

# Antenna Gain Measurement Report

**Report No.:** AGBEBU-WTW-P23040420

**Brand:** Corsair

**Model No.:** MGR2255

**Received Date:** 2023/5/2

**Test Date:** 2023/5/3

**Issued Date:** 2023/5/9

**Applicant:** Corsair Memory, Inc.

**Address:** 115 North McCarthy Blvd, Milpitas, CA 95035, USA

**Issued By:** Bureau Veritas Consumer Products Services (H.K.) Ltd., Taoyuan Branch  
Lin Kou Laboratories

**Lab Address:** No. 47-2, 14th Ling, Chia Pau Vil., Lin Kou Dist., New Taipei City, Taiwan

**Test Location:** No. 47-2, 14th Ling, Chia Pau Vil., Lin Kou Dist., New Taipei City, Taiwan

## FCC Registration /

**Designation Number:** 198487 / TW2021

**Prepared by :**



**Date:** 2023/5/9

Jessica Cheng / Senior Specialist

**Approved by :**



**Date:** 2023/5/9

Jeremy Lin / Project Engineer

This report is governed by, and incorporates by reference, the Conditions of Testing as posted at the date of issuance of this report at <http://www.bureauveritas.com/home/about-us/our-business/cps/about-us/terms-conditions/> and is intended for your exclusive use. Any copying or replication of this report to or for any other person or entity, or use of our name or trademark, is permitted only with our prior written permission. This report sets forth our findings solely with respect to the test samples identified herein. The results set forth in this report are not indicative or representative of the quality or characteristics of the lot from which a test sample was taken or any similar or identical product unless specifically and expressly noted. Our report includes all of the tests requested by you and the results thereof based upon the information that you provided to us. Measurement uncertainty is only provided upon request for accredited tests. Statements of conformity are based on simple acceptance criteria without taking measurement uncertainty into account, unless otherwise requested in writing. You have 60 days from date of issuance of this report to notify us of any material error or omission caused by our negligence or if you require measurement uncertainty; provided, however, that such notice shall be in writing and shall specifically address the issue you wish to raise. A failure to raise such issue within the prescribed time shall constitute your unqualified acceptance of the completeness of this report, the tests conducted and the correctness of the report contents.

## Table of Contents

Release Control Record .....	3
1 EUT Antenna System Description .....	4
1.1 Antenna Information.....	4
1.2 Antenna Location .....	4
2 2D Antenna Pattern Measurement .....	5
2.1 Test Location .....	5
2.2 Test Measurement procedure .....	5
2.3 Test Setup Diagram @ Fully Anechoic Chamber .....	5
2.4 Test Setup Diagram for EUT .....	6
2.5 Test Instruments.....	6
2.6 Measurement Uncertainty.....	6
2.7 Test Procedure .....	7
2.8 Test Result .....	7
2.9 2D Pattern Test Plots .....	8
3 Appendix - Information of the Testing Laboratories .....	14

### Release Control Record

Issue No.	Description	Date Issued
AGBEBU-WTW-P23040420	Original release.	2023/5/9

## 1 EUT Antenna System Description

### 1.1 Antenna Information

Frequency Range (GHz)	Antenna Type	Connector Type
2.4~2.4835GHz	PCBA	None

Frequency (MHz)	Max Gain (dBi)
2400~2483.5	5.13

### 1.2 Antenna Location

Please refer to the attached file (Test Setup Photo)

## 2 2D Antenna Pattern Measurement

### 2.1 Test Location

2D antenna pattern measurement in Fully Anechoic Chamber

### 2.2 Test Measurement procedure

CISPR 16-1-6

ANSI 63.10-2013 clause 13

KDB 412172 D01 Determining ERP and EIRP v01r01

### 2.3 Test Setup Diagram @ Fully Anechoic Chamber

The 2D antenna pattern measurement is using the test system (refer to Figure 1). The EUT is positioned on center of turntable, for Free Space only in fully anechoic chamber. Data (Raw Value) is recorded using the spectrum analyzer at each position.

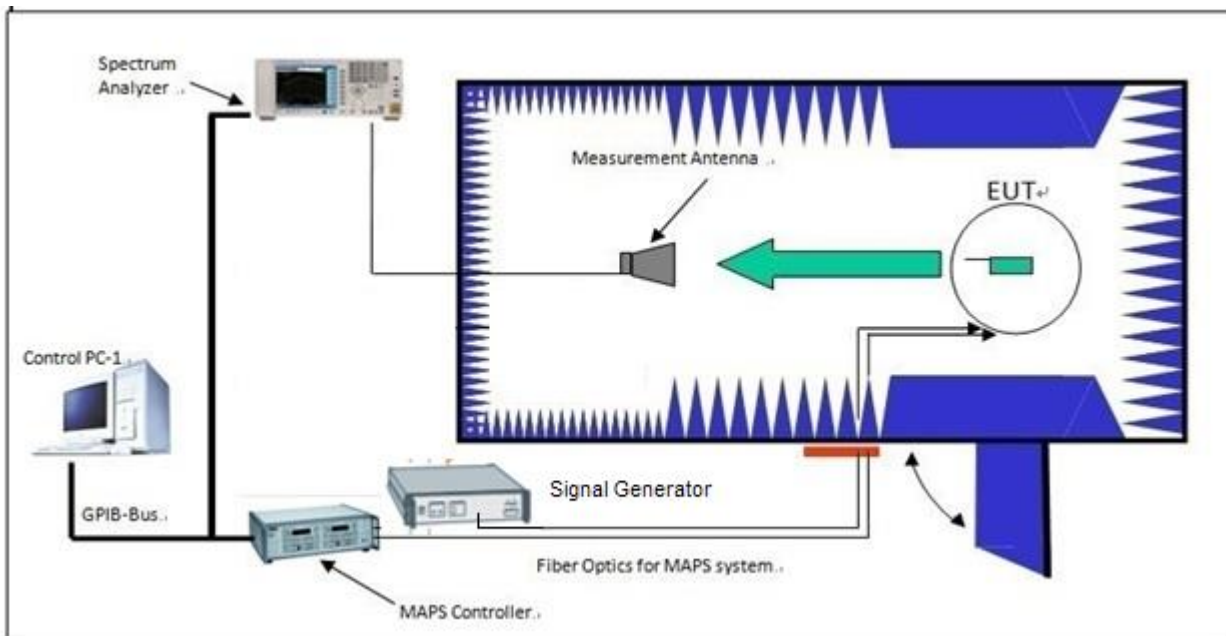

Figure 1. 2D antenna pattern test system.

## 2.4 Test Setup Diagram for EUT

The support equipment connect Wireless Mouse (Model: RGP0159) for testing.

Please refer to the attached file (Test Setup Photo)

## 2.5 Test Instruments

Description Manufacturer	Model No.	Serial No.	Calibrated Date	Calibrated Until				
Auto Control System(Antenna Tower, Table, Controller) ADT	SC100+AT100+TT100	N/A	N/A	N/A				
Horn Antenna ETS-Lindgren	3117	00034127	2022/11/13	2023/11/12				
Signal Generator R&S	SMR40	3008A01887	2022/6/15	2023/6/14				
RF Coaxial Cable EMCI	EMC 104	Cable-RF-01	2022/7/7	2023/7/6				
		Cable-RF-02	2022/7/7	2023/7/6				
RF Coaxial Cable HUBER SUHNER	SF-104	Cable-RF-03	2022/7/7	2023/7/6				
Software BVADT	Antenna Pattern V6.2-210118	N/A	N/A	N/A				
Spectrum Analyzer KEYSIGHT	N9030A	MY54490260	2022/7/14	2023/7/13				
Spectrum Analyzer R&S	FSV40	101042	2022/9/5	2023/9/4				
Absorber 30 MHz ~ 40GHz	TDK / IP-045C	N/A	N/A	N/A				
<b>TYPICAL ABSORPTION CHARACTERISTICS (VERTICAL INCIDENCE)</b> <span style="float: right;">Unit: dB</span>								
Material name	30MHz	50MHz	100MHz	500MHz	1GHz	5GHz	18GHz	40GHz
IP-045C	18	18	15	20	20	30	40	40

- Note:
1. The test was performed in LK - RF chamber.
  2. The horn antenna used only for the measurement of emission frequency above 1 GHz if tested.

## 2.6 Measurement Uncertainty

This uncertainty represents an expanded uncertainty expressed at approximately the 95% confidence level using a coverage factor of k=2.

Frequency Range	Uncertainty (±)
1 GHz ~ 18 GHz	3.294 dB

Note: Determining compliance based on the results of the compliance measurement, not taking into account measurement instrumentation uncertainty.

## 2.7 Test Procedure

- Connect the EUT antenna connector to the signal generator.
- Fasten the EUT to the locator in the center of the turntable, leaving only free space.
- Transmit a 0 dBm power level from the signal generator to the EUT antenna connector. Please refer to Figure 2 for detailed configuration.
- Make sure the transmit signal is stable at the maximum RF power level.
- Read the power level on the spectrum analyzer and record it in the following locations.
- The EUT is placed on a turntable that rotates 360° in 1° steps. Measure the E and H plane patterns.
- The turntable should be stepped from 0° to 360° with a maximum angular resolution of 1°. The 360° measurement should be compared to the 0° value to complete the pattern.
- According to section 2.3 of KDB 412172 D01 Determining ERP and EIRP v01r01, the substitution horn antenna is substituted for EUT at the same position and signals generator export the CW signal to the substitution antenna via a TX cable. Rotated the Turn Table and moved receiving antenna to find the maximum radiation power. Adjust output power level of S.G to get a Value of spectrum reading equal to "Raw Value". Record the power level of S.G.

$$EIRP = P_{SigGen} + G_T - L_C$$

where:

$P_{SigGen}$  = power setting of the signal generator that produces the same received power reading as the DUT, in dBm.

$G_T$  = gain of the substitute antenna, in dBd (ERP) or dBi (EIRP);

$L_C$  = signal loss in the cable connecting the signal generator to the substitute antenna, in dB.

## 2.8 Test Result

Tested By	Ian Chang
-----------	-----------

### X-Y Plane

Frequency (MHz)	Max Gain (dBi)
2402	3.53
2403	3.51
2440	4.52
2441	4.62
2480	4.43

### X-Z Plane

Frequency (MHz)	Max Gain (dBi)
2402	2.50
2403	2.34
2440	2.19
2441	1.97
2480	2.10

### Y-Z Plane

Frequency (MHz)	Max Gain (dBi)
2402	4.01
2403	3.97
2440	5.08
2441	5.13
2480	4.88

## 2.9 2D Pattern Test Plots

### X-Y Plane

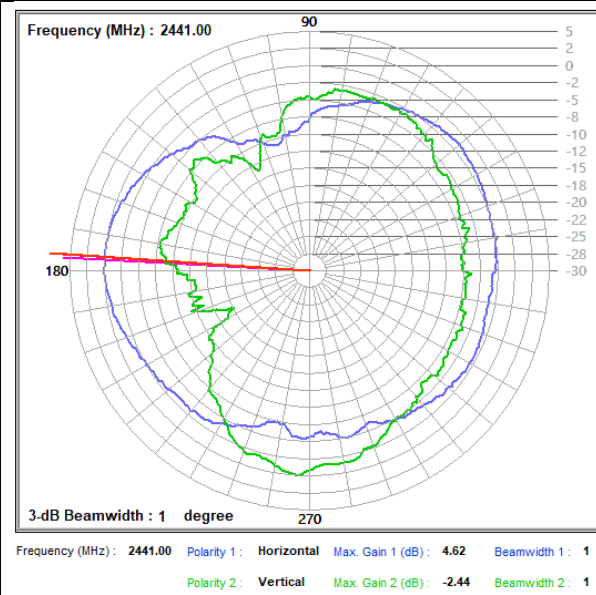
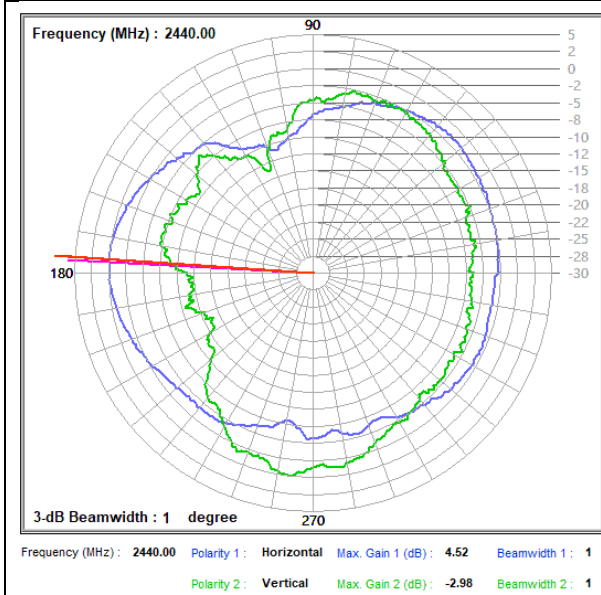
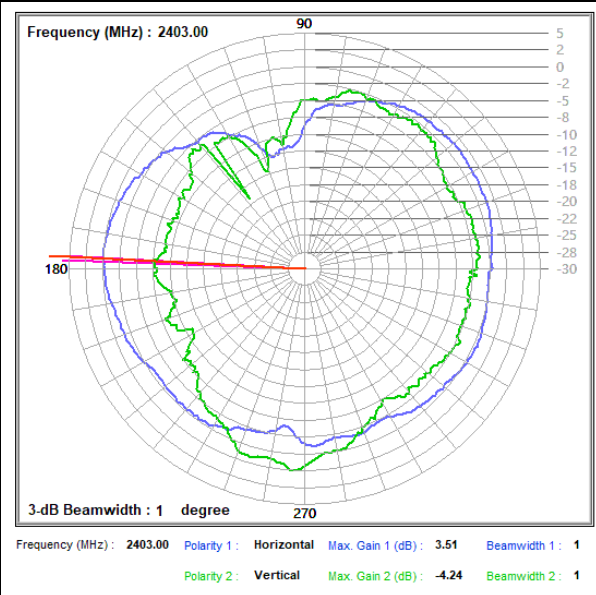
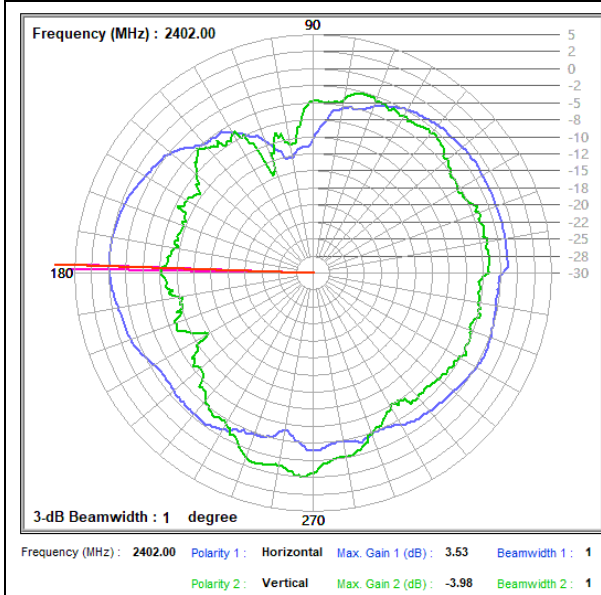



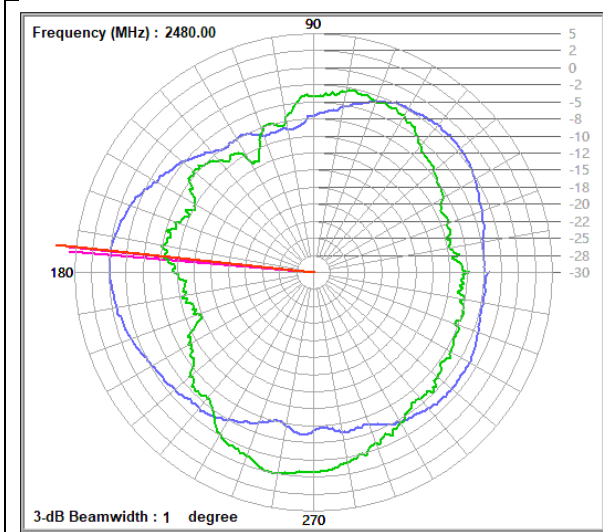

Frequency (MHz) : 2480.00 Polarity 1 : Horizontal Max. Gain 1 (dB) : 4.43 Beamwidth 1 : 1  
Polarity 2 : Vertical Max. Gain 2 (dB) : -3.52 Beamwidth 2 : 1

### X-Z Plane

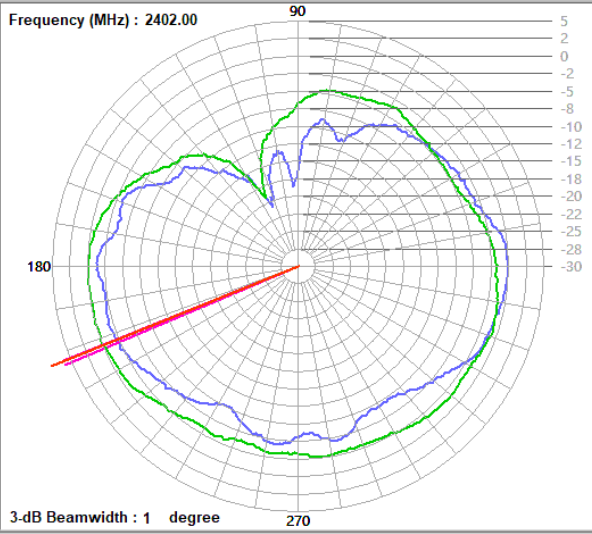

Frequency (MHz) : 2402.00 Polarity 1 : Horizontal Max. Gain 1 (dB) : 0.82 Beamwidth 1 : 1  
Polarity 2 : Vertical Max. Gain 2 (dB) : 2.50 Beamwidth 2 : 1

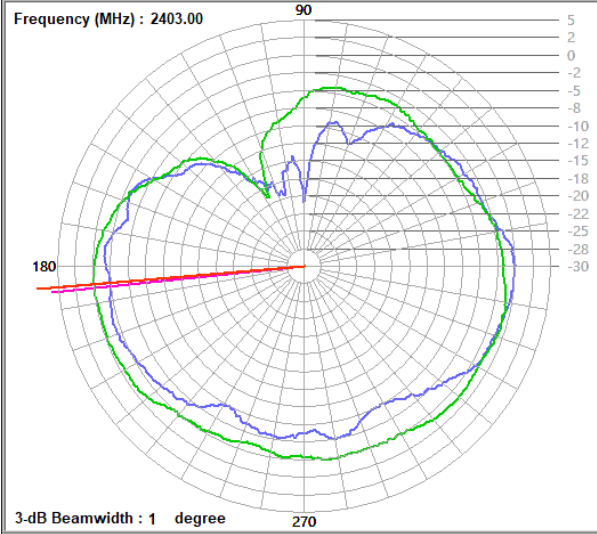

Frequency (MHz) : 2403.00 Polarity 1 : Horizontal Max. Gain 1 (dB) : 0.93 Beamwidth 1 : 1  
Polarity 2 : Vertical Max. Gain 2 (dB) : 2.34 Beamwidth 2 : 1

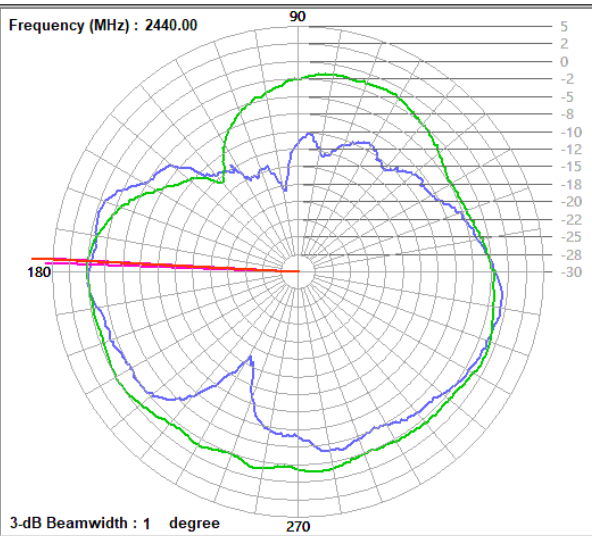

Frequency (MHz) : 2440.00 Polarity 1 : Horizontal Max. Gain 1 (dB) : 0.65 Beamwidth 1 : 1  
Polarity 2 : Vertical Max. Gain 2 (dB) : 2.19 Beamwidth 2 : 1

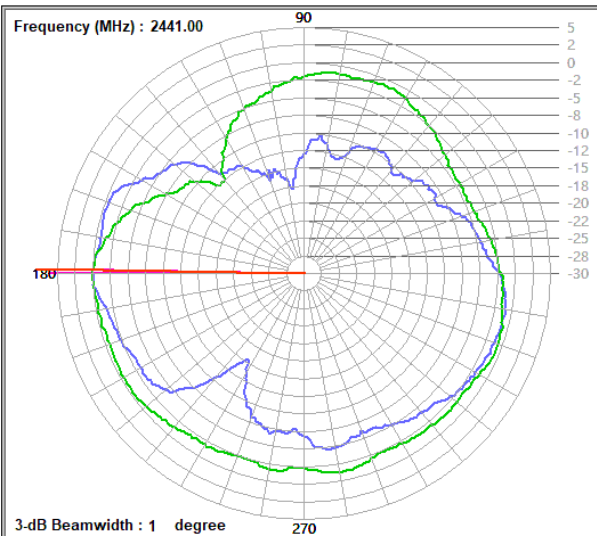

Frequency (MHz) : 2441.00 Polarity 1 : Horizontal Max. Gain 1 (dB) : 0.77 Beamwidth 1 : 1  
Polarity 2 : Vertical Max. Gain 2 (dB) : 1.97 Beamwidth 2 : 1

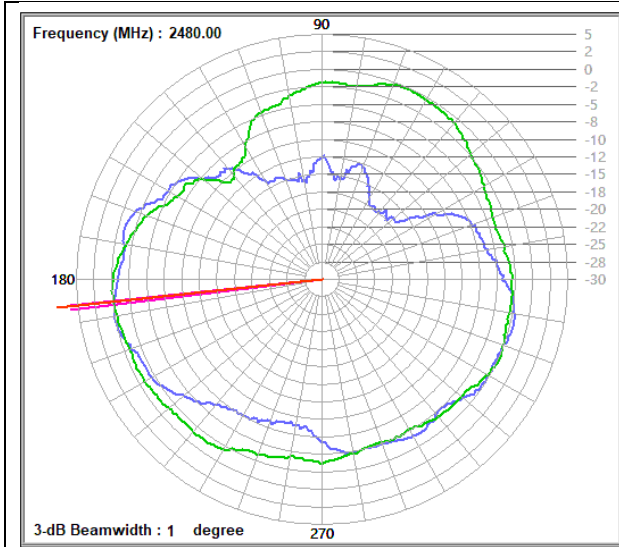

Frequency (MHz) : 2480.00 Polarity 1 : Horizontal Max. Gain 1 (dB) : 1.58 Beamwidth 1 : 1  
Polarity 2 : Vertical Max. Gain 2 (dB) : 2.10 Beamwidth 2 : 1

### Y-Z Plane

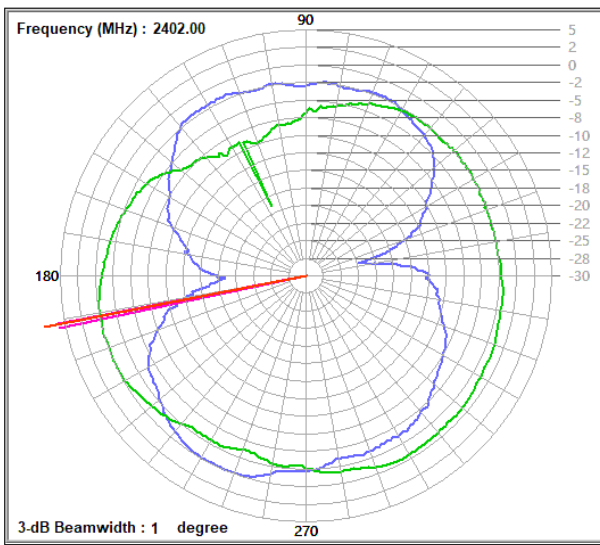

Frequency (MHz) : 2402.00 Polarity 1 : Horizontal Max. Gain 1 (dB) : 3.04 Beamwidth 1 : 1  
 Polarity 2 : Vertical Max. Gain 2 (dB) : 4.01 Beamwidth 2 : 1

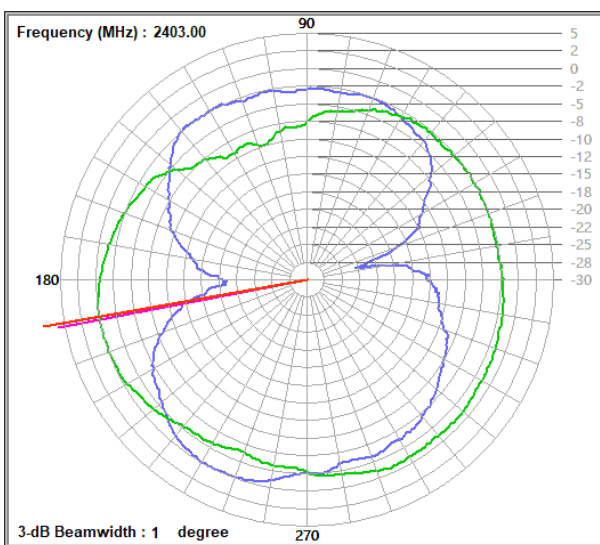

Frequency (MHz) : 2403.00 Polarity 1 : Horizontal Max. Gain 1 (dB) : 3.12 Beamwidth 1 : 1  
 Polarity 2 : Vertical Max. Gain 2 (dB) : 3.97 Beamwidth 2 : 1

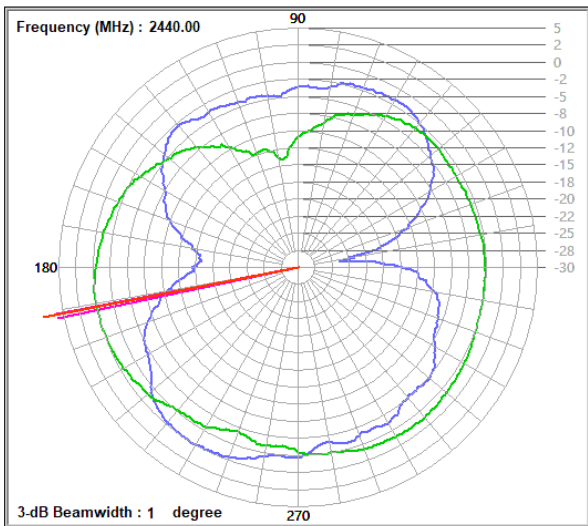

Frequency (MHz) : 2440.00 Polarity 1 : Horizontal Max. Gain 1 (dB) : 2.88 Beamwidth 1 : 1  
 Polarity 2 : Vertical Max. Gain 2 (dB) : 5.08 Beamwidth 2 : 1

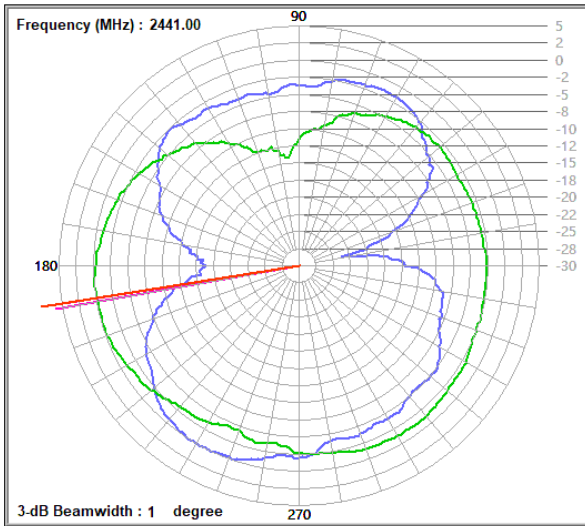

Frequency (MHz) : 2441.00 Polarity 1 : Horizontal Max. Gain 1 (dB) : 2.82 Beamwidth 1 : 1  
 Polarity 2 : Vertical Max. Gain 2 (dB) : 5.13 Beamwidth 2 : 1

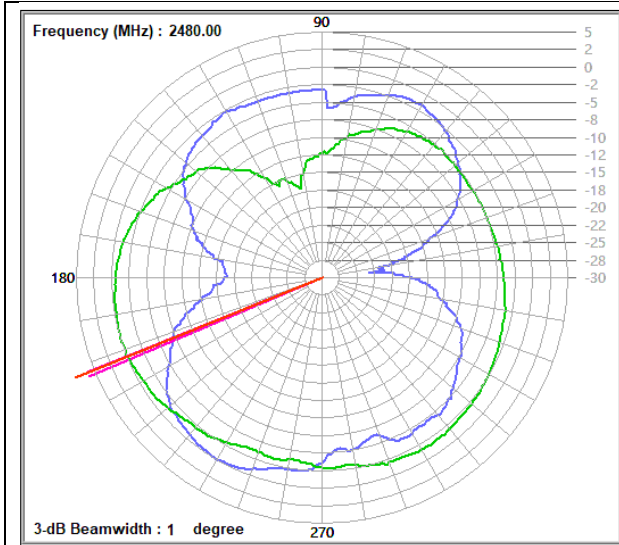

Frequency (MHz) : 2480.00 Polarity 1 : Horizontal Max. Gain 1 (dB) : 3.03 Beamwidth 1 : 1  
Polarity 2 : Vertical Max. Gain 2 (dB) : 4.88 Beamwidth 2 : 1

### 3 Appendix - Information of the Testing Laboratories

We, Bureau Veritas Consumer Products Services (H.K.) Ltd., Taoyuan Branch, were founded in 1988 to provide our best service in EMC, Radio, Telecom and Safety consultation. Our laboratories are FCC recognized accredited test firms and accredited and approved according to ISO/IEC 17025.

If you have any comments, please feel free to contact us at the following:

**Lin Kou EMC/RF Lab**

Tel: 886-2-26052180

Fax: 886-2-26051924

**Hsin Chu EMC/RF/Telecom Lab**

Tel: 886-3-6668565

Fax: 886-3-6668323

**Hwa Ya EMC/RF/Safety Lab**

Tel: 886-3-3183232

Fax: 886-3-3270892

**Email:** [service.adt@tw.bureauveritas.com](mailto:service.adt@tw.bureauveritas.com)

**Web Site:** <http://ee.bureauveritas.com.tw>

The address and road map of all our labs can be found in our web site also.

--- END ---