

## FCC Test Report

**Report No.:** RFBEBU-WTW-P23060145-1

**FCC ID:** 2AAFMRGP0158

**Product:** Wireless Mouse

**Brand:** Corsair

**Model No.:** RGP0158

**Received Date:** 2023/6/7

**Test Date:** 2023/6/9 ~ 2023/6/14

**Issued Date:** 2023/6/19

**Applicant:** Corsair Memory, Inc.

**Address:** 115 North McCarthy Blvd, Milpitas, CA 95035, USA

**Issued By:** Bureau Veritas Consumer Products Services (H.K.) Ltd., Taoyuan Branch  
Lin Kou Laboratories

**Lab Address:** No. 47-2, 14th Ling, Chia Pau Vil., Lin Kou Dist., New Taipei City, Taiwan

**FCC Registration /  
Designation Number:** 198487 / TW2021



This report is governed by, and incorporates by reference, the Conditions of Testing as posted at the date of issuance of this report at <http://www.bureauveritas.com/home/about-us/our-business/cps/about-us/terms-conditions/> and is intended for your exclusive use. Any copying or replication of this report to or for any other person or entity, or use of our name or trademark, is permitted only with our prior written permission. This report sets forth our findings solely with respect to the test samples identified herein. The results set forth in this report are not indicative or representative of the quality or characteristics of the lot from which a test sample was taken or any similar or identical product unless specifically and expressly noted. Our report includes all of the tests requested by you and the results thereof based upon the information that you provided to us. Measurement uncertainty is only provided upon request for accredited tests. Statements of conformity are based on simple acceptance criteria without taking measurement uncertainty into account, unless otherwise requested in writing. You have 60 days from date of issuance of this report to notify us of any material error or omission caused by our negligence or if you require measurement uncertainty; provided, however, that such notice shall be in writing and shall specifically address the issue you wish to raise. A failure to raise such issue within the prescribed time shall constitute your unqualified acceptance of the completeness of this report, the tests conducted and the correctness of the report contents.

## Table of Contents

<b>Release Control Record</b> .....	<b>3</b>
<b>1 Certificate of Conformity</b> .....	<b>4</b>
<b>2 Summary of Test Results</b> .....	<b>5</b>
2.1 Measurement Uncertainty .....	5
2.2 Modification Record .....	5
<b>3 General Information</b> .....	<b>6</b>
3.1 General Description of EUT .....	6
3.2 Description of Test Modes .....	7
3.2.1 Test Mode Applicability and Tested Channel Detail .....	8
3.3 Duty Cycle of Test Signal .....	9
3.4 Description of Support Units .....	10
3.4.1 Configuration of System under Test .....	10
3.5 General Description of Applied Standards .....	12
<b>4 Test Types and Results</b> .....	<b>13</b>
4.1 Radiated Emission and Bandedge Measurement .....	13
4.1.1 Limits of Radiated Emission and Bandedge Measurement .....	13
4.1.2 Test Instruments .....	14
4.1.3 Test Procedures .....	16
4.1.4 Deviation from Test Standard .....	16
4.1.5 Test Setup .....	17
4.1.6 EUT Operating Conditions .....	18
4.1.7 Test Results .....	19
4.2 Conducted Emission Measurement .....	26
4.2.1 Limits of Conducted Emission Measurement .....	26
4.2.2 Test Instruments .....	26
4.2.3 Test Procedures .....	27
4.2.4 Deviation From Test Standard .....	27
4.2.5 Test Setup .....	27
4.2.6 EUT Operating Condition .....	27
4.2.7 Test Results .....	28
4.3 Channel Bandwidth .....	32
4.3.1 Test Setup .....	32
4.3.2 Test Instruments .....	32
4.3.3 Test Procedure .....	32
4.3.4 Deviation from Test Standard .....	32
4.3.5 EUT Operating Condition .....	32
4.3.6 Test Results .....	33
<b>5 Pictures of Test Arrangements</b> .....	<b>34</b>
<b>Appendix – Information of the Testing Laboratories</b> .....	<b>35</b>

### Release Control Record

Issue No.	Description	Date Issued
RFBEBU-WTW-P23060145-1	Original release.	2023/6/19



## 2 Summary of Test Results

47 CFR FCC Part 15, Subpart C (SECTION 15.249)			
FCC Clause	Test Item	Result	Remarks
15.207	AC Power Conducted Emission	PASS	Meet the requirement of limit. Minimum passing margin is -11.76dB at 1.10621MHz.
15.215	Channel Bandwidth Measurement	PASS	Meet the requirement of limit.
15.209 15.249 (a) 15.249 (d)	Radiated Emission and Bandedge Measurement	PASS	Meet the requirement of limit. Minimum passing margin is -8.6dB at 2483.50MHz.
15.203	Antenna Requirement	PASS	No antenna connector is used.

Note: Determining compliance based on the results of the compliance measurement, not taking into account measurement instrumentation uncertainty.

### 2.1 Measurement Uncertainty

Where relevant, the following measurement uncertainty levels have been estimated for tests performed on the EUT as specified in CISPR 16-4-2:

Parameter	Specification	Expanded Uncertainty (k=2) (±)
Conducted Out of Band Emissions	9 kHz ~ 40 GHz	2.63 dB
AC Power Conducted Emissions	150 kHz ~ 30 MHz	3.00 dB
Unwanted Emissions below 1 GHz	9 kHz ~ 30 MHz	2.38 dB
	30 MHz ~ 1 GHz	5.7 dB
Unwanted Emissions above 1 GHz	1 GHz ~ 6 GHz	4.83 dB
	6 GHz ~ 18 GHz	5.37 dB
	18 GHz ~ 40 GHz	5.24 dB

The other instruments specified are routine verified to remain within the calibrated levels, no measurement uncertainty is required to be calculated.

### 2.2 Modification Record

There were no modifications required for compliance.

### 3 General Information

#### 3.1 General Description of EUT

Product	Wireless Mouse
Brand	Corsair
Test Model	RGP0158
Status of EUT	Engineering sample
Power Supply Rating	3.8Vdc from Battery or 5Vdc from host equipment for USB mode
Modulation Type	GFSK
Operating Frequency	2403 ~ 2480 MHz
Number of Channel	78
Field Strength	82.8 dBuV/m (3m)
Antenna Type	PCBA Antenna with 5.98dBi gain
Antenna Connector	N/A
Accessory Device	N/A
Data Cable Supplied	Shielded USB cable (1.8m)

Note:

1. There are Bluetooth and GFSK technology used for the EUT.
2. Bluetooth and GFSK technology can not transmit at same time.
3. Due to radiated measurements are made and the antenna gain is already accounted for this device, so provide an antenna datasheet and/or antenna measurement report is not required. The antenna dimensions and pictures (include antenna wire length if have) are stated in EUT photo exhibit.
4. The above EUT information is declared by manufacturer and for more detailed features description, please refers to the manufacturer's specifications or user's manual.

### 3.2 Description of Test Modes

78 channels are provided to this EUT:

Channel	Freq. (MHz)	Channel	Freq. (MHz)	Channel	Freq. (MHz)	Channel	Freq. (MHz)
0	2403	20	2423	40	2443	60	2463
1	2404	21	2424	41	2444	61	2464
2	2405	22	2425	42	2445	62	2465
3	2406	23	2426	43	2446	63	2466
4	2407	24	2427	44	2447	64	2467
5	2408	25	2428	45	2448	65	2468
6	2409	26	2429	46	2449	66	2469
7	2410	27	2430	47	2450	67	2470
8	2411	28	2431	48	2451	68	2471
9	2412	29	2432	49	2452	69	2472
10	2413	30	2433	50	2453	70	2473
11	2414	31	2434	51	2454	71	2474
12	2415	32	2435	52	2455	72	2475
13	2416	33	2436	53	2456	73	2476
14	2417	34	2437	54	2457	74	2477
15	2418	35	2438	55	2458	75	2478
16	2419	36	2439	56	2459	76	2479
17	2420	37	2440	57	2460	77	2480
18	2421	38	2441	58	2461		
19	2422	39	2442	59	2462		

### 3.2.1 Test Mode Applicability and Tested Channel Detail

Pre-Scan:	1. For Unwanted Emission below 1 GHz has Charging with Adapter/ Charging with NB mode of power supply. Pre-scan these modes and find the worst charging case as a representative test condition.
Worst Case:	1. For Unwanted Emission below 1 GHz Charging with NB mode is the worst charging case of power supply.

EUT Configure Mode	Applicable To				Description
	RE $\geq$ 1G	RE $<$ 1G	PLC	APCM	
A	√	√	-	√	EUT only
B	-	√	√	-	Charging with NB
C	-	-	√	-	Charging with Adapter

Where **RE $\geq$ 1G**: Radiated Emission above 1GHz & Bandedge Measurement      **RE $<$ 1G**: Radiated Emission below 1GHz  
**PLC**: Power Line Conducted Emission      **APCM**: Antenna Port Conducted Measurement

#### **Radiated Emission Test (Above 1GHz):**

- Pre-Scan has been conducted to determine the worst-case mode from all possible combinations between available modulations, data rates and antenna ports (if EUT with antenna diversity architecture).
- Following channel(s) was (were) selected for the final test as listed below.

EUT Configure Mode	Available Channel	Tested Channel	Modulation Type
A	0 to 77	0, 38, 77	GFSK

#### **Radiated Emission Test (Below 1GHz):**

- Pre-Scan has been conducted to determine the worst-case mode from all possible combinations between available modulations, data rates and antenna ports (if EUT with antenna diversity architecture).
- Following channel(s) was (were) selected for the final test as listed below.

EUT Configure Mode	Available Channel	Tested Channel	Modulation Type
A	0 to 77	0	GFSK
B	-	-	-

#### **Power Line Conducted Emission Test:**

- Pre-Scan has been conducted to determine the worst-case mode from all possible combinations between available modulations, data rates and antenna ports (if EUT with antenna diversity architecture).
- Following channel(s) was (were) selected for the final test as listed below.

EUT Configure Mode	Available Channel	Tested Channel	Modulation Type
B	-	-	-
C	-	-	-

#### **Antenna Port Conducted Measurement:**

- This item includes all test value of each mode, but only includes spectrum plot of worst value of each mode.
- Pre-Scan has been conducted to determine the worst-case mode from all possible combinations between available modulations, data rates and antenna ports (if EUT with antenna diversity architecture).
- Following channel(s) was (were) selected for the final test as listed below.

EUT Configure Mode	Available Channel	Tested Channel	Modulation Type
A	0 to 77	0, 38, 77	GFSK



**Test Condition:**

Applicable To	EUT Configure Mode	Environmental Conditions	Input Power	Tested By
RE≥1G	A	25deg. C, 76%RH	3.8Vdc	Jed Wu
RE<1G	A	25deg. C, 76%RH	3.8Vdc	Jed Wu
	B	25deg. C, 76%RH	120Vac, 60Hz (System)	Jed Wu
PLC	B	25deg. C, 75%RH	120Vac, 60Hz (System)	Jed Wu
	C	25deg. C, 75%RH	120Vac, 60Hz (Adapter)	Jed Wu
APCM	A	25deg. C, 75%RH	3.8Vdc	Dalen Dai

**3.3 Duty Cycle of Test Signal**

Duty cycle correction factor =  $20 \log(\text{Duty cycle}) = 20 \log(0.168) = -15.5\text{dB}$

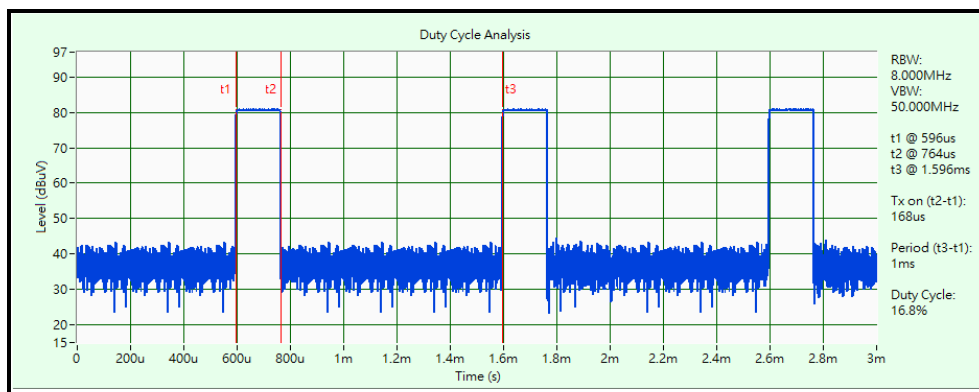

### 3.4 Description of Support Units

The EUT has been tested as an independent unit together with other necessary accessories or support units. The following support units or accessories were used to form a representative test configuration during the tests.

ID	Product	Brand	Model No.	Serial No.	FCC ID	Remarks
A	NB	Lenovo	80WG	YD01YRC9	N/A	Provided by Lab
B	NB Adapter	Lenovo	ADLX65CLGU2A	N/A	N/A	Provided by Lab
C	Adapter	Apple	A1385	N/A	N/A	Provided by Lab

ID	Cable Descriptions	Qty.	Length (m)	Shielding (Yes/No)	Cores (Qty.)	Remarks
1	USB cable	1	1.8	Y	0	Supplied by applicant
2	DC cable	1	1.9	N	0	Provided by Lab

#### 3.4.1 Configuration of System under Test

Mode A



-----  
Remote Site

Mode B

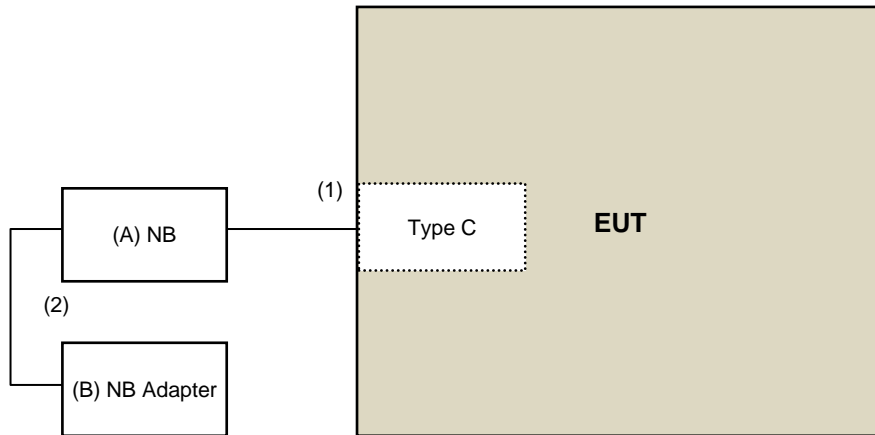

-----  
Remote Site

Mode C

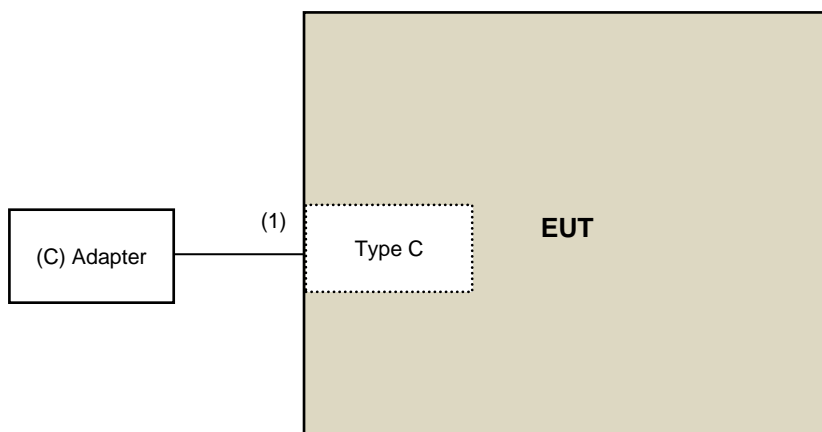

-----  
Remote Site

### 3.5 General Description of Applied Standards

The EUT is a RF Product. According to the specifications of the manufacturer, it must comply with the requirements of the following standards:

**FCC Part 15, Subpart C (15.249)**

ANSI C63.10-2013

All test items have been performed and recorded as per the above standards.

## 4 Test Types and Results

### 4.1 Radiated Emission and Bandedge Measurement

#### 4.1.1 Limits of Radiated Emission and Bandedge Measurement

The field strength of emissions from intentional radiators operated within these frequency bands shall comply with the following

Fundamental Frequency	Field Strength of Fundamental (millivolts/meter)	Field Strength of Harmonics (microvolts/meter)
902 ~ 928 MHz	50	500
2400 ~ 2483.5 MHz	50	500
5725 ~ 5875 MHz	50	500
24 ~ 24.25 GHz	250	2500

Emissions radiated outside of the specified frequency bands, except for harmonics, shall be attenuated by at least 50 dB below the level of the fundamental or to the general radiated emission limits as below table, whichever is the lesser attenuation

Frequencies (MHz)	Field Strength (microvolts/meter)	Measurement Distance (meters)
0.009 ~ 0.490	2400/F(kHz)	300
0.490 ~ 1.705	24000/F(kHz)	30
1.705 ~ 30.0	30	30
30 ~ 88	100	3
88 ~ 216	150	3
216 ~ 960	200	3
Above 960	500	3

#### NOTE:

1. The lower limit shall apply at the transition frequencies.
2. Emission level (dBuV/m) = 20 log Emission level (uV/m).
3. For frequencies above 1000MHz, the field strength limits are based on average detector, however, the peak field strength of any emission shall not exceed the maximum permitted average limits, specified above by more than 20dB under any condition of modulation.

#### 4.1.2 Test Instruments

##### Unwanted Emissions below 1 GHz

Description Manufacturer	Model No.	Serial No.	Calibrated Date	Calibrated Until
Loop Antenna EMCI	LPA600	270	2021/9/2	2023/9/1
Bi_Log Antenna Schwarzbeck	VULB 9168	137	2022/10/21	2023/10/20
Coupling / Decoupling Network Schwarzbeck	CDNE-M2	00097	2023/5/25	2024/5/24
	CDNE-M3	00091	2023/5/25	2024/5/24
MXE EMI Receiver Agilent	N9038A	MY51210129	2023/3/24	2024/3/23
		MY51210137	2023/6/5	2024/6/4
Preamplifier EMCI	EMC001340	980269	2022/6/28	2023/6/27
Preamplifier HP	8447D	2432A03504	2023/2/16	2024/2/15
RF Coaxial Cable Pacific	8D-FB	Cable-CH6-02	2022/6/30	2023/6/29
Signal Analyzer R&S	FSV40	101544	2023/5/9	2024/5/8
Software BVADT	Radiated_V7.7.1.1.1	N/A	N/A	N/A
	Radiated_V8.7.08	N/A	N/A	N/A
Tower ADT	AT100	0306	N/A	N/A
Turn Table ADT	TT100	0306	N/A	N/A

##### Notes:

1. The calibration interval of the above test instruments is 12/24 months and the calibrations are traceable to NML/ROC and NIST/USA
2. The test was performed in Linkou 966 Chamber 6 (CH 6).
3. Tested Date: 2023/6/9

Unwanted Emissions above 1 GHz

Description Manufacturer	Model No.	Serial No.	Calibrated Date	Calibrated Until
Band Pass Filter Micro-Tronics	BRM17690	005	2023/5/25	2024/5/24
Boresight antenna tower fixture BV	BAF-02	6	N/A	N/A
High Pass Filter Wainwright	WHK 3.1/18G-10SS	SN 8	2023/5/25	2024/5/24
Horn Antenna EMCO	3115	00028257	2022/11/13	2023/11/12
Horn Antenna ETS-Lindgren	3117-PA	00215857	2022/11/13	2023/11/12
Horn Antenna Schwarzbeck	BBHA 9170	212	2022/10/20	2023/10/19
MXE EMI Receiver Agilent	N9038A	MY51210129	2023/3/24	2024/3/23
		MY51210137	2023/6/5	2024/6/4
Notch Filter Micro-Tronics	BRC50703-01	010	2023/5/25	2024/5/24
Preamplifier EMCI	EMC0126545 EMC184045B	980076	2023/2/16	2024/2/15
		980175	2022/9/3	2023/9/2
		980235	2023/2/16	2024/2/15
Preamplifier HP	8449B	3008A01201	2023/2/16	2024/2/15
RF Coaxial Cable EM	EM102-KMKM-3.5+1M	EM102-KMKM- 3.5+1M-01	2022/7/7	2023/7/6
RF Coaxial Cable EMCI	EMC104	190801	2022/9/20	2023/9/19
		190804	2022/9/20	2023/9/19
RF Coaxial Cable HUBER SUHNER	SF-104	Cable-CH6-01	2022/9/20	2023/9/19
Signal Analyzer R&S	FSV40	101042	2022/9/5	2023/9/4
		101544	2023/5/9	2024/5/8
Software BVADT	Radiated_V7.7.1.1.1	N/A	N/A	N/A
	Radiated_V8.7.08	N/A	N/A	N/A
Tower ADT	AT100	0306	N/A	N/A
Turn Table ADT	TT100	0306	N/A	N/A

Notes:

1. The calibration interval of the above test instruments is 12 months and the calibrations are traceable to NML/ROC and NIST/USA
2. The test was performed in Linkou 966 Chamber 6 (CH 6).
3. Tested Date: 2023/6/9

#### 4.1.3 Test Procedures

##### **For Radiated emission below 30MHz**

- a. The EUT was placed on the top of a rotating table 0.8 meters above the ground at a 3 meter chamber room. The table was rotated 360 degrees to determine the position of the highest radiation.
- b. The EUT was set 3 meters away from the interference-receiving antenna, which was mounted on the top of a variable-height antenna tower.
- c. Parallel, perpendicular, and ground-parallel orientations of the antenna are set to make the measurement.
- d. For each suspected emission, the EUT was arranged to its worst case and the rotatable table was turned from 0 degrees to 360 degrees to find the maximum reading.
- e. The test-receiver system was set to Quasi-Peak Detect Function and Specified Bandwidth with Maximum Hold Mode.

##### **NOTE:**

1. The resolution bandwidth and video bandwidth of test receiver/spectrum analyzer is 9kHz at frequency below 30MHz.

##### **For Radiated emission above 30MHz**

- a. The EUT was placed on the top of a rotating table 0.8 meters (for 30MHz ~ 1GHz) / 1.5 meters (for above 1GHz) above the ground at 3 meter chamber room for test. The table was rotated 360 degrees to determine the position of the highest radiation.
- b. The EUT was set 3 meters away from the interference-receiving antenna, which was mounted on the top of a variable-height antenna tower.
- c. The height of antenna is varied from one meter to four meters above the ground to determine the maximum value of the field strength. Both horizontal and vertical polarizations of the antenna are set to make the measurement.
- d. For each suspected emission, the EUT was arranged to its worst case and then the antenna was tuned to heights from 1 meter to 4 meters and the rotatable table was turned from 0 degrees to 360 degrees to find the maximum reading.
- e. The test-receiver system was set to quasi-peak detect function and specified bandwidth with maximum hold mode when the test frequency is below 1 GHz.
- f. The test-receiver system was set to peak and average detect function and specified bandwidth with maximum hold mode when the test frequency is above 1 GHz. If the peak reading value also meets average limit, measurement with the average detector is unnecessary.

##### **Note:**

1. The resolution bandwidth and video bandwidth of test receiver/spectrum analyzer is 120kHz for Quasi-peak detection (QP) at frequency below 1GHz.
2. The resolution bandwidth of test receiver/spectrum analyzer is 1 MHz and the video bandwidth is 3 MHz for Peak detection (PK) and Average detection at frequency above 1GHz. For fundamental and harmonic signal measurement, according to ANSI C63.10 section 7.5, the average value = peak value + duty factor. The duty factor refer to Chapter 3.3 of this report.
3. All modes of operation were investigated and the worst-case emissions are reported.

#### 4.1.4 Deviation from Test Standard

No deviation.



#### 4.1.5 Test Setup

##### For Radiated emission below 30MHz

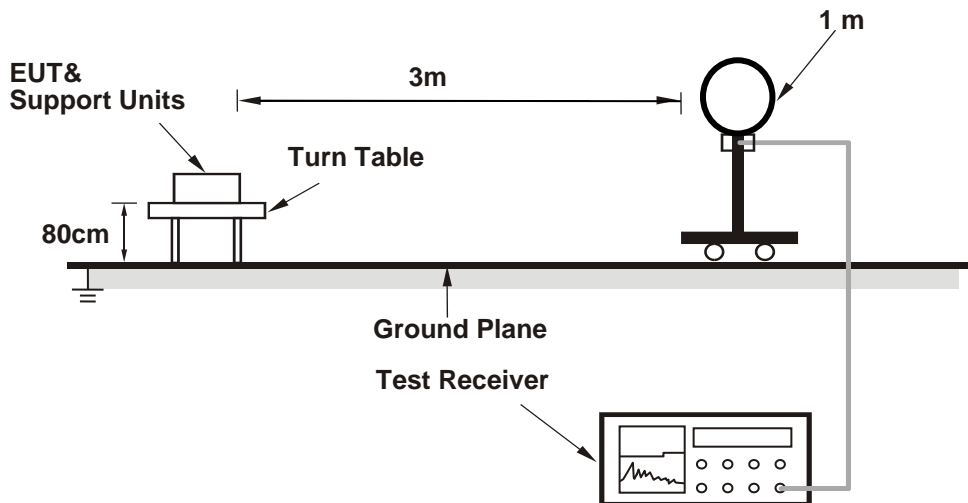

##### For Radiated emission 30MHz to 1GHz

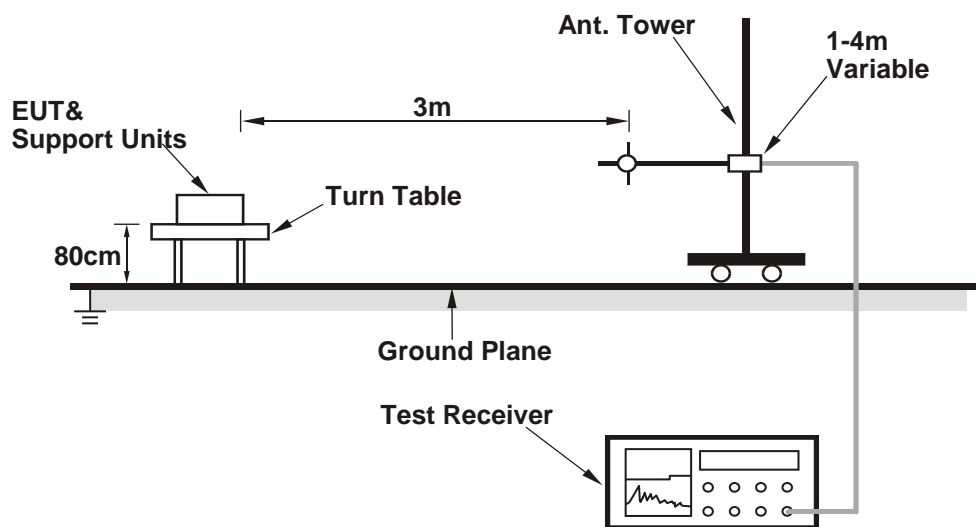

**For Radiated emission above 1GHz**

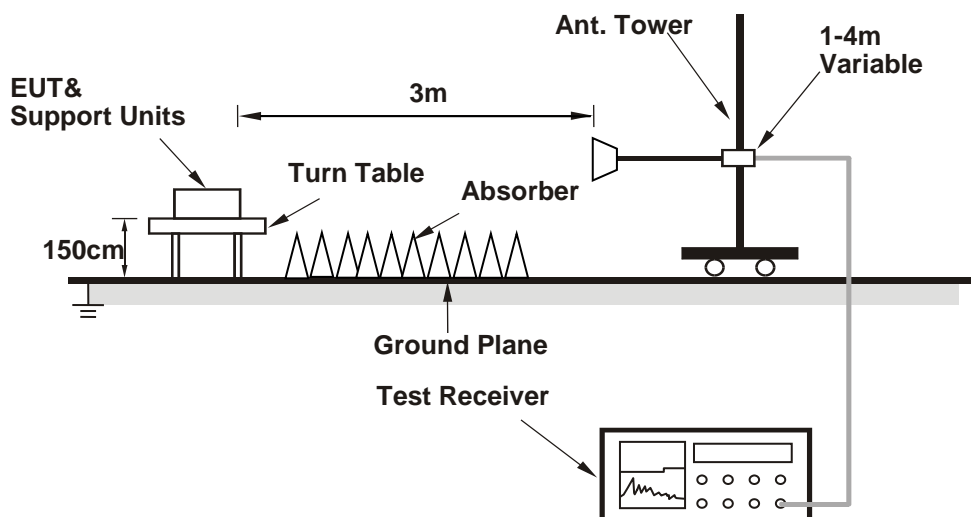

For the actual test configuration, please refer to the attached file (Test Setup Photo).

**4.1.6 EUT Operating Conditions**

**Mode A**

Set the EUT under transmission condition continuously at specific channel frequency.

**Mode B**

Connected the EUT to Notebook.

Set the EUT under charging condition.

#### 4.1.7 Test Results

#### ABOVE 1GHz DATA

#### Mode A

<b>RF Mode</b>	GFSK	<b>Channel</b>	CH 0 : 2403 MHz
<b>Frequency Range</b>	1 GHz ~ 25 GHz	<b>Detector Function &amp; Bandwidth</b>	Peak (PK), RB = 1 MHz, VB = 3 MHz RMS (AV), RB = 1 MHz, VB = 3 MHz

#### Antenna Polarity & Test Distance : Horizontal at 3 m

No	Frequency (MHz)	Emission Level (dBuV/m)	Limit (dBuV/m)	Margin (dB)	Antenna Height (m)	Table Angle (Degree)	Raw Value (dBuV)	Correction Factor (dB/m)
1	2390.00	51.1 PK	74.0	-22.9	1.18 H	137	48.8	2.3
2	2390.00	33.4 AV	54.0	-20.6	1.18 H	137	31.1	2.3
3	2400.00	48.3 PK	74.0	-25.7	1.18 H	137	46.0	2.3
4	2400.00	32.8 AV	54.0	-21.2	1.18 H	137	30.5	2.3
5	*2403.00	98.3 PK	114.0	-15.7	1.18 H	137	95.7	2.6
6	*2403.00	82.8 AV	94.0	-11.2	1.18 H	137	80.2	2.6
7	4806.00	52.8 PK	74.0	-21.2	1.41 H	169	39.7	13.1
8	4806.00	37.3 AV	54.0	-16.7	1.41 H	169	24.2	13.1

#### Antenna Polarity & Test Distance : Vertical at 3 m

No	Frequency (MHz)	Emission Level (dBuV/m)	Limit (dBuV/m)	Margin (dB)	Antenna Height (m)	Table Angle (Degree)	Raw Value (dBuV)	Correction Factor (dB/m)
1	2390.00	47.6 PK	74.0	-26.4	3.91 V	170	45.3	2.3
2	2390.00	32.4 AV	54.0	-21.6	3.91 V	170	30.1	2.3
3	2400.00	44.1 PK	74.0	-29.9	3.91 V	170	41.8	2.3
4	2400.00	28.6 AV	54.0	-25.4	3.91 V	170	26.3	2.3
5	*2403.00	93.8 PK	114.0	-20.2	3.91 V	170	91.2	2.6
6	*2403.00	78.3 AV	94.0	-15.7	3.91 V	170	75.7	2.6
7	4806.00	52.1 PK	74.0	-21.9	3.52 V	146	39.0	13.1
8	4806.00	36.6 AV	54.0	-17.4	3.52 V	146	23.5	13.1

#### Remarks:

1. Emission Level(dBuV/m) = Raw Value(dBuV) + Correction Factor(dB/m)
2. Correction Factor(dB/m) = Antenna Factor(dB/m) + Cable Factor(dB) – Pre-Amplifier Factor(dB)
3. Margin value = Emission Level – Limit value
4. The other emission levels were very low against the limit.
5. " \* ": Fundamental frequency.
6. The average value of fundamental and harmonic frequency is: Average = Peak value + 20 log(Duty cycle) Where the duty cycle correction factor is calculated from following formula:  
 $20 \log(\text{Duty cycle}) = 20 \log(0.168) = -15.5\text{dB}$

<b>RF Mode</b>	GFSK	<b>Channel</b>	CH 38 : 2441 MHz
<b>Frequency Range</b>	1 GHz ~ 25 GHz	<b>Detector Function &amp; Bandwidth</b>	Peak (PK), RB = 1 MHz, VB = 3 MHz RMS (AV), RB = 1 MHz, VB = 3 MHz

**Antenna Polarity & Test Distance : Horizontal at 3 m**

No	Frequency (MHz)	Emission Level (dBuV/m)	Limit (dBuV/m)	Margin (dB)	Antenna Height (m)	Table Angle (Degree)	Raw Value (dBuV)	Correction Factor (dB/m)
1	*2441.00	96.6 PK	114.0	-17.4	1.33 H	137	94.0	2.6
2	*2441.00	81.1 AV	94.0	-12.9	1.33 H	137	78.5	2.6
3	4882.00	52.4 PK	74.0	-21.6	1.56 H	168	38.7	13.7
4	4882.00	36.9 AV	54.0	-17.1	1.56 H	168	23.2	13.7

**Antenna Polarity & Test Distance : Vertical at 3 m**

No	Frequency (MHz)	Emission Level (dBuV/m)	Limit (dBuV/m)	Margin (dB)	Antenna Height (m)	Table Angle (Degree)	Raw Value (dBuV)	Correction Factor (dB/m)
1	*2441.00	92.1 PK	114.0	-21.9	3.76 V	171	89.5	2.6
2	*2441.00	76.6 AV	94.0	-17.4	3.76 V	171	74.0	2.6
3	4882.00	51.7 PK	74.0	-22.3	3.37 V	147	38.0	13.7
4	4882.00	36.2 AV	54.0	-17.8	3.37 V	147	22.5	13.7

**Remarks:**

1. Emission Level(dBuV/m) = Raw Value(dBuV) + Correction Factor(dB/m)
2. Correction Factor(dB/m) = Antenna Factor(dB/m) + Cable Factor(dB) – Pre-Amplifier Factor(dB)
3. Margin value = Emission Level – Limit value
4. The other emission levels were very low against the limit.
5. " \* ": Fundamental frequency.
6. The average value of fundamental and harmonic frequency is: Average = Peak value + 20 log(Duty cycle) Where the duty cycle correction factor is calculated from following formula:  
 $20 \log(\text{Duty cycle}) = 20 \log(0.168) = -15.5\text{dB}$

<b>RF Mode</b>	GFSK	<b>Channel</b>	CH 77 : 2480 MHz
<b>Frequency Range</b>	1 GHz ~ 25 GHz	<b>Detector Function &amp; Bandwidth</b>	Peak (PK), RB = 1 MHz, VB = 3 MHz RMS (AV), RB = 1 MHz, VB = 3 MHz

**Antenna Polarity & Test Distance : Horizontal at 3 m**

No	Frequency (MHz)	Emission Level (dBuV/m)	Limit (dBuV/m)	Margin (dB)	Antenna Height (m)	Table Angle (Degree)	Raw Value (dBuV)	Correction Factor (dB/m)
1	*2480.00	96.2 PK	114.0	-17.8	1.15 H	136	93.5	2.7
2	*2480.00	80.7 AV	94.0	-13.3	1.15 H	136	78.0	2.7
3	2483.50	60.9 PK	74.0	-13.1	1.15 H	136	58.2	2.7
<b>4</b>	<b>2483.50</b>	<b>45.4 AV</b>	<b>54.0</b>	<b>-8.6</b>	<b>1.15 H</b>	<b>136</b>	<b>42.7</b>	<b>2.7</b>
5	4960.00	52.5 PK	74.0	-21.5	1.38 H	170	38.9	13.6
6	4960.00	37.0 AV	54.0	-17.0	1.38 H	170	23.4	13.6

**Antenna Polarity & Test Distance : Vertical at 3 m**

No	Frequency (MHz)	Emission Level (dBuV/m)	Limit (dBuV/m)	Margin (dB)	Antenna Height (m)	Table Angle (Degree)	Raw Value (dBuV)	Correction Factor (dB/m)
1	*2480.00	91.9 PK	114.0	-22.1	3.88 V	169	89.2	2.7
2	*2480.00	76.4 AV	94.0	-17.6	3.88 V	169	73.7	2.7
3	2483.50	56.8 PK	74.0	-17.2	3.88 V	169	54.1	2.7
4	2483.50	41.3 AV	54.0	-12.7	3.88 V	169	38.6	2.7
5	4960.00	51.8 PK	74.0	-22.2	3.49 V	145	38.2	13.6
6	4960.00	36.3 AV	54.0	-17.7	3.49 V	145	22.7	13.6

**Remarks:**

1. Emission Level(dBuV/m) = Raw Value(dBuV) + Correction Factor(dB/m)
2. Correction Factor(dB/m) = Antenna Factor(dB/m) + Cable Factor(dB) – Pre-Amplifier Factor(dB)
3. Margin value = Emission Level – Limit value
4. The other emission levels were very low against the limit.
5. " \* ": Fundamental frequency.
6. The average value of fundamental and harmonic frequency is: Average = Peak value + 20 log(Duty cycle) Where the duty cycle correction factor is calculated from following formula:  
20 log(Duty cycle) = 20 log(0.168) = -15.5dB

## BELOW 1GHz WORST-CASE DATA

### Mode A

<b>RF Mode</b>	GFSK	<b>Channel</b>	CH 0 : 2403 MHz
<b>Frequency Range</b>	30 MHz ~ 1 GHz	<b>Detector Function &amp; Bandwidth</b>	(QP) RB = 120kHz

Antenna Polarity & Test Distance : Horizontal at 3 m								
No	Frequency (MHz)	Emission Level (dBuV/m)	Limit (dBuV/m)	Margin (dB)	Antenna Height (m)	Table Angle (Degree)	Raw Value (dBuV)	Correction Factor (dB/m)
1	38.78	20.5 QP	40.0	-19.5	1.92 H	171	30.2	-9.7
2	156.39	20.0 QP	43.5	-23.5	1.73 H	138	28.2	-8.2
3	280.41	21.0 QP	46.0	-25.0	1.24 H	197	27.7	-6.7
4	364.75	22.8 QP	46.0	-23.2	1.58 H	185	27.6	-4.8
5	446.86	25.9 QP	46.0	-20.1	1.63 H	360	28.4	-2.5
6	520.67	27.2 QP	46.0	-18.8	1.32 H	88	28.5	-1.3

### Remarks:

1. Emission Level(dBuV/m) = Raw Value(dBuV) + Correction Factor(dB/m)
2. Correction Factor(dB/m) = Antenna Factor(dB/m) + Cable Factor(dB) – Pre-Amplifier Factor(dB)
3. Margin value = Emission Level – Limit value
4. The other emission levels were very low against the limit of frequency range 30 MHz ~ 1 GHz.
5. The emission levels were very low against the limit of frequency range 9 kHz ~ 30 MHz: the amplitude of spurious emissions attenuated more than 20 dB below the permissible value to be report.

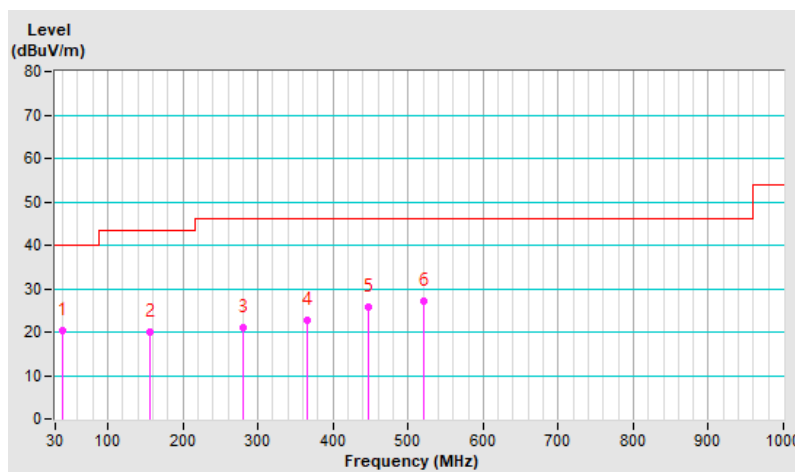

<b>RF Mode</b>	GFSK	<b>Channel</b>	CH 0 : 2403 MHz
<b>Frequency Range</b>	30 MHz ~ 1 GHz	<b>Detector Function &amp; Bandwidth</b>	(QP) RB = 120kHz

Antenna Polarity & Test Distance : Vertical at 3 m								
No	Frequency (MHz)	Emission Level (dBuV/m)	Limit (dBuV/m)	Margin (dB)	Antenna Height (m)	Table Angle (Degree)	Raw Value (dBuV)	Correction Factor (dB/m)
1	38.05	20.6 QP	40.0	-19.4	1.24 V	60	30.3	-9.7
2	127.44	21.5 QP	43.5	-22.0	1.39 V	357	31.7	-10.2
3	273.81	19.9 QP	46.0	-26.1	1.58 V	128	26.8	-6.9
4	367.90	23.6 QP	46.0	-22.4	1.72 V	126	28.3	-4.7
5	470.04	25.8 QP	46.0	-20.2	1.67 V	208	28.0	-2.2
6	560.44	27.5 QP	46.0	-18.5	1.30 V	206	28.1	-0.6

**Remarks:**

1. Emission Level(dBuV/m) = Raw Value(dBuV) + Correction Factor(dB/m)
2. Correction Factor(dB/m) = Antenna Factor(dB/m) + Cable Factor(dB) – Pre-Amplifier Factor(dB)
3. Margin value = Emission Level – Limit value
4. The other emission levels were very low against the limit of frequency range 30 MHz ~ 1 GHz.
5. The emission levels were very low against the limit of frequency range 9 kHz ~ 30 MHz: the amplitude of spurious emissions attenuated more than 20 dB below the permissible value to be report.

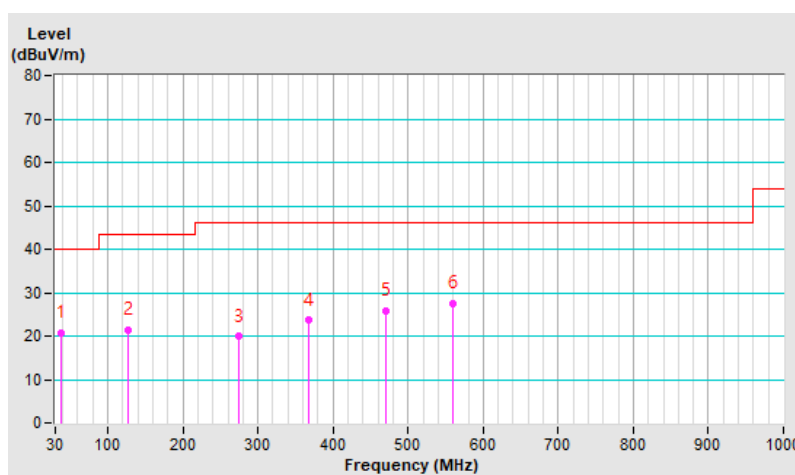

**Mode B**

<b>Frequency Range</b>	30 MHz ~ 1 GHz	<b>Detector Function &amp; Bandwidth</b>	(QP) RB = 120kHz
<b>Tested By</b>	Jed Wu	<b>Environmental Conditions</b>	25°C, 76% RH

Antenna Polarity & Test Distance : Horizontal at 3 m								
No	Frequency (MHz)	Emission Level (dBuV/m)	Limit (dBuV/m)	Margin (dB)	Antenna Height (m)	Table Angle (Degree)	Raw Value (dBuV)	Correction Factor (dB/m)
1	30.63	25.1 QP	40.0	-14.9	1.64 H	214	35.9	-10.8
2	163.62	24.2 QP	43.5	-19.3	1.52 H	146	32.5	-8.3
3	275.02	28.9 QP	46.0	-17.1	1.34 H	175	35.7	-6.8
4	363.00	27.4 QP	46.0	-18.6	1.75 H	200	32.3	-4.9
5	455.39	28.8 QP	46.0	-17.2	1.28 H	360	31.3	-2.5
6	533.09	31.1 QP	46.0	-14.9	1.11 H	167	32.1	-1.0

**Remarks:**

1. Emission Level(dBuV/m) = Raw Value(dBuV) + Correction Factor(dB/m)
2. Correction Factor(dB/m) = Antenna Factor(dB/m) + Cable Factor(dB) – Pre-Amplifier Factor(dB)
3. Margin value = Emission Level – Limit value
4. The other emission levels were very low against the limit of frequency range 30 MHz ~ 1 GHz.
5. The emission levels were very low against the limit of frequency range 9 kHz ~ 30 MHz: the amplitude of spurious emissions attenuated more than 20 dB below the permissible value to be report.

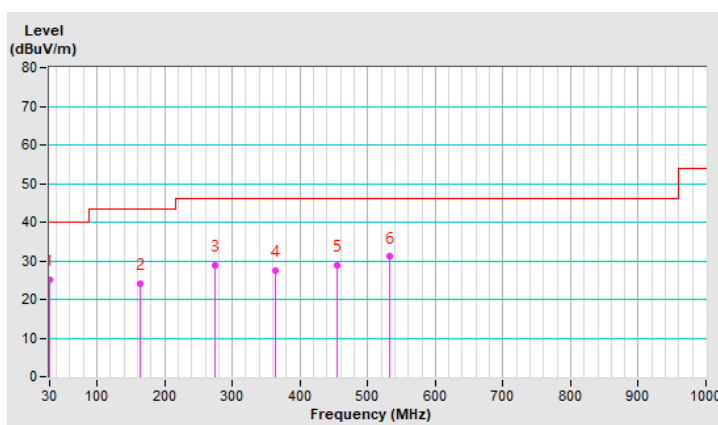



<b>Frequency Range</b>	30 MHz ~ 1 GHz	<b>Detector Function &amp; Bandwidth</b>	(QP) RB = 120kHz
<b>Tested By</b>	Jed Wu	<b>Environmental Conditions</b>	25°C, 76% RH

Antenna Polarity & Test Distance : Vertical at 3 m								
No	Frequency (MHz)	Emission Level (dBuV/m)	Limit (dBuV/m)	Margin (dB)	Antenna Height (m)	Table Angle (Degree)	Raw Value (dBuV)	Correction Factor (dB/m)
1	30.58	25.1 QP	40.0	-14.9	1.78 V	98	35.9	-10.8
2	162.60	22.7 QP	43.5	-20.8	1.49 V	160	30.9	-8.2
3	300.82	25.2 QP	46.0	-20.8	1.58 V	279	31.3	-6.1
4	368.53	26.0 QP	46.0	-20.0	1.67 V	215	30.6	-4.6
5	416.45	28.3 QP	46.0	-17.7	1.23 V	320	31.8	-3.5
6	498.32	30.6 QP	46.0	-15.4	1.38 V	348	32.4	-1.8

**Remarks:**

1. Emission Level(dBuV/m) = Raw Value(dBuV) + Correction Factor(dB/m)
2. Correction Factor(dB/m) = Antenna Factor(dB/m) + Cable Factor(dB) – Pre-Amplifier Factor(dB)
3. Margin value = Emission Level – Limit value
4. The other emission levels were very low against the limit of frequency range 30 MHz ~ 1 GHz.
5. The emission levels were very low against the limit of frequency range 9 kHz ~ 30 MHz: the amplitude of spurious emissions attenuated more than 20 dB below the permissible value to be report.

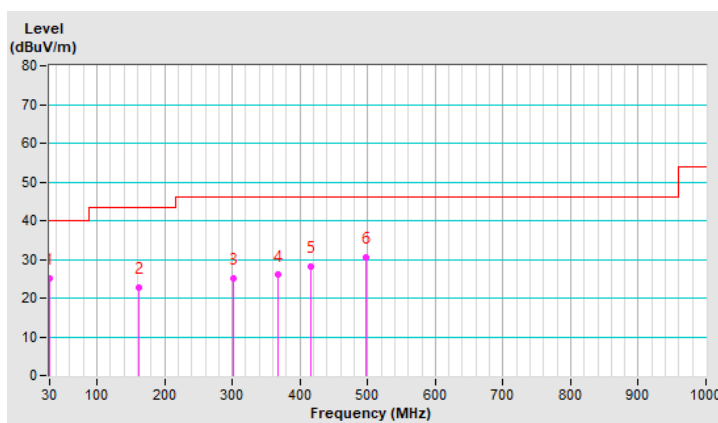

## 4.2 Conducted Emission Measurement

### 4.2.1 Limits of Conducted Emission Measurement

Frequency (MHz)	Conducted Limit (dBuV)	
	Quasi-peak	Average
0.15 - 0.5	66 - 56	56 - 46
0.50 - 5.0	56	46
5.0 - 30.0	60	50

Note: 1. The lower limit shall apply at the transition frequencies.

2. The limit decreases in line with the logarithm of the frequency in the range of 0.15 to 0.50MHz.

### 4.2.2 Test Instruments

Description Manufacturer	Model No.	Serial No.	Calibrated Date	Calibrated Until
50 ohm terminal resistance LYNICS	0900510	E1-01-305	2023/2/13	2024/2/12
		E1-011285	2022/9/19	2023/9/18
		E1-011286	2022/9/19	2023/9/18
DC LISN R&S	ESH3-Z6	100219	2022/8/2	2023/8/1
		844950/018	2022/8/2	2023/8/1
EMI Test Receiver R&S	ESCS 30	100276	2023/4/20	2024/4/19
	ESR3	102412	2022/12/21	2023/12/20
Fixed Attenuator STI	STI02-2200-10	NO.4	2022/9/2	2023/9/1
High Voltage Probe Schwarzbeck	TK9420	00982	2022/12/14	2023/12/13
Isolation Transformer Erika Fiedler	D-65396	017	2022/9/8	2023/9/7
LISN Schwarzbeck	NNLK 8121	8121-00759	2022/8/18	2023/8/17
		8121-808	2023/5/2	2024/5/1
		NSLK 8128	8128-244	2022/11/8
RF Coaxial Cable Commate	5D-FB	Cable-CO5-01	2023/1/19	2024/1/18
Software BVADT	Cond_V7.3.7.4	N/A	N/A	N/A

Notes: 1. The calibration interval of the above test instruments is 12 months and the calibrations are traceable to NML/ROC and NIST/USA.

2. The test was performed in Linkou Conduction05

3. Tested Date: 2023/6/9

#### 4.2.3 Test Procedures

- a. The EUT was placed 0.4 meters from the conducting wall of the shielded room with EUT being connected to the power mains through a line impedance stabilization network (LISN). Other support units were connected to the power mains through another LISN. The two LISNs provide 50 ohm/ 50uH of coupling impedance for the measuring instrument.
- b. Both lines of the power mains connected to the EUT were checked for maximum conducted interference.
- c. The frequency range from 150kHz to 30MHz was searched. Emission levels under (Limit - 20dB) was not recorded.

**NOTE:** The resolution bandwidth and video bandwidth of test receiver is 9kHz for quasi-peak detection (QP) and average detection (AV) at frequency 0.15MHz-30MHz.

#### 4.2.4 Deviation From Test Standard

No deviation.

#### 4.2.5 Test Setup

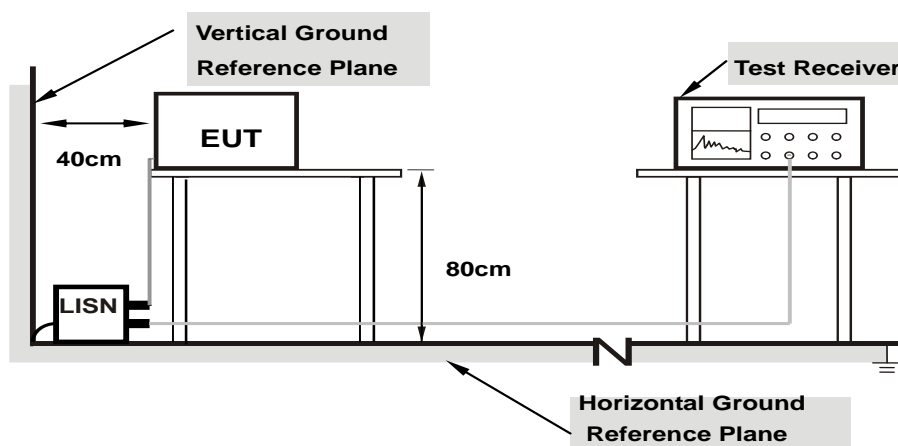

**Note: 1.Support units were connected to second LISN.**

For the actual test configuration, please refer to the attached file (Test Setup Photo).

#### 4.2.6 EUT Operating Condition

##### Mode B & C

- a. Connected the EUT to Notebook PC or Adapter
- b. Set the EUT under charging condition.

#### 4.2.7 Test Results

##### Mode B

<b>Frequency Range</b>	150kHz ~ 30MHz	<b>Detector Function &amp; Resolution Bandwidth</b>	Quasi-Peak (QP) / Average (AV), 9 kHz
<b>Tested by</b>	Jed Wu	<b>Environmental Conditions</b>	23.1°C, 62.2% RH

Phase Of Power : Line (L)										
No	Frequency (MHz)	Correction Factor (dB)	Reading Value (dBuV)		Emission Level (dBuV)		Limit (dBuV)		Margin (dB)	
			Q.P.	AV.	Q.P.	AV.	Q.P.	AV.	Q.P.	AV.
1	0.16564	9.72	37.47	19.97	47.19	29.69	65.18	55.18	-17.99	-25.49
2	0.44724	9.76	26.39	17.20	36.15	26.96	56.93	46.93	-20.78	-19.97
3	1.20007	9.79	25.54	16.25	35.33	26.04	56.00	46.00	-20.67	-19.96
4	4.68868	9.86	24.24	15.72	34.10	25.58	56.00	46.00	-21.90	-20.42
5	11.98896	10.00	19.93	16.00	29.93	26.00	60.00	50.00	-30.07	-24.00
6	22.08325	10.10	22.39	17.89	32.49	27.99	60.00	50.00	-27.51	-22.01

##### Remarks:

1. Q.P. and AV. are abbreviations of quasi-peak and average individually.
2. The emission levels of other frequencies were very low against the limit.
3. Margin value = Emission level – Limit value
4. Correction factor = Insertion loss + Cable loss
5. Emission Level = Correction Factor + Reading Value

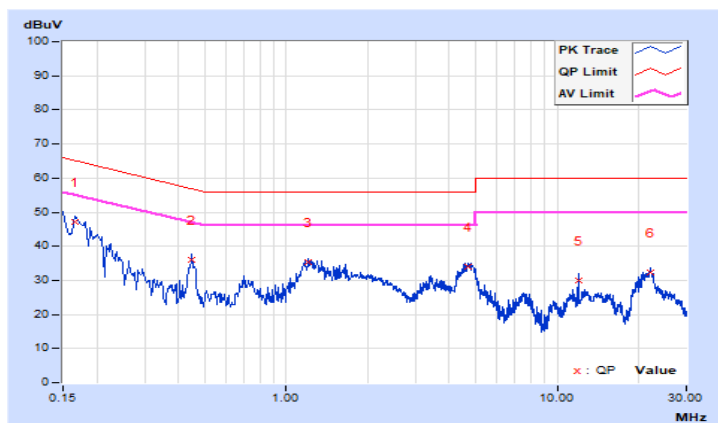

<b>Frequency Range</b>	150kHz ~ 30MHz	<b>Detector Function &amp; Resolution Bandwidth</b>	Quasi-Peak (QP) / Average (AV), 9 kHz
<b>Tested by</b>	Jed Wu	<b>Environmental Conditions</b>	23.1°C, 62.2% RH

Phase Of Power : Neutral (N)										
No	Frequency (MHz)	Correction Factor (dB)	Reading Value (dBuV)		Emission Level (dBuV)		Limit (dBuV)		Margin (dB)	
			Q.P.	AV.	Q.P.	AV.	Q.P.	AV.	Q.P.	AV.
1	0.16564	9.72	38.63	16.50	48.35	26.22	65.18	55.18	-16.83	-28.96
2	0.45456	9.76	25.04	16.41	34.80	26.17	56.79	46.79	-21.99	-20.62
<b>3</b>	<b>1.10621</b>	<b>9.80</b>	<b>30.37</b>	<b>24.44</b>	<b>40.17</b>	<b>34.24</b>	<b>56.00</b>	<b>46.00</b>	<b>-15.83</b>	<b>-11.76</b>
4	4.69259	9.88	21.15	12.98	31.03	22.86	56.00	46.00	-24.97	-23.14
5	7.44437	9.94	20.79	14.71	30.73	24.65	60.00	50.00	-29.27	-25.35
6	20.74178	10.19	18.26	13.60	28.45	23.79	60.00	50.00	-31.55	-26.21

**Remarks:**

1. Q.P. and AV. are abbreviations of quasi-peak and average individually.
2. The emission levels of other frequencies were very low against the limit.
3. Margin value = Emission level – Limit value
4. Correction factor = Insertion loss + Cable loss
5. Emission Level = Correction Factor + Reading Value

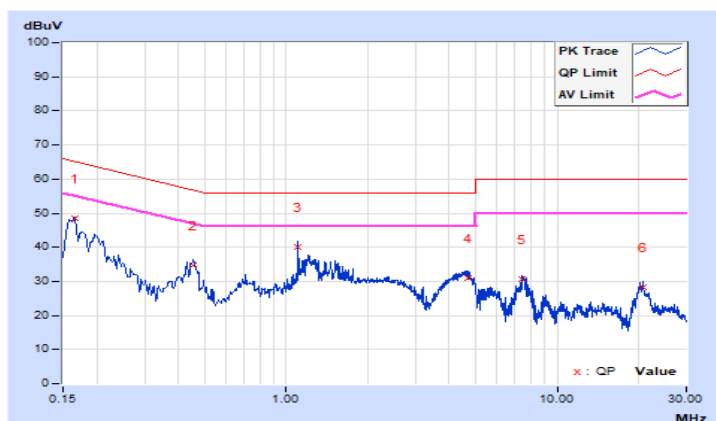

### Mode C

<b>Frequency Range</b>	150kHz ~ 30MHz	<b>Detector Function &amp; Resolution Bandwidth</b>	Quasi-Peak (QP) / Average (AV), 9 kHz
<b>Tested by</b>	Jed Wu	<b>Environmental Conditions</b>	23.1°C, 62.2% RH

Phase Of Power : Line (L)										
No	Frequency (MHz)	Correction Factor (dB)	Reading Value (dBuV)		Emission Level (dBuV)		Limit (dBuV)		Margin (dB)	
			Q.P.	AV.	Q.P.	AV.	Q.P.	AV.	Q.P.	AV.
1	0.16956	9.72	24.37	4.77	34.09	14.49	64.98	54.98	-30.89	-40.49
2	0.43926	9.76	16.57	4.33	26.33	14.09	57.08	47.08	-30.75	-32.99
3	0.78843	9.78	21.85	14.95	31.63	24.73	56.00	46.00	-24.37	-21.27
4	1.21962	9.79	22.45	5.52	32.24	15.31	56.00	46.00	-23.76	-30.69
5	5.63358	9.88	16.81	8.03	26.69	17.91	60.00	50.00	-33.31	-32.09
6	9.74013	9.96	16.79	9.53	26.75	19.49	60.00	50.00	-33.25	-30.51

### Remarks:

1. Q.P. and AV. are abbreviations of quasi-peak and average individually.
2. The emission levels of other frequencies were very low against the limit.
3. Margin value = Emission level – Limit value
4. Correction factor = Insertion loss + Cable loss
5. Emission Level = Correction Factor + Reading Value

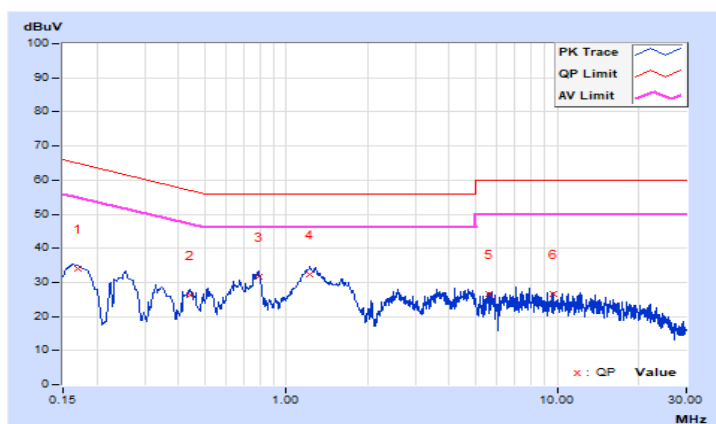

<b>Frequency Range</b>	150kHz ~ 30MHz	<b>Detector Function &amp; Resolution Bandwidth</b>	Quasi-Peak (QP) / Average (AV), 9 kHz
<b>Tested by</b>	Jed Wu	<b>Environmental Conditions</b>	23.1°C, 62.2% RH

Phase Of Power : Neutral (N)										
No	Frequency (MHz)	Correction Factor (dB)	Reading Value (dBuV)		Emission Level (dBuV)		Limit (dBuV)		Margin (dB)	
			Q.P.	AV.	Q.P.	AV.	Q.P.	AV.	Q.P.	AV.
1	0.16956	9.73	24.06	4.15	33.79	13.88	64.98	54.98	-31.19	-41.10
2	0.43123	9.76	15.52	3.19	25.28	12.95	57.23	47.23	-31.95	-34.28
3	0.79332	9.79	20.34	11.98	30.13	21.77	56.00	46.00	-25.87	-24.23
4	1.20505	9.80	22.87	3.63	32.67	13.43	56.00	46.00	-23.33	-32.57
5	5.78611	9.90	15.24	5.45	25.14	15.35	60.00	50.00	-34.86	-34.65
6	9.23952	9.98	14.81	5.21	24.79	15.19	60.00	50.00	-35.21	-34.81

**Remarks:**

1. Q.P. and AV. are abbreviations of quasi-peak and average individually.
2. The emission levels of other frequencies were very low against the limit.
3. Margin value = Emission level – Limit value
4. Correction factor = Insertion loss + Cable loss
5. Emission Level = Correction Factor + Reading Value

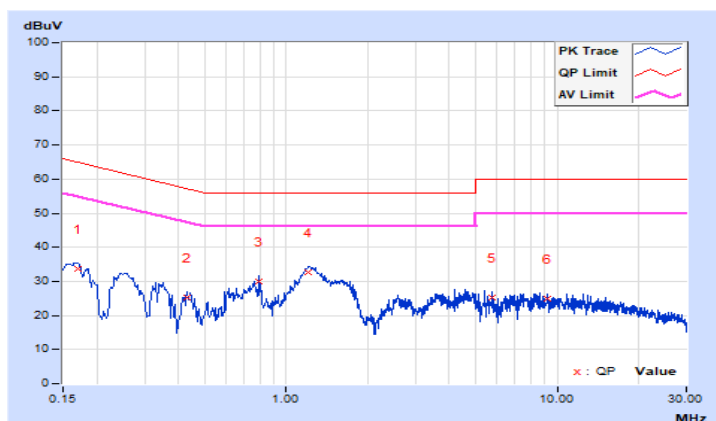

### 4.3 Channel Bandwidth

#### 4.3.1 Test Setup

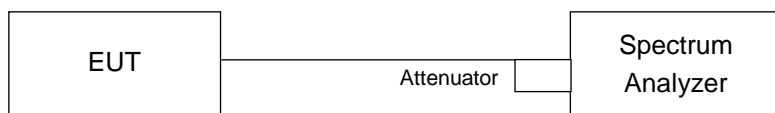

#### 4.3.2 Test Instruments

Description & Manufacturer	Model no.	Serial No.	Calibrated Date	Calibrated Until
Spectrum Analyzer R&S	FSV40	101544	2023/5/9	2024/5/8

- NOTE:**
1. The calibration interval of the above test instruments is 12 months. And the calibrations are traceable to NML/ROC and NIST/USA.
  2. The test was performed in LK - Oven
  3. Tested Date: 2023/6/14

#### 4.3.3 Test Procedure

- a. Check the calibration of the measuring instrument using either an internal calibrator or a known signal from an external generator.
- b. Turn on the EUT and connect it to measurement instrument. Then set it to any one convenient frequency within its operating range. Set a reference level on the measuring instrument equal to the highest peak value.
- c. Measure the frequency difference of two frequencies that were attenuated 20dB from the reference level. Record the frequency difference as the emission bandwidth.
- d. Repeat above procedures until all frequencies measured were complete.

#### 4.3.4 Deviation from Test Standard

No deviation.

#### 4.3.5 EUT Operating Condition

The software provided by client enabled the EUT to transmit and receive data at lowest, middle and highest channel frequencies individually.



#### 4.3.6 Test Results

Channel	Frequency (MHz)	20dB Bandwidth (MHz)
0	2403	1.73
38	2441	2.13
77	2480	2.12

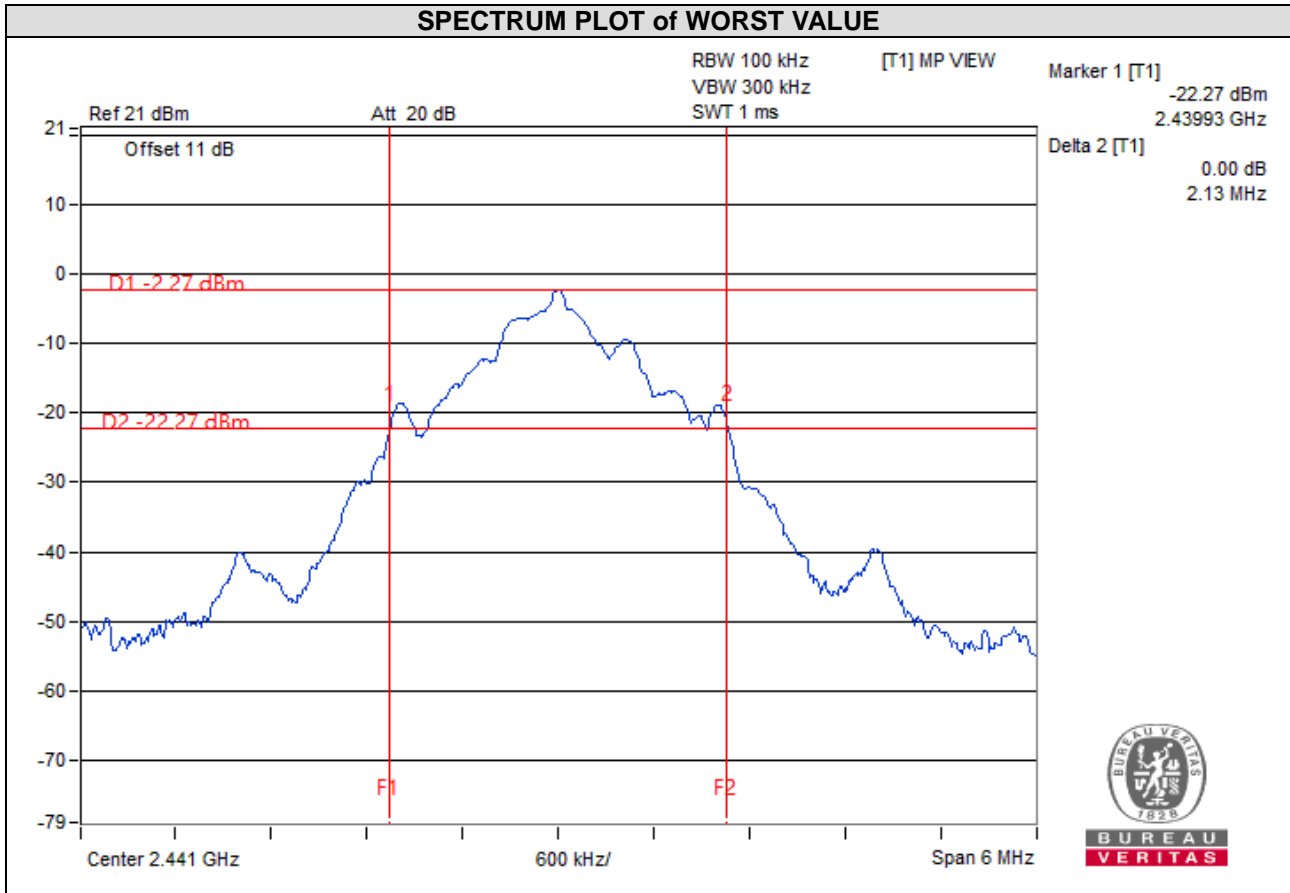

## 5 Pictures of Test Arrangements

Please refer to the attached file (Test Setup Photo).

## Appendix – Information of the Testing Laboratories

We, Bureau Veritas Consumer Products Services (H.K.) Ltd., Taoyuan Branch, were founded in 1988 to provide our best service in EMC, Radio, Telecom and Safety consultation. Our laboratories are FCC recognized accredited test firms and accredited according to ISO/IEC 17025.

If you have any comments, please feel free to contact us at the following:

**Lin Kou EMC/RF Lab**

Tel: 886-2-26052180

Fax: 886-2-26051924

**Hsin Chu EMC/RF/Telecom Lab**

Tel: 886-3-6668565

Fax: 886-3-6668323

**Hwa Ya EMC/RF/Safety Lab**

Tel: 886-3-3183232

Fax: 886-3-3270892

**Email:** [service.adt@tw.bureauveritas.com](mailto:service.adt@tw.bureauveritas.com)

**Web Site:** <http://ee.bureauveritas.com.tw>

The address and road map of all our labs can be found in our web site also.

--- END ---