

FCC Test Report

Report No.: RFBBDJ-WTW-P23010532-1

FCC ID: 2AAFMRGP0145

Product: Wireless Mouse

Brand: CORSAIR

Model No.: RGP0145

Received Date: 2023/1/30

Test Date: 2023/1/31 ~ 2023/2/11

Issued Date: 2023/3/29

Applicant: Corsair Memory, Inc.

Address: 115 North McCarthy Blvd, Milpitas, CA 95035, USA

Issued By: Bureau Veritas Consumer Products Services (H.K.) Ltd., Taoyuan Branch
Lin Kou Laboratories

Lab Address: No. 47-2, 14th Ling, Chia Pau Vil., Lin Kou Dist., New Taipei City, Taiwan

**FCC Registration /
Designation Number:** 198487 / TW2021



This report is governed by, and incorporates by reference, the Conditions of Testing as posted at the date of issuance of this report at <http://www.bureauveritas.com/home/about-us/our-business/cps/about-us/terms-conditions/> and is intended for your exclusive use. Any copying or replication of this report to or for any other person or entity, or use of our name or trademark, is permitted only with our prior written permission. This report sets forth our findings solely with respect to the test samples identified herein. The results set forth in this report are not indicative or representative of the quality or characteristics of the lot from which a test sample was taken or any similar or identical product unless specifically and expressly noted. Our report includes all of the tests requested by you and the results thereof based upon the information that you provided to us. Measurement uncertainty is only provided upon request for accredited tests. Statements of conformity are based on simple acceptance criteria without taking measurement uncertainty into account, unless otherwise requested in writing. You have 60 days from date of issuance of this report to notify us of any material error or omission caused by our negligence or if you require measurement uncertainty; provided, however, that such notice shall be in writing and shall specifically address the issue you wish to raise. A failure to raise such issue within the prescribed time shall constitute your unqualified acceptance of the completeness of this report, the tests conducted and the correctness of the report contents.

Table of Contents

Release Control Record	3
1 Certificate of Conformity	4
2 Summary of Test Results	5
2.1 Measurement Uncertainty	5
2.2 Modification Record	5
3 General Information	6
3.1 General Description of EUT	6
3.2 Description of Test Modes	7
3.2.1 Test Mode Applicability and Tested Channel Detail	8
3.3 Duty Cycle of Test Signal	9
3.4 Description of Support Units	10
3.4.1 Configuration of System under Test	11
3.5 General Description of Applied Standards	12
4 Test Types and Results	13
4.1 Radiated Emission and Bandedge Measurement	13
4.1.1 Limits of Radiated Emission and Bandedge Measurement	13
4.1.2 Test Instruments	14
4.1.3 Test Procedures	16
4.1.4 Deviation from Test Standard	16
4.1.5 Test Setup	17
4.1.6 EUT Operating Conditions	18
4.1.7 Test Results	19
4.2 Conducted Emission Measurement	26
4.2.1 Limits of Conducted Emission Measurement	26
4.2.2 Test Instruments	27
4.2.3 Test Procedures	28
4.2.4 Deviation From Test Standard	28
4.2.5 Test Setup	28
4.2.6 EUT Operating Condition	29
4.2.7 Test Results	30
4.3 Channel Bandwidth	34
4.3.1 Test Setup	34
4.3.2 Test Instruments	34
4.3.3 Test Procedure	34
4.3.4 Deviation from Test Standard	34
4.3.5 EUT Operating Condition	34
4.3.6 Test Results	35
5 Pictures of Test Arrangements	36
Appendix – Information of the Testing Laboratories	37

Release Control Record

Issue No.	Description	Date Issued
RFBBDJ-WTW-P23010532-1	Original release.	2023/3/29

1 Certificate of Conformity

Product: Wireless Mouse
Brand: CORSAIR
Test Model: RGP0145
Sample Status: Engineering sample
Applicant: Corsair Memory, Inc.
Test Date: 2023/1/31 ~ 2023/2/11
Standards: 47 CFR FCC Part 15, Subpart C (Section 15.249)
Measurement procedure: ANSI C63.10: 2013

The above equipment has been tested by **Bureau Veritas Consumer Products Services (H.K.) Ltd., Taoyuan Branch**, and found compliance with the requirement of the above standards. The test record, data evaluation & Equipment Under Test (EUT) configurations represented herein are true and accurate accounts of the measurements of the sample's RF characteristics under the conditions specified in this report.

Prepared by : *Jessica Cheng* , **Date:** 2023/3/29
 Jessica Cheng / Senior Specialist

Approved by : *Jeremy Lin* , **Date:** 2023/3/29
 Jeremy Lin / Project Engineer

2 Summary of Test Results

47 CFR FCC Part 15, Subpart C (SECTION 15.249)			
FCC Clause	Test Item	Result	Remarks
15.207	AC Power Conducted Emission	PASS	Meet the requirement of limit. Minimum passing margin is -16.01dB at 8.37109MHz.
15.215	Channel Bandwidth Measurement	PASS	Meet the requirement of limit.
15.209 15.249 (a) 15.249 (d)	Radiated Emission and Bandedge Measurement	PASS	Meet the requirement of limit. Minimum passing margin is -3.4dB at 2403.00MHz.
15.203	Antenna Requirement	PASS	No antenna connector is used.

Note: Determining compliance based on the results of the compliance measurement, not taking into account measurement instrumentation uncertainty.

2.1 Measurement Uncertainty

Where relevant, the following measurement uncertainty levels have been estimated for tests performed on the EUT as specified in CISPR 16-4-2:

Parameter	Specification	Expanded Uncertainty (k=2) (±)
Conducted Out of Band Emissions	9 kHz ~ 40 GHz	2.63 dB
AC Power Conducted Emissions	150 kHz ~ 30 MHz	3.00 dB
Unwanted Emissions below 1 GHz	9 kHz ~ 30 MHz	2.38 dB
	30 MHz ~ 1 GHz	5.7 dB
Unwanted Emissions above 1 GHz	1 GHz ~ 6 GHz	4.83 dB
	6 GHz ~ 18 GHz	5.37 dB
	18 GHz ~ 40 GHz	5.24 dB

The other instruments specified are routine verified to remain within the calibrated levels, no measurement uncertainty is required to be calculated.

2.2 Modification Record

There were no modifications required for compliance.

3 General Information

3.1 General Description of EUT

Product	Wireless Mouse
Brand	CORSAIR
Test Model	RGP0145
Status of EUT	Engineering sample
Power Supply Rating	3.8Vdc from battery or 5Vdc from USB port
Modulation Type	GFSK
Operating Frequency	2403 ~ 2480 MHz
Number of Channel	78
Field Strength	90.6dBuV/m (3m)
Antenna Type	SMD Antenna with 2.1dBi gain
Antenna Connector	N/A
Accessory Device	Refer to note as below
Data Cable Supplied	N/A

Note:

1. The EUT uses following accessories.

Shielded USB Cable 1.9m

2. There are Bluetooth and GFSK technology used for the EUT.
3. Bluetooth and GFSK technology can not transmit at same time.
4. For Radiated Emissions test mode, following modes were pre-tested:

Pre-Scan:	1. For Unwanted Emission below 1 GHz Charging mode has EUT with USB Cable+NB /EUT with USB Cable+Adapter. Pre-scan these modes and find the worst case as a representative test condition.
Worst Case:	1. For Unwanted Emission below 1 GHz Charging mode: EUT with USB Cable+NB.

5. Due to radiated measurements are made and the antenna gain is already accounted for this device, so provide an antenna datasheet and/or antenna measurement report is not required. The antenna dimensions and pictures (include antenna wire length if have) are stated in EUT photo exhibit.
6. The above EUT information is declared by manufacturer and for more detailed features description, please refers to the manufacturer's specifications or user's manual.

3.2 Description of Test Modes

78 channels are provided to this EUT:

Channel	Frequency (MHz)	Channel	Frequency (MHz)	Channel	Frequency (MHz)	Channel	Frequency (MHz)
1	2403	21	2423	41	2443	61	2463
2	2404	22	2424	42	2444	62	2464
3	2405	23	2425	43	2445	63	2465
4	2406	24	2426	44	2446	64	2466
5	2407	25	2427	45	2447	65	2467
6	2408	26	2428	46	2448	66	2468
7	2409	27	2429	47	2449	67	2469
8	2410	28	2430	48	2450	68	2470
9	2411	29	2431	49	2451	69	2471
10	2412	30	2432	50	2452	70	2472
11	2413	31	2433	51	2453	71	2473
12	2414	32	2434	52	2454	72	2474
13	2415	33	2435	53	2455	73	2475
14	2416	34	2436	54	2456	74	2476
15	2417	35	2437	55	2457	75	2477
16	2418	36	2438	56	2458	76	2478
17	2419	37	2439	57	2459	77	2479
18	2420	38	2440	58	2460	78	2480
19	2421	39	2441	59	2461		
20	2422	40	2442	60	2462		

3.2.1 Test Mode Applicability and Tested Channel Detail

EUT Configure Mode	Applicable To				Description
	RE \geq 1G	RE $<$ 1G	PLC	APCM	
A	√	√	-	√	EUT only
B	-	√	√	-	EUT with USB Cable+NB
C	-	-	√	-	EUT with USB Cable+Adapter

Where **RE \geq 1G:** Radiated Emission above 1GHz & Bandedge Measurement

RE $<$ 1G: Radiated Emission below 1GHz

PLC: Power Line Conducted Emission

APCM: Antenna Port Conducted Measurement

Radiated Emission Test (Above 1GHz):

- Pre-Scan has been conducted to determine the worst-case mode from all possible combinations between available modulations, data rates and antenna ports (if EUT with antenna diversity architecture).
- Following channel(s) was (were) selected for the final test as listed below.

EUT Configure Mode	Available Channel	Tested Channel	Modulation Type
A	1 to 78	1, 39, 78	GFSK

Radiated Emission Test (Below 1GHz):

- Pre-Scan has been conducted to determine the worst-case mode from all possible combinations between available modulations, data rates and antenna ports (if EUT with antenna diversity architecture).
- Following channel(s) was (were) selected for the final test as listed below.

EUT Configure Mode	Available Channel	Tested Channel	Modulation Type
A	1 to 78	1	GFSK
B	-	-	-

Power Line Conducted Emission Test:

- Pre-Scan has been conducted to determine the worst-case mode from all possible combinations between available modulations, data rates and antenna ports (if EUT with antenna diversity architecture).
- Following channel(s) was (were) selected for the final test as listed below.

EUT Configure Mode	Available Channel	Tested Channel	Modulation Type
B	-	-	-
C	-	-	-

Antenna Port Conducted Measurement:

- This item includes all test value of each mode, but only includes spectrum plot of worst value of each mode.
- Pre-Scan has been conducted to determine the worst-case mode from all possible combinations between available modulations, data rates and antenna ports (if EUT with antenna diversity architecture).
- Following channel(s) was (were) selected for the final test as listed below.

EUT Configure Mode	Available Channel	Tested Channel	Modulation Type
A	1 to 78	1, 39, 78	GFSK

Test Condition:

Applicable To	EUT Configure Mode	Environmental Conditions	Input Power	Tested By
RE \geq 1G	A	17.4deg. C, 62.7%RH	3.8Vdc	Jed Wu
RE $<$ 1G	A	14deg. C, 58%RH	3.8Vdc	Jed Wu
	B	14deg. C, 58%RH	120Vac, 60Hz (System)	Jed Wu
PLC	B	25deg. C, 75%RH	120Vac, 60Hz (System)	Jed Wu
	C	25deg. C, 75%RH	120Vac, 60Hz (Adapter)	Jed Wu
APCM	A	25deg. C, 76%RH	3.8Vdc	Dalen Dai

3.3 Duty Cycle of Test Signal

Duty cycle correction factor = $20 \log(\text{Duty cycle}) = 20 \log(0.108 \text{ ms} / 0.225 \text{ ms}) = -6.4 \text{ dB}$

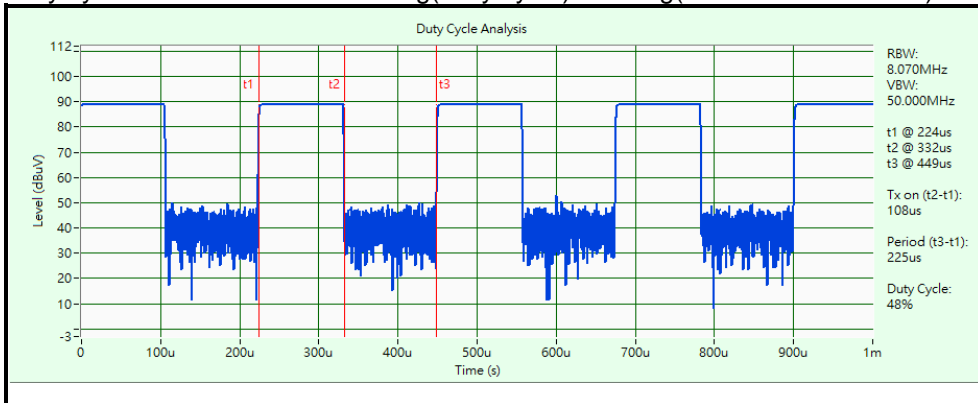

3.4 Description of Support Units

The EUT has been tested as an independent unit together with other necessary accessories or support units. The following support units or accessories were used to form a representative test configuration during the tests.

ID	Product	Brand	Model No.	Serial No.	FCC ID	Remarks
A	Laptop	Lenovo	81A4	YD02TWDP	N/A	Provided by Lab
B	Laptop Adapter	Lenovo	N/A	N/A	N/A	Provided by Lab
C	Adapter	APPLE	A1305	N/A	N/A	Provided by Lab

ID	Cable Descriptions	Qty.	Length (m)	Shielding (Yes/No)	Cores (Qty.)	Remarks
1	Type C to USB cable	1	1.9	Y	0	Supplied by applicant
2	NB Adapter DC cable	1	1.9	N	0	Provided by Lab

3.4.1 Configuration of System under Test

Mode A

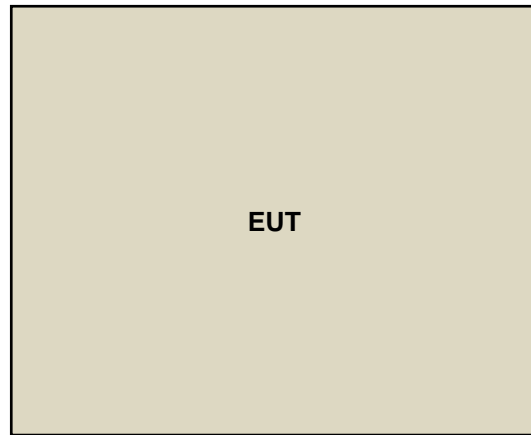

Under Table

Mode B

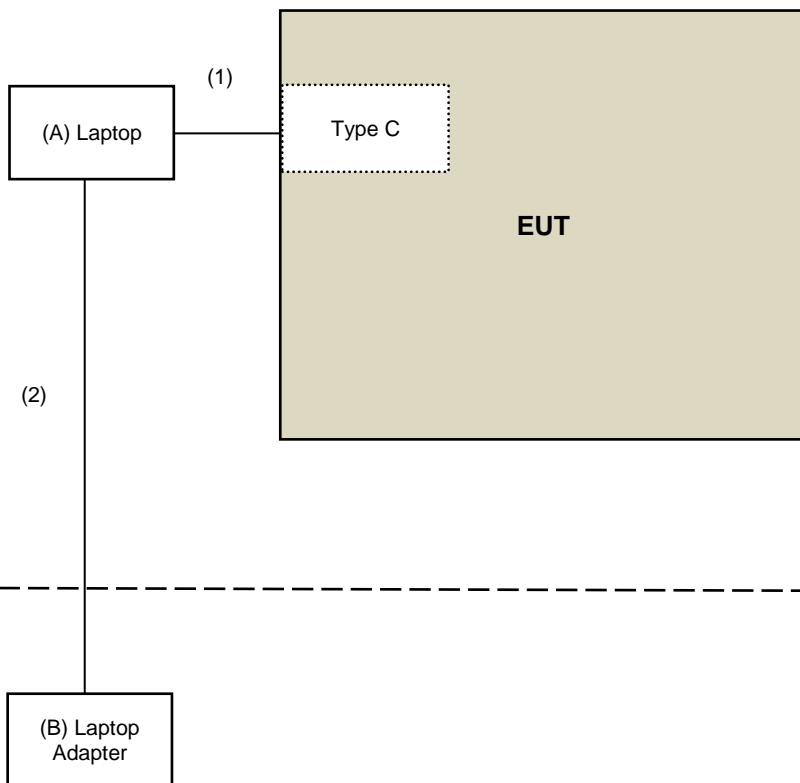

Under Table

Mode C

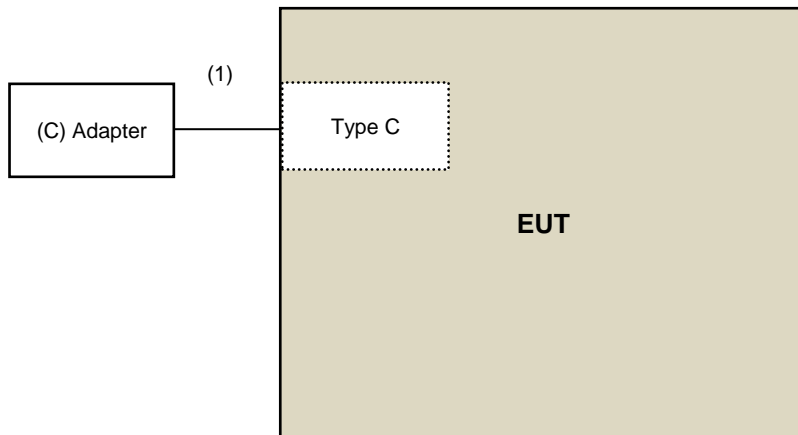

Under Table

3.5 General Description of Applied Standards

The EUT is a RF Product. According to the specifications of the manufacturer, it must comply with the requirements of the following standards:

FCC Part 15, Subpart C (15.249)

ANSI C63.10-2013

All test items have been performed and recorded as per the above standards.

4 Test Types and Results

4.1 Radiated Emission and Bandedge Measurement

4.1.1 Limits of Radiated Emission and Bandedge Measurement

The field strength of emissions from intentional radiators operated within these frequency bands shall comply with the following

Fundamental Frequency	Field Strength of Fundamental (millivolts/meter)	Field Strength of Harmonics (microvolts/meter)
902 ~ 928 MHz	50	500
2400 ~ 2483.5 MHz	50	500
5725 ~ 5875 MHz	50	500
24 ~ 24.25 GHz	250	2500

Emissions radiated outside of the specified frequency bands, except for harmonics, shall be attenuated by at least 50 dB below the level of the fundamental or to the general radiated emission limits as below table, whichever is the lesser attenuation

Frequencies (MHz)	Field Strength (microvolts/meter)	Measurement Distance (meters)
0.009 ~ 0.490	2400/F(kHz)	300
0.490 ~ 1.705	24000/F(kHz)	30
1.705 ~ 30.0	30	30
30 ~ 88	100	3
88 ~ 216	150	3
216 ~ 960	200	3
Above 960	500	3

NOTE:

1. The lower limit shall apply at the transition frequencies.
2. Emission level (dBuV/m) = 20 log Emission level (uV/m).
3. For frequencies above 1000MHz, the field strength limits are based on average detector, however, the peak field strength of any emission shall not exceed the maximum permitted average limits, specified above by more than 20dB under any condition of modulation.

4.1.2 Test Instruments

Below 1 GHz:

Description Manufacturer	Model No.	Serial No.	Calibrated Date	Calibrated Until
* LOOP ANTENNA EMCI	LPA600	270	2021/9/2	2023/9/1
Bi_Log Antenna Schwarzbeck	VULB 9168	137	2022/10/21	2023/10/20
Coupling/Dcoupling Network Schwarzbeck	CDNE-M2	00097	2022/6/1	2023/5/31
	CDNE-M3	00091	2022/6/1	2023/5/31
Pre_Amplifier EMCI	EMC001340	980269	2022/6/28	2023/6/27
Pre_Amplifier HP	8447D	2432A03504	2022/2/17	2023/2/16
RF Coaxial Cable Pacific	8D-FB	Cable-CH6-02	2022/6/30	2023/6/29
Software BVADT	Radiated_V7.7.1.1.1	N/A	N/A	N/A
	Radiated_V8.7.08	N/A	N/A	N/A
Spectrum Analyzer R&S	FSV40	101544	2022/5/9	2023/5/8
Test Receiver Agilent	N9038A	MY51210129	2022/4/8	2023/4/7
		MY51210137	2022/6/9	2023/6/8
Tower ADT	AT100	0306	N/A	N/A
Turn Table ADT	TT100	0306	N/A	N/A

Notes:

1. The calibration interval of the above test instruments is 12/24 months and the calibrations are traceable to NML/ROC and NIST/USA
2. The test was performed in Linkou 966 Chamber 6 (CH 6).
3. Tested Date: 2023/2/7 ~ 2023/2/8

Above 1 GHz:

Description Manufacturer	Model No.	Serial No.	Calibrated Date	Calibrated Until
Band Pass Filter MICRO-TRONICS	BRM17690	005	2022/5/26	2023/5/25
Boresight antenna tower fixture BV	BAF-02	6	N/A	N/A
High Pass Filter Wainwright Instruments	WHK 3.1/18G-10SS	SN 8	2022/5/26	2023/5/25
Horn Antenna EMCO	3115	00028257	2022/11/13	2023/11/12
Horn Antenna ETS-Lindgren	3117-PA	00215857	2022/11/13	2023/11/12
Horn Antenna Schwarzbeck	BBHA 9170	212	2022/10/20	2023/10/19
Notch Filter MICRO-TRONICS	BRC50703-01	010	2022/5/26	2023/5/25
Pre-amplifier HP	8449B	3008A01201	2022/2/17	2023/2/16
Pre-amplifier (18GHz-40GHz) EMCI	EMC184045B	980175	2022/9/3	2023/9/2
Pre_Amplifier EMCI	EMC0126545	980076	2022/2/17	2023/2/16
	EMC184045B	980235	2022/2/17	2023/2/16
RF Coaxial Cable EM	EM102-KMKM-3.5+1M	EM102-KMKM- 3.5+1M-01	2022/7/7	2023/7/6
RF Coaxial Cable EMCI		190801	2022/7/7	2023/7/6
		190804	2022/7/7	2023/7/6
RF Coaxial Cable HUBER SUHNER	SF-104	Cable-CH6-01	2022/9/20	2023/9/19
Software BVADT	Radiated_V7.7.1.1.1	N/A	N/A	N/A
	Radiated_V8.7.08	N/A	N/A	N/A
Spectrum Analyzer R&S	FSV40	101042	2022/9/5	2023/9/4
		101544	2022/5/9	2023/5/8
Test Receiver Agilent	N9038A	MY51210129	2022/4/8	2023/4/7
Tower ADT	AT100	0306	N/A	N/A
Turn Table ADT	TT100	0306	N/A	N/A

Notes:

1. The calibration interval of the above test instruments is 12/24 months and the calibrations are traceable to NML/ROC and NIST/USA
2. The test was performed in Linkou 966 Chamber 6 (CH 6).
3. Tested Date: 2023/2/7

4.1.3 Test Procedures

For Radiated emission below 30MHz

- a. The EUT was placed on the top of a rotating table 0.8 meters above the ground at a 3 meter chamber room. The table was rotated 360 degrees to determine the position of the highest radiation.
- b. The EUT was set 3 meters away from the interference-receiving antenna, which was mounted on the top of a variable-height antenna tower.
- c. Parallel, perpendicular, and ground-parallel orientations of the antenna are set to make the measurement.
- d. For each suspected emission, the EUT was arranged to its worst case and the rotatable table was turned from 0 degrees to 360 degrees to find the maximum reading.
- e. The test-receiver system was set to Quasi-Peak Detect Function and Specified Bandwidth with Maximum Hold Mode.

NOTE:

1. The resolution bandwidth and video bandwidth of test receiver/spectrum analyzer is 9kHz at frequency below 30MHz.

For Radiated emission above 30MHz

- a. The EUT was placed on the top of a rotating table 0.8 meters (for 30MHz ~ 1GHz) / 1.5 meters (for above 1GHz) above the ground at 3 meter chamber room for test. The table was rotated 360 degrees to determine the position of the highest radiation.
- b. The EUT was set 3 meters away from the interference-receiving antenna, which was mounted on the top of a variable-height antenna tower.
- c. The height of antenna is varied from one meter to four meters above the ground to determine the maximum value of the field strength. Both horizontal and vertical polarizations of the antenna are set to make the measurement.
- d. For each suspected emission, the EUT was arranged to its worst case and then the antenna was tuned to heights from 1 meter to 4 meters and the rotatable table was turned from 0 degrees to 360 degrees to find the maximum reading.
- e. The test-receiver system was set to quasi-peak detect function and specified bandwidth with maximum hold mode when the test frequency is below 1 GHz.
- f. The test-receiver system was set to peak and average detect function and specified bandwidth with maximum hold mode when the test frequency is above 1 GHz. If the peak reading value also meets average limit, measurement with the average detector is unnecessary.

Note:

1. The resolution bandwidth and video bandwidth of test receiver/spectrum analyzer is 120kHz for Quasi-peak detection (QP) at frequency below 1GHz.
2. The resolution bandwidth of test receiver/spectrum analyzer is 1 MHz and the video bandwidth is 3 MHz for Peak detection (PK) and Average detection at frequency above 1GHz. For fundamental and harmonic signal measurement, according to ANSI C63.10 section 7.5, the average value = peak value + duty factor. The duty factor refer to Chapter 3.3 of this report.
3. All modes of operation were investigated and the worst-case emissions are reported.

4.1.4 Deviation from Test Standard

No deviation.

4.1.5 Test Setup

For Radiated emission below 30MHz

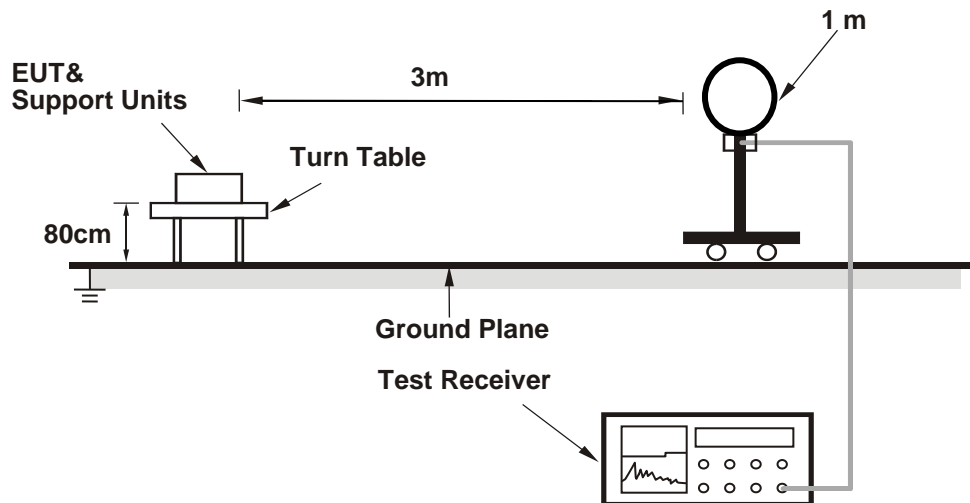

For Radiated emission 30MHz to 1GHz

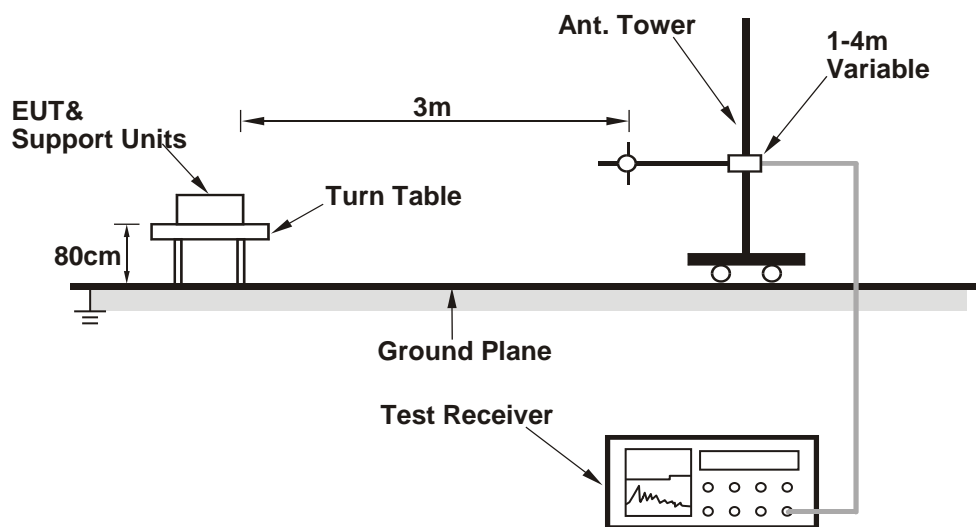

For Radiated emission above 1GHz

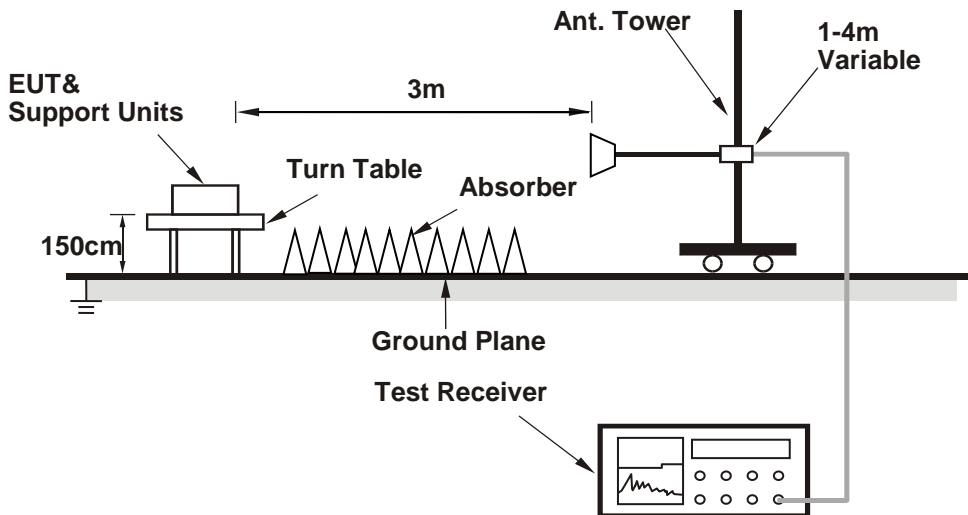

For the actual test configuration, please refer to the attached file (Test Setup Photo).

4.1.6 EUT Operating Conditions

Mode A

Set the EUT under transmission and charging condition continuously at specific channel frequency.

Mode B

- a. Connected the EUT to Laptop via USB cable.
- b. Set the EUT under charging condition.

4.1.7 Test Results

Mode A

ABOVE 1GHz DATA

RF Mode	TX GFSK	Channel	CH 1 : 2403 MHz
Frequency Range	1 GHz ~ 25 GHz	Detector Function & Bandwidth	(PK) RB = 1 MHz, VB = 3 MHz (AV) RB = 1 MHz, VB = 3 MHz (RMS)

Antenna Polarity & Test Distance : Horizontal at 3 m

No	Frequency (MHz)	Emission Level (dBuV/m)	Limit (dBuV/m)	Margin (dB)	Antenna Height (m)	Table Angle (Degree)	Raw Value (dBuV)	Correction Factor (dB/m)
1	2390.00	47.9 PK	74.0	-26.1	1.03 H	336	45.80	2.10
2	2390.00	38.8 AV	54.0	-15.2	1.03 H	336	36.70	2.10
3	2400.00	43.0 PK	74.0	-31.0	1.03 H	336	40.90	2.10
4	2400.00	36.6 AV	54.0	-17.4	1.03 H	336	34.50	2.10
5	*2403.00	97.0 PK	114.0	-17.0	1.03 H	336	94.60	2.40
6	*2403.00	90.6 AV	94.0	-3.4	1.03 H	336	88.20	2.40
7	4806.00	51.5 PK	74.0	-22.5	1.16 H	309	39.50	12.00
8	4806.00	45.1 AV	54.0	-8.9	1.16 H	309	33.10	12.00

Antenna Polarity & Test Distance : Vertical at 3 m

No	Frequency (MHz)	Emission Level (dBuV/m)	Limit (dBuV/m)	Margin (dB)	Antenna Height (m)	Table Angle (Degree)	Raw Value (dBuV)	Correction Factor (dB/m)
1	2390.00	45.7 PK	74.0	-28.3	3.06 V	76	43.60	2.10
2	2390.00	35.2 AV	54.0	-18.8	3.06 V	76	33.10	2.10
3	2400.00	38.4 PK	74.0	-35.6	3.06 V	76	36.30	2.10
4	2400.00	32.0 AV	54.0	-22.0	3.06 V	76	29.90	2.10
5	*2403.00	91.5 PK	114.0	-22.5	3.06 V	76	89.10	2.40
6	*2403.00	85.1 AV	94.0	-8.9	3.06 V	76	82.70	2.40
7	4806.00	50.1 PK	74.0	-23.9	2.84 V	108	38.10	12.00
8	4806.00	43.7 AV	54.0	-10.3	2.84 V	108	31.70	12.00

Remarks:

1. Emission Level(dBuV/m) = Raw Value(dBuV) + Correction Factor(dB/m)
2. Correction Factor(dB/m) = Antenna Factor(dB/m) + Cable Factor(dB) – Pre-Amplifier Factor(dB)
3. Margin value = Emission Level – Limit value
4. The other emission levels were very low against the limit.
5. " * " : Fundamental frequency.
6. The average value of fundamental and harmonic frequency is: Average value = Peak value + 20 log(Duty cycle) Where the duty cycle correction factor is calculated from following formula:
 $20 \log(\text{Duty cycle}) = 20 \log(0.108 \text{ ms} / 0.225 \text{ ms}) = -6.4\text{dB}$

RF Mode	TX GFSK	Channel	CH 39 : 2441 MHz
Frequency Range	1 GHz ~ 25 GHz	Detector Function & Bandwidth	(PK) RB = 1 MHz, VB = 3 MHz (AV) RB = 1 MHz, VB = 3 MHz (RMS)

Antenna Polarity & Test Distance : Horizontal at 3 m

No	Frequency (MHz)	Emission Level (dBuV/m)	Limit (dBuV/m)	Margin (dB)	Antenna Height (m)	Table Angle (Degree)	Raw Value (dBuV)	Correction Factor (dB/m)
1	*2441.00	96.9 PK	114.0	-17.1	1.51 H	331	94.50	2.40
2	*2441.00	90.5 AV	94.0	-3.5	1.51 H	331	88.10	2.40
3	4882.00	52.1 PK	74.0	-21.9	1.64 H	304	39.40	12.70
4	4882.00	45.7 AV	54.0	-8.3	1.64 H	304	33.00	12.70

Antenna Polarity & Test Distance : Vertical at 3 m

No	Frequency (MHz)	Emission Level (dBuV/m)	Limit (dBuV/m)	Margin (dB)	Antenna Height (m)	Table Angle (Degree)	Raw Value (dBuV)	Correction Factor (dB/m)
1	*2441.00	91.6 PK	114.0	-22.4	3.54 V	71	89.20	2.40
2	*2441.00	85.2 AV	94.0	-8.8	3.54 V	71	82.80	2.40
3	4882.00	50.7 PK	74.0	-23.3	3.32 V	103	38.00	12.70
4	4882.00	44.3 AV	54.0	-9.7	3.32 V	103	31.60	12.70

Remarks:

1. Emission Level(dBuV/m) = Raw Value(dBuV) + Correction Factor(dB/m)
2. Correction Factor(dB/m) = Antenna Factor(dB/m) + Cable Factor(dB) – Pre-Amplifier Factor(dB)
3. Margin value = Emission Level – Limit value
4. The other emission levels were very low against the limit.
5. " * " : Fundamental frequency.
6. The average value of fundamental and harmonic frequency is: Average value = Peak value + 20 log(Duty cycle) Where the duty cycle correction factor is calculated from following formula:
 $20 \log(\text{Duty cycle}) = 20 \log(0.108 \text{ ms} / 0.225 \text{ ms}) = -6.4\text{dB}$

RF Mode	TX GFSK	Channel	CH 78 : 2480 MHz
Frequency Range	1 GHz ~ 25 GHz	Detector Function & Bandwidth	(PK) RB = 1 MHz, VB = 3 MHz (AV) RB = 1 MHz, VB = 3 MHz (RMS)
Tested By	Jed Wu		

Antenna Polarity & Test Distance : Horizontal at 3 m

No	Frequency (MHz)	Emission Level (dBuV/m)	Limit (dBuV/m)	Margin (dB)	Antenna Height (m)	Table Angle (Degree)	Raw Value (dBuV)	Correction Factor (dB/m)
1	*2480.00	95.6 PK	114.00	-18.4	2.70 H	345	93.10	2.50
2	*2480.00	89.2 AV	94.00	-4.8	2.70 H	345	86.70	2.50
3	2483.50	52.0 PK	74.00	-22.0	2.70 H	345	49.50	2.50
4	2483.50	45.6 AV	54.00	-8.4	2.70 H	345	43.10	2.50
5	4960.00	53.7 PK	74.00	-20.3	2.83 H	318	41.00	12.70
6	4960.00	47.3 AV	54.00	-6.7	2.83 H	318	34.60	12.70

Antenna Polarity & Test Distance : Vertical at 3 m

No	Frequency (MHz)	Emission Level (dBuV/m)	Limit (dBuV/m)	Margin (dB)	Antenna Height (m)	Table Angle (Degree)	Raw Value (dBuV)	Correction Factor (dB/m)
1	*2480.00	90.2 PK	114.0	-23.8	1.39 V	85	87.70	2.50
2	*2480.00	83.8 AV	94.0	-10.2	1.39 V	85	81.30	2.50
3	2483.50	48.0 PK	74.0	-26.0	1.39 V	85	45.50	2.50
4	2483.50	41.6 AV	54.0	-12.4	1.39 V	85	39.10	2.50
5	4960.00	52.3 PK	74.0	-21.7	1.17 V	99	39.60	12.70
6	4960.00	45.9 AV	54.0	-8.1	1.17 V	99	33.20	12.70

Remarks:

1. Emission Level(dBuV/m) = Raw Value(dBuV) + Correction Factor(dB/m)
2. Correction Factor(dB/m) = Antenna Factor(dB/m) + Cable Factor(dB) – Pre-Amplifier Factor(dB)
3. Margin value = Emission Level – Limit value
4. The other emission levels were very low against the limit.
5. " * " : Fundamental frequency.
6. The average value of fundamental and harmonic frequency is: Average value = Peak value + 20 log(Duty cycle) Where the duty cycle correction factor is calculated from following formula:
 $20 \log(\text{Duty cycle}) = 20 \log(0.108 \text{ ms} / 0.225 \text{ ms}) = -6.4\text{dB}$

BELOW 1GHz WORST-CASE DATA

Mode A

RF Mode	TX GFSK	Channel	CH 1 : 2403 MHz
Frequency Range	30 MHz ~ 1 GHz	Detector Function & Bandwidth	(QP) RB = 120kHz

Antenna Polarity & Test Distance : Horizontal at 3 m								
No	Frequency (MHz)	Emission Level (dBuV/m)	Limit (dBuV/m)	Margin (dB)	Antenna Height (m)	Table Angle (Degree)	Raw Value (dBuV)	Correction Factor (dB/m)
1	30.58	25.4 QP	40.0	-14.6	1.23 H	219	35.90	-10.50
2	161.10	19.4 QP	43.5	-24.1	1.56 H	99	27.40	-8.00
3	253.10	19.3 QP	46.0	-26.7	1.89 H	327	27.10	-7.80
4	311.06	22.3 QP	46.0	-23.7	1.34 H	209	27.70	-5.40
5	384.20	25.0 QP	46.0	-21.0	1.67 H	260	28.80	-3.80
6	442.44	27.6 QP	46.0	-18.4	1.98 H	38	29.80	-2.20

Remarks:

1. Emission Level(dBuV/m) = Raw Value(dBuV) + Correction Factor(dB/m)
2. Correction Factor(dB/m) = Antenna Factor(dB/m) + Cable Factor(dB) – Pre-Amplifier Factor(dB)
3. Margin value = Emission Level – Limit value
4. The other emission levels were very low against the limit of frequency range 30 MHz ~ 1 GHz.
5. The emission levels were very low against the limit of frequency range 9 kHz ~ 30 MHz: the amplitude of spurious emissions attenuated more than 20 dB below the permissible value to be report.

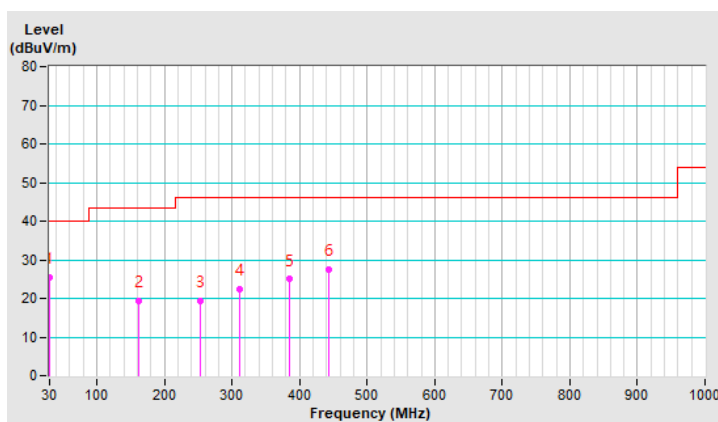

RF Mode	TX GFSK	Channel	CH 1 : 2403 MHz
Frequency Range	30 MHz ~ 1 GHz	Detector Function & Bandwidth	(QP) RB = 120kHz

Antenna Polarity & Test Distance : Vertical at 3 m								
No	Frequency (MHz)	Emission Level (dBuV/m)	Limit (dBuV/m)	Margin (dB)	Antenna Height (m)	Table Angle (Degree)	Raw Value (dBuV)	Correction Factor (dB/m)
1	50.42	28.7 QP	40.0	-11.3	1.69 V	270	36.90	-8.20
2	164.01	20.2 QP	43.5	-23.3	1.36 V	223	28.30	-8.10
3	271.14	20.6 QP	46.0	-25.4	1.25 V	116	27.30	-6.70
4	319.35	21.7 QP	46.0	-24.3	1.58 V	39	27.00	-5.30
5	371.63	23.5 QP	46.0	-22.5	1.47 V	273	27.60	-4.10
6	429.88	25.2 QP	46.0	-20.8	1.14 V	302	27.70	-2.50

Remarks:

1. Emission Level(dBuV/m) = Raw Value(dBuV) + Correction Factor(dB/m)
2. Correction Factor(dB/m) = Antenna Factor(dB/m) + Cable Factor(dB) – Pre-Amplifier Factor(dB)
3. Margin value = Emission Level – Limit value
4. The other emission levels were very low against the limit of frequency range 30 MHz ~ 1 GHz.
5. The emission levels were very low against the limit of frequency range 9 kHz ~ 30 MHz: the amplitude of spurious emissions attenuated more than 20 dB below the permissible value to be report.

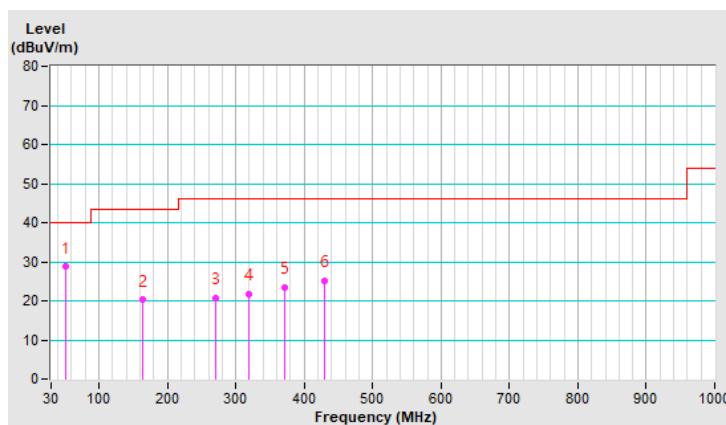

Mode B

Frequency Range	30 MHz ~ 1 GHz	Detector Function & Bandwidth	(QP) RB = 120kHz
------------------------	----------------	------------------------------------------	------------------

Antenna Polarity & Test Distance : Horizontal at 3 m								
No	Frequency (MHz)	Emission Level (dBuV/m)	Limit (dBuV/m)	Margin (dB)	Antenna Height (m)	Table Angle (Degree)	Raw Value (dBuV)	Correction Factor (dB/m)
1	35.50	23.6 QP	40.0	-16.4	1.26 H	158	33.50	-9.90
2	156.10	23.3 QP	43.5	-20.2	1.36 H	77	31.20	-7.90
3	250.60	23.8 QP	46.0	-22.2	1.59 H	244	31.80	-8.00
4	341.90	30.7 QP	46.0	-15.3	1.76 H	237	35.60	-4.90
5	429.60	35.9 QP	46.0	-10.1	1.42 H	68	38.40	-2.50
6	509.40	29.9 QP	46.0	-16.1	1.55 H	203	30.90	-1.00

Remarks:

1. Emission Level(dBuV/m) = Raw Value(dBuV) + Correction Factor(dB/m)
2. Correction Factor(dB/m) = Antenna Factor(dB/m) + Cable Factor(dB) – Pre-Amplifier Factor(dB)
3. Margin value = Emission Level – Limit value
4. The other emission levels were very low against the limit of frequency range 30 MHz ~ 1 GHz.
5. The emission levels were very low against the limit of frequency range 9 kHz ~ 30 MHz: the amplitude of spurious emissions attenuated more than 20 dB below the permissible value to be report.

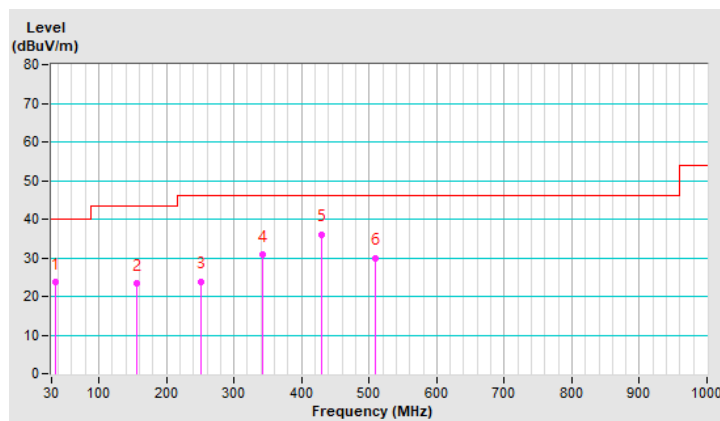

Frequency Range	30 MHz ~ 1 GHz	Detector Function & Bandwidth	(QP) RB = 120kHz
------------------------	----------------	------------------------------------------	------------------

Antenna Polarity & Test Distance : Vertical at 3 m

No	Frequency (MHz)	Emission Level (dBuV/m)	Limit (dBuV/m)	Margin (dB)	Antenna Height (m)	Table Angle (Degree)	Raw Value (dBuV)	Correction Factor (dB/m)
1	50.40	31.7 QP	40.0	-8.3	1.72 V	291	39.90	-8.20
2	161.30	24.2 QP	43.5	-19.3	1.83 V	60	32.20	-8.00
3	249.40	23.3 QP	46.0	-22.7	1.91 V	84	31.30	-8.00
4	336.70	26.4 QP	46.0	-19.6	1.42 V	351	31.30	-4.90
5	418.40	27.9 QP	46.0	-18.1	1.58 V	208	31.00	-3.10
6	479.10	29.1 QP	46.0	-16.9	1.60 V	40	30.80	-1.70

Remarks:

1. Emission Level(dBuV/m) = Raw Value(dBuV) + Correction Factor(dB/m)
2. Correction Factor(dB/m) = Antenna Factor(dB/m) + Cable Factor(dB) – Pre-Amplifier Factor(dB)
3. Margin value = Emission Level – Limit value
4. The other emission levels were very low against the limit of frequency range 30 MHz ~ 1 GHz.
5. The emission levels were very low against the limit of frequency range 9 kHz ~ 30 MHz: the amplitude of spurious emissions attenuated more than 20 dB below the permissible value to be report.

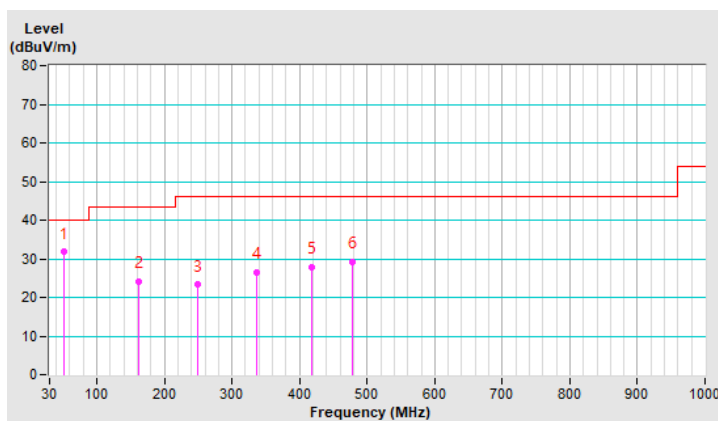

4.2 Conducted Emission Measurement

4.2.1 Limits of Conducted Emission Measurement

Frequency (MHz)	Conducted Limit (dBuV)	
	Quasi-peak	Average
0.15 - 0.5	66 - 56	56 - 46
0.50 - 5.0	56	46
5.0 - 30.0	60	50

Note: 1. The lower limit shall apply at the transition frequencies.

2. The limit decreases in line with the logarithm of the frequency in the range of 0.15 to 0.50MHz.

4.2.2 Test Instruments

Description Manufacturer	Model No.	Serial No.	Calibrated Date	Calibrated Until
50 ohm terminal LYNICS	0900510	E1-011285	2022/9/19	2023/9/18
		E1-011286	2022/9/19	2023/9/18
Attenuator STI	STI02-2200-10	NO.4	2022/9/2	2023/9/1
DC LISN R&S	ESH3-Z6	100219	2022/8/2	2023/8/1
		844950/018	2022/8/2	2023/8/1
DC LISN Schwarzbeck	NNLK 8121	8121-808	2022/4/29	2023/4/28
High Voltage Probe Schwarzbeck	TK9420	00982	2022/12/14	2023/12/13
Isolation Transformer Erika Fiedler	D-65396	017	2022/9/8	2023/9/7
LISN R&S	ENV216	101196	2022/5/24	2023/5/23
LISN Schwarzbeck	NNLK 8121	8121-731	2022/5/26	2023/5/25
		8121-00759	2022/8/18	2023/8/17
	NNLK8129	8129229	2022/6/8	2023/6/7
	NSLK 8128	8128-244	2022/11/8	2023/11/7
RF Coaxial Cable Commate	5D-FB	Cable-CO5-01	2023/1/19	2024/1/18
Software BVADT	Cond_V7.3.7.4	N/A	N/A	N/A
Test Receiver R&S	ESR3	102412	2022/12/21	2023/12/20

Notes:

1. The calibration interval of the above test instruments is 12 months and the calibrations are traceable to NML/ROC and NIST/USA.
2. The test was performed in Linkou Conduction 5.
3. Tested Date: 2023/2/11

4.2.3 Test Procedures

- The EUT was placed 0.4 meters from the conducting wall of the shielded room with EUT being connected to the power mains through a line impedance stabilization network (LISN). Other support units were connected to the power mains through another LISN. The two LISNs provide 50 ohm/ 50uH of coupling impedance for the measuring instrument.
- Both lines of the power mains connected to the EUT were checked for maximum conducted interference.
- The frequency range from 150kHz to 30MHz was searched. Emission levels under (Limit - 20dB) was not recorded.

NOTE: The resolution bandwidth and video bandwidth of test receiver is 9kHz for quasi-peak detection (QP) and average detection (AV) at frequency 0.15MHz-30MHz.

4.2.4 Deviation From Test Standard

No deviation.

4.2.5 Test Setup

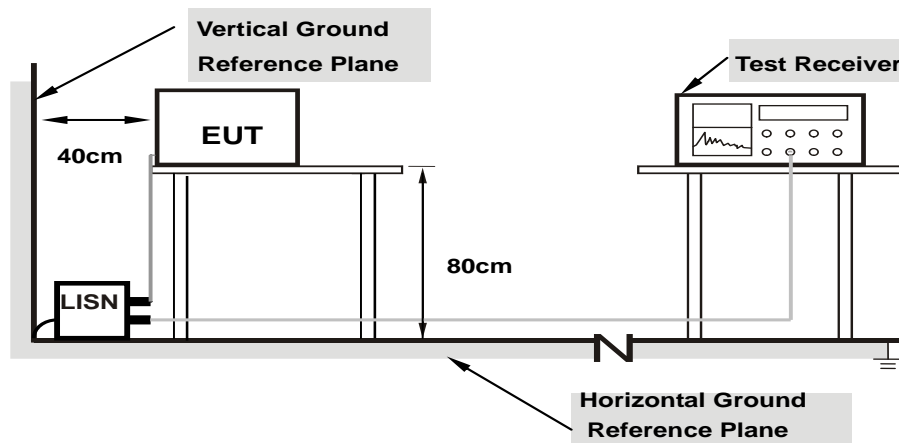

Note: 1.Support units were connected to second LISN.

For the actual test configuration, please refer to the attached file (Test Setup Photo).

4.2.6 EUT Operating Condition

Mode B

- a. Connected the EUT to Laptop via USB cable.
- b. Set the EUT under charging condition.

Mode C

- a. Connected the EUT to Adapter via USB cable.
- b. Set the EUT under charging condition.

4.2.7 Test Results

Mode B

Frequency Range	150 kHz ~ 30 MHz	Detector Function & Resolution Bandwidth	Quasi-Peak (QP) / Average (AV), 9kHz
------------------------	------------------	-----------------------------------------------------	--------------------------------------

Phase Of Power : Line (L)										
No	Frequency (MHz)	Correction Factor (dB)	Reading Value (dBuV)		Emission Level (dBuV)		Limit (dBuV)		Margin (dB)	
			Q.P.	AV.	Q.P.	AV.	Q.P.	AV.	Q.P.	AV.
1	0.16562	10.06	36.55	17.71	46.61	27.77	65.18	55.18	-18.57	-27.41
2	0.46250	10.23	21.17	16.51	31.40	26.74	56.65	46.65	-25.25	-19.91
3	0.76328	10.30	24.63	17.30	34.93	27.60	56.00	46.00	-21.07	-18.40
4	3.86719	10.49	25.65	16.11	36.14	26.60	56.00	46.00	-19.86	-19.40
5	6.16016	10.56	23.17	16.60	33.73	27.16	60.00	50.00	-26.27	-22.84
6	8.37109	10.62	29.53	23.37	40.15	33.99	60.00	50.00	-19.85	-16.01

Remarks:

1. Q.P. and AV. are abbreviations of quasi-peak and average individually.
2. The emission levels of other frequencies were very low against the limit.
3. Margin value = Emission level – Limit value
4. Correction factor = Insertion loss + Cable loss
5. Emission Level = Correction Factor + Reading Value

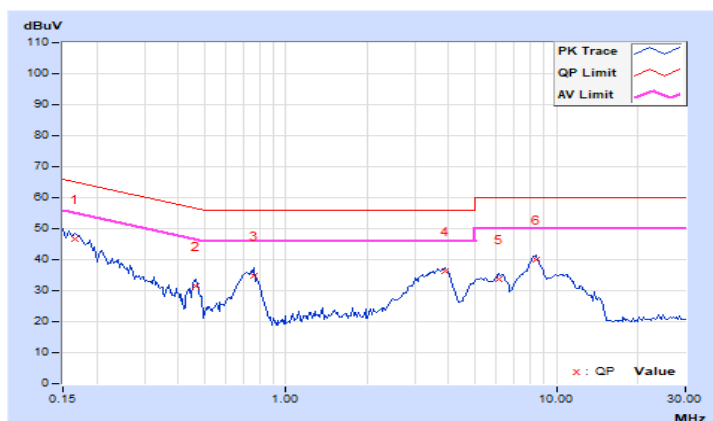

Frequency Range	150 kHz ~ 30 MHz	Detector Function & Resolution Bandwidth	Quasi-Peak (QP) / Average (AV), 9kHz
------------------------	------------------	-----------------------------------------------------	--------------------------------------

Phase Of Power : Neutral (N)										
No	Frequency (MHz)	Correction Factor (dB)	Reading Value (dBuV)		Emission Level (dBuV)		Limit (dBuV)		Margin (dB)	
			Q.P.	AV.	Q.P.	AV.	Q.P.	AV.	Q.P.	AV.
1	0.16562	10.10	35.61	17.92	45.71	28.02	65.18	55.18	-19.47	-27.16
2	0.46250	10.20	20.44	17.82	30.64	28.02	56.65	46.65	-26.01	-18.63
3	0.71250	10.23	23.13	16.64	33.36	26.87	56.00	46.00	-22.64	-19.13
4	3.69141	10.41	23.83	17.07	34.24	27.48	56.00	46.00	-21.76	-18.52
5	6.19141	10.51	22.23	15.70	32.74	26.21	60.00	50.00	-27.26	-23.79
6	8.35547	10.60	27.17	20.48	37.77	31.08	60.00	50.00	-22.23	-18.92

Remarks:

1. Q.P. and AV. are abbreviations of quasi-peak and average individually.
2. The emission levels of other frequencies were very low against the limit.
3. Margin value = Emission level – Limit value
4. Correction factor = Insertion loss + Cable loss
5. Emission Level = Correction Factor + Reading Value

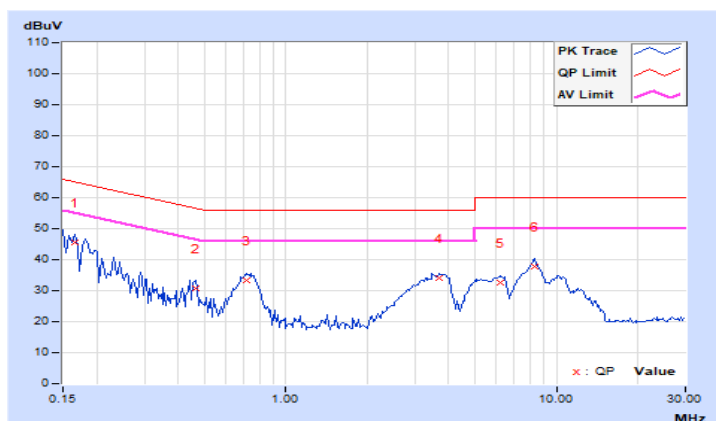

Mode C

Frequency Range	150 kHz ~ 30 MHz	Detector Function & Resolution Bandwidth	Quasi-Peak (QP) / Average (AV), 9kHz
------------------------	------------------	-----------------------------------------------------	--------------------------------------

Phase Of Power : Line (L)										
No	Frequency (MHz)	Correction Factor (dB)	Reading Value (dBuV)		Emission Level (dBuV)		Limit (dBuV)		Margin (dB)	
			Q.P.	AV.	Q.P.	AV.	Q.P.	AV.	Q.P.	AV.
1	0.15781	10.05	23.68	1.77	33.73	11.82	65.58	55.58	-31.85	-43.76
2	0.42344	10.22	15.73	1.19	25.95	11.41	57.38	47.38	-31.43	-35.97
3	0.70078	10.29	19.24	12.06	29.53	22.35	56.00	46.00	-26.47	-23.65
4	4.25781	10.51	13.34	3.16	23.85	13.67	56.00	46.00	-32.15	-32.33
5	7.47266	10.59	15.37	5.10	25.96	15.69	60.00	50.00	-34.04	-34.31
6	12.45703	10.72	13.01	2.69	23.73	13.41	60.00	50.00	-36.27	-36.59

Remarks:

1. Q.P. and AV. are abbreviations of quasi-peak and average individually.
2. The emission levels of other frequencies were very low against the limit.
3. Margin value = Emission level – Limit value
4. Correction factor = Insertion loss + Cable loss
5. Emission Level = Correction Factor + Reading Value

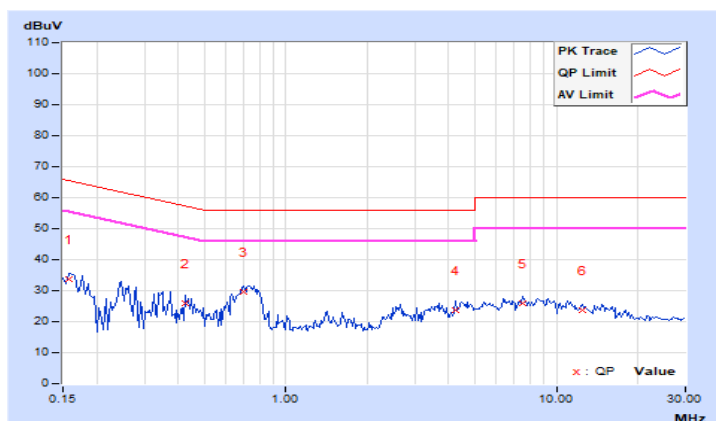

Frequency Range	150 kHz ~ 30 MHz	Detector Function & Resolution Bandwidth	Quasi-Peak (QP) / Average (AV), 9kHz
------------------------	------------------	-----------------------------------------------------	--------------------------------------

Phase Of Power : Neutral (N)										
No	Frequency (MHz)	Correction Factor (dB)	Reading Value (dBuV)		Emission Level (dBuV)		Limit (dBuV)		Margin (dB)	
			Q.P.	AV.	Q.P.	AV.	Q.P.	AV.	Q.P.	AV.
1	0.15391	10.07	25.52	2.84	35.59	12.91	65.79	55.79	-30.20	-42.88
2	0.44688	10.20	17.91	2.63	28.11	12.83	56.93	46.93	-28.82	-34.10
3	0.79844	10.24	22.41	15.59	32.65	25.83	56.00	46.00	-23.35	-20.17
4	3.69141	10.41	14.38	3.56	24.79	13.97	56.00	46.00	-31.21	-32.03
5	5.64063	10.49	14.11	2.87	24.60	13.36	60.00	50.00	-35.40	-36.64
6	9.57031	10.64	13.67	2.93	24.31	13.57	60.00	50.00	-35.69	-36.43

Remarks:

1. Q.P. and AV. are abbreviations of quasi-peak and average individually.
2. The emission levels of other frequencies were very low against the limit.
3. Margin value = Emission level – Limit value
4. Correction factor = Insertion loss + Cable loss
5. Emission Level = Correction Factor + Reading Value

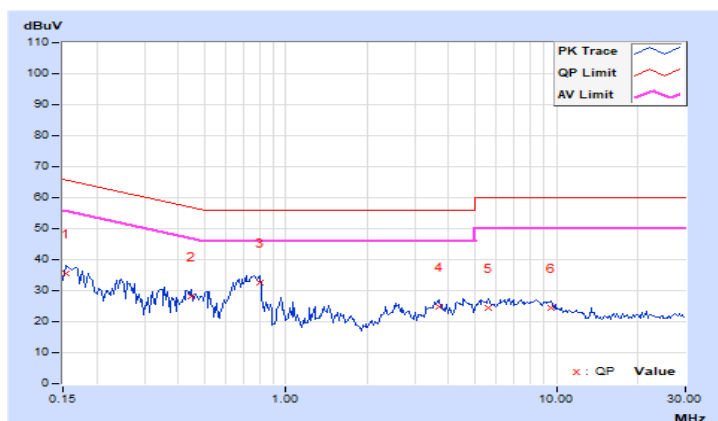

4.3 Channel Bandwidth

4.3.1 Test Setup

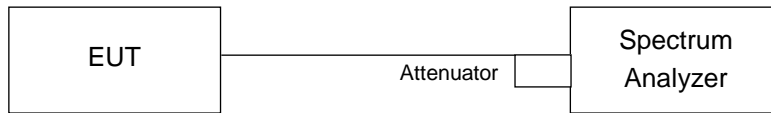

4.3.2 Test Instruments

Description & Manufacturer	Model no.	Serial No.	Calibrated Date	Calibrated Until
Spectrum Analyzer R&S	FSV40	101544	2022/5/9	2023/5/8

- NOTE:** 1. The calibration interval of the above test instruments is 12 months. And the calibrations are traceable to NML/ROC and NIST/USA.
 2. The test was performed in LK - Oven
 3. Tested Date: 2023/1/31

4.3.3 Test Procedure

- Check the calibration of the measuring instrument using either an internal calibrator or a known signal from an external generator.
- Turn on the EUT and connect it to measurement instrument. Then set it to any one convenient frequency within its operating range. Set a reference level on the measuring instrument equal to the highest peak value.
- Measure the frequency difference of two frequencies that were attenuated 20dB from the reference level. Record the frequency difference as the emission bandwidth.
- Repeat above procedures until all frequencies measured were complete.

4.3.4 Deviation from Test Standard

No deviation.

4.3.5 EUT Operating Condition

The software provided by client enabled the EUT to transmit and receive data at lowest, middle and highest channel frequencies individually.

4.3.6 Test Results

Channel	Frequency (MHz)	20dB Bandwidth (MHz)
1	2403	1.93
39	2441	2.09
78	2480	2.04

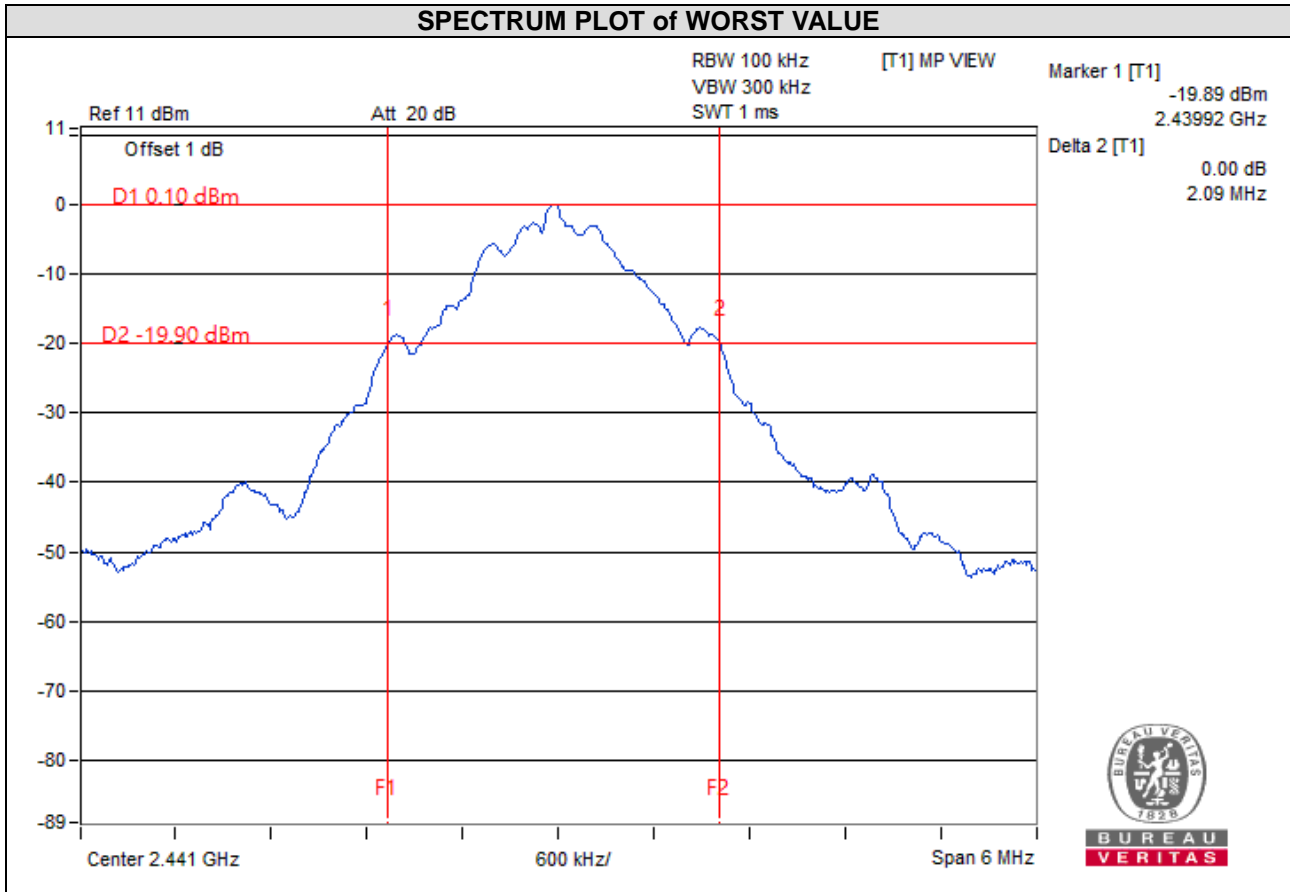

5 Pictures of Test Arrangements

Please refer to the attached file (Test Setup Photo).

Appendix – Information of the Testing Laboratories

We, Bureau Veritas Consumer Products Services (H.K.) Ltd., Taoyuan Branch, were founded in 1988 to provide our best service in EMC, Radio, Telecom and Safety consultation. Our laboratories are FCC recognized accredited test firms and accredited according to ISO/IEC 17025.

If you have any comments, please feel free to contact us at the following:

Lin Kou EMC/RF Lab

Tel: 886-2-26052180

Fax: 886-2-26051924

Hsin Chu EMC/RF/Telecom Lab

Tel: 886-3-6668565

Fax: 886-3-6668323

Hwa Ya EMC/RF/Safety Lab

Tel: 886-3-3183232

Fax: 886-3-3270892

Email: service.adt@tw.bureauveritas.com

Web Site: <http://ee.bureauveritas.com.tw>

The address and road map of all our labs can be found in our web site also.

--- END ---