

APPROVAL SHEET

RoHS
compliance

CUSTOMER : 光寶科技股份有限公司
ISSUE DATE : 2021.07.05

APPROVED

COMPANY	APPROVED BY	CHECK BY	PREPARED BY
	Herbert Chou	Mike Yang	Eva Chou
APPROVAL NO :	H2U34W1H1Z0600		
MODEL :	WiFi/Bluetooth Chip Antenna(321605-AA055C)		
Customer NO :	OCS P/N : 20301-000170A000 SJ P/N : 838-00309-00A		

3.2 x 1.6 x 0.5 (mm) WiFi/Bluetooth Ceramic Chip Antenna (AA055C) Engineering Specification

1. Product Number

H 2 U 3 4 W 1 H 1 Z 0 6 0 0



2. Features

- *Stable and reliable in performances
- *Low profile, compact size
- *RoHS 2.0 compliance
- *SMT processes compatible
- *AEC-Q200 compliant

3. Applications

- *ISM 2.4 GHz applications
- *ZigBee/BLE applications
- *Bluetooth earphone systems
- *Hand-held devices when WiFi / Bluetooth functions are needed, e.g., Smart phones
- *IEEE802.11 b/g/n
- *Wireless PCMCIA cards or USB dongles

4. Description

Unictron's AA055C ceramic chip antenna is designed for ISM 2.4GHz applications, covering frequencies 2400~2500MHz. Fabricated with proprietary design and processes, AA055C shows excellent performance and is fully compatible with SMT processes which can decrease the assembly cost and improve device's quality and consistency.



詠業科技股份有限公司
Unictron Technologies Corporation
Website: www.unictron.com

THIS DRAWINGS AND SPECIFICATIONS ARE THE PROPERTY OF UNICTRON TECHNOLOGIES CORPORATION AND SHALL NOT BE REPRODUCED OR USED AS THE BASIS FOR THE MANUFACTURE OR SALE OF APPARATUS OR DEVICES WITHOUT PERMISSION

Prepared by : Jane

Designed by : George Hung

Checked by : Mike

Approved by : Herbert

TITLE : 3.2 x 1.6 x 0.5(mm) WiFi/Bluetooth Ceramic Chip Antenna (AA055C) Engineering Specification

DOCUMENT NO.

H2U34W1H1Z0600

REV.
H

5. Layout Guide & Electrical Specifications

5-1. Layout Guide (unit : mm)

Solder Land Pattern:

The solder land pattern (gold marking areas) is shown below. Recommendation on matching circuit will be provided according to customer's installation conditions.

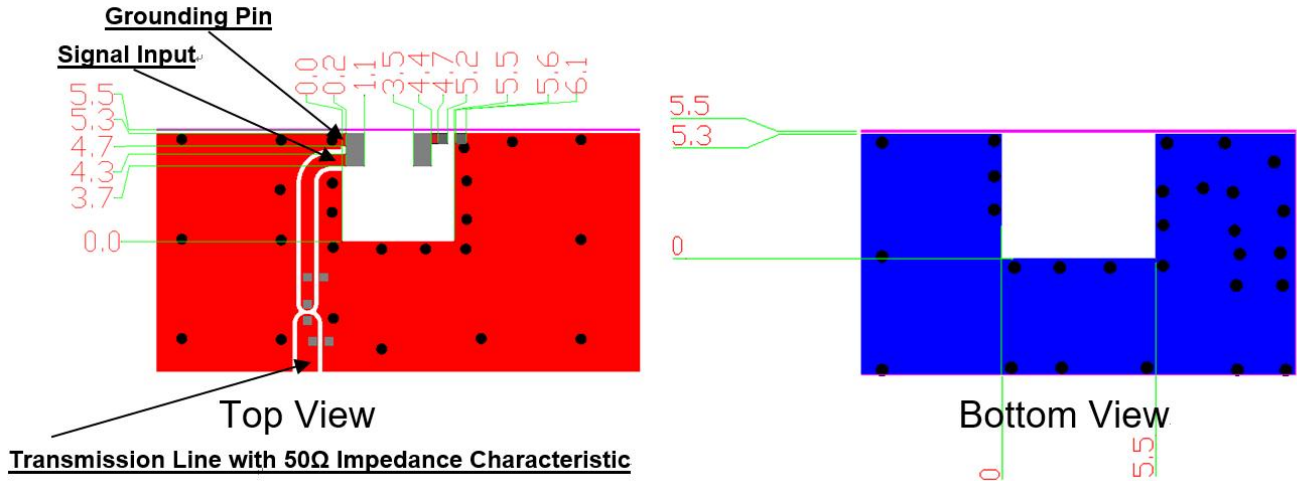

5-2. Electrical Specifications (Evaluation Board Dimensions: 80 x 40 mm²)

5-2-1. Electrical Table

Characteristics		Specifications	Unit
Outline Dimensions		3.2 x 1.6 x 0.5	mm
Ground Plane Dimensions		80 x 40	mm
Working Frequency		2400~2500	MHz
VSWR (@ center frequency)*		2 Max.	
Characteristic Impedance		50	Ω
Polarization		Linear Polarization	
Peak Gain	(@2442 MHz)	2.5 (typical**)	dBi
Efficiency		84 (typical**)	%

*Center frequency means the frequency with the lowest value in return loss of the chip antenna on the evaluation board.

**A typical value is for reference only, not guaranteed.



詠業科技股份有限公司
 Unictron Technologies Corporation
 Website: www.unictron.com

THIS DRAWINGS AND SPECIFICATIONS ARE THE PROPERTY OF UNICTRON TECHNOLOGIES CORPORATION AND SHALL NOT BE REPRODUCED OR USED AS THE BASIS FOR THE MANUFACTURE OR SALE OF APPARATUS OR DEVICES WITHOUT PERMISSION

Prepared by : Jane

Designed by : George Hung

Checked by : Mike

Approved by : Herbert

TITLE : 3.2 x 1.6 x 0.5(mm) WiFi/Bluetooth Ceramic Chip Antenna (AA055C) Engineering Specification

DOCUMENT NO.

H2U34W1H1Z0600

REV.

H

5-2-2. Return Loss & VSWR

Return Loss (S₁₁)

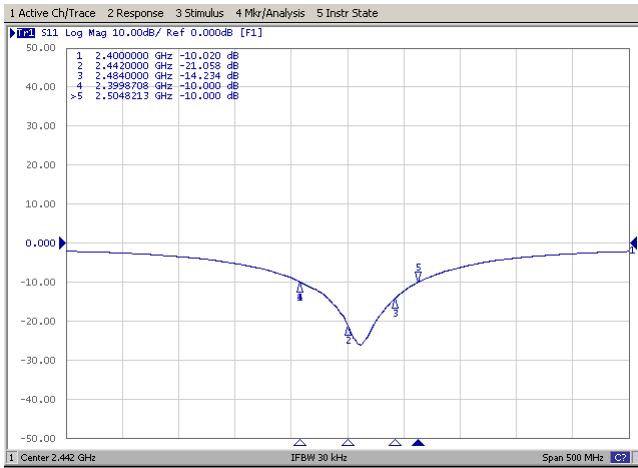

VSWR(S₁₁)

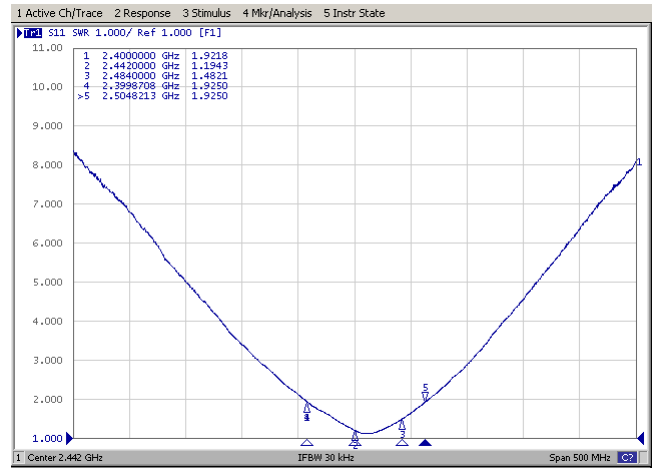

6. Outline Dimensions of Antenna & Evaluation Board (unit: mm)

6-1. Antenna Dimensions

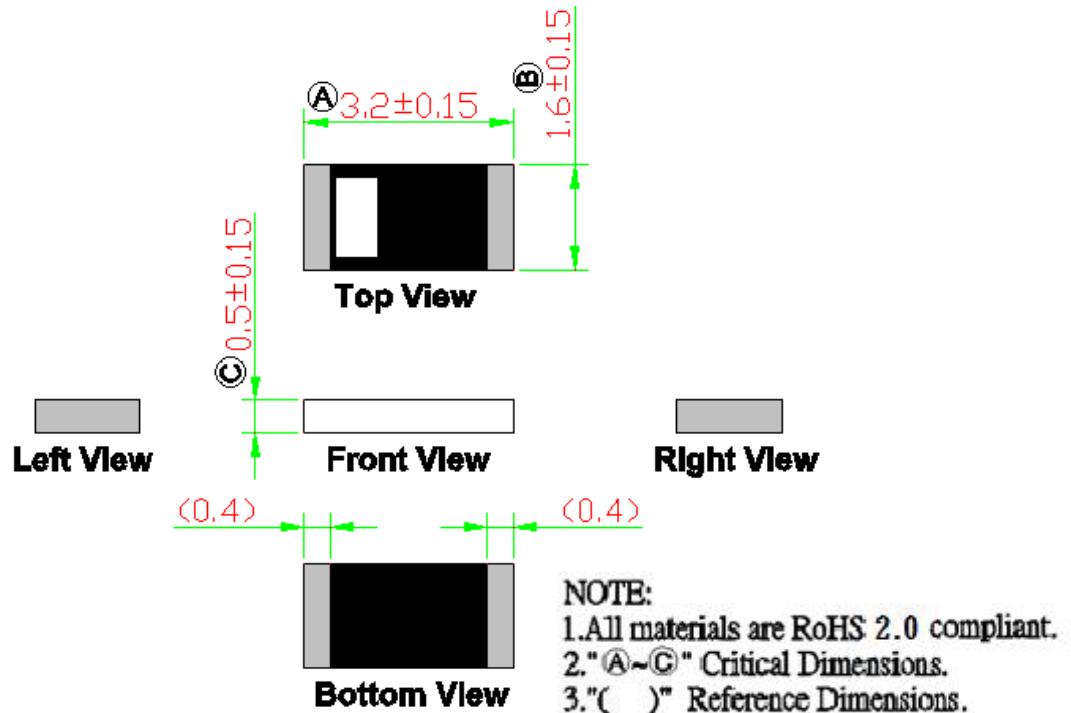

詠業科技股份有限公司
 Unictron Technologies Corporation
 Website: www.unictron.com

THIS DRAWINGS AND SPECIFICATIONS ARE THE PROPERTY OF UNICTRON TECHNOLOGIES CORPORATION AND SHALL NOT BE REPRODUCED OR USED AS THE BASIS FOR THE MANUFACTURE OR SALE OF APPARATUS OR DEVICES WITHOUT PERMISSION

Prepared by : Jane

Designed by : George Hung

Checked by : Mike

Approved by : Herbert

TITLE : 3.2 x 1.6 x 0.5(mm) WiFi/Bluetooth Ceramic Chip Antenna (AA055C) Engineering Specification

DOCUMENT NO.

H2U34W1H1Z0600

REV.
H

PIN Definitions



PIN	1	2
Soldering PAD	Signal	Tuning / Ground

6-2. Evaluation Board with Antenna

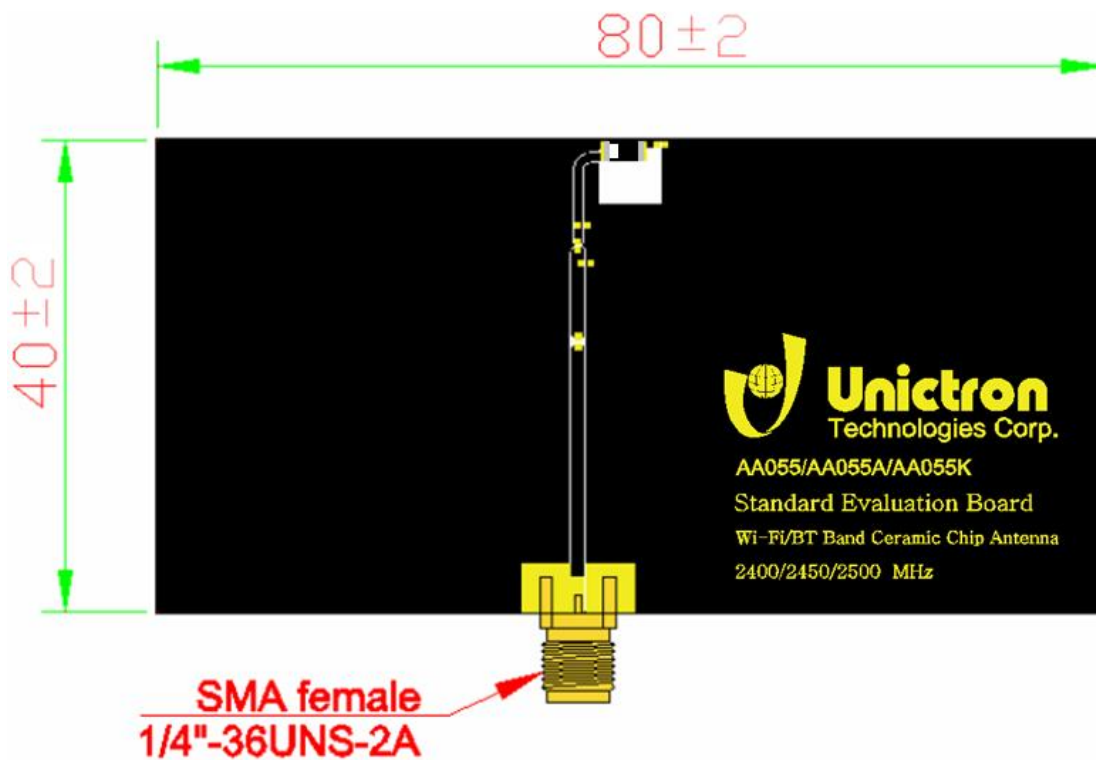

unit : mm
Unictron
Technologies Corp.
2021-07-05
Document
Control Center



詠業科技股份有限公司
Unictron Technologies Corporation
Website: www.unictron.com

THIS DRAWINGS AND SPECIFICATIONS ARE THE PROPERTY OF UNICTRON TECHNOLOGIES CORPORATION AND SHALL NOT BE REPRODUCED OR USED AS THE BASIS FOR THE MANUFACTURE OR SALE OF APPARATUS OR DEVICES WITHOUT PERMISSION

Prepared by : Jane

Designed by : George Hung

Checked by : Mike

Approved by : Herbert

TITLE : 3.2 x 1.6 x 0.5(mm) WiFi/Bluetooth Ceramic Chip Antenna (AA055C) Engineering Specification

DOCUMENT NO.

H2U34W1H1Z0600

REV.

H

7. 3D Radiation Gain Pattern (with 80 x 40 mm² Evaluation Board)

7-1. 3D Radiation Gain Pattern @ 2442 MHz (unit: dBi)

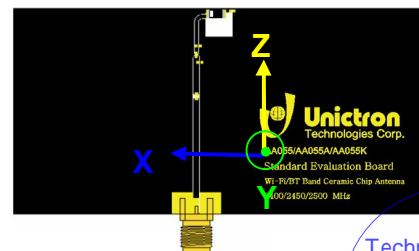
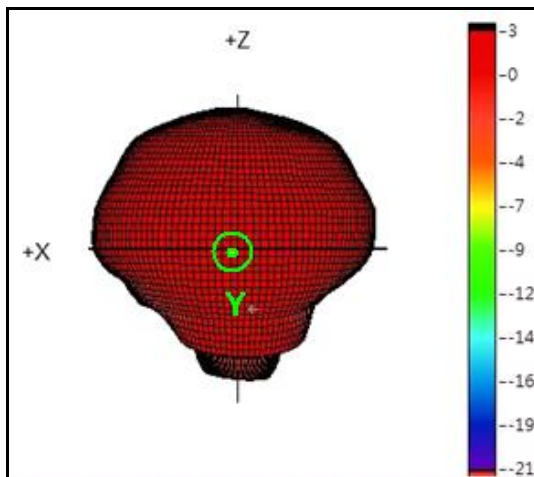
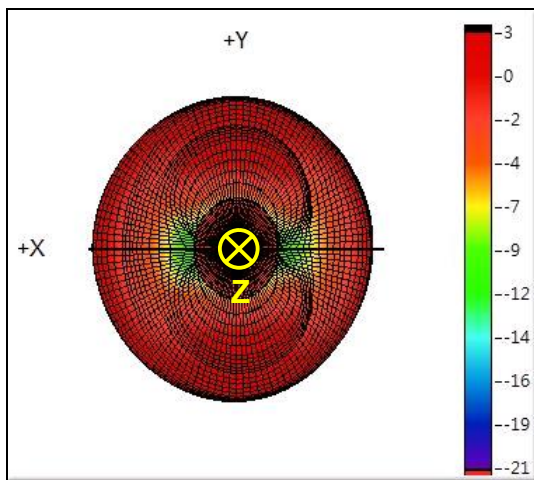
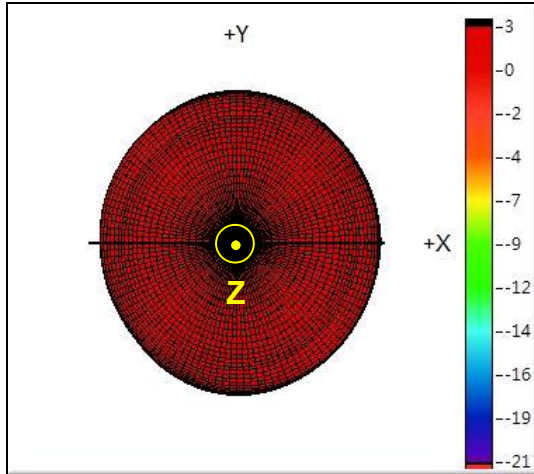

Unictron
Technologies Corp.
2021-07-05
Document
Control Center



詠業科技股份有限公司
Unictron Technologies Corporation
Website: www.unictron.com

THIS DRAWINGS AND SPECIFICATIONS ARE THE PROPERTY OF UNICTRON TECHNOLOGIES CORPORATION AND SHALL NOT BE REPRODUCED OR USED AS THE BASIS FOR THE MANUFACTURE OR SALE OF APPARATUS OR DEVICES WITHOUT PERMISSION

Prepared by : Jane

Designed by : George Hung

Checked by : Mike

Approved by : Herbert

TITLE : 3.2 x 1.6 x 0.5(mm) WiFi/Bluetooth Ceramic Chip Antenna (AA055C) Engineering Specification

DOCUMENT NO.

H2U34W1H1Z0600

REV.

H

7-2. 3D Efficiency Table

Frequency(MHz)	2400	2412	2417	2422	2427	2432	2437	2442	2447	2452	2457	2462	2467	2472	2484	2500
Efficiency(dB)	-1.4	-1.0	-0.9	-0.8	-0.8	-0.8	-0.7	-0.7	-0.8	-0.8	-0.8	-0.9	-0.9	-1.0	-1.2	-1.4
Efficiency(%)	72.8	78.7	80.4	82.3	83.0	83.9	84.4	84.5	84.1	84.0	83.2	82.0	80.5	78.6	75.4	72.5
Peak Gain(dBi)	1.5	1.8	1.9	2.1	2.3	2.3	2.4	2.5	2.5	2.5	2.4	2.4	2.2	2.1	1.9	1.8

7-3. 3D Efficiency vs. Frequency

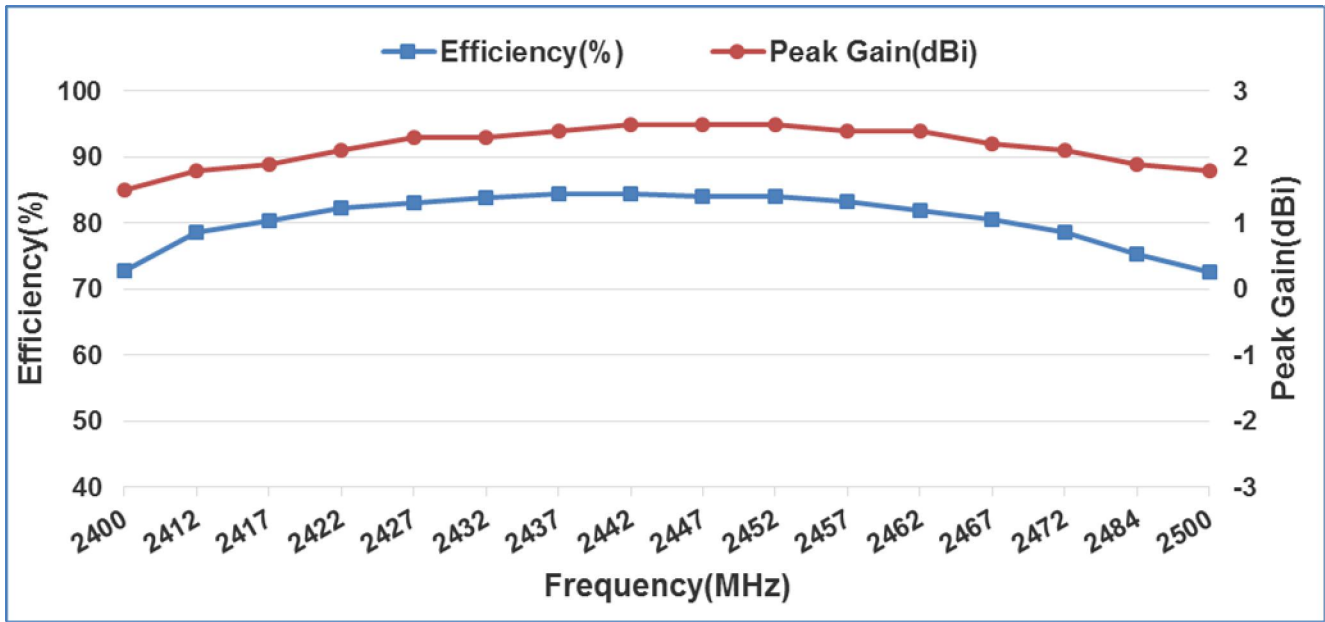

Unictron
Technologies Corp.
2021-07-05
Document
Control Center



詠業科技股份有限公司
Unictron Technologies Corporation
Website: www.unictron.com

THIS DRAWINGS AND SPECIFICATIONS ARE THE PROPERTY OF UNICTRON TECHNOLOGIES CORPORATION AND SHALL NOT BE REPRODUCED OR USED AS THE BASIS FOR THE MANUFACTURE OR SALE OF APPARATUS OR DEVICES WITHOUT PERMISSION

Prepared by : **Jane**

Designed by : **George Hung**

Checked by : **Mike**

Approved by : **Herbert**

TITLE : 3.2 x 1.6 x 0.5(mm) WiFi/Bluetooth Ceramic Chip Antenna (AA055C) Engineering Specification

DOCUMENT NO.

H2U34W1H1Z0600

REV. H

8. Frequency tuning and Matching circuit

8-1. Chip antenna tuning scenario :

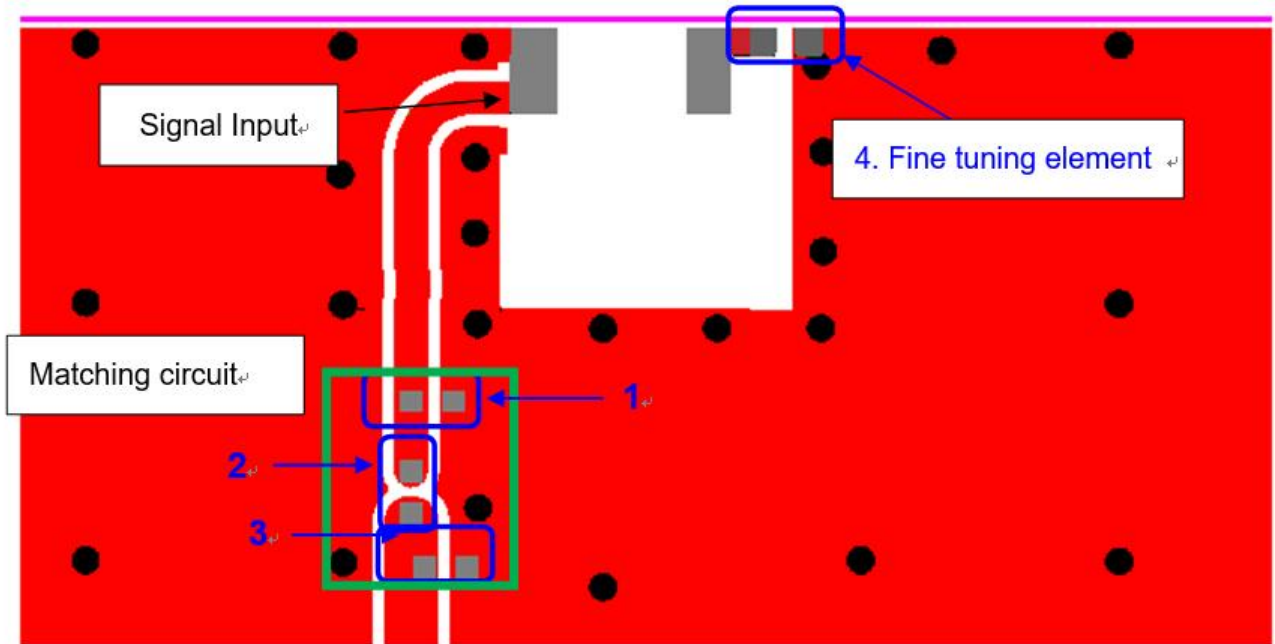

8-2. Matching circuit :

With the following recommended values of matching and tuning components, the center frequencies will be about 2442 MHz at our standard 80x40 mm² evaluation board. However, these are typical reference values which may need to be changed when circuit boards or part vendors are different.

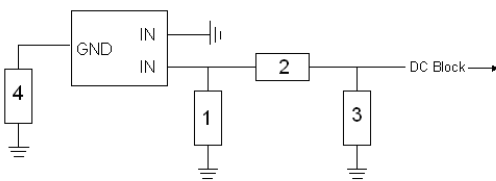

System Matching Circuit Component			
Location	Description	Vendor	Tolerance
1	1.2pF, (0402)	DARFON	±0.1 pF
2	3.3nH, (0402)	DARFON	±0.1 nH
3	N/A	-	-
4	Fine tuning element	DARFON	±0.1 pF



詠業科技股份有限公司
Unictron Technologies Corporation
Website: www.unictron.com

THIS DRAWINGS AND SPECIFICATIONS ARE THE PROPERTY OF UNICTRON TECHNOLOGIES CORPORATION AND SHALL NOT BE REPRODUCED OR USED AS THE BASIS FOR THE MANUFACTURE OR SALE OF APPARATUS OR DEVICES WITHOUT PERMISSION

Prepared by : Jane

Designed by : George Hung

Checked by : Mike

Approved by : Herbert

TITLE : 3.2 x 1.6 x 0.5(mm) WiFi/Bluetooth Ceramic Chip Antenna (AA055C) Engineering Specification

DOCUMENT NO.

H2U34W1H1Z0600

REV.
H

8-3. Reference for frequency tuning element

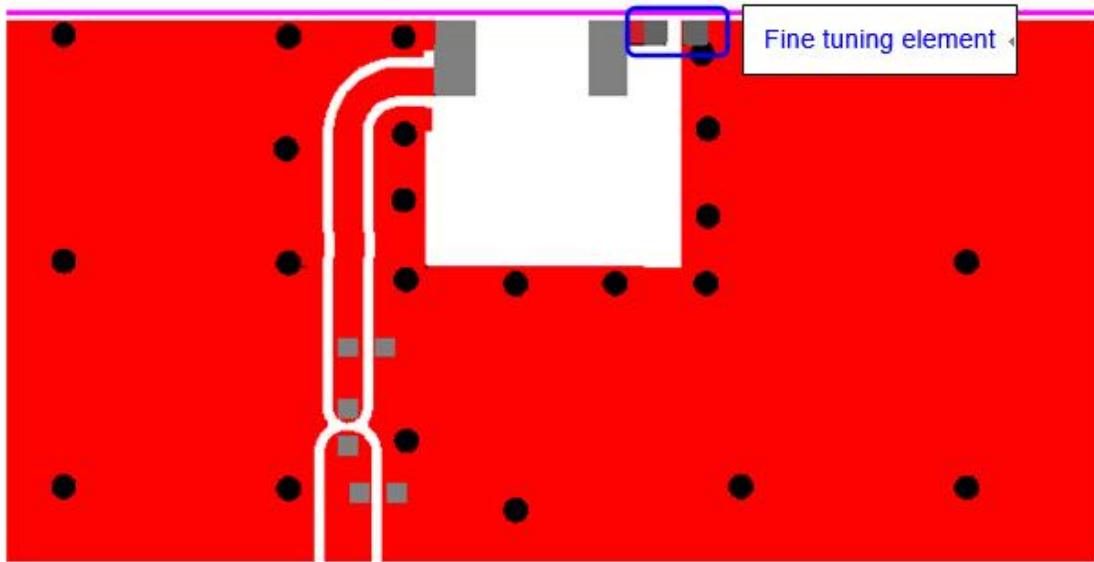

Frequencies vs. capacitance of tuning element

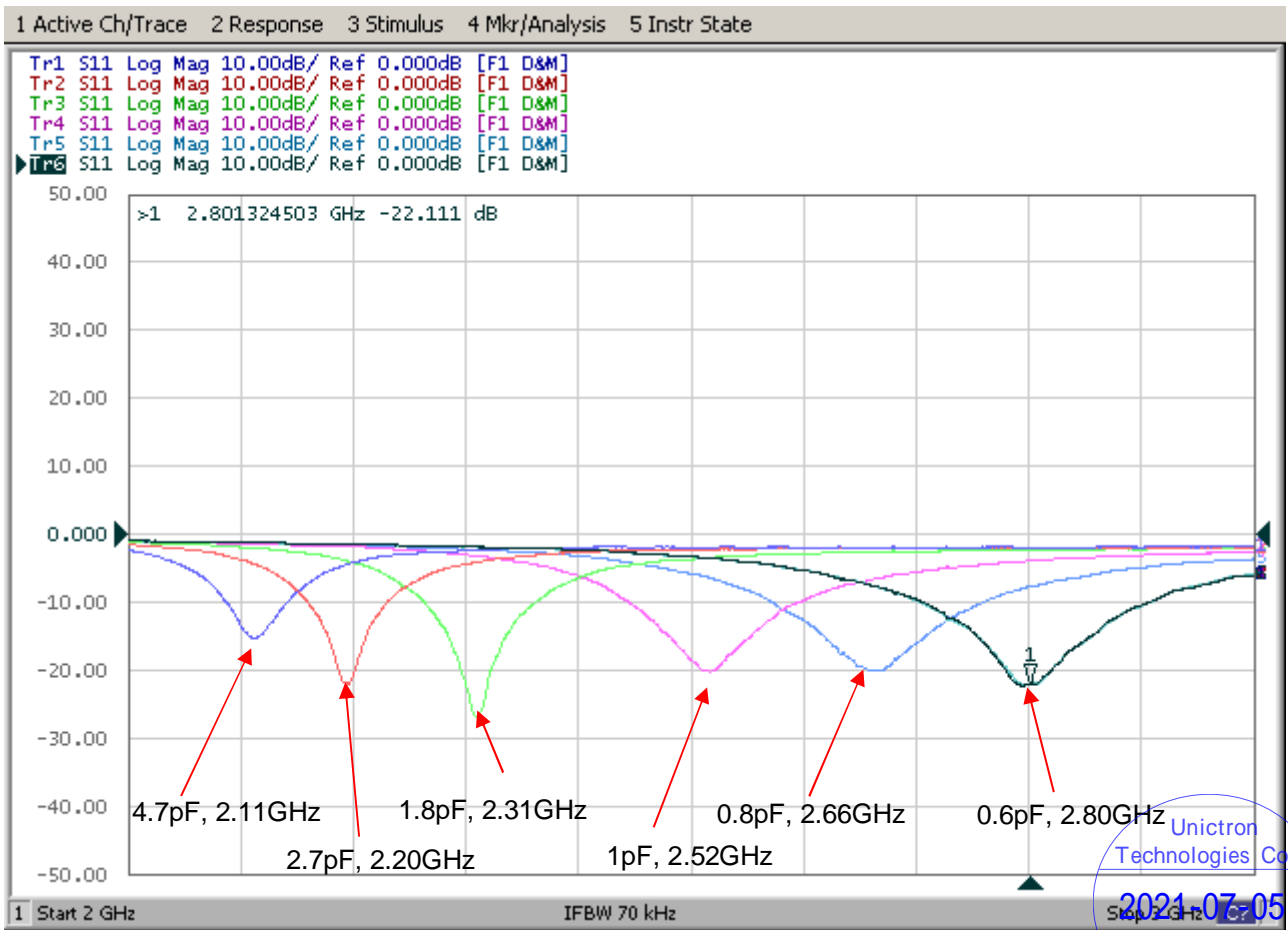

Unictron Technologies Corp.
2021-07-05
Document Control Center



詠業科技股份有限公司
Unictron Technologies Corporation
Website: www.unictron.com

THIS DRAWINGS AND SPECIFICATIONS ARE THE PROPERTY OF UNICTRON TECHNOLOGIES CORPORATION AND SHALL NOT BE REPRODUCED OR USED AS THE BASIS FOR THE MANUFACTURE OR SALE OF APPARATUS OR DEVICES WITHOUT PERMISSION

Prepared by : Jane Designed by : George Hung Checked by : Mike Approved by : Herbert

TITLE : 3.2 x 1.6 x 0.5(mm) WiFi/Bluetooth Ceramic Chip Antenna (AA055C) Engineering Specification	DOCUMENT NO.	H2U34W1H1Z0600	REV.
			H

9. Soldering Conditions

Typical Soldering Profile for Lead-free Process

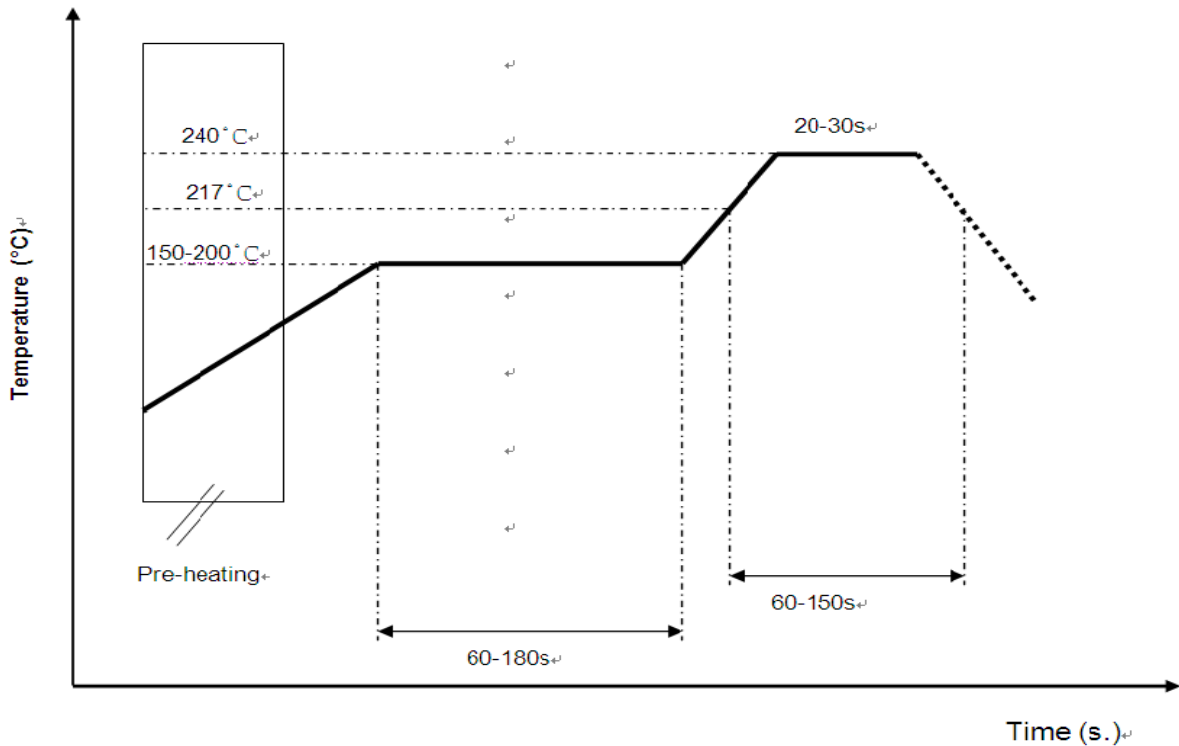

*Recommended solder paste alloy: SAC305 (Sn96.5 /Ag3 /Cu0.5) Lead Free solder paste.

10. Reminders for users of Unictron's AA055C ceramic chip antennas

- 10-1. This chip antenna is made of ceramic materials which are relatively more rigid and brittle compared to printed circuit board materials. Bending of circuit board at the locations where chip antenna is mounted may cause the cracking of solder joints or antenna itself.
- 10-2. Punching/cutting of the break-off tab of PCB panel may cause severe bending of the circuit board which may result in cracking of solder joints or chip antenna itself. Therefore break-off tab shall be located away from the installation site of chip antenna.
- 10-3. Be cautious when ultrasonic welding process needs to be used near the locations where chip antennas are installed. Strong ultrasonic vibration may cause the cracking of chip antenna solder joints.



詠業科技股份有限公司
Unictron Technologies Corporation
Website: www.unictron.com

THIS DRAWINGS AND SPECIFICATIONS ARE THE PROPERTY OF UNICTRON TECHNOLOGIES CORPORATION AND SHALL NOT BE REPRODUCED OR USED AS THE BASIS FOR THE MANUFACTURE OR SALE OF APPARATUS OR DEVICES WITHOUT PERMISSION

Prepared by : Jane

Designed by : George Hung

Checked by : Mike

Approved by : Herbert

TITLE : 3.2 x 1.6 x 0.5(mm) WiFi/Bluetooth Ceramic Chip Antenna (AA055C) Engineering Specification

DOCUMENT NO.

H2U34W1H1Z0600

REV.
H

11. Packing

- (1) Quantity/Reel: 5000 pcs/Reel
- (2) Plastic tape:

a. Tape Drawing

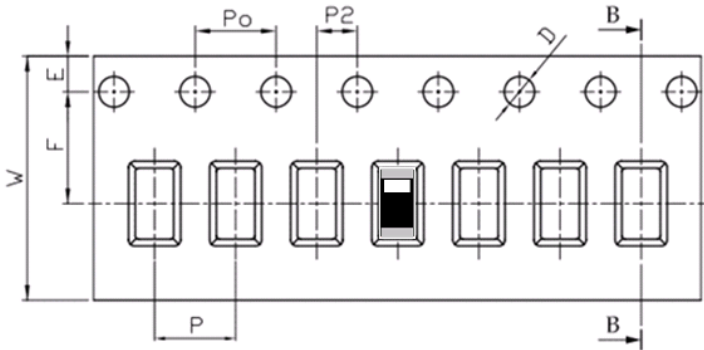

b. Tape Dimensions (unit: mm)

Feature	Specifications	Tolerances
W	12.00	±0.30
P	4.00	±0.10
E	1.75	±0.10
F	5.50	±0.10
P2	2.00	±0.10
D	1.50	+0.10 -0.00
Po	4.00	±0.10
10Po	40.00	±0.20

c. Reel Drawing

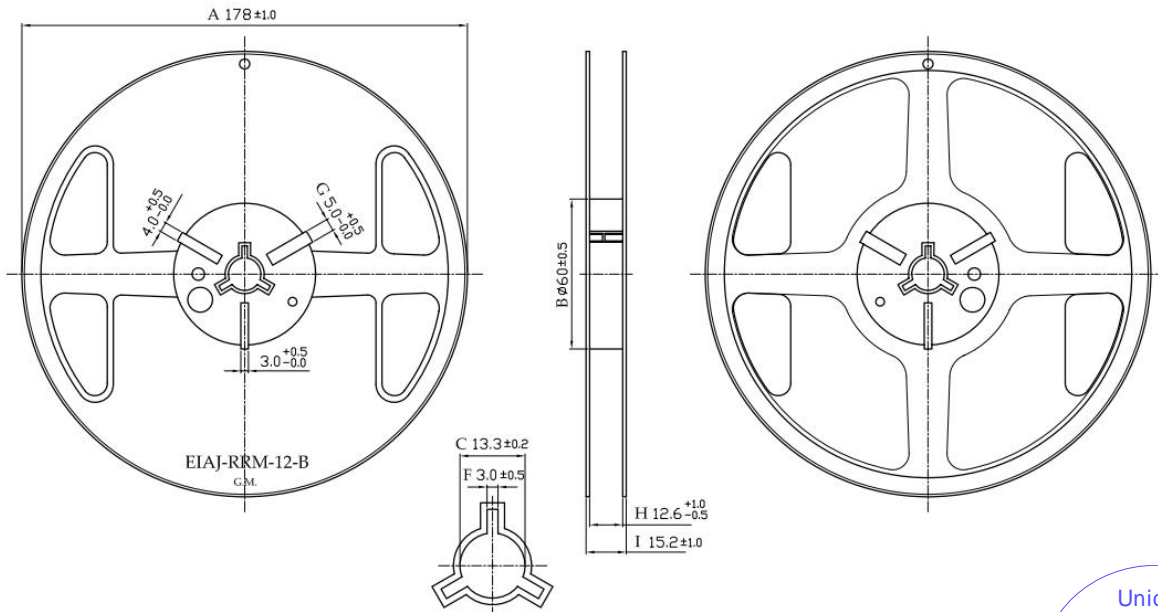

Unictron
Technologies Corp.
2021-07-05
Document
Control Center



詠業科技股份有限公司
Unictron Technologies Corporation
Website: www.unictron.com

THIS DRAWINGS AND SPECIFICATIONS ARE THE PROPERTY OF UNICTRON TECHNOLOGIES CORPORATION AND SHALL NOT BE REPRODUCED OR USED AS THE BASIS FOR THE MANUFACTURE OR SALE OF APPARATUS OR DEVICES WITHOUT PERMISSION

Prepared by : **Jane**

Designed by : **George Hung**

Checked by : **Mike**

Approved by : **Herbert**

TITLE : 3.2 x 1.6 x 0.5(mm) WiFi/Bluetooth Ceramic Chip Antenna (AA055C) Engineering Specification

DOCUMENT NO.

H2U34W1H1Z0600

REV. H

d. Drawing of small size carton in developed view

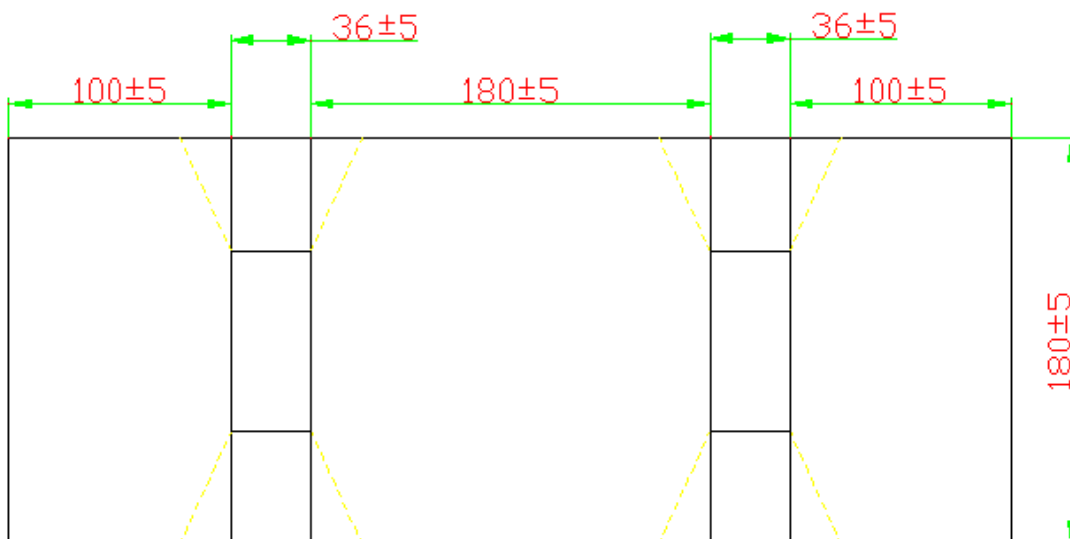

e. Drawing of middle size carton in developed view

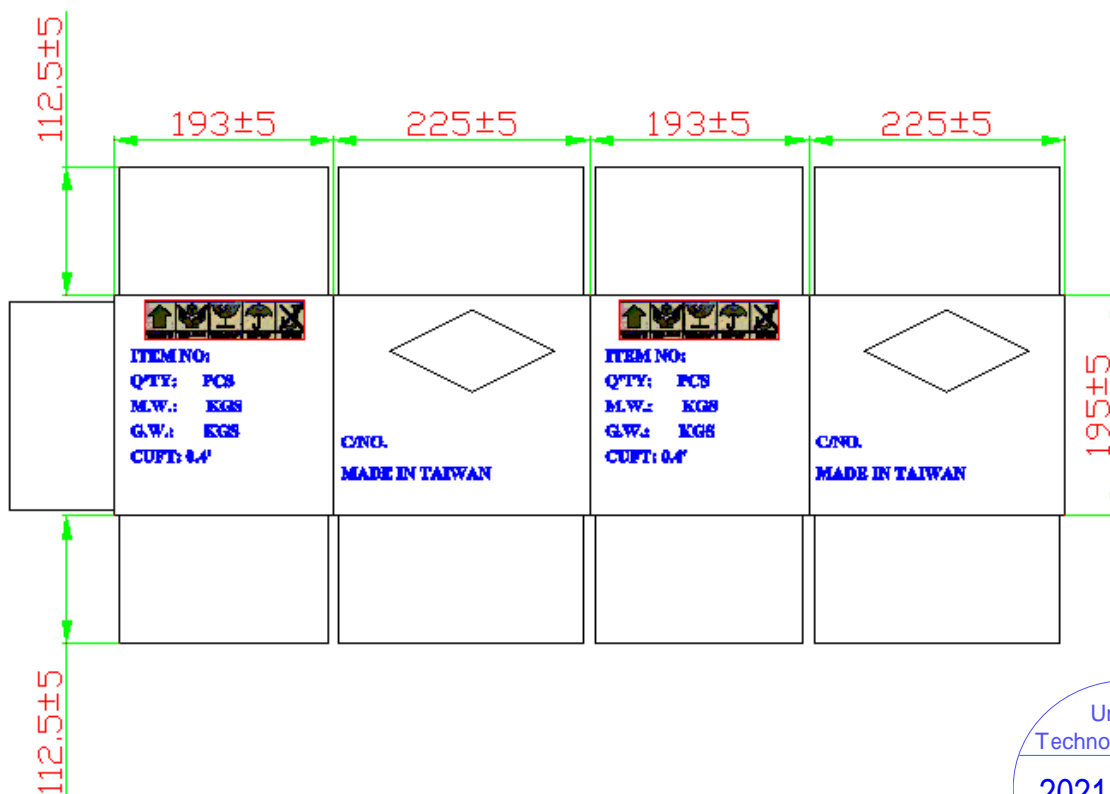

詠業科技股份有限公司
Unictron Technologies Corporation
Website: www.unictron.com

THIS DRAWINGS AND SPECIFICATIONS ARE THE PROPERTY OF UNICTRON TECHNOLOGIES CORPORATION AND SHALL NOT BE REPRODUCED OR USED AS THE BASIS FOR THE MANUFACTURE OR SALE OF APPARATUS OR DEVICES WITHOUT PERMISSION

Prepared by : Jane Designed by : George Hung Checked by : Mike Approved by : Herbert

TITLE : 3.2 x 1.6 x 0.5(mm) WiFi/Bluetooth Ceramic Chip Antenna (AA055C) Engineering Specification	DOCUMENT NO.	H2U34W1H1Z0600	REV.
			H

f. Drawing of large size carton in developed view

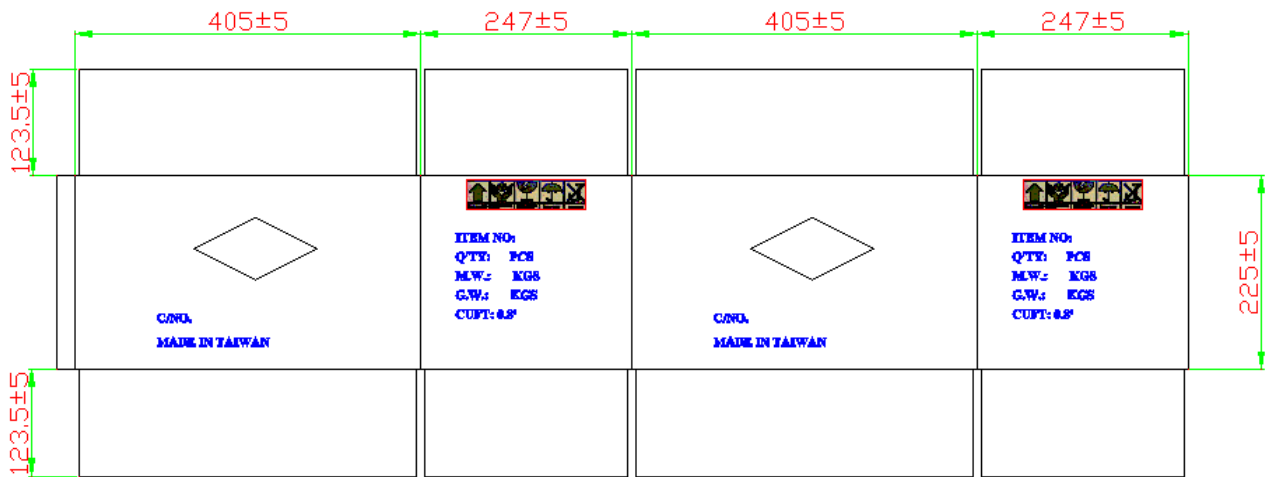

g. Picture of label

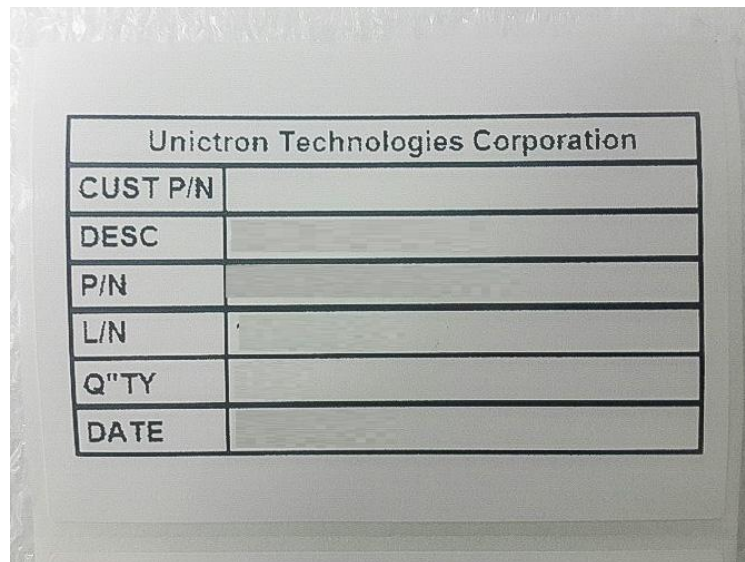

詠業科技股份有限公司
Unictron Technologies Corporation
Website: www.unictron.com

THIS DRAWINGS AND SPECIFICATIONS ARE THE PROPERTY OF UNICTRON TECHNOLOGIES CORPORATION AND SHALL NOT BE REPRODUCED OR USED AS THE BASIS FOR THE MANUFACTURE OR SALE OF APPARATUS OR DEVICES WITHOUT PERMISSION

Prepared by : Jane

Designed by : George Hung

Checked by : Mike

Approved by : Herbert

TITLE : 3.2 x 1.6 x 0.5(mm) WiFi/Bluetooth Ceramic Chip Antenna (AA055C) Engineering Specification

DOCUMENT NO.

H2U34W1H1Z0600

REV.

H

h. Reel with label



i. Small size carton with label

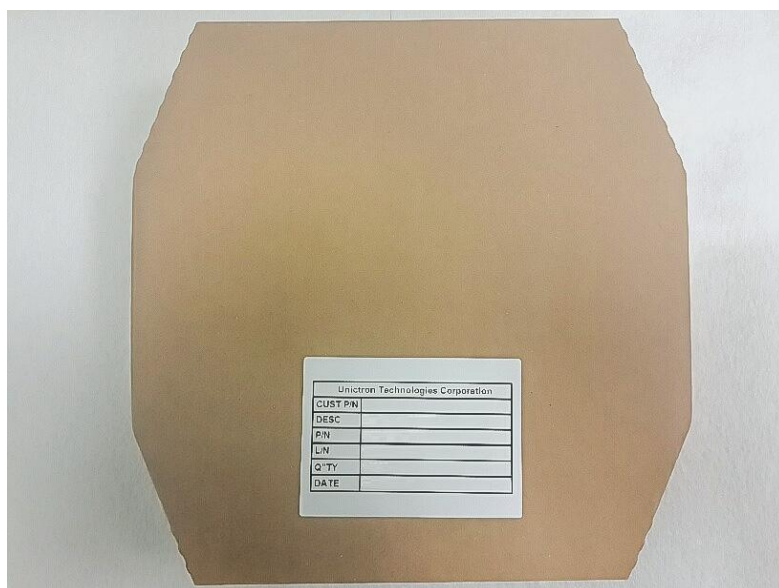

詠業科技股份有限公司
 Unictron Technologies Corporation
 Website:www.unictron.com

THIS DRAWINGS AND SPECIFICATIONS ARE THE PROPERTY OF UNICTRON TECHNOLOGIES CORPORATION AND SHALL NOT BE REPRODUCED OR USED AS THE BASIS FOR THE MANUFACTURE OR SALE OF APPARATUS OR DEVICES WITHOUT PERMISSION

Prepared by : **Jane** Designed by : **George Hung** Checked by : **Mike** Approved by : **Herbert**

TITLE : 3.2 x 1.6 x 0.5(mm) WiFi/Bluetooth Ceramic Chip Antenna (AA055C) Engineering Specification	DOCUMENT NO.	H2U34W1H1Z0600	REV.
			H

j. Middle size carton with label



11-2. Process of packing



1 reel includes 5,000pcs(max.) chip antennas

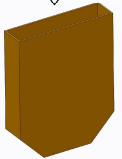

1 small size carton includes 2pcs(max.) reels

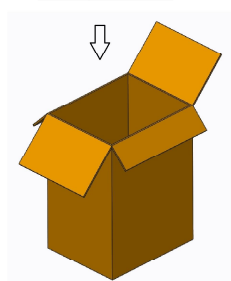

1 middle size carton includes 5pcs(max.) small cartons

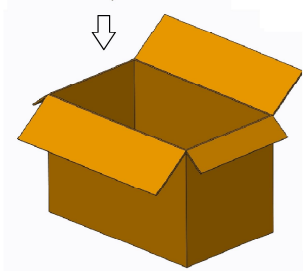

1 large size carton includes 2pcs(max.) middle cartons

Unictron
Technologies Corp.
2021-07-05
Document
Control Center



詠業科技股份有限公司
Unictron Technologies Corporation
Website:www.unictron.com

THIS DRAWINGS AND SPECIFICATIONS ARE THE PROPERTY OF UNICTRON TECHNOLOGIES CORPORATION AND SHALL NOT BE REPRODUCED OR USED AS THE BASIS FOR THE MANUFACTURE OR SALE OF APPARATUS OR DEVICES WITHOUT PERMISSION

Prepared by : **Jane** Designed by : **George Hung** Checked by : **Mike** Approved by : **Herbert**

TITLE : 3.2 x 1.6 x 0.5(mm) WiFi/Bluetooth Ceramic Chip Antenna (AA055C) Engineering Specification	DOCUMENT NO.	H2U34W1H1Z0600	REV.
			H

12. Operating & Storage Conditions

12-1. Operating

- (1) Maximum Input Power: 2 W
- (2) Operating Temperature: -40°C to 85°C
- (3) Relative Humidity: 10% to 70%

12-2. Storage (sealed)

- (1) Storage Temperature: -5°C to 40°C
- (2) Relative Humidity: 20% to 70%
- (3) Shelf Life: 1 year

12-3. Storage (unsealed)

Meet the criteria of J-STD-033 MSL2a

12-4. Storage (After mounted on customer's PCB with SMT process)

- (1) Storage Temperature: -40°C to 85°C
- (2) Relative Humidity: 10% to 70%

13. Notice

(1) Installation Guide:

Please refer to Unictron's application note "General guidelines for the installation of Unictron's chip antennas" for further information.

(2) All specifications are subject to change without notice.



詠業科技股份有限公司
Unictron Technologies Corporation
Website: www.unictron.com

THIS DRAWINGS AND SPECIFICATIONS ARE THE PROPERTY OF UNICTRON TECHNOLOGIES CORPORATION AND SHALL NOT BE REPRODUCED OR USED AS THE BASIS FOR THE MANUFACTURE OR SALE OF APPARATUS OR DEVICES WITHOUT PERMISSION

Prepared by : **Jane**

Designed by : **George Hung**

Checked by : **Mike**

Approved by : **Herbert**

TITLE : 3.2 x 1.6 x 0.5(mm) WiFi/Bluetooth Ceramic Chip Antenna (AA055C) Engineering Specification

DOCUMENT NO.

H2U34W1H1Z0600

REV.
H