

FCC Test Report (BT LE)

Report No.: RF190123D06

FCC ID: 2AAFMRGP0085

Test Model: RGP0085

Received Date: Jan. 23, 2019

Test Date: Jan. 29 ~ Feb. 15, 2019

Issued Date: Feb. 21, 2019

Applicant: Corsair Memory, Inc.

Address: 47100 Bayside Pkwy, Fremont, CA 94538, USA

Issued By: Bureau Veritas Consumer Products Services (H.K.) Ltd., Taoyuan Branch

Lab Address: No. 47-2, 14th Ling, Chia Pau Vil., Lin Kou Dist., New Taipei City, Taiwan, R.O.C.

**FCC Registration /
Designation Number:** 198487 / TW2021



This report is for your exclusive use. Any copying or replication of this report to or for any other person or entity, or use of our name or trademark, is permitted only with our prior written permission. This report sets forth our findings solely with respect to the test samples identified herein. The results set forth in this report are not indicative or representative of the quality or characteristics of the lot from which a test sample was taken or any similar or identical product specifically and expressly noted. Our report includes all of the tests requested by you and the results thereof based upon the information that you provided to us. You have 60 days from date of issuance of this report to notify us of any material error or omission caused by our negligence, provided, however, that such notice shall be in writing and shall specifically address the issue you wish to raise. A failure to raise such issue within the prescribed time shall constitute your unqualified acceptance of the completeness of this report, the tests conducted and the correctness of the report contents. Unless specific mention, the uncertainty of measurement has been explicitly taken into account to declare the compliance or non-compliance to the specification. The report must not be used by the client to claim product certification, approval, or endorsement by TAF or any government agencies.

Table of Contents

Release Control Record	4
1 Certificate of Conformity	5
2 Summary of Test Results	6
2.1 Measurement Uncertainty	6
2.2 Modification Record	6
3 General Information	7
3.1 General Description of EUT	7
3.2 Description of Test Modes.....	8
3.2.1 Test Mode Applicability and Tested Channel Detail.....	9
3.3 Duty cycle of test signal	11
3.4 Description of Support Units	12
3.4.1 Configuration of System under Test	12
3.5 General Description of Applied Standards	13
4 Test Types and Results	14
4.1 Radiated Emission and Bandedge Measurement.....	14
4.1.1 Limits of Radiated Emission and Bandedge Measurement	14
4.1.2 Test Instruments	15
4.1.3 Test Procedures.....	16
4.1.4 Deviation from Test Standard	16
4.1.5 Test Setup.....	17
4.1.6 EUT Operating Conditions.....	18
4.1.7 Test Results	19
4.2 Conducted Emission Measurement.....	24
4.2.1 Limits of Conducted Emission Measurement.....	24
4.2.2 Test Instruments	24
4.2.3 Test Procedure	25
4.2.4 Deviation from Test Standard	25
4.2.5 Test Setup.....	25
4.2.6 EUT Operating Condition	25
4.2.7 Test Results	26
4.3 6dB Bandwidth Measurement.....	30
4.3.1 Limits of 6dB Bandwidth Measurement.....	30
4.3.2 Test Setup.....	30
4.3.3 Test Instruments	30
4.3.4 Test Procedure	30
4.3.5 Deviation from Test Standard	30
4.3.6 EUT Operating Conditions.....	30
4.3.7 Test Result.....	31
4.4 Conducted Output Power Measurement.....	32
4.4.1 Limits OF Conducted Output Power Measurement	32
4.4.2 Test Setup.....	32
4.4.3 Test Instruments	32
4.4.4 Test Procedures.....	32
4.4.5 Deviation from Test Standard	32
4.4.6 EUT Operating Conditions.....	32
4.4.7 Test Results	33
4.5 Power Spectral Density Measurement.....	34

4.5.1	Limits of Power Spectral Density Measurement.....	34
4.5.2	Test Setup.....	34
4.5.3	Test Instruments	34
4.5.4	Test Procedure	34
4.5.5	Deviation from Test Standard	34
4.5.6	EUT Operating Condition	34
4.5.7	Test Results	35
4.6	Conducted Out of Band Emission Measurement.....	36
4.6.1	Limits of Conducted Out of Band Emission Measurement.....	36
4.6.2	Test Setup.....	36
4.6.3	Test Instruments	36
4.6.4	Test Procedure	36
4.6.5	Deviation from Test Standard	36
4.6.6	EUT Operating Condition	36
4.6.7	Test Results	37
5	Pictures of Test Arrangements.....	38
	Appendix – Information on the Testing Laboratories	39

Release Control Record

Issue No.	Description	Date Issued
RF190123D06	Original release.	Feb. 21, 2019

1 Certificate of Conformity

Product: CORSAIR K57 RGB Wireless Gaming Keyboard

Brand: Corsair

Test Model: RGP0085

Sample Status: Engineering sample

Applicant: Corsair Memory, Inc.

Test Date: Jan. 29 ~ Feb. 15, 2019

Standards: 47 CFR FCC Part 15, Subpart C (Section 15.247)
ANSI C63.10: 2013

The above equipment has been tested by **Bureau Veritas Consumer Products Services (H.K.) Ltd., Taoyuan Branch**, and found compliance with the requirement of the above standards. The test record, data evaluation & Equipment Under Test (EUT) configurations represented herein are true and accurate accounts of the measurements of the sample's RF characteristics under the conditions specified in this report.

Prepared by :



Date:

Feb. 21, 2019

Jessica Cheng / Senior Specialist

Approved by :



Date:

Feb. 21, 2019

Rex Lai / Associate Technical Manager

2 Summary of Test Results

47 CFR FCC Part 15, Subpart C (SECTION 15.247)			
FCC Clause	Test Item	Result	Remarks
15.207	AC Power Conducted Emission	PASS	Meet the requirement of limit. Minimum passing margin is -14.81dB at 0.18516 MHz.
15.205 & 209 & 15.247(d)	Radiated Emissions & Band Edge Measurement	PASS	Meet the requirement of limit. Minimum passing margin is -11.86dB at 2483.50 MHz.
15.247(d)	Antenna Port Emission	PASS	Meet the requirement of limit.
15.247(a)(2)	6dB bandwidth	PASS	Meet the requirement of limit.
15.247(b)	Conducted power	PASS	Meet the requirement of limit.
15.247(e)	Power Spectral Density	PASS	Meet the requirement of limit.
15.203	Antenna Requirement	PASS	No antenna connector is used.

Note: Determining compliance based on the results of the compliance measurement, not taking into account measurement instrumentation uncertainty.

2.1 Measurement Uncertainty

Where relevant, the following measurement uncertainty levels have been estimated for tests performed on the EUT as specified in CISPR 16-4-2:

Measurement	Frequency	Expanded Uncertainty (k=2) (\pm)
Conducted Emissions at mains ports	150kHz ~ 30MHz	2.77 dB
Radiated Emissions up to 1 GHz	9kHz ~ 30MHz	2.38 dB
	30MHz ~ 1000MHz	5.54 dB
Radiated Emissions above 1 GHz	Above 1GHz	5.48 dB

2.2 Modification Record

There were no modifications required for compliance.

3 General Information

3.1 General Description of EUT

Product	CORSAIR K57 RGB Wireless Gaming Keyboard
Brand	Corsair
Test Model	RGP0085
Status of EUT	Engineering Sample
Power Supply Rating	3.7Vdc from battery (For Wireless mode) 5Vdc from USB interface (For Wired mode and Charging mode)
Modulation Type	GFSK
Transfer Rate	Up to 1Mbps
Operating Frequency	2402MHz ~ 2480MHz
Number of Channel	40
Output Power	1.371mW
Antenna Type	Printed antenna with 3.55dBi gain
Antenna Connector	N/A
Accessory Device	N/A
Data Cable Supplied	Shielded USB cable (1.8m)

Note:

1. Bluetooth & GFSK technologies cannot transmit at same time.
2. The above EUT information is declared by manufacturer and for more detailed features description, please refer to the manufacturer's specifications or user's manual.

3.2 Description of Test Modes

40 channels are provided to this EUT:

CHANNEL	FREQ. (MHz)	CHANNEL	FREQ. (MHz)	CHANNEL	FREQ. (MHz)	CHANNEL	FREQ. (MHz)
0	2402	10	2422	20	2442	30	2462
1	2404	11	2424	21	2444	31	2464
2	2406	12	2426	22	2446	32	2466
3	2408	13	2428	23	2448	33	2468
4	2410	14	2430	24	2450	34	2470
5	2412	15	2432	25	2452	35	2472
6	2414	16	2434	26	2454	36	2474
7	2416	17	2436	27	2456	37	2476
8	2418	18	2438	28	2458	38	2478
9	2420	19	2440	29	2460	39	2480

3.2.1 Test Mode Applicability and Tested Channel Detail

EUT Configure Mode	Applicable To				Description
	RE≥1G	RE<1G	PLC	APCM	
A	√	√	-	√	Operating Mode (EUT Stand-alone)
B	-	-	√	-	Charging Mode (Powered from Notebook)
C	-	-	√	-	Charging Mode (Powered from Adapter)

Where **RE≥1G**: Radiated Emission above 1GHz **RE<1G**: Radiated Emission below 1GHz
PLC: Power Line Conducted Emission **APCM**: Antenna Port Conducted Measurement

Radiated Emission Test (Above 1GHz):

- Pre-Scan has been conducted to determine the worst-case mode from all possible combinations between available modulations, data rates and antenna ports (if EUT with antenna diversity architecture).
- Following channel(s) was (were) selected for the final test as listed below.

EUT Configure Mode	Available Channel	Tested Channel	Modulation Type	Data Rate (Mbps)
A	0 to 39	0, 19, 39	GFSK	1

Radiated Emission Test (Below 1GHz):

- Pre-Scan has been conducted to determine the worst-case mode from all possible combinations between available modulations, data rates and antenna ports (if EUT with antenna diversity architecture).
- Following channel(s) was (were) selected for the final test as listed below.

EUT Configure Mode	Available Channel	Tested Channel	Modulation Type	Data Rate (Mbps)
A	0 to 39	39	GFSK	1

Power Line Conducted Emission Test:

- Pre-Scan has been conducted to determine the worst-case mode from all possible combinations between available modulations, data rates and antenna ports (if EUT with antenna diversity architecture).
- Following channel(s) was (were) selected for the final test as listed below.

EUT Configure Mode	Available Channel	Tested Channel	Modulation Type	Data Rate (Mbps)
B~C	0 to 39	39	GFSK	1

Antenna Port Conducted Measurement:

- This item includes all test value of each mode, but only includes spectrum plot of worst value of each mode.
- Pre-Scan has been conducted to determine the worst-case mode from all possible combinations between available modulations, data rates and antenna ports (if EUT with antenna diversity architecture).
- Following channel(s) was (were) selected for the final test as listed below.

EUT Configure Mode	Available Channel	Tested Channel	Modulation Type	Data Rate (Mbps)
A	0 to 39	0, 19, 39	GFSK	1

Test Condition:

Applicable To	EUT Configure Mode	Environmental Conditions	Input Power	Tested By
RE \geq 1G	A	20deg. C, 66%RH	3.7Vdc	Ian Chang
RE<1G	A	23deg. C, 69%RH	3.7Vdc	Ian Chang
PLC	B	25deg. C, 75%RH	120Vac, 60Hz(System)	Ian Chang
	C	25deg. C, 75%RH	120Vac, 60Hz(Adapter)	Ian Chang
APCM	A	25deg. C, 76%RH	3.7Vdc	Dalen Dai

3.3 Duty cycle of test signal

Duty cycle of test signal is < 98%

Duty cycle = $0.264/0.816 = 0.324$, Duty factor = $10 * \log(1/0.324) = 4.9$



3.4 Description of Support Units

The EUT has been tested as an independent unit together with other necessary accessories or support units. The following support units or accessories were used to form a representative test configuration during the tests.

ID	Product	Brand	Model No.	Serial No.	FCC ID	Remarks
A.	Notebook PC	Lenovo	81A4	YD02TWDP	FCC DoC Approved	Provided by Lab
B.	AC Adapter	HTC	TC U250	N/A	N/A	Provided by Lab

Note: All power cords of the above support units are non-shielded (1.8m).

ID	Descriptions	Qty.	Length (m)	Shielding (Yes/No)	Cores (Qty.)	Remarks
1.	USB cable	1	1.8	Y	0	Supplied by client

Note: The core(s) is(are) originally attached to the cable(s).

3.4.1 Configuration of System under Test

Mode A:

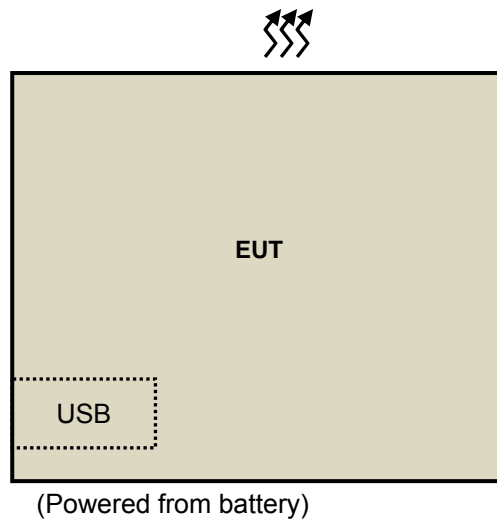

Mode B:

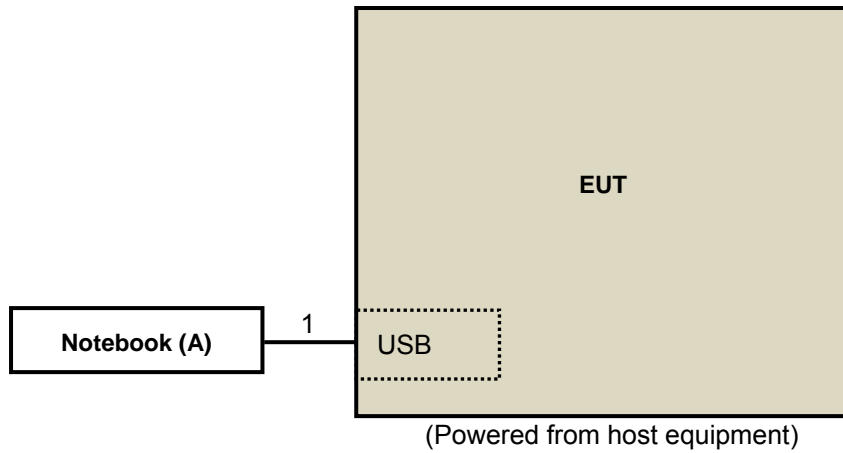

Mode C:

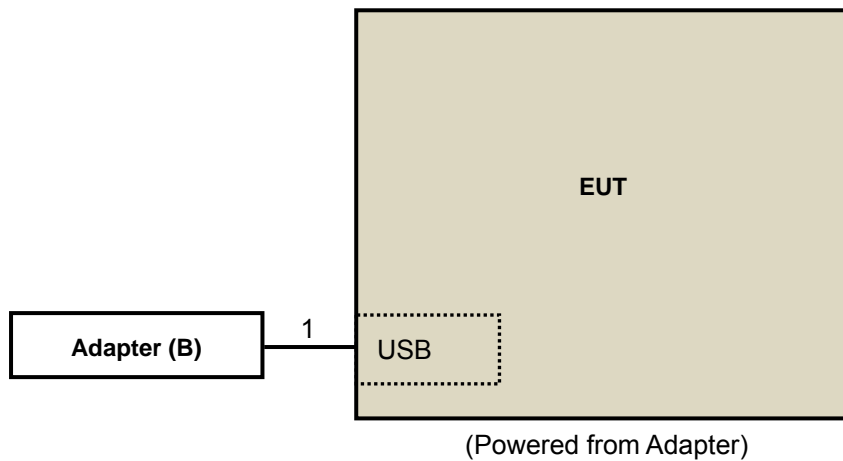

3.5 General Description of Applied Standards

The EUT is a RF Product. According to the specifications of the manufacturer, it must comply with the requirements of the following standards:

- FCC Part 15, Subpart C (15.247)**
- KDB 558074 D01 15.247 Meas Guidance v05r1**
- ANSI C63.10-2013

All test items have been performed and recorded as per the above standards.

4 Test Types and Results

4.1 Radiated Emission and Bandedge Measurement

4.1.1 Limits of Radiated Emission and Bandedge Measurement

Radiated emissions which fall in the restricted bands must comply with the radiated emission limits specified as below table. Other emissions shall be at least 20dB below the highest level of the desired power:

Frequencies (MHz)	Field Strength (microvolts/meter)	Measurement Distance (meters)
0.009 ~ 0.490	2400/F(kHz)	300
0.490 ~ 1.705	24000/F(kHz)	30
1.705 ~ 30.0	30	30
30 ~ 88	100	3
88 ~ 216	150	3
216 ~ 960	200	3
Above 960	500	3

NOTE:

1. The lower limit shall apply at the transition frequencies.
2. Emission level (dBuV/m) = 20 log Emission level (uV/m).
3. For frequencies above 1000MHz, the field strength limits are based on average detector, however, the peak field strength of any emission shall not exceed the maximum permitted average limits, specified above by more than 20dB under any condition of modulation.

4.1.2 Test Instruments

DESCRIPTION & MANUFACTURER	MODEL NO.	SERIAL NO.	CALIBRATED DATE	CALIBRATED UNTIL
HP Preamplifier	8447D	2432A03504	Feb. 21, 2018	Feb. 20, 2019
HP Preamplifier	8449B	3008A01201	Feb. 22, 2018	Feb. 21, 2019
MITEQ Preamplifier	AMF-6F-260400-33-8P	892164	Feb. 21, 2018	Feb. 20, 2019
Agilent TEST RECEIVER	N9038A	MY51210137	Jun. 19, 2018	Jun. 18, 2019
Schwarzbeck Antenna	VULB 9168	139	Nov. 26, 2018	Nov. 25, 2019
Schwarzbeck Antenna	VHBA 9123	480	May 19, 2017	May 18, 2019
Schwarzbeck Horn Antenna	BBHA-9170	212	Nov. 25, 2018	Nov. 24, 2019
Schwarzbeck Horn Antenna	BBHA 9120-D1	D130	Nov. 25, 2018	Nov. 24, 2019
ADT. Turn Table	TT100	0306	NA	NA
ADT. Tower	AT100	0306	NA	NA
Software	Radiated_V7.6.15.9.5	NA	NA	NA
SUHNER RF cable With 4dB PAD	SF102	Cable-CH6-01	Aug. 13, 2018	Aug. 12, 2019
SUHNER RF cable With 3/4dB PAD	SF102	Cable-CH8-3.6m	Aug. 13, 2018	Aug. 12, 2019
KEYSIGHT MIMO Powermeasurement Test set	U2021XA	U2021XA-001	Jun. 4, 2018	Jun. 3, 2019
KEYSIGHT Spectrum Analyzer	N9030A	MY54490260	Aug. 3, 2018	Aug. 2, 2019
Loop Antenna EMCI	LPA600	270	Aug. 11, 2017	Aug. 10, 2019
EMCO Horn Antenna	3115	00028257	Nov. 25, 2018	Nov. 24, 2019
Highpass filter Wainwright Instruments	WHK 3.1/18G-10SS	SN 8	NA	NA
ROHDE & SCHWARZ Spectrum Analyzer	FSV40	101042	Sep. 27, 2018	Sep. 26, 2019
Anritsu Power Sensor	MA2411B	0738404	Apr. 26, 2018	Apr. 25, 2019
Anritsu Power Meter	ML2495A	0842014	Apr. 26, 2018	Apr. 25, 2019

- NOTE:**
1. The calibration interval of the above test instruments is 12/24 months. And the calibrations are traceable to NML/ROC and NIST/USA.
 2. The horn antenna and HP preamplifier (model: 8449B) are used only for the measurement of emission frequency above 1GHz if tested.
 3. The test was performed in Chamber No. 6.
 4. The Industry Canada Reference No. IC 7450E-6.

4.1.3 Test Procedures

For Radiated emission below 30MHz

- a. The EUT was placed on the top of a rotating table 0.8 meters above the ground at a 3 meter chamber room. The table was rotated 360 degrees to determine the position of the highest radiation.
- b. The EUT was set 3 meters away from the interference-receiving antenna, which was mounted on the top of a variable-height antenna tower.
- c. Parallel, perpendicular, and ground-parallel orientations of the antenna are set to make the measurement.
- d. For each suspected emission, the EUT was arranged to its worst case and the rotatable table was turned from 0 degrees to 360 degrees to find the maximum reading.
- e. The test-receiver system was set to Quasi-Peak Detect Function and Specified Bandwidth with Maximum Hold Mode.

NOTE: The resolution bandwidth and video bandwidth of test receiver/spectrum analyzer is 9kHz at frequency below 30MHz.

For Radiated emission above 30MHz

- a. The EUT was placed on the top of a rotating table 0.8 meters (for 30MHz ~ 1GHz) / 1.5 meters (for above 1GHz) above the ground at 3 meter chamber room for test. The table was rotated 360 degrees to determine the position of the highest radiation.
- b. The EUT was set 3 meters away from the interference-receiving antenna, which was mounted on the top of a variable-height antenna tower.
- c. The height of antenna is varied from one meter to four meters above the ground to determine the maximum value of the field strength. Both horizontal and vertical polarizations of the antenna are set to make the measurement.
- d. For each suspected emission, the EUT was arranged to its worst case and then the antenna was tuned to heights from 1 meter to 4 meters and the rotatable table was turned from 0 degrees to 360 degrees to find the maximum reading.
- e. The test-receiver system was set to quasi-peak detect function and specified bandwidth with maximum hold mode when the test frequency is below 1 GHz.
- f. The test-receiver system was set to peak and average detect function and specified bandwidth with maximum hold mode when the test frequency is above 1 GHz. If the peak reading value also meets average limit, measurement with the average detector is unnecessary.

Note:

1. The resolution bandwidth and video bandwidth of test receiver/spectrum analyzer is 120kHz for Quasi-peak detection (QP) at frequency below 1GHz.
2. The resolution bandwidth of test receiver/spectrum analyzer is 1 MHz and the video bandwidth is 3 MHz for Peak detection (PK) at frequency above 1GHz.
3. The resolution bandwidth of test receiver/spectrum analyzer is 1MHz and the video bandwidth is $\geq 1/T$ (Duty cycle < 98%) or 10Hz (Duty cycle $\geq 98\%$) for Peak detection at frequency above 1GHz.
4. All modes of operation were investigated and the worst-case emissions are reported.

4.1.4 Deviation from Test Standard

No deviation.

4.1.5 Test Setup

For Radiated emission below 30MHz

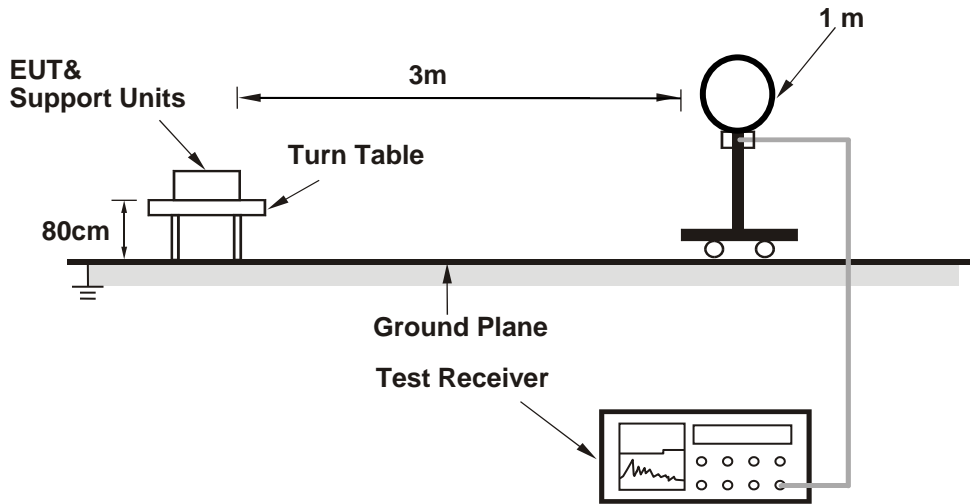

For Radiated emission 30MHz to 1GHz

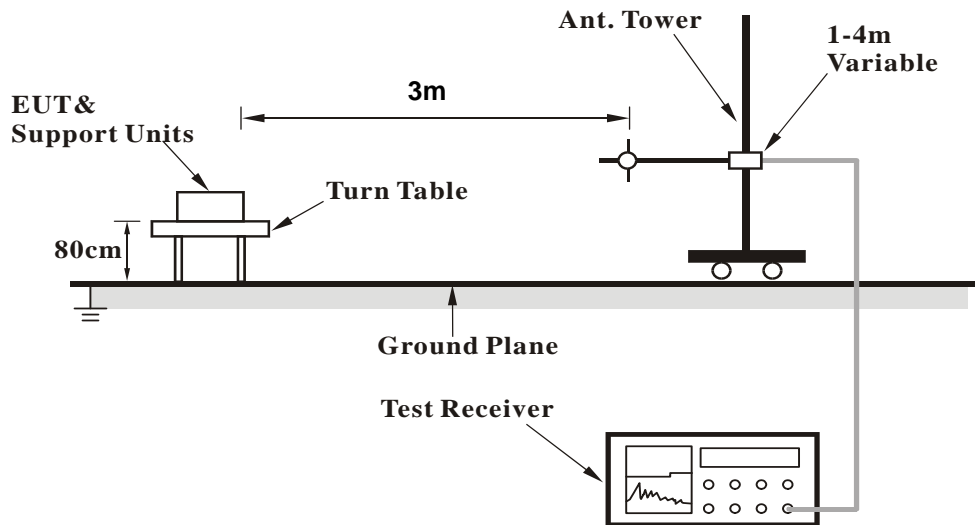

For Radiated emission above 1GHz

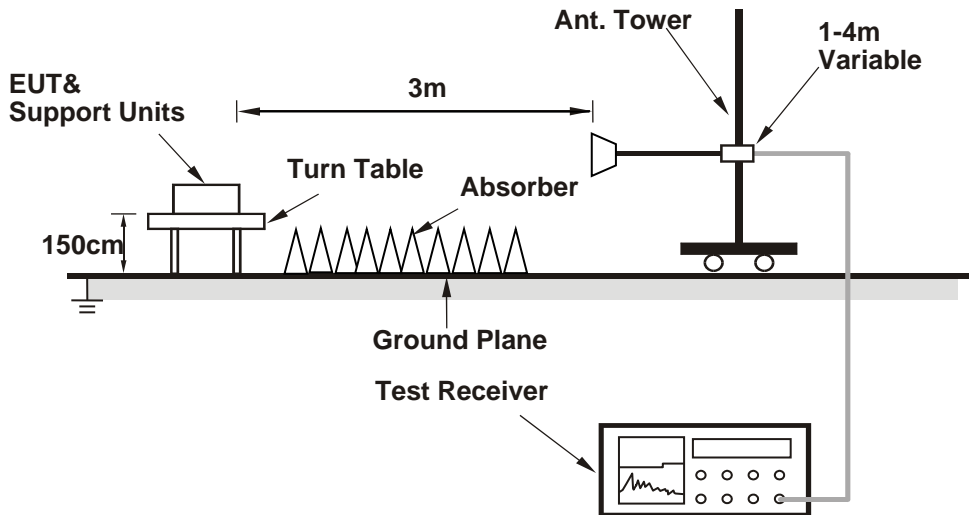

For the actual test configuration, please refer to the attached file (Test Setup Photo).

4.1.6 EUT Operating Conditions

Set the EUT under transmission condition continuously at specific channel frequency continuously.

4.1.7 Test Results

Mode A

ABOVE 1GHz DATA

CHANNEL	TX Channel 0	DETECTOR FUNCTION	Peak (PK)
FREQUENCY RANGE	1GHz ~ 25GHz		Average (AV)

ANTENNA POLARITY & TEST DISTANCE: HORIZONTAL AT 3 M

NO.	FREQ. (MHz)	EMISSION LEVEL (dBuV/m)	LIMIT (dBuV/m)	MARGIN (dB)	ANTENNA HEIGHT (m)	TABLE ANGLE (Degree)	RAW VALUE (dBuV)	CORRECTION FACTOR (dB/m)
1	2390.00	53.21 PK	74.00	-20.79	1.16 H	315	54.36	-1.15
2	2390.00	38.96 AV	54.00	-15.04	1.16 H	315	40.11	-1.15
3	*2402.00	97.24 PK			1.16 H	315	98.39	-1.15
4	*2402.00	96.29 AV			1.16 H	315	97.44	-1.15
5	4804.00	48.23 PK	74.00	-25.77	1.30 H	93	42.89	5.34
6	4804.00	38.88 AV	54.00	-15.12	1.30 H	93	33.54	5.34

ANTENNA POLARITY & TEST DISTANCE: VERTICAL AT 3 M

NO.	FREQ. (MHz)	EMISSION LEVEL (dBuV/m)	LIMIT (dBuV/m)	MARGIN (dB)	ANTENNA HEIGHT (m)	TABLE ANGLE (Degree)	RAW VALUE (dBuV)	CORRECTION FACTOR (dB/m)
1	2390.00	52.98 PK	74.00	-21.02	3.86 V	163	54.13	-1.15
2	2390.00	38.79 AV	54.00	-15.21	3.86 V	163	39.94	-1.15
3	*2402.00	96.57 PK			3.86 V	163	97.72	-1.15
4	*2402.00	95.62 AV			3.86 V	163	96.77	-1.15
5	4804.00	48.74 PK	74.00	-25.26	2.28 V	162	43.40	5.34
6	4804.00	40.88 AV	54.00	-13.12	2.28 V	162	35.54	5.34

REMARKS:

1. Emission Level(dBuV/m) = Raw Value(dBuV) + Correction Factor(dB/m)
2. Correction Factor(dB/m) = Antenna Factor(dB/m) + Cable Factor(dB) – Pre-Amplifier Factor(dB)
3. The other emission levels were very low against the limit.
4. Margin value = Emission Level – Limit value
5. " * ": Fundamental frequency.

CHANNEL	TX Channel 19	DETECTOR FUNCTION	Peak (PK)
FREQUENCY RANGE	1GHz ~ 25GHz		Average (AV)

ANTENNA POLARITY & TEST DISTANCE: HORIZONTAL AT 3 M

NO.	FREQ. (MHz)	EMISSION LEVEL (dBuV/m)	LIMIT (dBuV/m)	MARGIN (dB)	ANTENNA HEIGHT (m)	TABLE ANGLE (Degree)	RAW VALUE (dBuV)	CORRECTION FACTOR (dB/m)
1	*2440.00	96.84 PK			1.33 H	280	97.91	-1.07
2	*2440.00	95.79 AV			1.33 H	280	96.86	-1.07
3	4880.00	47.80 PK	74.00	-26.20	1.00 H	128	42.74	5.06
4	4880.00	38.42 AV	54.00	-15.58	1.00 H	128	33.36	5.06

ANTENNA POLARITY & TEST DISTANCE: VERTICAL AT 3 M

NO.	FREQ. (MHz)	EMISSION LEVEL (dBuV/m)	LIMIT (dBuV/m)	MARGIN (dB)	ANTENNA HEIGHT (m)	TABLE ANGLE (Degree)	RAW VALUE (dBuV)	CORRECTION FACTOR (dB/m)
1	*2440.00	96.06 PK			3.90 V	158	97.13	-1.07
2	*2440.00	94.95 AV			3.90 V	158	96.02	-1.07
3	4880.00	48.58 PK	74.00	-25.42	2.36 V	157	43.52	5.06
4	4880.00	40.32 AV	54.00	-13.68	2.36 V	157	35.26	5.06

REMARKS:

1. Emission Level(dBuV/m) = Raw Value(dBuV) + Correction Factor(dB/m)
2. Correction Factor(dB/m) = Antenna Factor(dB/m) + Cable Factor(dB) – Pre-Amplifier Factor(dB)
3. The other emission levels were very low against the limit.
4. Margin value = Emission Level – Limit value
5. " * ": Fundamental frequency.

CHANNEL	TX Channel 39	DETECTOR FUNCTION	Peak (PK)
FREQUENCY RANGE	1GHz ~ 25GHz		Average (AV)

ANTENNA POLARITY & TEST DISTANCE: HORIZONTAL AT 3 M

NO.	FREQ. (MHz)	EMISSION LEVEL (dBuV/m)	LIMIT (dBuV/m)	MARGIN (dB)	ANTENNA HEIGHT (m)	TABLE ANGLE (Degree)	RAW VALUE (dBuV)	CORRECTION FACTOR (dB/m)
1	*2480.00	97.47 PK			1.49 H	273	98.45	-0.98
2	*2480.00	96.59 AV			1.49 H	273	97.57	-0.98
3	2483.50	62.14 PK	74.00	-11.86	1.49 H	273	63.12	-0.98
4	2483.50	41.38 AV	54.00	-12.62	1.49 H	273	42.36	-0.98
5	4960.00	47.98 PK	74.00	-26.02	1.33 H	89	42.95	5.03
6	4960.00	38.71 AV	54.00	-15.29	1.33 H	89	33.68	5.03

ANTENNA POLARITY & TEST DISTANCE: VERTICAL AT 3 M

NO.	FREQ. (MHz)	EMISSION LEVEL (dBuV/m)	LIMIT (dBuV/m)	MARGIN (dB)	ANTENNA HEIGHT (m)	TABLE ANGLE (Degree)	RAW VALUE (dBuV)	CORRECTION FACTOR (dB/m)
1	*2480.00	96.86 PK			3.82 V	156	97.84	-0.98
2	*2480.00	95.98 AV			3.82 V	156	96.96	-0.98
3	2483.50	61.59 PK	74.00	-12.41	3.82 V	156	62.57	-0.98
4	2483.50	40.87 AV	54.00	-13.13	3.82 V	156	41.85	-0.98
5	4960.00	48.60 PK	74.00	-25.40	2.34 V	169	43.57	5.03
6	4960.00	40.92 AV	54.00	-13.08	2.34 V	169	35.89	5.03

REMARKS:

1. Emission Level(dBuV/m) = Raw Value(dBuV) + Correction Factor(dB/m)
2. Correction Factor(dB/m) = Antenna Factor(dB/m) + Cable Factor(dB) – Pre-Amplifier Factor(dB)
3. The other emission levels were very low against the limit.
4. Margin value = Emission Level – Limit value
5. " * ": Fundamental frequency.

BELOW 1GHz WORST-CASE DATA

CHANNEL	TX Channel 39	DETECTOR FUNCTION	Quasi-Peak (QP)
FREQUENCY RANGE	9kHz ~ 1GHz		

ANTENNA POLARITY & TEST DISTANCE: HORIZONTAL AT 3 M								
NO.	FREQ. (MHz)	EMISSION LEVEL (dBuV/m)	LIMIT (dBuV/m)	MARGIN (dB)	ANTENNA HEIGHT (m)	TABLE ANGLE (Degree)	RAW VALUE (dBuV)	CORRECTION FACTOR (dB/m)
1	45.71	17.16 QP	40.00	-22.84	2.36 H	205	24.56	-7.40
2	156.15	20.68 QP	43.50	-22.82	2.20 H	360	27.60	-6.92
3	257.80	32.03 QP	46.00	-13.97	1.98 H	187	38.93	-6.90
4	288.70	33.41 QP	46.00	-12.59	1.64 H	213	38.97	-5.56
5	343.26	27.99 QP	46.00	-18.01	1.11 H	352	32.62	-4.63
6	611.90	25.12 QP	46.00	-20.88	1.29 H	109	24.12	1.00

REMARKS:

1. Emission Level(dBuV/m) = Raw Value(dBuV) + Correction Factor(dB/m)
2. Correction Factor(dB/m) = Antenna Factor(dB/m) + Cable Factor(dB) – Pre-Amplifier Factor(dB)
3. The other emission levels were very low against the limit.
4. Margin value = Emission Level – Limit value
5. The emission levels were very low against the limit of frequency range 9kHz ~ 30MHz :the amplitude of spurious emissions attenuated more than 20 dB below the permissible value to be report.

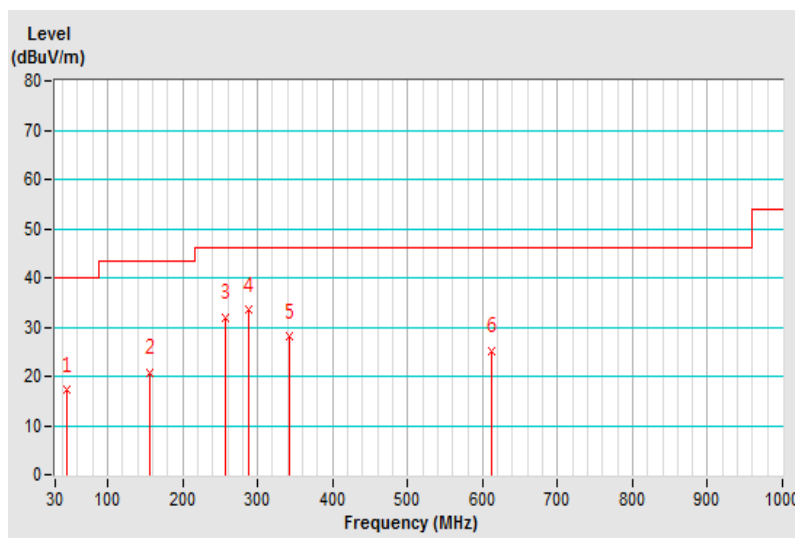

CHANNEL	TX Channel 39	DETECTOR FUNCTION	Quasi-Peak (QP)
FREQUENCY RANGE	9kHz ~ 1GHz		

ANTENNA POLARITY & TEST DISTANCE: VERTICAL AT 3 M								
NO.	FREQ. (MHz)	EMISSION LEVEL (dBuV/m)	LIMIT (dBuV/m)	MARGIN (dB)	ANTENNA HEIGHT (m)	TABLE ANGLE (Degree)	RAW VALUE (dBuV)	CORRECTION FACTOR (dB/m)
1	41.59	18.84 QP	40.00	-21.16	1.34 V	103	26.58	-7.74
2	61.96	18.35 QP	40.00	-21.65	1.84 V	315	26.65	-8.30
3	117.54	18.08 QP	43.50	-25.42	1.04 V	137	27.62	-9.54
4	241.80	19.30 QP	46.00	-26.70	1.31 V	278	26.82	-7.52
5	288.84	22.75 QP	46.00	-23.25	1.17 V	301	28.29	-5.54
6	434.25	20.97 QP	46.00	-25.03	1.28 V	160	23.40	-2.43

REMARKS:

1. Emission Level(dBuV/m) = Raw Value(dBuV) + Correction Factor(dB/m)
2. Correction Factor(dB/m) = Antenna Factor(dB/m) + Cable Factor(dB) – Pre-Amplifier Factor(dB)
3. The other emission levels were very low against the limit.
4. Margin value = Emission Level – Limit value
5. The emission levels were very low against the limit of frequency range 9kHz ~ 30MHz :the amplitude of spurious emissions attenuated more than 20 dB below the permissible value to be report.

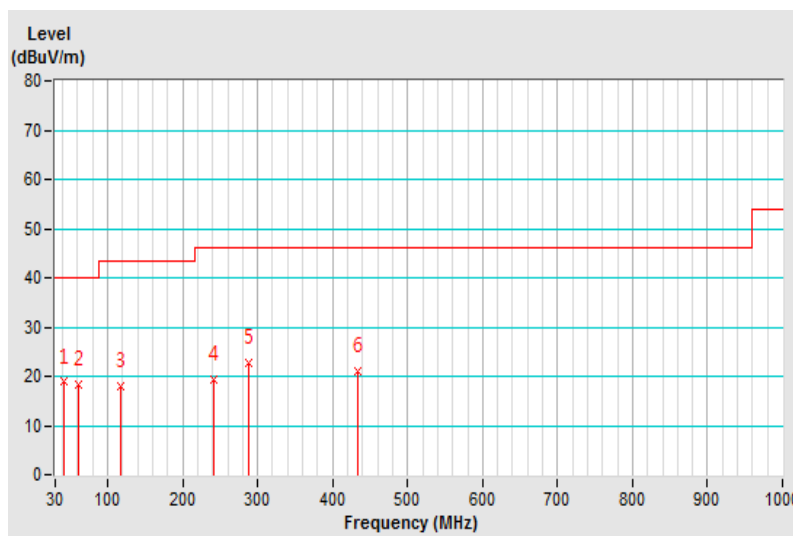

4.2 Conducted Emission Measurement

4.2.1 Limits of Conducted Emission Measurement

Frequency (MHz)	Conducted Limit (dBuV)	
	Quasi-peak	Average
0.15 - 0.5	66 - 56	56 - 46
0.50 - 5.0	56	46
5.0 - 30.0	60	50

Note: 1. The lower limit shall apply at the transition frequencies.

2. The limit decreases in line with the logarithm of the frequency in the range of 0.15 to 0.50MHz.

4.2.2 Test Instruments

Description & Manufacturer	Model No.	Serial No.	Cal. Date	Cal. Due
ROHDE & SCHWARZ TEST RECEIVER	ESCS 30	838251/021	Nov. 1, 2018	Oct. 31, 2019
ROHDE & SCHWARZ Artificial Mains Network (For EUT)	ENV216	101195	May 2, 2018	May 1, 2019
LISN With Adapter (for EUT)	AD10	C03Ada-002	May 2, 2018	May 1, 2019
EMCO L.I.S.N. (For peripherals)	3825/2	9504-2359	Jul. 26, 2018	Jul. 25, 2019
SCHWARZBECK Artificial Mains Network (For EUT)	NNLK8129	8129229	May 3, 2018	May 2, 2019
Software	Cond_V7.3.7.4	NA	NA	NA
RF cable (JYEBAO) With 10dB PAD	5D-FB	Cable-C03.01	Sep. 18, 2018	Sep. 17, 2019
LYNICS Terminator (For EMCO LISN)	0900510	E1-01-300	Jan. 25, 2019	Jan. 24, 2020
LYNICS Terminator (For EMCO LISN)	0900510	E1-01-301	Jan. 25, 2019	Jan. 24, 2020
ROHDE & SCHWARZ Artificial Mains Network (For TV EUT)	ESH3-Z5	100220	Nov. 21, 2018	Nov. 20, 2019
LISN With Adapter (for TV EUT)	100220	N/A	Nov. 21, 2018	Nov. 20, 2019

Notes: 1. The calibration interval of the above test instruments is 12 months and the calibrations are traceable to NML/ROC and NIST/USA.

2. The test was performed in Shielded Room No. 3.

3. Tested Date: Feb. 11, 2019

4.2.3 Test Procedure

- The EUT was placed 0.4 meters from the conducting wall of the shielded room with EUT being connected to the power mains through a line impedance stabilization network (LISN). Other support units were connected to the power mains through another LISN. The two LISNs provide 50 ohm/ 50uH of coupling impedance for the measuring instrument.
- Both lines of the power mains connected to the EUT were checked for maximum conducted interference.
- The frequency range from 150kHz to 30MHz was searched. Emission levels under (Limit - 20dB) was not recorded.

NOTE: All modes of operation were investigated and the worst-case emissions are reported.

4.2.4 Deviation from Test Standard

No deviation.

4.2.5 Test Setup

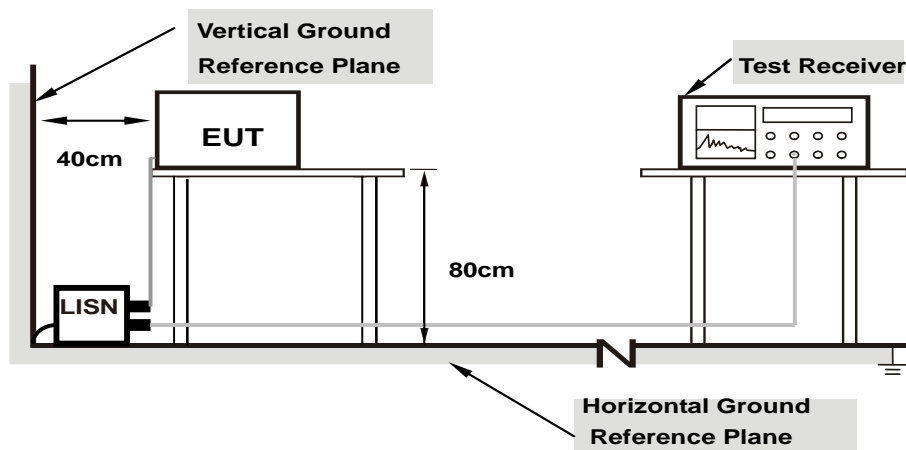

Note: 1.Support units were connected to second LISN.

For the actual test configuration, please refer to the attached file (Test Setup Photo).

4.2.6 EUT Operating Condition

For Mode B:

- Connected the EUT with the Notebook.
- Set the EUT under charging condition continuously.

For Mode C:

- Connected the EUT with the Adapter.
- Set the EUT under charging condition continuously.

4.2.7 Test Results

CH 39

Phase	Line (L)	Detector Function	Quasi-Peak (QP) / Average (AV)
Test Mode	Mode B		

Phase Of Power : Line (L)										
No	Frequency (MHz)	Correction Factor (dB)	Reading Value (dBuV)		Emission Level (dBuV)		Limit (dBuV)		Margin (dB)	
			Q.P.	AV.	Q.P.	AV.	Q.P.	AV.	Q.P.	AV.
1	0.16953	9.68	38.62	11.46	48.30	21.14	64.98	54.98	-16.68	-33.84
2	0.23984	9.67	31.86	15.77	41.53	25.44	62.10	52.10	-20.57	-26.66
3	0.72031	9.71	20.46	12.41	30.17	22.12	56.00	46.00	-25.83	-23.88
4	2.63672	9.79	27.08	18.41	36.87	28.20	56.00	46.00	-19.13	-17.80
5	7.39453	9.89	26.13	19.77	36.02	29.66	60.00	50.00	-23.98	-20.34
6	20.70313	9.98	16.53	11.36	26.51	21.34	60.00	50.00	-33.49	-28.66

Remarks:

1. Q.P. and AV. are abbreviations of quasi-peak and average individually.
2. The emission levels of other frequencies were very low against the limit.
3. Margin value = Emission level – Limit value
4. Correction factor = Insertion loss + Cable loss
5. Emission Level = Correction Factor + Reading Value

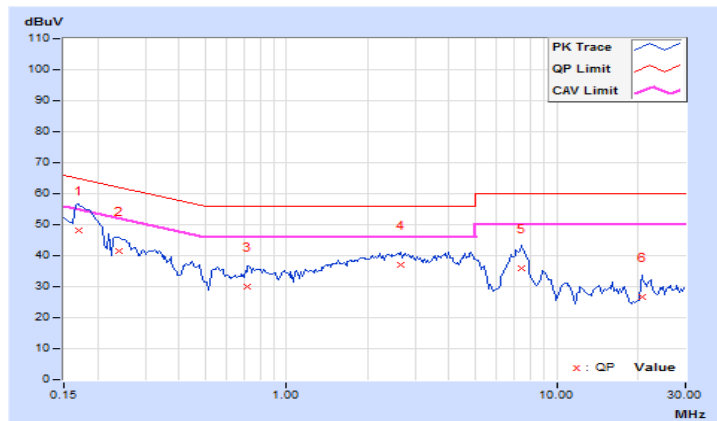

Phase	Neutral (N)	Detector Function	Quasi-Peak (QP) / Average (AV)
Test Mode	Mode B		

Phase Of Power : Neutral (N)										
No	Frequency (MHz)	Correction Factor (dB)	Reading Value (dBuV)		Emission Level (dBuV)		Limit (dBuV)		Margin (dB)	
			Q.P.	AV.	Q.P.	AV.	Q.P.	AV.	Q.P.	AV.
1	0.17734	9.67	36.27	12.76	45.94	22.43	64.61	54.61	-18.67	-32.18
2	0.18516	9.67	39.77	21.72	49.44	31.39	64.25	54.25	-14.81	-22.86
3	0.41563	9.69	23.37	10.42	33.06	20.11	57.54	47.54	-24.48	-27.43
4	2.43359	9.79	29.31	18.14	39.10	27.93	56.00	46.00	-16.90	-18.07
5	4.20313	9.84	27.62	17.85	37.46	27.69	56.00	46.00	-18.54	-18.31
6	20.87500	10.04	25.03	19.72	35.07	29.76	60.00	50.00	-24.93	-20.24

Remarks:

1. Q.P. and AV. are abbreviations of quasi-peak and average individually.
2. The emission levels of other frequencies were very low against the limit.
3. Margin value = Emission level – Limit value
4. Correction factor = Insertion loss + Cable loss
5. Emission Level = Correction Factor + Reading Value

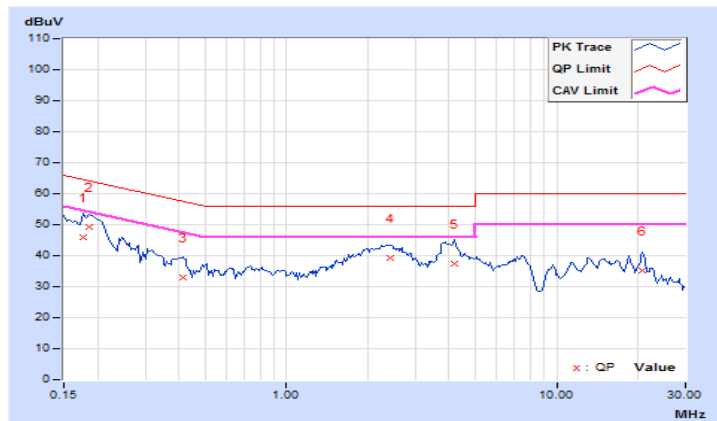

CH 39

Phase	Line (L)	Detector Function	Quasi-Peak (QP) / Average (AV)
Test Mode	Mode C		

Phase Of Power : Line (L)										
No	Frequency (MHz)	Correction Factor (dB)	Reading Value (dBuV)		Emission Level (dBuV)		Limit (dBuV)		Margin (dB)	
			Q.P.	AV.	Q.P.	AV.	Q.P.	AV.	Q.P.	AV.
1	0.15000	9.68	35.08	15.50	44.76	25.18	66.00	56.00	-21.24	-30.82
2	0.42734	9.69	24.97	15.76	34.66	25.45	57.30	47.30	-22.64	-21.85
3	0.87266	9.72	26.17	17.37	35.89	27.09	56.00	46.00	-20.11	-18.91
4	1.68750	9.76	23.04	13.54	32.80	23.30	56.00	46.00	-23.20	-22.70
5	3.61328	9.82	21.72	12.54	31.54	22.36	56.00	46.00	-24.46	-23.64
6	16.60938	9.96	18.05	8.70	28.01	18.66	60.00	50.00	-31.99	-31.34

Remarks:

1. Q.P. and AV. are abbreviations of quasi-peak and average individually.
2. The emission levels of other frequencies were very low against the limit.
3. Margin value = Emission level – Limit value
4. Correction factor = Insertion loss + Cable loss
5. Emission Level = Correction Factor + Reading Value

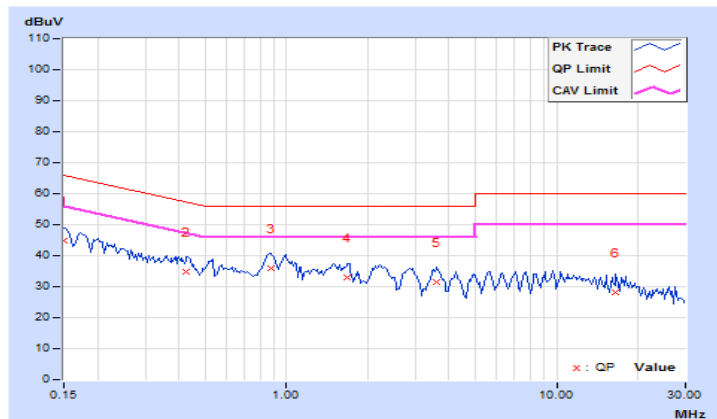

Phase	Neutral (N)	Detector Function	Quasi-Peak (QP) / Average (AV)
Test Mode	Mode C		

Phase Of Power : Neutral (N)										
No	Frequency (MHz)	Correction Factor (dB)	Reading Value (dBuV)		Emission Level (dBuV)		Limit (dBuV)		Margin (dB)	
			Q.P.	AV.	Q.P.	AV.	Q.P.	AV.	Q.P.	AV.
1	0.15391	9.68	36.01	13.94	45.69	23.62	65.79	55.79	-20.10	-32.17
2	0.28281	9.68	25.59	6.74	35.27	16.42	60.73	50.73	-25.46	-34.31
3	0.87656	9.72	22.96	13.21	32.68	22.93	56.00	46.00	-23.32	-23.07
4	0.98594	9.73	22.86	12.77	32.59	22.50	56.00	46.00	-23.41	-23.50
5	2.19531	9.78	19.89	10.01	29.67	19.79	56.00	46.00	-26.33	-26.21
6	4.96094	9.86	16.93	8.09	26.79	17.95	56.00	46.00	-29.21	-28.05
7	12.40625	9.96	18.25	5.41	28.21	15.37	60.00	50.00	-31.79	-34.63

Remarks:

1. Q.P. and AV. are abbreviations of quasi-peak and average individually.
2. The emission levels of other frequencies were very low against the limit.
3. Margin value = Emission level – Limit value
4. Correction factor = Insertion loss + Cable loss
5. Emission Level = Correction Factor + Reading Value

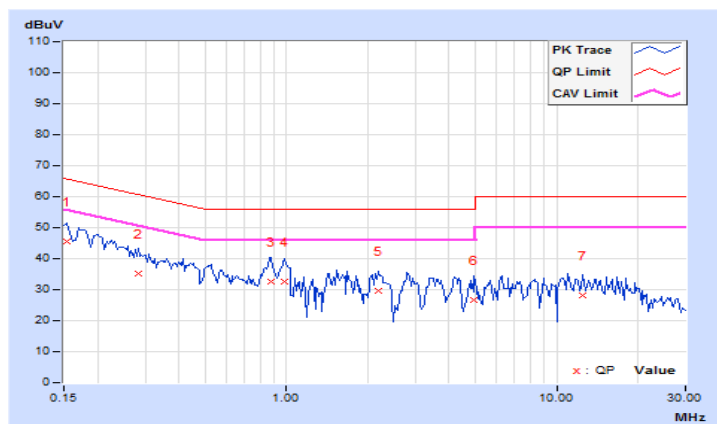

4.3 6dB Bandwidth Measurement

4.3.1 Limits of 6dB Bandwidth Measurement

The minimum of 6dB Bandwidth Measurement is 0.5 MHz.

4.3.2 Test Setup

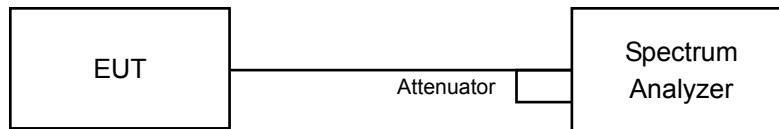

4.3.3 Test Instruments

Refer to section 4.1.2 to get information of above instrument.

4.3.4 Test Procedure

- a. Set resolution bandwidth (RBW) = 100kHz
- b. Set the video bandwidth (VBW) $\geq 3 \times$ RBW, Detector = Peak.
- c. Trace mode = max hold.
- d. Sweep = auto couple.
- e. Measure the maximum width of the emission that is constrained by the frequencies associated with the two amplitude points (upper and lower) that are attenuated by 6 dB relative to the maximum level measured in the fundamental emission

4.3.5 Deviation from Test Standard

No deviation.

4.3.6 EUT Operating Conditions

The software provided by client to enable the EUT under transmission condition continuously at lowest, middle and highest channel frequencies individually.

4.3.7 Test Result

Mode A

Channel	Frequency (MHz)	6dB Bandwidth (MHz)	Minimum Limit (MHz)	Pass / Fail
0	2402	0.70	0.5	Pass
19	2440	0.71	0.5	Pass
39	2480	0.70	0.5	Pass

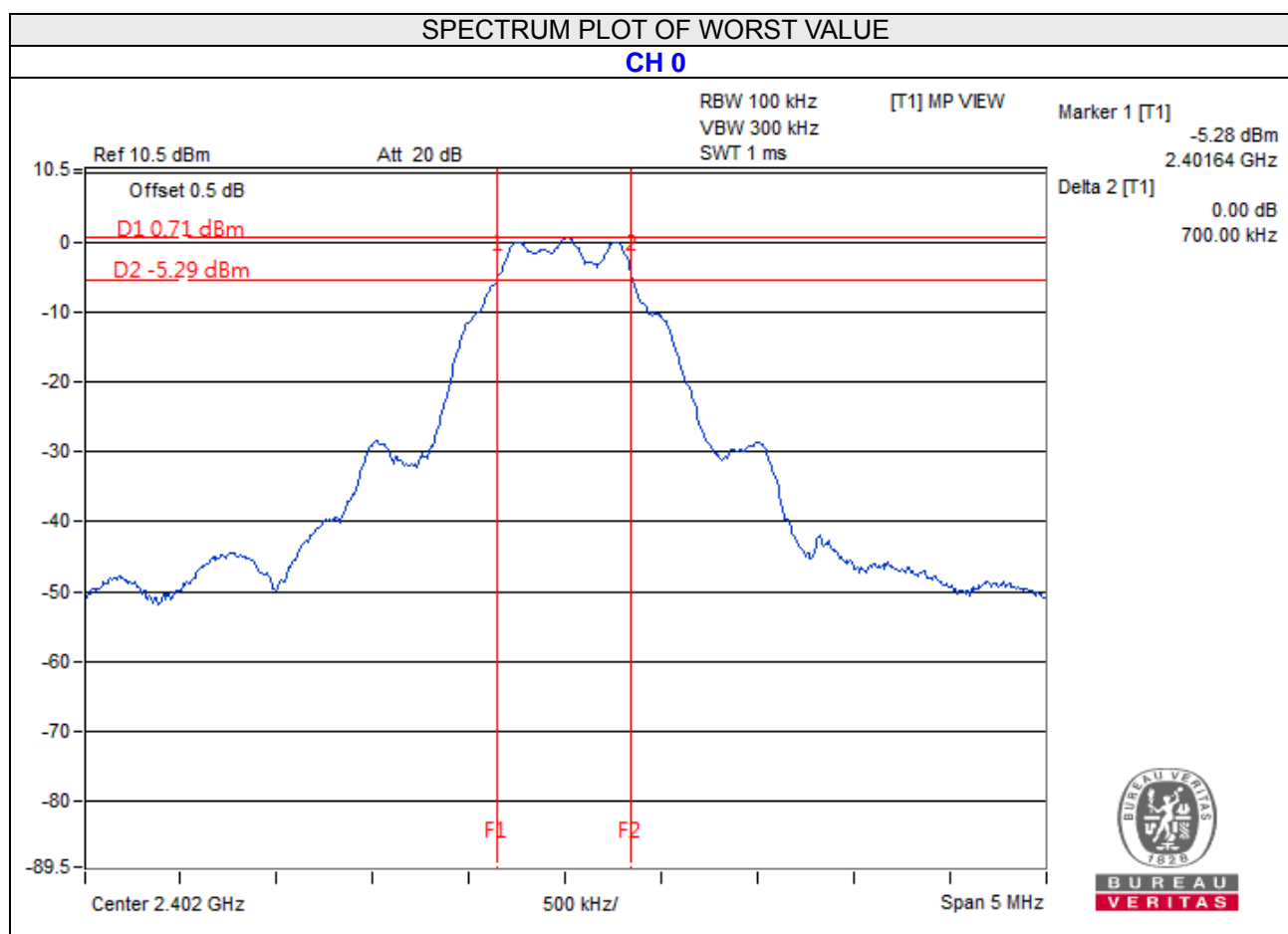

4.4 Conducted Output Power Measurement

4.4.1 Limits OF Conducted Output Power Measurement

For systems using digital modulation in the 2400–2483.5 MHz bands: 1 Watt (30dBm)

4.4.2 Test Setup

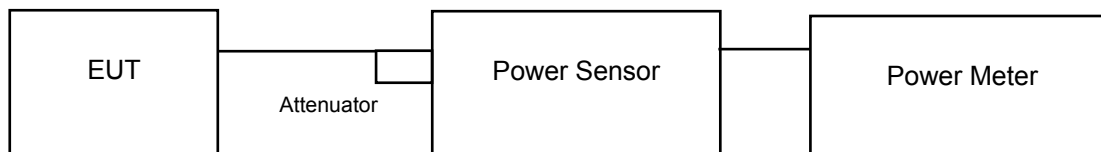

4.4.3 Test Instruments

Refer to section 4.1.2 to get information of above instrument.

4.4.4 Test Procedures

A peak power sensor was used on the output port of the EUT. A power meter was used to read the response of the peak power sensor. Record the power level.

Average power sensor was used to perform output power measurement, trigger and gating function of wide band power meter is enabled to measure max output power of TX on burst. Duty factor is not added to measured value.

4.4.5 Deviation from Test Standard

No deviation.

4.4.6 EUT Operating Conditions

Same as Item 4.3.6.

4.4.7 Test Results

Mode A

FOR PEAK POWER

Channel	Frequency (MHz)	Peak Power (mW)	Peak Power (dBm)	Limit (dBm)	Pass/Fail
0	2402	1.371	1.37	30	Pass
19	2440	1.321	1.21	30	Pass
39	2480	1.268	1.03	30	Pass

FOR AVERAGE POWER

Channel	Frequency (MHz)	Average Power (mW)	Average Power (dBm)
0	2402	1.340	1.27
19	2440	1.288	1.10
39	2480	1.225	0.88

4.5 Power Spectral Density Measurement

4.5.1 Limits of Power Spectral Density Measurement

The Maximum of Power Spectral Density Measurement is 8dBm.

4.5.2 Test Setup

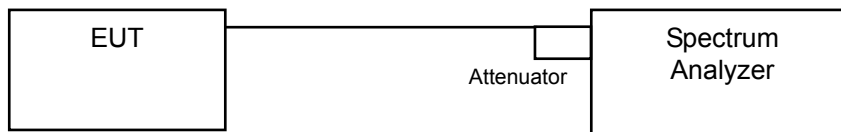

4.5.3 Test Instruments

Refer to section 4.1.2 to get information of above instrument.

4.5.4 Test Procedure

- a. Set analyzer center frequency to DTS channel center frequency.
- b. Set the span to 1.5 times the DTS bandwidth.
- c. Set the RBW to: $3 \text{ kHz} \leq \text{RBW} \leq 100 \text{ kHz}$.
- d. Set the VBW $\geq 3 \times \text{RBW}$.
- e. Detector = peak.
- f. Sweep time = auto couple.
- g. Trace mode = max hold.
- h. Allow trace to fully stabilize.
- i. Use the peak marker function to determine the maximum amplitude level within the RBW.

4.5.5 Deviation from Test Standard

No deviation.

4.5.6 EUT Operating Condition

Same as Item 4.3.6

4.5.7 Test Results

Mode A

Channel	Freq. (MHz)	PSD (dBm/3kHz)	Limit (dBm/3kHz)	PASS /FAIL
0	2402	-10.86	8	PASS
19	2440	-11.10	8	PASS
39	2480	-11.33	8	PASS

SPECTRUM PLOT OF WORST VALUE

CH 0

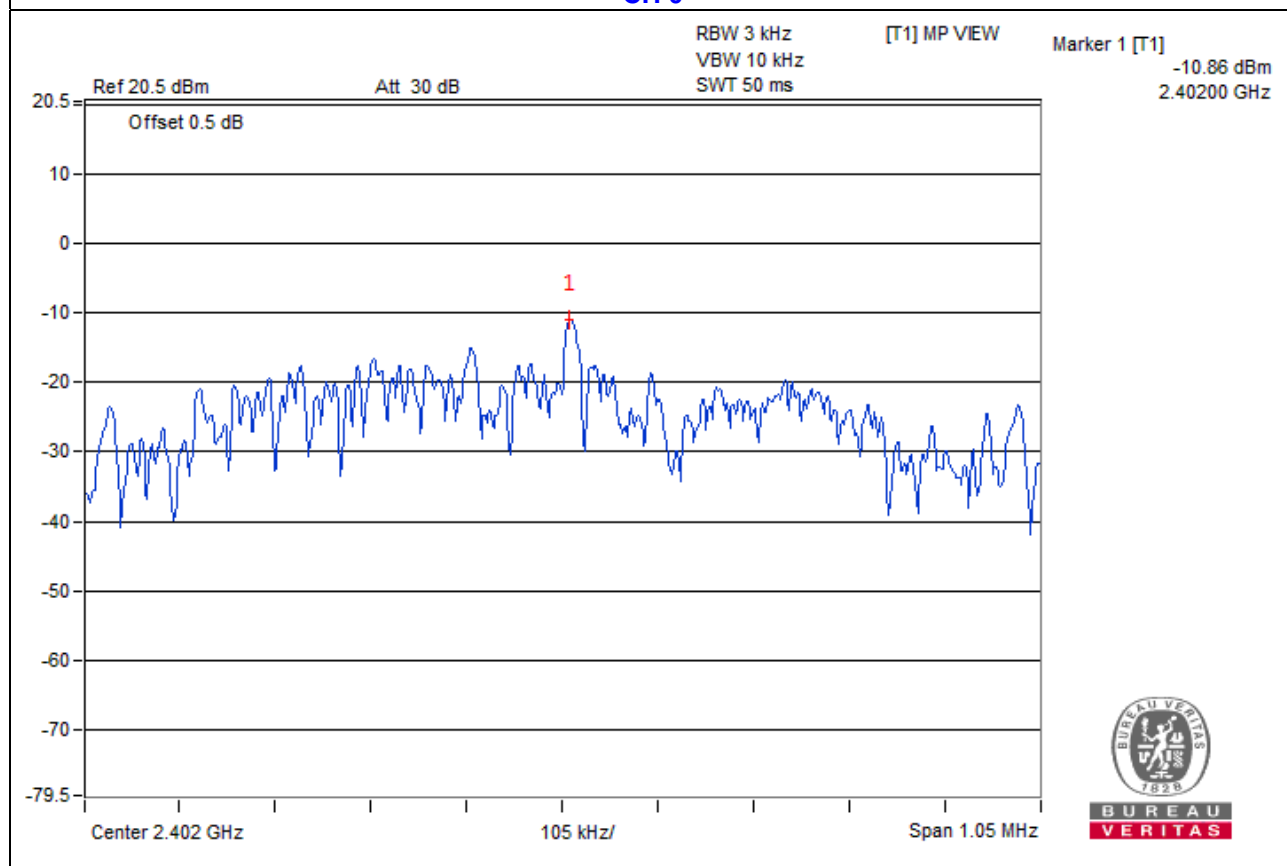

4.6 Conducted Out of Band Emission Measurement

4.6.1 Limits of Conducted Out of Band Emission Measurement

Below -20dB of the highest emission level of operating band (in 100kHz Resolution Bandwidth).

4.6.2 Test Setup

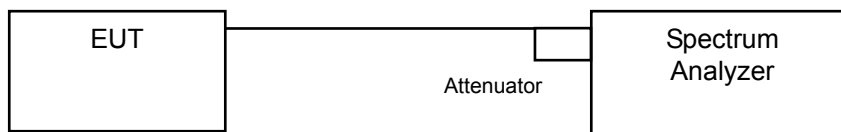

4.6.3 Test Instruments

Refer to section 4.1.2 to get information of above instrument.

4.6.4 Test Procedure

MEASUREMENT PROCEDURE REF

1. Set the RBW = 100 kHz.
2. Set the VBW \geq 300 kHz.
3. Detector = peak.
4. Sweep time = auto couple.
5. Trace mode = max hold.
6. Allow trace to fully stabilize.
7. Use the peak marker function to determine the maximum power level in any 100 kHz band segment within the fundamental EBW.

MEASUREMENT PROCEDURE OOB

1. Set RBW = 100 kHz.
2. Set VBW \geq 300 kHz.
3. Detector = peak.
4. Sweep = auto couple.
5. Trace Mode = max hold.
6. Allow trace to fully stabilize.
7. Use the peak marker function to determine the maximum amplitude level.

4.6.5 Deviation from Test Standard

No deviation.

4.6.6 EUT Operating Condition

Same as Item 4.3.6

4.6.7 Test Results

Mode A

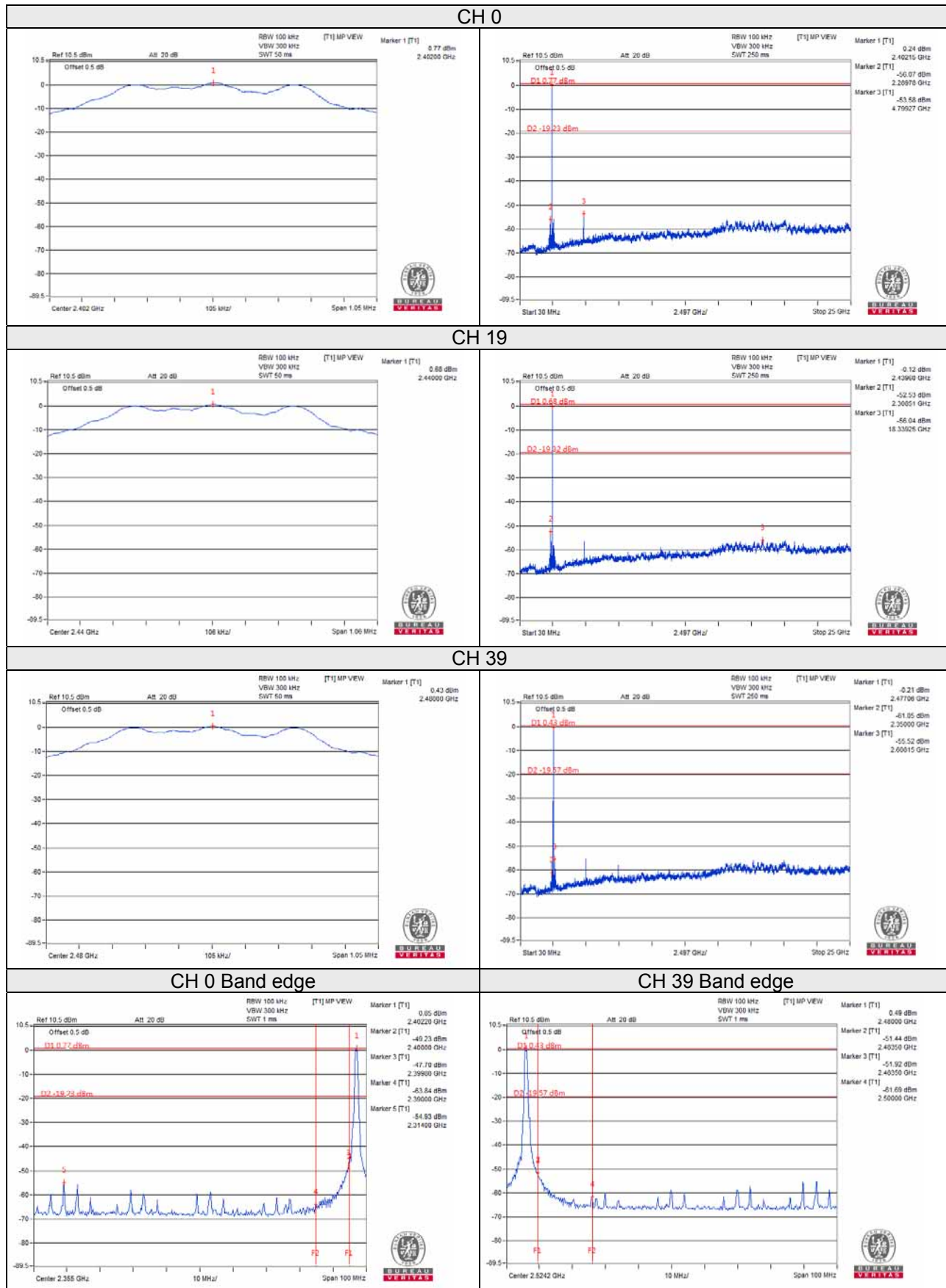

5 Pictures of Test Arrangements

Please refer to the attached file (Test Setup Photo).

Appendix – Information of the Testing Laboratories

We, Bureau Veritas Consumer Products Services (H.K.) Ltd., Taoyuan Branch, were founded in 1988 to provide our best service in EMC, Radio, Telecom and Safety consultation. Our laboratories are FCC recognized accredited test firms and accredited according to ISO/IEC 17025.

If you have any comments, please feel free to contact us at the following:

Lin Kou EMC/RF Lab

Tel: 886-2-26052180

Fax: 886-2-26051924

Hsin Chu EMC/RF/Telecom Lab

Tel: 886-3-6668565

Fax: 886-3-6668323

Hwa Ya EMC/RF/Safety Lab

Tel: 886-3-3183232

Fax: 886-3-3270892

Email: service.adt@tw.bureauveritas.com

Web Site: www.bureauveritas-adt.com

The address and road map of all our labs can be found in our web site also.

--- END ---