

FCC Test Report

Report No.: RF171206D09-1

FCC ID: 2AAFMRGP0051

Test Model: RGP0051

Received Date: Dec. 6, 2017

Test Date: Dec. 6 ~ 8, 2017

Issued Date: Dec. 15, 2017

Applicant: Corsair Memory, Inc.

Address: No.69, Sec. 2, Guangfu Rd., Sanchong Dist., New Taipei City 241,
Taiwan(R.O.C.)

Issued By: Bureau Veritas Consumer Products Services (H.K.) Ltd., Taoyuan Branch

Lab Address: No. 47-2, 14th Ling, Chia Pau Vil., Lin Kou Dist., New Taipei City, Taiwan
(R.O.C.)

**FCC Registration /
Designation Number:** 198487 / TW2021



This report is for your exclusive use. Any copying or replication of this report to or for any other person or entity, or use of our name or trademark, is permitted only with our prior written permission. This report sets forth our findings solely with respect to the test samples identified herein. The results set forth in this report are not indicative or representative of the quality or characteristics of the lot from which a test sample was taken or any similar or identical product unless specifically and expressly noted. Our report includes all of the tests requested by you and the results thereof based upon the information that you provided to us. You have 60 days from date of issuance of this report to notify us of any material error or omission caused by our negligence, provided, however, that such notice shall be in writing and shall specifically address the issue you wish to raise. A failure to raise such issue within the prescribed time shall constitute your unqualified acceptance of the completeness of this report, the tests conducted and the correctness of the report contents. Unless specific mention, the uncertainty of measurement has been explicitly taken into account to declare the compliance or non-compliance to the specification. The report must not be used by the client to claim product certification, approval, or endorsement by TAF or any government agencies.

Table of Contents

Release Control Record	3
1 Certificate of Conformity	4
2 Summary of Test Results	5
2.1 Measurement Uncertainty	5
2.2 Modification Record	5
3 General Information	6
3.1 General Description of EUT	6
3.2 Description of Test Modes	7
3.2.1 Test Mode Applicability and Tested Channel Detail	8
3.3 Description of Support Units	10
3.3.1 Configuration of System under Test	10
3.4 General Description of Applied Standards	12
4 Test Types and Results	13
4.1 Radiated Emission and Bandedge Measurement.....	13
4.1.1 Limits of Radiated Emission and Bandedge Measurement	13
4.1.2 Test Instruments	14
4.1.3 Test Procedures.....	15
4.1.4 Deviation from Test Standard	15
4.1.5 Test Setup.....	16
4.1.6 EUT Operating Conditions.....	17
4.1.7 Test Results	18
4.2 Conducted Emission Measurement	23
4.2.1 Limits of Conducted Emission Measurement	23
4.2.2 Test Instruments	23
4.2.3 Test Procedures.....	24
4.2.4 Deviation from Test Standard	24
4.2.5 Test Setup.....	24
4.2.6 EUT Operating Conditions.....	24
4.2.7 Test Results	25
4.3 Channel Bandwidth	29
4.3.1 Test Setup.....	29
4.3.2 Test Instruments	29
4.3.3 Test Procedure	29
4.3.4 Deviation from Test Standard	29
4.3.5 EUT Operating Condition	29
4.3.6 Test Results	30
5 Pictures of Test Arrangements	31
Appendix – Information on the Testing Laboratories	32

Release Control Record

Issue No.	Description	Date Issued
RF171206D09-1	Original release.	Dec. 15, 2017

1 Certificate of Conformity

Product: Wireless Mouse

Brand: Corsair

Test Model: RGP0051

Sample Status: Engineering sample

Applicant: Corsair Memory, Inc.

Test Date: Dec. 6 ~ 8, 2017

Standards: 47 CFR FCC Part 15, Subpart C (Section 15.249)
ANSI C63.10: 2013

The above equipment has been tested by **Bureau Veritas Consumer Products Services (H.K.) Ltd., Taoyuan Branch**, and found compliance with the requirement of the above standards. The test record, data evaluation & Equipment Under Test (EUT) configurations represented herein are true and accurate accounts of the measurements of the sample's EMC characteristics under the conditions specified in this report.

Prepared by :

Annie Chang

Date:

Dec. 15, 2017

Annie Chang / Senior Specialist

Approved by :

Rex Lai

Date:

Dec. 15, 2017

Rex Lai / Assistant Technical Manager

2 Summary of Test Results

47 CFR FCC Part 15, Subpart C (SECTION 15.249)			
FCC Clause	Test Item	Result	Remarks
15.207	AC Power Conducted Emission	PASS	Meet the requirement of limit. Minimum passing margin is -10.44 dB at 0.49375 MHz
15.215	Channel Bandwidth Measurement	PASS	Meet the requirement.
15.209 15.249 15.249 (d)	Radiated Emission Test Band Edge Measurement Limit: 50dB less than the peak value of fundamental frequency or meet radiated emission limit in section 15.209	PASS	Meet the requirement of limit. Minimum passing margin is -12.25dB at 948.36MHz.

2.1 Measurement Uncertainty

Where relevant, the following measurement uncertainty levels have been estimated for tests performed on the EUT as specified in CISPR 16-4-2:

Measurement	Frequency	Expanded Uncertainty (k=2) (\pm)
Conducted Emissions at mains ports	150kHz ~ 30MHz	2.77 dB
Radiated Emissions up to 1 GHz	9kHz ~ 30MHz	2.38 dB
	30MHz ~ 1000MHz	5.54 dB
Radiated Emissions above 1 GHz	Above 1GHz	5.48 dB

2.2 Modification Record

There were no modifications required for compliance.

3 General Information

3.1 General Description of EUT

Product	Wireless Mouse
Brand	Corsair
Test Model	RGP0051
Status of EUT	Engineering sample
Power Supply Rating	3.7Vdc from battery (For Wireless mode) 5Vdc from USB interface (For Wired mode and Charging mode)
Modulation Type	GFSK
Operating Frequency	2403MHz ~ 2480MHz
Number of Channel	78
Antenna Type	Printed antenna with -0.33dBi gain
Antenna Connector	N/A
Accessory Device	N/A
Data Cable Supplied	Shielded USB cable (1.8m)

Note:

1. The EUT has two types:

Type	Model	Function
Type 1	RGP0051	BTLE, GFSK, Qi(RX)
Type 2	RGP0051	BTLE, GFSK

The above two type were pre-tested and **Type 1** was the worst case for final test.

2. For Spurious Emissions test, following modes were pre-tested:

Mode A: Operating Mode (EUT Stand-alone)

Mode B: Charging Mode (Powered from Notebook)

Mode C: Charging Mode (Powered from Adapter)

The worst emission level was found when the EUT was tested under **Mode A**, therefore, only its test data was recorded in this report.

3. The above EUT information is declared by manufacturer and for more detailed features description, please refer to the manufacturer's specifications or user's manual.

3.2 Description of Test Modes

78 channels are provided to this EUT:

CHANNEL	FREQ. (MHz)	CHANNEL	FREQ. (MHz)	CHANNEL	FREQ. (MHz)	CHANNEL	FREQ. (MHz)
1	2403	21	2423	41	2443	61	2463
2	2404	22	2424	42	2444	62	2464
3	2405	23	2425	43	2445	63	2465
4	2406	24	2426	44	2446	64	2466
5	2407	25	2427	45	2447	65	2467
6	2408	26	2428	46	2448	66	2468
7	2409	27	2429	47	2449	67	2469
8	2410	28	2430	48	2450	68	2470
9	2411	29	2431	49	2451	69	2471
10	2412	30	2432	50	2452	70	2472
11	2413	31	2433	51	2453	71	2473
12	2414	32	2434	52	2454	72	2474
13	2415	33	2435	53	2455	73	2475
14	2416	34	2436	54	2456	74	2476
15	2417	35	2437	55	2457	75	2477
16	2418	36	2438	56	2458	76	2478
17	2419	37	2439	57	2459	77	2479
18	2420	38	2440	58	2460	78	2480
19	2421	39	2441	59	2461		
20	2422	40	2442	60	2462		

3.2.1 Test Mode Applicability and Tested Channel Detail

EUT CONFIGURE MODE	APPLICABLE TO				DESCRIPTION
	RE \geq 1G	RE $<$ 1G	PLC	APCM	
A	√	√	-	√	Operating Mode (EUT Stand-alone)
B	√	√	√	-	Charging Mode (Powered from Notebook)
C	-	-	√	-	Charging Mode (Powered from Adapter)

Where **RE \geq 1G**: Radiated Emission above 1GHz & Bandedge Measurement
RE $<$ 1G: Radiated Emission below 1GHz
PLC: Power Line Conducted Emission
APCM: Antenna Port Conducted Measurement

Radiated Emission Test (Above 1GHz):

- Pre-Scan has been conducted to determine the worst-case mode from all possible combinations between available modulations, data rates and antenna ports (if EUT with antenna diversity architecture).
- Following channel(s) was (were) selected for the final test as listed below.

EUT CONFIGURE MODE	AVAILABLE CHANNEL	TESTED CHANNEL	MODULATION TYPE
A	1 to 78	1, 39, 78	GFSK

Radiated Emission Test (Below 1GHz):

- Pre-Scan has been conducted to determine the worst-case mode from all possible combinations between available modulations, data rates and antenna ports (if EUT with antenna diversity architecture).
- Following channel(s) was (were) selected for the final test as listed below.

EUT CONFIGURE MODE	AVAILABLE CHANNEL	TESTED CHANNEL	MODULATION TYPE
A	1 to 78	1	GFSK

Power Line Conducted Emission Test:

- Pre-Scan has been conducted to determine the worst-case mode from all possible combinations between available modulations, data rates and antenna ports (if EUT with antenna diversity architecture).
- Following channel(s) was (were) selected for the final test as listed below.

EUT CONFIGURE MODE	AVAILABLE CHANNEL	TESTED CHANNEL	MODULATION TYPE
B~C	1 to 78	1,	GFSK

Antenna Port Conducted Measurement:

- This item includes all test value of each mode, but only includes spectrum plot of worst value of each mode.
- Pre-Scan has been conducted to determine the worst-case mode from all possible combinations between available modulations, data rates and antenna ports (if EUT with antenna diversity architecture).
- Following channel(s) was (were) selected for the final test as listed below.

EUT CONFIGURE MODE	AVAILABLE CHANNEL	TESTED CHANNEL	MODULATION TYPE
A	1 to 78	1, 39, 78	GFSK

Test Condition:

APPLICABLE TO	EUT CONFIGURE MODE	ENVIRONMENTAL CONDITIONS	INPUT POWER	TESTED BY
RE \geq 1G	A	19deg. C, 77%RH	3.7Vdc	Ian Chang
RE<1G	A	19deg. C, 77%RH	3.7Vdc	Ian Chang
PLC	B	17deg. C, 75%RH	120Vac, 60Hz(System)	Ian Chang
	C	17deg. C, 75%RH	120Vac, 60Hz(Adapter)	Ian Chang
APCM	A	25deg. C, 76%RH	3.7Vdc	Saxon Lee

3.3 Description of Support Units

The EUT has been tested as an independent unit together with other necessary accessories or support units. The following support units or accessories were used to form a representative test configuration during the tests.

ID	Product	Brand	Model No.	Serial No.	FCC ID	Remarks
A.	Notebook	DELL	E5410	BW33YM1	FCC DoC Approved	Provided by Lab
B.	AC Adapter	HTC	TC U250	N/A	N/A	Provided by Lab

Note: All power cords of the above support units are non-shielded (1.8m).

ID	Descriptions	Qty.	Length (m)	Shielding (Yes/No)	Cores (Qty.)	Remarks
1.	USB cable	1	1.8	Y	0	Supplied by client

Note: The core(s) is(are) originally attached to the cable(s).

3.3.1 Configuration of System under Test

Mode A:

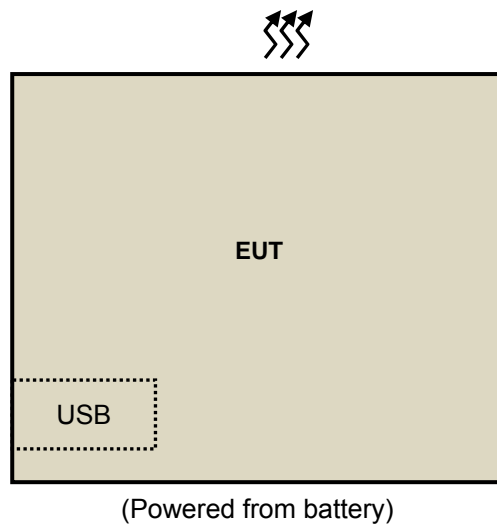

Mode B:

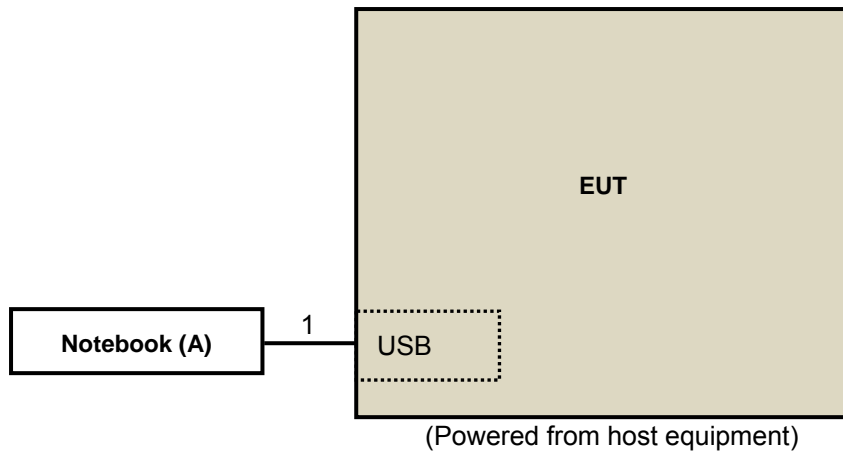

Mode C:

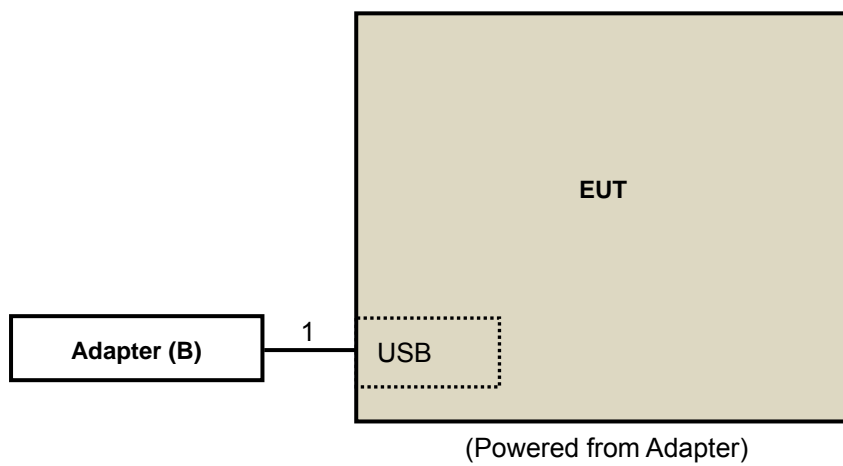

3.4 General Description of Applied Standards

The EUT is a RF Product. According to the specifications of the manufacturer, it must comply with the requirements of the following standards:

FCC Part 15, Subpart C (15.249)

ANSI C63.10-2013

All test items have been performed and recorded as per the above standards.

4 Test Types and Results

4.1 Radiated Emission and Bandedge Measurement

4.1.1 Limits of Radiated Emission and Bandedge Measurement

The field strength of emissions from intentional radiators operated within these frequency bands shall comply with the following

Fundamental Frequency	Field Strength of Fundamental (millivolts/meter)	Field Strength of Harmonics (microvolts/meter)
902 ~ 928 MHz	50	500
2400 ~ 2483.5 MHz	50	500
5725 ~ 5875 MHz	50	500
24 ~ 24.25 GHz	250	2500

Emissions radiated outside of the specified frequency bands, except for harmonics, shall be attenuated by at least 50 dB below the level of the fundamental or to the general radiated emission limits as below table, whichever is the lesser attenuation

Frequencies (MHz)	Field Strength (microvolts/meter)	Measurement Distance (meters)
0.009 ~ 0.490	2400/F(kHz)	300
0.490 ~ 1.705	24000/F(kHz)	30
1.705 ~ 30.0	30	30
30 ~ 88	100	3
88 ~ 216	150	3
216 ~ 960	200	3
Above 960	500	3

NOTE:

1. The lower limit shall apply at the transition frequencies.
2. Emission level (dBuV/m) = 20 log Emission level (uV/m).
3. For frequencies above 1000MHz, the field strength limits are based on average detector, however, the peak field strength of any emission shall not exceed the maximum permitted average limits, specified above by more than 20dB under any condition of modulation.

4.1.2 Test Instruments

DESCRIPTION & MANUFACTURER	MODEL NO.	SERIAL NO.	CALIBRATED DATE	CALIBRATED UNTIL
HP Preamplifier	8447D	2432A03504	Feb. 21, 2017	Feb. 20, 2018
HP Preamplifier	8449B	3008A01201	Feb. 22, 2017	Feb. 21, 2018
MITEQ Preamplifier	AMF-6F-260400-33-8P	892164	Feb. 21, 2017	Feb. 20, 2018
Agilent TEST RECEIVER	N9038A	MY51210129	Feb. 8, 2017	Feb. 7, 2018
Schwarzbeck Antenna	VULB 9168	139	Dec. 13, 2016	Dec. 12, 2017
Schwarzbeck Antenna	VHBA 9123	480	May 19, 2017	May 18, 2019
Schwarzbeck Horn Antenna	BBHA-9170	212	Dec. 30, 2016	Dec. 29, 2017
Schwarzbeck Horn Antenna	BBHA 9120-D1	D130	Dec. 27, 2016	Dec. 26, 2017
ADT. Turn Table	TT100	0306	NA	NA
ADT. Tower	AT100	0306	NA	NA
Software	Radiated_V7.6.15.9.5	NA	NA	NA
SUHNER RF cable With 4dB PAD	SF104	CABLE-CH6	Aug. 14, 2017	Aug. 13, 2018
SUHNER RF cable With 3dB PAD	SF102	Cable-CH8-3.6m	Aug. 14, 2017	Aug. 13, 2018
KEYSIGHT MIMO Powermeasurement Test set	U2021XA	U2021XA-001	May 31,2017	May 30,2018
KEYSIGHT Spectrum Analyzer	N9030A	MY54490260	Jul. 26, 2017	Jul. 25, 2018
Loop Antenna EMCI	LPA600	270	Aug. 11, 2017	Aug. 10, 2019
EMCO Horn Antenna	3115	00028257	Dec. 15, 2016	Dec. 14, 2017
Highpass filter Wainwright Instruments	WHK 3.1/18G-10SS	SN 8	NA	NA
ROHDE & SCHWARZ Spectrum Analyzer	FSV40	101042	Sep. 29, 2017	Sep. 28, 2018
Anritsu Power Sensor	MA2411B	0738404	Apr. 24, 2017	Apr. 23, 2018
Anritsu Power Meter	ML2495A	0842014	Apr. 24, 2017	Apr. 23, 2018

- NOTE:**
1. The calibration interval of the above test instruments is 12/24 months. And the calibrations are traceable to NML/ROC and NIST/USA.
 2. The horn antenna and HP preamplifier (model: 8449B) are used only for the measurement of emission frequency above 1GHz if tested.
 3. The test was performed in Chamber No. 6.
 4. The Industry Canada Reference No. IC 7450E-6.

4.1.3 Test Procedures

For Radiated emission below 30MHz

- a. The EUT was placed on the top of a rotating table 0.8 meters above the ground at a 3 meter chamber room. The table was rotated 360 degrees to determine the position of the highest radiation.
- b. The EUT was set 3 meters away from the interference-receiving antenna, which was mounted on the top of a variable-height antenna tower.
- c. Both X and Y axes of the antenna are set to make the measurement.
- d. For each suspected emission, the EUT was arranged to its worst case and the rotatable table was turned from 0 degrees to 360 degrees to find the maximum reading.
- e. The test-receiver system was set to Quasi-Peak Detect Function and Specified Bandwidth with Maximum Hold Mode.

NOTE:

1. The resolution bandwidth and video bandwidth of test receiver/spectrum analyzer is 9kHz at frequency below 30MHz.

For Radiated emission above 30MHz

- a. The EUT was placed on the top of a rotating table 0.8 meters (for 30MHz ~ 1GHz) / 1.5 meters (for above 1GHz) above the ground at 3 meter chamber room for test. The table was rotated 360 degrees to determine the position of the highest radiation.
- b. The EUT was set 3 meters away from the interference-receiving antenna, which was mounted on the top of a variable-height antenna tower.
- c. The height of antenna is varied from one meter to four meters above the ground to determine the maximum value of the field strength. Both horizontal and vertical polarizations of the antenna are set to make the measurement.
- d. For each suspected emission, the EUT was arranged to its worst case and then the antenna was tuned to heights from 1 meter to 4 meters and the rotatable table was turned from 0 degrees to 360 degrees to find the maximum reading.
- e. The test-receiver system was set to quasi-peak detect function and specified bandwidth with maximum hold mode when the test frequency is below 1 GHz.
- f. The test-receiver system was set to peak and average detect function and specified bandwidth with maximum hold mode when the test frequency is above 1 GHz. If the peak reading value also meets average limit, measurement with the average detector is unnecessary.

Note:

1. The resolution bandwidth and video bandwidth of test receiver/spectrum analyzer is 120kHz for Quasi-peak detection (QP) at frequency below 1GHz.
2. The resolution bandwidth of test receiver/spectrum analyzer is 1 MHz and the video bandwidth is 3 MHz for Peak detection (PK) at frequency above 1GHz.
3. All modes of operation were investigated and the worst-case emissions are reported.

4.1.4 Deviation from Test Standard

No deviation.

4.1.5 Test Setup

For Radiated emission below 30MHz

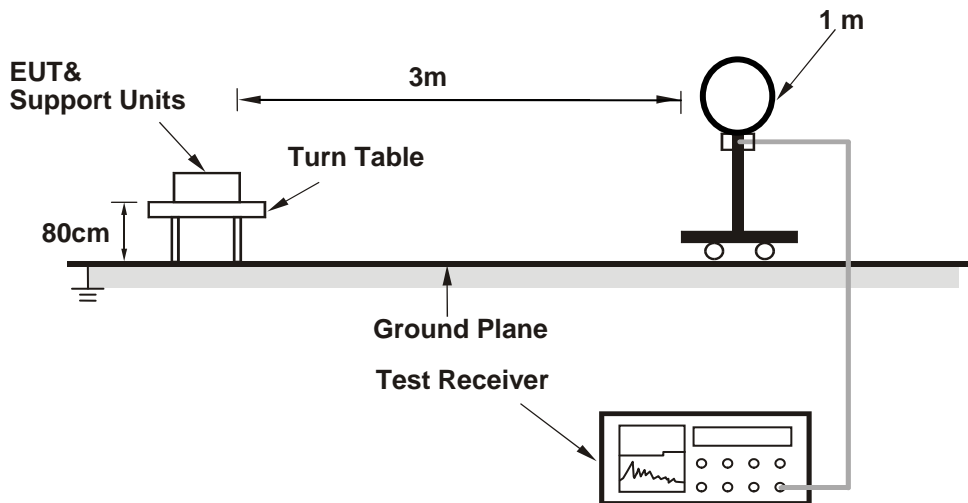

For Radiated emission 30MHz to 1GHz

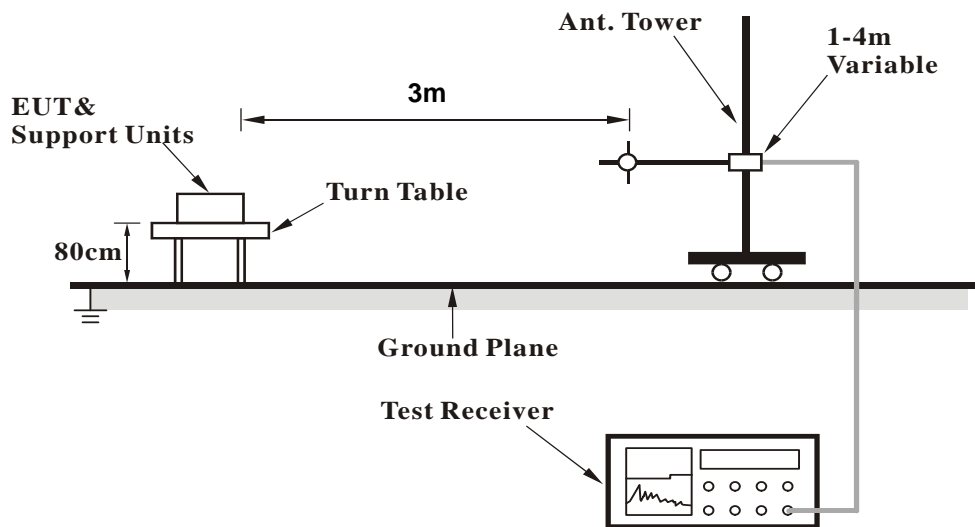

For Radiated emission above 1GHz

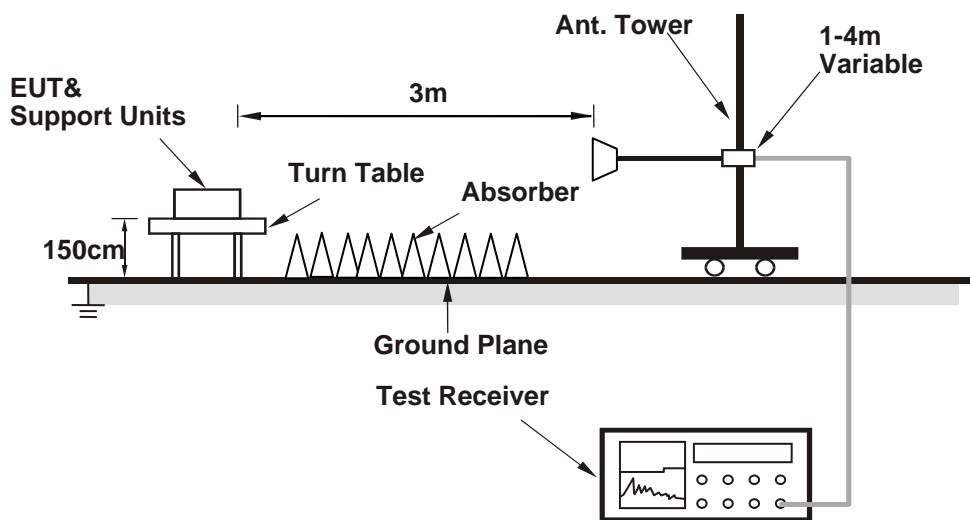

For the actual test configuration, please refer to the attached file (Test Setup Photo).

4.1.6 EUT Operating Conditions

Set the EUT under transmission condition continuously at specific channel frequency continuously.

4.1.7 Test Results

ABOVE 1GHz DATA

CHANNEL	TX Channel 1	DETECTOR FUNCTION	Peak (PK)
FREQUENCY RANGE	1GHz ~ 25GHz		Average (AV)

ANTENNA POLARITY & TEST DISTANCE: HORIZONTAL AT 3 M

NO.	FREQ. (MHz)	EMISSION LEVEL (dBuV/m)	LIMIT (dBuV/m)	MARGIN (dB)	ANTENNA HEIGHT (m)	TABLE ANGLE (Degree)	RAW VALUE (dBuV)	CORRECTION FACTOR (dB/m)
1	2390.00	56.90 PK	74.00	-17.10	2.81 H	73	59.21	-2.31
2	2390.00	39.13 AV	54.00	-14.87	2.81 H	73	41.44	-2.31
3	#2400.00	57.85 PK	74.00	-16.15	2.81 H	73	60.10	-2.25
4	#2400.00	40.08 AV	54.00	-13.92	2.81 H	73	42.33	-2.25
5	*2403.00	92.75 PK	114.00	-21.25	2.81 H	73	94.99	-2.24
6	*2403.00	74.98 AV	94.00	-19.02	2.81 H	73	77.22	-2.24
7	4806.00	44.89 PK	74.00	-29.11	2.86 H	88	40.75	4.14
8	4806.00	27.12 AV	54.00	-26.88	2.86 H	88	22.98	4.14

ANTENNA POLARITY & TEST DISTANCE: VERTICAL AT 3 M

NO.	FREQ. (MHz)	EMISSION LEVEL (dBuV/m)	LIMIT (dBuV/m)	MARGIN (dB)	ANTENNA HEIGHT (m)	TABLE ANGLE (Degree)	RAW VALUE (dBuV)	CORRECTION FACTOR (dB/m)
1	2390.00	52.36 PK	74.00	-21.64	3.87 V	57	54.67	-2.31
2	2390.00	34.59 AV	54.00	-19.41	3.87 V	57	36.90	-2.31
3	#2400.00	56.96 PK	74.00	-17.04	3.87 V	57	59.21	-2.25
4	#2400.00	39.19 AV	54.00	-14.81	3.87 V	57	41.44	-2.25
5	*2403.00	87.11 PK	114.00	-26.89	3.87 V	57	89.35	-2.24
6	*2403.00	69.34 AV	94.00	-24.66	3.87 V	57	71.58	-2.24
7	4806.00	43.93 PK	74.00	-30.07	3.68 V	106	39.79	4.14
8	4806.00	26.16 AV	54.00	-27.84	3.68 V	106	22.02	4.14

REMARKS:

- Emission Level(dBuV/m) = Raw Value(dBuV) + Correction Factor(dB/m)
- Correction Factor(dB/m) = Antenna Factor(dB/m) + Cable Factor(dB) – Pre-Amplifier Factor(dB)
- The other emission levels were very low against the limit.
- Margin value = Emission Level – Limit value
- " * ": Fundamental frequency.
- " # ": The radiated frequency is out of the restricted band.
- The average value of fundamental and harmonic frequency is: Average = Peak value + 20 log(Duty cycle) Where the duty factor is calculated from following formula:
 $20 \log(\text{Duty cycle}) = 20 \log(0.07513 \text{ ms} / 0.5811 \text{ ms}) = -17.77 \text{ dB}$
Please see page 21 for plotted duty.

CHANNEL	TX Channel 39	DETECTOR FUNCTION	Peak (PK)
FREQUENCY RANGE	1GHz ~ 25GHz		Average (AV)

ANTENNA POLARITY & TEST DISTANCE: HORIZONTAL AT 3 M

NO.	FREQ. (MHz)	EMISSION LEVEL (dBuV/m)	LIMIT (dBuV/m)	MARGIN (dB)	ANTENNA HEIGHT (m)	TABLE ANGLE (Degree)	RAW VALUE (dBuV)	CORRECTION FACTOR (dB/m)
1	*2441.00	92.31 PK	114.00	-21.69	2.99 H	77	94.30	-1.99
2	*2441.00	74.54 AV	94.00	-19.46	2.99 H	77	76.53	-1.99
3	4882.00	44.87 PK	74.00	-29.13	2.95 H	170	40.62	4.25
4	4882.00	27.10 AV	54.00	-26.90	2.95 H	170	22.85	4.25

ANTENNA POLARITY & TEST DISTANCE: VERTICAL AT 3 M

NO.	FREQ. (MHz)	EMISSION LEVEL (dBuV/m)	LIMIT (dBuV/m)	MARGIN (dB)	ANTENNA HEIGHT (m)	TABLE ANGLE (Degree)	RAW VALUE (dBuV)	CORRECTION FACTOR (dB/m)
1	*2441.00	87.49 PK	114.00	-26.51	1.05 V	51	89.48	-1.99
2	*2441.00	69.72 AV	94.00	-24.28	1.05 V	51	71.71	-1.99
3	4882.00	43.43 PK	74.00	-30.57	2.90 V	165	39.18	4.25
4	4882.00	25.66 AV	54.00	-28.34	2.90 V	165	21.41	4.25

REMARKS:

1. Emission Level(dBuV/m) = Raw Value(dBuV) + Correction Factor(dB/m)
2. Correction Factor(dB/m) = Antenna Factor(dB/m) + Cable Factor(dB) – Pre-Amplifier Factor(dB)
3. The other emission levels were very low against the limit.
4. Margin value = Emission Level – Limit value
5. " * ": Fundamental frequency.
6. The average value of fundamental and harmonic frequency is: Average = Peak value + 20 log(Duty cycle) Where the duty factor is calculated from following formula:
 $20 \log(\text{Duty cycle}) = 20 \log(0.07513 \text{ ms} / 0.5811 \text{ ms}) = -17.77 \text{ dB}$
 Please see page 21 for plotted duty.

CHANNEL	TX Channel 78	DETECTOR FUNCTION	Peak (PK)
FREQUENCY RANGE	1GHz ~ 25GHz		Average (AV)

ANTENNA POLARITY & TEST DISTANCE: HORIZONTAL AT 3 M

NO.	FREQ. (MHz)	EMISSION LEVEL (dBuV/m)	LIMIT (dBuV/m)	MARGIN (dB)	ANTENNA HEIGHT (m)	TABLE ANGLE (Degree)	RAW VALUE (dBuV)	CORRECTION FACTOR (dB/m)
1	*2480.00	92.54 PK	114.00	-21.46	2.60 H	85	94.27	-1.73
2	*2480.00	74.77 AV	94.00	-19.23	2.60 H	85	76.50	-1.73
3	2483.50	57.56 PK	74.00	-16.44	2.60 H	85	59.27	-1.71
4	2483.50	39.79 AV	54.00	-14.21	2.60 H	85	41.50	-1.71
5	4960.00	44.58 PK	74.00	-29.42	2.78 H	214	40.26	4.32
6	4960.00	26.81 AV	54.00	-27.19	2.78 H	214	22.49	4.32

ANTENNA POLARITY & TEST DISTANCE: VERTICAL AT 3 M

NO.	FREQ. (MHz)	EMISSION LEVEL (dBuV/m)	LIMIT (dBuV/m)	MARGIN (dB)	ANTENNA HEIGHT (m)	TABLE ANGLE (Degree)	RAW VALUE (dBuV)	CORRECTION FACTOR (dB/m)
1	*2480.00	87.30 PK	114.00	-26.70	1.48 V	46	89.03	-1.73
2	*2480.00	69.53 AV	94.00	-24.47	1.48 V	46	71.26	-1.73
3	2483.50	54.78 PK	74.00	-19.22	1.48 V	46	56.49	-1.71
4	2483.50	37.01 AV	54.00	-16.99	1.48 V	46	38.72	-1.71
5	4960.00	43.97 PK	74.00	-30.03	2.27 V	155	39.65	4.32
6	4960.00	26.20 AV	54.00	-27.80	2.27 V	155	21.88	4.32

REMARKS:

1. Emission Level(dBuV/m) = Raw Value(dBuV) + Correction Factor(dB/m)
2. Correction Factor(dB/m) = Antenna Factor(dB/m) + Cable Factor(dB) – Pre-Amplifier Factor(dB)
3. The other emission levels were very low against the limit.
4. Margin value = Emission Level – Limit value
5. " * ": Fundamental frequency.
6. The average value of fundamental and harmonic frequency is: Average = Peak value + 20 log(Duty cycle) Where the duty factor is calculated from following formula:
 $20 \log(\text{Duty cycle}) = 20 \log(0.07513 \text{ ms} / 0.5811 \text{ ms}) = -17.77 \text{ dB}$
 Please see page 21 for plotted duty.

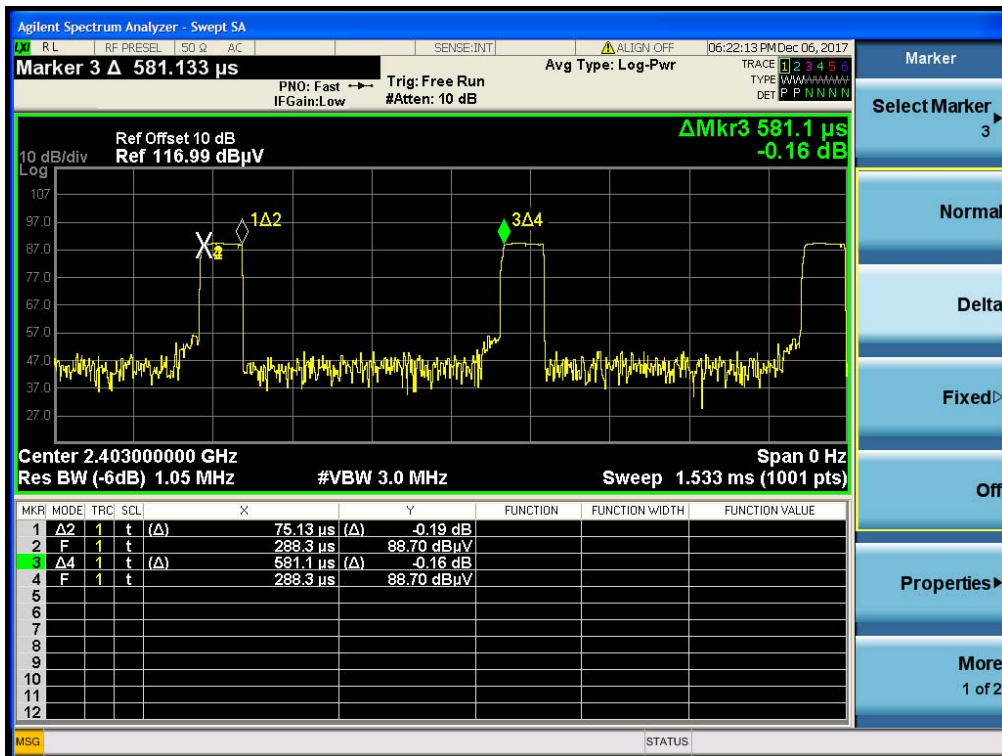

$$20 \log(\text{Duty cycle}) = 20 \log(0.07513 \text{ ms} / 0.5811 \text{ ms}) = -17.77 \text{ dB}$$

BELOW 1GHz WORST-CASE DATA

CHANNEL	TX Channel 1	DETECTOR FUNCTION	Quasi-Peak (QP)
FREQUENCY RANGE	9kHz ~ 1GHz		

ANTENNA POLARITY & TEST DISTANCE: HORIZONTAL AT 3 M

NO.	FREQ. (MHz)	EMISSION LEVEL (dBuV/m)	LIMIT (dBuV/m)	MARGIN (dB)	ANTENNA HEIGHT (m)	TABLE ANGLE (Degree)	RAW VALUE (dBuV)	CORRECTION FACTOR (dB/m)
1	113.80	21.53 QP	43.50	-21.97	1.00 H	258	33.83	-12.30
2	213.57	18.64 QP	43.50	-24.86	1.53 H	89	29.87	-11.23
3	478.91	23.45 QP	46.00	-22.55	1.11 H	321	26.89	-3.44
4	642.38	27.86 QP	46.00	-18.14	1.43 H	99	27.63	0.23
5	813.57	31.55 QP	46.00	-14.45	2.19 H	84	28.04	3.51
6	963.47	31.28 QP	54.00	-22.72	3.96 H	271	25.26	6.02

ANTENNA POLARITY & TEST DISTANCE: VERTICAL AT 3 M

NO.	FREQ. (MHz)	EMISSION LEVEL (dBuV/m)	LIMIT (dBuV/m)	MARGIN (dB)	ANTENNA HEIGHT (m)	TABLE ANGLE (Degree)	RAW VALUE (dBuV)	CORRECTION FACTOR (dB/m)
1	115.39	21.96 QP	43.50	-21.54	2.68 V	145	34.10	-12.14
2	347.35	20.33 QP	46.00	-25.67	2.57 V	39	26.79	-6.46
3	567.87	25.86 QP	46.00	-20.14	1.46 V	258	27.38	-1.52
4	673.87	28.36 QP	46.00	-17.64	3.54 V	168	27.75	0.61
5	858.64	31.99 QP	46.00	-14.01	2.45 V	39	28.07	3.92
6	948.36	33.75 QP	46.00	-12.25	3.54 V	218	28.02	5.73

REMARKS:

1. Emission Level(dBuV/m) = Raw Value(dBuV) + Correction Factor(dB/m)
2. Correction Factor(dB/m) = Antenna Factor(dB/m) + Cable Factor(dB) – Pre-Amplifier Factor(dB)
3. The other emission levels were very low against the limit.
4. Margin value = Emission Level – Limit value

4.2 Conducted Emission Measurement

4.2.1 Limits of Conducted Emission Measurement

Frequency (MHz)	Conducted Limit (dBuV)	
	Quasi-peak	Average
0.15 - 0.5	66 - 56	56 - 46
0.50 - 5.0	56	46
5.0 - 30.0	60	50

Note: 1. The lower limit shall apply at the transition frequencies.

2. The limit decreases in line with the logarithm of the frequency in the range of 0.15 to 0.50MHz.

4.2.2 Test Instruments

Description & Manufacturer	Model No.	Serial No.	Cal. Date	Cal. Due
ROHDE & SCHWARZ TEST RECEIVER	ESCS 30	100292	Dec. 9, 2016	Dec. 8, 2017
ROHDE & SCHWARZ Artificial Mains Network (For EUT)	ENV216	101195	May 2, 2017	May 1, 2018
LISN With Adapter (for EUT)	AD10	C03Ada-002	May 2, 2017	May 1, 2018
EMCO L.I.S.N. (For peripherals)	3825/2	9504-2359	Jul. 25, 2017	Jul. 24, 2018
SCHWARZBECK Artificial Mains Network (For EUT)	NNLK8129	8129229	May 9, 2017	May 8, 2018
Software	Cond_V7.3.7.4	NA	NA	NA
RF cable (JYEBAO) With 10dB PAD	5D-FB	Cable-C03.01	Sep. 19, 2017	Sep. 18, 2018
LYNICS Terminator (For EMCO LISN)	0900510	E1-01-300	Jan. 18, 2017	Jan. 17, 2018
LYNICS Terminator (For EMCO LISN)	0900510	E1-01-301	Jan. 18, 2017	Jan. 17, 2018
ROHDE & SCHWARZ Artificial Mains Network (For TV EUT)	ESH3-Z5	100220	Nov. 14, 2017	Nov. 13, 2018
LISN With Adapter (for TV EUT)	100220	N/A	Nov. 14, 2017	Nov. 13, 2018

Notes: 1. The calibration interval of the above test instruments is 12 months and the calibrations are traceable to NML/ROC and NIST/USA.

2. The test was performed in Shielded Room No. 3.

4.2.3 Test Procedures

- The EUT was placed 0.4 meters from the conducting wall of the shielded room with EUT being connected to the power mains through a line impedance stabilization network (LISN). Other support units were connected to the power mains through another LISN. The two LISNs provide 50 ohm/ 50uH of coupling impedance for the measuring instrument.
- Both lines of the power mains connected to the EUT were checked for maximum conducted interference.
- The frequency range from 150kHz to 30MHz was searched. Emission levels under (Limit - 20dB) was not recorded.

NOTE: The resolution bandwidth and video bandwidth of test receiver is 9kHz for quasi-peak detection (QP) and average detection (AV) at frequency 0.15MHz-30MHz.

4.2.4 Deviation from Test Standard

No deviation.

4.2.5 Test Setup

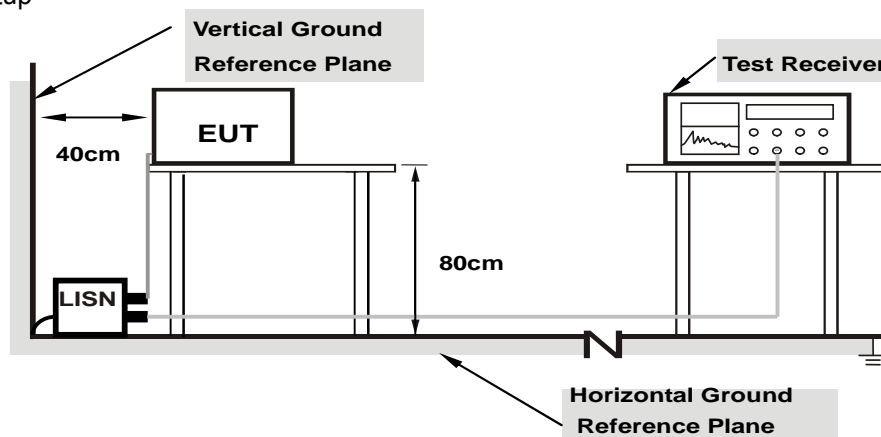

Note: Support units were connected to second LISN.

For the actual test configuration, please refer to the attached file (Test Setup Photo).

4.2.6 EUT Operating Conditions

For Mode B:

- Connected the EUT with the Notebook.
- Set the EUT under charging condition continuously.

For Mode C:

- Connected the EUT with the Adapter.
- Set the EUT under charging condition continuously.

4.2.7 Test Results

Frequency Range	150kHz ~ 30MHz	Detector Function	Quasi-Peak (QP) / Average (AV)
Test Mode	Mode B		

Phase Of Power : Line (L)										
No	Frequency (MHz)	Correction Factor (dB)	Reading Value (dBuV)		Emission Level (dBuV)		Limit (dBuV)		Margin (dB)	
			Q.P.	AV.	Q.P.	AV.	Q.P.	AV.	Q.P.	AV.
1	0.15000	9.57	37.12	22.76	46.69	32.33	66.00	56.00	-19.31	-23.67
2	0.34922	9.58	29.35	22.94	38.93	32.52	58.98	48.98	-20.05	-16.46
3	1.18359	9.62	23.05	17.77	32.67	27.39	56.00	46.00	-23.33	-18.61
4	4.03906	9.72	23.77	15.03	33.49	24.75	56.00	46.00	-22.51	-21.25
5	13.01953	9.86	20.17	13.66	30.03	23.52	60.00	50.00	-29.97	-26.48
6	17.85938	9.88	22.86	17.81	32.74	27.69	60.00	50.00	-27.26	-22.31

Remarks:

1. Q.P. and AV. are abbreviations of quasi-peak and average individually.
2. The emission levels of other frequencies were very low against the limit.
3. Margin value = Emission level – Limit value
4. Correction factor = Insertion loss + Cable loss
5. Emission Level = Correction Factor + Reading Value

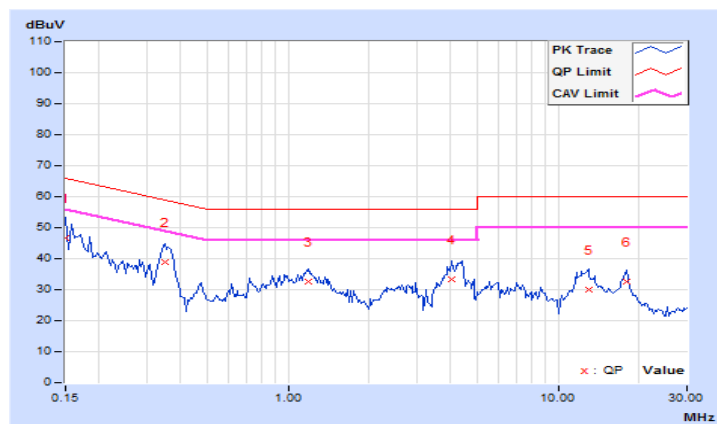

Frequency Range	150kHz ~ 30MHz	Detector Function	Quasi-Peak (QP) / Average (AV)
Test Mode	Mode B		

Phase Of Power : Neutral (N)										
No	Frequency (MHz)	Correction Factor (dB)	Reading Value (dBuV)		Emission Level (dBuV)		Limit (dBuV)		Margin (dB)	
			Q.P.	AV.	Q.P.	AV.	Q.P.	AV.	Q.P.	AV.
1	0.15000	9.73	35.61	23.14	45.34	32.87	66.00	56.00	-20.66	-23.13
2	0.36094	9.74	29.47	23.76	39.21	33.50	58.71	48.71	-19.50	-15.21
3	1.17969	9.79	22.10	16.97	31.89	26.76	56.00	46.00	-24.11	-19.24
4	2.37109	9.84	17.40	12.03	27.24	21.87	56.00	46.00	-28.76	-24.13
5	4.25781	9.89	24.00	15.18	33.89	25.07	56.00	46.00	-22.11	-20.93
6	12.73828	10.04	21.47	15.24	31.51	25.28	60.00	50.00	-28.49	-24.72
7	17.93359	10.10	23.19	18.46	33.29	28.56	60.00	50.00	-26.71	-21.44

Remarks:

1. Q.P. and AV. are abbreviations of quasi-peak and average individually.
2. The emission levels of other frequencies were very low against the limit.
3. Margin value = Emission level – Limit value
4. Correction factor = Insertion loss + Cable loss
5. Emission Level = Correction Factor + Reading Value

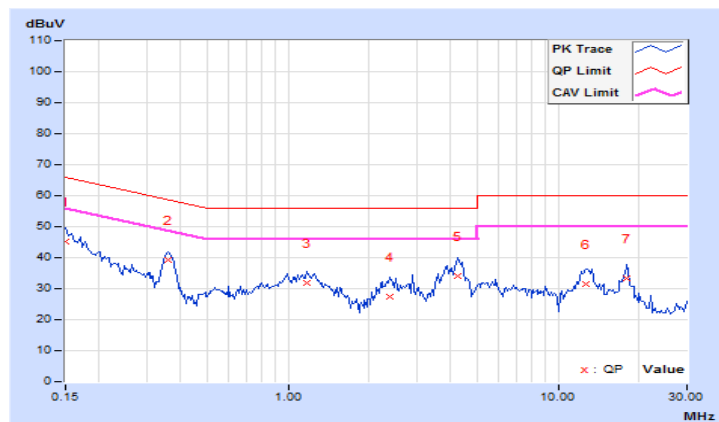

Frequency Range	150kHz ~ 30MHz	Detector Function	Quasi-Peak (QP) / Average (AV)
Test Mode	Mode C		

Phase Of Power : Line (L)										
No	Frequency (MHz)	Correction Factor (dB)	Reading Value (dBuV)		Emission Level (dBuV)		Limit (dBuV)		Margin (dB)	
			Q.P.	AV.	Q.P.	AV.	Q.P.	AV.	Q.P.	AV.
1	0.18516	9.61	36.47	20.32	46.08	29.93	64.25	54.25	-18.17	-24.32
2	0.49375	9.67	34.14	25.99	43.81	35.66	56.10	46.10	-12.29	-10.44
3	0.76719	9.70	26.65	16.95	36.35	26.65	56.00	46.00	-19.65	-19.35
4	1.47266	9.77	33.35	23.99	43.12	33.76	56.00	46.00	-12.88	-12.24
5	2.64453	9.84	28.01	17.55	37.85	27.39	56.00	46.00	-18.15	-18.61
6	3.14844	9.86	28.24	17.80	38.10	27.66	56.00	46.00	-17.90	-18.34
7	16.94531	10.16	26.20	17.05	36.36	27.21	60.00	50.00	-23.64	-22.79

Remarks:

1. Q.P. and AV. are abbreviations of quasi-peak and average individually.
2. The emission levels of other frequencies were very low against the limit.
3. Margin value = Emission level – Limit value
4. Correction factor = Insertion loss + Cable loss
5. Emission Level = Correction Factor + Reading Value

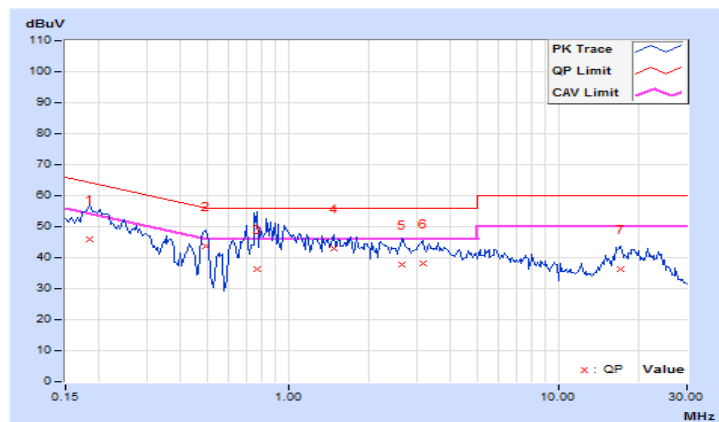

Frequency Range	150kHz ~ 30MHz	Detector Function	Quasi-Peak (QP) / Average (AV)
Test Mode	Mode C		

Phase Of Power : Neutral (N)										
No	Frequency (MHz)	Correction Factor (dB)	Reading Value (dBuV)		Emission Level (dBuV)		Limit (dBuV)		Margin (dB)	
			Q.P.	AV.	Q.P.	AV.	Q.P.	AV.	Q.P.	AV.
1	0.18516	9.77	32.63	15.88	42.40	25.65	64.25	54.25	-21.85	-28.60
2	0.48984	9.81	29.18	21.83	38.99	31.64	56.17	46.17	-17.18	-14.53
3	1.28906	9.90	23.22	15.28	33.12	25.18	56.00	46.00	-22.88	-20.82
4	2.44531	9.98	23.41	14.28	33.39	24.26	56.00	46.00	-22.61	-21.74
5	3.26172	10.01	21.93	13.77	31.94	23.78	56.00	46.00	-24.06	-22.22
6	18.16016	10.38	20.94	11.27	31.32	21.65	60.00	50.00	-28.68	-28.35

Remarks:

1. Q.P. and AV. are abbreviations of quasi-peak and average individually.
2. The emission levels of other frequencies were very low against the limit.
3. Margin value = Emission level – Limit value
4. Correction factor = Insertion loss + Cable loss
5. Emission Level = Correction Factor + Reading Value

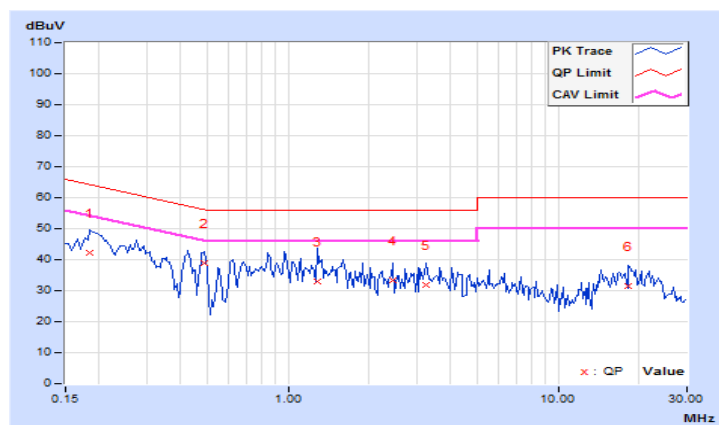

4.3 Channel Bandwidth

4.3.1 Test Setup

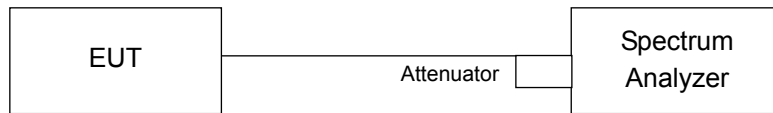

4.3.2 Test Instruments

Refer to section 4.1.2 to get information of above instrument.

4.3.3 Test Procedure

- a. Check the calibration of the measuring instrument using either an internal calibrator or a known signal from an external generator.
- b. Turn on the EUT and connect it to measurement instrument. Then set it to any one convenient frequency within its operating range. Set a reference level on the measuring instrument equal to the highest peak value.
- c. Measure the frequency difference of two frequencies that were attenuated 20dB from the reference level. Record the frequency difference as the emission bandwidth.
- d. Repeat above procedures until all frequencies measured were complete.

4.3.4 Deviation from Test Standard

No deviation.

4.3.5 EUT Operating Condition

The software provided by client enabled the EUT to transmit and receive data at lowest, middle and highest channel frequencies individually.

4.3.6 Test Results

Mode A

CHANNEL	FREQUENCY (MHz)	20dB BANDWIDTH (MHz)
1	2403	2.11
39	2441	2.11
78	2480	2.11

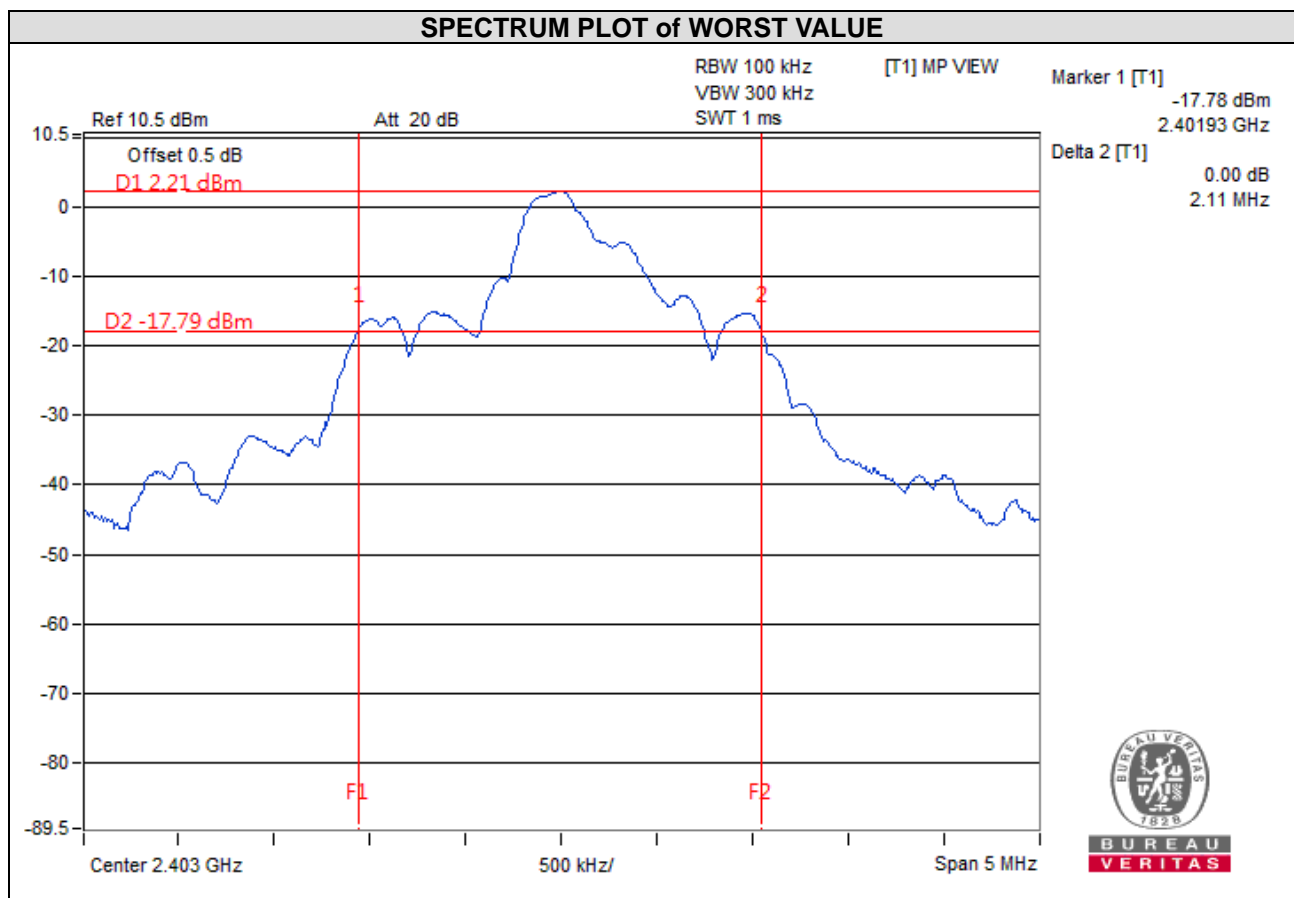

5 Pictures of Test Arrangements

Please refer to the attached file (Test Setup Photo).

Appendix – Information on the Testing Laboratories

We, Bureau Veritas Consumer Products Services (H.K.) Ltd., Taoyuan Branch, were founded in 1988 to provide our best service in EMC, Radio, Telecom and Safety consultation. Our laboratories are accredited and approved according to ISO/IEC 17025.

If you have any comments, please feel free to contact us at the following:

Linko EMC/RF Lab

Tel: 886-2-26052180

Fax: 886-2-26051924

Hsin Chu EMC/RF/Telecom Lab

Tel: 886-3-6668565

Fax: 886-3-6668323

Hwa Ya EMC/RF/Safety Lab

Tel: 886-3-3183232

Fax: 886-3-3270892

Email: service.adt@tw.bureauveritas.com

Web Site: www.bureauveritas-adt.com

The address and road map of all our labs can be found in our web site also.

--- END ---