

ignion 

Your innovation.
Accelerated.

DUO mXTEND™: TWO INDEPENDENT RADIOS IN THE SMALLEST ANTENNA FOOTPRINT

USER MANUAL
DUO mXTEND™ (NN03-320)

DUO mXTEND™

Two independent radios in the smallest antenna footprint

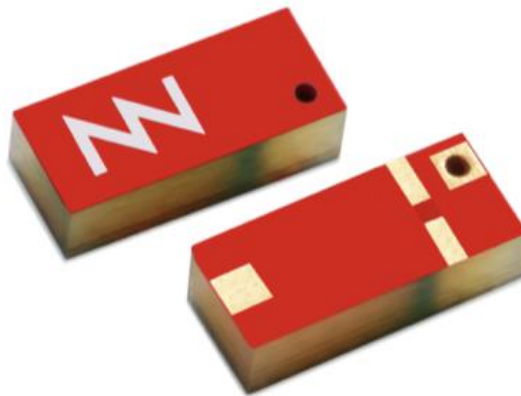

NN03-320

DUO mXTEND™ | IoT Antenna | GNSS+Bluetooth

Operating range: 1500 - 10600 MHz

Best for: 1560 - 5000 MHz

Dimensions: 7.0 mm x 3.0 mm x 2.0 mm

What is DUO mXTEND?

DUO mXTEND is a dual-port, chip antenna component designed to embed up to **two independent radios** in the smallest antenna footprint. The chip is designed to combine, for example, Bluetooth and GNSS or Wi-Fi and GNSS into a single package. Due to its Virtual Antenna technology, DUO mXTEND can feature many other wireless services, such as UWB making it the ideal antenna part for **indoor/outdoor tracking devices**.

DUO mXTEND has been engineered so that usually **no ground clearance** around the component is required. Only a minimum clearance underneath the exact footprint of the component is needed to obtain the best radiation efficiency in most cases. Moreover, the component has been designed for **dual-mounting**: either at the *center edge* of your device or at a *corner*, making this antenna *flexible* and *easy* to adapt in a variety of devices and radio configurations.

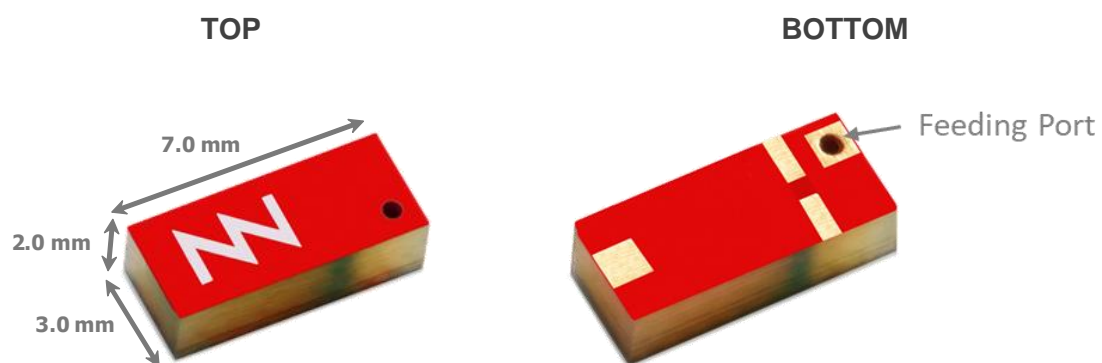





What is DUO mXTEND for?

DUO mXTEND current operating range extends from 1500 MHz up to 10.600 MHz, making it a versatile component to cover any radio application within that range, including **Bluetooth, Wi-Fi, and UWB**, but also **5G** and **CBRS**. Its miniature and slim form factor, together with its **no-ground clearance** and **dual-mounting** features makes it the ideal wireless connectivity chip for small indoor/outdoor tracking devices and all kinds of miniature IoT sensors. Due to the minimum footprint and size of the **DUO mXTEND**, embedded massive MIMO (e.g. 8 x 8) devices are a good application, where the density of installed antennas in a PCB is inherently high.

- IoT Asset Trackers
- 5G Routers (MIMO)
- Wi-Fi Routers (MIMO)
- Environmental Sensors
- Personal Gadget Tracker
- Indoor Trackers
- Notebooks/Tablets
- Health sensors
- Animal Trackers
- IoT Developer Kits
- Smart City sensors

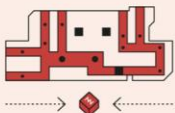
What differentiates DUO mXTEND from other chip antennas?

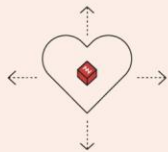
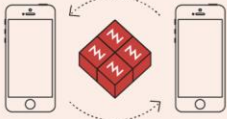
Like every other Virtual Antenna™ product, DUO mXTEND is frequency neutral, meaning that its frequency response is not determined by the antenna component but designed by the electronics engineer through a simple matching circuit. Virtual Antenna™ technology enables packaging the desired multiband performance in the smallest ever form factor, which enables the whole mXTEND range of components featuring a tiny off-the-shelf, surface-mount (SMD) electronic chip package. That makes mXTEND components easy to be integrated in about any IoT device through a shorter and easier design cycle and a much more robust, reliable and costs effective manufacturing process.

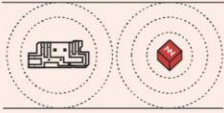
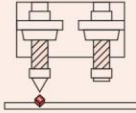
			
<p>Off-the-shelf Ready to be delivered 'as is' with no need for customization.</p>	<p>Up to 10 times smaller A booster can be 5³mm³ providing the same connectivity.</p>	<p>Versatility A phone can be designed with several architectures yet still using the same component.</p>	<p>Scalability The 'heart' of the design can be reused across multiple device models.</p>
			
<p>Modular Modules or standard building blocks can be re-used in the design of multiple devices.</p>	<p>Multiband A single antenna provides connectivity in 2G, 3G and 4G band.</p>	<p>Full performance The same performance in a much smaller, off-the-shelf and versatile component.</p>	<p>Pick & place No manual assembly is needed, only a conventional SMT machine.</p>

In addition, DUO mXTEND is one of the Virtual Antenna™ products featuring **Variant™** technology, which enables embedding **multiple antenna boosting elements into a single chip**. By embedding both an independent electric and magnetic booster, the chip features two independent ports/feeds that enable sharing the same antenna component by two different radios. This, together with the **no-ground clearance** and **dual-mounting** features, the DUO mXTEND provides all the **flexibility** needed to develop nearly any wireless device **fast**. Use the DUO mXTEND for any wireless IoT or mobile product and save critical space on your PCB, as it covers multiple radio needs for many IoT applications, including, GNSS, or Bluetooth, Wi-Fi, UWB and the high bands of 5G and CBRS, to name a few.

Click and select an application that fits your project:

DUO mXTEND USING TWO PORTS
GNSS + *Bluetooth IoT TRACKER*



(1500 MHz – 2500 MHz)

DUO mXTEND FOR 5G



(3400 MHz – 3800 MHz)

DUO mXTEND FOR UWB



(3100 MHz – 10600 MHz)

Click to view other useful DUO mXTEND guidelines:

[HOW TO EMBED A VIRTUAL ANTENNA](#)

[MECHANICAL SPECIFICATIONS](#)

[ASSEMBLY AND MANUFACTURING](#)

[PACKAGING](#)

Chapter Index

1. HOW TO EMBED A VIRUTAL ANTENNA.....	6
2. DUO mXTEND TWO-PORT IoT TRACKER.....	8
3. DUO mXTEND FOR 5G.....	15
4. DUO mXTEND UWB.....	20
5. MECHANICAL SPECIFICATIONS.....	25
6. ASSEMBLY AND MANUFACTURING.....	28
7. PACKAGING.....	30

How to embed a Virtual Antenna

Design with Virtual Antenna in 1-2-3

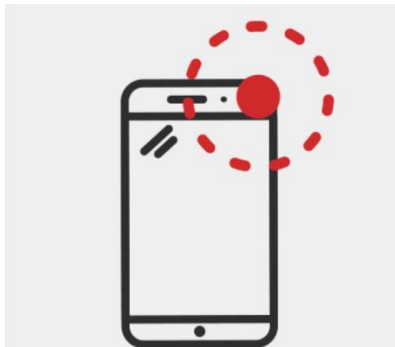

STEP 1: Place the antenna component

1. Select one corner of your PCB
2. Ensure your ground plane meets the DUO mXTEND clearance area restrictions
3. Respect a keep out space around the booster. Keep at least 5mm distance from metallic objects

Look [here](#) for an example on placing the DUO mXTEND

STEP 2: Design your matching network

1. Through a combination of inductors & capacitors obtain 50 Ohms of antenna impedance to optimize the transfer of energy to your antenna
2. It is critical to fine-tune your MN throughout the entirety the design process of achieve your desired frequency response

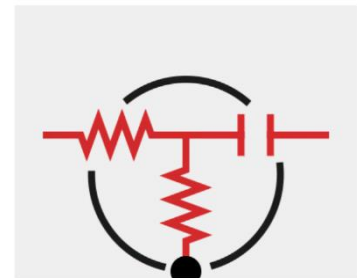

Look [here](#) for an example of a matching network we found in an DUO mXTEND application via simulation

STEP 3: Test your device

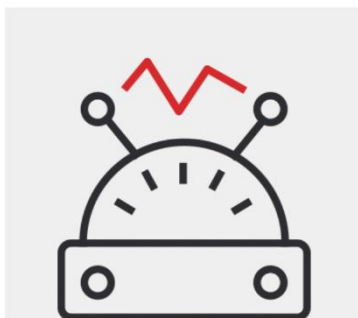

1. Perform a field test in which your antenna is placed in its final housing. Fine-tune the MN if needed.
2. Use a network analyzer to adjust mismatch
3. Test the antennas efficiency with an anechoic chamber

Look [here](#) for testing we did on our Evaluation Board, with the DUO mXTEND integrated in our Anechoic Chamber

<https://www.ignion.io/tutorials>

Scan QR code to
be taken to our
videos highlighting
these three easy
steps





Need further help? Easy start with NN Wireless Fast Track

Do you need more help with your antenna for your device?

Use our **NN Wireless Fast Track service** and get your ready-to-test antenna design especially simulated for your platform **free of charge**¹, and in **24 hours**.

1. Fill out the form, submit it and receive a confirmation email.
2. Reply to the email. If you wish, attach any relevant design file.
3. Get your design in 24h.

<https://www.ignion.io/fast-track-project/>



Scan QR code
to be taken to
our Wireless
Fast Track
page

DUO mXTEND USING TWO PORTS

GNSS and Bluetooth in a Single Package

The DUO mXTEND[™] antenna booster has been specifically designed for providing worldwide Global Navigation Satellite Systems (GNSS) and Bluetooth (BT) performance in wireless devices with small space requirements. Here we will compare BeiDou, GPS & Galileo and GLONASS performance operating in conjunction with Bluetooth. Using one of our Evaluation Boards, an example of a common DUO mXTEND[™] placement is seen. Finally, two different matching networks are selected, using both ports, for both GNSS and BT, allowing us to test, obtain, and analyze the VSWR, total efficiency, gain and radiation patterns.

QUICK REFERENCE GUIDE

Technical features	BeiDou	GPS & GALILEO	GLONASS	Bluetooth
	1561MHz	1575MHz	1598 – 1606MHz	2400 – 2500MHz
Average Efficiency	> 40%	> 45%	> 50%	> 50%
Peak Gain	-1.1 dBi	-1.0 dBi	-1.0 dBi	-0.9 dBi
VSWR	< 3:1			
Radiation Pattern	Omnidirectional			
Polarization	Linear			
Weight (approx.)	0.11 g.			
Temperature	-40 to +125 °C			
Impedance	50 Ω			
Dimensions (L x W x H)	7.0 mm x 3.0 mm x 2.0 mm			

Table 1 – Technical Features. Measures from the Evaluation Board. See Figure 1.

ELECTRICAL PERFORMANCE

EVALUATION BOARD

This Evaluation Board (part number: EB_NN03-320-m-GNSS-BT) integrates one DUO mXTEND™ antenna booster to provide operation in four frequency regions, 1561MHz (BeiDou E1 band), 1575 MHz (GPS L1 band and GALILEO E1), from 1598 MHz to 1606 MHz (GLONASS L1 band) and from 2400 MHz to 2500MHz (Bluetooth). A couple of UFL cables connect this dual input/output port solution to the SMA connectors for testing purposes.

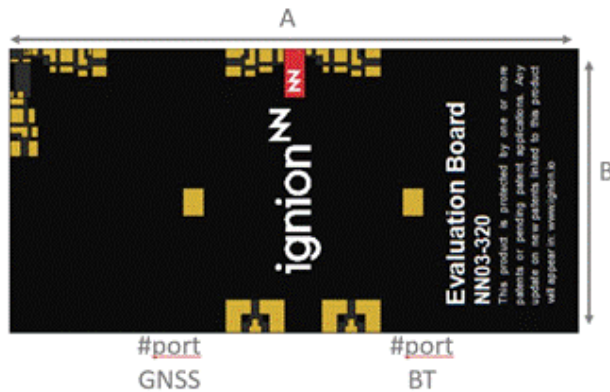

Measure	mm
A	80
B	40

Tolerance: ±0.2 mm

Material: The Evaluation Boards are built on FR4 substrate. Thickness is 1 mm.

Figure 1 – EB_NN03-320-m-GNSS-BT Evaluation Board providing operation at BeiDou E1 band (1561 MHz), GPS L1 band and GALILEO E1 band (1575 MHz), GLONASS L1 band (from 1598 MHz to 1606 MHz) and Bluetooth (from 2400MHz to 2480MHz). Notice that the clearance area is equal to the DUO mXTEND™ footprint.

This product and its use are protected by at least one or more of the following [patents and patent applications](#) PAT. US 62/529032; and other domestic and international patents pending. Additional information about patents related to this product is available at www.ignion.io/virtual-antenna/.

MATCHING NETWORK

DUO mXTEND™ needs two matching networks to connect to your device, a first for the Bluetooth port, a second for the GNSS one (Figure 2). This section describes in (Figure 3) a suitable matching network for DUO mXTEND™ and the resulting product specs when measured in the reference evaluation board (EB_NN03-320-m-GNSS-BT) described in the previous section. Please note that different tracking devices with different form factors, RF ground planes and nearby components may need a different matching network. If you need assistance to design your matching network, please contact support@ignion.io, or try our free-of-charge **NN Wireless Fast-Track** design service, you will get your chip antenna design including a custom matching network for your device in 24h¹. Other related to NN's range of R&D services is available at: <https://www.ignion.io/rdservices/>

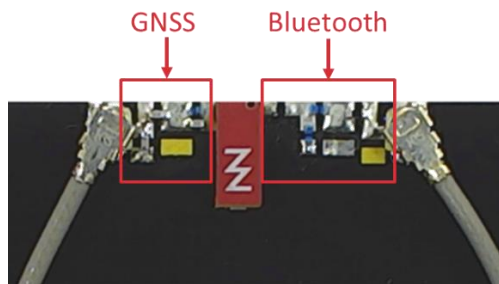

Figure 2 – Matching network distribution in the Evaluation Board (Figure 1).

1561 MHz – 1606 MHz and 2400 MHz – 2500 MHz											
MN GNSS	<div style="display: flex; align-items: center;">  <table border="1" style="margin-left: 20px;"> <thead> <tr> <th>Value</th> <th>Part Number</th> </tr> </thead> <tbody> <tr> <td>2.4 nH</td> <td>LQW15AN2N4C00</td> </tr> <tr> <td>2.0 pF</td> <td>GJM1555C1H2R0WB01</td> </tr> <tr> <td>0.7 pF</td> <td>GJM1555C1HR70WB01</td> </tr> <tr> <td>2.8 pF</td> <td>GJM1555C1H2R8WB01</td> </tr> </tbody> </table> </div>	Value	Part Number	2.4 nH	LQW15AN2N4C00	2.0 pF	GJM1555C1H2R0WB01	0.7 pF	GJM1555C1HR70WB01	2.8 pF	GJM1555C1H2R8WB01
Value	Part Number										
2.4 nH	LQW15AN2N4C00										
2.0 pF	GJM1555C1H2R0WB01										
0.7 pF	GJM1555C1HR70WB01										
2.8 pF	GJM1555C1H2R8WB01										
MN BT	<div style="display: flex; align-items: center;">  <table border="1" style="margin-left: 20px;"> <thead> <tr> <th>Value</th> <th>Part Number</th> </tr> </thead> <tbody> <tr> <td>0 Ω</td> <td>-</td> </tr> <tr> <td>4.7 nH</td> <td>LQW15AN4N7G80</td> </tr> <tr> <td>4.7 nH</td> <td>LQW15AN4N7G80</td> </tr> <tr> <td>0 Ω</td> <td>-</td> </tr> </tbody> </table> </div>	Value	Part Number	0 Ω	-	4.7 nH	LQW15AN4N7G80	4.7 nH	LQW15AN4N7G80	0 Ω	-
Value	Part Number										
0 Ω	-										
4.7 nH	LQW15AN4N7G80										
4.7 nH	LQW15AN4N7G80										
0 Ω	-										

Figure 3 – Matching network implemented in the Evaluation Board 1 port (Figure 1).

¹ See terms and conditions for a free NN Wireless Fast-Track service at: <https://www.ignion.io/fast-track-project/>

To ensure optimal results, the use of high-quality factor (Q) and tight tolerance components is highly recommended (e.g. Murata components with part numbers as in Figure 3). The antenna performance is always conditioned by its operating environment so that different devices with different printed circuit board sizes, components nearby the antenna, LCD's, batteries, covers, connectors, etc. affect the antenna performance. Accordingly, it is highly recommended placing pads compatible with 0402 and 0603 SMD components for a matching network as close as possible to the feeding point of the antenna element. Do it in the ground plane area, not in the clearance area. By tuning the matching network in your final design with your final surrounding components (batteries, displays, covers, etc.) you will be able to optimize the antenna performance without changing the antenna part.

VSWR AND TOTAL EFFICIENCY

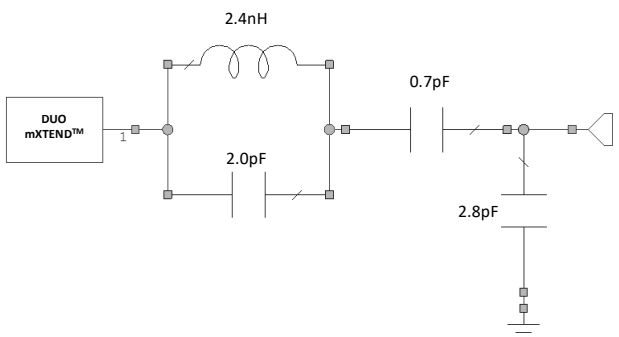
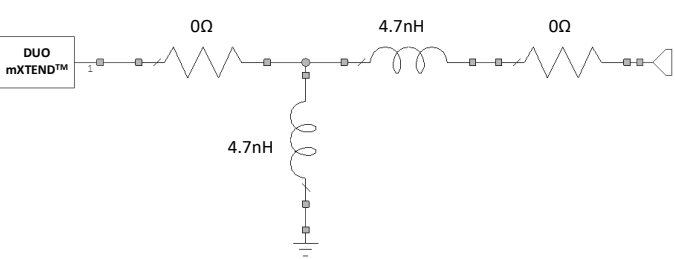
VSWR (Voltage Standing Wave Ratio) and Total Efficiency versus Frequency (GHz).

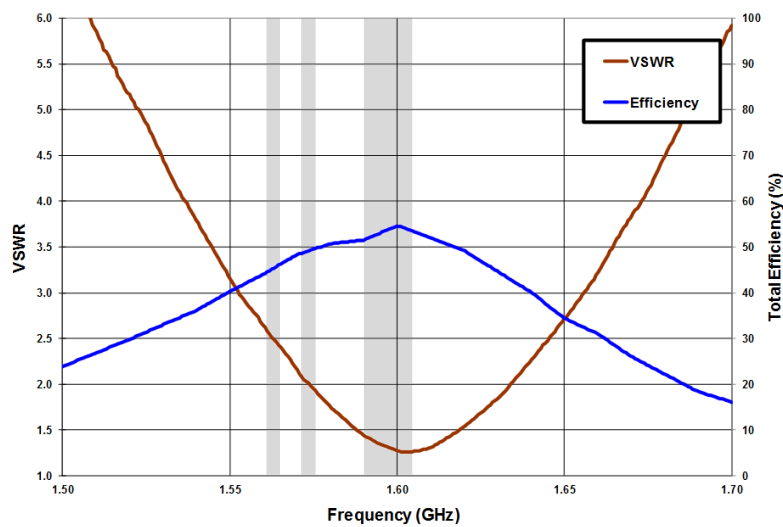

Figure 4 – VSWR and Total Efficiency at BeiDou E1 band (1561 MHz), GPS L1 band and GALILEO E1 band (1575 MHz), GLONASS L1 band (from 1598 to 1606 MHz) (from the Evaluation Board) (Figure 1).

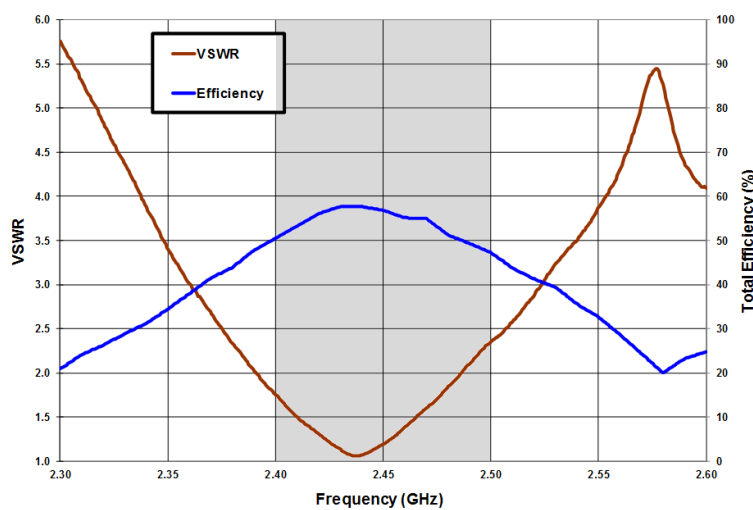

Figure 5 – VSWR and Total Efficiency for the 2400 – 2500 MHz (from the Evaluation Board) (Figure 1).

TRANSMISSION COEFFICIENT

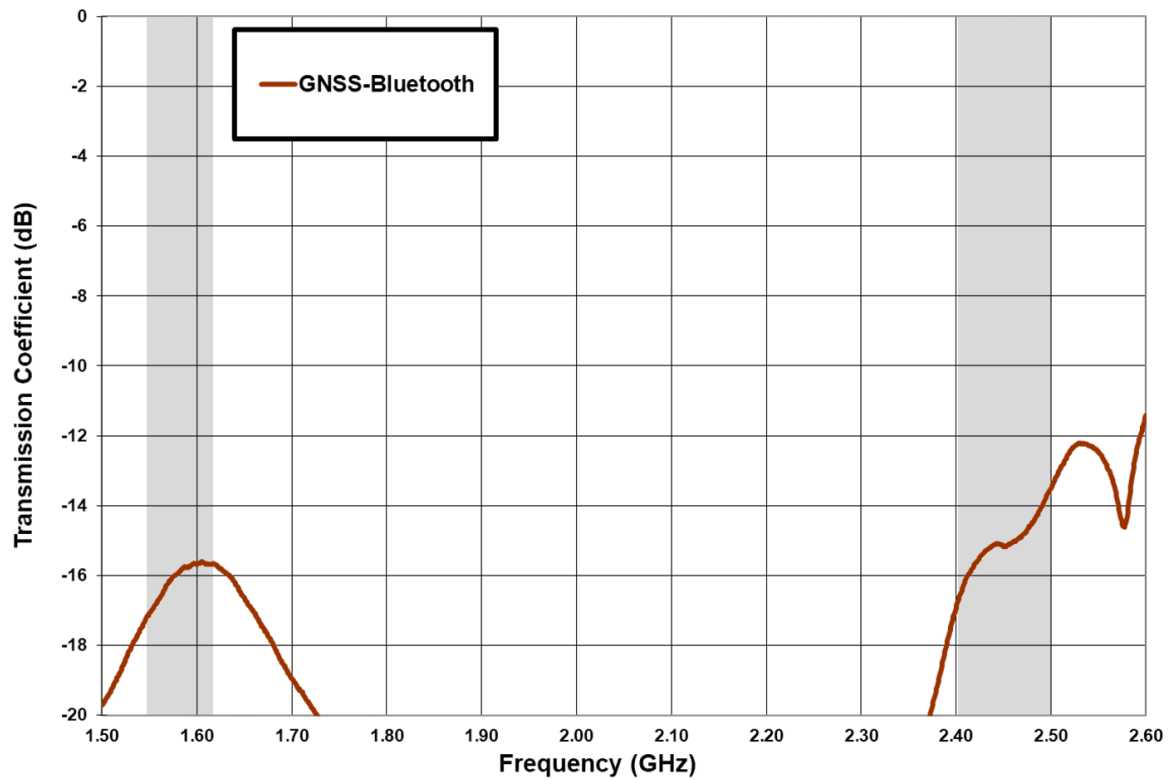
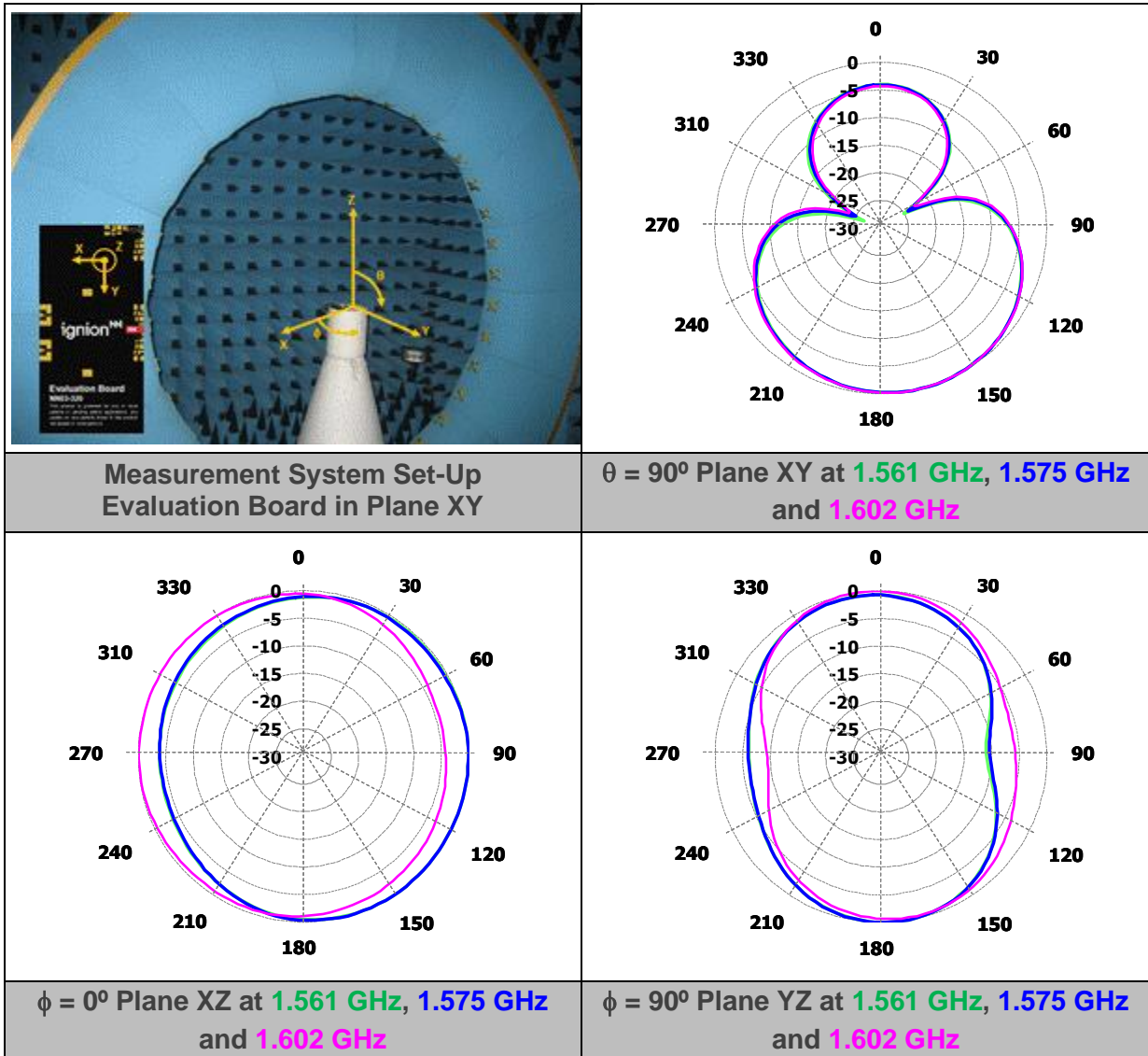

Figure 6 – Transmission coefficient between GNSS (1561 – 1606 MHz) and Bluetooth (2400 – 2500 MHz) from the Evaluation Board (Figure 1).

RADIATION PATTERNS (1561MHz, 1575MHz, and 1598 - 1606MHz), GAIN AND EFFICIENCY



BeiDou	Gain	-1.1 dBi	
	Efficiency	44.6 %	
GPS	Gain	-1.0 dBi	
	Efficiency	49.7 %	
GLONASS	Gain	Peak Gain	-1.0 dBi
		Average Gain across the band	-1.0 dBi
		Gain Range across the band (min, max)	-1.0 <=> -1.0 dBi
	Efficiency	Peak Efficiency	54.6 %
		Average Efficiency across the band	53.9 %
		Efficiency Range across the band (min, max)	53.0 – 54.6 %

Table 2 – Antenna Gain and Total Efficiency from the Evaluation Board (Figure 1) for BeiDou E1 (1561 MHz), GPS L1 (1575 MHz) and GLONASS L1 (1598 MHz – 1606 MHz) bands. Measures made in the Satimo STARGATE 32 anechoic chamber.

RADIATION PATTERNS (2400 - 2500 MHz) GAIN, AND EFFICIENCY

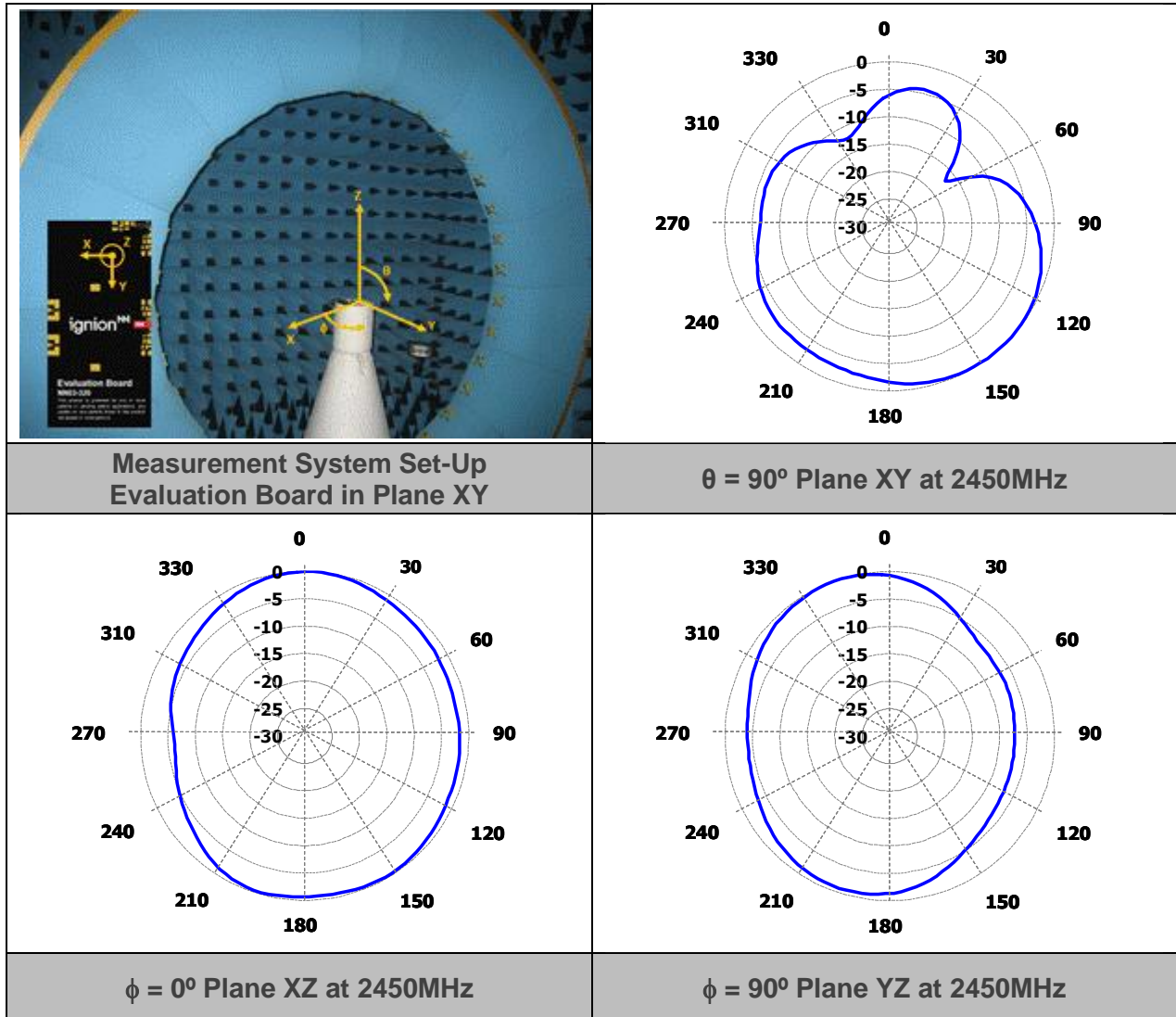

Gain	Peak Gain	-0.9 dBi
	Average Gain across the band	-0.9 dBi
	Gain Range across the band (min, max)	-1.0 dBi <-> -0.9 dBi
Efficiency	Peak Efficiency	57.7 %
	Average Efficiency across the band	54.1 %
	Efficiency Range across the band (min, max)	47.2 – 57.7 %

Table 3 – Antenna Gain and Total Efficiency for the Evaluation Board (Figure 1) for Bluetooth (2400 MHz - 2500 MHz). Measures made in the Satimo STARGATE 32 anechoic chamber.

DUO mXTEND for 5G

In this use case the DUO mXTEND[™] antenna booster is operating at 5G (3.4GHz-3.8GHz) and is integrated at the center edge of the Evaluation Board. A single matching network is selected allowing us to test, obtain, and analyze the VSWR, total efficiency, gain and radiation patterns. In the following design example DUO mXTEND[™] antenna booster does **not** require further **clearance area beyond** its 7 mm x 3 mm **footprint**.

QUICK REFERENCE GUIDE

Technical features	3.4 – 3.8 GHz
Average Efficiency	> 60%
Peak Gain	2.6 dBi
VSWR	< 3.0:1
Radiation Pattern	Omnidirectional
Polarization	Linear
Weight (approx.)	0.11 g.
Temperature	-40 to + 125 °C
Impedance	50 Ω
Dimensions (L x W x H)	7.0 mm x 3.0 mm x 2.0 mm

Table 4 – Technical Features. Measures from the Evaluation Board. See Figure 7.

EVALUATION BOARD

This Evaluation Board EB_NN03-320-m-5G integrates a UFL cable to connect the DUO mXTEND™ antenna booster with the SMA connector. The DUO mXTEND™ provides operation in the frequency region going from 3.4 GHz to 3.8 GHz (5G band), through a single input/output port.

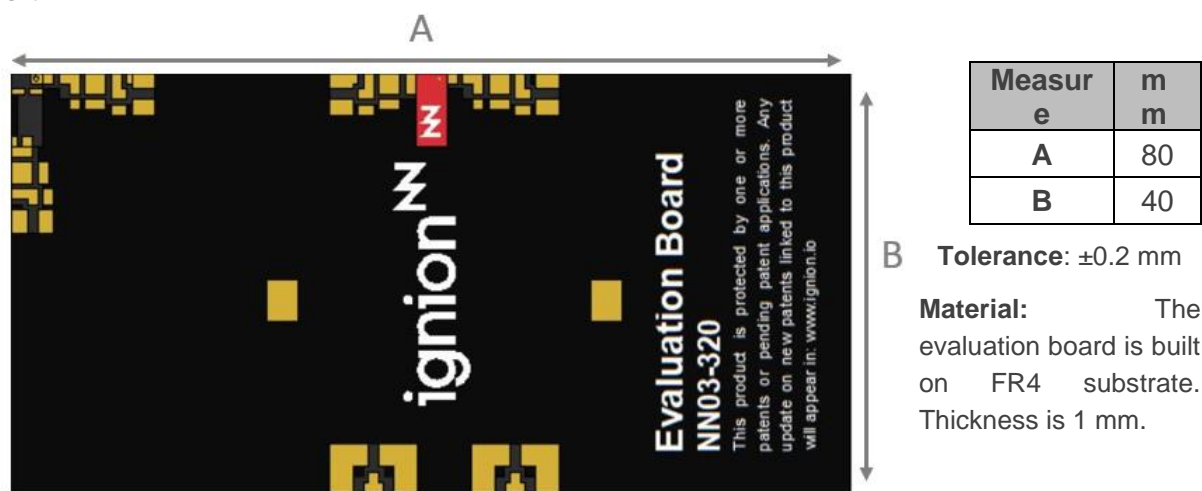

Figure 7 – EB_NN03-320-m-5G. Evaluation Board providing operation at 5G band (from 3.4 GHz to 3.8 GHz). Notice that the clearance area is equal to the DUO mXTEND™ footprint.

This product and/or its use is protected by at least one or more of the following patents and patent applications US 62,777,835, EP 18211745.7, US 15,835,007; and other domestic and international patents pending. Additional information about patents related to this product is available at www.ignion.io/virtual-antenna/.

MATCHING NETWORK

The antenna performance is always conditioned by its operating environment. Different devices with different printed circuit board sizes, components nearby the antenna, LCD's, batteries, covers, connectors, etc. affect the antenna performance. Accordingly, it is highly recommended placing pads compatible with 0402 and 0603 SMD components for a matching network as close as possible to the feeding point of the antenna element. Do it in the ground plane area, not in the clearance area. This provides a degree of freedom to tune the DUO mXTEND™ antenna booster once the design is finished and taking into account all elements of the system (batteries, displays, covers, etc.).

This section will present the proposed matching network and specs measured in the corresponding evaluation board (

Figure 7), which is an ideal case. Please note that different devices with different ground planes and different components nearby the DUO mXTEND™ antenna booster may need a different matching network. To ensure optimal results, the use of high-quality factor (Q) and tight tolerance components is highly recommended (e.g. Murata components (Figure)).

If you need assistance to design your matching network, please contact support@ignion.io, or try our free-of-charge¹ **NN Wireless Fast-Track** design service, you will get your chip antenna design including a custom matching network for your device in 24h². Other related to NN's range of R&D services is available at: <https://www.ignion.io/rdservices/>

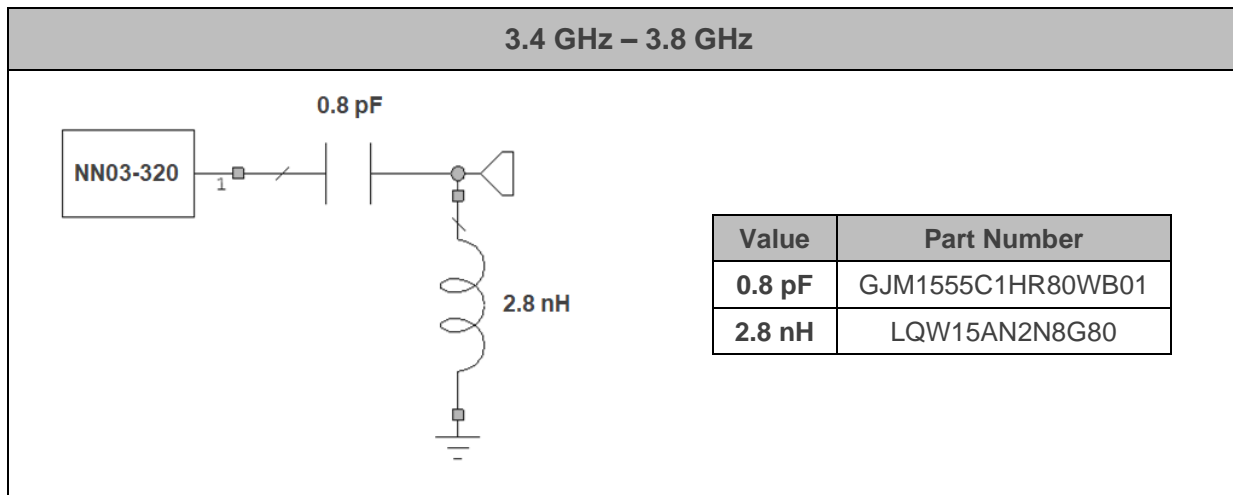

Figure 8 – Matching Network implemented in the evaluation board (Figure 7).

² See terms and conditions for a free NN Wireless Fast-Track service in 24h at: <https://www.ignion.io/fast-track-project/>

VSWR AND TOTAL EFFICIENCY

VSWR (Voltage Standing Wave Ratio) and Total Efficiency versus Frequency (GHz).

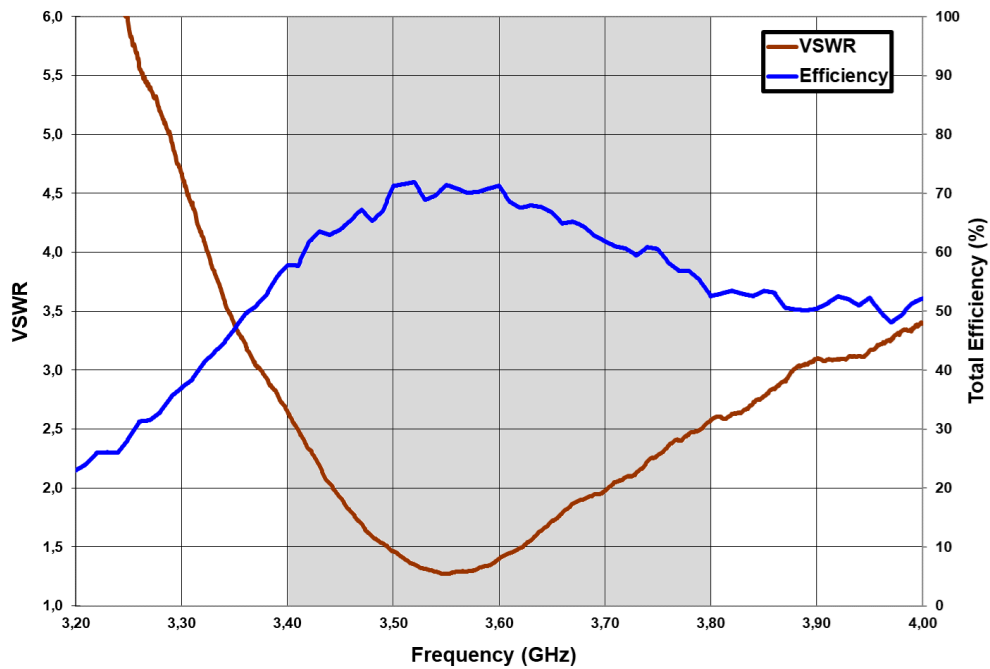

Figure 9 – VSWR and Total Efficiency for 5G band (3.4 – 3.8 GHz) from the evaluation board Figure 7.

RECOMMENDED ANTENNA FOOTPRINT FOR NN03-320

Assuming that the DUO mXTEND™ antenna booster (NN03-320) is placed in the middle of the PCB, see below the recommended footprint dimensions.

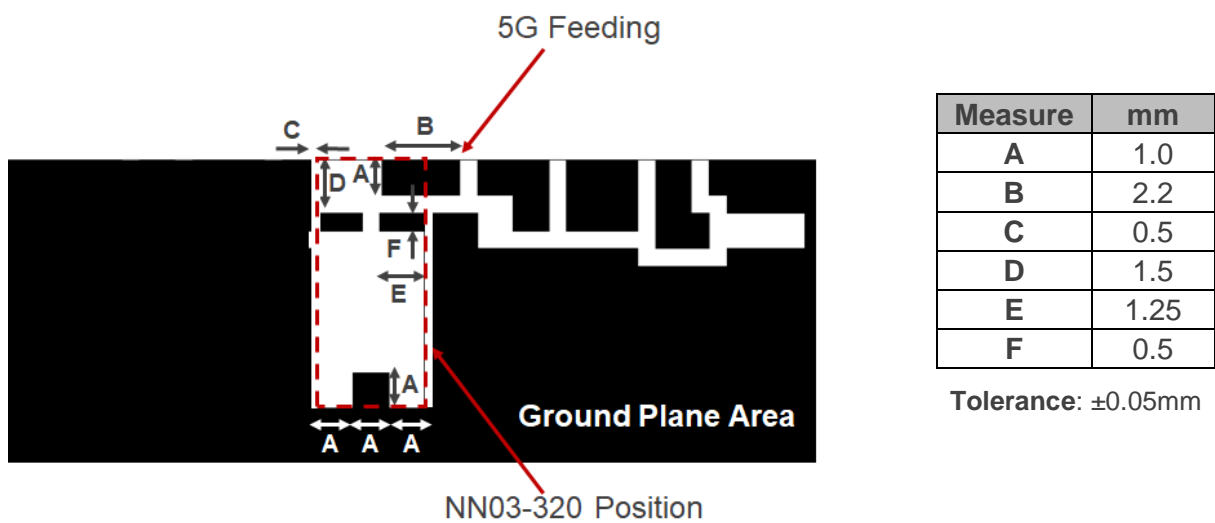
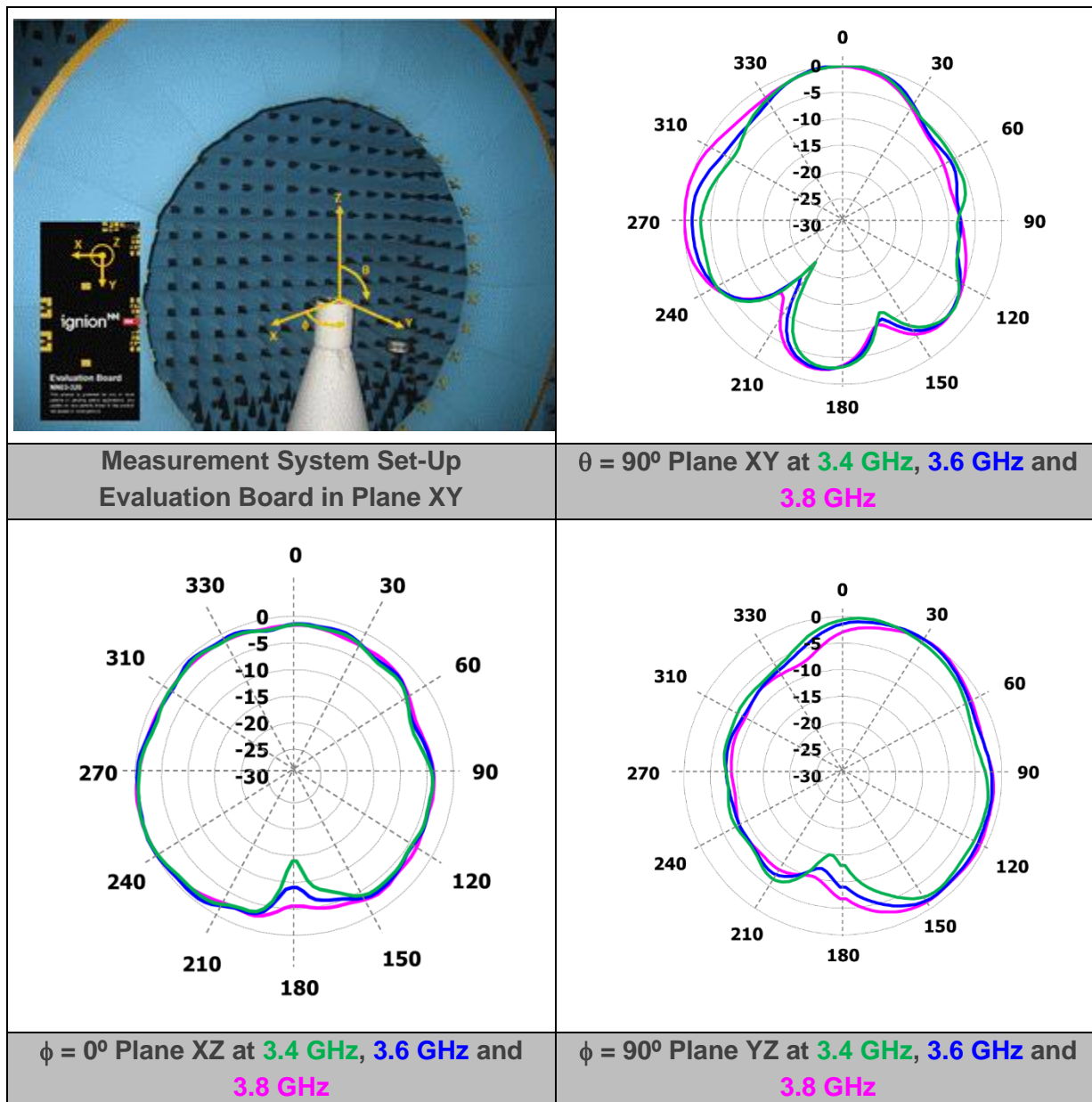

Figure 10 – Footprint dimensions for the NN03-320 in the middle for 5G.

For additional support in the integration process, please contact support@ignion.io.

RADIATION PATTERNS (3.4, 3.6 and 3.8 GHz), GAIN, AND EFFICIENCY



5G	Gain	Peak Gain	2.6 dBi
		Average Gain across the band	2.2 dBi
		Gain Range across the band (min, max)	1.7 \leftrightarrow 2.6 dBi
	Efficiency	Peak Efficiency	71.9 %
		Average Efficiency across the band	64.9 %
		Efficiency Range across the band (min, max)	52.55 – 71.9 %

Table 5 – Antenna Gain and Total Efficiency from the evaluation board (Figure 7) for 3.4GHz-3.8GHz band. Measures made in the Satimo STARGATE 32 anechoic chamber

DUO mXTEND for UWB

The DUO mXTEND[™] can be used to operate all common **UWB** frequency bands in a single port configuration, namely **bands 1-14** ranging from: **3.1GHz up to 10.6GHz**. Using one of our Evaluation Boards, an example of a common DUO mXTEND[™] placement is seen. Finally, two different matching network options are shown, for both LFR and HFR, allowing us to test, obtain, and analyze the VSWR, total efficiency, gain and radiation patterns and compare the two frequency ranges.

QUICK REFERENCE GUIDE

Technical features	Option 1 UWB (LFR)	Option 2 UWB (HFR)
	3.1 – 4.8 GHz	6.0 – 10.6 GHz
Average Efficiency	> 80%	> 80%
Peak Gain	2.3 dBi	3.6 dBi
VSWR	< 2.6:1	< 4.0:1
Radiation Pattern	Omnidirectional	
Polarization	Linear	
Weight (approx.)	0.11 g.	
Temperature	-40 to + 125 °C	
Impedance	50 Ω	
Dimensions (L x W x H)	7.0 mm x 3.0 mm x 2.0 mm	

Table 6 – Technical Features. Measures from the Evaluation Board. See Figure 11.

EVALUATION BOARD UWB

The Evaluation Board EB_NN03-320-UWB integrates the DUO mXTEND[™] antenna booster to provide operation in the frequency region going from 3.1 GHz to 10.6 GHz, through a single input/output port.

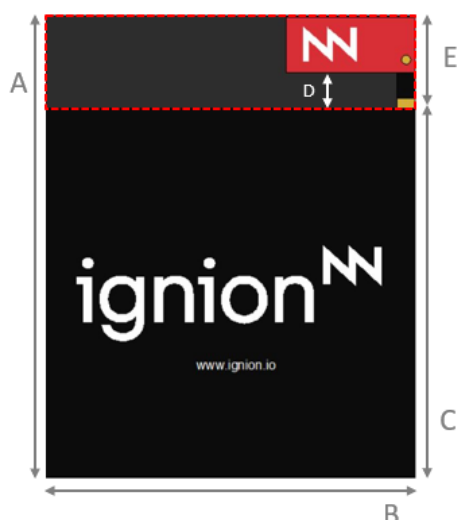

Measure	mm
A	25.0
B	20.0
C	20.0
D	2.0
E	5.0

Tolerance: ±0.2 mm

D: Distance between the DUO mXTEND[™] antenna booster and the ground plane.

Material: The Evaluation Board is built on FR4 substrate. Thickness is 1 mm.

Clearance Area: 20.0 mm x 5.0 mm (B x E)

Figure 11 – EB_NN03-320-UWB. Evaluation Board providing operation at UWB (from 3.1 GHz to 10.6 GHz).

This product and/or its use is protected by at least one or more of the following [patents and patent applications](#) PAT. US 9,865,917 B2, WO 2019/008171, US 16/731755, EP 18736916.0, CN 201880045357.8; and other domestic and international patents pending. Additional information about patents related to this product is available at www.ignion.io/virtual-antenna

MATCHING NETWORK

DUO mXTEND[™] antenna booster needs a matching network to connect to your UWB RF module. This section presents the proposed matching network and specifications obtained in the corresponding Evaluation Board (**Figure 11**), which is an ideal case. Thanks to its versatility the DUO mXTEND[™] antenna booster can be easily tuned to cover different regions of the UWB spectrum through just the proper adjustment of the matching network. The excellent tuning capabilities of the DUO mXTEND[™] makes it ideal to avoid unnecessary product redesigns each time your product specifications and operating frequencies vary. It allows you to easily adapt your design to different applications, market segments, and devices through just the proper design of the matching network by maintaining the same antenna part.

Two different options with two different matching networks are presented herein to illustrate this flexibility. The first one is used to properly tune the antenna performance to UWB channels ranging from 3.1-4.8GHz (Option 1). The second one can be used to cover channels operating from 6.0-10.6GHz (Option 2).

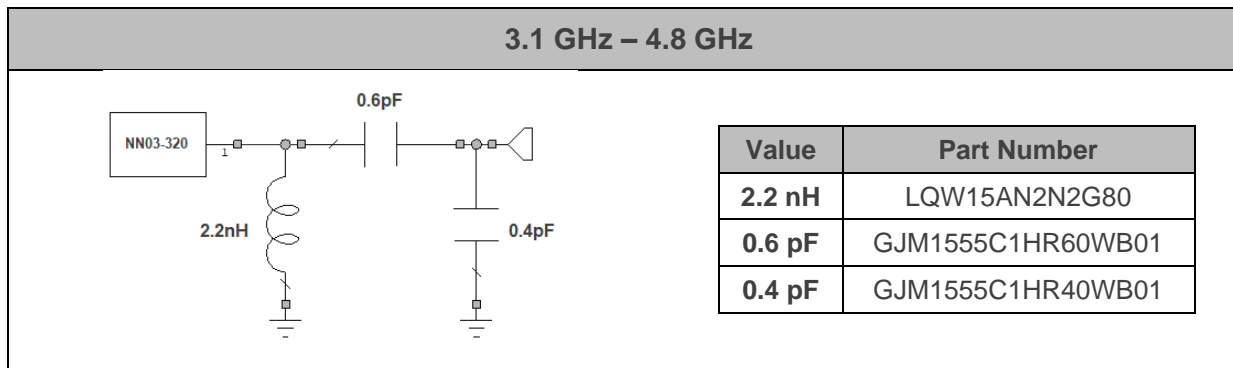

Figure 12 – Matching network implemented in the Evaluation Board (**Figure 11**) for covering the low frequency region from 3.1GHz to 4.8GHz.

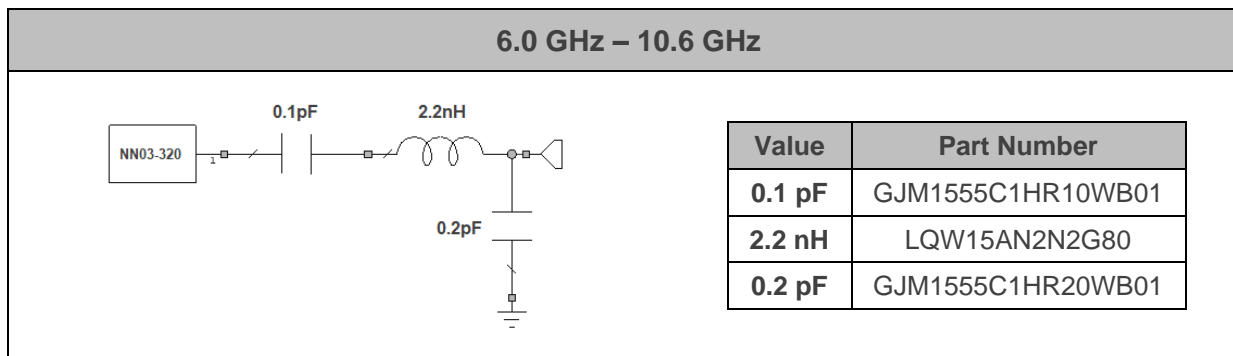

Figure 13 – Matching network implemented in the Evaluation Board (**Figure 11**) for covering the high frequency region from 6.0GHz to 10.6GHz.

The antenna performance is always conditioned by its operating environment. Different devices with different printed circuit board sizes, components nearby the antenna, LCD's, batteries, covers, connectors, etc. may need a different matching network. Accordingly, it is highly recommended placing pads compatible with 0402 and 0603 SMD components for a matching network as close as possible to the feeding point of the antenna element in the ground plane area, not in the clearance area. This provides a degree of freedom to tune the DUO mXTEND™ antenna booster once the design is finished and taking into account all elements of the system (batteries, displays, covers, etc.). To ensure optimal results, the use of high-quality factor (Q) and tight tolerance components is highly recommended (e.g. Murata components (Figure 12)).

If you need assistance to design your matching network, please contact support@ignion.io, or if you are designing a **different device size** or a **different band of the UWB spectrum**, we **can assist you** in less than 24 hours. Please, try our free-of-charge¹ **NN Wireless Fast-Track** design service (<https://www.ignion.io/fast-track-project/>), you will get your chip antenna design including a custom matching network for your device in 24h³. Other related to NN's range of R&D services is available at: <https://www.ignion.io/rdservices/>

³ See terms and conditions for a free NN Wireless Fast-Track service in 24h at: <https://www.ignion.io/fast-track-project/>

VSWR AND TOTAL EFFICIENCY

VSWR (Voltage Standing Wave Ratio) and total efficiency versus frequency (GHz).

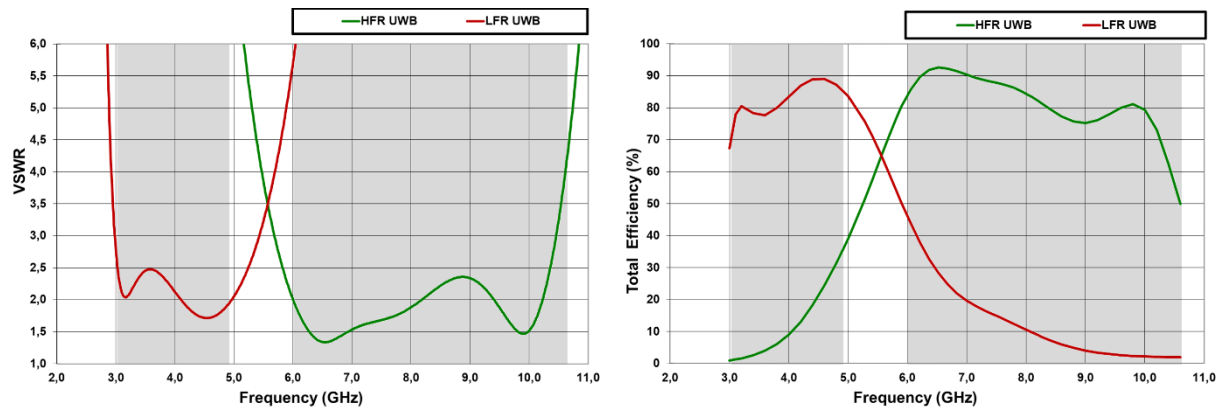

Figure 14 – VSWR and total efficiency for the UWB LFR (3.1GHz – 4.8GHz) and for the UWB HFR (6.0GHz – 10.6GHz) from the Evaluation Board (**Figure 11** with the matching networks gathered in **Figure 12** (LFR UWB) and **Figure 13** (HFR UWB), respectively. Simulated results obtained with CST.

RECOMMENDED ANTENNA FOOTPRINT FOR NN03-320

The DUO mXTEND™ antenna booster (NN03-320) can be placed close to a corner or the PCB or close to the center of the longitudinal PCB edge. See below the recommended footprint dimensions when it is placed close to a corner of the PCB with the feeding line aligned with the longest side of the board according to the Evaluation Board (**Figure 11**).

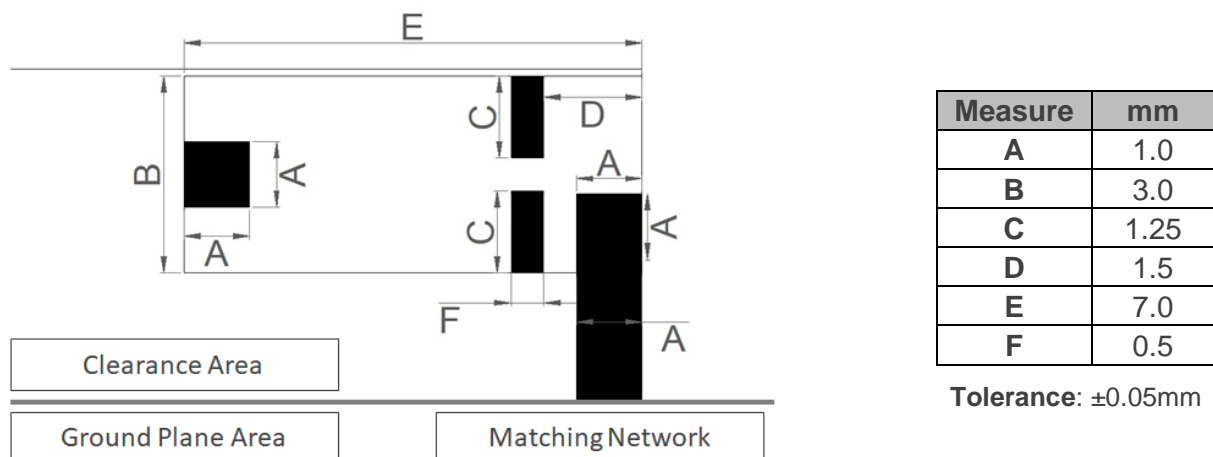
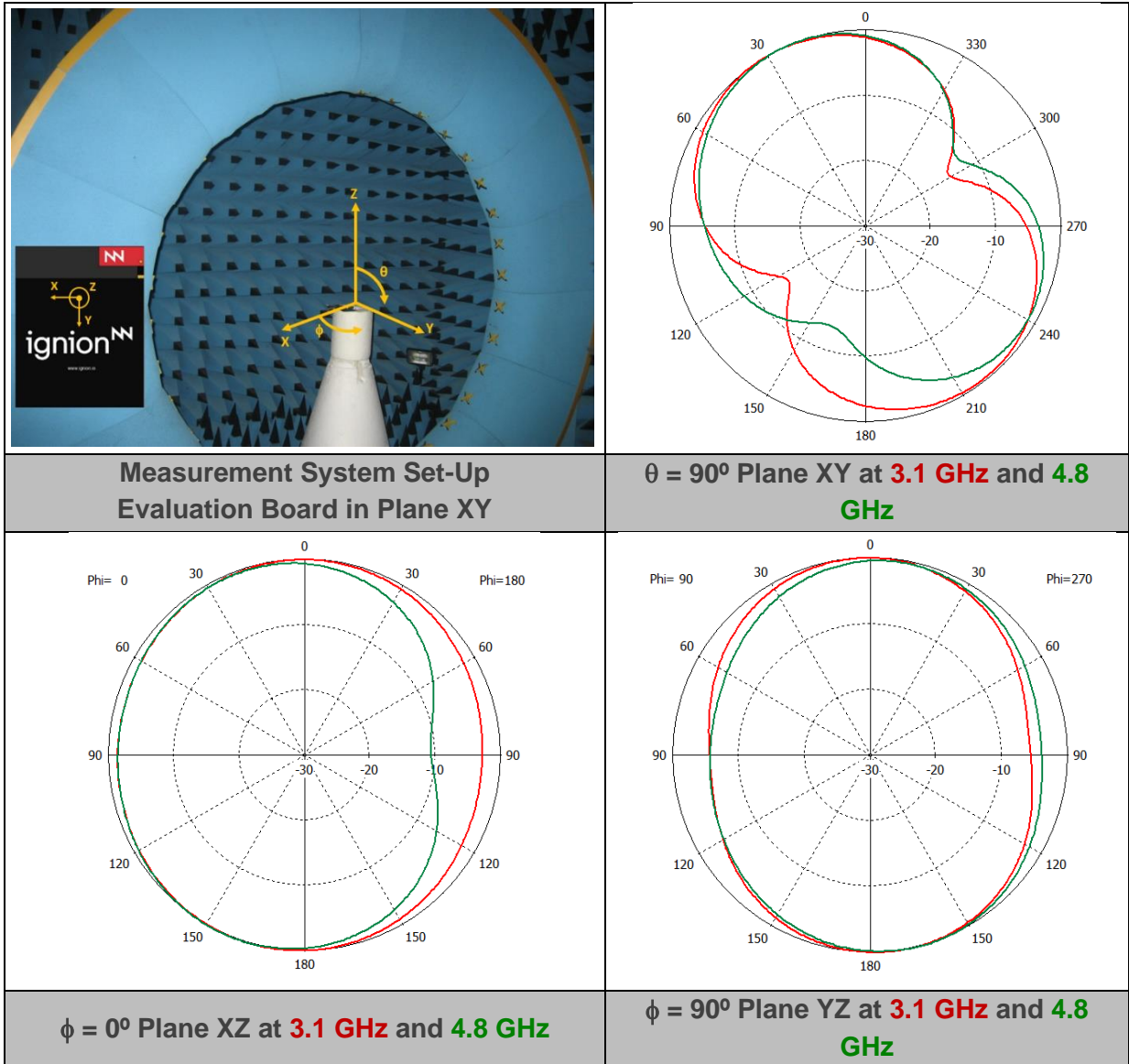

Figure 15 – Footprint dimensions for the NN03-320 in the corner for UWB.

For additional support in the integration process, please contact support@ignion.io.

RADIATION PATTERNS UWB (3.1 to 4.8 GHz), GAIN, AND EFFICIENCY



LFR UWB 3.1-4.8GHz	Gain	Peak Gain	2.3 dBi
		Average Gain across the band	1.7 dBi
		Gain Range across the band (min, max)	1.1 <-> 2.3 dBi
	Efficiency	Peak Efficiency	89.0 %
		Average Efficiency across the band	83.0 %
		Efficiency Range across the band (min, max)	77.7 – 89.0 %

Table 7 – Antenna gain and total efficiency from the Evaluation Board (Figure 11) for 3.1GHz – 4.8GHz with the matching network of Figure 12. Simulated results obtained with CST.

RADIATION PATTERNS UWB (6.0 to 10.6 GHz), GAIN, AND EFFICIENCY

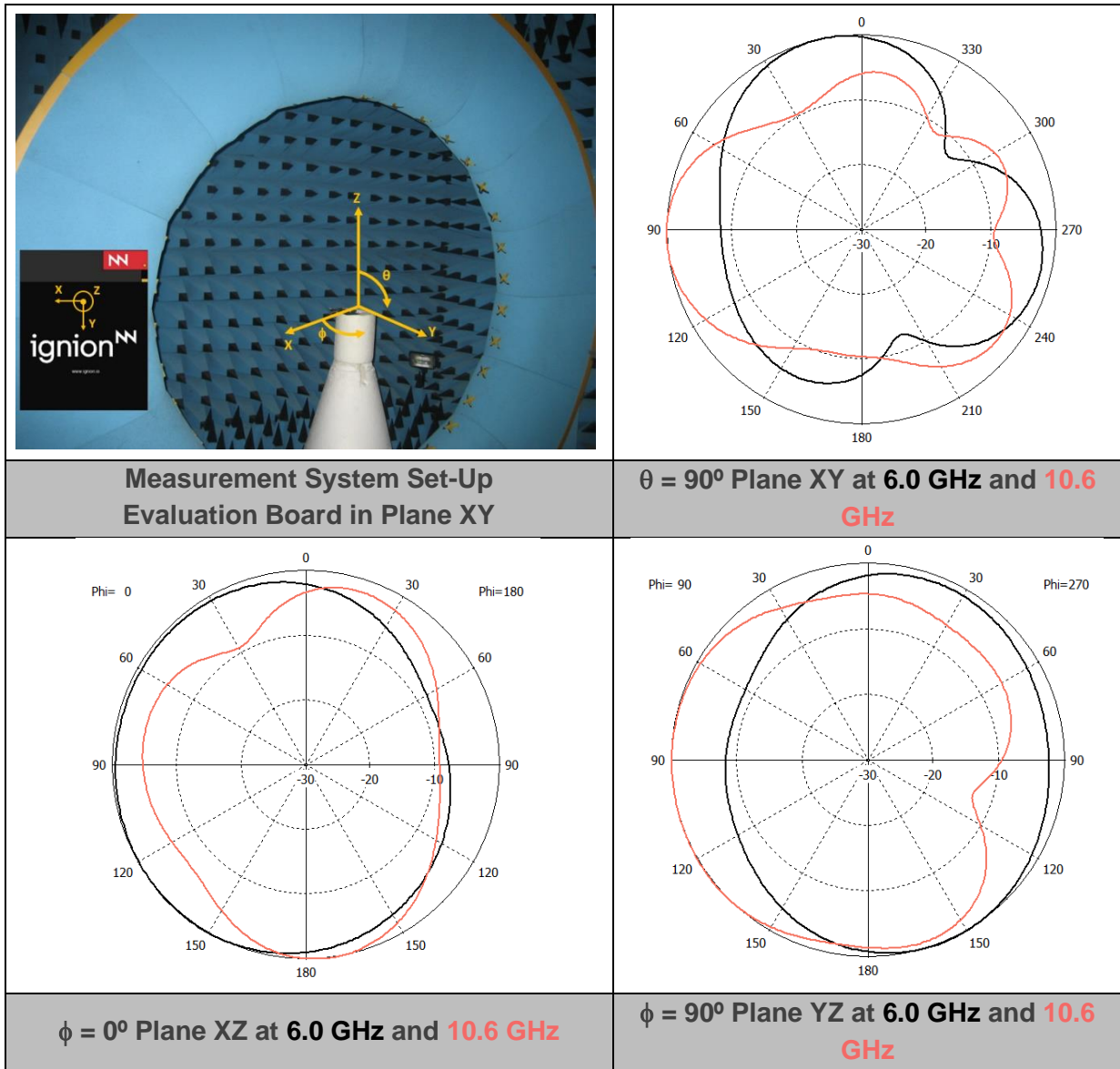

HFR UWB 6.0-10.6GHz	Gain	Peak Gain	3.6 dBi
		Average Gain across the band	3.0 dBi
		Gain Range across the band (min, max)	1.5 <-> 3.6 dBi
	Efficiency	Peak Efficiency	92.6 %
		Average Efficiency across the band	82.2 %
		Efficiency Range across the band (min, max)	50.0 – 92.6 %

Table 8 – Antenna Gain and Total Efficiency from the Evaluation Board (Figure 11) for 6.0GHz – 10.6GHz band considering the matching network in Figure . Simulated results obtained with CST.

MECHANICAL SPECIFICATIONS

DIMENSIONS, TOLERANCES, AND RoHS

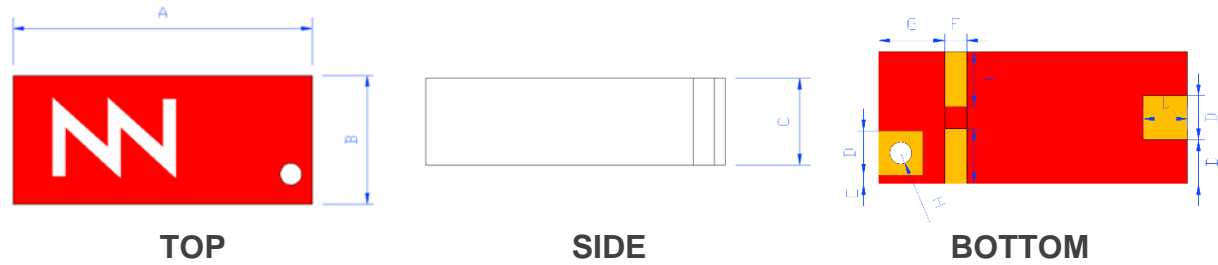

Dimension	mm	Dimension	mm
A	7.0 ± 0.2	B	3.0 ± 0.2
C	2.0 ± 0.1	D	1.0 ± 0.15
E	0.2 ± 0.1	F	0.5 ± 0.1
G	1.5 ± 0.1	H	R0.25 ± 0.1
I	1.25 ± 0.1		

Figure 16 – DUO mXTEND[™] antenna booster dimensions and tolerances.

The DUO mXTEND[™] antenna booster NN03-320 is compliant with the restriction of the use of hazardous substances (RoHS). For more information, please contact info@ignion.io.

COLOR RANGE FOR THE INK

Next figure shows the range of the colors in the DUO mXTEND[™] antenna booster:

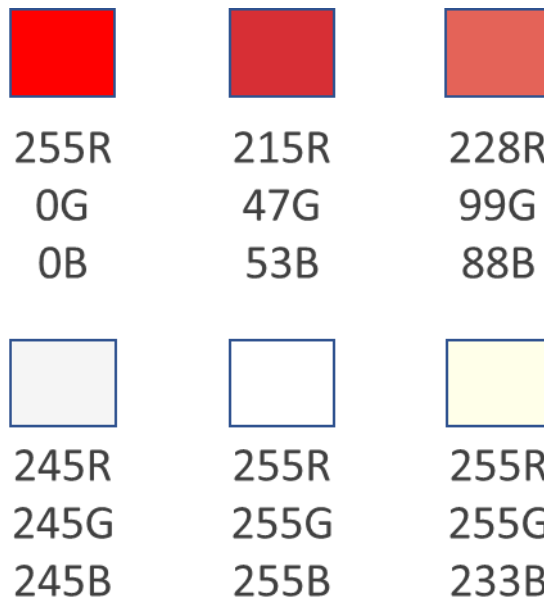

ANTENNA FOOTPRINT

See below the recommended footprint dimensions for the DUO mXTEND™ antenna booster NN03-320.

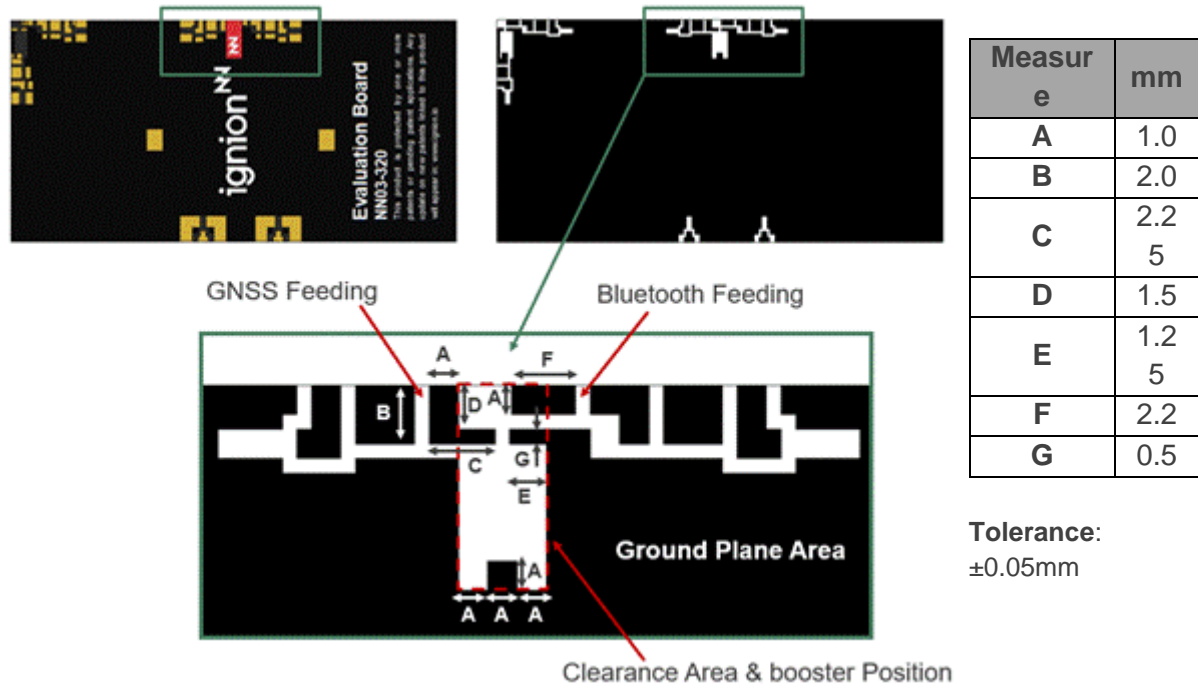

Figure 17 – Footprint dimensions for the DUO mXTEND™ (NN03-320) antenna booster.

For additional support in the integration process, please contact support@ignion.io.

ASSEMBLY AND MANUFACTURING

Figure 18 shows the back and front views of the DUO mXTEND[™] antenna booster (NN03-320).

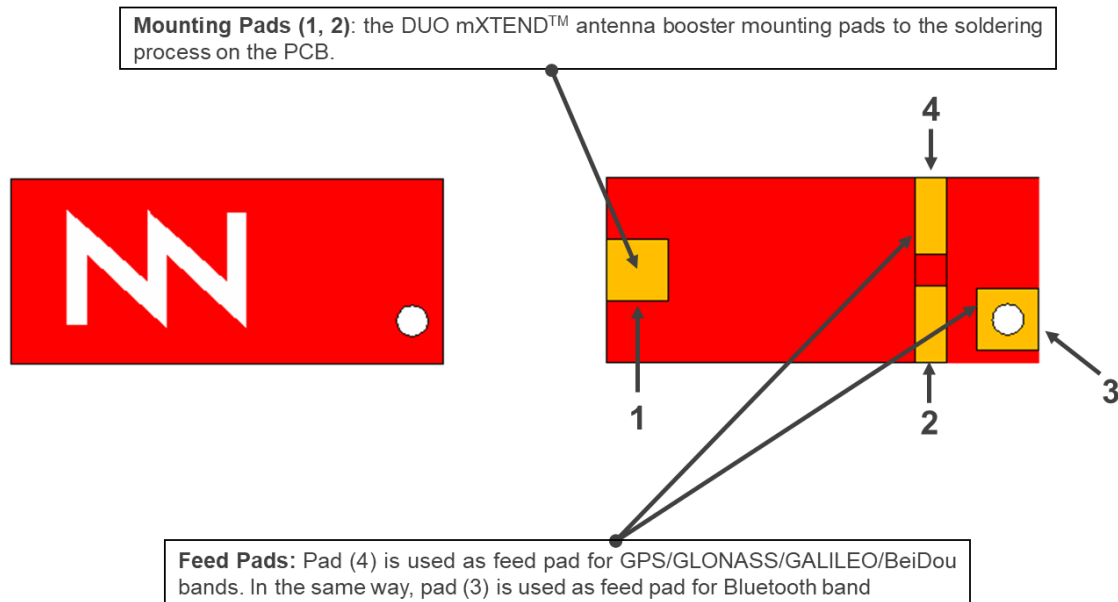

Figure 18 – Pads of the DUO mXTEND[™] antenna booster NN03-320.

As a surface mount device (SMD), the DUO mXTEND[™] antenna booster is compatible with industry standard soldering processes. The basic assembly procedure for the DUO mXTEND[™] antenna booster is as follows:

1. Apply a solder paste on the pads of the PCB. Place the DUO mXTEND[™] antenna booster on the board.
2. Perform a reflow process according to the temperature profile detailed in Table 9, Figure 20.
3. After soldering the DUO mXTEND[™] antenna booster to the circuit board, perform a cleaning process to remove any residual flux. Ignion recommends conducting a visual inspection after the cleaning process to verify that all reflux has been removed.

The drawing below shows the soldering details obtained after a correct assembly process:

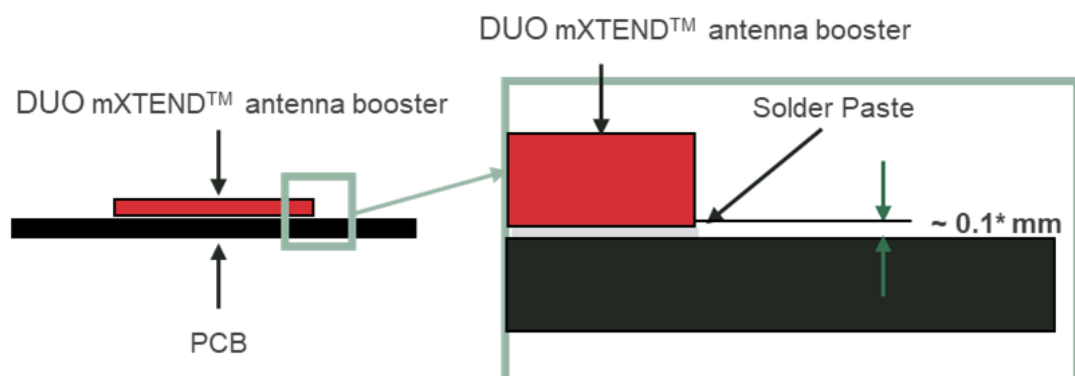

Figure 19 – Soldering Details.

NOTE(*): Solder paste thickness after the assembly process will depend on the thickness of the soldering stencil mask. A stencil thickness equal or larger than 127 microns (5 mils) is required.

The DUO mXTEND[™] antenna booster (NN03-320) can be assembled following the Pb-free assembly process. According to the Standard **IPC/JEDEC J-STD-020C**, the temperature profile suggested is as follows:

Phase	Profile features	Pb-Free Assembly (SnAgCu)
RAMP-UP	Avg. Ramp-up Rate (T _{smax} to T _p)	3 °C / second (max.)
PREHEAT	- Temperature Min (T _{smin}) - Temperature Max (T _{smax}) - Time (t _{smin} to t _{smax})	150 °C 200 °C 60-180 seconds
REFLOW	- Temperature (T _L) - Total Time above T _L (t _L)	217 °C 60-150 seconds
PEAK	- Temperature (T _p) - Time (t _p)	260 °C 20-40 seconds
RAMP-DOWN	Rate	6 °C/second max
Time from 25 °C to Peak Temperature		8 minutes max

Table 9 – Recommended soldering temperatures.

Next graphic shows temperature profile (grey zone) for the DUO mXTEND[™] antenna booster assembly process reflow ovens.

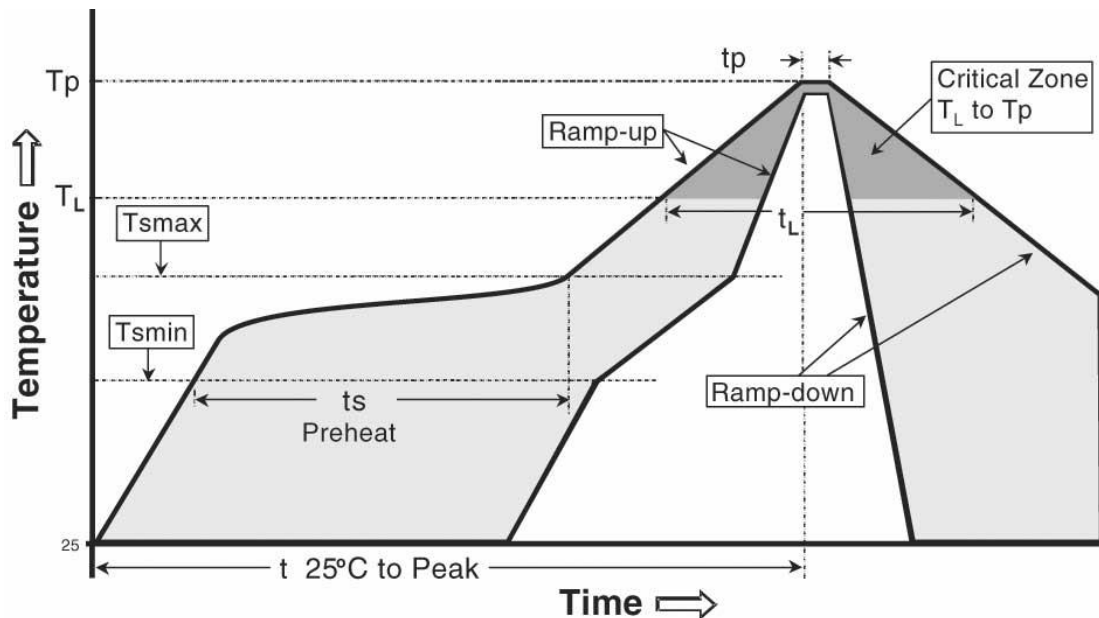
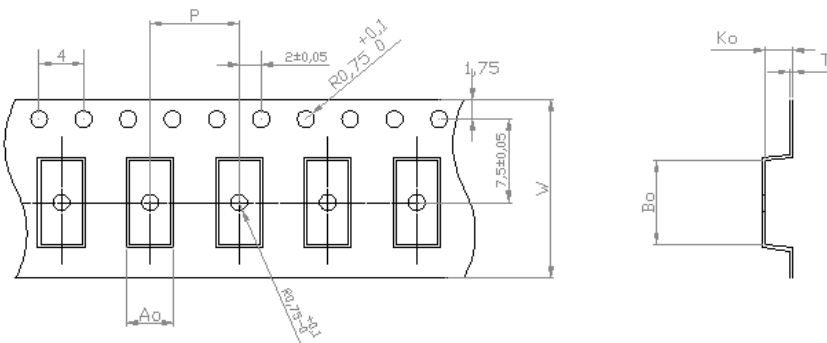

Figure 20 – Temperature profile.

PACKAGING

The DUO mXTEND™ antenna booster NN03-320 is delivered in tape and reel packaging.



Measure	mm
A0	3.6 ± 0.1
B0	7.5 ± 0.1
K0	2.5 ± 0.1
W	16.0 ± 0.3
P	8.0 ± 0.1
T	0.3 ± 0.05

Figure 21 – Tape dimensions and tolerances.

REEL DIMENSIONS

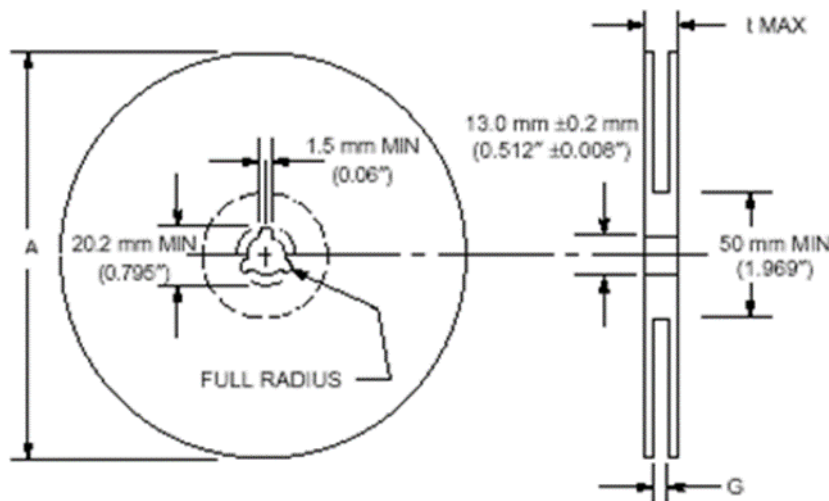

Measure	mm
A	330 ± 1.0
G	16.4 ± 0.1
t max	20.4 ± 0.1

Reel Capacity: 2500 pcs

Figure 22 – Reel dimensions and capacity.

Ignion products and solutions are protected by [Ignion patents](#).

All information contained within this document is property of Ignion and is subject to change without prior notice. Information is provided “as is” and without warranties. It is prohibited to copy or reproduce this information without prior approval.

Ignion is an ISO 9001:2015 certified company. All our antennas are lead-free and RoHS compliant.

ISO 9001: 2015 Certified



This project has received funding from CDTI
under grant agreement IDI-20190285





Your innovation.
Accelerated.

Contact:
support@ignion.io
+34 935 660 710

Barcelona

Av. Alcalde Barnils, 64-68 Modul C, 3a pl.
Sant Cugat del Vallés
08174 Barcelona
Spain

Shanghai

Shanghai Bund Centre
18/F Bund Centre, 222 Yan'an Road East,
Huangpu District
Shanghai, 200002
China

New Dehli

New Delhi, Red Fort Capital Parsvnath Towers
Bhai Veer Singh Marg, Gole Market,
New Delhi, 110001
India

Tampa

8875 Hidden River Parkway
Suite 300
Tampa, FL 33637
USA