

<b>Prüfbericht-Nr.:</b> <i>Test Report No.:</i>	<b>50199559 001</b>	<b>Auftrags-Nr.:</b> <i>Order No.:</i>	114082904	<b>Seite 1 von 50</b> <i>Page 1 of 50</i>
<b>Kunden-Referenz-Nr.:</b> <i>Client Reference No.:</i>	N/A	<b>Auftragsdatum:</b> <i>Order date:</i>	16-Oct-2018	
<b>Auftraggeber:</b> <i>Client:</i>	Corsair Memory, Inc. 47100 Bayside Parkway, Fremont, CA 94538, United States			
<b>Prüfgegenstand:</b> <i>Test item:</i>	Elgato Key Light			
<b>Bezeichnung / Typ-Nr.:</b> <i>Identification / Type No.:</i>	20GAK9901			
<b>Auftrags-Inhalt:</b> <i>Order content:</i>	FCC Part 15C, IC RSS-247 Test report			
<b>Prüfgrundlage:</b> <i>Test specification:</i>	FCC 47CFR Part 15: Subpart C Section 15.247 RSS-247 (02-2017)			
<b>Wareneingangsdatum:</b> <i>Date of receipt:</i>	22-Oct-2018			
<b>Prüfmuster-Nr.:</b> <i>Test sample No.:</i>	A000818888-005 A000818888-006			
<b>Prüfzeitraum:</b> <i>Testing period:</i>	25-Oct-2018 - 11-Dec-2018			
<b>Ort der Prüfung:</b> <i>Place of testing:</i>	EMC/RF Laboratory Taipei			
<b>Prüflaboratorium:</b> <i>Testing laboratory:</i>	TUV Rheinland Taiwan Ltd.			
<b>Prüfergebnis*:</b> <i>Test result*:</i>	Pass			
<b>geprüft von / tested by:</b>		<b>kontrolliert von / reviewed by:</b>		
2018-12-11	Mars Y. J. Lin / Project Engineer	2018-12-11	Ryan W. T. Chen / Project Manager	
<b>Datum</b> <i>Date</i>	<b>Name / Stellung</b> <i>Name / Position</i>	<b>Unterschrift</b> <i>Signature</i>	<b>Datum</b> <i>Date</i>	<b>Name / Stellung</b> <i>Name / Position</i>
				<b>Unterschrift</b> <i>Signature</i>
<b>Sonstiges / Other:</b>				
<b>Zustand des Prüfgegenstandes bei Anlieferung:</b> <i>Condition of the test item at delivery:</i>		Prüfmuster vollständig und unbeschädigt <i>Test item complete and undamaged</i>		
* Legende:	1 = sehr gut P(ass) = entspricht o.g. Prüfgrundlage(n)	2 = gut F(ail) = entspricht nicht o.g. Prüfgrundlage(n)	3 = befriedigend N/A = nicht anwendbar	4 = ausreichend N/T = nicht getestet
Legend:	1 = very good P(ass) = passed a.m. test specification(s)	2 = good F(ail) = failed a.m. test specification(s)	3 = satisfactory N/A = not applicable	4 = sufficient N/T = not tested
<p><b>Dieser Prüfbericht bezieht sich nur auf das o.g. Prüfmuster und darf ohne Genehmigung der Prüfstelle nicht auszugsweise vervielfältigt werden. Dieser Bericht berechtigt nicht zur Verwendung eines Prüfzeichens.</b>  <i>This test report only relates to the a. m. test sample. Without permission of the test center this test report is not permitted to be duplicated in extracts. This test report does not entitle to carry any test mark.</i></p>				

## TEST SUMMARY

### 5.1.1 ANTENNA REQUIREMENT

RESULT: *Passed*

### 5.1.2 PEAK OUTPUT POWER

RESULT: *Passed*

### 5.1.3 6dB BANDWIDTH AND 99% BANDWIDTH

RESULT: *Passed*

### 5.1.4 POWER DENSITY

RESULT: *Passed*

### 5.1.5 CONDUCTED SPURIOUS EMISSIONS AND FREQUENCY BAND EDGE MEASURED IN 100KHZ BANDWIDTH

RESULT: *Passed*

### 5.1.6 SPURIOUS EMISSION

RESULT: *Passed*

### 5.2.1 MAINS CONDUCTED EMISSIONS

RESULT: *Passed*

### 6.1.1 ELECTROMAGNETIC FIELDS

RESULT: *Passed*

## Contents

<b>1.</b>	<b>GENERAL REMARKS .....</b>	<b>5</b>
<b>1.1</b>	<b>COMPLEMENTARY MATERIALS.....</b>	<b>5</b>
<b>2.</b>	<b>TEST SITES .....</b>	<b>6</b>
<b>2.1</b>	<b>TEST LABORATORY .....</b>	<b>6</b>
<b>2.2</b>	<b>TEST FACILITIES.....</b>	<b>6</b>
<b>2.3</b>	<b>LIST OF TEST AND MEASUREMENT INSTRUMENTS.....</b>	<b>7</b>
<b>2.4</b>	<b>TRACEABILITY .....</b>	<b>8</b>
<b>2.5</b>	<b>CALIBRATION .....</b>	<b>8</b>
<b>2.6</b>	<b>MEASUREMENT UNCERTAINTY .....</b>	<b>8</b>
<b>3.</b>	<b>GENERAL PRODUCT INFORMATION.....</b>	<b>9</b>
<b>3.1</b>	<b>PRODUCT FUNCTION AND INTENDED USE .....</b>	<b>9</b>
<b>3.2</b>	<b>SYSTEM DETAILS AND RATINGS.....</b>	<b>9</b>
<b>3.3</b>	<b>INDEPENDENT OPERATION MODES.....</b>	<b>10</b>
<b>3.4</b>	<b>NOISE GENERATING AND NOISE SUPPRESSING PARTS .....</b>	<b>10</b>
<b>3.5</b>	<b>SUBMITTED DOCUMENTS.....</b>	<b>10</b>
<b>4.</b>	<b>TEST SET-UP AND OPERATION MODES.....</b>	<b>11</b>
<b>4.1</b>	<b>PRINCIPLE OF CONFIGURATION SELECTION .....</b>	<b>11</b>
<b>4.2</b>	<b>TEST OPERATION AND TEST SOFTWARE.....</b>	<b>12</b>
<b>4.3</b>	<b>ADDITIONAL ACCESSORIES AND AUXILIARY EQUIPMENT .....</b>	<b>12</b>
<b>4.4</b>	<b>COUNTERMEASURES TO ACHIEVE EMC COMPLIANCE.....</b>	<b>13</b>
<b>4.5</b>	<b>TEST SETUP DIAGRAM .....</b>	<b>13</b>
<b>5.</b>	<b>TEST RESULTS .....</b>	<b>15</b>
<b>5.1</b>	<b>TRANSMITTER REQUIREMENT &amp; TEST SUITES.....</b>	<b>15</b>
<b>5.1.1</b>	<i>Antenna Requirement .....</i>	<i>15</i>
<b>5.1.2</b>	<i>Peak Output Power .....</i>	<i>16</i>
<b>5.1.3</b>	<i>6dB Bandwidth and 99% Bandwidth .....</i>	<i>18</i>
<b>5.1.4</b>	<i>Power Density .....</i>	<i>30</i>
<b>5.1.5</b>	<i>Conducted spurious emissions and Frequency Band Edge measured in 100kHz Bandwidth.....</i>	<i>37</i>
<b>5.1.6</b>	<i>Spurious Emission .....</i>	<i>47</i>
<b>5.2</b>	<b>MAINS EMISSIONS.....</b>	<b>48</b>
<b>5.2.1</b>	<i>Mains Conducted Emissions.....</i>	<i>48</i>
<b>6.</b>	<b>SAFETY HUMAN EXPOSURE .....</b>	<b>49</b>

<b>6.1</b>	<b>RADIO FREQUENCY EXPOSURE COMPLIANCE .....</b>	<b>49</b>
6.1.1	<i>Electromagnetic Fields.....</i>	<i>49</i>
<b>7.</b>	<b>LIST OF TABLES .....</b>	<b>50</b>

## 1. General Remarks

### 1.1 Complementary Materials

The following attachments are integral parts of this test report:

- Appendix P: Photo Documentation**  
(File Name: 50199559 001 Appendix P)
- Appendix D: Test Result of Radiated Emissions**  
(File Name: 50199559 001 Appendix D)
- Appendix X: Photographs of the Test Set-Up**  
(File Name: 50199559 001 Appendix X)

Test Specifications

The following standards were applied (in bold: product standards, otherwise: basic standards).

**Table 1: Applied Standard and Test Levels**

<b>Radio</b>
FCC CFR47 Part 15: Subpart C Section 15.247 RSS-247 Issue 2 Feb 2017 ANSI C63.10:2013 KDB558074 D01 DTS Meas Guidance v05

## 2. Test Sites

### 2.1 Test Laboratory

TUV Rheinland Taiwan Ltd.  
Taichung Branch Office

No.9, Lane 36, Minsheng Rd., Sec. 3, Daya District,  
Taichung City 428  
Taiwan (R.O.C.)

### 2.2 Test Facilities

TUV Rheinland Taiwan Ltd.  
Taipei Office

11F. No.758, Sec. 4, Bade Rd., Songshan Dist.  
Taipei City 105  
Taiwan (R.O.C.)

FCC RegistrationNo.: 340738  
IC Canada Registration No.: 9465A-1  
TAF Accredited NCC Test Lab. No.:0759  
TAF ISO17025 Certification effective periods: 2016-Jul-1st to 2019-Jun-30th



**Testing Laboratory**  
**0759**

## 2.3 List of Test and Measurement Instruments

**Table 2: List of Test and Measurement Equipment**

Kind of Equipment	Manu-facturer	Type	S/N	Last Calibration	Next Calibration
Test Software	Farad	EZ_EMCC	Ver. TUV3A1	N/A	N/A
EMI Test Receiver	R&S	ESR7	101062	2018/09/12	2019/09/12
Spectrum Analyzer	R&S	FSV 40	100921	2018/04/21	2019/04/21
Spectrum Analyzer	Agilent	N9010A	MY53470241	2018/04/25	2019/04/24
Preamplifier (30MHz -1GHz)	HP	8447F	2805A03335	2018/07/29	2019/07/29
Preamplifier (18 GHz -40 GHz)	COM-POWER	PAM-840	461257	2018/11/02	2019/11/02
Pre-Amplifier (1GHz~18GHz)	EM Electronics	EM01G18G	060558	2018/11/02	2019/11/02
Bilog Antenna	TESEQ	CBL6111D	29804	2018/06/23	2019/06/23
Horn Antenna	ETS-Lindgren	3117	138160	2018/05/03	2019/05/03
Horn Antenna (18GHz~40GHz)	COM-POWER	AH840	101031	2019/11/02	2019/11/02
EMI Test Receiver	R&S	ESCI7	100797	2017/12/28	2018/12/27
Temp. & Humid. Chamber	Giant Force	GCT-099-40-S	MAF0103-007	2018/07/13	2019/07/12
LISN (1 phase)	R&S	ENV216	101243	2018/06/02	2019/06/02
LISN	R&S	ENV216	101262	2018/06/16	2019/06/16
Test Software	Audix	e3	Ver. 9	N/A	N/A
Test Software	Agilent	300328 testssystem	V1.9.1	N/A	N/A
Power sensor	Agilent	U2021XA	MY53480013	2018/03/11	2019/03/10

## 2.4 Traceability

All measurement equipment calibrations are traceable to NML(Taiwan)/NIST(USA) or where calibration is performed outside Taiwan, to equivalent nationally recognized standards organizations.

## 2.5 Calibration

Equipment requiring calibration is calibrated periodically by the manufacturer or according to manufacturer's specifications. Additionally all equipment is verified for proper performance on a regular basis using in house standards or comparisons.

## 2.6 Measurement Uncertainty

The estimated combined standard uncertainty for radiated emissions and conducted emissions measurements are  $\pm 3$ dB.

**Table 3: Emission Measurement Uncertainty**

Parameter	Uncertainty
RF power, conducted	$\pm 1.5$ dB
Adjacent channel power	$\pm 3$ dB
Radiated emission of transmitter, valid up to 26 GHz	$\pm 6$ dB
Radiated emission of receiver, valid up to 26 GHz	$\pm 6$ dB
Temperature	$\pm 2$ °C
Humidity	$\pm 10$ %



### 3. General Product Information

#### 3.1 Product Function and Intended Use

The EUT is a Elgato Key Light. It contains a WiFi compatible module enabling the user to communicate data through a Wireless interface.  
For details refer to the User Guide, Data Sheet and Circuit Diagram.

#### 3.2 System Details and Ratings

**Table 4: Basic Information of EUT**

Item	EUT information
Kind of Equipment	Elgato Key Light
Type Designation	20GAK9901
FCC ID	2AAFM-LGHT001
IC ID	10954A-LGHT001
HVIN	20GAK9901

**Table 5: Technical Specification of EUT**

Technical Specification	Value
Operating Frequencies	2412~2462 MHz
Channel Spacing	5MHz
Channel number	11
Operation Voltage	100-240Vac
Modulation	802.11b: DSSS 802.11g/n: OFDM with BPSK, QPSK, QAM
Antenna gain	2.01dBi

### 3.3 Independent Operation Modes

Basic operation modes are:

- A. Transmitting
  - 1. Low channel
  - 2. Middle channel
  - 3. High channel
- B. Receiving
- C. Standby
- D. Off

### 3.4 Noise Generating and Noise Suppressing Parts

Refer to the Circuit Diagram.

### 3.5 Submitted Documents

- Block Diagram
- Photo Document
- Technical Description
- Circuit Diagram
- Instruction Manual
- Rating Label

## 4. Test Set-up and Operation Modes

### 4.1 Principle of Configuration Selection

The test modes were adapted accordingly in reference to the instructions for use.

During testing, Channel and Power Controlling Software provided by the customer was used to control the operating channel as well as the output power level. The RF output power selection is for the setting of RF output power expected by the customer and is going to be fixed on the firmware of the final end product.

**Table 6: Table for Parameters of Test Software Setting**

Mode	Channel Frequency					
	NCB: 20MHz			NCB: 40MHz		
	2412 MHz	2437 MHz	2462 MHz	2422 MHz	2437 MHz	2452 MHz
802.11b	34	34	34	x	x	x
802.11g	49	63	51	x	x	x
802.11n MCS0 HT20	44	63	49	x	x	x
802.11n MCS0 HT40	x	x	x	x	x	x

## 4.2 Test Operation and Test Software

Setup for testing: Test samples are provided with a USB interface which makes it possible to control them through a test software installed on a notebook computer.

This software was running on the laptop computer connected to the EUT. It was used to enable the operation modes listed in section 3.3 as appropriate.

The samples were used as follows:

Conducted: A000818888-005

Radiation: A000818888-006

Full test was applied on all test modes, but only worst case was shown

IEEE 802.11b mode:

Channel Low (2412MHz), Channel Mid (2437MHz) and Channel High (2462MHz) with 1Mbps data rate were chosen for full testing.

IEEE 802.11g mode:

Channel Low (2412MHz), Channel Mid (2437MHz) and Channel High (2462MHz) with 6Mbps data rate were chosen for full testing.

IEEE 802.11n HT 20 mode:

Channel Low (2412MHz), Channel Mid (2437MHz) and Channel High (2462MHz) with 13Mbps data rate were chosen for full testing.

## 4.3 Additional Accessories and Auxiliary Equipment

The product has been tested together with the following additional accessories:

Description	Manufacturer	Model No.	Serial No.
Notebook(EMC-06)	Lenovo	TP00048A	PB-0F8B2

## 4.4 Countermeasures to achieve EMC Compliance

The test sample which has been tested contained the noise suppression parts as described in the Constructional Data Form or the Technical Construction File. No additional measures were employed to achieve compliance.

## 4.5 Test Setup Diagram

### Diagram of Measurement Configuration for Radiation Test

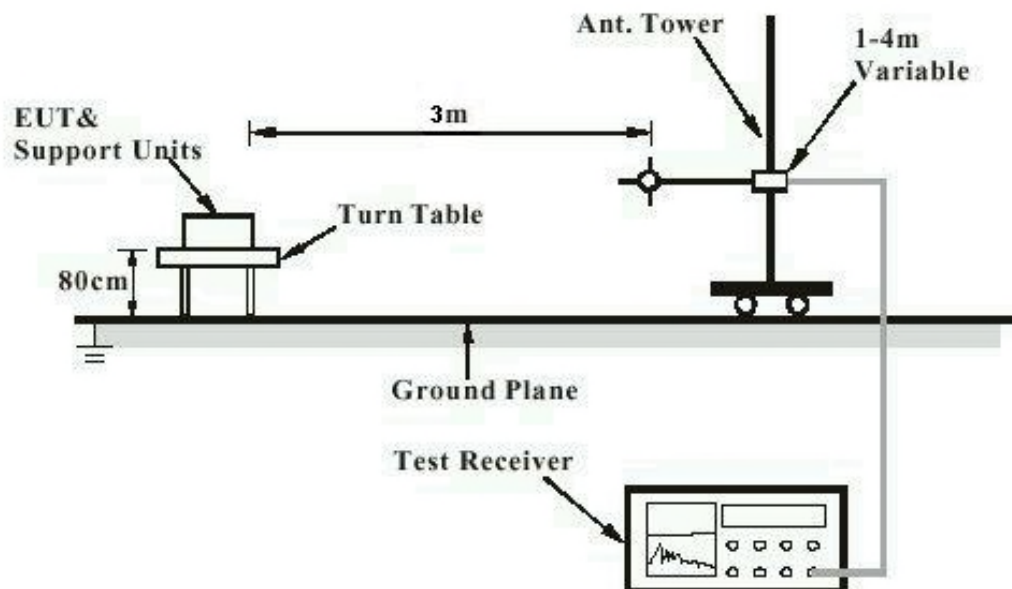

Note: Measurements above 1 GHz are done with a table height of 1.5m.

**Diagram of Measurement Equipment Configuration for Mains Conduction Measurement (if applicable)**

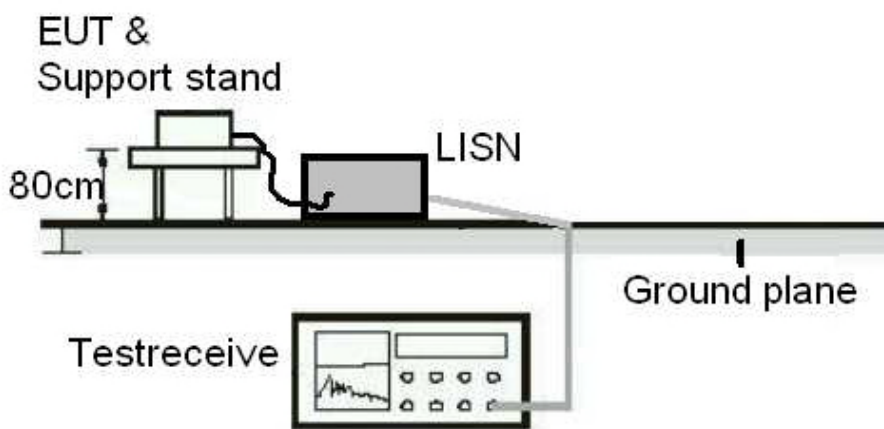

**Diagram of Measurement Equipment Configuration for Conducted Transmitter Measurement**

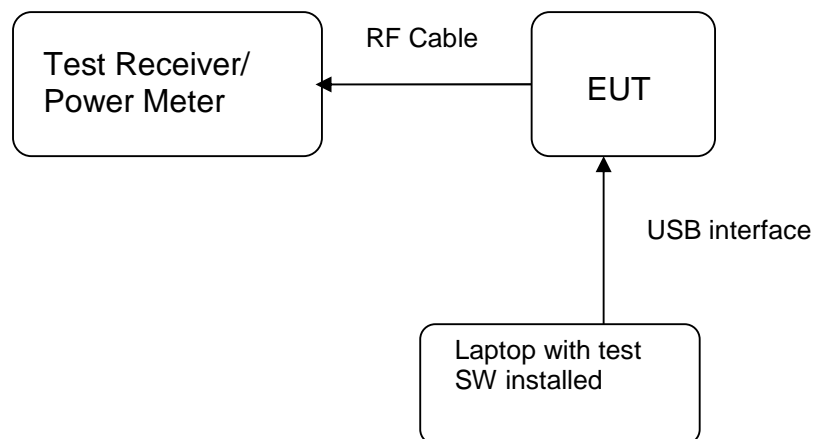

## 5. Test Results

### 5.1 Transmitter Requirement & Test Suites

#### 5.1.1 Antenna Requirement

**RESULT:** **Passed**

Test standard : FCC Part 15.247(b)(4), Part 15.203 and RSS-Gen 8.3

Limit : the use of antennas with directional gains that do not exceed 6 dBi

According to the manufacturer declaration, the EUT has an antenna with a directional gain of 2.01 dBi. The antenna is a Chip Antenna soldered to the PCB with no possibility of replacement with a non-approved antenna by the end-user. Therefore, the EUT is considered to comply with this provision.

Refer to EUT photo for details.

**Prüfbericht - Nr.: 50199559 001**

Test Report No.

Seite 16 von 50

Page 16 of 50

## 5.1.2 Peak Output Power

**RESULT:****Passed**

Test standard : FCC Part 15.247(b)(3)  
RSS-247 5.4(4)  
Basic standard : ANSI C63.10:2013, KDB558074  
Limit : 1 Watt  
Kind of test site : Shielded room

**Test setup**

Test Channel : Low/ Middle/ High  
Operation Mode : A  
Ambient temperature : 22-26 °C  
Relative humidity : 50-65 %  
Atmospheric pressure : 100-103 kPa



**Table 7: Test result of Peak Output Power (802.11b)**

Channel	Channel Frequency (MHz)	Output Power		Limit (W)
		(dBm)	(W)	
Low Channel	2412	18.37	0.0688	1
Middle Channel	2437	18.49	0.0707	1
High Channel	2462	17.92	0.0620	1

**Table 8: Test result of Peak Output Power (802.11g)**

Channel	Channel Frequency (MHz)	Output Power		Limit (W)
		(dBm)	(W)	
Low Channel	2412	24.72	0.2965	1
Middle Channel	2437	25.33	0.3412	1
High Channel	2462	25.11	0.3244	1

**Table 9: Test result of Peak Output Power (802.11n HT20)**

Channel	Channel Frequency (MHz)	Output Power		Limit (W)
		(dBm)	(W)	
Low Channel	2412	23.34	0.2158	1
Middle Channel	2437	25.27	0.3366	1
High Channel	2462	24.60	0.2885	1

**Table 10: Test result of Maximum AVG Output Power (802.11g)**

Channel	Channel Frequency (MHz)	Output Power			Limit (W)
		(dBm)	(W)	(mw)	
Middle Channel	2437	21.14	0.1301	130.1	1

**Prüfbericht - Nr.: 50199559 001**

Test Report No.

**Seite 18 von 50**

Page 18 of 50

### 5.1.3 6dB Bandwidth and 99% Bandwidth

**RESULT:****Passed**

Test standard : FCC Part 15.247(a)(2)  
RSS-247 5.2(1)  
Basic standard : ANSI C63.10:2013, KDB558074  
Kind of test site : Shielded room

**Test setup**

Test Channel : Low/ Middle/ High  
Operation Mode : A  
Ambient temperature : 22-26°C  
Relative humidity : 50-65%  
Atmospheric pressure : 100-103 kPa

**Table 11: Test result of 6dB Bandwidth (802.11b)**

Channel	Channel Frequency (MHz)	6dB Bandwidth (MHz)	Limit (MHz)	Result
Low Channel	2412	9.089	0.5	Pass
Middle Channel	2437	9.080	0.5	Pass
High Channel	2462	9.087	0.5	Pass

**Table 12: Test result of 6dB Bandwidth (802.11g)**

Channel	Channel Frequency (MHz)	6dB Bandwidth (MHz)	Limit (MHz)	Result
Low Channel	2412	16.590	0.5	Pass
Middle Channel	2437	16.520	0.5	Pass
High Channel	2462	16.580	0.5	Pass

**Table 13: Test result of 6dB Bandwidth (802.11n HT20)**

Channel	Channel Frequency (MHz)	6dB Bandwidth (MHz)	Limit (MHz)	Result
Low Channel	2412	17.780	0.5	Pass
Middle Channel	2437	17.820	0.5	Pass
High Channel	2462	17.730	0.5	Pass

**Table 14: Test result of 99% Bandwidth (802.11b)**

Channel	Channel Frequency (MHz)	99% Bandwidth (MHz)
Middle Channel	2437	13.343

**Table 15: Test result of 99% Bandwidth (802.11g)**

Channel	Channel Frequency (MHz)	99% Bandwidth (MHz)
Middle Channel	2437	17.208

**Table 16: Test result of 99% Bandwidth (802.11n HT20)**

Channel	Channel Frequency (MHz)	99% Bandwidth (MHz)
Middle Channel	2437	18.177

## Test Plot of 6dB Bandwidth (802.11b)

### Low Channel

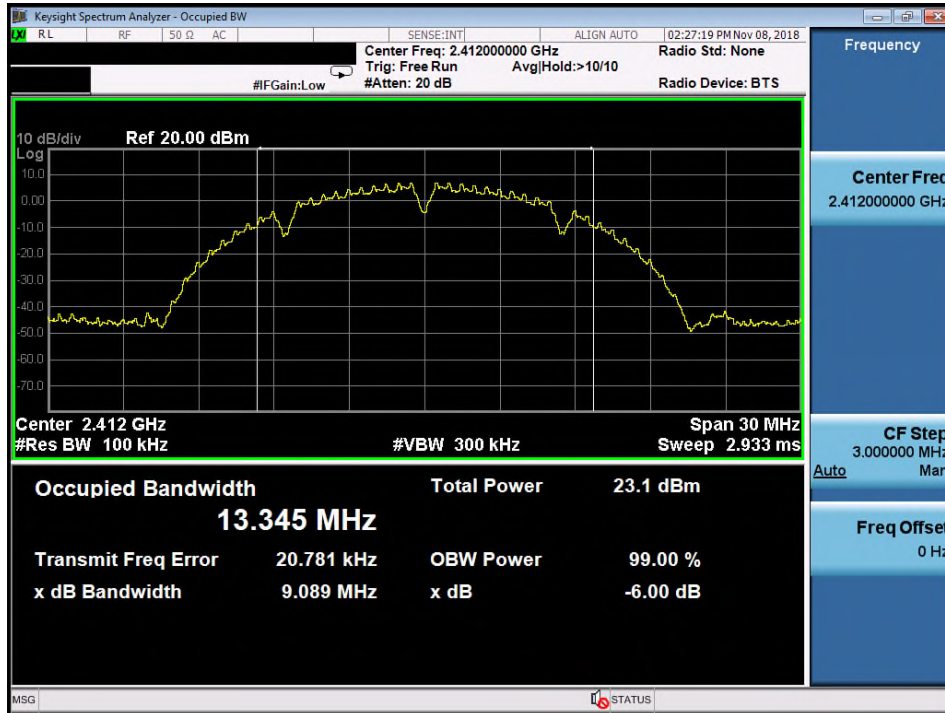

### Middle Channel

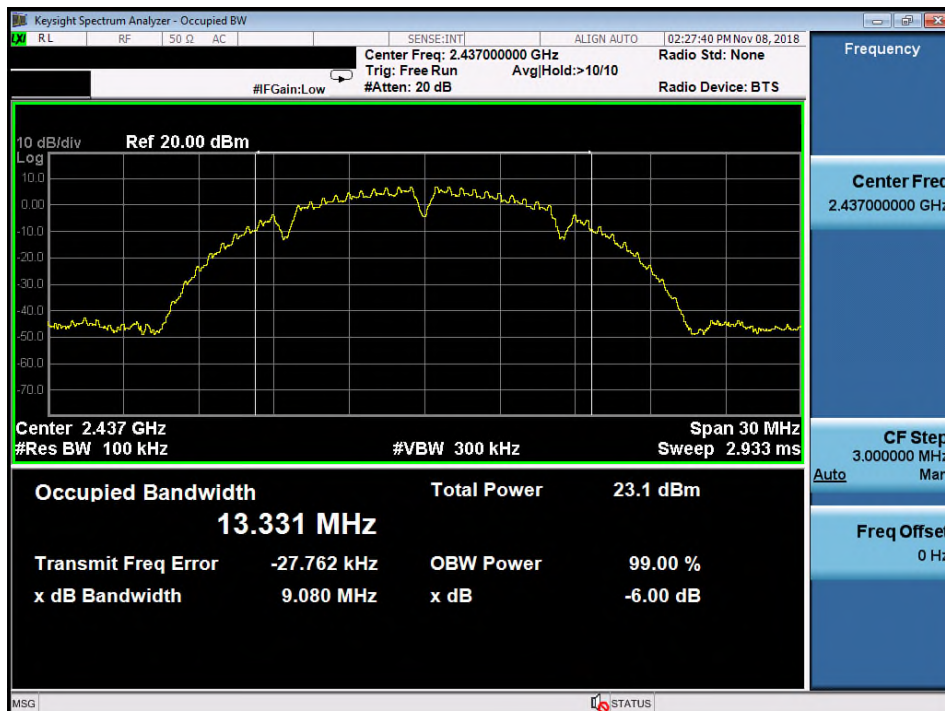

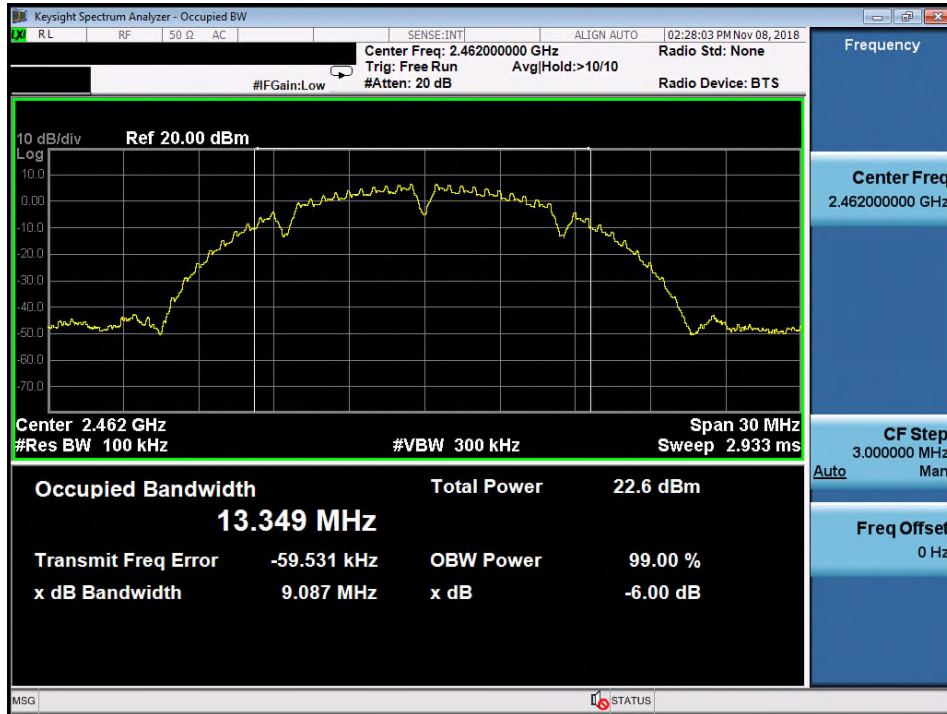
**High Channel**

## Test Plot of 6dB Bandwidth (802.11g)

### Low Channel

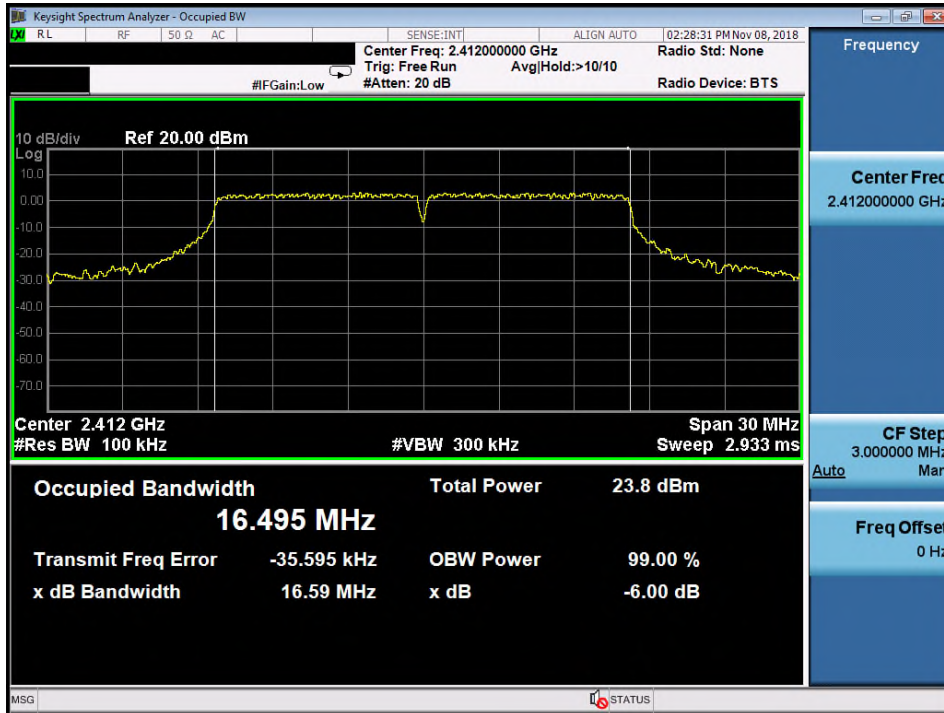

### Middle Channel

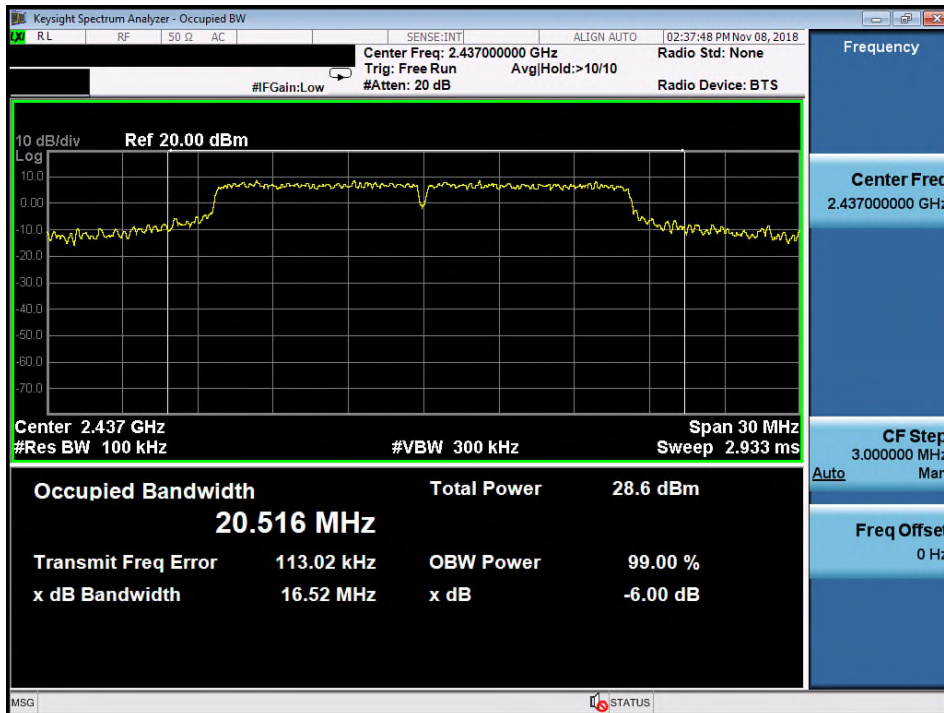

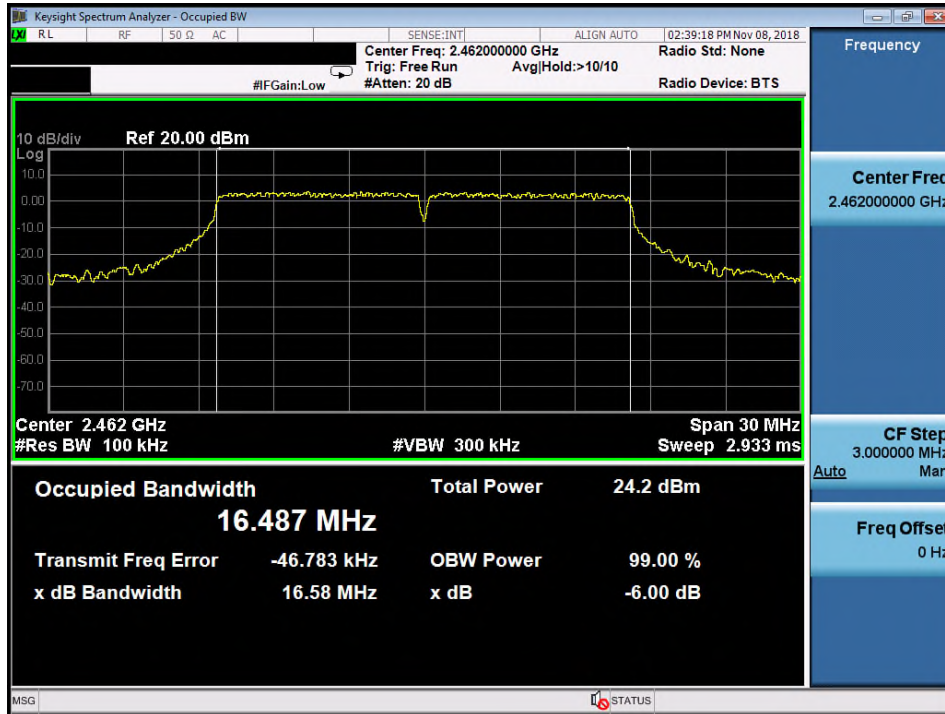
**High Channel**



## Test Plot of 6dB Bandwidth (802.11n HT20)

### Low Channel

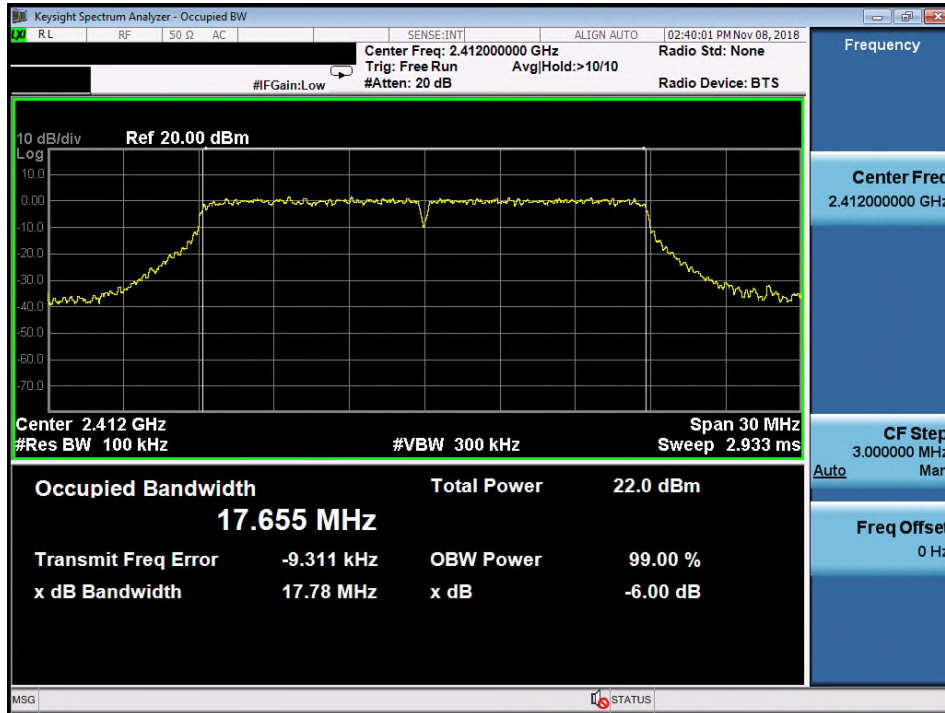

### Middle Channel

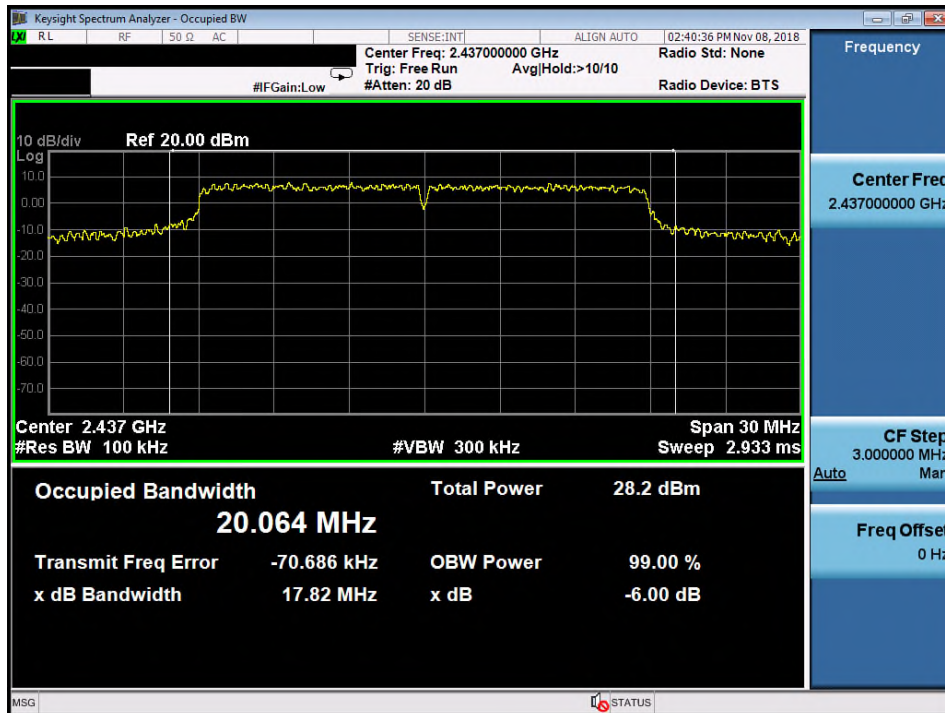

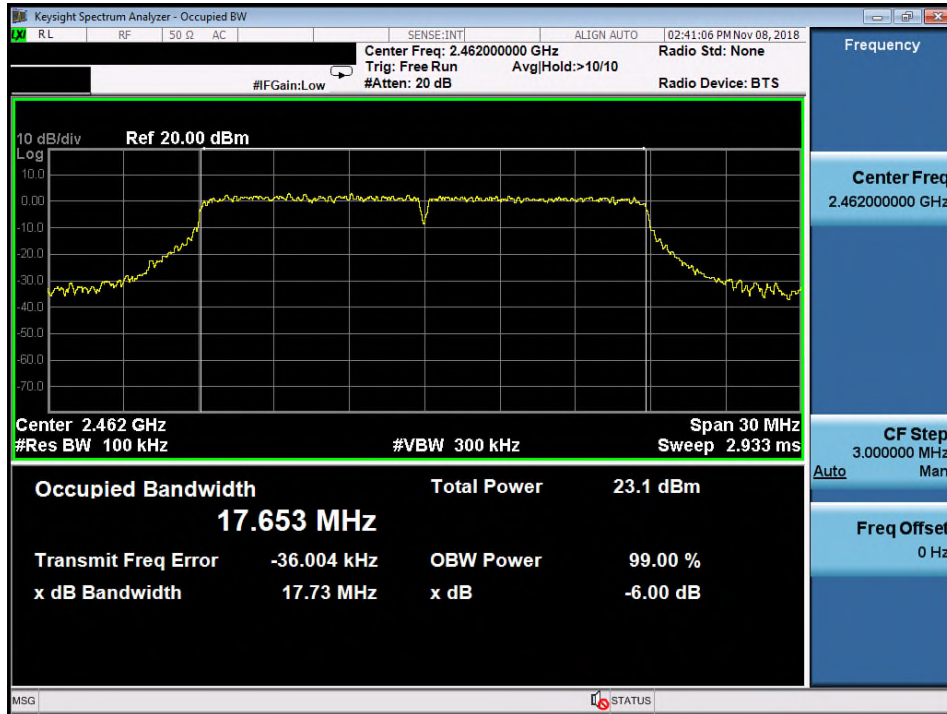
**High Channel**

## Test Plot of 99% Bandwidth (802.11b)

### Middle Channel

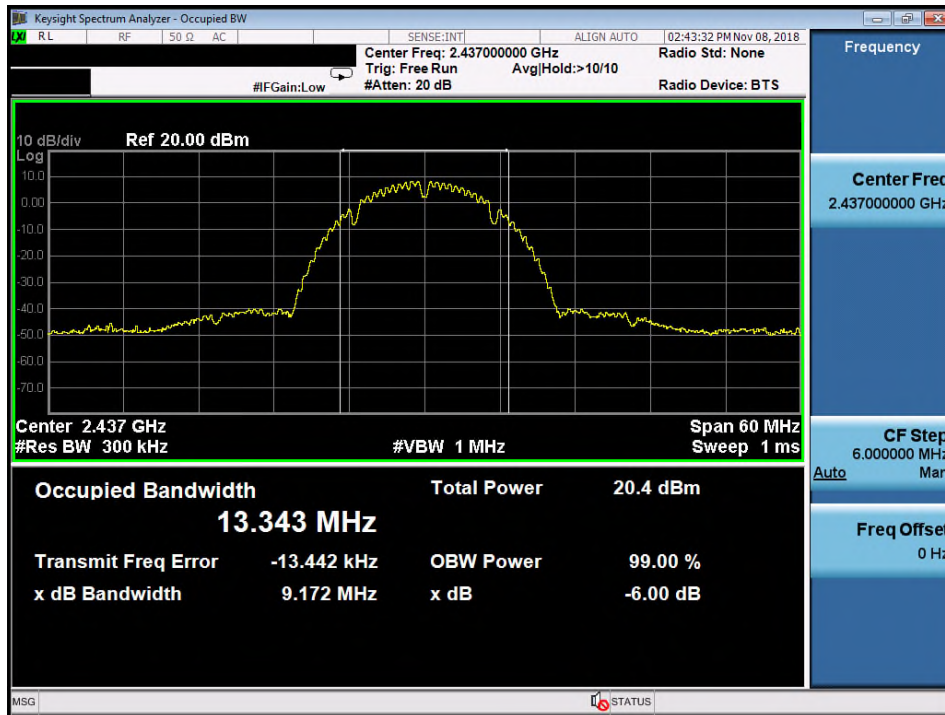

## Test Plot of 99% Bandwidth (802.11g)

### Middle Channel

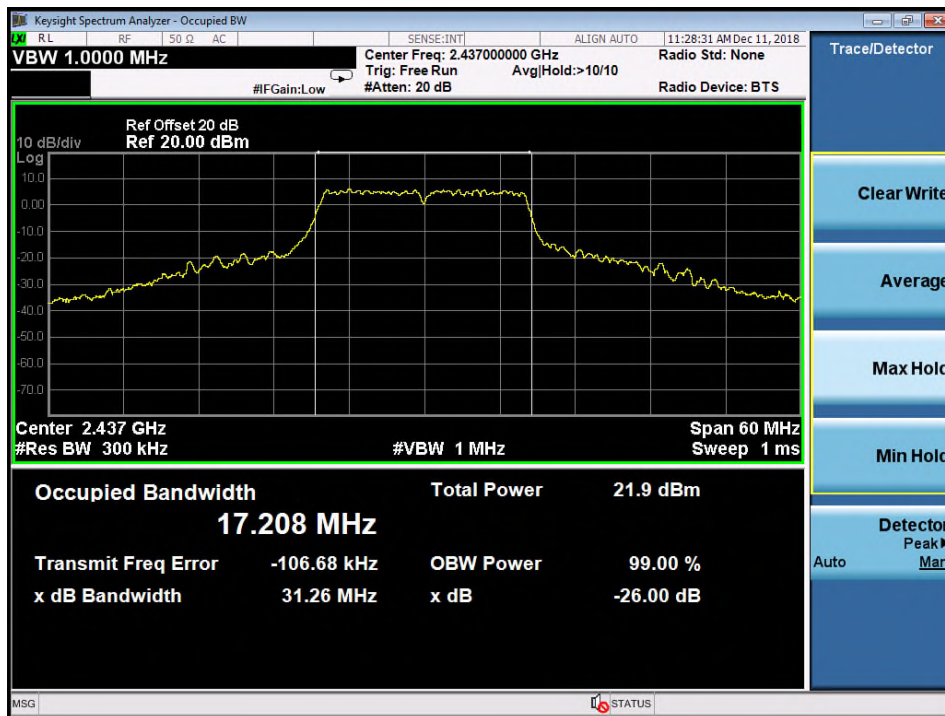

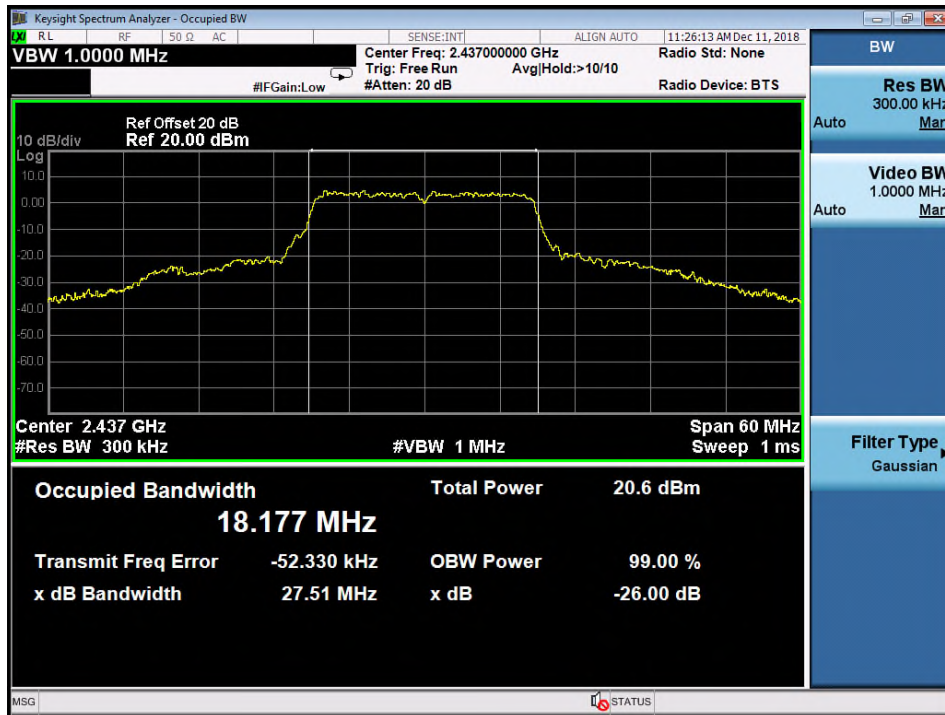
**Test Plot of 99% Bandwidth (802.11n HT20)**
**Middle Channel**

### 5.1.4 Power Density

**RESULT:**
**Passed**

Test standard : FCC Part 15.247(e)  
 RSS-247 5.2(2)  
 Basic standard : ANSI C63.10:2013, KDB558074  
 Kind of test site : Shielded room

**Test setup**

Test Channel : Low/ Middle/ High  
 Operation Mode : A  
 Ambient temperature : 22-26°C  
 Relative humidity : 50-65%  
 Atmospheric pressure : 100-103 kPa

**Table 17: Test result of Power Density (802.11b)**

Channel	Channel Frequency (MHz)	Power Density	Limit
		(dBm)	(dBm)
Low Channel	2412	-13.52	8
Middle Channel	2437	-13.37	8
High Channel	2462	-13.87	8

**Table 18: Test result of Power Density (802.11g)**

Channel	Channel Frequency (MHz)	Power Density	Limit
		(dBm)	(dBm)
Low Channel	2412	-11.42	8
Middle Channel	2437	-6.54	8
High Channel	2462	-11.02	8

**Table 19: Test result of Power Density (802.11n HT20)**

Channel	Channel Frequency (MHz)	Power Density	Limit
		(dBm)	(dBm)
Low Channel	2412	-13.07	8
Middle Channel	2437	-6.25	8
High Channel	2462	-13.92	8

### Test Plot of Power Density (802.11b)

#### Low Channel

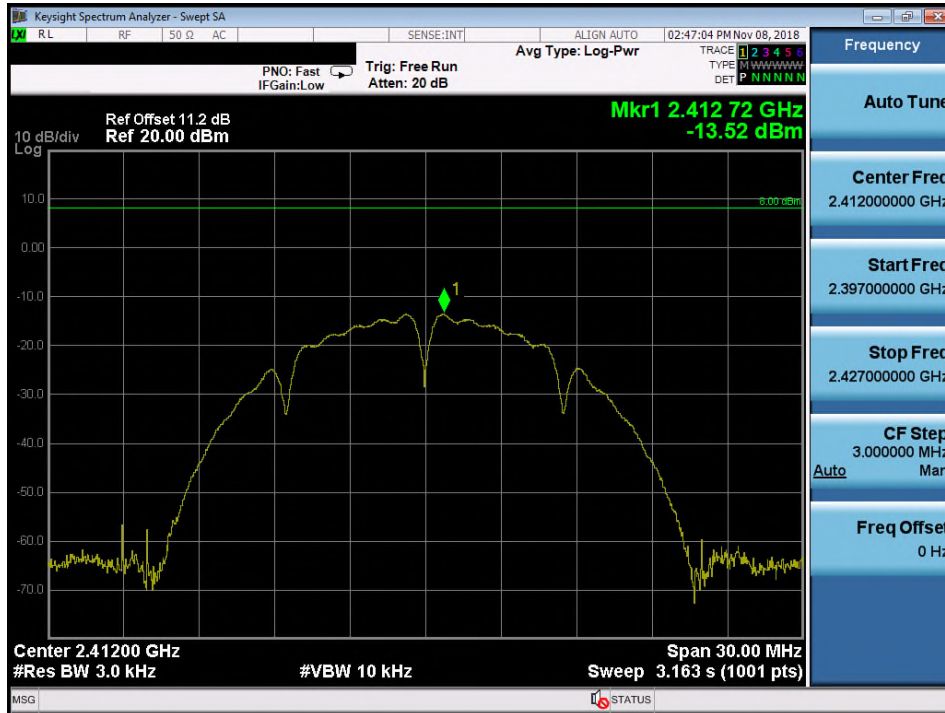

#### Middle Channel

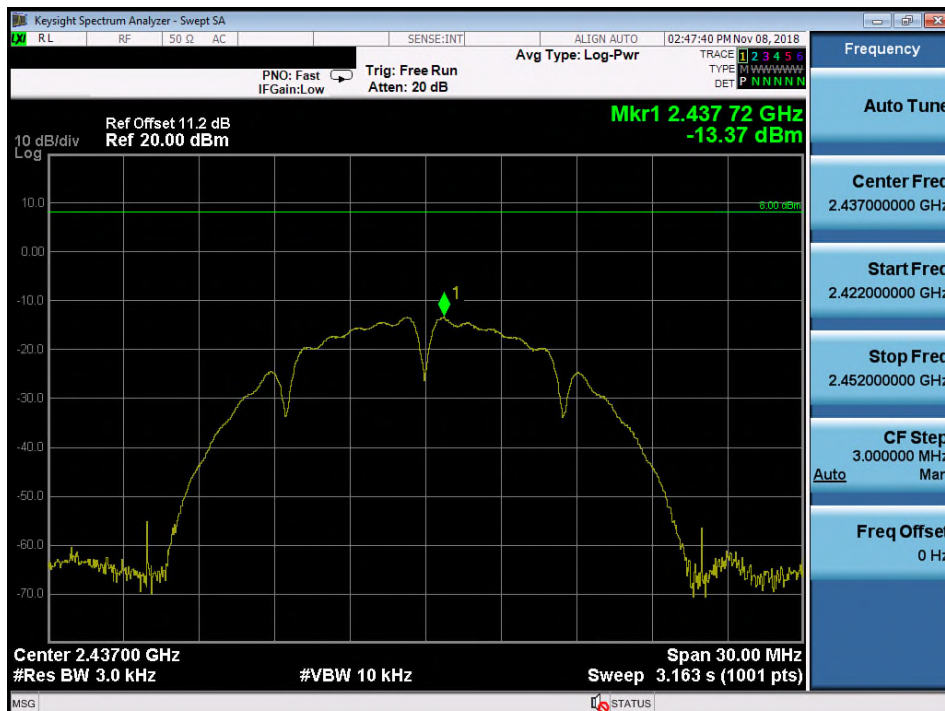

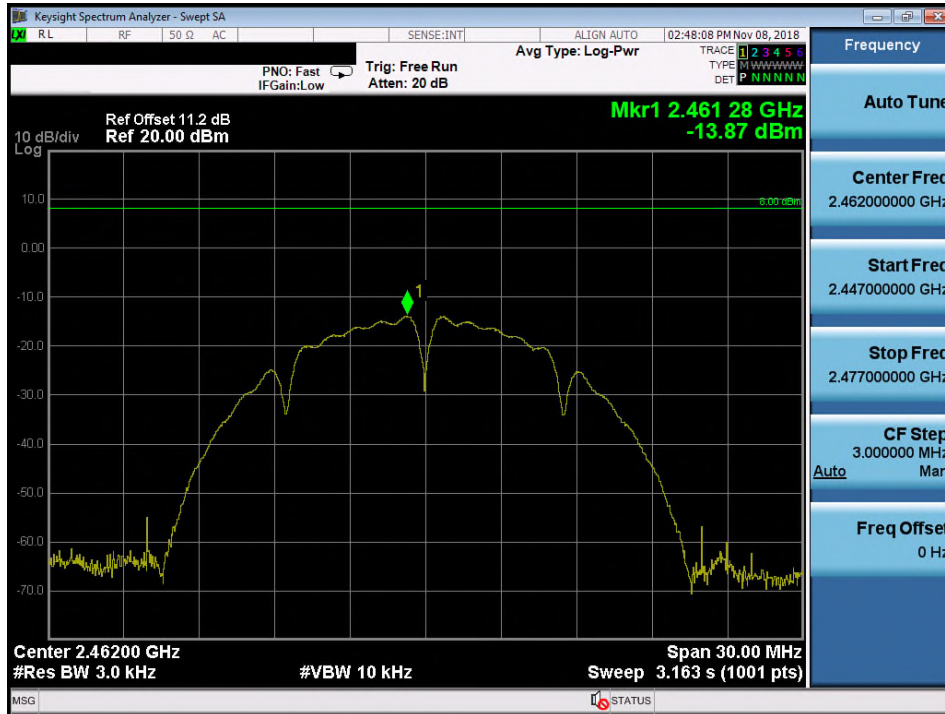
**High Channel**



## Test Plot of Power Density (802.11g)

### Low Channel

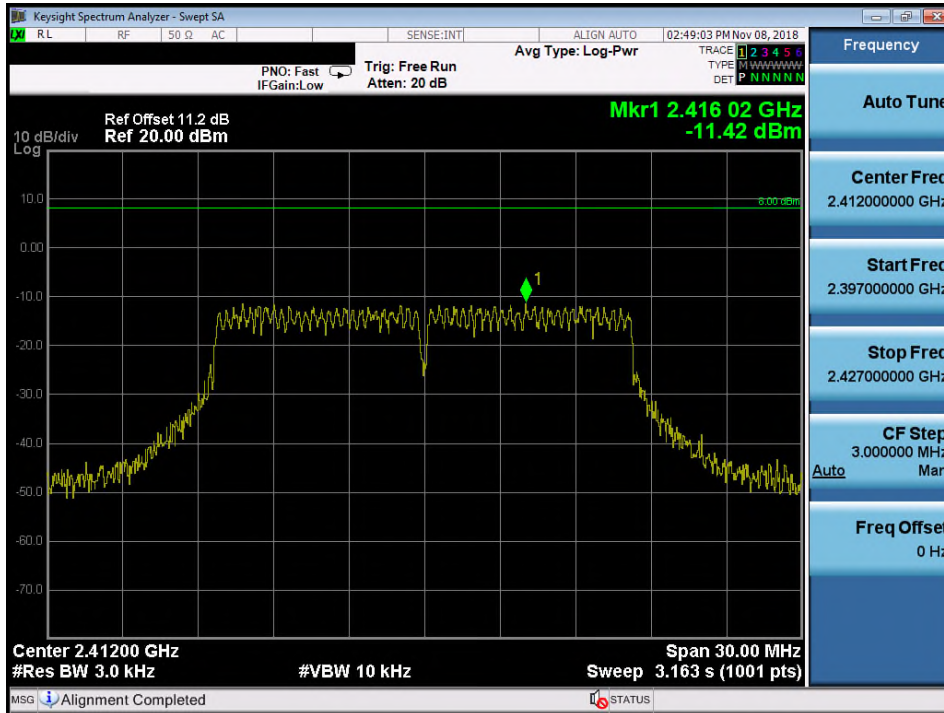

### Middle Channel

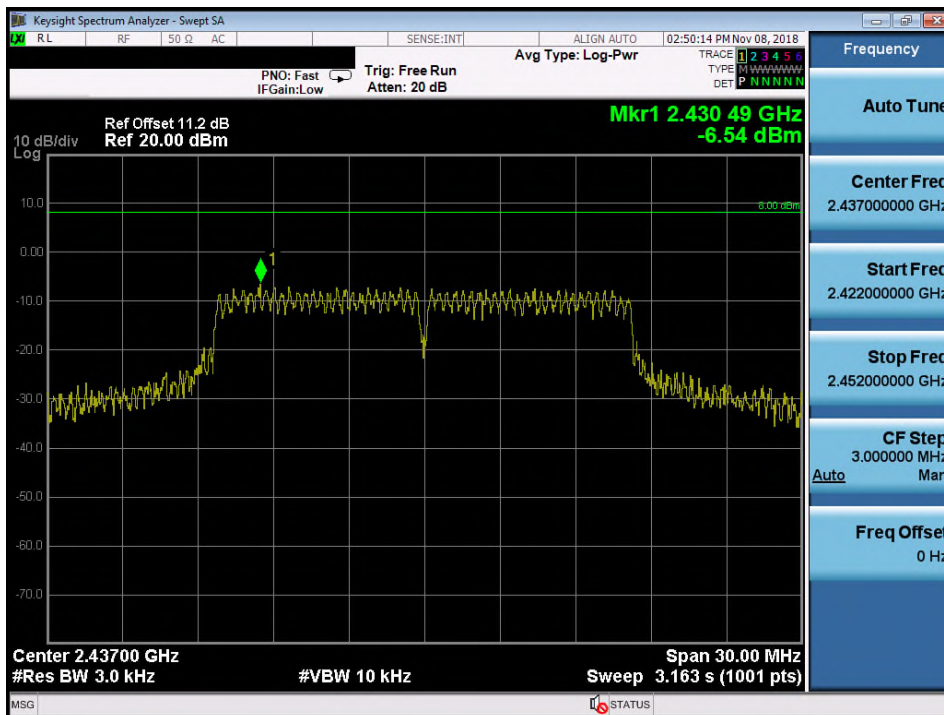

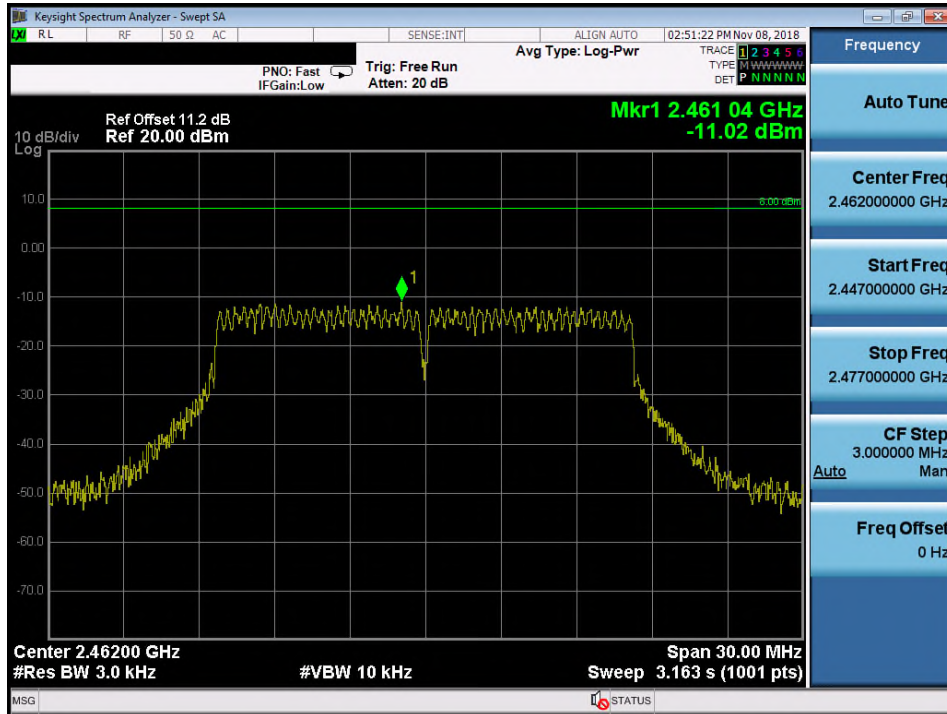
**High Channel**

## Test Plot of Power Density (802.11n HT20)

### Low Channel

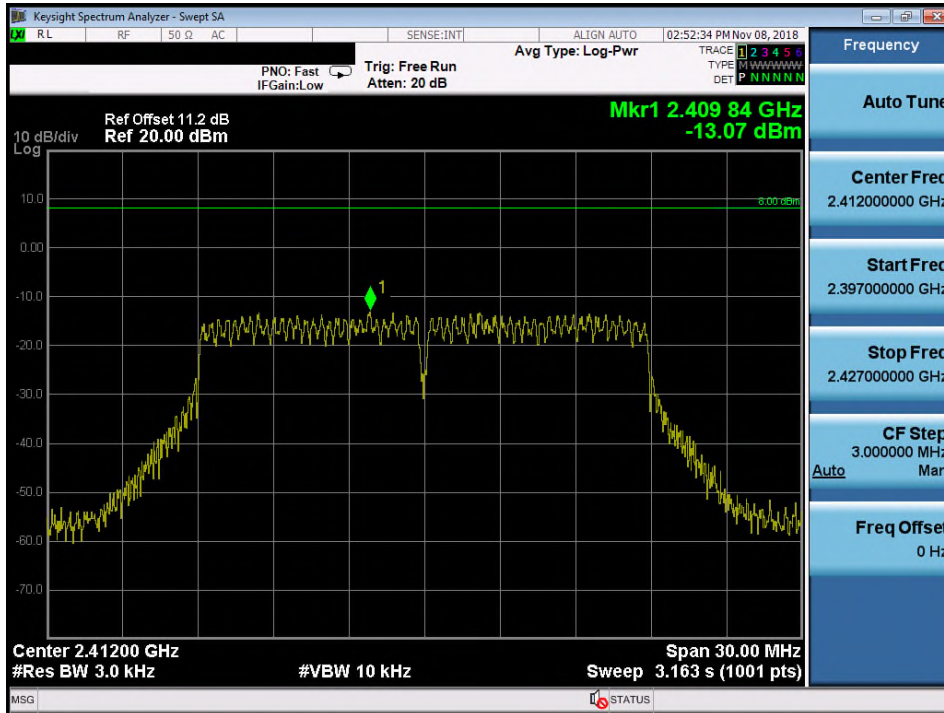

### Middle Channel

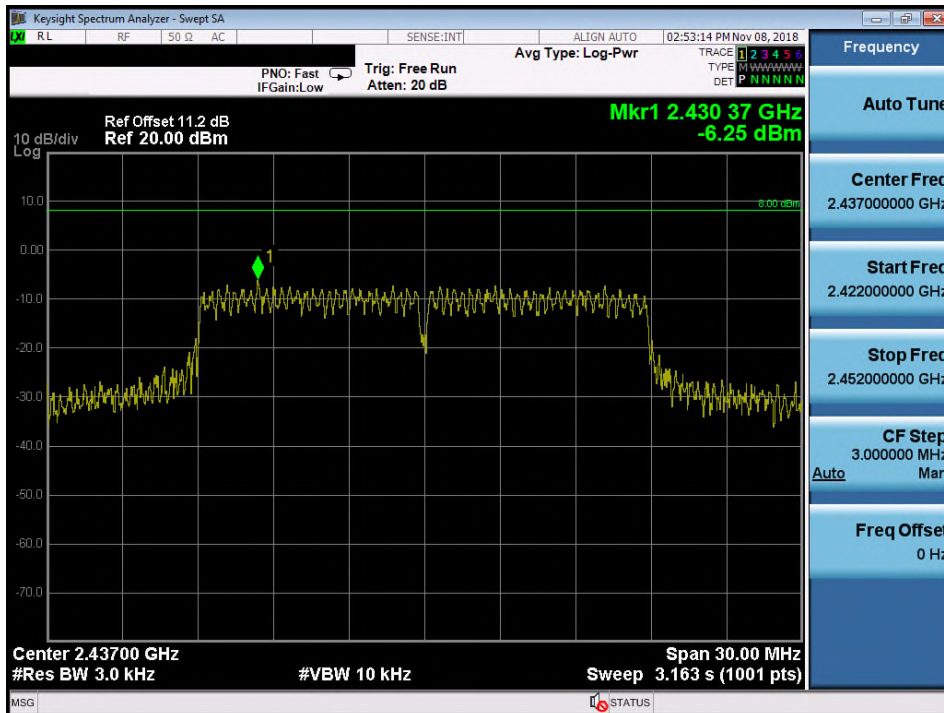

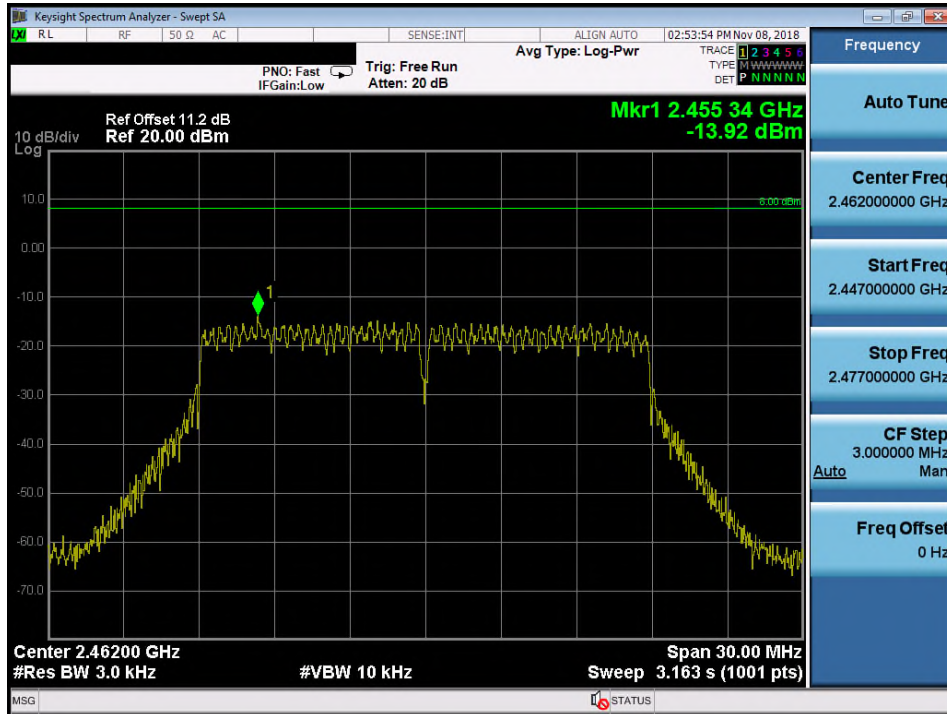
**High Channel**

### 5.1.5 Conducted spurious emissions and Frequency Band Edge measured in 100kHz Bandwidth

**RESULT:** **Passed**

Test standard : FCC part 15.247(d)  
RSS-247 5.5  
Basic standard : ANSI C63.10:2013, KDB558074  
Limit : 20dB (below that in the 100kHz bandwidth within the  
band that contains the highest level of the desired power)  
Kind of test site : Shielded room

#### Test setup

Test Channel : Low/ Middle/ High for Conducted Spurious Emissions  
Low/ High for Frequency Band Edge  
Operation mode : A  
Ambient temperature : 22-26°C  
Relative humidity : 50-65%  
Atmospheric pressure : 100-103 kPa

All emissions are more than 20dB below fundamental, details refer to following test plot, and compliance is achieved as well.

Due to the small size of the product and that there are no inductive components of significant size, 9kHz to 30MHz frequency range is not tested based on technical judgment.

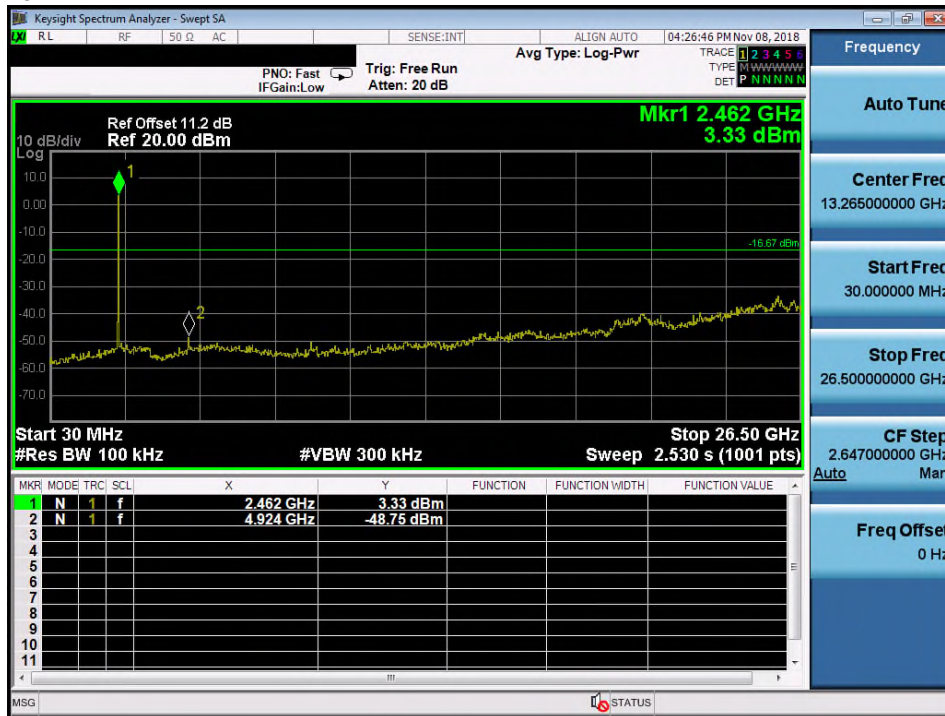

**High Channel**

Frequency

Auto Tune

Center Freq  
13.265000000 GHz

Start Freq  
30.000000 MHz

Stop Freq  
26.500000000 GHz

CF Step  
2.647000000 GHz

Auto Man

Freq Offset  
0 Hz

## Test Plot 100kHz Conducted Emissions (802.11g)

### Low Channel



### Middle Channel

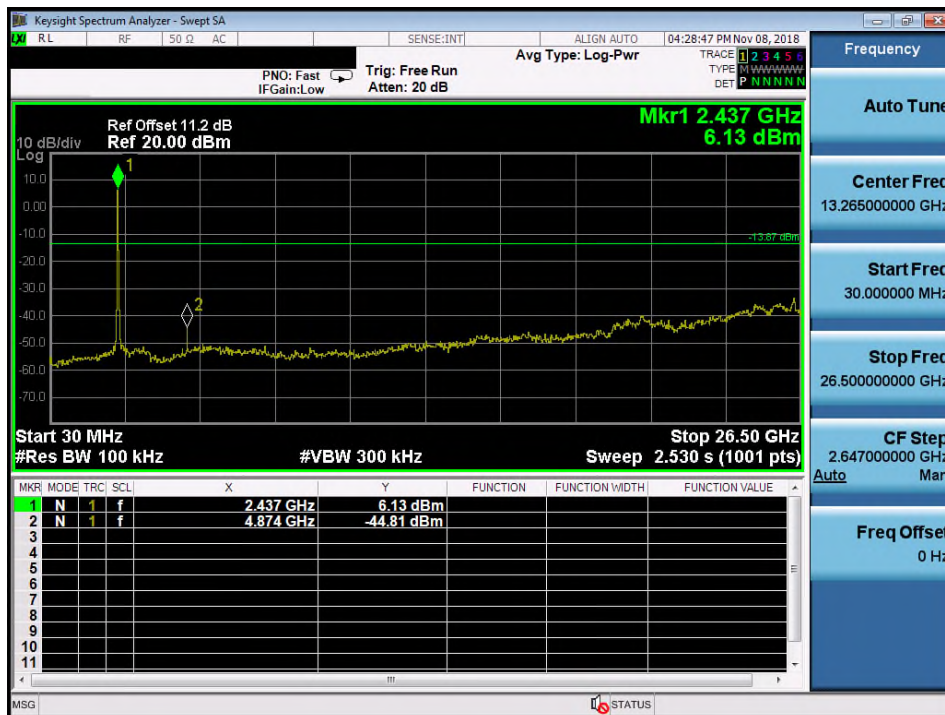



**High Channel**

## Test Plot 100kHz Conducted Emissions (802.11n HT20)

### Low Channel



### Middle Channel





## Test Plot 100kHz RBW of Band Edge (802.11b)

### Low Channel

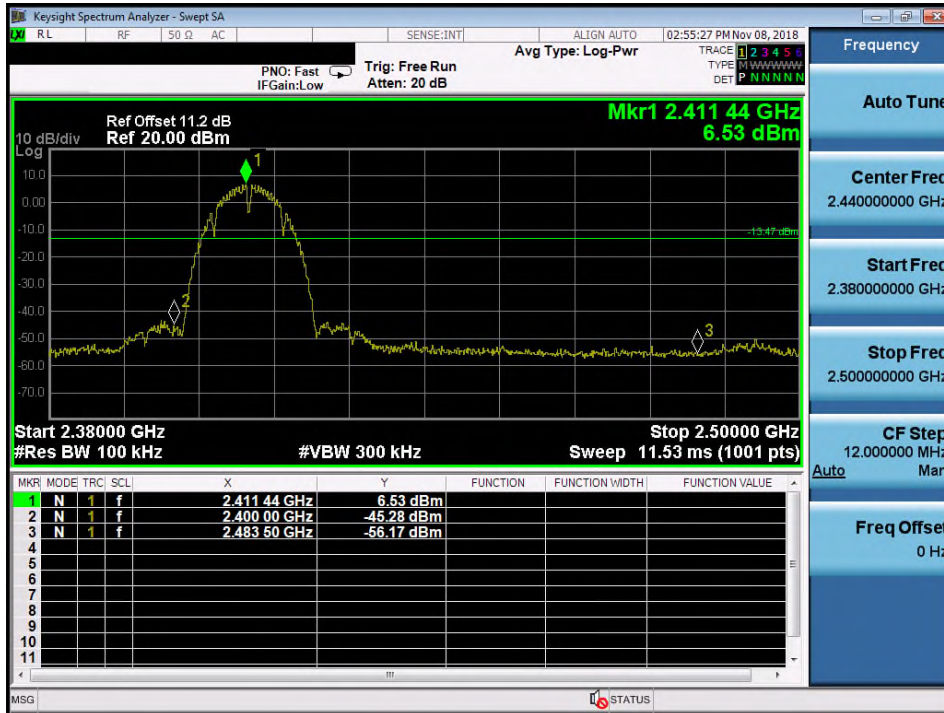

### High Channel

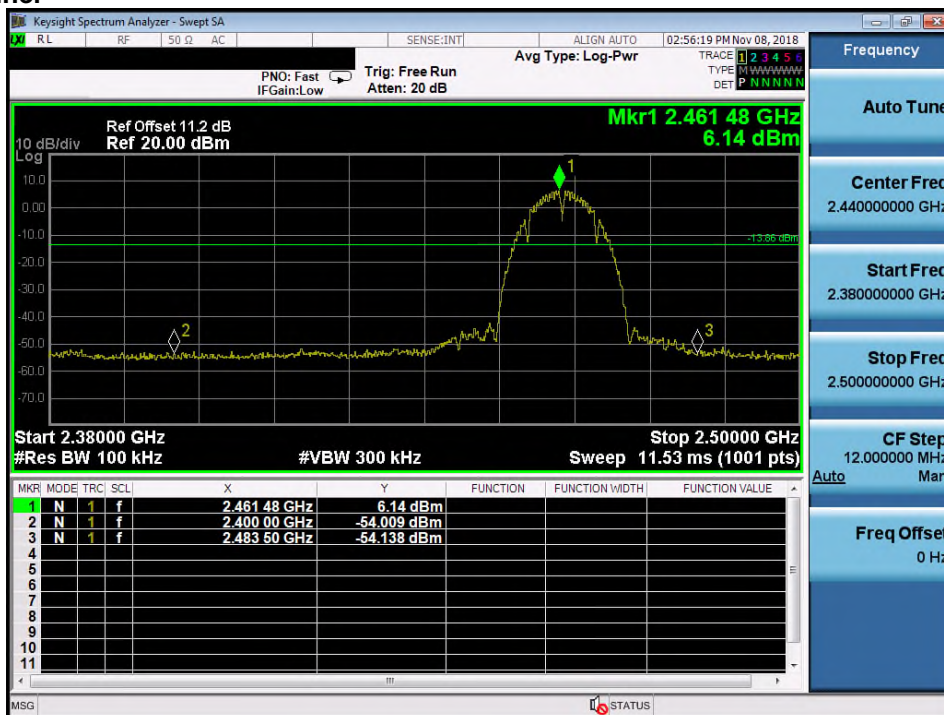

## Test Plot 100kHz RBW of Band Edge (802.11g)

### Low Channel



### High Channel

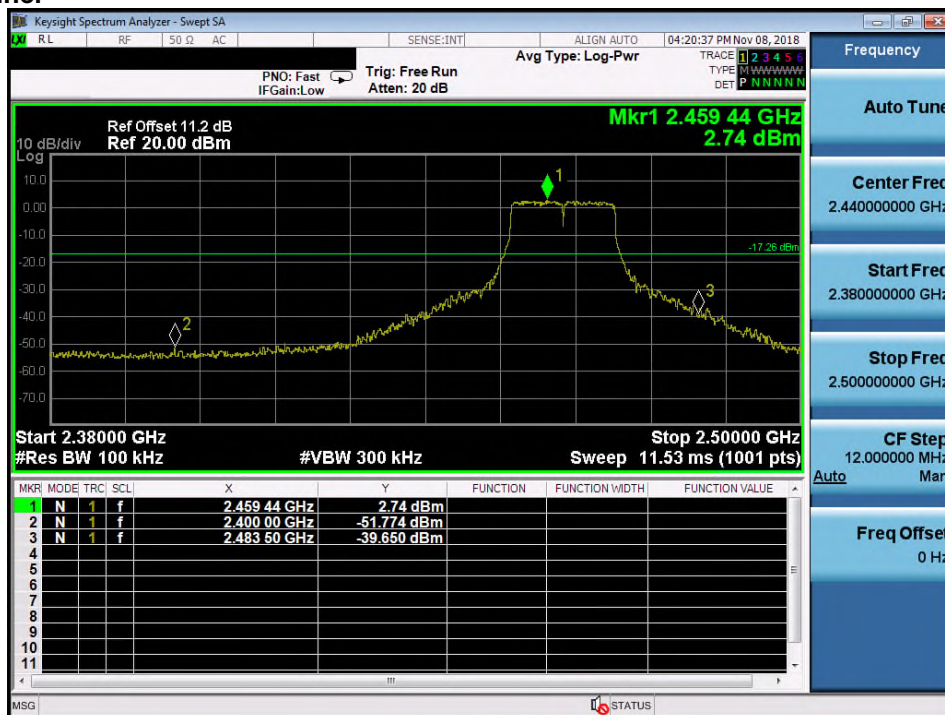

## Test Plot 100kHz RBW of Band Edge (802.11n HT20)

### Low Channel

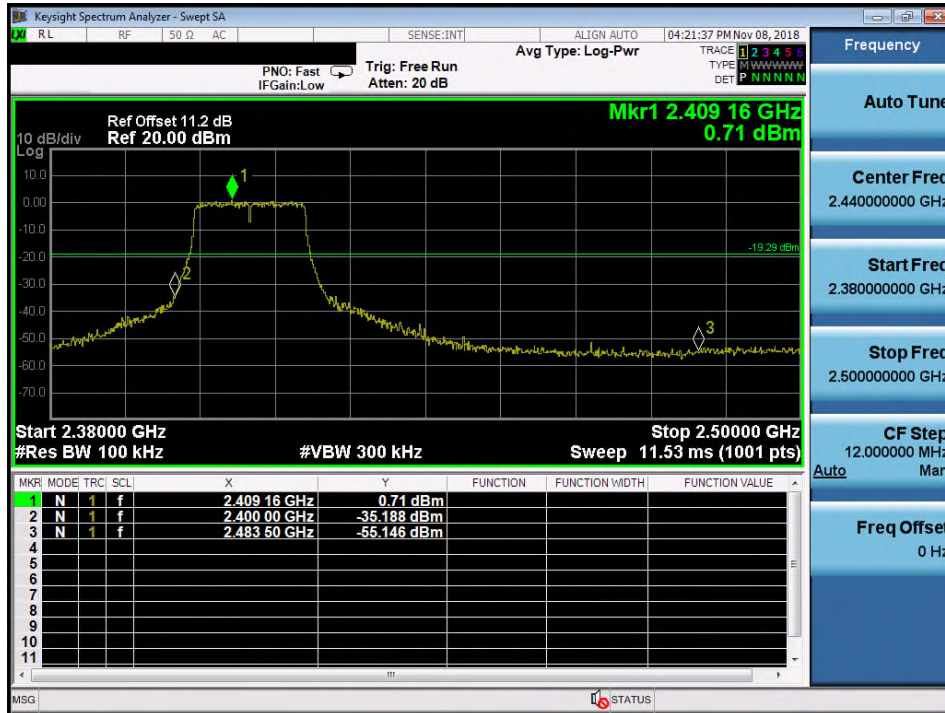

### High Channel

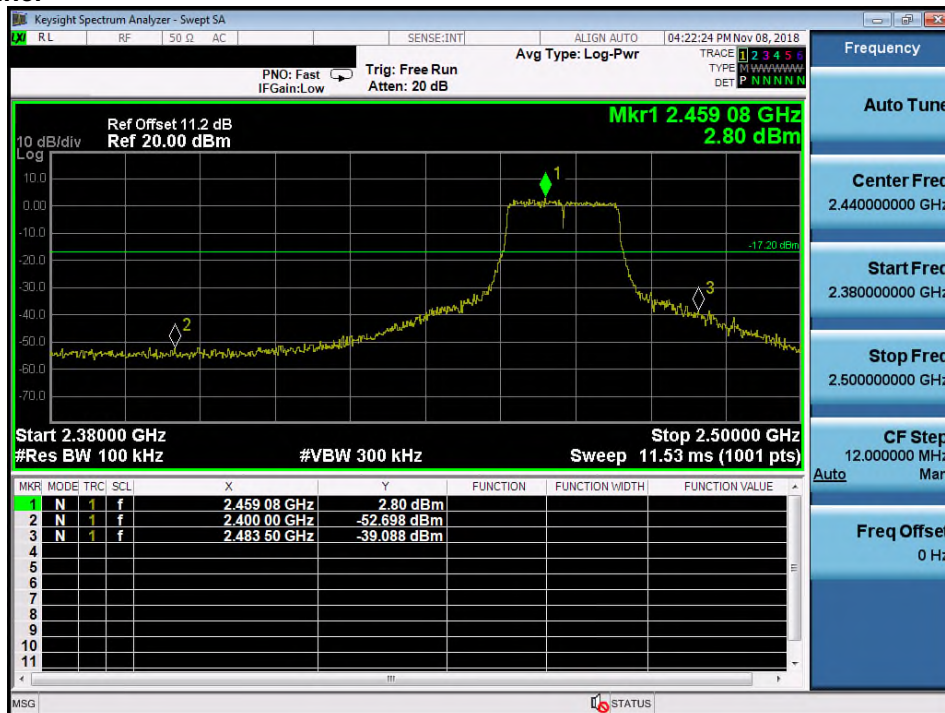

## 5.1.6 Spurious Emission

**RESULT:****Passed**

Test standard	:	FCC part 15.247(d), FCC 15.205, FCC 15.209 RSS-Gen 8.9
Basic standard	:	ANSI C63.10: 2013
Limits	:	Radiated emissions which fall in the restricted bands, as defined in FCC 15.205(a) and RSS-Gen i5, 8.10 (Table 7), must comply with the radiated emission limits specified in FCC 15.209(a) and RSS-Gen 5, 8.9 (Table 5 and 6).\
		Emission radiated outside the restricted and authorized frequency bands must either comply with the radiated emission limits specified for the restricted bands or in FCC15.247(d) and RSS-247 i2, 5.5.
Kind of test site	:	3m Semi-Anechoic Chamber

**Test setup**

Test Channel	:	Low/ Middle/ High
Operation mode	:	A, B

Remark: Testing was carried out within frequency range 30MHz to the tenth harmonic.

For details refer to Appendix D.

The Radiated Emissions testing was performed in the X, Y and Z axis orientation. The Z Axis orientation is the worst-case and recorded in this test report. Due to the small size of the product and that there are no inductive components of significant size, 9kHz to 30MHz frequency range is not tested based on technical judgment.

## 5.2 Mains Emissions

### 5.2.1 Mains Conducted Emissions

**RESULT:****Passed**

Test standard : FCC Part 15.207  
FCC Part 15.107  
RSS-Gen 8.8

Limits : Mains Conducted emissions as defined in  
above test standards must comply with the  
mains conducted emission limits specified

Kind of test site : Shielded Room

**Test setup**

Test Channel : Normal link  
Operation mode : Normal link

Ambient temperature : 20-24 °C  
Relative humidity : 50-65 %  
Atmospheric pressure : 100-103 kPa

Remark: For details refer to Appendix D.



## 6. Safety Human exposure

### 6.1 Radio Frequency Exposure Compliance

#### 6.1.1 Electromagnetic Fields

**RESULT:**
**Passed**

Test standard : FCC KDB Publication 447498 D01 v06  
 RSS 102

Separation distance is more than 20 cm, thus mobile device exposure limits can be applied.

**Maximum Exposure:**

Power to Antenna (mW)	130.1 mW
Power to Antenna (dBm)	21.1 dBm
Antenna Gain	2.01 dBi
Power+Ant Gain	206.7 mW
Distance	20 cm
S=	0.041 mW/cm <sup>2</sup>

Limit FCC:  
**1500-100,000 MHz 1.0 mW/cm<sup>2</sup>**

**Limit Canada:**  $0.02619f^{0.6834}$

---End---

## 7. List of Tables

Table 1: Applied Standard and Test Levels .....	5
Table 2: List of Test and Measurement Equipment .....	7
Table 3: Emission Measurement Uncertainty.....	8
Table 4: Basic Information of EUT .....	9
Table 5: Technical Specification of EUT .....	9
Table 6: Table for Parameters of Test Software Setting .....	11
Table 7: Test result of Peak Output Power (802.11b).....	17
Table 8: Test result of Peak Output Power (802.11g).....	17
Table 9: Test result of Peak Output Power (802.11n HT20).....	17
Table 10: Test result of Maximum AVG Output Power (802.11g).....	17
Table 11: Test result of 6dB Bandwidth (802.11b).....	19
Table 12: Test result of 6dB Bandwidth (802.11g).....	19
Table 13: Test result of 6dB Bandwidth (802.11n HT20).....	19
Table 14: Test result of 99% Bandwidth (802.11b).....	20
Table 15: Test result of 99% Bandwidth (802.11g).....	20
Table 16: Test result of 99% Bandwidth (802.11n HT20).....	20
Table 17: Test result of Power Density (802.11b).....	30
Table 18: Test result of Power Density (802.11g).....	30
Table 19: Test result of Power Density (802.11n HT20).....	30