

TEST REPORT

CERTIFICATE OF CONFORMITY

Standard: 47 CFR FCC Part 15, Subpart C (Section 15.247)

Report No.: RFBHOU-WTW-P23040022

FCC ID: 2AAF-20LAG9901

Product: Light Strip Pro

Brand: elgato

Model No.: 20LAG9901

Received Date: 2023/4/6

Test Date: 2023/4/17 ~ 2023/5/8

Issued Date: 2023/6/13

Applicant: Corsair Memory, Inc.

Address: 115 North McCarthy Blvd, Milpitas, CA 95035, USA

Issued By: Bureau Veritas Consumer Products Services (H.K.) Ltd., Taoyuan Branch
Lin Kou Laboratories

Lab Address: No. 47-2, 14th Ling, Chia Pau Vil., Lin Kou Dist., New Taipei City, Taiwan

Test Location: No. 47-2, 14th Ling, Chia Pau Vil., Lin Kou Dist., New Taipei City, Taiwan

FCC Registration / 198487 / TW2021

Designation Number:

Approved by: Jeremy Lin, **Date:** 2023/6/13
Jeremy Lin / Project Engineer

This test report consists of 58 pages in total. It may be duplicated completely for legal use with the approval of the applicant. It should not be reproduced except in full, without the written approval of our laboratory. The test results in the report only apply to the tested sample. The test results in this report are traceable to the national or international standards.

Prepared by : Jessica Cheng / Senior Specialist



This report is governed by, and incorporates by reference, the Conditions of Testing as posted at the date of issuance of this report at <http://www.bureauveritas.com/home/about-us/our-business/cps/about-us/terms-conditions/> and is intended for your exclusive use. Any copying or replication of this report to or for any other person or entity, or use of our name or trademark, is permitted only with our prior written permission. This report sets forth our findings solely with respect to the test samples identified herein. The results set forth in this report are not indicative or representative of the quality or characteristics of the lot from which a test sample was taken or any similar or identical product unless specifically and expressly noted. Our report includes all of the tests requested by you and the results thereof based upon the information that you provided to us. Measurement uncertainty is only provided upon request for accredited tests. Statements of conformity are based on simple acceptance criteria without taking measurement uncertainty into account, unless otherwise requested in writing. You have 60 days from date of issuance of this report to notify us of any material error or omission caused by our negligence or if you require measurement uncertainty; provided, however, that such notice shall be in writing and shall specifically address the issue you wish to raise. A failure to raise such issue within the prescribed time shall constitute your unqualified acceptance of the completeness of this report, the tests conducted and the correctness of the report contents.

Table of Contents

Release Control Record	4
1 Certificate	5
2 Summary of Test Results	6
2.1 Measurement Uncertainty	6
2.2 Supplementary Information	6
3 General Information	7
3.1 General Description	7
3.2 Antenna Description of EUT	8
3.3 Channel List	9
3.4 Test Mode Applicability and Tested Channel Detail	10
3.5 Duty Cycle of Test Signal	11
3.6 Test Program Used and Operation Descriptions	13
3.7 Connection Diagram of EUT and Peripheral Devices	13
3.8 Configuration of Peripheral Devices and Cable Connections	14
4 Test Instruments	15
4.1 RF Output Power	15
4.2 Power Spectral Density	15
4.3 6 dB Bandwidth	15
4.4 Conducted Out of Band Emissions	15
4.5 AC Power Conducted Emissions	16
4.6 Unwanted Emissions below 1 GHz	17
4.7 Unwanted Emissions above 1 GHz	18
5 Limits of Test Items	19
5.1 RF Output Power	19
5.2 Power Spectral Density	19
5.3 6 dB Bandwidth	19
5.4 Conducted Out of Band Emissions	19
5.5 AC Power Conducted Emissions	19
5.6 Unwanted Emissions below 1 GHz	19
5.7 Unwanted Emissions above 1 GHz	20
6 Test Arrangements	21
6.1 RF Output Power	21
6.1.1 Test Setup	21
6.1.2 Test Procedure	21
6.2 Power Spectral Density	21
6.2.1 Test Setup	21
6.2.2 Test Procedure	21
6.3 6 dB Bandwidth	22
6.3.1 Test Setup	22
6.3.2 Test Procedure	22
6.4 Conducted Out of Band Emissions	22
6.4.1 Test Setup	22
6.4.2 Test Procedure	22
6.5 AC Power Conducted Emissions	23
6.5.1 Test Setup	23
6.5.2 Test Procedure	23
6.6 Unwanted Emissions below 1 GHz	24
6.6.1 Test Setup	24
6.6.2 Test Procedure	25
6.7 Unwanted Emissions above 1 GHz	26
6.7.1 Test Setup	26
6.7.2 Test Procedure	26
7 Test Results of Test Item	27



7.1	RF Output Power	27
7.2	Power Spectral Density	29
7.3	6 dB Bandwidth	31
7.4	Conducted Out of Band Emissions	33
7.5	AC Power Conducted Emissions	37
7.6	Unwanted Emissions below 1 GHz	39
7.7	Unwanted Emissions above 1 GHz	41
8	Pictures of Test Arrangements	57
9	Information of the Testing Laboratories	58



Release Control Record

Issue No.	Description	Date Issued
RFBHOU-WTW-P23040022	Original release.	2023/6/13

1 Certificate

Product: Light Strip Pro

Brand: elgato

Test Model: 20LAG9901

Sample Status: Engineering sample

Applicant: Corsair Memory, Inc.

Test Date: 2023/4/17 ~ 2023/5/8

Standard: 47 CFR FCC Part 15, Subpart C (Section 15.247)

Measurement ANSI C63.10-2013

procedure: KDB 558074 D01 15.247 Meas Guidance v05r02

The above equipment has been tested by **Bureau Veritas Consumer Products Services (H.K.) Ltd., Taoyuan Branch**, and found compliance with the requirement of the above standards. The test record, data evaluation & Equipment Under Test (EUT) configurations represented herein are true and accurate accounts of the measurements of the sample's RF characteristics under the conditions specified in this report.

2 Summary of Test Results

47 CFR FCC Part 15, Subpart C (Section 15.247)			
Standard / Clause	Test Item	Result	Remark
15.247(b)	RF Output Power	Pass	Meet the requirement of limit.
15.247(e)	Power Spectral Density	Pass	Meet the requirement of limit.
15.247(a)(2)	6 dB Bandwidth	Pass	Meet the requirement of limit.
15.247(d)	Conducted Out of Band Emissions	Pass	Meet the requirement of limit.
15.207	AC Power Conducted Emissions	Pass	Minimum passing margin is -14.43 dB at 0.36600 MHz
15.205 / 15.209 / 15.247(d)	Unwanted Emissions below 1 GHz	Pass	Minimum passing margin is -10.7 dB at 61.72 MHz
15.205 / 15.209 / 15.247(d)	Unwanted Emissions above 1 GHz	Pass	Minimum passing margin is -0.5 dB at 2483.50 MHz
15.203	Antenna Requirement	Pass	No antenna connector is used.

Note: Determining compliance based on the results of the compliance measurement, not taking into account measurement instrumentation uncertainty.

2.1 Measurement Uncertainty

Where relevant, the following measurement uncertainty levels have been estimated for tests performed on the EUT as specified in CISPR 16-4-2:

Measurement	Specification	Expanded Uncertainty (k=2) (±)
Conducted Out of Band Emissions	9 kHz ~ 40 GHz	2.63 dB
AC Power Conducted Emissions	150 kHz ~ 30 MHz	3.00 dB
Unwanted Emissions below 1 GHz	9 kHz ~ 30 MHz	2.38 dB
	30 MHz ~ 1 GHz	5.7 dB
Unwanted Emissions above 1 GHz	1 GHz ~ 6 GHz	4.83 dB
	6 GHz ~ 18 GHz	5.37 dB
	18 GHz ~ 40 GHz	5.24 dB

The other instruments specified are routine verified to remain within the calibrated levels, no measurement uncertainty is required to be calculated.

2.2 Supplementary Information

There is not any deviation from the test standards for the test method, and no modifications required for compliance.

3 General Information

3.1 General Description

Product	Light Strip Pro
Brand	elgato
Test Model	20LAG9901
Status of EUT	Engineering sample
Power Supply Rating	24Vdc/ 1.25A
Modulation Type	CCK, DQPSK, DBPSK for DSSS 64QAM, 16QAM, QPSK, BPSK for OFDM
Modulation Technology	DSSS, OFDM, OFDMA
Transfer Rate	Up to 150 Mbps
Operating Frequency	2.412 GHz ~ 2.462 GHz
Number of Channel	802.11b, 802.11g, 802.11n (HT20): 11 802.11n (HT40): 7
Output Power	645.654 mW (28.1 dBm)

Note:

1. The EUT uses following accessories.

AC Adapter		
Brand	Model	Specification
ULLPOWER	ICP30A-240-1250	AC Input : 100-240V ~ 50/60Hz 0.8A DC Output : 24.0VDC 1.25A 30.0W DC Output Cable : Nonshielded without cord, 1.5m Plug : AC 2 Pin
Light Strip		
Specification		
Signal Line : 2m		

2. The above EUT information is declared by manufacturer and for more detailed features description, please refer to the manufacturer's specifications or user's manual.

3.2 Antenna Description of EUT

1. The antenna information is listed as below.

Gain (dBi)	Antenna Type	Connector Type
1.05	Chip	None

* Detail antenna specification please refer to antenna datasheet and/or antenna measurement report.

2. The EUT incorporates a SISO function:

2.4 GHz Band		
Modulation Mode	TX & RX Configuration	
802.11b	1TX	1RX
802.11g	1TX	1RX
802.11n (HT20)	1TX	1RX
802.11n (HT40)	1TX	1RX

3.3 Channel List

11 channels are provided for 802.11b, 802.11g, 802.11n (HT20):

Channel	Frequency	Channel	Frequency
1	2412 MHz	7	2442 MHz
2	2417 MHz	8	2447 MHz
3	2422 MHz	9	2452 MHz
4	2427 MHz	10	2457 MHz
5	2432 MHz	11	2462 MHz
6	2437 MHz		

7 channels are provided for 802.11n (HT40):

Channel	Frequency	Channel	Frequency
3	2422 MHz	7	2442 MHz
4	2427 MHz	8	2447 MHz
5	2432 MHz	9	2452 MHz
6	2437 MHz		

3.4 Test Mode Applicability and Tested Channel Detail

Pre-Scan:	1. EUT can be used in the following ways: XYZ 3-axis. Pre-scan in these ways and find the worst case as a representative test condition.
Worst Case:	1. X/ Y/ Z Worst Condition: X Axis for Unwanted Emission above 1GHz and Unwanted Emission below 1GHz.

Following channel(s) was (were) selected for the final test as listed below:

Test Item	Mode	Signal Mode	Tested Channel	Modulation	Data Rate Parameter
RF Output Power / Power Spectral Density	802.11b	CDD	1, 6, 11	DBPSK	1Mb/s
	802.11g	CDD	1, 6, 11	BPSK	6Mb/s
	802.11n (HT20)	CDD	1, 6, 11	BPSK	MCS0
	802.11n (HT40)	CDD	3, 6, 9	BPSK	MCS0
6 dB Bandwidth / Conducted Out of Band Emissions	802.11b	CDD	1, 6, 11	DBPSK	1Mb/s
	802.11g	CDD	1, 6, 11	BPSK	6Mb/s
	802.11n (HT20)	CDD	1, 6, 11	BPSK	MCS0
	802.11n (HT40)	CDD	3, 6, 9	BPSK	MCS0
AC Power Conducted Emissions	802.11g	CDD	1	BPSK	6Mb/s
Unwanted Emissions below 1 GHz	802.11g	CDD	1	BPSK	6Mb/s
Unwanted Emissions above 1 GHz	802.11b	CDD	1, 6, 11	DBPSK	1Mb/s
	802.11g	CDD	1, 6, 11	BPSK	6Mb/s
	802.11n (HT20)	CDD	1, 6, 11	BPSK	MCS0
	802.11n (HT40)	CDD	3, 6, 9	BPSK	MCS0

3.5 Duty Cycle of Test Signal

802.11b: Duty cycle = 12.42 ms / 12.546 ms x 100% = 99.0%

802.11g: Duty cycle = 2.065 ms / 2.193 ms x 100% = 94.2%, duty factor = $10 * \log (1/\text{Duty cycle}) = 0.26 \text{ dB}$

802.11n (HT20): Duty cycle = 1.92 ms / 2.049 ms x 100% = 93.7%, duty factor = $10 * \log (1/\text{Duty cycle}) = 0.28 \text{ dB}$

802.11n (HT40): Duty cycle = 0.945 ms / 1.074 ms x 100% = 88.0%, duty factor = $10 * \log (1/\text{Duty cycle}) = 0.56 \text{ dB}$

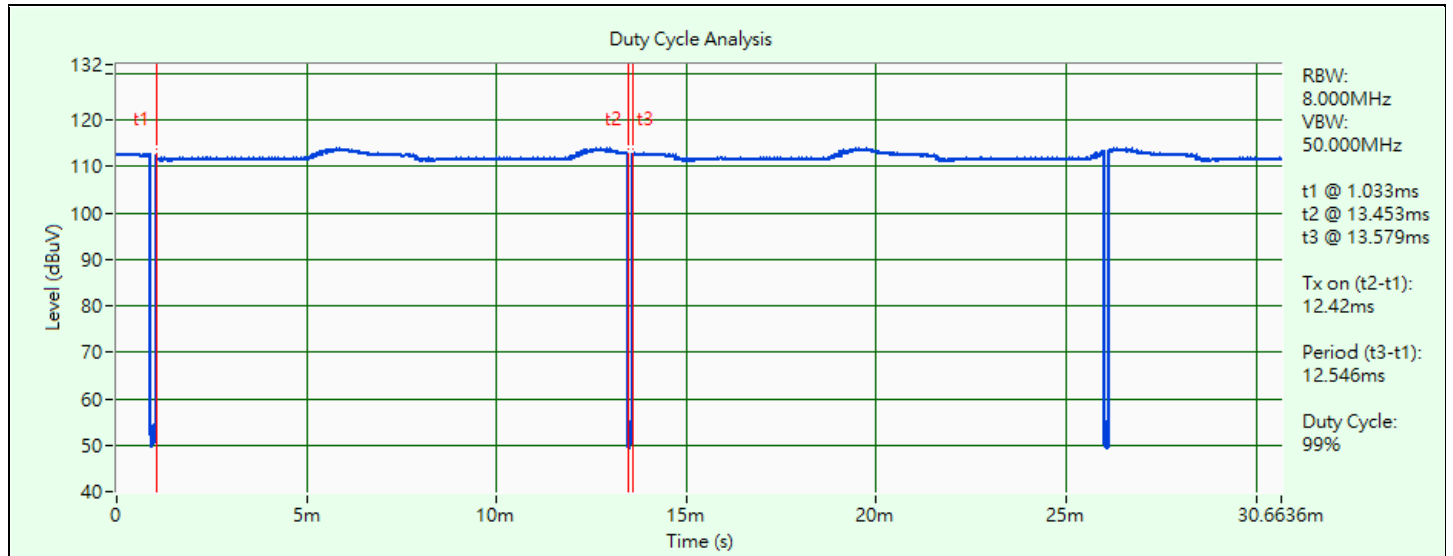

802.11b

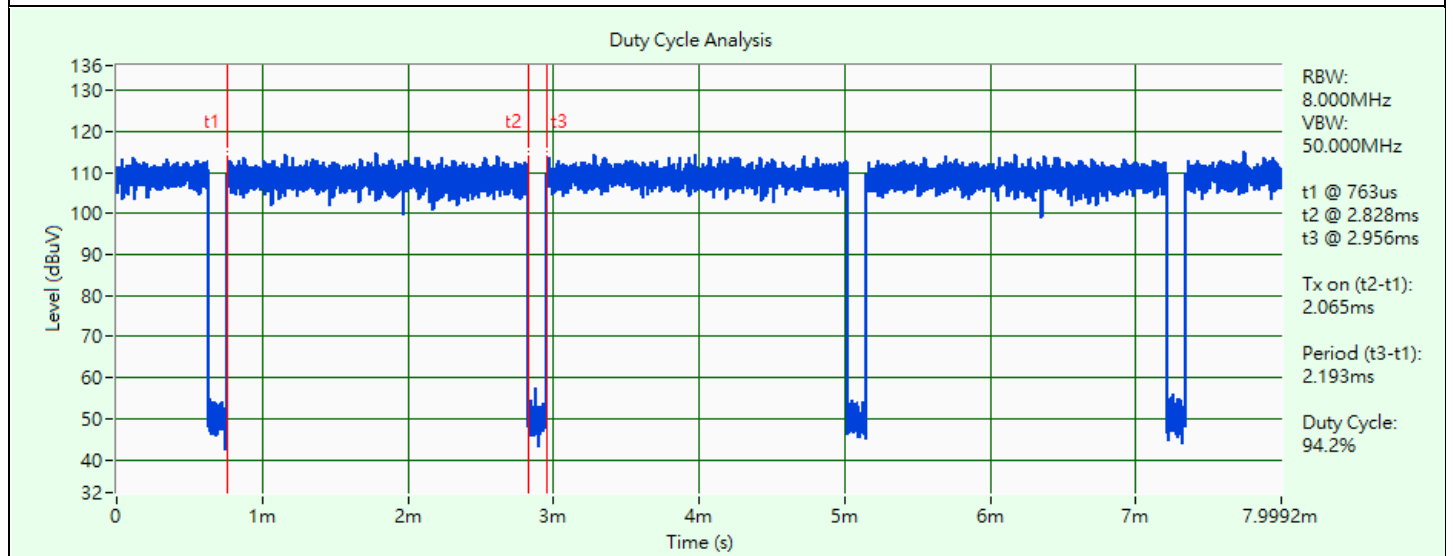

802.11g

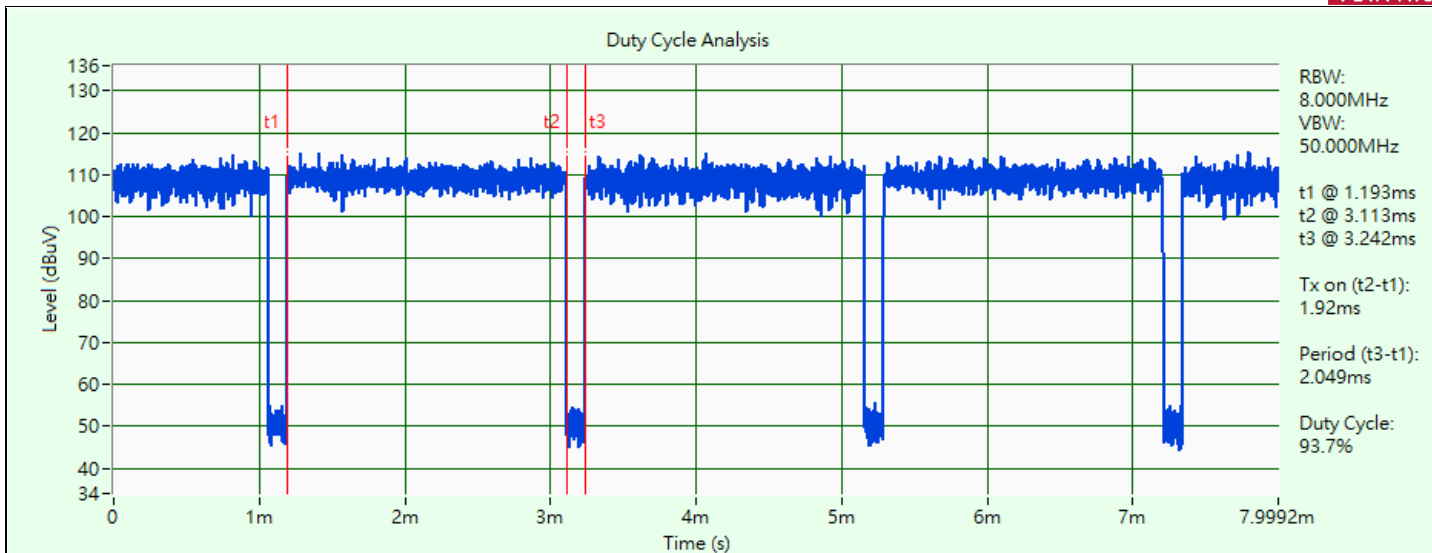

802.11n (HT20)

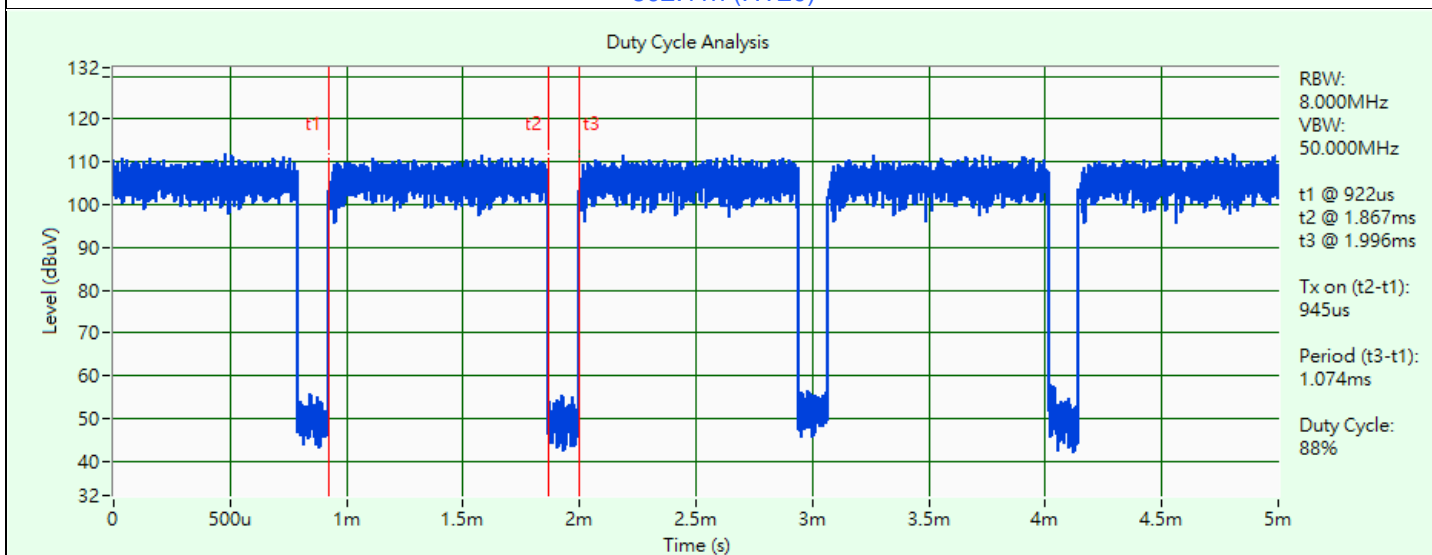

802.11n (HT40)

3.6 Test Program Used and Operation Descriptions

Controlling software (AmebaD_mptool V2.0) has been activated to set the EUT under transmission condition continuously at specific channel frequency.

3.7 Connection Diagram of EUT and Peripheral Devices

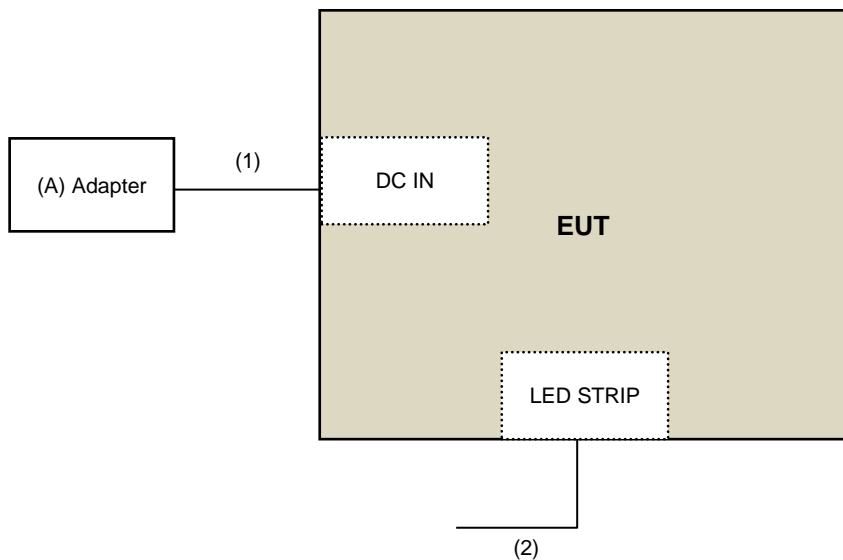

Under Table

3.8 Configuration of Peripheral Devices and Cable Connections

ID	Product	Brand	Model No.	Serial No.	FCC ID	Remarks
A	Adapter	ULLPOWER	ICP30A-240-1250	N/A	N/A	Supplied by applicant

ID	Cable Descriptions	Qty.	Length (m)	Shielding (Yes/No)	Cores (Qty.)	Remarks
1	Adapter DC cable	1	1.5	N	0	Supplied by applicant
2	LED STRIP	1	2	N	0	Supplied by applicant

4 Test Instruments

The calibration interval of the all test instruments are 12 months and the calibrations are traceable to NML/ROC and NIST/USA.

4.1 RF Output Power

Description Manufacturer	Model No.	Serial No.	Calibrated Date	Calibrated Until
MIMO Powermeasurement Test set (4X4) KEYSIGHT	U2021XA	U2021XA_001	2022/6/13	2023/6/12
MXG Vector Signal Generator KEYSIGHT	N5182B	MY53052658	2022/5/9	2023/5/8
Peak Power meter Anritsu	ML2495A	0842014	2023/5/5	2024/5/4
Pulse Power Sensor Anritsu	MA2411B	0738404	2023/5/5	2024/5/4
Spectrum Analyzer KEYSIGHT	N9030A	MY54490260	2022/7/14	2023/7/13
Spectrum Analyzer R&S	FSV40	101042	2022/9/5	2023/9/4
		101544	2022/5/9	2023/5/8
Temperature & Humidity Chamber TERCHY	MHU-225AU	920409	2022/6/27	2023/6/26
Voltage Meter FLUKE	179	89610322	2022/10/3	2023/10/2

Notes:

1. The test was performed in LK - Oven
2. Tested Date: 2023/5/8

4.2 Power Spectral Density

Refer to section 4.1 to get information of the instruments.

4.3 6 dB Bandwidth

Refer to section 4.1 to get information of the instruments.

4.4 Conducted Out of Band Emissions

Refer to section 4.1 to get information of the instruments.

4.5 AC Power Conducted Emissions

Description Manufacturer	Model No.	Serial No.	Calibrated Date	Calibrated Until
50 ohm terminal LYNICS	0900510	E1-011285	2022/9/19	2023/9/18
		E1-011286	2022/9/19	2023/9/18
50 Ohms Terminator LYNICS	0900510	E1-01-305	2023/2/13	2024/2/12
Attenuator STI	STI02-2200-10	NO.4	2022/9/2	2023/9/1
DC LISN R&S	ESH3-Z6	100219	2022/8/2	2023/8/1
		844950/018	2022/8/2	2023/8/1
DC LISN Schwarzbeck	NNLK 8121	8121-808	2023/5/2	2024/5/1
High Voltage Probe Schwarzbeck	TK9420	00982	2022/12/14	2023/12/13
Isolation Transformer Erika Fiedler	D-65396	017	2022/9/8	2023/9/7
LISN R&S	ENV216	101196	2022/5/24	2023/5/23
LISN Schwarzbeck	NNLK 8121	8121-00759	2022/8/18	2023/8/17
		8121-731	2022/5/26	2023/5/25
	NNLK8129	8129229	2022/6/8	2023/6/7
	NSLK 8128	8128-244	2022/11/8	2023/11/7
RF Coaxial Cable Commate	5D-FB	Cable-CO5-01	2023/1/19	2024/1/18
Software BVADT	Cond_V7.3.7.4	N/A	N/A	N/A
Test Receiver R&S	ESR3	102412	2022/12/21	2023/12/20

Notes:

1. The test was performed in Linkou Conduction 5.
2. Tested Date: 2023/5/6

4.6 Unwanted Emissions below 1 GHz

Description Manufacturer	Model No.	Serial No.	Calibrated Date	Calibrated Until
* LOOP ANTENNA EMCI	LPA600	270	2021/9/2	2023/9/1
Bi_Log Antenna Schwarzbeck	VULB 9168	137	2022/10/21	2023/10/20
Coupling/Dcoupling Network Schwarzbeck	CDNE-M2	00097	2022/6/1	2023/5/31
	CDNE-M3	00091	2022/6/1	2023/5/31
Pre_Amplifier EMCI	EMC001340	980269	2022/6/28	2023/6/27
Pre_Amplifier HP	8447D	2432A03504	2023/2/16	2024/2/15
RF Coaxial Cable Pacific	8D-FB	Cable-CH6-02	2022/6/30	2023/6/29
Software BVADT	Radiated_V7.7.1.1.1	N/A	N/A	N/A
	Radiated_V8.7.08	N/A	N/A	N/A
Spectrum Analyzer R&S	FSV40	101544	2022/5/9	2023/5/8
Test Receiver Agilent	N9038A	MY51210129	2023/3/24	2024/3/23
		MY51210137	2022/6/9	2023/6/8
Tower ADT	AT100	0306	N/A	N/A
Turn Table ADT	TT100	0306	N/A	N/A

Notes:

- * The calibration interval of the above test instruments is 24 months and the calibrations are traceable to NML/ROC and NIST/USA
- The test was performed in Linkou 966 Chamber 6 (CH 6).
- Tested Date: 2023/5/6

4.7 Unwanted Emissions above 1 GHz

Description Manufacturer	Model No.	Serial No.	Calibrated Date	Calibrated Until
Band Pass Filter MICRO-TRONICS	BRM17690	005	2022/5/26	2023/5/25
Boresight antenna tower fixture BV	BAF-02	6	N/A	N/A
High Pass Filter Wainwright Instruments	WHK 3.1/18G-10SS	SN 8	2022/5/26	2023/5/25
Horn Antenna EMCO	3115	00028257	2022/11/13	2023/11/12
Horn Antenna ETS-Lindgren	3117-PA	00215857	2023/2/3	2024/2/2
Horn Antenna Schwarzbeck	BBHA 9170	212	2022/10/20	2023/10/19
Notch Filter MICRO-TRONICS	BRC50703-01	010	2022/5/26	2023/5/25
Pre-amplifier HP	8449B	3008A01201	2023/2/16	2024/2/15
Pre-amplifier (18GHz-40GHz) EMCI	EMC184045B	980175	2022/9/3	2023/9/2
Pre_Amplifier EMCI	EMC0126545	980076	2023/2/16	2024/2/15
	EMC184045B	980235	2023/2/16	2024/2/15
RF Coaxial Cable EM	EM102-KMKM-3.5+1M	EM102-KMKM-3.5+1M-01	2022/7/7	2023/7/6
RF Coaxial Cable EMCI	EMC104	190801	2022/9/20	2023/9/19
		190804	2022/9/20	2023/9/19
RF Coaxial Cable HUBER SUHNER	SF-104	Cable-CH6-01	2022/9/20	2023/9/19
Software BVADT	Radiated_V7.7.1.1.1	N/A	N/A	N/A
	Radiated_V8.7.08	N/A	N/A	N/A
Spectrum Analyzer R&S	FSV40	101042	2022/9/5	2023/9/4
		101544	2022/5/9	2023/5/8
Test Receiver Agilent	N9038A	MY51210129	2023/3/24	2024/3/23
		MY51210137	2022/6/9	2023/6/8
Tower ADT	AT100	0306	N/A	N/A
Turn Table ADT	TT100	0306	N/A	N/A

Notes:

1. The test was performed in Linkou 966 Chamber 6 (CH 6).
2. Tested Date: 2023/4/17 ~ 2023/4/18

5 Limits of Test Items

5.1 RF Output Power

For systems using digital modulation in the 2400–2483.5 MHz bands: 1 Watt (30 dBm)

5.2 Power Spectral Density

The Maximum of Power Spectral Density Measurement is 8 dBm in any 3 kHz.

5.3 6 dB Bandwidth

The minimum of 6 dB Bandwidth Measurement is 0.5 MHz.

5.4 Conducted Out of Band Emissions

Below 20 dB of the highest emission level of operating band (in 100 kHz Resolution Bandwidth).

5.5 AC Power Conducted Emissions

Frequency (MHz)	Conducted Limit (dBuV)	
	Quasi-peak	Average
0.15 - 0.5	66 - 56	56 - 46
0.50 - 5.0	56	46
5.0 - 30.0	60	50

Notes:

1. The lower limit shall apply at the transition frequencies.
2. The limit decreases in line with the logarithm of the frequency in the range of 0.15 to 0.50 MHz.

5.6 Unwanted Emissions below 1 GHz

Radiated emissions up to 1 GHz which fall in the restricted bands must comply with the radiated emission limits specified as below table. Other emissions shall be at least 20 dB below the highest level of the desired power:

Frequencies (MHz)	Field Strength (microvolts/meter)	Measurement Distance (meters)
0.009 ~ 0.490	2400/F(kHz)	300
0.490 ~ 1.705	24000/F(kHz)	30
1.705 ~ 30.0	30	30
30 ~ 88	100	3
88 ~ 216	150	3
216 ~ 960	200	3
Above 960	500	3

Notes:

1. The lower limit shall apply at the transition frequencies.
2. Emission level (dBuV/m) = 20 log Emission level (uV/m).

5.7 Unwanted Emissions above 1 GHz

Radiated emissions above 1 GHz which fall in the restricted bands must comply with the radiated emission limits specified as below table. Other emissions shall be at least 20 dB below the highest level of the desired power:

Frequencies (MHz)	Field Strength (microvolts/meter)	Measurement Distance (meters)
Above 960	500	3

Notes:

1. The lower limit shall apply at the transition frequencies.
2. Emission level (dBuV/m) = 20 log Emission level (uV/m).
3. For frequencies above 1000 MHz, the field strength limits are based on average detector, however, the peak field strength of any emission shall not exceed the maximum permitted average limits, specified above by more than 20 dB under any condition of modulation.

6 Test Arrangements

6.1 RF Output Power

6.1.1 Test Setup

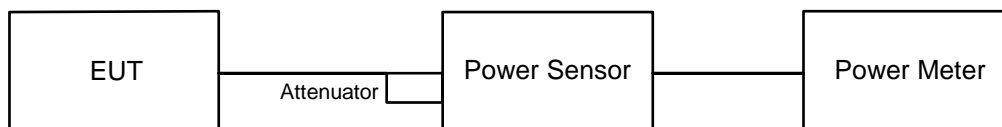

6.1.2 Test Procedure

Peak Power:

A peak power sensor was used on the output port of the EUT. A power meter was used to read the response of the peak power sensor. Record the power level.

Average Power:

Average power sensor was used to perform output power measurement, trigger and gating function of wide band power meter is enabled to measure max output power of TX on burst. Duty factor is not added to measured value.

6.2 Power Spectral Density

6.2.1 Test Setup

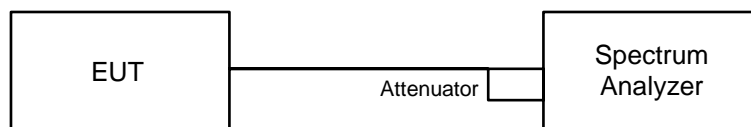

6.2.2 Test Procedure

- a. Set analyzer center frequency to DTS channel center frequency.
- b. Set the span to 1.5 times the DTS bandwidth.
- c. Set the RBW to: 3 kHz.
- d. Set the VBW $\geq 3 \times$ RBW.
- e. Detector = peak.
- f. Sweep time = auto couple.
- g. Trace mode = max hold.
- h. Allow trace to fully stabilize.
- i. Use the peak marker function to determine the maximum amplitude level within the RBW.

6.3 6 dB Bandwidth

6.3.1 Test Setup

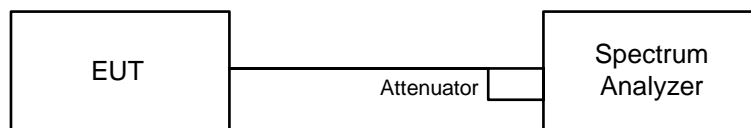

6.3.2 Test Procedure

- a. Set resolution bandwidth (RBW) = 100 kHz.
- b. Set the video bandwidth (VBW) $\geq 3 \times$ RBW, Detector = Peak.
- c. Trace mode = max hold.
- d. Sweep = auto couple.
- e. Measure the maximum width of the emission that is constrained by the frequencies associated with the two amplitude points (upper and lower) that are attenuated by 6 dB relative to the maximum level measured in the fundamental emission.

6.4 Conducted Out of Band Emissions

6.4.1 Test Setup

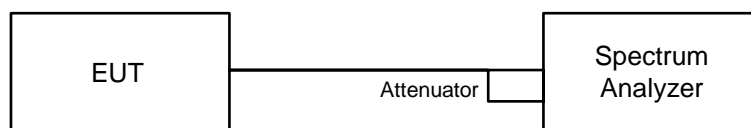

6.4.2 Test Procedure

MEASUREMENT PROCEDURE REF

- a. Set the RBW = 100 kHz.
- b. Set the VBW ≥ 300 kHz.
- c. Detector = peak.
- d. Sweep time = auto couple.
- e. Trace mode = max hold.
- f. Allow trace to fully stabilize.
- g. Use the peak marker function to determine the maximum power level in any 100 kHz band segment within the fundamental EBW.

MEASUREMENT PROCEDURE OOB

- a. Set RBW = 100 kHz.
- b. Set VBW ≥ 300 kHz.
- c. Detector = peak.
- d. Sweep = auto couple.
- e. Trace Mode = max hold.
- f. Allow trace to fully stabilize.
- g. Use the peak marker function to determine the maximum amplitude level.

6.5 AC Power Conducted Emissions

6.5.1 Test Setup

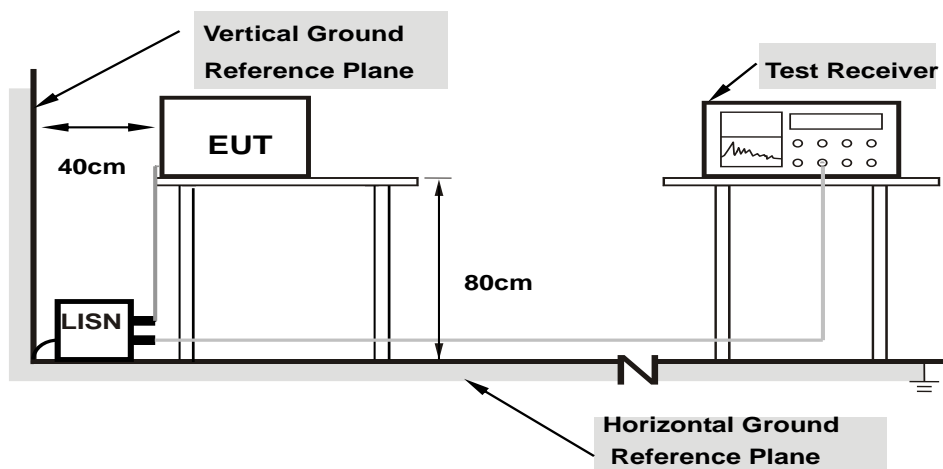

Note: 1.Support units were connected to second LISN.

For the actual test configuration, please refer to the attached file (Test Setup Photo).

6.5.2 Test Procedure

- The EUT was placed on a 0.8 meter to the top of table and placed 0.4 meters from the conducting wall of the shielded room with EUT being connected to the power mains through a line impedance stabilization network (LISN). Other support units were connected to the power mains through another LISN. The two LISNs provide 50 ohm/ 50 uH of coupling impedance for the measuring instrument.
- Both lines of the power mains connected to the EUT were checked for maximum conducted interference.
- The frequency range from 150 kHz to 30 MHz was searched. Emission levels under (Limit – 20 dB) was not recorded.

Note: The resolution bandwidth and video bandwidth of test receiver is 9 kHz for quasi-peak detection (QP) and average detection (AV) at frequency 0.15 MHz-30 MHz.

6.6 Unwanted Emissions below 1 GHz

6.6.1 Test Setup

For Radiated emission below 30 MHz

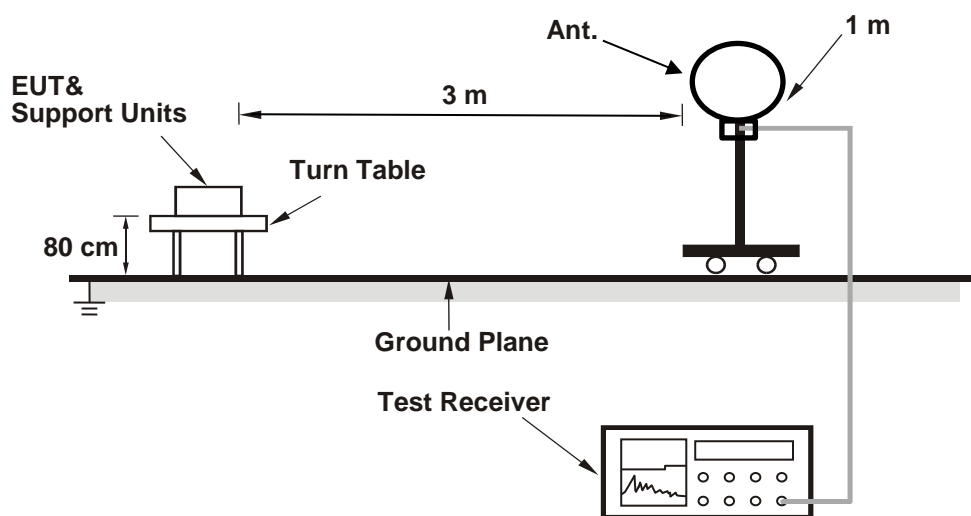

For Radiated emission above 30 MHz

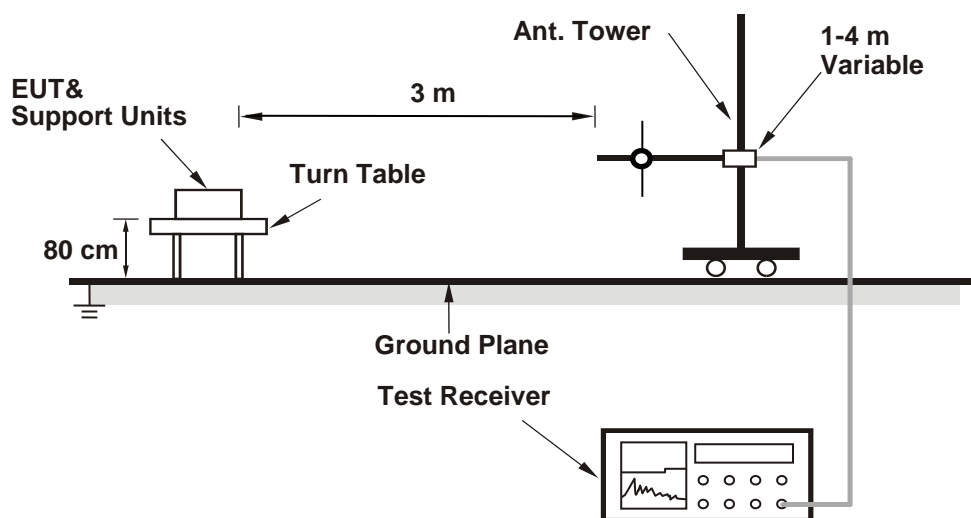

For the actual test configuration, please refer to the attached file (Test Setup Photo).

6.6.2 Test Procedure

For Radiated emission below 30 MHz

- a. The EUT was placed on the top of a rotating table 0.8 meters above the ground at 3 meter chamber room for test. The table was rotated 360 degrees to determine the position of the highest radiation.
- b. The EUT was set 3 meters away from the interference-receiving antenna, which was mounted on the top of a variable-height antenna tower.
- c. Parallel, perpendicular, and ground-parallel orientations of the antenna are set to make the measurement.
- d. For each suspected emission, the EUT was arranged to its worst case and the rotatable table was turned from 0 degrees to 360 degrees to find the maximum reading.
- e. The test-receiver system was set to Quasi-Peak Detect Function and Specified Bandwidth with Maximum Hold Mode, except for the frequency band (9 kHz to 90 kHz and 110 kHz to 490 kHz) set to average detect function and peak detect function.

Notes:

1. The resolution bandwidth and video bandwidth of test receiver/spectrum analyzer is 200 Hz at frequency below 150 kHz.
2. The resolution bandwidth and video bandwidth of test receiver/spectrum analyzer is 9 kHz or 10 kHz at frequency (150 kHz to 30 MHz).
3. All modes of operation were investigated and the worst-case emissions are reported.

For Radiated emission above 30 MHz

- a. The EUT was placed on the top of a rotating table 0.8 meters above the ground at 3 meter chamber room for test. The table was rotated 360 degrees to determine the position of the highest radiation.
- b. The EUT was set 3 meters away from the interference-receiving antenna, which was mounted on the top of a variable-height antenna tower.
- c. The height of antenna is varied from one meter to four meters above the ground to determine the maximum value of the field strength. Both horizontal and vertical polarizations of the antenna are set to make the measurement.
- d. For each suspected emission, the EUT was arranged to its worst case and then the antenna was tuned to heights from 1 meter to 4 meters and the rotatable table was turned from 0 degrees to 360 degrees to find the maximum reading.
- e. The test-receiver system was set to quasi-peak detect function and specified bandwidth with maximum hold mode when the test frequency is below 1 GHz.

Notes:

1. The resolution bandwidth and video bandwidth of test receiver/spectrum analyzer is 120 kHz for Quasi-peak detection (QP) at frequency below 1 GHz.
2. All modes of operation were investigated and the worst-case emissions are reported.

6.7 Unwanted Emissions above 1 GHz

6.7.1 Test Setup

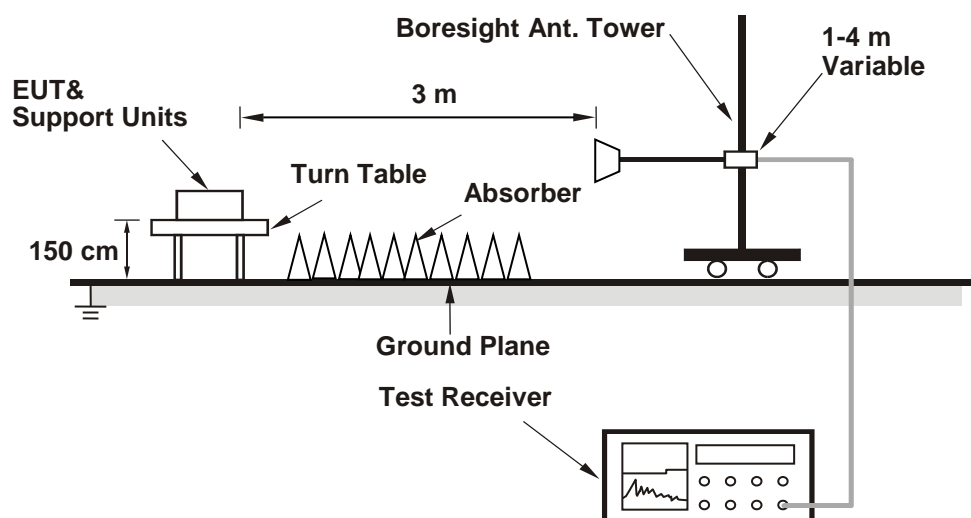

For the actual test configuration, please refer to the attached file (Test Setup Photo).

6.7.2 Test Procedure

- The EUT was placed on the top of a rotating table 1.5 meters above the ground at 3 meter chamber room for test. The table was rotated 360 degrees to determine the position of the highest radiation.
- The EUT was set 3 meters away from the interference-receiving antenna, which was mounted on the top of a variable-height antenna tower.
- The height of antenna is varied from one meter to four meters above the ground to determine the maximum value of the field strength. Both horizontal and vertical polarizations of the antenna are set to make the measurement.
- For each suspected emission, the EUT was arranged to its worst case and then the antenna was tuned to heights from 1 meter to 4 meters and the rotatable table was turned from 0 degrees to 360 degrees to find the maximum reading.
- The test-receiver system was set to peak and average detects function and specified bandwidth with maximum hold mode when the test frequency is above 1 GHz. If the peak reading value also meets average limit, measurement with the average detector is unnecessary.

Notes:

- The resolution bandwidth of test receiver/spectrum analyzer is 1 MHz and the video bandwidth is 3 MHz for Peak detection (PK) and Average detection (AV) at frequency above 1 GHz.
- For fundamental and harmonic signal measurement, the resolution bandwidth of test receiver/spectrum analyzer is 1 MHz and the video bandwidth is $\geq 1/T$ (Duty cycle $< 98\%$) or 10 Hz (Duty cycle $\geq 98\%$) for Average detection (AV) at frequency above 1 GHz.
- All modes of operation were investigated and the worst-case emissions are reported.

7 Test Results of Test Item

7.1 RF Output Power

Input Power:	120 Vac, 60 Hz	Environmental Conditions:	25°C, 76% RH	Tested By:	Dalen Dai
--------------	----------------	---------------------------	--------------	------------	-----------

For Peak Power

802.11b

Chan.	Chan. Freq. (MHz)	Peak Power (mW)	Peak Power (dBm)	Power Limit (dBm)	Test Result
1	2412	423.643	26.27	30	Pass
6	2437	422.669	26.26	30	Pass
11	2462	328.852	25.17	30	Pass

Note: The antenna gain is 1.05 dBi < 6 dBi, so the output power limit shall not be reduced.

802.11g

Chan.	Chan. Freq. (MHz)	Peak Power (mW)	Peak Power (dBm)	Power Limit (dBm)	Test Result
1	2412	645.654	28.10	30	Pass
6	2437	635.331	28.03	30	Pass
11	2462	415.911	26.19	30	Pass

Note: The antenna gain is 1.05 dBi < 6 dBi, so the output power limit shall not be reduced.

802.11n (HT20)

Chan.	Chan. Freq. (MHz)	Peak Power (mW)	Peak Power (dBm)	Power Limit (dBm)	Test Result
1	2412	542.001	27.34	30	Pass
6	2437	633.87	28.02	30	Pass
11	2462	378.443	25.78	30	Pass

Note: The antenna gain is 1.05 dBi < 6 dBi, so the output power limit shall not be reduced.

802.11n (HT40)

Chan.	Chan. Freq. (MHz)	Peak Power (mW)	Peak Power (dBm)	Power Limit (dBm)	Test Result
3	2422	533.335	27.27	30	Pass
6	2437	487.528	26.88	30	Pass
9	2452	425.598	26.29	30	Pass

Note: The antenna gain is 1.05 dBi < 6 dBi, so the output power limit shall not be reduced.

For Average Power

802.11b

Chan.	Chan. Freq. (MHz)	Average Power (mW)	Average Power (dBm)
1	2412	268.534	24.29
6	2437	276.058	24.41
11	2462	214.289	23.31

802.11g

Chan.	Chan. Freq. (MHz)	Average Power (mW)	Average Power (dBm)
1	2412	206.063	23.14
6	2437	219.28	23.41
11	2462	70.146	18.46

802.11n (HT20)

Chan.	Chan. Freq. (MHz)	Average Power (mW)	Average Power (dBm)
1	2412	160.325	22.05
6	2437	204.174	23.10
11	2462	66.681	18.24

802.11n (HT40)

Chan.	Chan. Freq. (MHz)	Average Power (mW)	Average Power (dBm)
3	2422	148.594	21.72
6	2437	83.753	19.23
9	2452	67.143	18.27

7.2 Power Spectral Density

Input Power:	120 Vac, 60 Hz	Environmental Conditions:	25°C, 76% RH	Tested By:	Dalen Dai
--------------	----------------	---------------------------	--------------	------------	-----------

802.11b

TX chain	Channel	Freq. (MHz)	PSD (dBm/3kHz)	PSD Limit (dBm/3kHz)	Pass / Fail
Chain 0	1	2412	2.11	8	Pass
	6	2437	2.08	8	Pass
	11	2462	0.91	8	Pass

Note: The antenna gain is 1.05 dBi < 6 dBi, so the power density limit shall not be reduced.

802.11g

TX chain	Channel	Freq. (MHz)	PSD (dBm/3kHz)	PSD Limit (dBm/3kHz)	Pass / Fail
Chain 0	1	2412	-1.69	8	Pass
	6	2437	-1.32	8	Pass
	11	2462	-5.65	8	Pass

Note: The antenna gain is 1.05 dBi < 6 dBi, so the power density limit shall not be reduced.

802.11n (HT20)

TX chain	Channel	Freq. (MHz)	PSD (dBm/3kHz)	PSD Limit (dBm/3kHz)	Pass / Fail
Chain 0	1	2412	-2.86	8	Pass
	6	2437	-1.84	8	Pass
	11	2462	-6.48	8	Pass

Note: The antenna gain is 1.05 dBi < 6 dBi, so the power density limit shall not be reduced.

802.11n (HT40)

TX chain	Channel	Freq. (MHz)	PSD (dBm/3kHz)	PSD Limit (dBm/3kHz)	Pass / Fail
Chain 0	3	2422	-5.95	8	Pass
	6	2437	-8.13	8	Pass
	9	2452	-9.04	8	Pass

Note: The antenna gain is 1.05 dBi < 6 dBi, so the power density limit shall not be reduced.



Spectrum Plot of Maximum Value

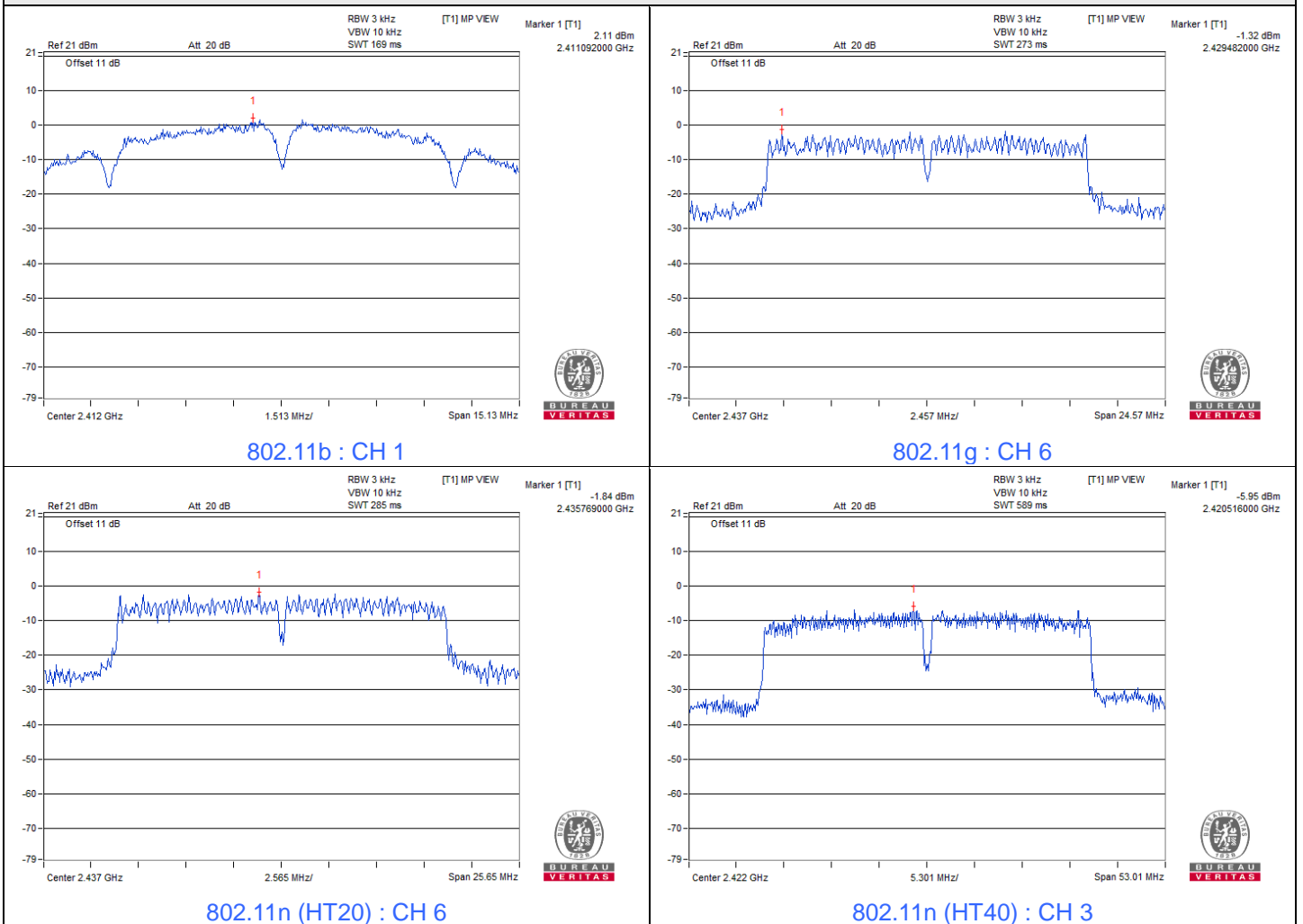

7.3 6 dB Bandwidth

Input Power:	120 Vac, 60 Hz	Environmental Conditions:	25°C, 76% RH	Tested By:	Dalen Dai
--------------	----------------	---------------------------	--------------	------------	-----------

802.11b

Channel	Frequency (MHz)	6dB Bandwidth (MHz)	Minimum Limit (MHz)	Test Result
1	2412	10.09	0.5	Pass
6	2437	10.1	0.5	Pass
11	2462	10.1	0.5	Pass

802.11g

Channel	Frequency (MHz)	6dB Bandwidth (MHz)	Minimum Limit (MHz)	Test Result
1	2412	16.38	0.5	Pass
6	2437	16.38	0.5	Pass
11	2462	16.38	0.5	Pass

802.11n (HT20)

Channel	Frequency (MHz)	6dB Bandwidth (MHz)	Minimum Limit (MHz)	Test Result
1	2412	17.25	0.5	Pass
6	2437	17.1	0.5	Pass
11	2462	17.13	0.5	Pass

802.11n (HT40)

Channel	Frequency (MHz)	6dB Bandwidth (MHz)	Minimum Limit (MHz)	Test Result
3	2422	35.34	0.5	Pass
6	2437	35.33	0.5	Pass
9	2452	35.33	0.5	Pass

Spectrum Plot of Minimum Value

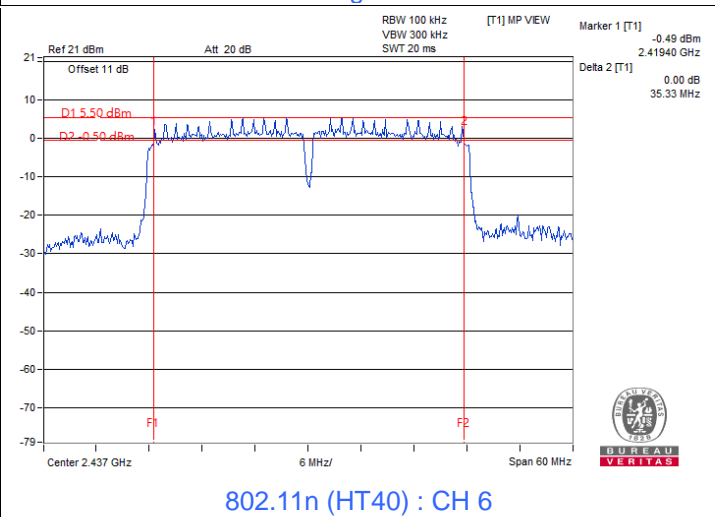
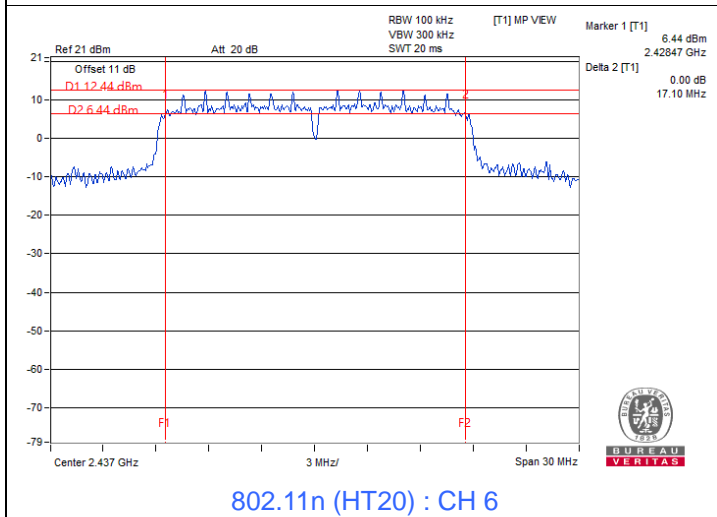
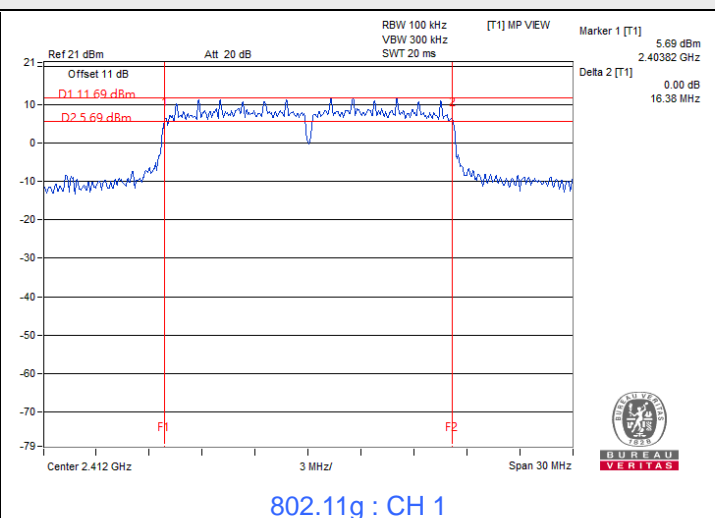
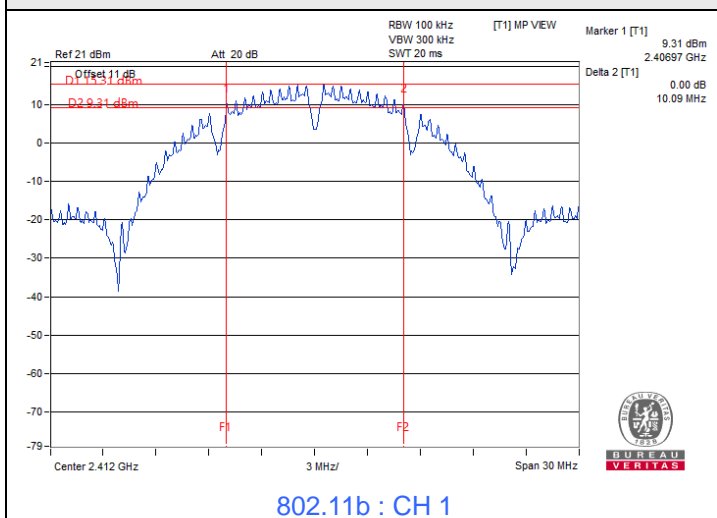



BUREAU VERITAS

7.4 Conducted Out of Band Emissions

Input Power:	120 Vac, 60 Hz	Environmental Conditions:	25°C, 76% RH	Tested By:	Dalen Dai
--------------	----------------	---------------------------	--------------	------------	-----------

802.11b

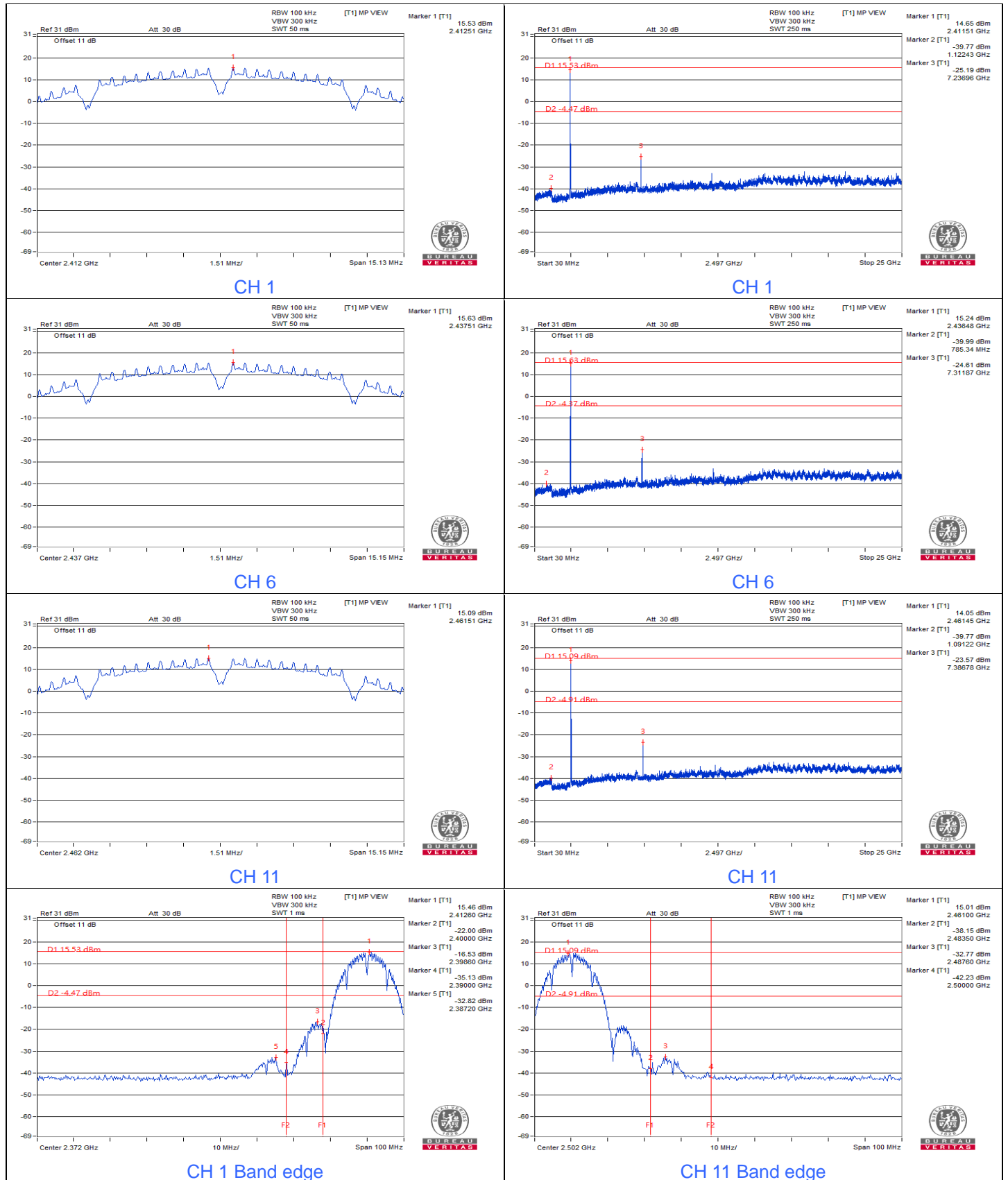



802.11g

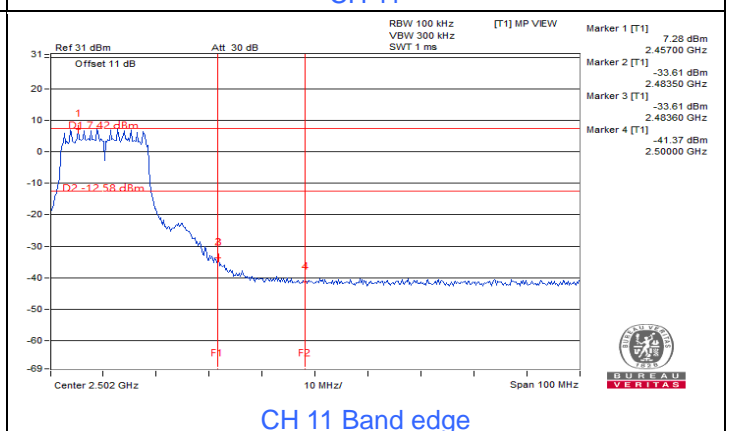
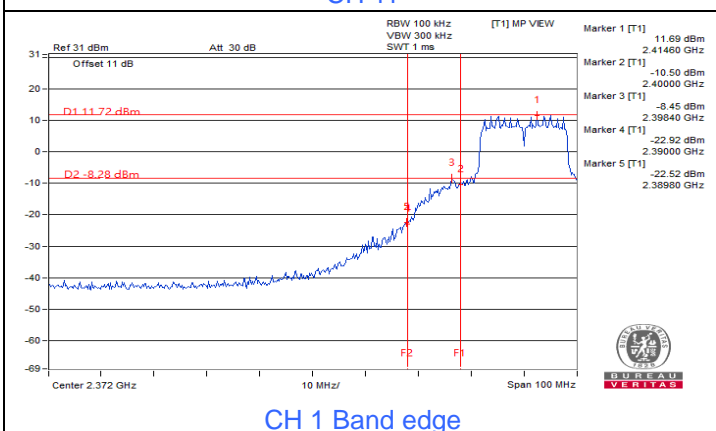
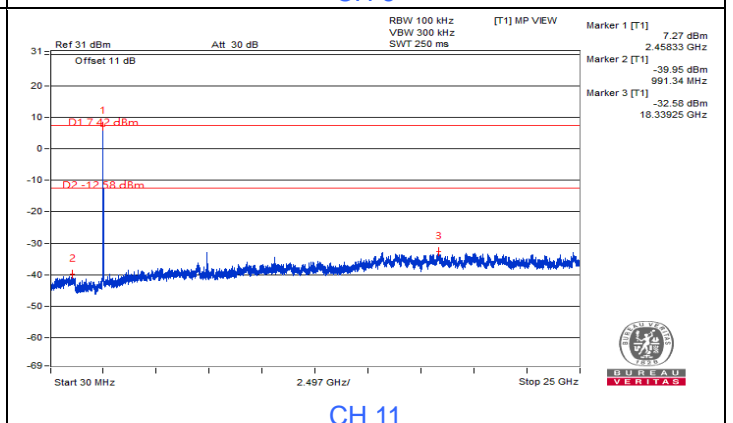
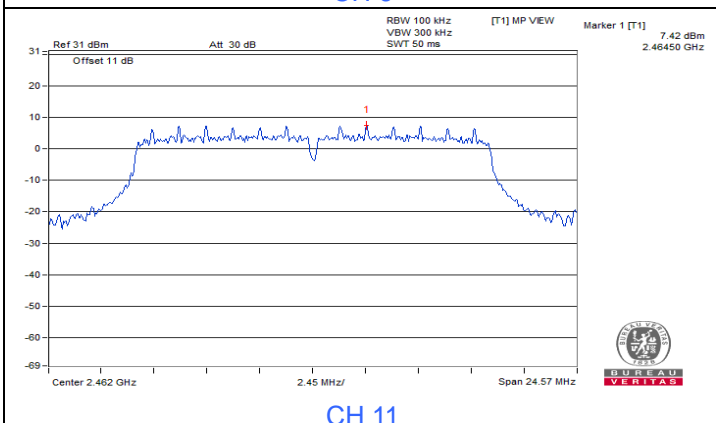
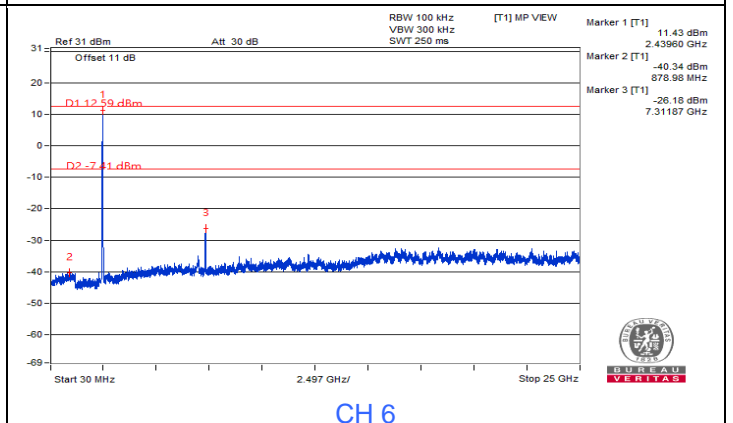
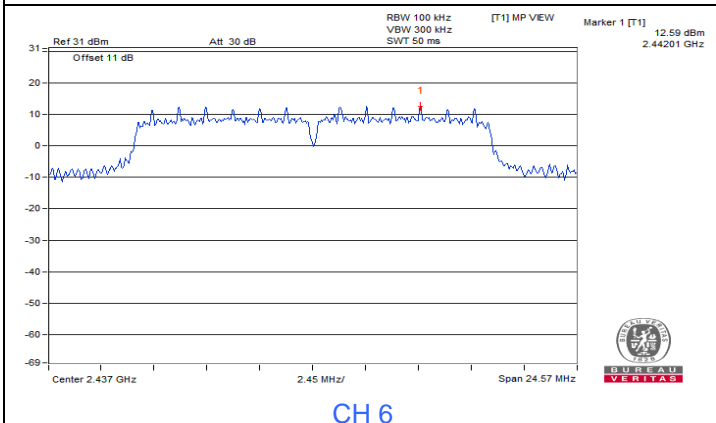
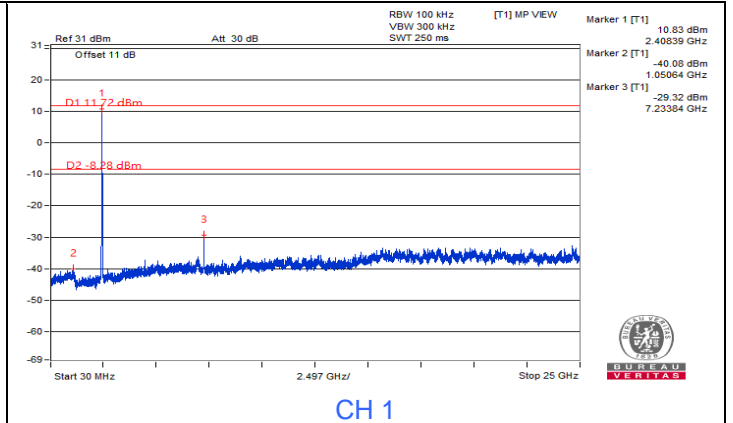
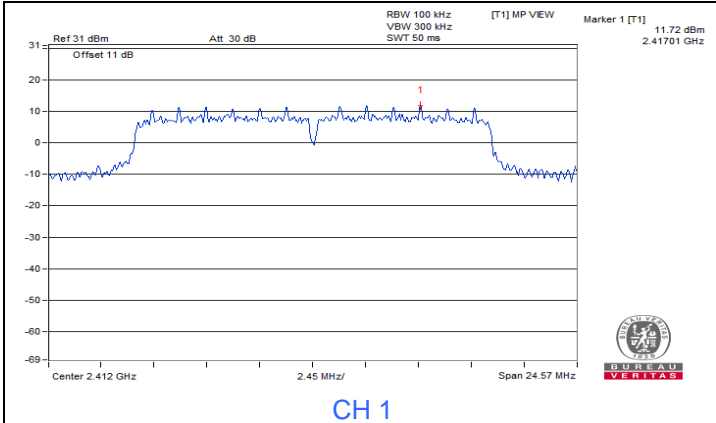



802.11n (HT20)

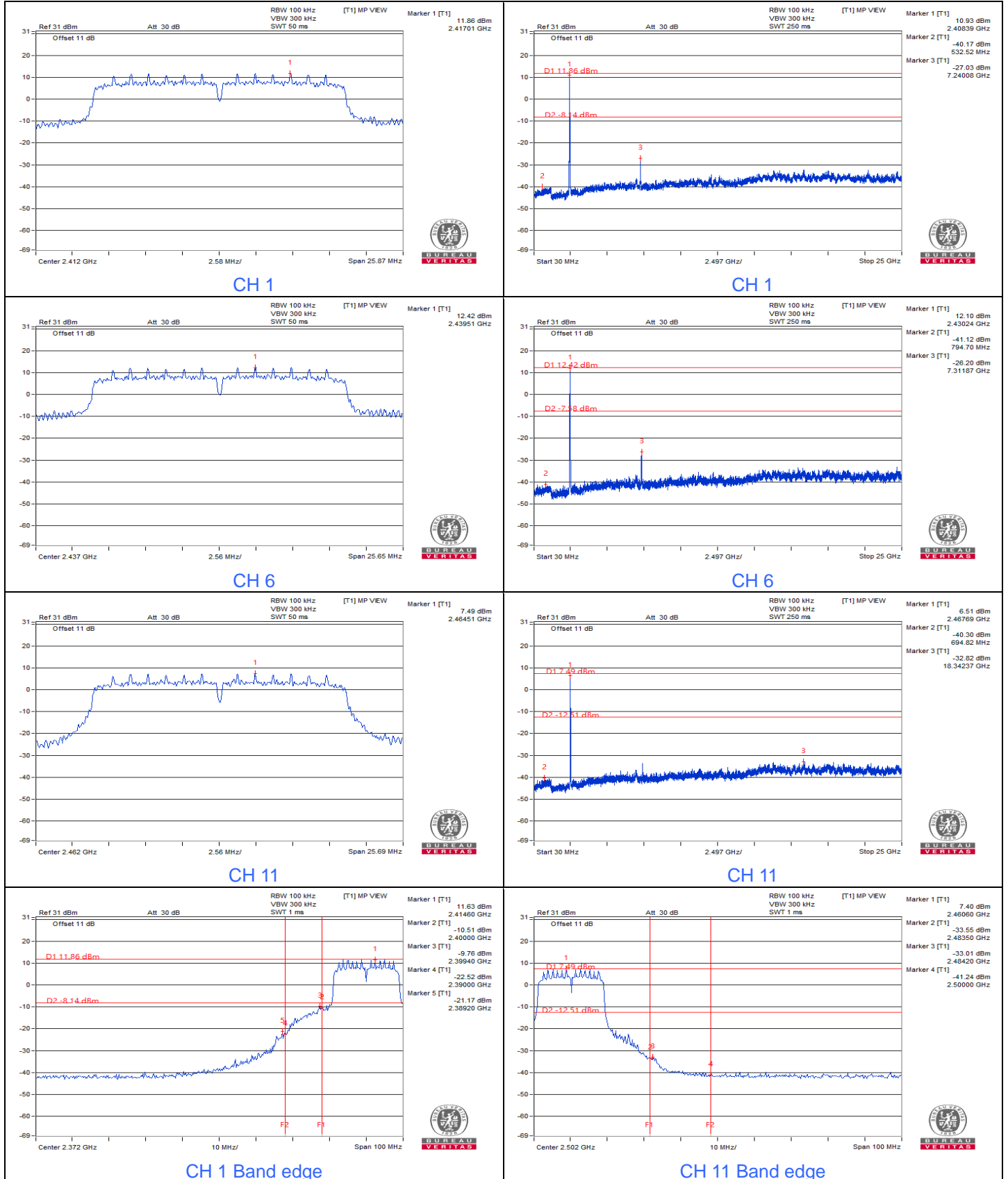



802.11n (HT40)

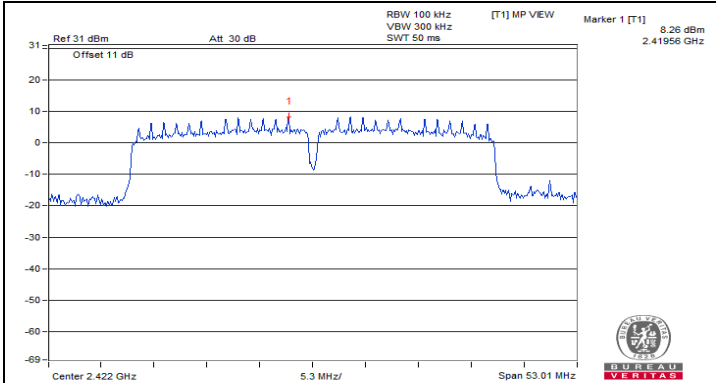

CH 3

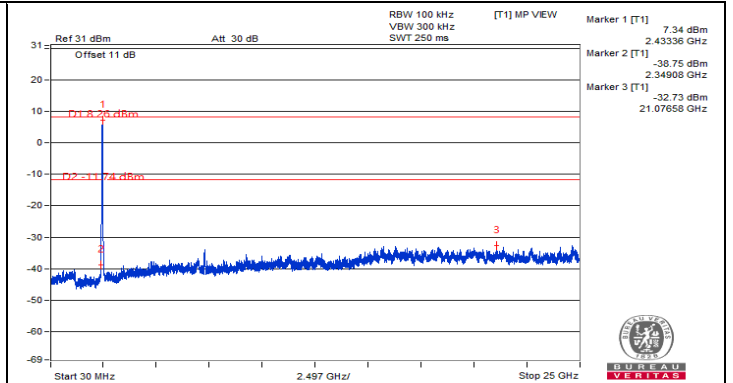

CH 3

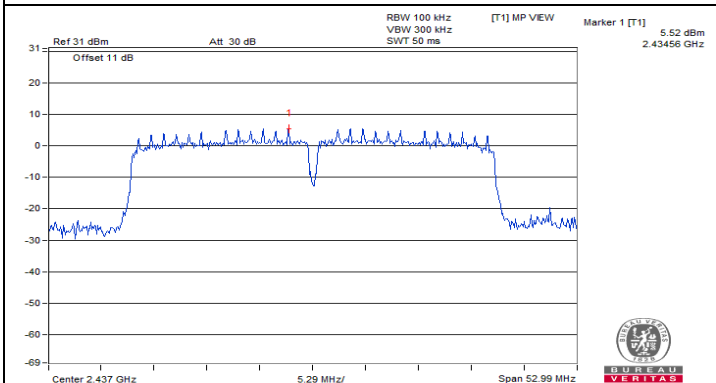

CH 6

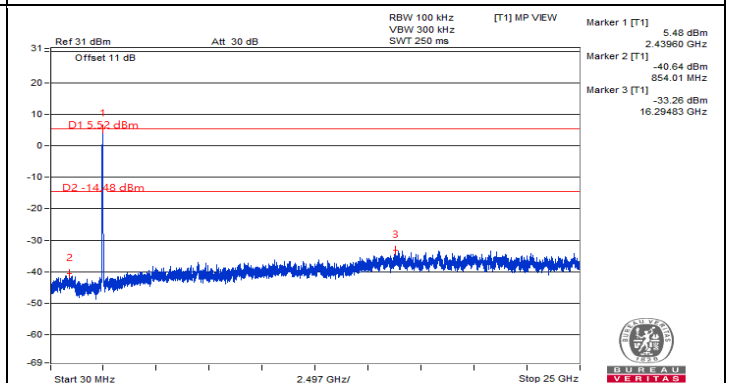

CH 6

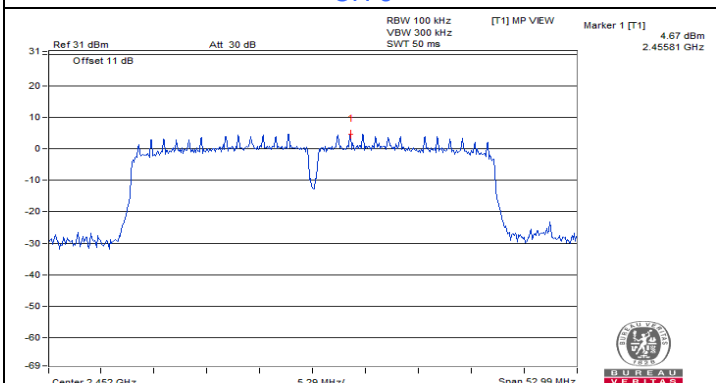

CH 9

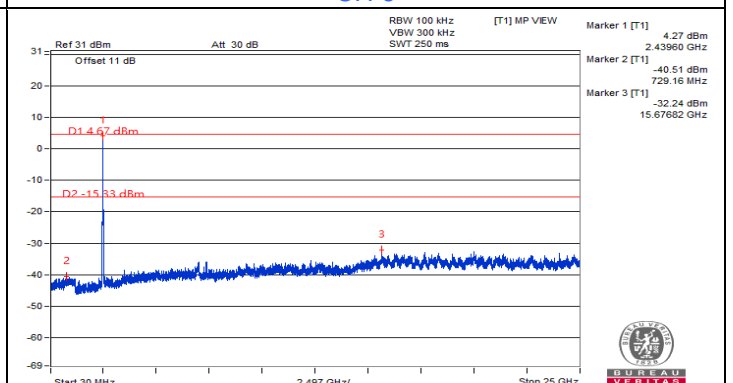

CH 9

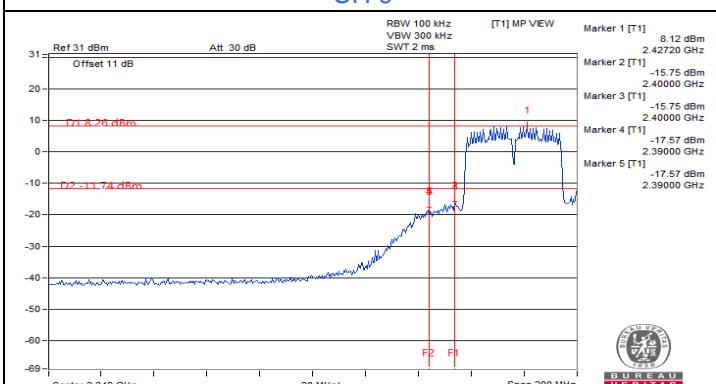

CH 3 Band edge

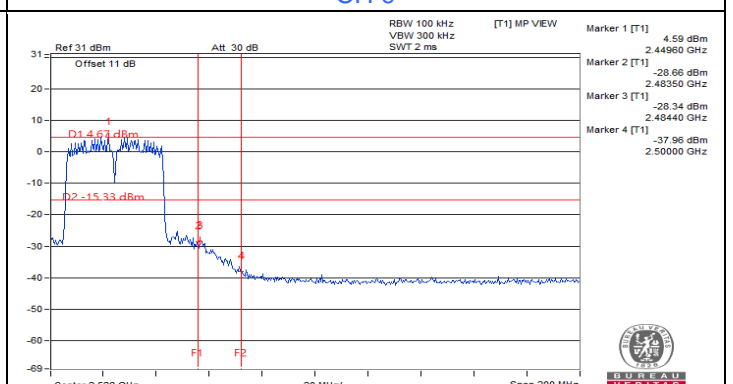

CH 9 Band edge

7.5 AC Power Conducted Emissions

RF Mode	802.11g	Channel	CH 1 : 2412 MHz
Frequency Range	150kHz ~ 30MHz	Detector Function & Resolution Bandwidth	Quasi-Peak (QP) / Average (AV), 9 kHz
Input Power	120 Vac, 60 Hz	Environmental Conditions	25°C, 75% RH
Tested By	Jed Wu		

Phase Of Power : Line (L)										
No	Frequency (MHz)	Correction Factor (dB)	Reading Value (dBuV)		Emission Level (dBuV)		Limit (dBuV)		Margin (dB)	
			Q.P.	AV.	Q.P.	AV.	Q.P.	AV.	Q.P.	AV.
1	0.22200	10.13	22.93	12.10	33.06	22.23	62.74	52.74	-29.68	-30.51
2	0.36600	10.19	33.97	20.94	44.16	31.13	58.59	48.59	-14.43	-17.46
3	0.73600	10.29	24.68	14.41	34.97	24.70	56.00	46.00	-21.03	-21.30
4	1.18965	10.37	28.91	15.19	39.28	25.56	56.00	46.00	-16.72	-20.44
5	5.92000	10.55	18.67	13.04	29.22	23.59	60.00	50.00	-30.78	-26.41
6	9.11200	10.64	25.79	19.73	36.43	30.37	60.00	50.00	-23.57	-19.63

Remarks:

1. Q.P. and AV. are abbreviations of quasi-peak and average individually.
2. The emission levels of other frequencies were very low against the limit.
3. Margin value = Emission level – Limit value
4. Correction factor = Insertion loss + Cable loss
5. Emission Level = Correction Factor + Reading Value

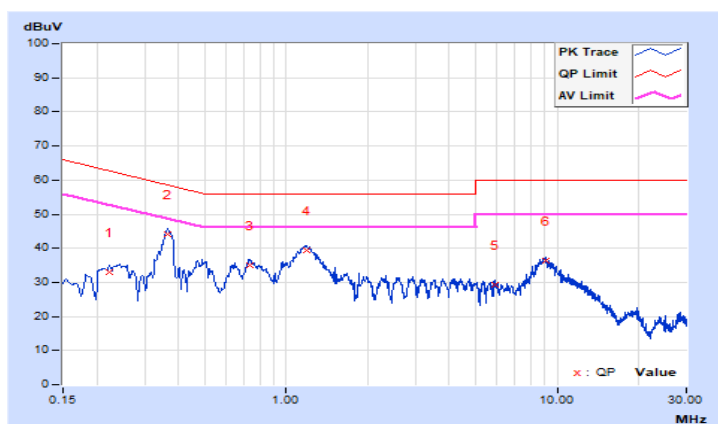

RF Mode	802.11g	Channel	CH 1 : 2412 MHz
Frequency Range	150kHz ~ 30MHz	Detector Function & Resolution Bandwidth	Quasi-Peak (QP) / Average (AV), 9 kHz
Input Power	120 Vac, 60 Hz	Environmental Conditions	25°C, 75% RH
Tested By	Jed Wu		

Phase Of Power : Neutral (N)										
No	Frequency (MHz)	Correction Factor (dB)	Reading Value (dBuV)		Emission Level (dBuV)		Limit (dBuV)		Margin (dB)	
			Q.P.	AV.	Q.P.	AV.	Q.P.	AV.	Q.P.	AV.
1	0.20600	10.18	20.46	12.21	30.64	22.39	63.37	53.37	-32.73	-30.98
2	0.36737	10.19	32.99	21.04	43.18	31.23	58.56	48.56	-15.38	-17.33
3	0.72800	10.23	22.52	11.92	32.75	22.15	56.00	46.00	-23.25	-23.85
4	1.17200	10.27	28.65	12.97	38.92	23.24	56.00	46.00	-17.08	-22.76
5	9.66000	10.65	19.40	14.30	30.05	24.95	60.00	50.00	-29.95	-25.05
6	14.25200	10.76	13.08	7.96	23.84	18.72	60.00	50.00	-36.16	-31.28

Remarks:

1. Q.P. and AV. are abbreviations of quasi-peak and average individually.
2. The emission levels of other frequencies were very low against the limit.
3. Margin value = Emission level – Limit value
4. Correction factor = Insertion loss + Cable loss
5. Emission Level = Correction Factor + Reading Value

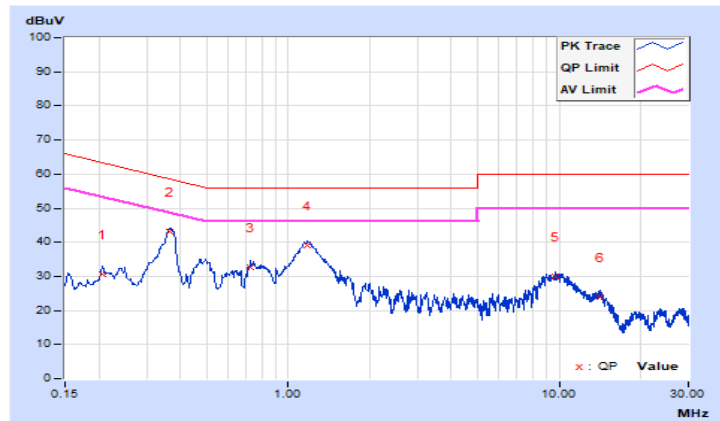

7.6 Unwanted Emissions below 1 GHz

RF Mode	802.11g	Channel	CH 1 : 2412 MHz
Frequency Range	30 MHz ~ 1 GHz	Detector Function & Bandwidth	(QP) RB = 120kHz
Input Power	120 Vac, 60 Hz	Environmental Conditions	14°C, 58% RH
Tested By	Jed Wu		

Antenna Polarity & Test Distance : Horizontal at 3 m								
No	Frequency (MHz)	Emission Level (dBuV/m)	Limit (dBuV/m)	Margin (dB)	Antenna Height (m)	Table Angle (Degree)	Raw Value (dBuV)	Correction Factor (dB/m)
1	73.75	25.4 QP	40.0	-14.6	1.47 H	61	37.3	-11.9
2	107.75	24.2 QP	43.5	-19.3	1.58 H	107	36.1	-11.9
3	177.15	27.0 QP	43.5	-16.5	1.69 H	88	36.2	-9.2
4	240.00	30.6 QP	46.0	-15.4	1.72 H	54	39.4	-8.8
5	290.35	27.9 QP	46.0	-18.1	1.81 H	307	34.4	-6.5
6	364.26	29.6 QP	46.0	-16.4	1.93 H	136	34.4	-4.8

Remarks:

1. Emission Level(dBuV/m) = Raw Value(dBuV) + Correction Factor(dB/m)
2. Correction Factor(dB/m) = Antenna Factor(dB/m) + Cable Factor(dB) – Pre-Amplifier Factor(dB)
3. Margin value = Emission Level – Limit value
4. The other emission levels were very low against the limit of frequency range 30 MHz ~ 1 GHz.
5. The emission levels were very low against the limit of frequency range 9 kHz ~ 30 MHz: the amplitude of spurious emissions attenuated more than 20 dB below the permissible value to be report.

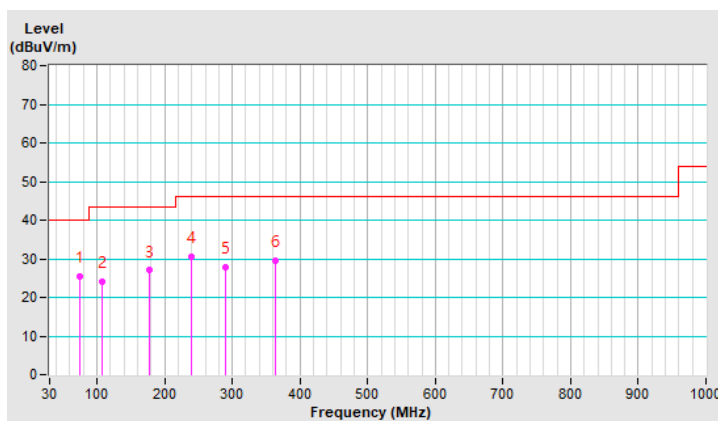

RF Mode	802.11g	Channel	CH 1 : 2412 MHz
Frequency Range	30 MHz ~ 1 GHz	Detector Function & Bandwidth	(QP) RB = 120kHz
Input Power	120 Vac, 60 Hz	Environmental Conditions	14°C, 58% RH
Tested By	Jed Wu		

Antenna Polarity & Test Distance : Vertical at 3 m								
No	Frequency (MHz)	Emission Level (dBuV/m)	Limit (dBuV/m)	Margin (dB)	Antenna Height (m)	Table Angle (Degree)	Raw Value (dBuV)	Correction Factor (dB/m)
1	61.72	29.3 QP	40.0	-10.7	1.40 V	296	39.0	-9.7
2	107.31	25.6 QP	43.5	-17.9	1.57 V	29	37.6	-12.0
3	176.13	25.9 QP	43.5	-17.6	1.86 V	107	35.0	-9.1
4	308.73	26.1 QP	46.0	-19.9	1.93 V	87	31.9	-5.8
5	381.58	27.1 QP	46.0	-18.9	1.24 V	36	31.3	-4.2
6	422.51	26.3 QP	46.0	-19.7	1.32 V	204	29.4	-3.1

Remarks:

1. Emission Level(dBuV/m) = Raw Value(dBuV) + Correction Factor(dB/m)
2. Correction Factor(dB/m) = Antenna Factor(dB/m) + Cable Factor(dB) – Pre-Amplifier Factor(dB)
3. Margin value = Emission Level – Limit value
4. The other emission levels were very low against the limit of frequency range 30 MHz ~ 1 GHz.
5. The emission levels were very low against the limit of frequency range 9 kHz ~ 30 MHz: the amplitude of spurious emissions attenuated more than 20 dB below the permissible value to be report.

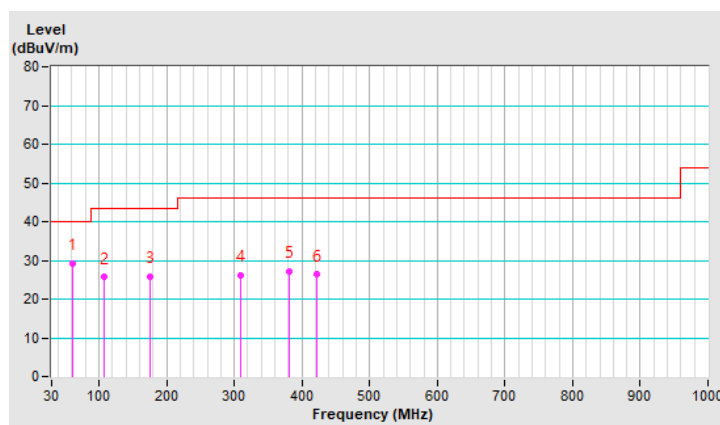

7.7 Unwanted Emissions above 1 GHz

RF Mode	802.11b	Channel	CH 1 : 2412 MHz
Frequency Range	1 GHz ~ 25 GHz	Detector Function & Bandwidth	(PK) RB = 1 MHz, VB = 3 MHz (AV) RB = 1 MHz, VB = 10 Hz
Input Power	120 Vac, 60 Hz	Environmental Conditions	16°C, 59.6% RH
Tested By	Jed Wu		

Antenna Polarity & Test Distance : Horizontal at 3 m								
No	Frequency (MHz)	Emission Level (dBuV/m)	Limit (dBuV/m)	Margin (dB)	Antenna Height (m)	Table Angle (Degree)	Raw Value (dBuV)	Correction Factor (dB/m)
1	2390.00	54.0 PK	74.0	-20.0	1.51 H	43	51.7	2.3
2	2390.00	44.1 AV	54.0	-9.9	1.51 H	43	41.8	2.3
3	*2412.00	106.4 PK			1.51 H	43	103.9	2.5
4	*2412.00	101.8 AV			1.51 H	43	99.3	2.5
5	4824.00	57.7 PK	74.0	-16.3	2.83 H	83	44.4	13.3
6	4824.00	51.2 AV	54.0	-2.8	2.83 H	83	37.9	13.3
7	#7236.00	60.1 PK			1.06 H	214	40.8	19.3
8	#7236.00	48.3 AV			1.06 H	214	29.0	19.3

Antenna Polarity & Test Distance : Vertical at 3 m								
No	Frequency (MHz)	Emission Level (dBuV/m)	Limit (dBuV/m)	Margin (dB)	Antenna Height (m)	Table Angle (Degree)	Raw Value (dBuV)	Correction Factor (dB/m)
1	2390.00	53.0 PK	74.0	-21.0	3.12 V	127	50.7	2.3
2	2390.00	39.7 AV	54.0	-14.3	3.12 V	127	37.4	2.3
3	*2412.00	100.4 PK			3.12 V	127	97.9	2.5
4	*2412.00	95.8 AV			3.12 V	127	93.3	2.5
5	4824.00	56.6 PK	74.0	-17.4	2.91 V	197	43.3	13.3
6	4824.00	48.7 AV	54.0	-5.3	2.91 V	197	35.4	13.3
7	#7236.00	62.0 PK			1.50 V	247	42.7	19.3
8	#7236.00	53.3 AV			1.50 V	247	34.0	19.3

Remarks:

1. Emission Level(dBuV/m) = Raw Value(dBuV) + Correction Factor(dB/m)
2. Correction Factor(dB/m) = Antenna Factor(dB/m) + Cable Factor(dB) – Pre-Amplifier Factor(dB)
3. Margin value = Emission Level – Limit value
4. The other emission levels were very low against the limit.
5. " * ": Fundamental frequency, the limit was restricted at the RF Output Power.
6. " # ": The radiated frequency is out of the restricted band, the limit was restricted at the Conducted Out of Band Emissions.



RF Mode	802.11b	Channel	CH 6 : 2437 MHz
Frequency Range	1 GHz ~ 25 GHz	Detector Function & Bandwidth	(PK) RB = 1 MHz, VB = 3 MHz (AV) RB = 1 MHz, VB = 10 Hz
Input Power	120 Vac, 60 Hz	Environmental Conditions	16°C, 59.6% RH
Tested By	Jed Wu		

Antenna Polarity & Test Distance : Horizontal at 3 m

No	Frequency (MHz)	Emission Level (dBuV/m)	Limit (dBuV/m)	Margin (dB)	Antenna Height (m)	Table Angle (Degree)	Raw Value (dBuV)	Correction Factor (dB/m)
1	*2437.00	110.1 PK			1.33 H	45	107.5	2.6
2	*2437.00	105.5 AV			1.33 H	45	102.9	2.6
3	4874.00	57.7 PK	74.0	-16.3	3.28 H	182	44.1	13.6
4	4874.00	50.6 AV	54.0	-3.4	3.28 H	182	37.0	13.6
5	7311.00	59.8 PK	74.0	-14.2	1.45 H	213	40.0	19.8
6	7311.00	47.5 AV	54.0	-6.5	1.45 H	213	27.7	19.8

Antenna Polarity & Test Distance : Vertical at 3 m

No	Frequency (MHz)	Emission Level (dBuV/m)	Limit (dBuV/m)	Margin (dB)	Antenna Height (m)	Table Angle (Degree)	Raw Value (dBuV)	Correction Factor (dB/m)
1	*2437.00	104.1 PK			2.94 V	125	101.5	2.6
2	*2437.00	99.5 AV			2.94 V	125	96.9	2.6
3	4874.00	56.6 PK	74.0	-17.4	2.46 V	296	43.0	13.6
4	4874.00	48.1 AV	54.0	-5.9	2.46 V	296	34.5	13.6
5	7311.00	61.7 PK	74.0	-12.3	1.11 V	246	41.9	19.8
6	7311.00	52.5 AV	54.0	-1.5	1.11 V	246	32.7	19.8

Remarks:

1. Emission Level(dBuV/m) = Raw Value(dBuV) + Correction Factor(dB/m)
2. Correction Factor(dB/m) = Antenna Factor(dB/m) + Cable Factor(dB) – Pre-Amplifier Factor(dB)
3. Margin value = Emission Level – Limit value
4. The other emission levels were very low against the limit.
5. " * ": Fundamental frequency, the limit was restricted at the RF Output Power.



RF Mode	802.11b	Channel	CH 11 : 2462 MHz
Frequency Range	1 GHz ~ 25 GHz	Detector Function & Bandwidth	(PK) RB = 1 MHz, VB = 3 MHz (AV) RB = 1 MHz, VB = 10 Hz
Input Power	120 Vac, 60 Hz	Environmental Conditions	16°C, 59.6% RH
Tested By	Jed Wu		

Antenna Polarity & Test Distance : Horizontal at 3 m

No	Frequency (MHz)	Emission Level (dBuV/m)	Limit (dBuV/m)	Margin (dB)	Antenna Height (m)	Table Angle (Degree)	Raw Value (dBuV)	Correction Factor (dB/m)
1	*2462.00	112.1 PK			1.31 H	44	109.4	2.7
2	*2462.00	107.6 AV			1.31 H	44	104.9	2.7
3	2483.50	67.5 PK	74.0	-6.5	1.31 H	44	64.8	2.7
4	2483.50	52.9 AV	54.0	-1.1	1.31 H	44	50.2	2.7
5	4924.00	58.1 PK	74.0	-15.9	2.79 H	189	44.4	13.7
6	4924.00	50.5 AV	54.0	-3.5	2.79 H	189	36.8	13.7
7	7386.00	59.7 PK	74.0	-14.3	1.46 H	238	39.7	20.0
8	7386.00	47.3 AV	54.0	-6.7	1.46 H	238	27.3	20.0

Antenna Polarity & Test Distance : Vertical at 3 m

No	Frequency (MHz)	Emission Level (dBuV/m)	Limit (dBuV/m)	Margin (dB)	Antenna Height (m)	Table Angle (Degree)	Raw Value (dBuV)	Correction Factor (dB/m)
1	*2462.00	106.1 PK			2.91 V	128	103.4	2.7
2	*2462.00	101.6 AV			2.91 V	128	98.9	2.7
3	2483.50	61.8 PK	74.0	-12.2	2.91 V	128	59.1	2.7
4	2483.50	46.3 AV	54.0	-7.7	2.91 V	128	43.6	2.7
5	4924.00	56.9 PK	74.0	-17.1	2.87 V	303	43.2	13.7
6	4924.00	48.0 AV	54.0	-6.0	2.87 V	303	34.3	13.7
7	7386.00	61.6 PK	74.0	-12.4	1.10 V	271	41.6	20.0
8	7386.00	52.3 AV	54.0	-1.7	1.10 V	271	32.3	20.0

Remarks:

1. Emission Level(dBuV/m) = Raw Value(dBuV) + Correction Factor(dB/m)
2. Correction Factor(dB/m) = Antenna Factor(dB/m) + Cable Factor(dB) – Pre-Amplifier Factor(dB)
3. Margin value = Emission Level – Limit value
4. The other emission levels were very low against the limit.
5. " * ": Fundamental frequency, the limit was restricted at the RF Output Power.

RF Mode	802.11g	Channel	CH 1 : 2412 MHz
Frequency Range	1 GHz ~ 25 GHz	Detector Function & Bandwidth	(PK) RB = 1 MHz, VB = 3 MHz (AV) RB = 1 MHz, VB = 510 Hz
Input Power	120 Vac, 60 Hz	Environmental Conditions	16°C, 59.6% RH
Tested By	Jed Wu		

Antenna Polarity & Test Distance : Horizontal at 3 m

No	Frequency (MHz)	Emission Level (dBuV/m)	Limit (dBuV/m)	Margin (dB)	Antenna Height (m)	Table Angle (Degree)	Raw Value (dBuV)	Correction Factor (dB/m)
1	2390.00	68.6 PK	74.0	-5.4	1.34 H	46	66.3	2.3
2	2390.00	49.7 AV	54.0	-4.3	1.34 H	46	47.4	2.3
3	*2412.00	107.4 PK			1.34 H	46	104.9	2.5
4	*2412.00	96.6 AV			1.34 H	46	94.1	2.5
5	4824.00	54.4 PK	74.0	-19.6	2.66 H	80	41.1	13.3
6	4824.00	41.5 AV	54.0	-12.5	2.66 H	80	28.2	13.3
7	#7236.00	61.5 PK			1.55 H	210	42.2	19.3
8	#7236.00	43.9 AV			1.55 H	210	24.6	19.3

Antenna Polarity & Test Distance : Vertical at 3 m

No	Frequency (MHz)	Emission Level (dBuV/m)	Limit (dBuV/m)	Margin (dB)	Antenna Height (m)	Table Angle (Degree)	Raw Value (dBuV)	Correction Factor (dB/m)
1	2390.00	61.5 PK	74.0	-12.5	2.95 V	130	59.2	2.3
2	2390.00	43.2 AV	54.0	-10.8	2.95 V	130	40.9	2.3
3	*2412.00	101.6 PK			2.95 V	130	99.1	2.5
4	*2412.00	91.2 AV			2.95 V	130	88.7	2.5
5	4824.00	53.3 PK	74.0	-20.7	2.74 V	194	40.0	13.3
6	4824.00	39.0 AV	54.0	-15.0	2.74 V	194	25.7	13.3
7	#7236.00	63.4 PK			1.01 V	243	44.1	19.3
8	#7236.00	48.9 AV			1.01 V	243	29.6	19.3

Remarks:

1. Emission Level(dBuV/m) = Raw Value(dBuV) + Correction Factor(dB/m)
2. Correction Factor(dB/m) = Antenna Factor(dB/m) + Cable Factor(dB) – Pre-Amplifier Factor(dB)
3. Margin value = Emission Level – Limit value
4. The other emission levels were very low against the limit.
5. " * ": Fundamental frequency, the limit was restricted at the RF Output Power.
6. " # ": The radiated frequency is out of the restricted band, the limit was restricted at the Conducted Out of Band Emissions.



RF Mode	802.11g	Channel	CH 6 : 2437 MHz
Frequency Range	1 GHz ~ 25 GHz	Detector Function & Bandwidth	(PK) RB = 1 MHz, VB = 3 MHz (AV) RB = 1 MHz, VB = 510 Hz
Input Power	120 Vac, 60 Hz	Environmental Conditions	16°C, 59.6% RH
Tested By	Jed Wu		

Antenna Polarity & Test Distance : Horizontal at 3 m

No	Frequency (MHz)	Emission Level (dBuV/m)	Limit (dBuV/m)	Margin (dB)	Antenna Height (m)	Table Angle (Degree)	Raw Value (dBuV)	Correction Factor (dB/m)
1	*2437.00	111.7 PK			1.32 H	45	109.1	2.6
2	*2437.00	101.2 AV			1.32 H	45	98.6	2.6
3	4874.00	55.1 PK	74.0	-18.9	2.68 H	81	41.5	13.6
4	4874.00	42.2 AV	54.0	-11.8	2.68 H	81	28.6	13.6
5	7311.00	61.1 PK	74.0	-12.9	1.56 H	197	41.3	19.8
6	7311.00	43.5 AV	54.0	-10.5	1.56 H	197	23.7	19.8

Antenna Polarity & Test Distance : Vertical at 3 m

No	Frequency (MHz)	Emission Level (dBuV/m)	Limit (dBuV/m)	Margin (dB)	Antenna Height (m)	Table Angle (Degree)	Raw Value (dBuV)	Correction Factor (dB/m)
1	*2437.00	105.7 PK			2.93 V	129	103.1	2.6
2	*2437.00	95.2 AV			2.93 V	129	92.6	2.6
3	4874.00	54.0 PK	74.0	-20.0	2.76 V	195	40.4	13.6
4	4874.00	39.7 AV	54.0	-14.3	2.76 V	195	26.1	13.6
5	7311.00	63.0 PK	74.0	-11.0	1.01 V	256	43.2	19.8
6	7311.00	48.5 AV	54.0	-5.5	1.01 V	256	28.7	19.8

Remarks:

1. Emission Level(dBuV/m) = Raw Value(dBuV) + Correction Factor(dB/m)
2. Correction Factor(dB/m) = Antenna Factor(dB/m) + Cable Factor(dB) – Pre-Amplifier Factor(dB)
3. Margin value = Emission Level – Limit value
4. The other emission levels were very low against the limit.
5. " * ": Fundamental frequency, the limit was restricted at the RF Output Power.



RF Mode	802.11g	Channel	CH 11 : 2462 MHz
Frequency Range	1 GHz ~ 25 GHz	Detector Function & Bandwidth	(PK) RB = 1 MHz, VB = 3 MHz (AV) RB = 1 MHz, VB = 510 Hz
Input Power	120 Vac, 60 Hz	Environmental Conditions	16°C, 59.6% RH
Tested By	Jed Wu		

Antenna Polarity & Test Distance : Horizontal at 3 m

No	Frequency (MHz)	Emission Level (dBuV/m)	Limit (dBuV/m)	Margin (dB)	Antenna Height (m)	Table Angle (Degree)	Raw Value (dBuV)	Correction Factor (dB/m)
1	*2462.00	110.1 PK			1.31 H	46	107.4	2.7
2	*2462.00	99.1 AV			1.31 H	46	96.4	2.7
3	2483.50	72.2 PK	74.0	-1.8	1.31 H	46	69.5	2.7
4	2483.50	50.1 AV	54.0	-3.9	1.31 H	46	47.4	2.7
5	4924.00	54.7 PK	74.0	-19.3	2.69 H	82	41.0	13.7
6	4924.00	41.8 AV	54.0	-12.2	2.69 H	82	28.1	13.7
7	7386.00	59.9 PK	74.0	-14.1	1.56 H	237	39.9	20.0
8	7386.00	43.5 AV	54.0	-10.5	1.56 H	237	23.5	20.0

Antenna Polarity & Test Distance : Vertical at 3 m

No	Frequency (MHz)	Emission Level (dBuV/m)	Limit (dBuV/m)	Margin (dB)	Antenna Height (m)	Table Angle (Degree)	Raw Value (dBuV)	Correction Factor (dB/m)
1	*2462.00	104.1 PK			2.93 V	124	101.4	2.7
2	*2462.00	94.2 AV			2.93 V	124	91.5	2.7
3	2483.50	66.9 PK	74.0	-7.1	2.93 V	124	64.2	2.7
4	2483.50	46.5 AV	54.0	-7.5	2.93 V	124	43.8	2.7
5	4924.00	52.7 PK	74.0	-21.3	2.77 V	198	39.9	12.8
6	4924.00	38.4 AV	54.0	-15.6	2.77 V	198	25.6	12.8
7	7386.00	62.4 PK	74.0	-11.6	1.00 V	270	43.6	18.8
8	7386.00	47.3 AV	54.0	-6.7	1.00 V	270	28.5	18.8

Remarks:

1. Emission Level(dBuV/m) = Raw Value(dBuV) + Correction Factor(dB/m)
2. Correction Factor(dB/m) = Antenna Factor(dB/m) + Cable Factor(dB) – Pre-Amplifier Factor(dB)
3. Margin value = Emission Level – Limit value
4. The other emission levels were very low against the limit.
5. " * ": Fundamental frequency, the limit was restricted at the RF Output Power.

RF Mode	802.11n (HT20)	Channel	CH 1 : 2412 MHz
Frequency Range	1 GHz ~ 25 GHz	Detector Function & Bandwidth	(PK) RB = 1 MHz, VB = 3 MHz (AV) RB = 1 MHz, VB = 1 kHz
Input Power	120 Vac, 60 Hz	Environmental Conditions	16°C, 59.6% RH
Tested By	Jed Wu		

Antenna Polarity & Test Distance : Horizontal at 3 m

No	Frequency (MHz)	Emission Level (dBuV/m)	Limit (dBuV/m)	Margin (dB)	Antenna Height (m)	Table Angle (Degree)	Raw Value (dBuV)	Correction Factor (dB/m)
1	2390.00	71.7 PK	74.0	-2.3	1.33 H	45	69.4	2.3
2	2390.00	52.6 AV	54.0	-1.4	1.33 H	45	50.3	2.3
3	*2412.00	106.7 PK			1.33 H	45	104.2	2.5
4	*2412.00	96.9 AV			1.33 H	45	94.4	2.5
5	4824.00	54.1 PK	74.0	-19.9	2.67 H	83	40.8	13.3
6	4824.00	41.2 AV	54.0	-12.8	2.67 H	83	27.9	13.3
7	#7236.00	62.2 PK			1.54 H	213	42.9	19.3
8	#7236.00	43.8 AV			1.54 H	213	24.5	19.3

Antenna Polarity & Test Distance : Vertical at 3 m

No	Frequency (MHz)	Emission Level (dBuV/m)	Limit (dBuV/m)	Margin (dB)	Antenna Height (m)	Table Angle (Degree)	Raw Value (dBuV)	Correction Factor (dB/m)
1	2390.00	64.7 PK	74.0	-9.3	2.94 V	129	62.4	2.3
2	2390.00	46.2 AV	54.0	-7.8	2.94 V	129	43.9	2.3
3	*2412.00	100.7 PK			2.94 V	129	98.2	2.5
4	*2412.00	91.0 AV			2.94 V	129	88.5	2.5
5	4824.00	53.0 PK	74.0	-21.0	2.75 V	196	39.7	13.3
6	4824.00	38.7 AV	54.0	-15.3	2.75 V	196	25.4	13.3
7	#7236.00	64.1 PK			1.02 V	246	44.8	19.3
8	#7236.00	48.8 AV			1.02 V	246	29.5	19.3

Remarks:

1. Emission Level(dBuV/m) = Raw Value(dBuV) + Correction Factor(dB/m)
2. Correction Factor(dB/m) = Antenna Factor(dB/m) + Cable Factor(dB) – Pre-Amplifier Factor(dB)
3. Margin value = Emission Level – Limit value
4. The other emission levels were very low against the limit.
5. " * " : Fundamental frequency, the limit was restricted at the RF Output Power.
6. " # " : The radiated frequency is out of the restricted band, the limit was restricted at the Conducted Out of Band Emissions.



RF Mode	802.11n (HT20)	Channel	CH 6 : 2437 MHz
Frequency Range	1 GHz ~ 25 GHz	Detector Function & Bandwidth	(PK) RB = 1 MHz, VB = 3 MHz (AV) RB = 1 MHz, VB = 1 kHz
Input Power	120 Vac, 60 Hz	Environmental Conditions	16°C, 59.6% RH
Tested By	Jed Wu		

Antenna Polarity & Test Distance : Horizontal at 3 m

No	Frequency (MHz)	Emission Level (dBuV/m)	Limit (dBuV/m)	Margin (dB)	Antenna Height (m)	Table Angle (Degree)	Raw Value (dBuV)	Correction Factor (dB/m)
1	*2437.00	110.9 PK			1.33 H	46	108.3	2.6
2	*2437.00	101.2 AV			1.33 H	46	98.6	2.6
3	4874.00	54.5 PK	74.0	-19.5	2.66 H	82	40.9	13.6
4	4874.00	41.6 AV	54.0	-12.4	2.66 H	82	28.0	13.6
5	7311.00	62.5 PK	74.0	-11.5	1.55 H	212	42.7	19.8
6	7311.00	44.1 AV	54.0	-9.9	1.55 H	212	24.3	19.8

Antenna Polarity & Test Distance : Vertical at 3 m

No	Frequency (MHz)	Emission Level (dBuV/m)	Limit (dBuV/m)	Margin (dB)	Antenna Height (m)	Table Angle (Degree)	Raw Value (dBuV)	Correction Factor (dB/m)
1	*2437.00	104.9 PK			2.94 V	124	102.3	2.6
2	*2437.00	95.2 AV			2.94 V	124	92.6	2.6
3	4874.00	53.4 PK	74.0	-20.6	2.73 V	200	39.8	13.6
4	4874.00	39.1 AV	54.0	-14.9	2.73 V	200	25.5	13.6
5	7311.00	64.4 PK	74.0	-9.6	1.01 V	245	44.6	19.8
6	7311.00	49.1 AV	54.0	-4.9	1.01 V	245	29.3	19.8

Remarks:

1. Emission Level(dBuV/m) = Raw Value(dBuV) + Correction Factor(dB/m)
2. Correction Factor(dB/m) = Antenna Factor(dB/m) + Cable Factor(dB) – Pre-Amplifier Factor(dB)
3. Margin value = Emission Level – Limit value
4. The other emission levels were very low against the limit.
5. " * ": Fundamental frequency, the limit was restricted at the RF Output Power.



RF Mode	802.11n (HT20)	Channel	CH 11 : 2462 MHz
Frequency Range	1 GHz ~ 25 GHz	Detector Function & Bandwidth	(PK) RB = 1 MHz, VB = 3 MHz (AV) RB = 1 MHz, VB = 1 kHz
Input Power	120 Vac, 60 Hz	Environmental Conditions	16°C, 59.6% RH
Tested By	Jed Wu		

Antenna Polarity & Test Distance : Horizontal at 3 m								
No	Frequency (MHz)	Emission Level (dBuV/m)	Limit (dBuV/m)	Margin (dB)	Antenna Height (m)	Table Angle (Degree)	Raw Value (dBuV)	Correction Factor (dB/m)
1	*2462.00	108.8 PK			1.16 H	43	106.1	2.7
2	*2462.00	98.9 AV			1.16 H	43	96.2	2.7
3	2483.50	73.5 PK	74.0	-0.5	1.16 H	43	70.8	2.7
4	2483.50	51.0 AV	54.0	-3.0	1.16 H	43	48.3	2.7
5	4924.00	54.8 PK	74.0	-19.2	2.49 H	79	41.1	13.7
6	4924.00	41.9 AV	54.0	-12.1	2.49 H	79	28.2	13.7
7	7386.00	62.4 PK	74.0	-11.6	1.38 H	215	42.4	20.0
8	7386.00	44.0 AV	54.0	-10.0	1.38 H	215	24.0	20.0

Antenna Polarity & Test Distance : Vertical at 3 m								
No	Frequency (MHz)	Emission Level (dBuV/m)	Limit (dBuV/m)	Margin (dB)	Antenna Height (m)	Table Angle (Degree)	Raw Value (dBuV)	Correction Factor (dB/m)
1	*2462.00	102.8 PK			2.77 V	127	100.1	2.7
2	*2462.00	93.2 AV			2.77 V	127	90.5	2.7
3	2483.50	66.5 PK	74.0	-7.5	2.77 V	127	63.8	2.7
4	2483.50	45.0 AV	54.0	-9.0	2.77 V	127	42.3	2.7
5	4924.00	53.7 PK	74.0	-20.3	2.56 V	198	40.0	13.7
6	4924.00	39.4 AV	54.0	-14.6	2.56 V	198	25.7	13.7
7	7386.00	64.3 PK	74.0	-9.7	1.18 V	248	44.3	20.0
8	7386.00	49.0 AV	54.0	-5.0	1.18 V	248	29.0	20.0

Remarks:

1. Emission Level(dBuV/m) = Raw Value(dBuV) + Correction Factor(dB/m)
2. Correction Factor(dB/m) = Antenna Factor(dB/m) + Cable Factor(dB) – Pre-Amplifier Factor(dB)
3. Margin value = Emission Level – Limit value
4. The other emission levels were very low against the limit.
5. " * " : Fundamental frequency, the limit was restricted at the RF Output Power.



RF Mode	802.11n (HT40)	Channel	CH 3 : 2422 MHz
Frequency Range	1 GHz ~ 25 GHz	Detector Function & Bandwidth	(PK) RB = 1 MHz, VB = 3 MHz (AV) RB = 1 MHz, VB = 2 kHz
Input Power	120 Vac, 60 Hz	Environmental Conditions	16°C, 59.6% RH
Tested By	Jed Wu		

Antenna Polarity & Test Distance : Horizontal at 3 m

No	Frequency (MHz)	Emission Level (dBuV/m)	Limit (dBuV/m)	Margin (dB)	Antenna Height (m)	Table Angle (Degree)	Raw Value (dBuV)	Correction Factor (dB/m)
1	2390.00	71.3 PK	74.0	-2.7	1.17 H	52	69.0	2.3
2	2390.00	52.4 AV	54.0	-1.6	1.17 H	52	50.1	2.3
3	*2422.00	105.7 PK			1.17 H	52	103.2	2.5
4	*2422.00	95.6 AV			1.17 H	52	93.1	2.5
5	4844.00	54.8 PK	74.0	-19.2	2.48 H	70	41.3	13.5
6	4844.00	41.9 AV	54.0	-12.1	2.48 H	70	28.4	13.5
7	7266.00	62.1 PK	74.0	-11.9	1.37 H	206	42.6	19.5
8	7266.00	43.7 AV	54.0	-10.3	1.37 H	206	24.2	19.5

Antenna Polarity & Test Distance : Vertical at 3 m

No	Frequency (MHz)	Emission Level (dBuV/m)	Limit (dBuV/m)	Margin (dB)	Antenna Height (m)	Table Angle (Degree)	Raw Value (dBuV)	Correction Factor (dB/m)
1	2390.00	63.3 PK	74.0	-10.7	2.78 V	118	61.0	2.3
2	2390.00	45.2 AV	54.0	-8.8	2.78 V	118	42.9	2.3
3	*2422.00	99.8 PK			2.78 V	118	97.3	2.5
4	*2422.00	89.9 AV			2.78 V	118	87.4	2.5
5	4844.00	53.7 PK	74.0	-20.3	2.55 V	189	40.2	13.5
6	4844.00	39.4 AV	54.0	-14.6	2.55 V	189	25.9	13.5
7	7266.00	64.0 PK	74.0	-10.0	1.17 V	257	44.5	19.5
8	7266.00	48.7 AV	54.0	-5.3	1.17 V	257	29.2	19.5

Remarks:

1. Emission Level(dBuV/m) = Raw Value(dBuV) + Correction Factor(dB/m)
2. Correction Factor(dB/m) = Antenna Factor(dB/m) + Cable Factor(dB) – Pre-Amplifier Factor(dB)
3. Margin value = Emission Level – Limit value
4. The other emission levels were very low against the limit.
5. " * " : Fundamental frequency, the limit was restricted at the RF Output Power.



RF Mode	802.11n (HT40)	Channel	CH 6 : 2437 MHz
Frequency Range	1 GHz ~ 25 GHz	Detector Function & Bandwidth	(PK) RB = 1 MHz, VB = 3 MHz (AV) RB = 1 MHz, VB = 2 kHz
Input Power	120 Vac, 60 Hz	Environmental Conditions	16°C, 59.6% RH
Tested By	Jed Wu		

Antenna Polarity & Test Distance : Horizontal at 3 m

No	Frequency (MHz)	Emission Level (dBuV/m)	Limit (dBuV/m)	Margin (dB)	Antenna Height (m)	Table Angle (Degree)	Raw Value (dBuV)	Correction Factor (dB/m)
1	*2437.00	105.9 PK			1.32 H	50	103.3	2.6
2	*2437.00	96.3 AV			1.32 H	50	93.7	2.6
3	2483.50	72.1 PK	74.0	-1.9	1.32 H	50	69.4	2.7
4	2483.50	53.2 AV	54.0	-0.8	1.32 H	50	50.5	2.7
5	4874.00	55.0 PK	74.0	-19.0	2.33 H	72	41.4	13.6
6	4874.00	42.1 AV	54.0	-11.9	2.33 H	72	28.5	13.6
7	7311.00	62.5 PK	74.0	-11.5	1.22 H	208	42.7	19.8
8	7311.00	44.1 AV	54.0	-9.9	1.22 H	208	24.3	19.8

Antenna Polarity & Test Distance : Vertical at 3 m

No	Frequency (MHz)	Emission Level (dBuV/m)	Limit (dBuV/m)	Margin (dB)	Antenna Height (m)	Table Angle (Degree)	Raw Value (dBuV)	Correction Factor (dB/m)
1	*2437.00	99.9 PK			2.92 V	134	97.3	2.6
2	*2437.00	90.4 AV			2.92 V	134	87.8	2.6
3	2483.50	68.5 PK	74.0	-5.5	2.92 V	134	65.8	2.7
4	2483.50	49.2 AV	54.0	-4.8	2.92 V	134	46.5	2.7
5	4874.00	53.7 PK	74.0	-20.3	2.41 V	173	40.1	13.6
6	4874.00	39.4 AV	54.0	-14.6	2.41 V	173	25.8	13.6
7	7311.00	64.2 PK	74.0	-9.8	1.03 V	241	44.4	19.8
8	7311.00	48.9 AV	54.0	-5.1	1.03 V	241	29.1	19.8

Remarks:

1. Emission Level(dBuV/m) = Raw Value(dBuV) + Correction Factor(dB/m)
2. Correction Factor(dB/m) = Antenna Factor(dB/m) + Cable Factor(dB) – Pre-Amplifier Factor(dB)
3. Margin value = Emission Level – Limit value
4. The other emission levels were very low against the limit.
5. " * " : Fundamental frequency, the limit was restricted at the RF Output Power.



RF Mode	802.11n (HT40)	Channel	CH 9 : 2452 MHz
Frequency Range	1 GHz ~ 25 GHz	Detector Function & Bandwidth	(PK) RB = 1 MHz, VB = 3 MHz (AV) RB = 1 MHz, VB = 2 kHz
Input Power	120 Vac, 60 Hz	Environmental Conditions	16°C, 59.6% RH
Tested By	Jed Wu		

Antenna Polarity & Test Distance : Horizontal at 3 m

No	Frequency (MHz)	Emission Level (dBuV/m)	Limit (dBuV/m)	Margin (dB)	Antenna Height (m)	Table Angle (Degree)	Raw Value (dBuV)	Correction Factor (dB/m)
1	*2452.00	104.7 PK			1.31 H	45	102.0	2.7
2	*2452.00	95.5 AV			1.31 H	45	92.8	2.7
3	2483.50	72.5 PK	74.0	-1.5	1.31 H	45	69.8	2.7
4	2483.50	52.2 AV	54.0	-1.8	1.31 H	45	49.5	2.7
5	4904.00	54.7 PK	74.0	-19.3	2.34 H	77	41.0	13.7
6	4904.00	41.8 AV	54.0	-12.2	2.34 H	77	28.1	13.7
7	7356.00	62.3 PK	74.0	-11.7	1.21 H	203	42.3	20.0
8	7356.00	43.9 AV	54.0	-10.1	1.21 H	203	23.9	20.0

Antenna Polarity & Test Distance : Vertical at 3 m

No	Frequency (MHz)	Emission Level (dBuV/m)	Limit (dBuV/m)	Margin (dB)	Antenna Height (m)	Table Angle (Degree)	Raw Value (dBuV)	Correction Factor (dB/m)
1	*2452.00	99.0 PK			2.91 V	124	96.3	2.7
2	*2452.00	89.6 AV			2.91 V	124	86.9	2.7
3	2483.50	67.2 PK	74.0	-6.8	2.91 V	124	64.5	2.7
4	2483.50	47.0 AV	54.0	-7.0	2.91 V	124	44.3	2.7
5	4904.00	53.4 PK	74.0	-20.6	2.40 V	183	39.7	13.7
6	4904.00	39.1 AV	54.0	-14.9	2.40 V	183	25.4	13.7
7	7356.00	64.0 PK	74.0	-10.0	1.04 V	231	44.0	20.0
8	7356.00	48.7 AV	54.0	-5.3	1.04 V	231	28.7	20.0

Remarks:

1. Emission Level(dBuV/m) = Raw Value(dBuV) + Correction Factor(dB/m)
2. Correction Factor(dB/m) = Antenna Factor(dB/m) + Cable Factor(dB) – Pre-Amplifier Factor(dB)
3. Margin value = Emission Level – Limit value
4. The other emission levels were very low against the limit.
5. " * " : Fundamental frequency, the limit was restricted at the RF Output Power.

Plot of Band Edge

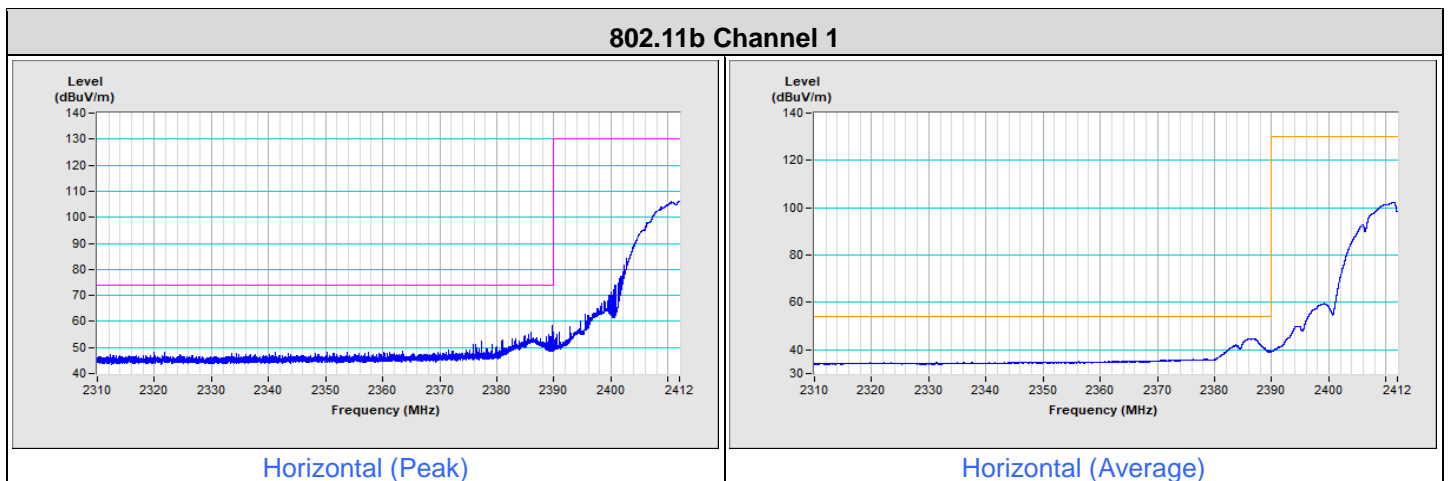

802.11b Channel 1

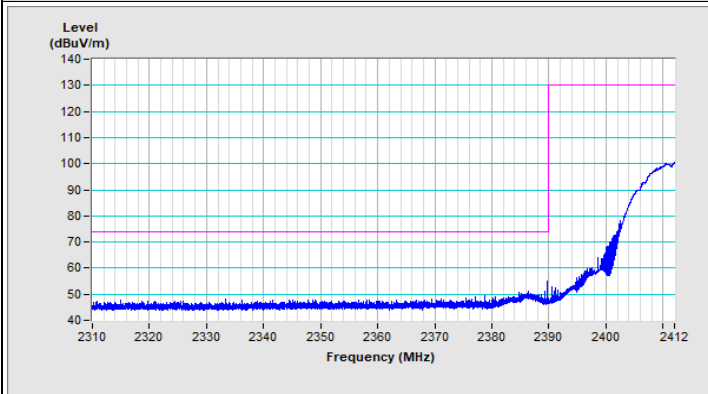

Vertical (Peak)

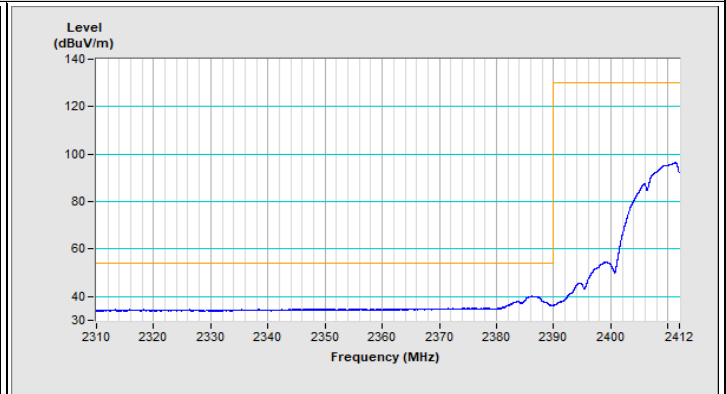

Vertical (Average)

802.11b Channel 11

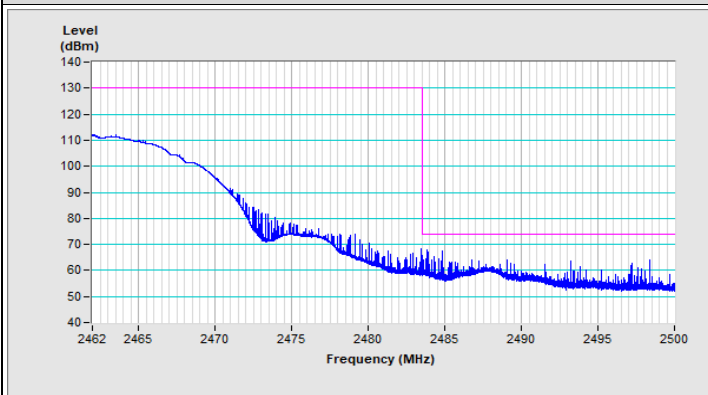

Horizontal (Peak)

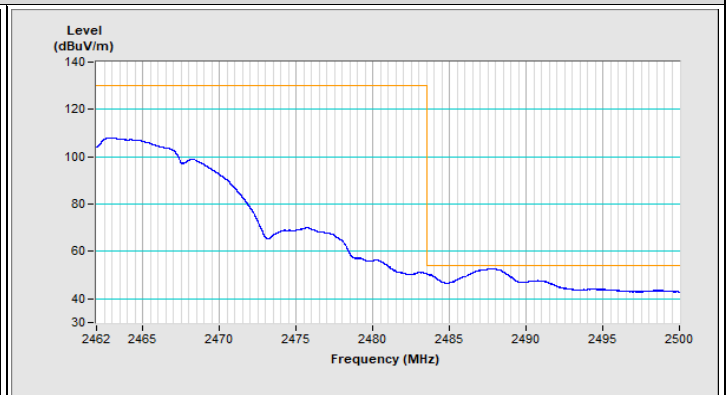

Horizontal (Average)

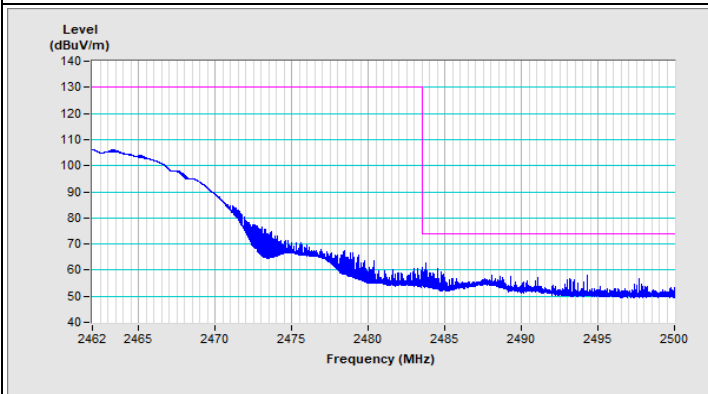

Vertical (Peak)

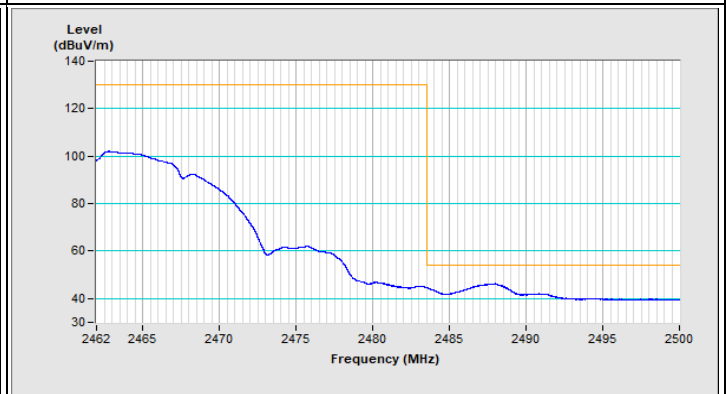

Vertical (Average)

802.11g Channel 1

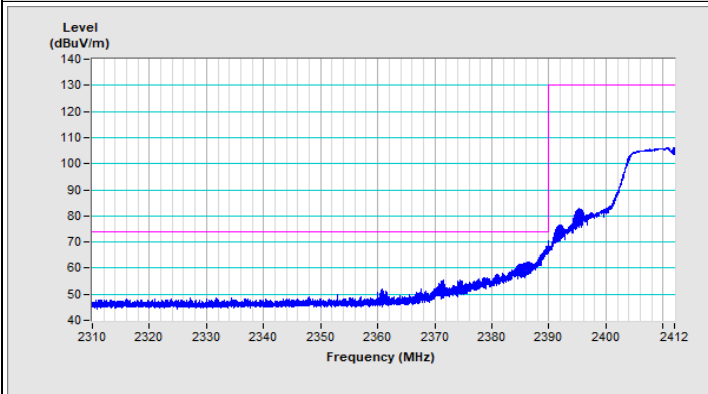

Horizontal (Peak)

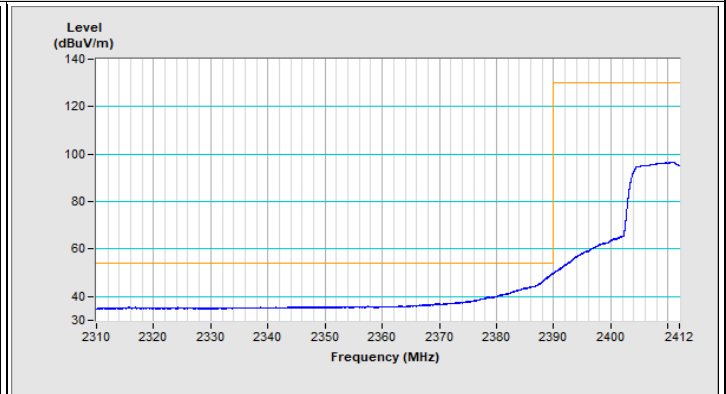

Horizontal (Average)

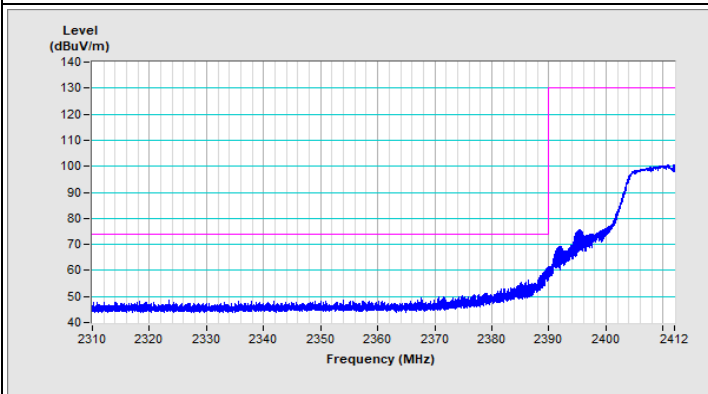

Vertical (Peak)

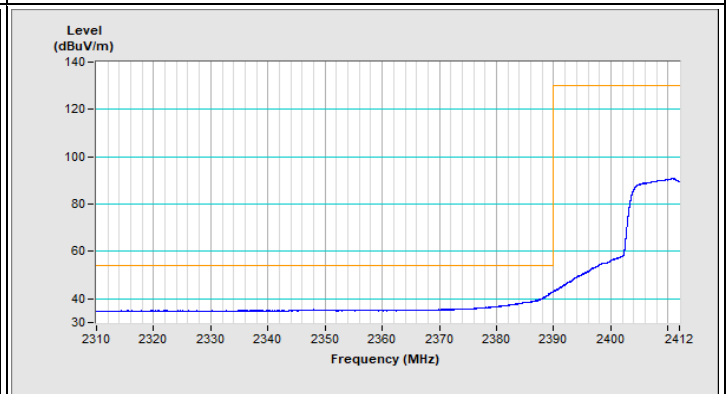

Vertical (Average)

802.11g Channel 11

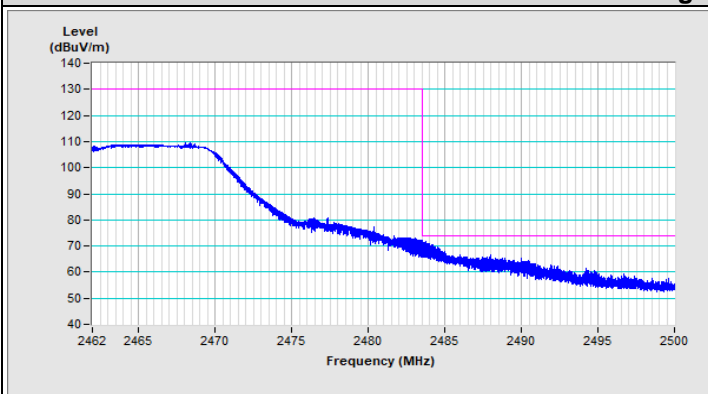

Horizontal (Peak)

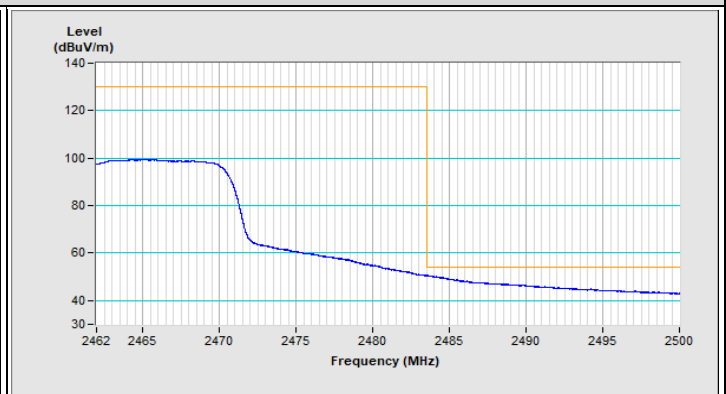

Horizontal (Average)

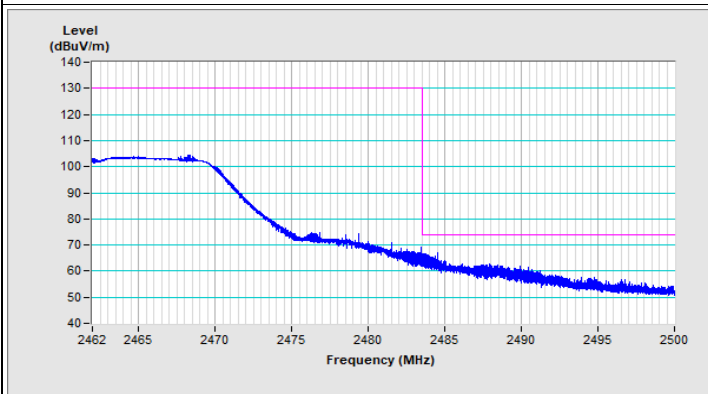

Vertical (Peak)

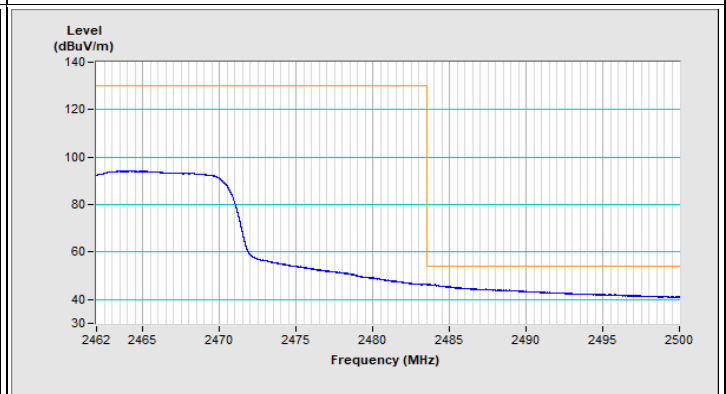

Vertical (Average)

802.11n (HT20) Channel 1

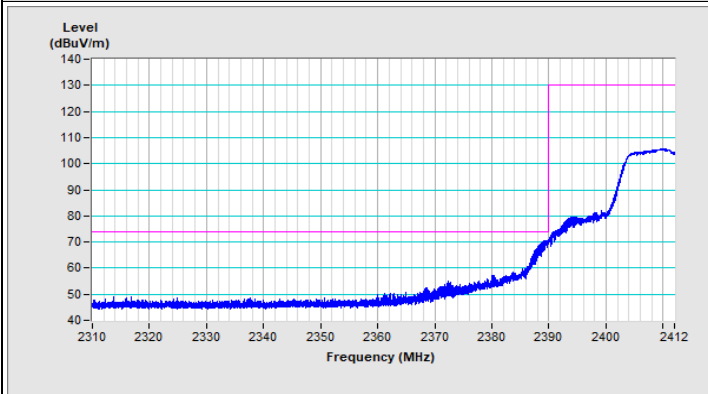

Horizontal (Peak)

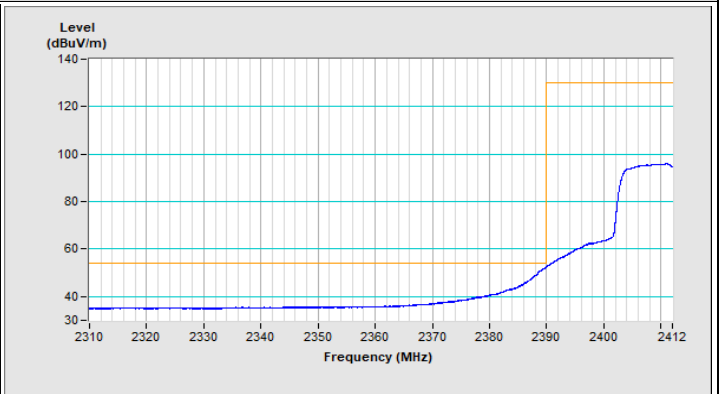

Horizontal (Average)

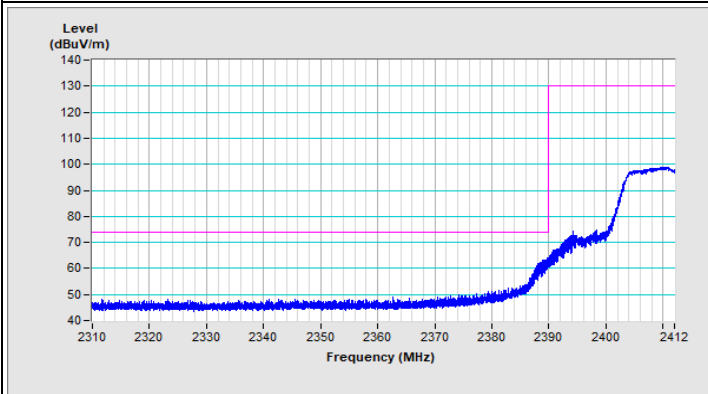

Vertical (Peak)

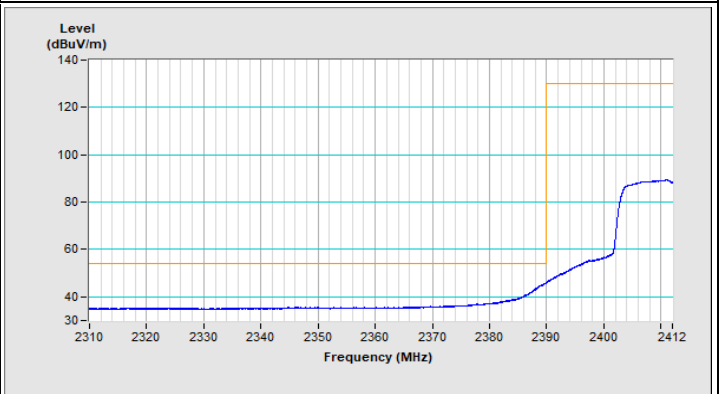

Vertical (Average)

802.11n (HT20) Channel 11

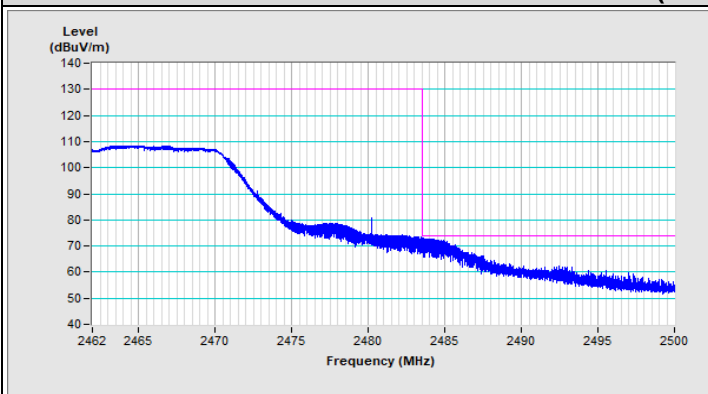

Horizontal (Peak)

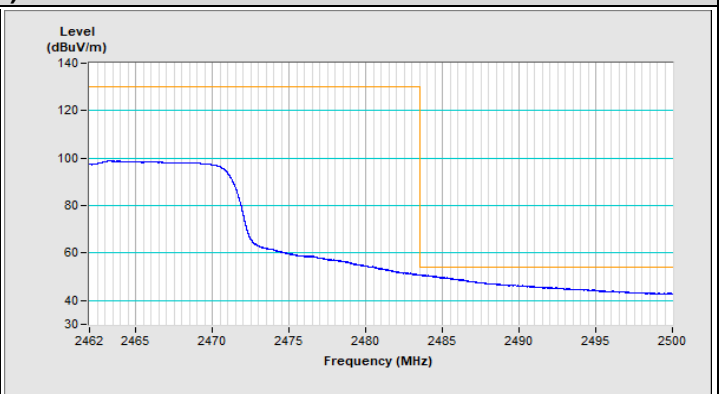

Horizontal (Average)

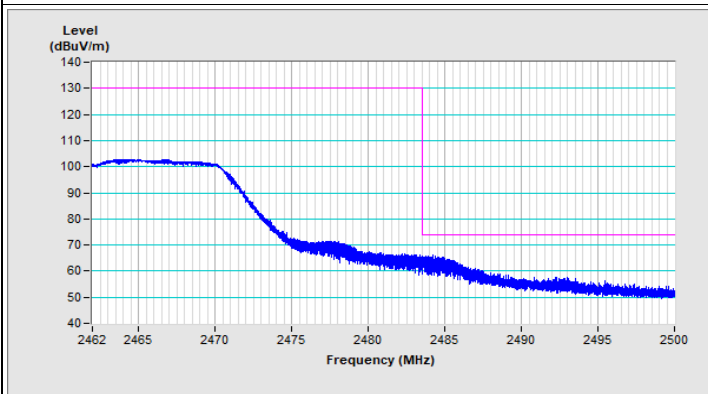

Vertical (Peak)

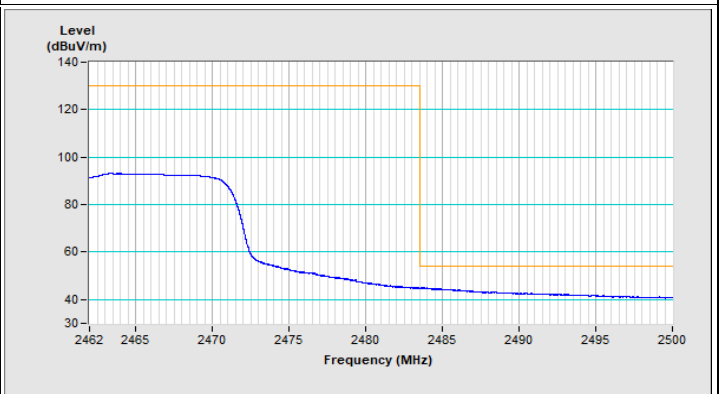

Vertical (Average)

802.11n (HT40) Channel 3

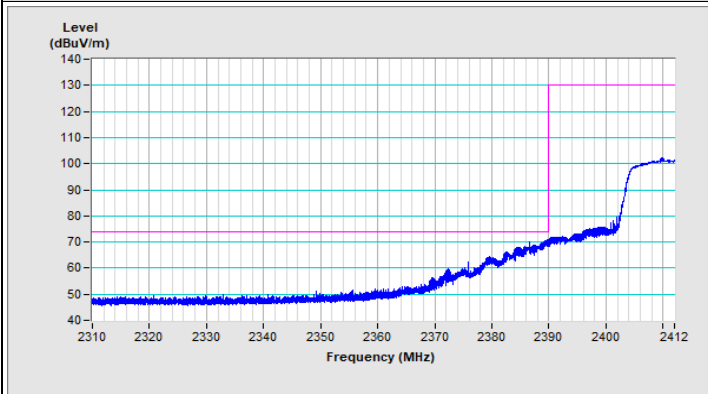

Horizontal (Peak)

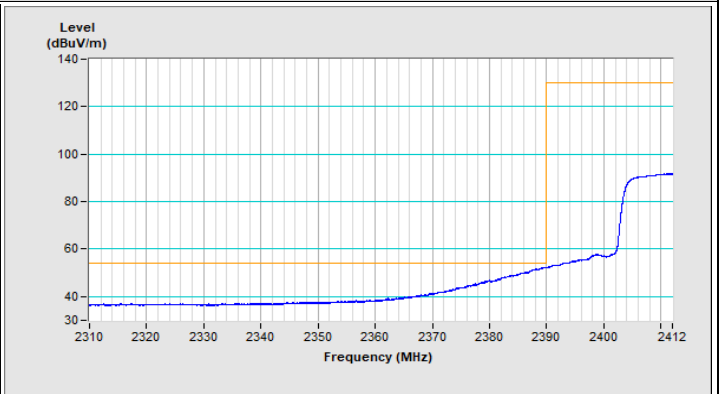

Horizontal (Average)

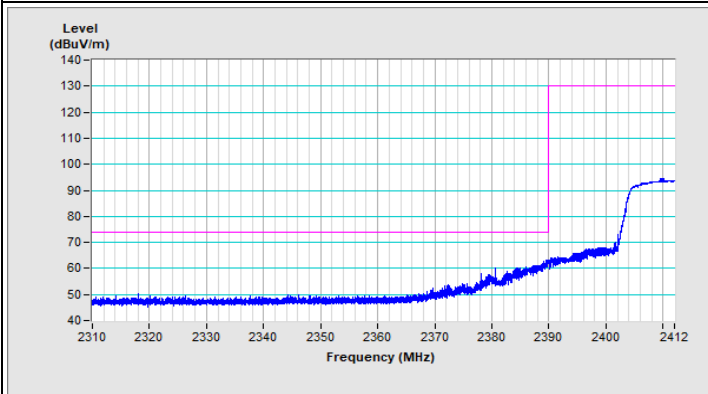

Vertical (Peak)

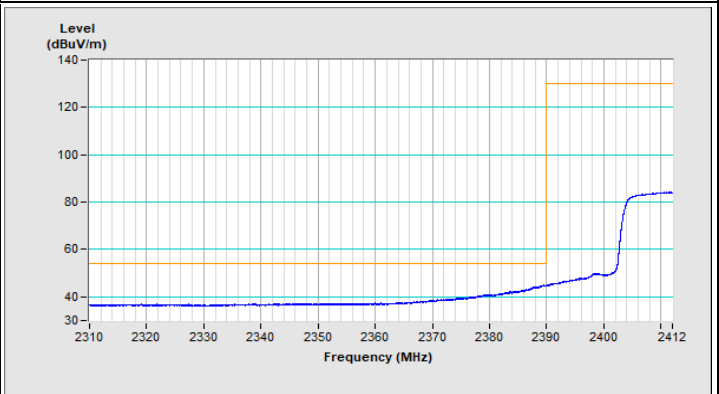

Vertical (Average)

802.11n (HT40) Channel 9

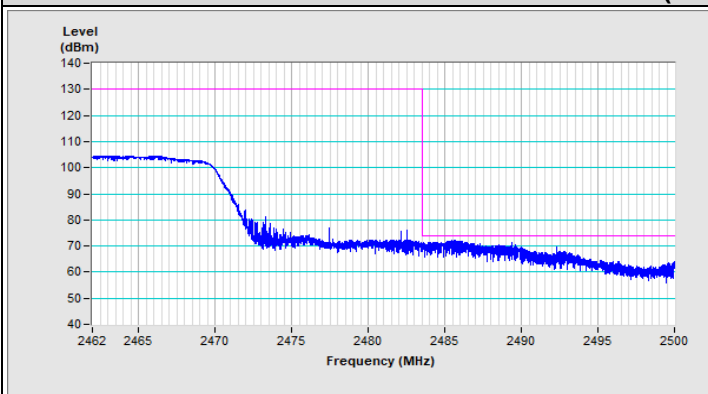

Horizontal (Peak)

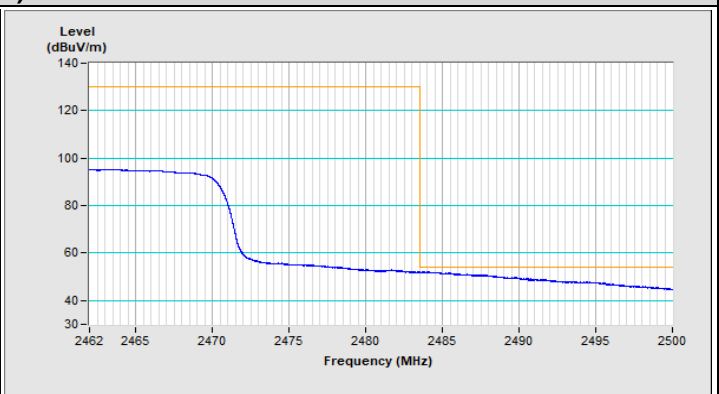

Horizontal (Average)

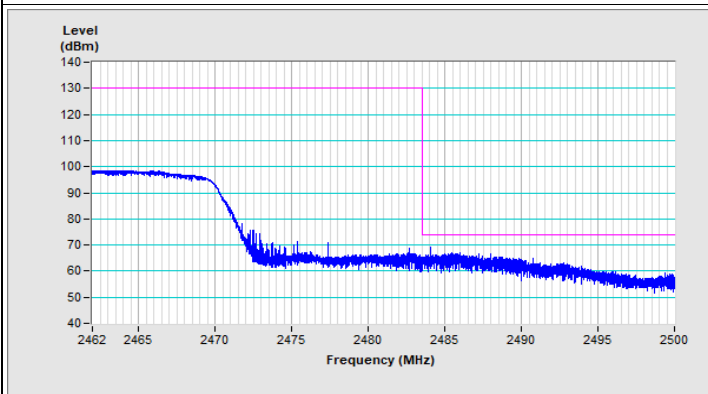

Vertical (Peak)

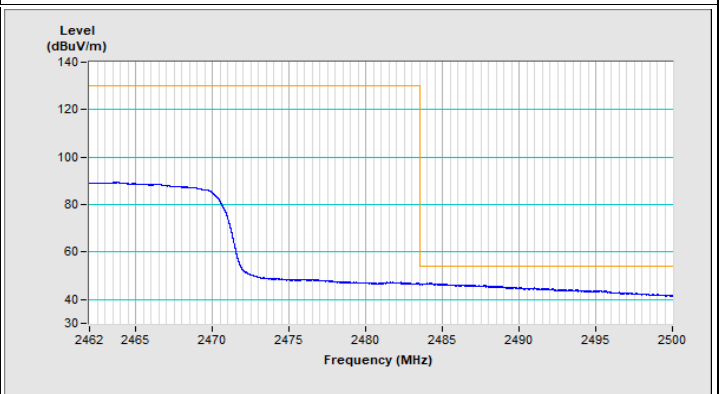

Vertical (Average)

8 Pictures of Test Arrangements

Please refer to the attached file (Test Setup Photo)

9 Information of the Testing Laboratories

We, Bureau Veritas Consumer Products Services (H.K.) Ltd., Taoyuan Branch, were founded in 1988 to provide our best service in EMC, Radio, Telecom and Safety consultation. Our laboratories are FCC recognized accredited test firms and accredited according to ISO/IEC 17025.

If you have any comments, please feel free to contact us at the following:

Lin Kou EMC/RF Lab

Tel: 886-2-26052180

Fax: 886-2-26051924

Hsin Chu EMC/RF/Telecom Lab

Tel: 886-3-6668565

Fax: 886-3-6668323

Hwa Ya EMC/RF/Safety Lab

Tel: 886-3-3183232

Fax: 886-3-3270892

Email: service.adt@bureauveritas.com

Web Site: <http://ee.bureauveritas.com.tw>

The address and road map of all our labs can be found in our web site also.

--- END ---