

Prüfbericht-Nr.: <i>Test report no.:</i>	CN22ZQ3P (P15C-WiFi 2.4G) 001	Auftrags-Nr.: <i>Order no.:</i>	238546695	Seite 1 von 30 Page 1 of 30
Kunden-Referenz-Nr.: <i>Client reference no.:</i>	N/A	Auftragsdatum: <i>Order date:</i>	2022-08-11	
Auftraggeber: <i>Client:</i>	Corsair Memory, Inc. 115 North McCarthy Blvd, Milpitas, CA 95035, USA			
Prüfgegenstand: <i>Test item:</i>	Key Light			
Bezeichnung / Typ-Nr.: <i>Identification / Type no.:</i>	20GAK9902			
Auftrags-Inhalt: <i>Order content:</i>	FCC Part 15C Test report (WiFi 2.4GHz)			
Prüfgrundlage: <i>Test specification:</i>	FCC 47CFR Part 15: Subpart C Section 15.247			
Wareneingangsdatum: <i>Date of sample receipt:</i>	2022-09-16			
Prüfmuster-Nr.: <i>Test sample no.:</i>	A003337280-001 A003337280-003			
Prüfzeitraum: <i>Testing period:</i>	2022-10-05 – 2022-10-17 2023-06-09 – 2023-06-14			
Ort der Prüfung: <i>Place of testing:</i>	EMC/RF Taipei Testing Site			
Prüflaboratorium: <i>Testing laboratory:</i>	Taipei Testing Laboratories			
Prüfergebnis*: <i>Test result*:</i>	Pass			
zusammengestellt von: <i>compiled by:</i>		genehmigt von: <i>authorized by:</i>		
Datum: <i>Date:</i>	2023-06-19	Ausstellungsdatum: <i>Issue date:</i>	2023-06-19	
Stellung / Position:	Senior Project Manager	Stellung / Position:	Senior Project Manager	
Sonstiges / Other:				
Zustand des Prüfgegenstandes bei Anlieferung: <i>Condition of the test item at delivery:</i>		Prüfmuster vollständig und unbeschädigt <i>Test item complete and undamaged</i>		
* Legende:	1 = sehr gut P(ass) = entspricht o.g. Prüfgrundlage(n)	2 = gut F(ail) = entspricht nicht o.g. Prüfgrundlage(n)	3 = befriedigend N/A = nicht anwendbar	4 = ausreichend N/T = nicht getestet
* Legend:	1 = very good P(ass) = passed a.m. test specification(s)	2 = good F(ail) = failed a.m. test specification(s)	3 = satisfactory N/A = not applicable	4 = sufficient N/T = not tested
Dieser Prüfbericht bezieht sich nur auf das o.g. Prüfmuster und darf ohne Genehmigung der Prüfstelle nicht auszugsweise vervielfältigt werden. Dieser Bericht berechtigt nicht zur Verwendung eines Prüfzeichens. <i>This test report only relates to the a. m. test sample. Without permission of the test center this test report is not permitted to be duplicated in extracts. This test report does not entitle to carry any test mark.</i>				

TEST SUMMARY

Report Section	FCC Clause	Test Item	Result
5.1.1	15.247(b) & 15.203	Antenna Requirement	Pass
5.1.2	15.247(b)(3)	Peak Output Power	Pass
5.1.3	15.247(a)(2)	6 dB Bandwidth	Pass
5.1.3	2.1049	99% Occupied Bandwidth	Pass
5.1.4	15.247(e)	Power Spectral Density	Pass
5.1.5	15.247(d)	Conducted Spurious Emissions and Band Edges	Pass
5.1.6	15.247(d) & 15.205 & 15.209	Radiated Spurious Emissions and Band Edges	Pass
5.2.1	15.207	Mains Conducted Emission	Pass

Note: Determining compliance based on the results of the compliance measurement, not taking into account measurement instrumentation uncertainty.

Contents

HISTORY OF THIS TEST REPORT	5
1. GENERAL REMARKS	6
1.1 COMPLEMENTARY MATERIALS.....	6
1.2 DECISION RULE OF CONFORMITY	6
2. TEST SITES	7
2.1 TEST LABORATORY	7
2.2 TEST FACILITY.....	7
2.3 TRACEABILITY	8
2.4 CALIBRATION	8
2.5 MEASUREMENT UNCERTAINTY	8
3. GENERAL PRODUCT INFORMATION.....	9
3.1 PRODUCT FUNCTION AND INTENDED USE	9
3.2 SYSTEM DETAILS AND RATINGS.....	9
3.3 NOISE GENERATING AND NOISE SUPPRESSING PARTS	10
3.4 SUBMITTED DOCUMENTS.....	10
4. TEST SET-UP AND OPERATION MODES.....	11
4.1 PRINCIPLE OF CONFIGURATION SELECTION	11
4.2 CARRIER FREQUENCY AND CHANNEL.....	11
4.3 TEST OPERATION AND TEST SOFTWARE.....	12
4.4 SPECIAL ACCESSORIES AND AUXILIARY EQUIPMENT	14
4.5 TEST SETUP DIAGRAM	15
4.6 DUTY CYCLE OF TEST SIGNAL	16
5. TEST RESULTS	17
5.1 TRANSMITTER REQUIREMENT & TEST SUITES.....	17
5.1.1 <i>Antenna Requirement</i>	<i>17</i>
5.1.2 <i>Peak Output Power</i>	<i>18</i>
5.1.3 <i>6 dB Bandwidth and 99% Occupied Bandwidth.....</i>	<i>21</i>
5.1.4 <i>Power Spectral Density.....</i>	<i>22</i>
5.1.5 <i>Conducted Spurious Emissions and Frequency Band Edges Measured in 100 kHz</i> <i>Bandwidth.....</i>	<i>23</i>
5.1.6 <i>Radiated Spurious Emissions and Band Edges</i>	<i>24</i>
5.2 MAINS EMISSION	29
5.2.1 <i>Mains Conducted Emission.....</i>	<i>29</i>

Prüfbericht - Nr.: CN22ZQ3P (P15C-WiFi 2.4G) 001
Test Report No.

Seite 4 von 30
Page 4 of 30

APPENDIX A - TEST RESULT OF CONDUCTED

APPENDIX B - TEST RESULT OF RADIATED EMISSIONS & MAINS CONDUCTED EMISSION

APPENDIX SP - PHOTOGRAPHS OF TEST SETUP

APPENDIX EP - PHOTOGRAPHS OF EUT

Prüfbericht - Nr.: CN22ZQ3P (P15C-WiFi 2.4G) 001
Test Report No.

Seite 5 von 30
Page 5 of 30

HISTORY OF THIS TEST REPORT

Report No.	Description	Date Issued
CN22ZQ3P (P15C-WiFi 2.4G) 001	Original Release	2023-06-19

1. General Remarks

1.1 Complementary Materials

All attachments are integral parts of this test report. This applies especially to the following appendix:

Appendix A - Test Result of Conducted

Appendix B - Test Result of Radiated Emissions & Mains Conducted Emission

Appendix SP - Photographs of Test Setup

Appendix EP - Photographs of EUT

Applied Standard and Test Levels

Radio
FCC 47CFR Part 15: Subpart C Section 15.247
FCC 47CFR Part 2: Subpart J Section 2.1049
ANSI C63.10:2013
KDB 558074 D01 15.247 Meas Guidance v05r02
KDB 662911 D01 Multiple Transmitter Output v02r01

1.2 Decision Rule of Conformity

The decision rule of conformity of this test report is following the requirements of the requested standard in the quotation, and agreed among testing laboratory and manufacturer (applicant) to exclude the consideration of Measurement Uncertainty, unless it is required by the specific standard.

2. Test Sites

2.1 Test Laboratory

Taipei Testing Laboratories

11F. No.758, Sec. 4, Bade Rd., Songshan Dist.
Taipei City 105
Taiwan (R.O.C.)

2.2 Test Facility

Taipei Testing Laboratories

No.458-18, Sec. 2, Fenliao Rd., Linkou Dist.,
New Taipei City 244
Taiwan (R.O.C.)
FCC Registration No.: 180491
ISED Registration No.: 25563

2.3 Traceability

All measurement equipment calibrations are traceable to NML(Taiwan)/NIST(USA) or where calibration is performed outside Taiwan, to equivalent nationally recognized standards organizations.

2.4 Calibration

Equipment requiring calibration is calibrated periodically in a suitably accredited Calibration Lab. Additionally all equipment is verified for proper performance on a regular basis using in house standards or comparisons.

2.5 Measurement Uncertainty

All measurement uncertainty values are shown with a coverage factor of $k=2$ to indicate a 95% level of confidence.

Emission Measurement Uncertainty

Parameter	Uncertainty
Radiated Emission (9 kHz ~ 30 MHz)	± 1.15 dB
Radiated Emission (30 MHz ~ 200 MHz)	± 1.32 dB
Radiated Emission (200 MHz ~ 1 GHz)	± 1.31 dB
Radiated Emission (1 GHz ~ 18 GHz)	± 1.53 dB
Radiated Emission (18 GHz ~ 40 GHz)	± 2.50 dB
Mains Conducted Emission	± 1.65 dB

3. General Product Information

3.1 Product Function and Intended Use

The EUT is a Key Light. It contains a WLAN compatible module enabling the user to communicate data through a Wireless interface.

For details refer to the User Guide, Data Sheet and Circuit Diagram.

3.2 System Details and Ratings

Basic Information of EUT

Item	EUT information
Kind of Equipment/Test Item	Key Light
Type Identification	20GAK9902
FCC ID	2AAFM-20GAK9902

Technical Specification of EUT

Item	EUT information
Operating Frequency	2412 MHz ~ 2462 MHz
Channel Spacing	5 MHz
Channel Number	802.11b/g/n HT20: 11 802.11n HT40: 7
Data Rate	802.11b: 11.0 / 5.5 / 2.0 / 1.0 Mbps 802.11g: 54.0 / 48.0 / 36.0 / 24.0 / 18.0 / 12.0 / 9.0 / 6.0 Mbps 802.11n: up to MCS7
Operation Voltage	100-240Vac (Adapter), input 13Vdc
Modulation	DSSS (DBPSK, DQPSK, CCK) OFDM (BPSK, QPSK, 16QAM, 64QAM)
Maximum Output Power (mW)	802.11b: 78.16 802.11g: 161.44 802.11n HT20: 160.69 802.11n HT40: 140.28
Antenna Information	Refer to 5.1.1
Accessory Device	Refer to 4.4

3.3 Noise Generating and Noise Suppressing Parts

Refer to the Circuit Diagram.

3.4 Submitted Documents

- Circuit Diagram
- Instruction Manual
- Rating Label
- Technical Description

4. Test Set-up and Operation Modes

4.1 Principle of Configuration Selection

The test modes were adapted accordingly in reference to the instructions for use.

During testing, Channel and Power Controlling Software provided by the customer was used to control the operating channel as well as the output power level. The RF output power selection is for the setting of RF output expected by the customer and is going to be fixed on the firmware of the final end product.

Table for Parameters of Test Software Setting

802.11b		802.11g		802.11n HT20		802.11n HT40	
Channel	Power Setting	Channel	Power Setting	Channel	Power Setting	Channel	Power Setting
1	127	1	123	1	119	3	110
6	124	6	127	6	127	6	108
11	116	11	103	11	100	9	102

4.2 Carrier Frequency and Channel

802.11b, 802.11g and 802.11n HT20:

Channel	Frequency (MHz)	Channel	Frequency (MHz)
1	2412	8	2447
2	2417	9	2452
3	2422	10	2457
4	2427	11	2462
5	2432		
6	2437		
7	2442		

802.11n HT40:

Channel	Frequency (MHz)	Channel	Frequency (MHz)
3	2422	7	2442
4	2427	8	2447
5	2432	9	2452
6	2437		

4.3 Test Operation and Test Software

Setup for testing: Test samples are provided with a USB interface which makes it possible to control them through a test software installed on a notebook computer.
 This software was running on the laptop computer connected to the EUT. It was used to enable the operation modes listed as below.

Test Software	UI_mptool.exe
---------------	---------------

The samples were used as follows:

A003337280-001

A003337280-003

Full test was applied on all test modes, but only worst case was shown.

Modulation Mode	Tx Function
802.11b	1TX (SISO)
802.11g	1TX (SISO)
802.11n HT20	1TX (SISO)
802.11n HT40	1TX (SISO)

EUT Configure Mode	Applicable To			Description	
	Antenna Port Conducted Measurement	Radiated Spurious Emissions above 1 GHz	Radiated Spurious Emissions below 1 GHz		Mains Conducted Emission
-	√	√	√	√	-

Note:

1. The EUT had been pre-tested on the positioned of each 3 axis. The worst case was found when position on Z-plane.
2. "-" means no effect.

Antenna Port Conducted Measurement

- Pre-Scan full test was applied on all test modes, but only worst case was shown.
- Following channel(s) was (were) selected for the final test as listed below.

EUT Configure Mode	Mode	Available Channel	Tested Channel	Date Rate (Mbps)
-	802.11b	1 to 11	1, 6, 11	1.0
-	802.11g	1 to 11	1, 6, 11	6.0
-	802.11n HT20	1 to 11	1, 6, 11	MCS0
-	802.11n HT40	3 to 9	3, 6, 9	MCS0

Radiated Spurious Emissions (Above 1 GHz)

- Pre-Scan full test was applied on all test modes, but only worst case was shown.
- Following channel(s) was (were) selected for the final test as listed below.

EUT Configure Mode	Mode	Available Channel	Tested Channel	Date Rate (Mbps)
-	802.11b	1 to 11	1, 6, 11	1.0
-	802.11g	1 to 11	1, 6, 11	6.0
-	802.11n HT20	1 to 11	1, 6, 11	MCS0
-	802.11n HT40	3 to 9	3, 6, 9	MCS0

Radiated Spurious Emissions (Below 1 GHz)

- Pre-Scan full test was applied on all test modes, but only worst case was shown.
- Following channel(s) was (were) selected for the final test as listed below.

EUT Configure Mode	Mode	Available Channel	Tested Channel	Date Rate (Mbps)
-	802.11n HT20	1 to 11	6	MCS0

Mains Conducted Emission

- Pre-Scan full test was applied on all test modes, but only worst case was shown.
- Following channel(s) was (were) selected for the final test as listed below.

EUT Configure Mode	Mode	Available Channel	Tested Channel	Date Rate (Mbps)
-	802.11n HT20	1 to 11	6	MCS0

Test Condition

Test Item	Ambient Temperature	Relative Humidity	Tested by
Conducted Measurement	18-23 °C	58-67 %	Nick Guan
Radiated Spurious Emissions above 1 GHz	23.7-24.6 °C	52-55 %	Roger Liao
Radiated Spurious Emissions below 1 GHz	23.7-24.6 °C	52-55 %	Roger Liao
Mains Conducted Emission	21 °C	54 %	Ray Huang

4.4 Special Accessories and Auxiliary Equipment

The product has been tested together with the following additional accessories:

Accessory of EUT

None.

Support Unit

No.	Description	Brand	Model	S/N	Remark
Radiated Test					
A	Uart	Dexatek	CP2102	-	USB to TTL
B	Adapter (LED Driver)	Intertek	A654-13040000I	-	I/P: 100-240 Vac, 50/60 Hz, 1.5 A O/P: 13 Vdc, 4 A 250 cm non-shielded cable with core
1	USB to USB	TUV	TUV-03	-	300 cm non-shielded cable w/o core
2	Notebook	Lenovo	81BL	MP1DCD6Y	-
3	DC cable	TUV	TUV-01	-	300 cm non-shielded cable w/o core
Mains Conducted Test					
A	Adapter (LED Driver)	Intertek	A654-13040000I	-	I/P: 100-240 Vac, 50/60 Hz, 1.5 A O/P: 13 Vdc, 4 A 250 cm non-shielded cable with core
B	Uart	Dexatek	CP2102	-	USB to TTL
1	USB to USB	TUV	TUV-03	-	300 cm non-shielded cable w/o core
2	Notebook	Lenovo	81BL	MP1DCD6Y	-
Conducted Test					
-	Notebook	Lenovo	20CLS3P606	PC0DH09R	NB-06

4.5 Test Setup Diagram

<Radiated Spurious Emissions mode>

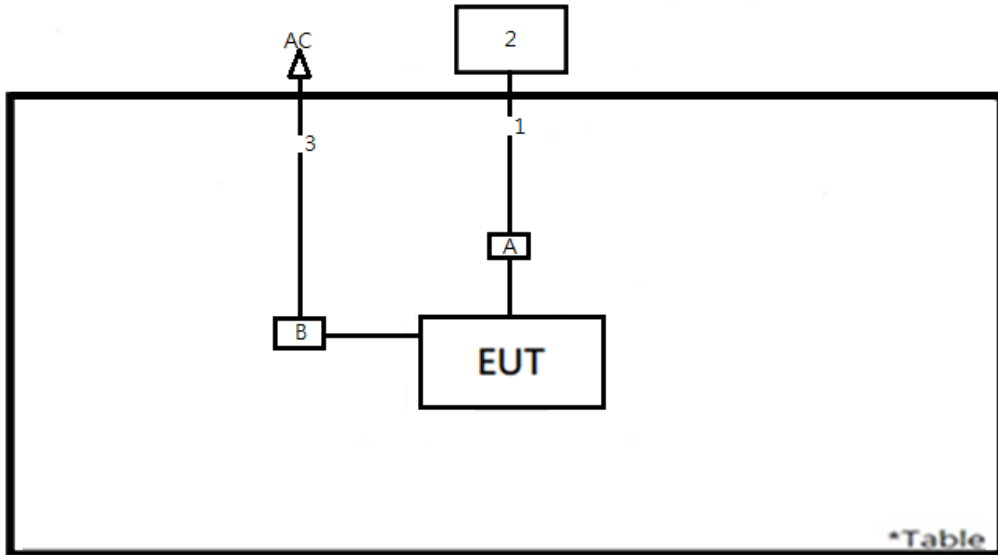

<Mains Conducted Emission mode>

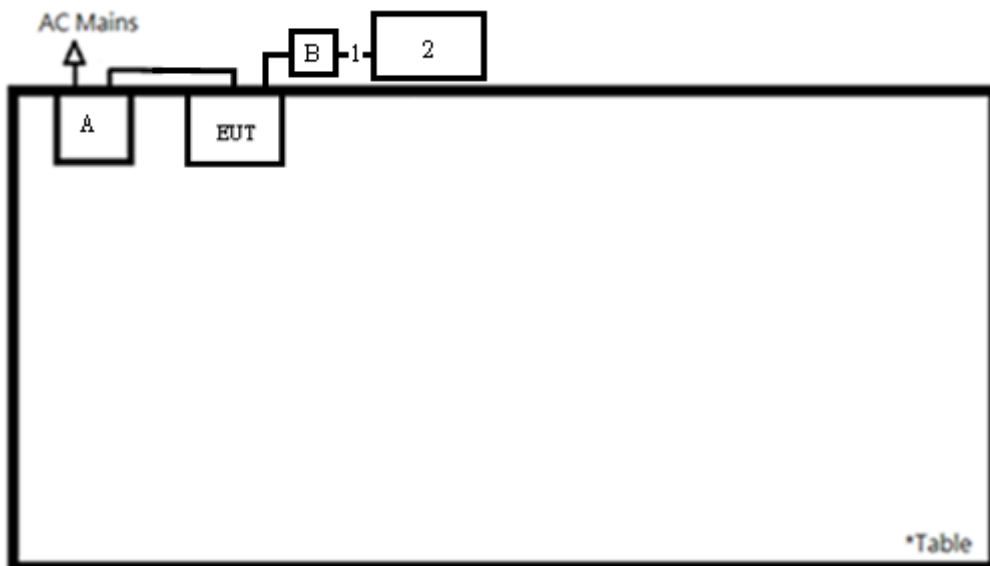

4.6 Duty Cycle of Test Signal

Mode	On + Off Time (ms)	On Time (ms)	Duty Cycle (%)	Duty Factor (dB)
802.11b	12.56	12.42	98.89	0.05
802.11g	2.19	2.05	93.61	0.29
802.11n HT20	2.06	1.90	92.23	0.35
802.11n HT40	1.08	0.94	87.04	0.60

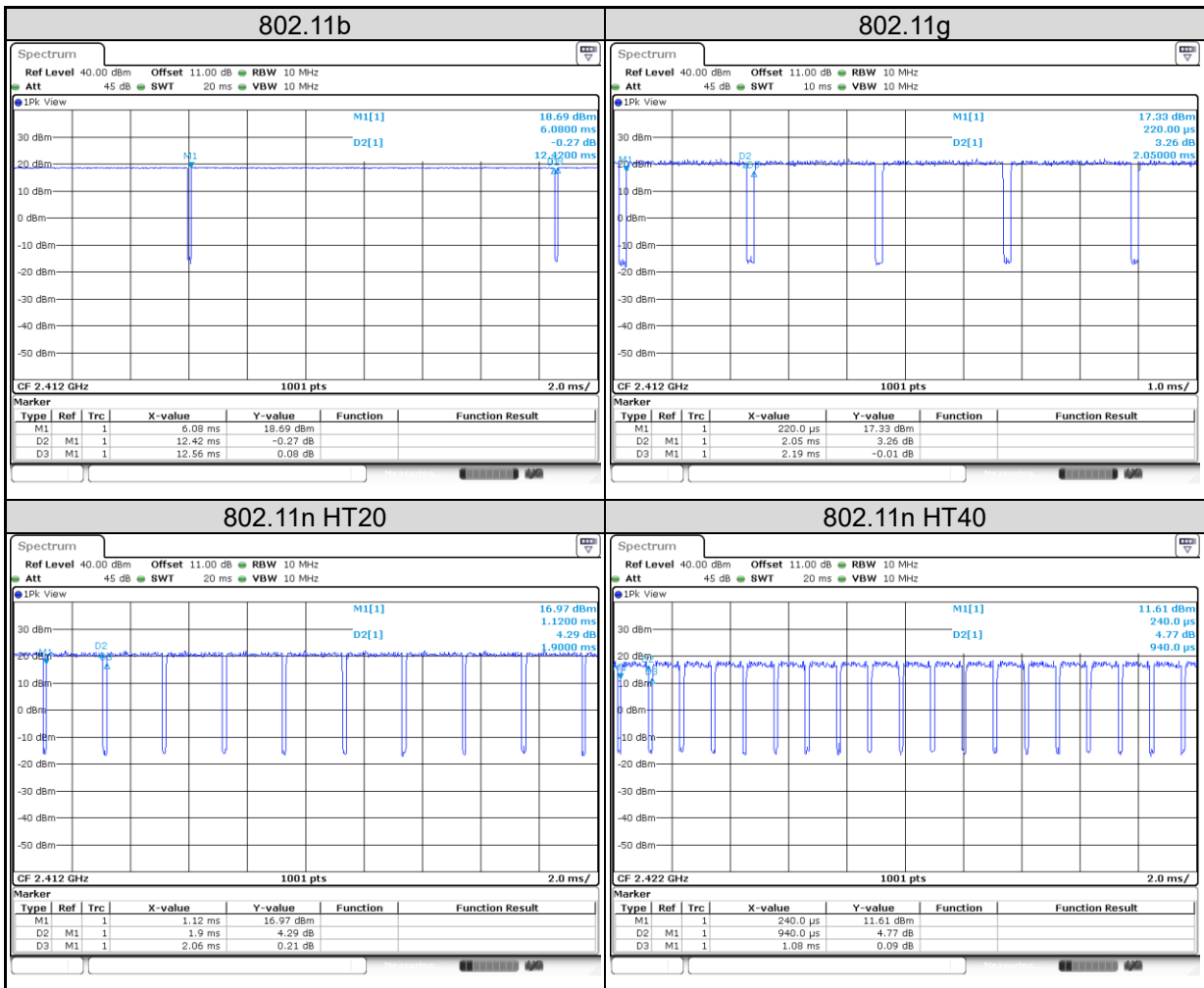

5. Test Results

5.1 Transmitter Requirement & Test Suites

5.1.1 Antenna Requirement

Requirement Use of approved antennas only

According to the manufacturer declaration, the EUT has an antenna with a directional gain of 1 dBi. The antenna is Chip Antenna with no possibility of replacement with a non-approved antenna by the end-user. Therefore, the EUT is considered to comply with this provision.

Refer to EUT photo for details.

5.1.2 Peak Output Power

Limit 1 watt (30 dBm)

Kind of Test Site Shielded room

Test Setup

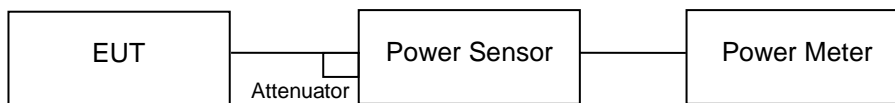

Test Instruments

Kind of Equipment	Manufacturer	Type	S/N	Calibration Date	Calibration Due Date	Test Date	
						From	Until
Power Meter	Anritsu	ML2495A	1901008	2022/3/15	2023/3/14	2022/10/5	2022/11/17
Power Sensor	Anritsu	MA2411B	1725269	2022/3/15	2023/3/14	2022/10/5	2022/11/17

Test Procedures

A peak power sensor was used on the output port of the EUT. A power meter was used to read the response of the peak power sensor. Record the power level.

Average power sensor was used to perform output power measurement, trigger and gating function of wide band power meter is enabled to measure max output power of TX on burst. Duty factor is not added to measured value.

Test Result
Peak Output Power
<802.11b>

Channel	Channel Frequency (MHz)	Peak Output Power		Limit (dBm)
		(dBm)	(mW)	
1	2412	18.93	78.16	30
6	2437	18.58	72.11	30
11	2462	17.38	54.70	30

<802.11g>

Channel	Channel Frequency (MHz)	Peak Output Power		Limit (dBm)
		(dBm)	(mW)	
1	2412	21.94	156.31	30
6	2437	22.08	161.44	30
11	2462	20.38	109.14	30

<802.11n HT20>

Channel	Channel Frequency (MHz)	Peak Output Power		Limit (dBm)
		(dBm)	(mW)	
1	2412	21.92	155.60	30
6	2437	22.06	160.69	30
11	2462	20.49	111.94	30

<802.11n HT40>

Channel	Channel Frequency (MHz)	Peak Output Power		Limit (dBm)
		(dBm)	(mW)	
3	2422	21.38	137.40	30
6	2437	21.47	140.28	30
9	2452	19.72	93.76	30

Average Power
<802.11b>

Channel	Channel Frequency (MHz)	Average Power	
		(dBm)	(mW)
1	2412	16.82	48.08
6	2437	16.56	45.29
11	2462	15.12	32.51

<802.11g>

Channel	Channel Frequency (MHz)	Average Power	
		(dBm)	(mW)
1	2412	16.72	46.99
6	2437	17.49	56.10
11	2462	12.62	18.28

<802.11n HT20>

Channel	Channel Frequency (MHz)	Average Power	
		(dBm)	(mW)
1	2412	16.45	44.16
6	2437	17.45	55.59
11	2462	12.96	19.77

<802.11n HT40>

Channel	Channel Frequency (MHz)	Average Power	
		(dBm)	(mW)
3	2422	14.23	26.49
6	2437	14.24	26.55
9	2452	12.85	19.28

5.1.3 6 dB Bandwidth and 99% Occupied Bandwidth

Limit The minimum 6 dB bandwidth shall be at least 500 kHz.

Kind of Test Site Shielded room

Test Setup

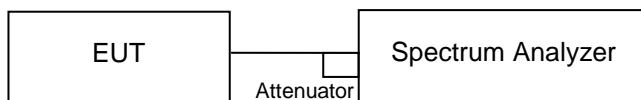

Test Instruments

Kind of Equipment	Manufacturer	Type	S/N	Calibration Date	Calibration Due Date	Test Date	
						From	Until
Spectrum Analyzer	R&S	FSV40	101512	2022/2/24	2023/2/23	2022/10/5	2022/11/17
Thermal Chamber	GIANT FORCE	GCT-099-40-S	MAF0103-007	2022/3/2	2023/3/1	2022/10/5	2022/11/17

Test Procedure

- Set resolution bandwidth (RBW) = 100 kHz
- Set the video bandwidth (VBW) $\geq 3 \times$ RBW, Detector = Peak.
- Trace mode = max hold.
- Sweep = auto couple.
- Measure the maximum width of the emission that is constrained by the frequencies associated with the two amplitude points (upper and lower) that are attenuated by 6 dB relative to the maximum level measured in the fundamental emission.
- For 99% occupied bandwidth measurement, the transmitter output was connected to the spectrum analyzer through an attenuator. The bandwidth of the fundamental frequency was measured by spectrum analyzer with resolution bandwidth in the range of 1% to 5% of the anticipated emission bandwidth, and a video bandwidth at least 3x the resolution bandwidth and set the detector to PEAK. The width of a frequency band such that, below the lower and above the upper frequency limits, the mean powers emitted are each equal to a specified percentage 0.5% of the total mean power of a given emission.

Test Results

Please refer to Appendix A.

5.1.4 Power Spectral Density

Limit

The power spectral density shall not be greater than 8 dBm in any 3 kHz band.

Kind of Test Site Shielded room

Test Setup

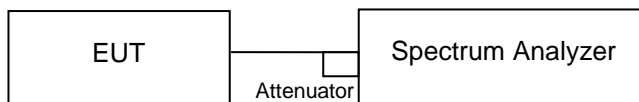

Test Instruments

Kind of Equipment	Manufacturer	Type	S/N	Calibration Date	Calibration Due Date	Test Date	
						From	Until
Spectrum Analyzer	R&S	FSV40	101512	2022/2/24	2023/2/23	2022/10/5	2022/11/17
Thermal Chamber	GIANT FORCE	GCT-099-40-S	MAF0103-007	2022/3/2	2023/3/1	2022/10/5	2022/11/17

Test Procedure

- a. Set analyzer center frequency to DTS channel center frequency.
- b. Set the span to 1.5 times the DTS bandwidth.
- c. Set the RBW to: $3 \text{ kHz} \leq \text{RBW} \leq 100 \text{ kHz}$.
- d. Set the VBW $\geq 3 \times \text{RBW}$.
- e. Detector = peak.
- f. Sweep time = auto couple.
- g. Trace mode = max hold.
- h. Allow trace to fully stabilize.
- i. Use the peak marker function to determine the maximum amplitude level within the RBW.

Test Results

Please refer to Appendix A.

5.1.5 Conducted Spurious Emissions and Frequency Band Edges Measured in 100 kHz Bandwidth

Limit

20 dB (below that in the 100 kHz bandwidth within the band that contains the highest level of the desired power.)

Kind of Test Site Shielded room

Test Setup

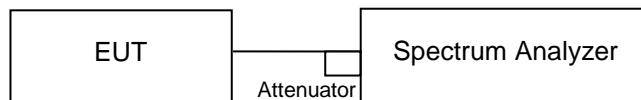

Test Instruments

Kind of Equipment	Manufacturer	Type	S/N	Calibration Date	Calibration Due Date	Test Date	
						From	Until
Spectrum Analyzer	R&S	FSV40	101512	2022/2/24	2023/2/23	2022/10/5	2022/11/17
Thermal Chamber	GIANT FORCE	GCT-099-40-S	MAF0103-007	2022/3/2	2023/3/1	2022/10/5	2022/11/17

Test Procedure

Measurement procedure REF

1. Set the RBW = 100 kHz.
2. Set the VBW \geq 300 kHz.
3. Detector = peak.
4. Sweep time = auto couple.
5. Trace mode = max hold.
6. Allow trace to fully stabilize.
7. Use the peak marker function to determine the maximum power level in any 100 kHz band segment within the fundamental EBW.

Measurement procedure OOBE

1. Set RBW = 100 kHz.
2. Set VBW \geq 300 kHz.
3. Detector = peak.
4. Sweep = auto couple.
5. Trace Mode = max hold.
6. Allow trace to fully stabilize.
7. Use the peak marker function to determine the maximum amplitude level.

Test Results

Please refer to Appendix A.

5.1.6 Radiated Spurious Emissions and Band Edges

Limit

Radiated emissions which fall in the restricted bands, as defined in §15.205(a), must comply with the radiated emission limits specified in §15.209(a).

Emissions radiated outside the restricted and authorized frequency bands must either comply with the radiated emission limits specified for the restricted bands or in §15.247(d).

Kind of Test Site 3m Semi-Anechoic Chamber

Test Setup

<Radiated Emissions below 30 MHz>

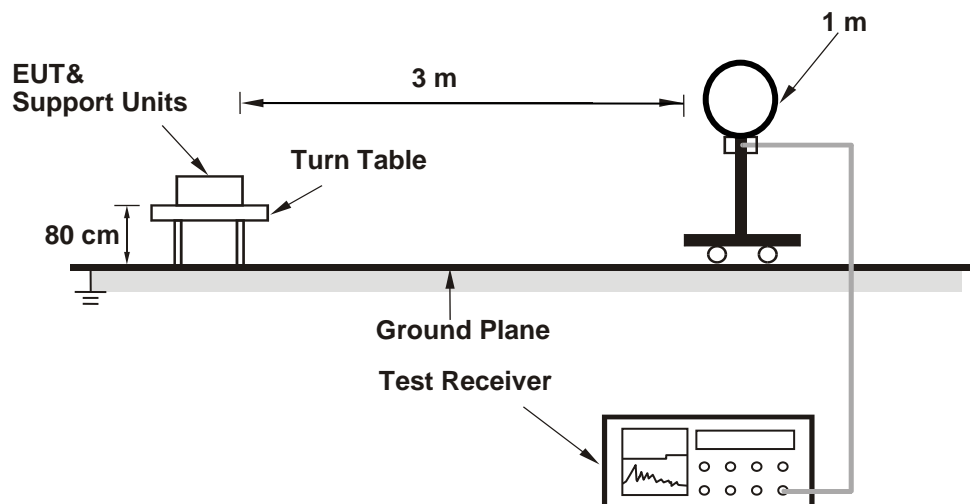

<Radiated Emissions 30 MHz to 1 GHz>

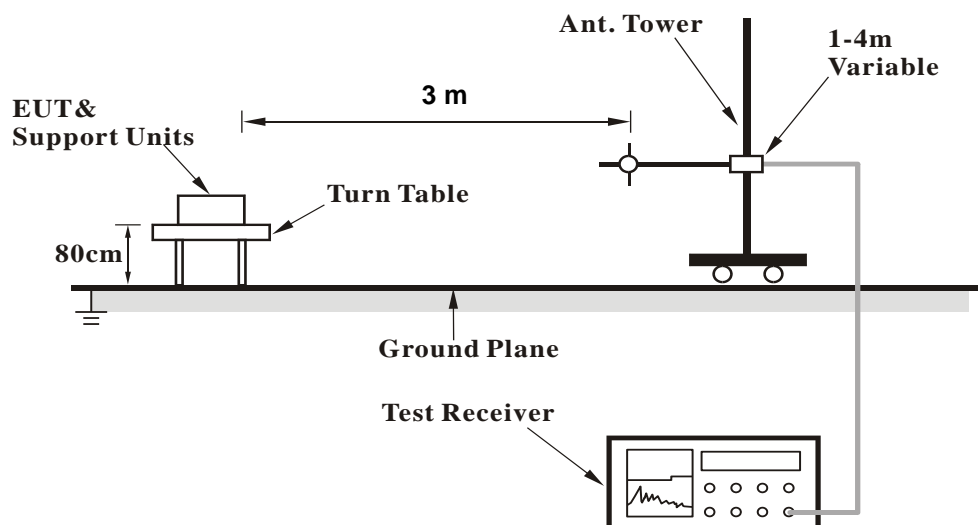

<Radiated Emissions above 1 GHz>

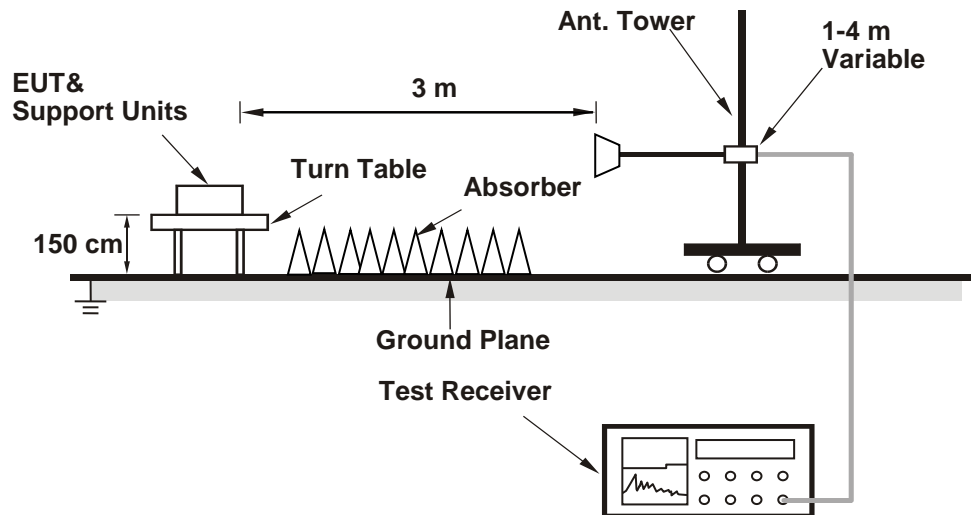

For the actual test configuration, please refer to the attached file (Test Setup Photo).

Test Instruments

Test Date: 2022/10/18 ~ 2022/10/25

Kind of Equipment	Manufacturer	Type	S/N	Calibration Date	Calibration Due Date
Above 1GHz					
Signal Analyzer	R&S	FSV40	101509	2022/4/22	2023/4/21
Horn Antenna	ETS-Lindgren	3117	00218929	2021/11/25	2022/11/24
HF-AMP + AC source	EMCI	EMC051845SE	980635	2022/1/20	2023/1/19
HF-AMP + AC source	EMCI	EMC184045SE	980656	2022/1/20	2023/1/19
Horn Antenna	SCHWARZBECK	BBHA 9170	00887	2022/3/29	2023/3/28
30MHz-1GHz					
Receiver	R&S	ESR7	102109	2022/2/25	2023/2/24
Bilog Antenna	SCHWARZBECK	VULB-9168	00949	2022/5/29	2023/5/28
LF-AMP	Agilent	8447D	2727A05146	2022/2/16	2023/2/15
Below 30MHz					
Receiver	R&S	ESR7	102109	2022/2/25	2023/2/24
Microwave Cable	SUCOFLEX 104EA	800056/4EA	804680/4	2022/3/22	2023/3/21
Loop Antenna	SCHWARZBECK	FMZB 1519B	00215	2021/12/8	2022/12/7

Test Date: 2023/6/9 ~ 2023/6/12

Kind of Equipment	Manufacturer	Type	S/N	Calibration Date	Calibration Due Date
30MHz-1GHz					
Receiver	R&S	ESR7	102109	2023/2/24	2024/2/23
Bilog Antenna	SCHWARZBECK	VULB-9168	00951	2023/3/31	2024/3/29
LF-AMP	Agilent	8447D	2727A05146	2023/2/16	2024/2/15
Below 30MHz					
Receiver	R&S	ESR7	102109	2023/2/24	2024/2/23
Loop Antenna	SCHWARZBECK	FMZB 1519B	00215	2023/1/4	2024/1/3

Test Procedures**For Radiated Emissions below 30 MHz**

- a. The EUT was placed on the top of a rotating table 0.8 meters above the ground at a 3 meter chamber room. The table was rotated 360 degrees to determine the position of the highest radiation.
- b. The EUT was set 3 meters away from the interference-receiving antenna, which was mounted on the top of a variable-height antenna tower.
- c. Parallel (OPEN), perpendicular (CLOSE), and ground-parallel (GROUND) orientations of the antenna are set to make the measurement.
- d. For each suspected emission, the EUT was arranged to its worst case and the rotatable table was turned from 0 degrees to 360 degrees to find the maximum reading.
- e. The test-receiver system was set to Quasi-Peak Detect Function and Specified Bandwidth with Maximum Hold Mode.

Note:

1. The resolution bandwidth and video bandwidth of test receiver/spectrum analyzer is 9 kHz at frequency below 30 MHz.
2. All modes of operation were investigated and the worst-case emissions are reported.

For Radiated Emissions above 30 MHz

- a. The EUT was placed on the top of a rotating table 0.8 meters (for 30 MHz ~ 1 GHz) / 1.5 meters (for above 1 GHz) above the ground at 3 meter chamber room for test. The table was rotated 360 degrees to determine the position of the highest radiation.
- b. The EUT was set 3 meters away from the interference-receiving antenna, which was mounted on the top of a variable-height antenna tower.
- c. The height of antenna is varied from one meter to four meters above the ground to determine the maximum value of the field strength. Both horizontal and vertical polarizations of the antenna are set to make the measurement.
- d. For each suspected emission, the EUT was arranged to its worst case and then the antenna was tuned to heights from 1 meter to 4 meters and the rotatable table was turned from 0 degrees to 360 degrees to find the maximum reading.
- e. The test-receiver system was set to quasi-peak detect function and specified bandwidth with maximum hold mode when the test frequency is below 1 GHz.
- f. The test-receiver system was set to peak and average detected function and specified bandwidth with maximum hold mode when the test frequency is above 1 GHz. If the peak reading value also meets average limit, measurement with the average detector is unnecessary.

Note:

1. The resolution bandwidth and video bandwidth of test receiver/spectrum analyzer is 120 kHz for Quasi-peak detection (QP) or Peak detection (PK) at frequency below 1 GHz.
2. The resolution bandwidth of test receiver/spectrum analyzer is 1 MHz and the video bandwidth is 3 MHz for Peak detection (PK) at frequency above 1 GHz.
3. The resolution bandwidth of test receiver/spectrum analyzer is 1 MHz and the video bandwidth is $\geq 1/T$ (Duty cycle < 98 %) or 10 Hz (Duty cycle ≥ 98 %) for Average detection (AV) at frequency above 1 GHz.
4. All modes of operation were investigated and the worst-case emissions are reported.
5. The Radiated Emissions testing was performed in the X(E1), Y(H) and Z(E2) axis orientation. The worst-case Axis orientation is recorded in this test report.
6. The emission levels of other frequencies (including the 10th harmonic of the highest fundamental frequency) are very lower than the limit and are not shown in the test report

Prüfbericht - Nr.: CN22ZQ3P (P15C-WiFi 2.4G) 001
Test Report No.

Seite 28 von 30
Page 28 of 30

Test Results

Factor (dB/m) = Antenna Factor (dB/m) + Cable Loss (dB)
Level (dBuV/m) = Reading (dBuV) + Factor (dB/m)

Please refer to Appendix B.

5.2 Mains Emission

5.2.1 Mains Conducted Emission

Limit

Mains Conducted Emission as defined in §15.207 must comply with the mains conducted emission limits.

Kind of Test Site Shielded room

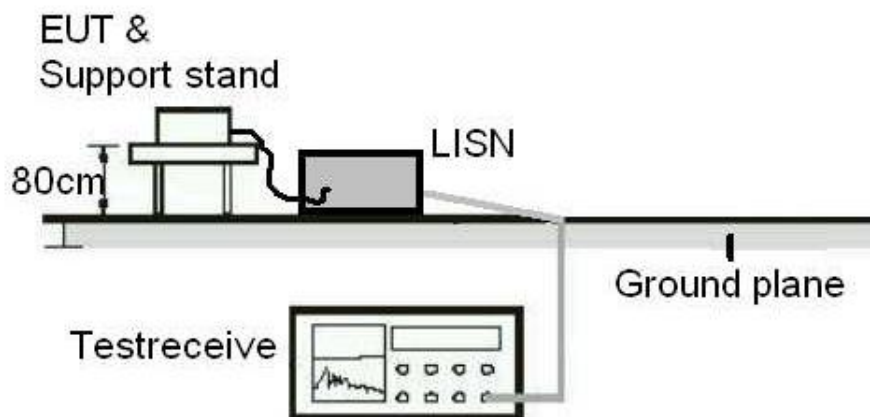
Test Setup

Test Instruments

Test Date: 2023/6/14

Kind of Equipment	Manufacturer	Type	S/N	Calibration Date	Calibration Due Date
Two-Line V-Network	Rohde & Schwarz	ENV216	101938	2022/9/22	2023/9/21
EMI Test Receiver	R&S	ESCI	100797	2022/6/19	2023/6/18

Test Procedures

- a. The EUT was placed 0.4 meters from the conducting wall of the shielded room with EUT being connected to the power mains through a line impedance stabilization network (LISN). Other support units were connected to the power mains through another LISN. The two LISNs provide 50 ohm/50 uH of coupling impedance for the measuring instrument.
- b. Both lines of the power mains connected to the EUT were checked for maximum conducted interference.
- c. The frequency range from 150 kHz to 30 MHz was searched. Emission levels under (Limit – 20 dB) was not recorded.

Note: The resolution bandwidth and video bandwidth of test receiver is 9 kHz for quasi-peak detection (QP) and average detection (AV) at frequency 0.15 MHz – 30 MHz.

Test Results

Please refer to Appendix B.

Appendix A: Test Results of Conducted Test

Test Result of 6 dB Bandwidth

802.11b

Channel	Channel Frequency (MHz)	6 dB Bandwidth (MHz)	Limit (MHz)	Result
Low Channel	2412	10.15	> 0.5	Pass
Middle Channel	2437	10.11	> 0.5	Pass
High Channel	2462	9.63	> 0.5	Pass

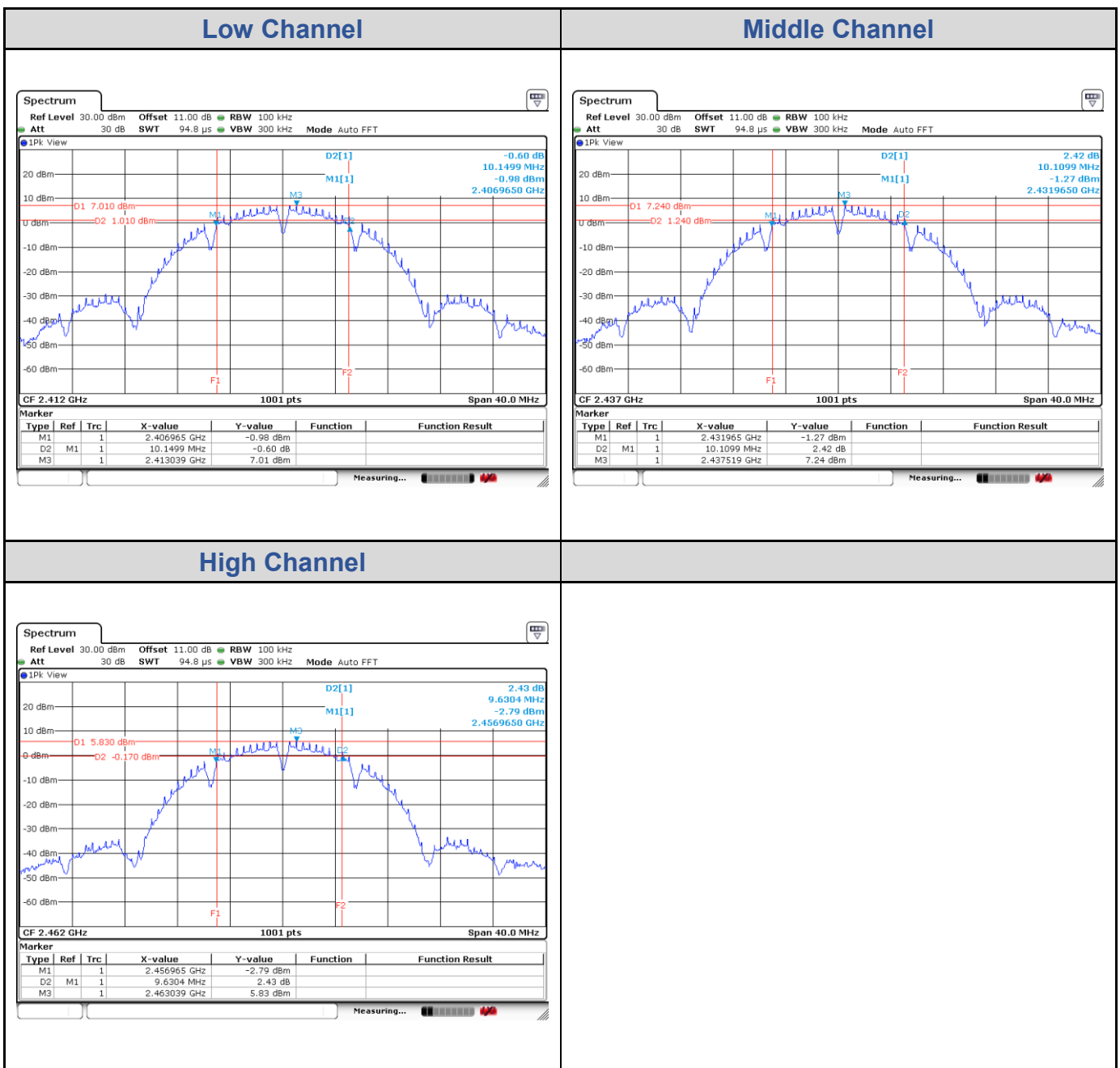

802.11g

Channel	Channel Frequency (MHz)	6 dB Bandwidth (MHz)	Limit (MHz)	Result
Low Channel	2412	16.34	> 0.5	Pass
Middle Channel	2437	16.38	> 0.5	Pass
High Channel	2462	16.38	> 0.5	Pass

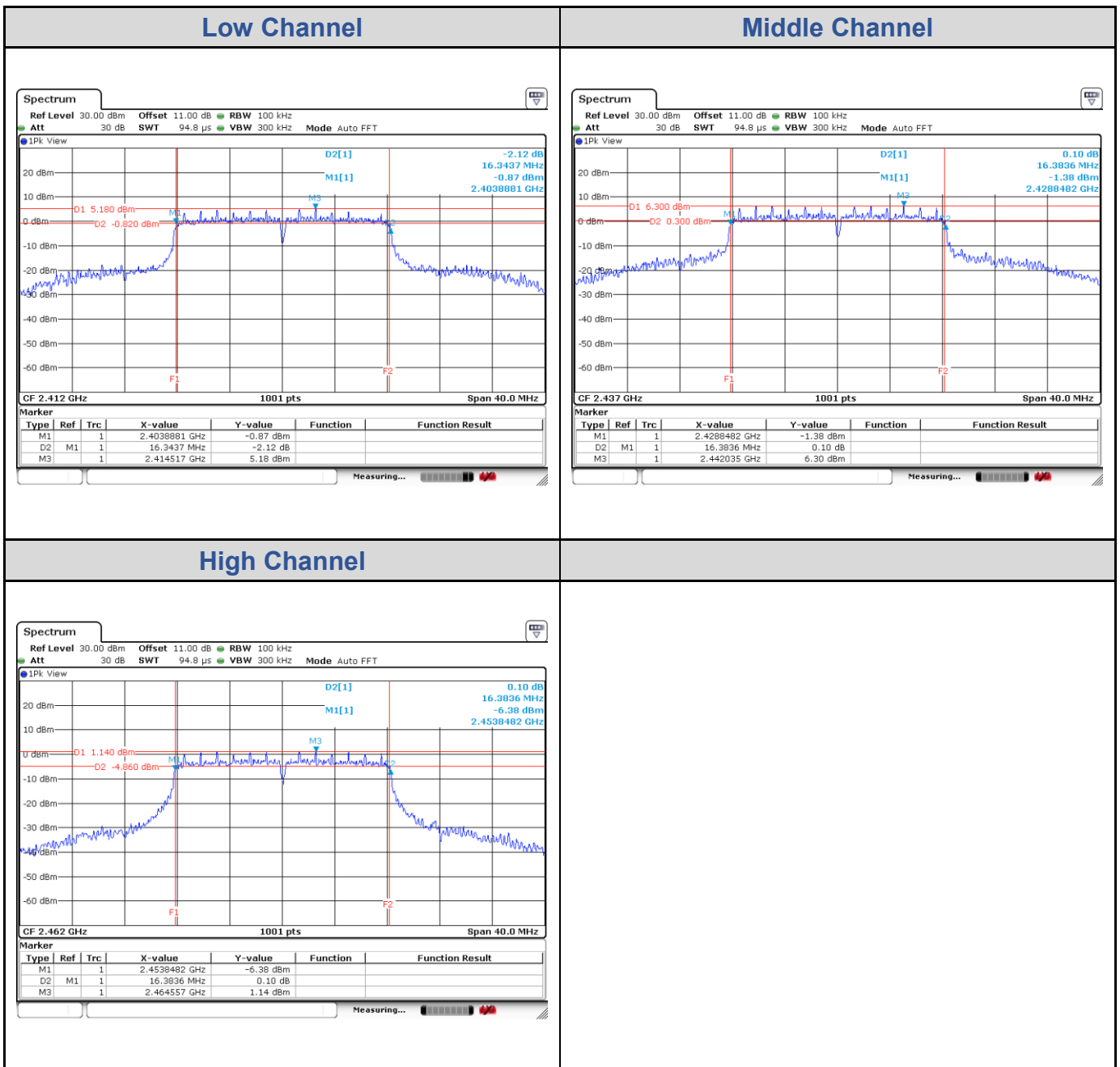

802.11n HT20

Channel	Channel Frequency (MHz)	6 dB Bandwidth (MHz)	Limit (MHz)	Result
Low Channel	2412	16.62	> 0.5	Pass
Middle Channel	2437	16.86	> 0.5	Pass
High Channel	2462	17.10	> 0.5	Pass

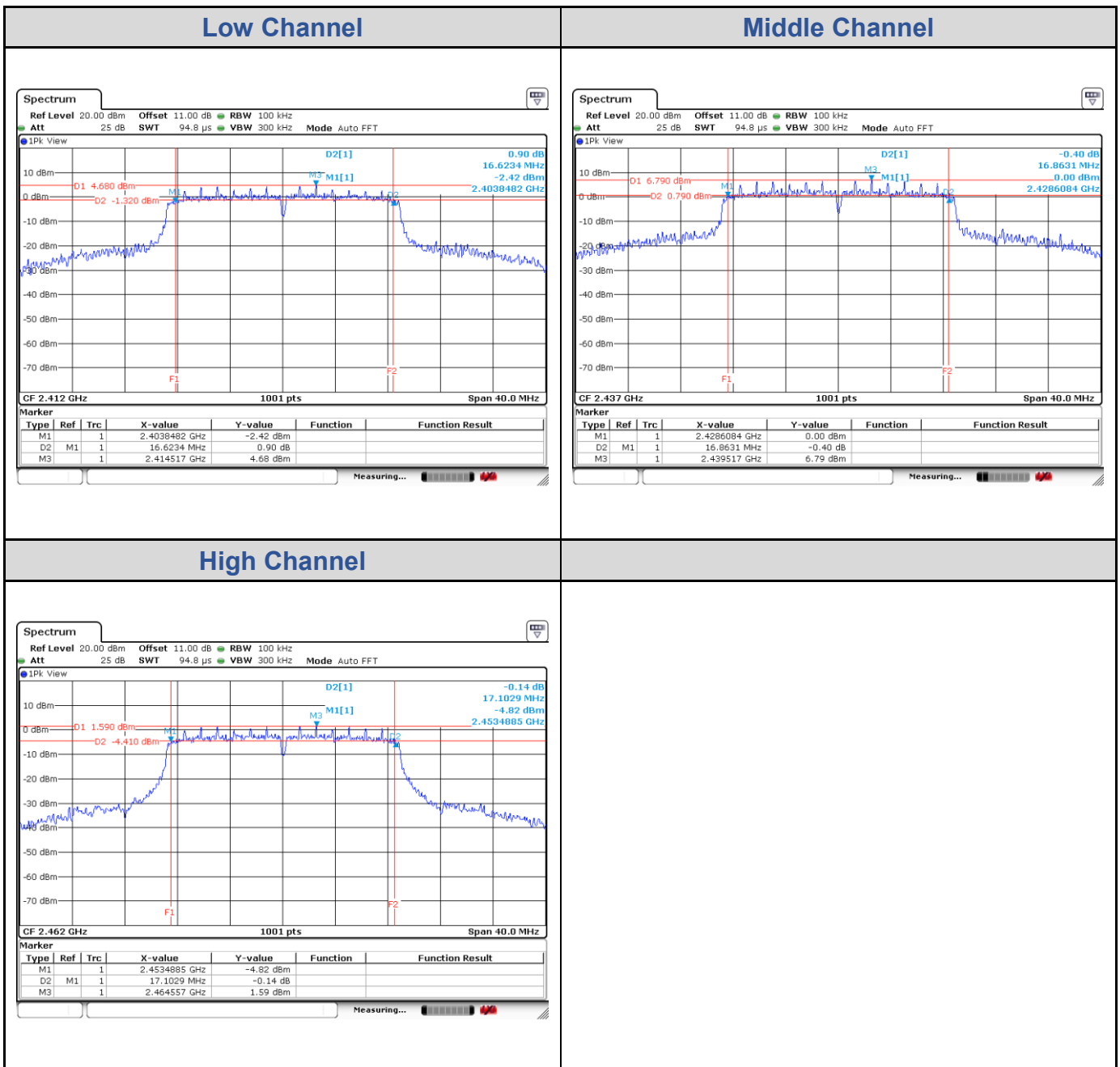

802.11n HT40

Channel	Channel Frequency (MHz)	6 dB Bandwidth (MHz)	Limit (MHz)	Result
Low Channel	2422	35.32	> 0.5	Pass
Middle Channel	2437	35.24	> 0.5	Pass
High Channel	2452	35.24	> 0.5	Pass

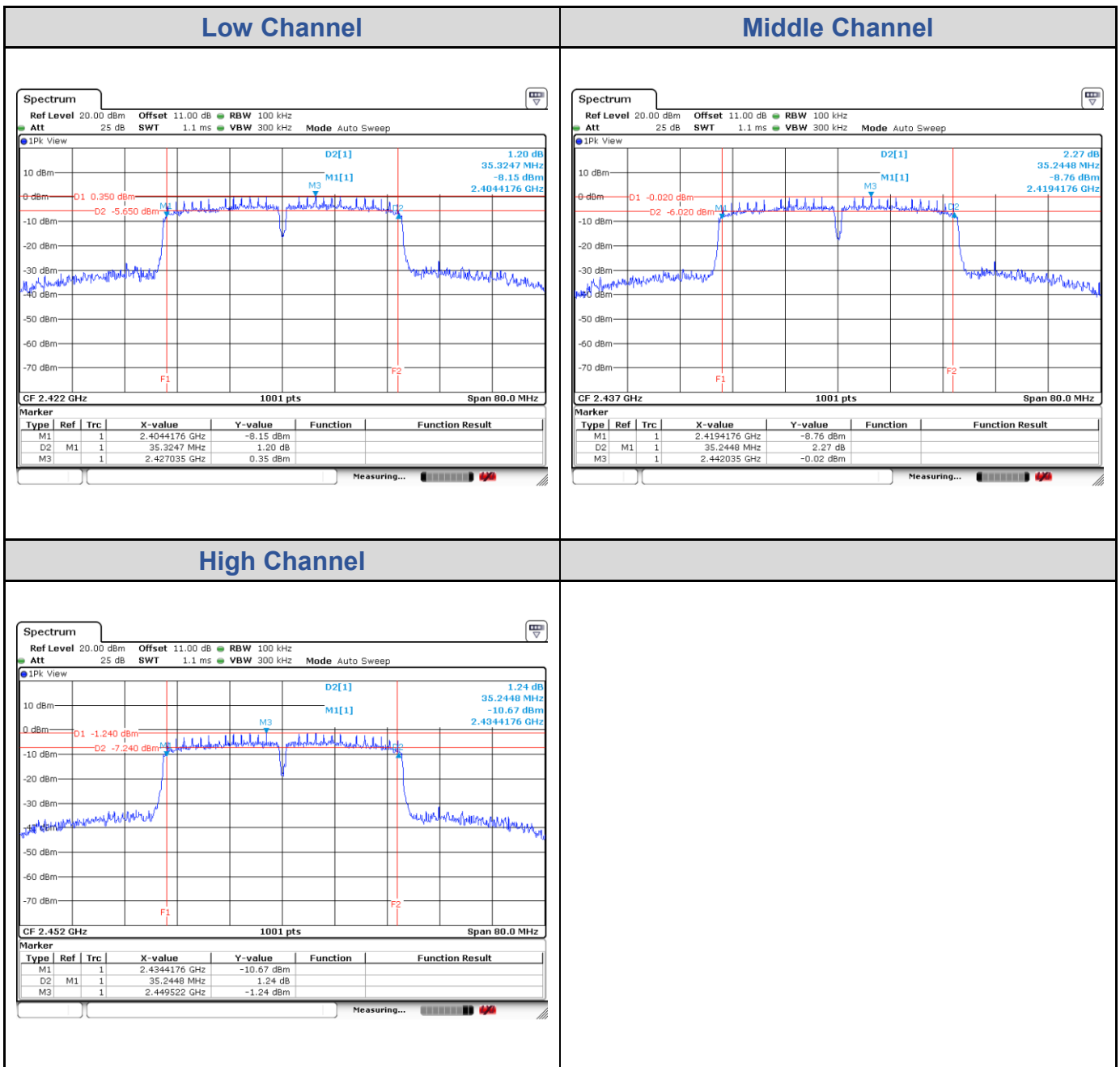

Test Result of 99% Occupied Bandwidth

802.11b

Channel	Channel Frequency (MHz)	99% Bandwidth (MHz)
Low Channel	2412	14.99
Middle Channel	2437	14.99
High Channel	2462	14.71

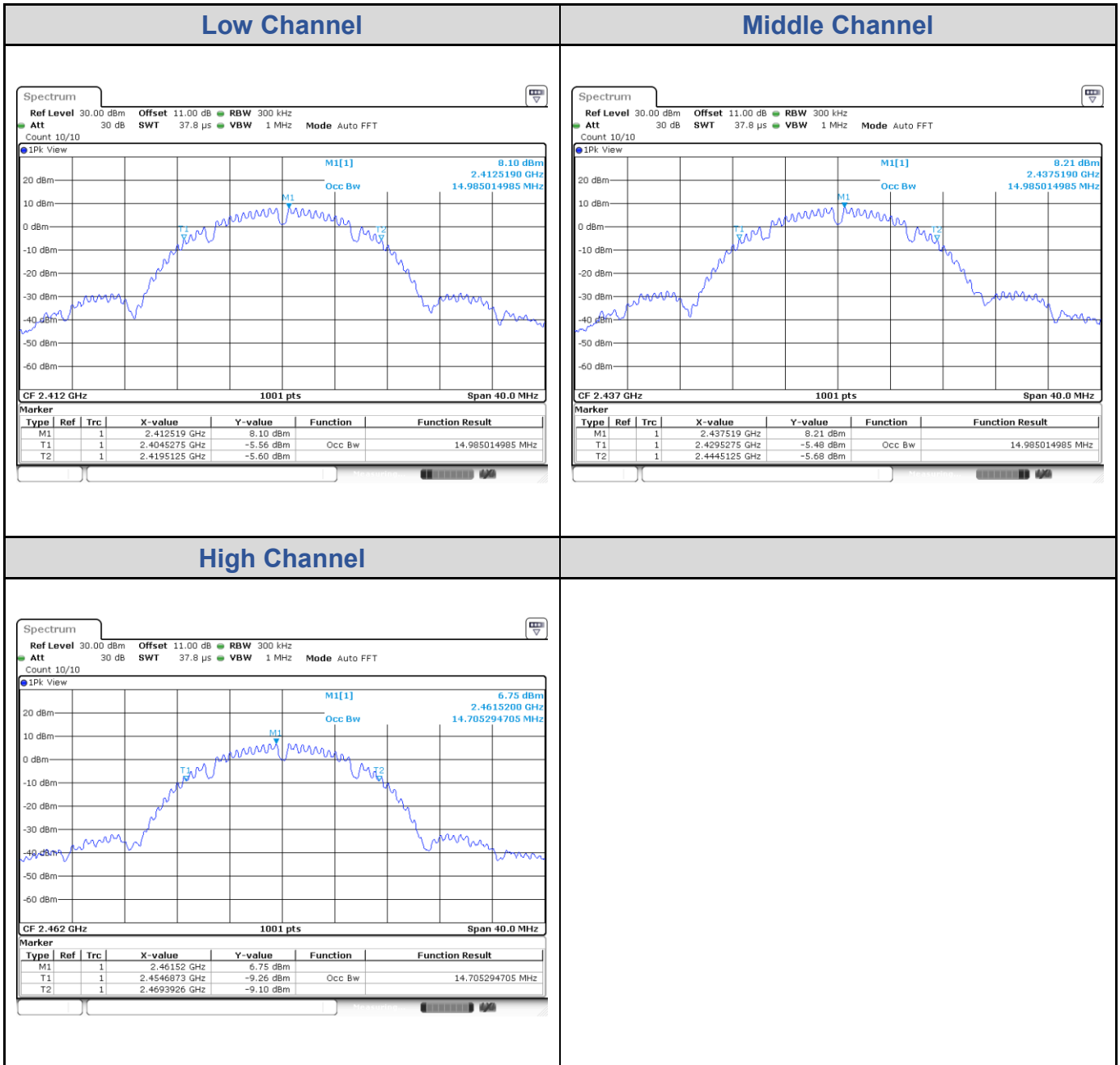

802.11g

Channel	Channel Frequency (MHz)	99% Bandwidth (MHz)
Low Channel	2412	17.86
Middle Channel	2437	21.18
High Channel	2462	16.86

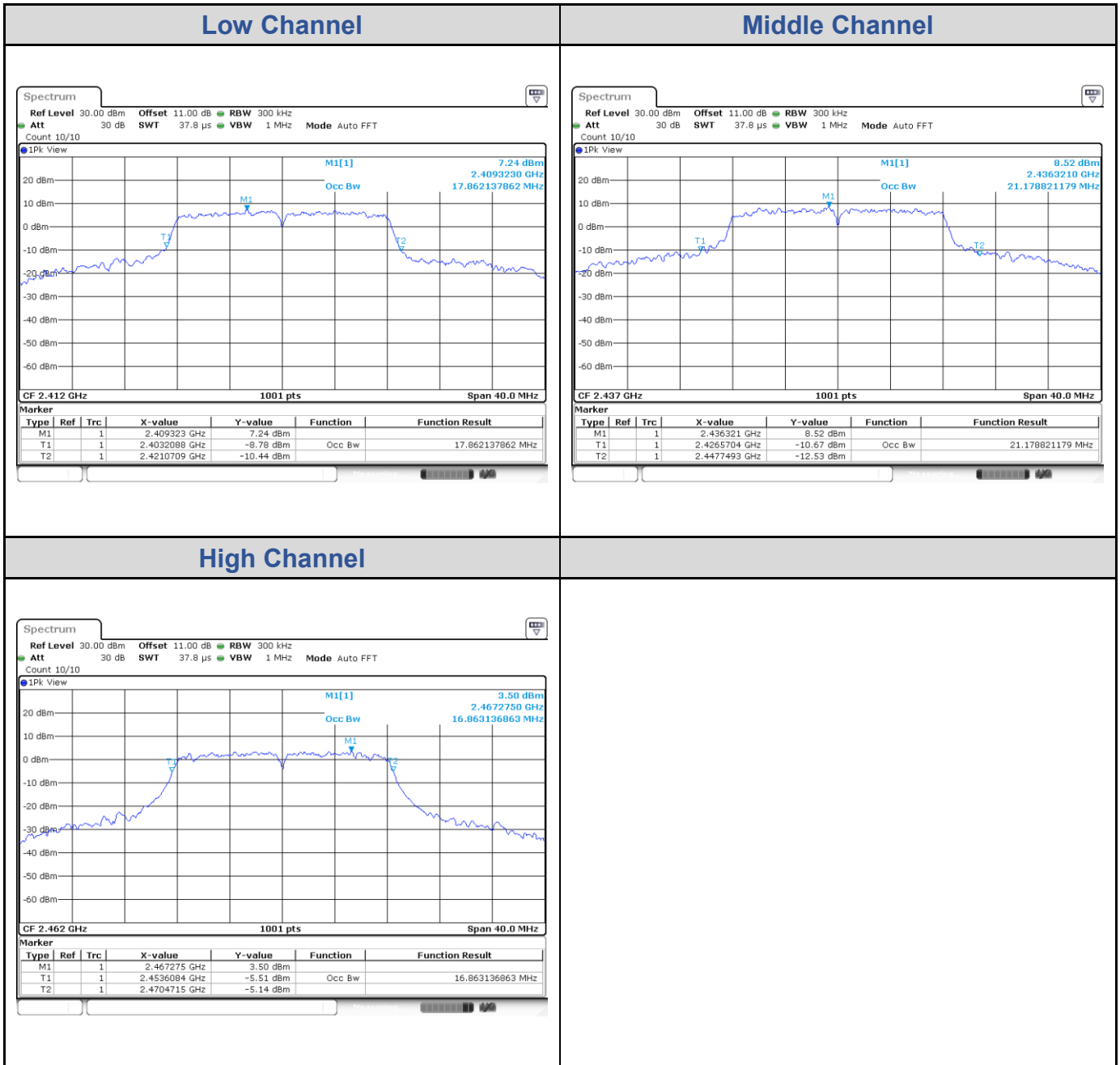

802.11n HT20

Channel	Channel Frequency (MHz)	99% Bandwidth (MHz)
Low Channel	2412	18.22
Middle Channel	2437	22.42
High Channel	2462	17.82

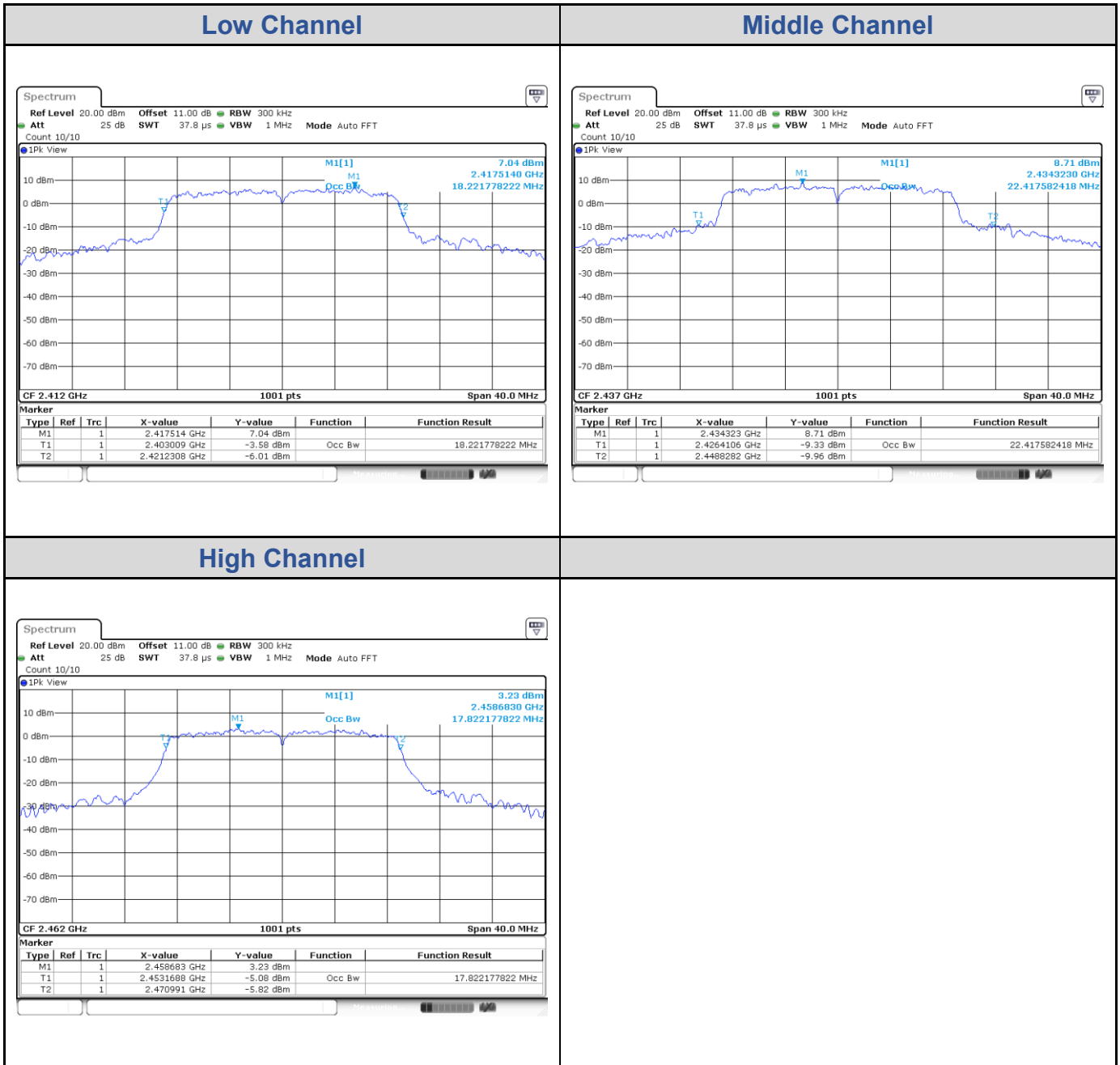

802.11n HT40

Channel	Channel Frequency (MHz)	99% Bandwidth (MHz)
Low Channel	2422	36.12
Middle Channel	2437	36.12
High Channel	2452	35.80

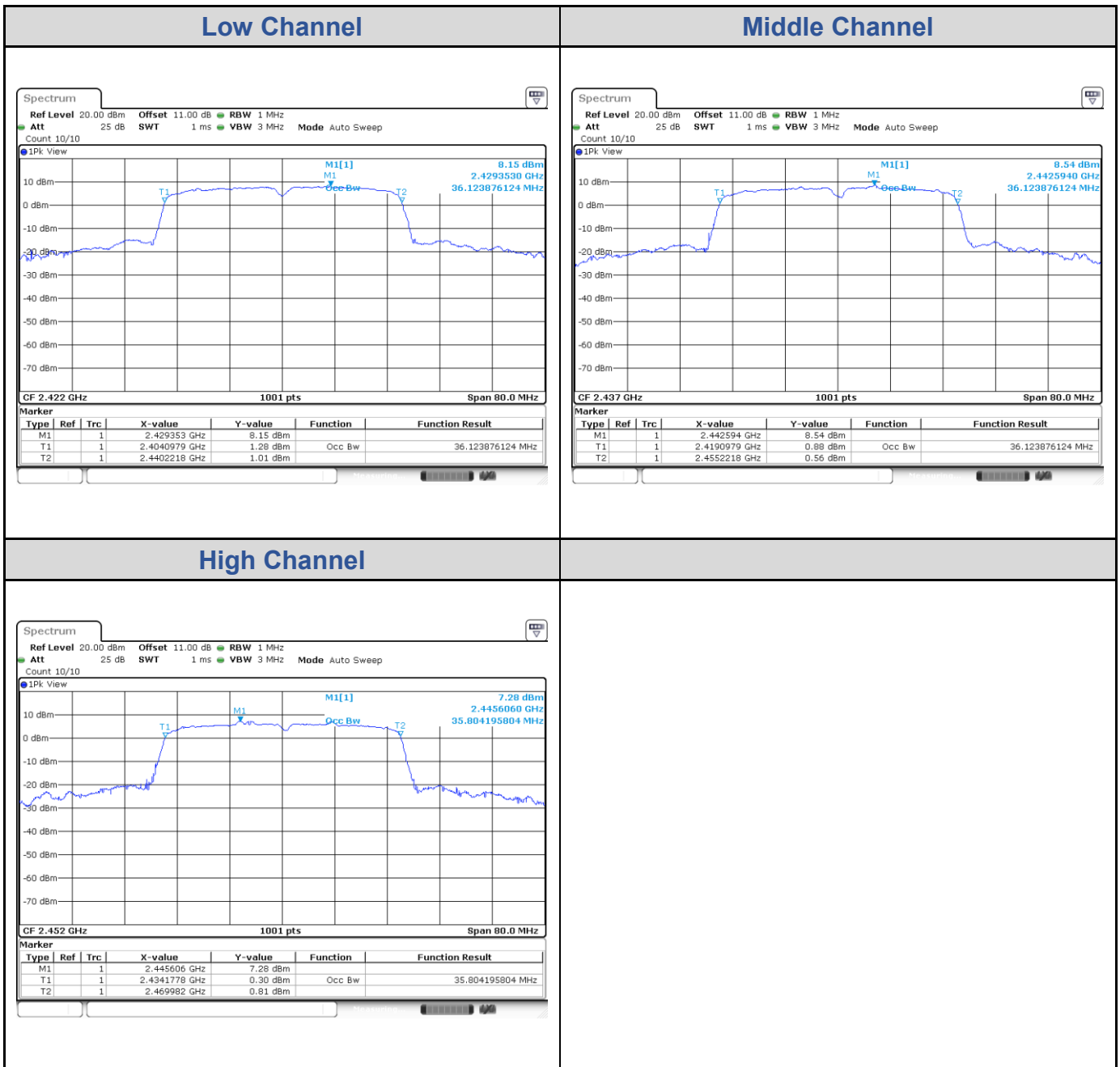

Test Result of Power Spectral Density

802.11b

Channel	Channel Frequency (MHz)	Power Density (dBm/3kHz)	Limit (dBm/3kHz)
Low Channel	2412	-5.00	8
Middle Channel	2437	-5.90	8
High Channel	2462	-5.73	8

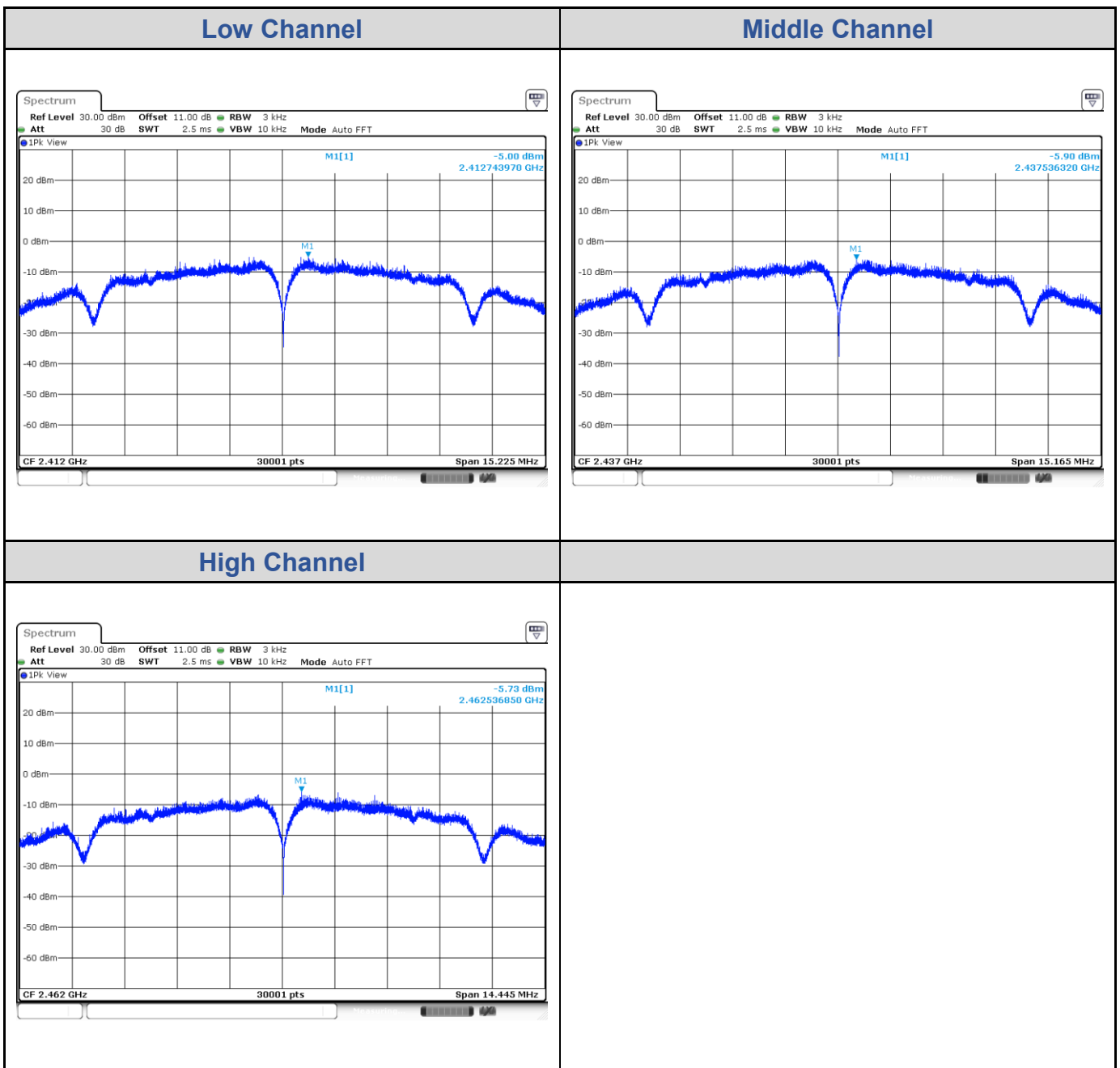

802.11g

Channel	Channel Frequency (MHz)	Power Density (dBm/3kHz)	Limit (dBm/3kHz)
Low Channel	2412	-9.11	8
Middle Channel	2437	-7.87	8
High Channel	2462	-12.53	8

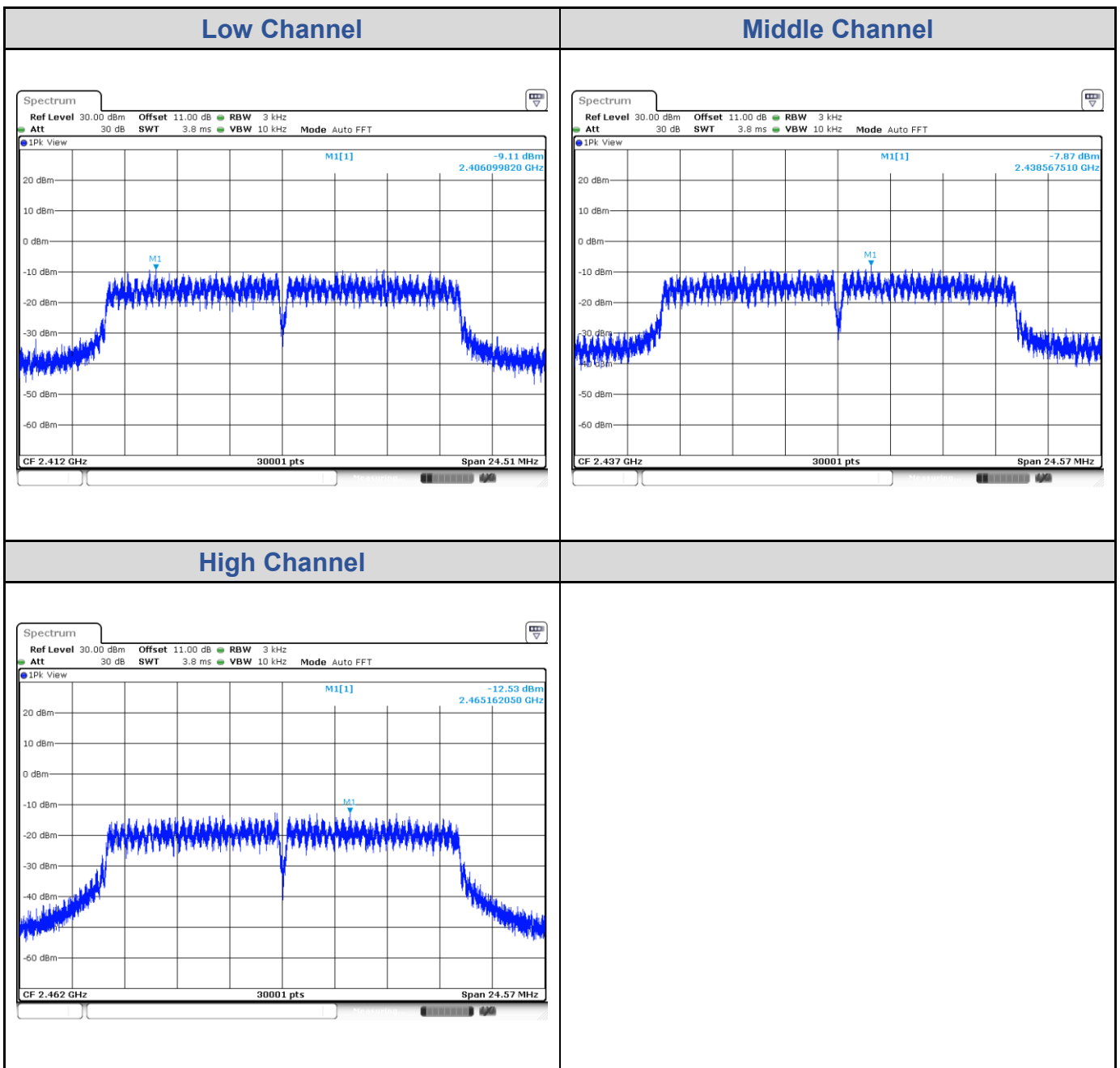

802.11n HT20

Channel	Channel Frequency (MHz)	Power Density (dBm/3kHz)	Limit (dBm/3kHz)
Low Channel	2412	-9.93	8
Middle Channel	2437	-7.36	8
High Channel	2462	-13.08	8

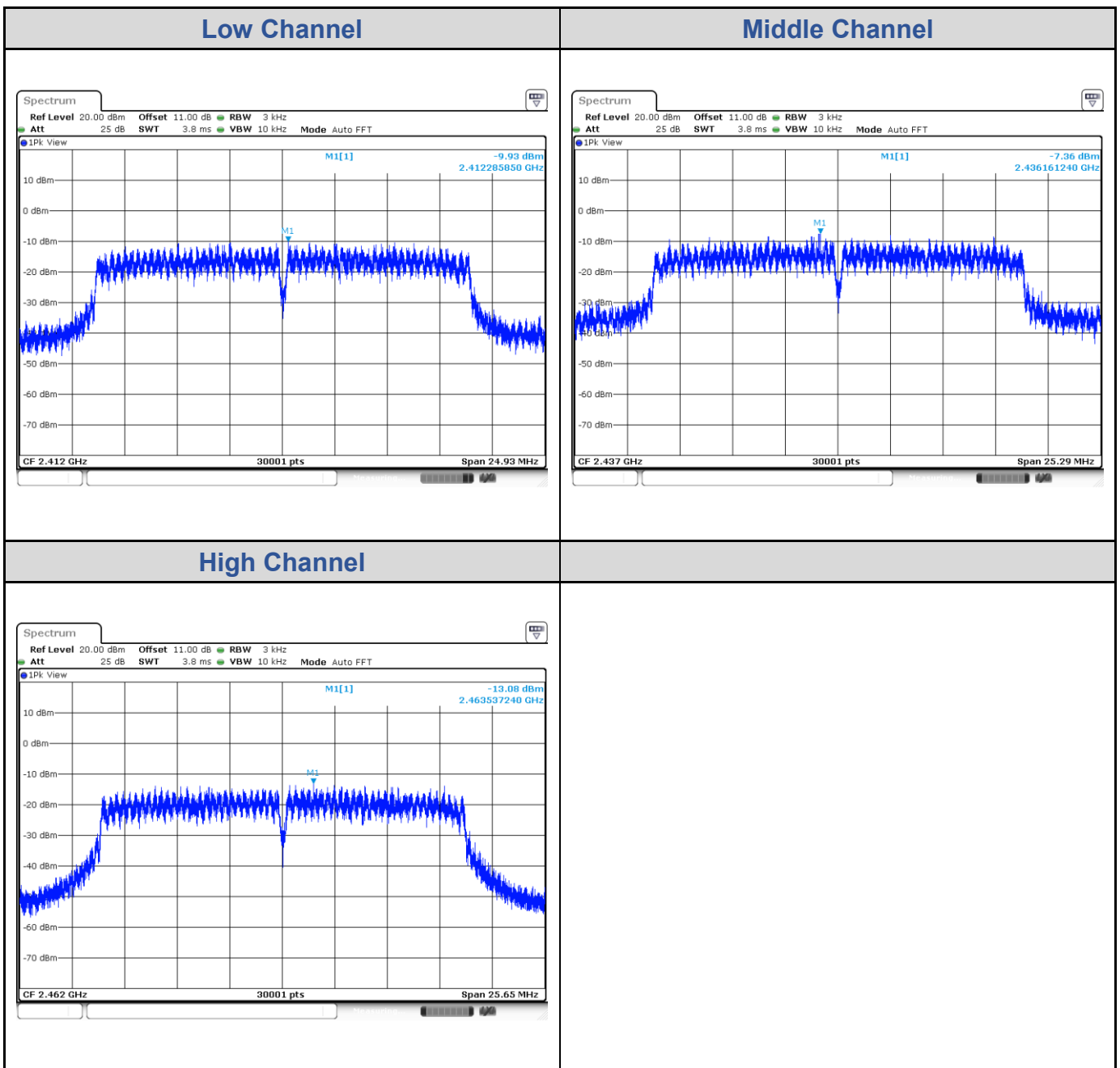

802.11n HT40

Channel	Channel Frequency (MHz)	Power Density (dBm/3kHz)	Limit (dBm/3kHz)
Low Channel	2422	-14.10	8
Middle Channel	2437	-13.79	8
High Channel	2452	-15.86	8

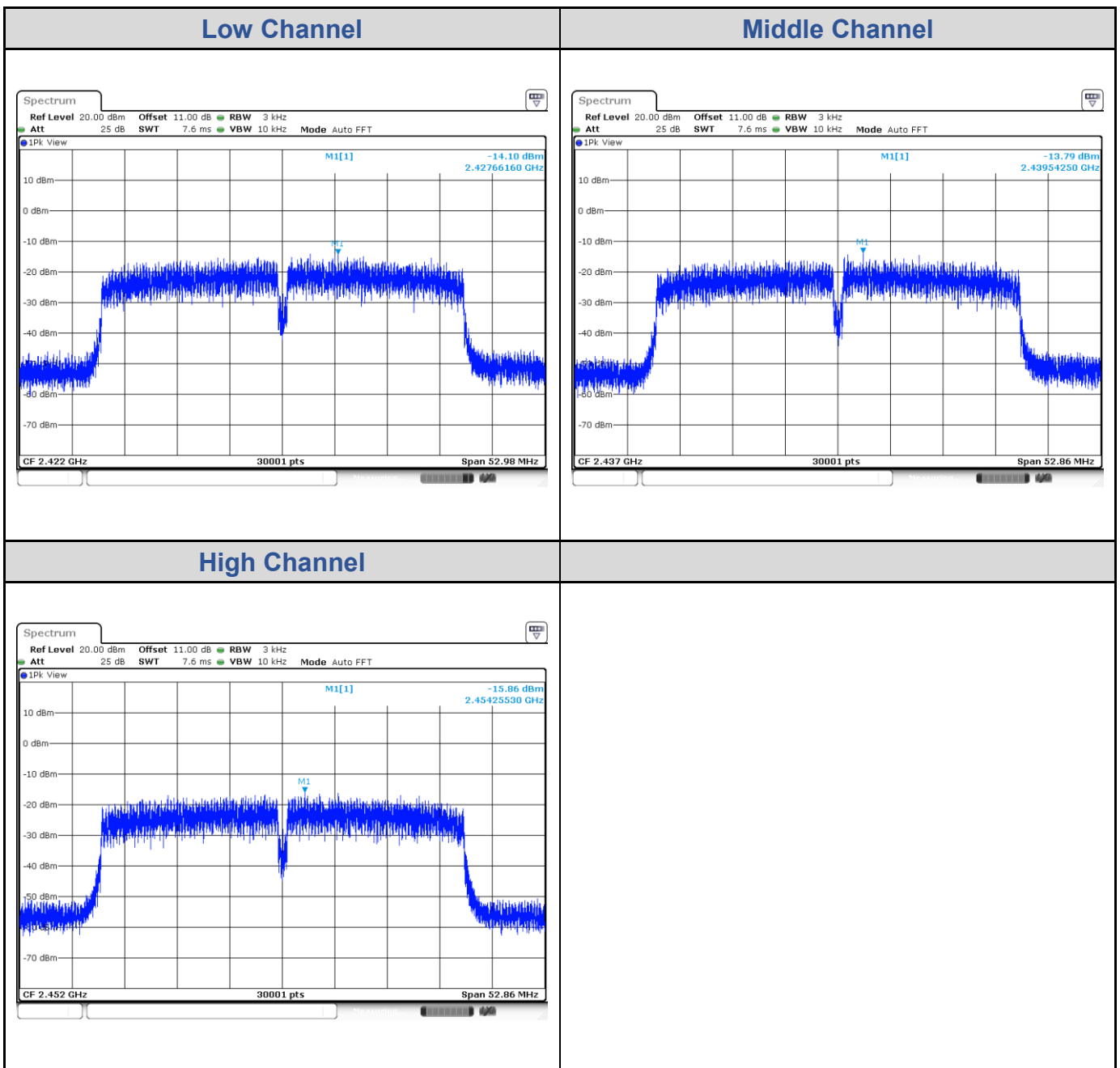

Test Result of Conducted Spurious Emissions 802.11b

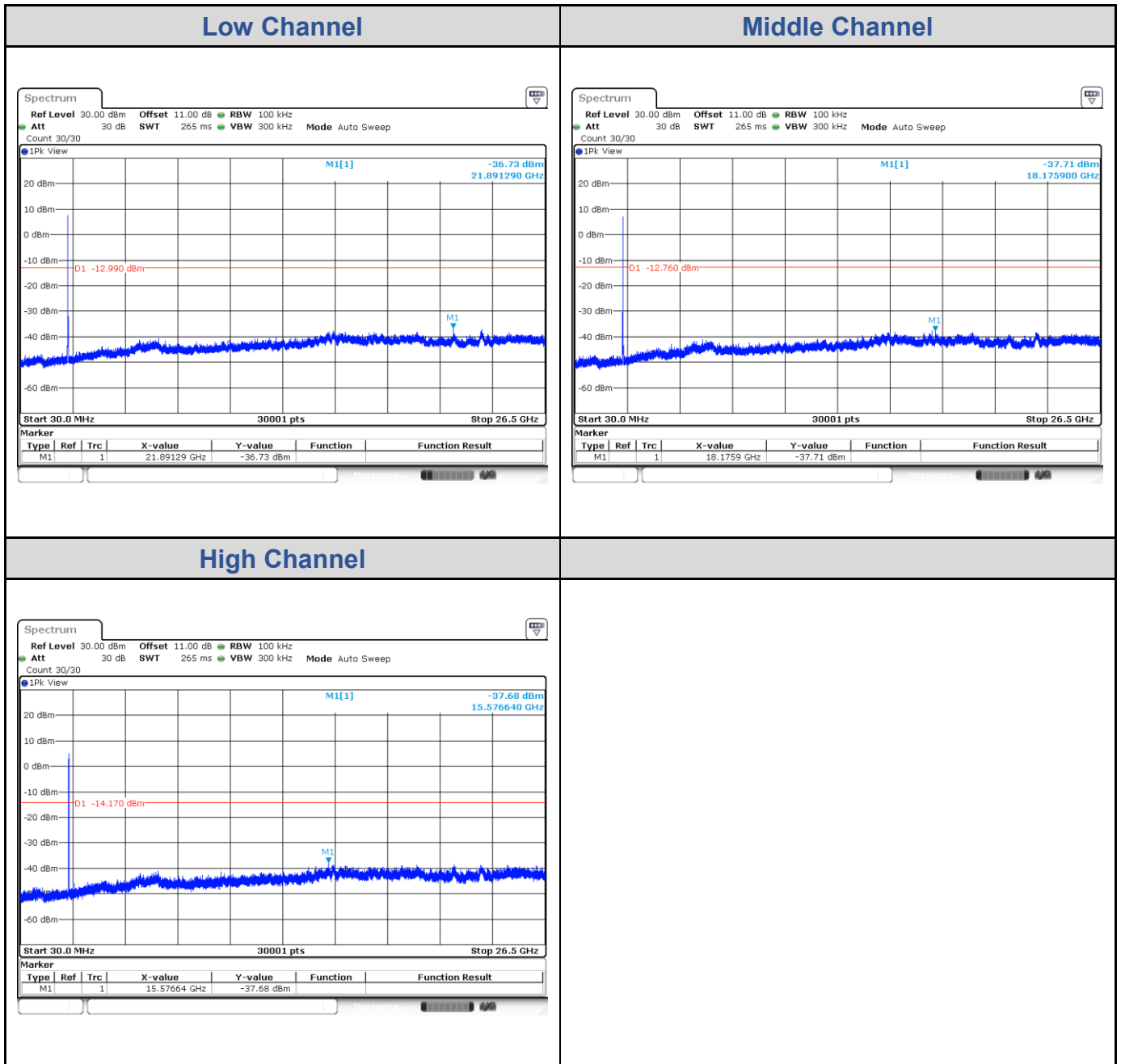

802.11g

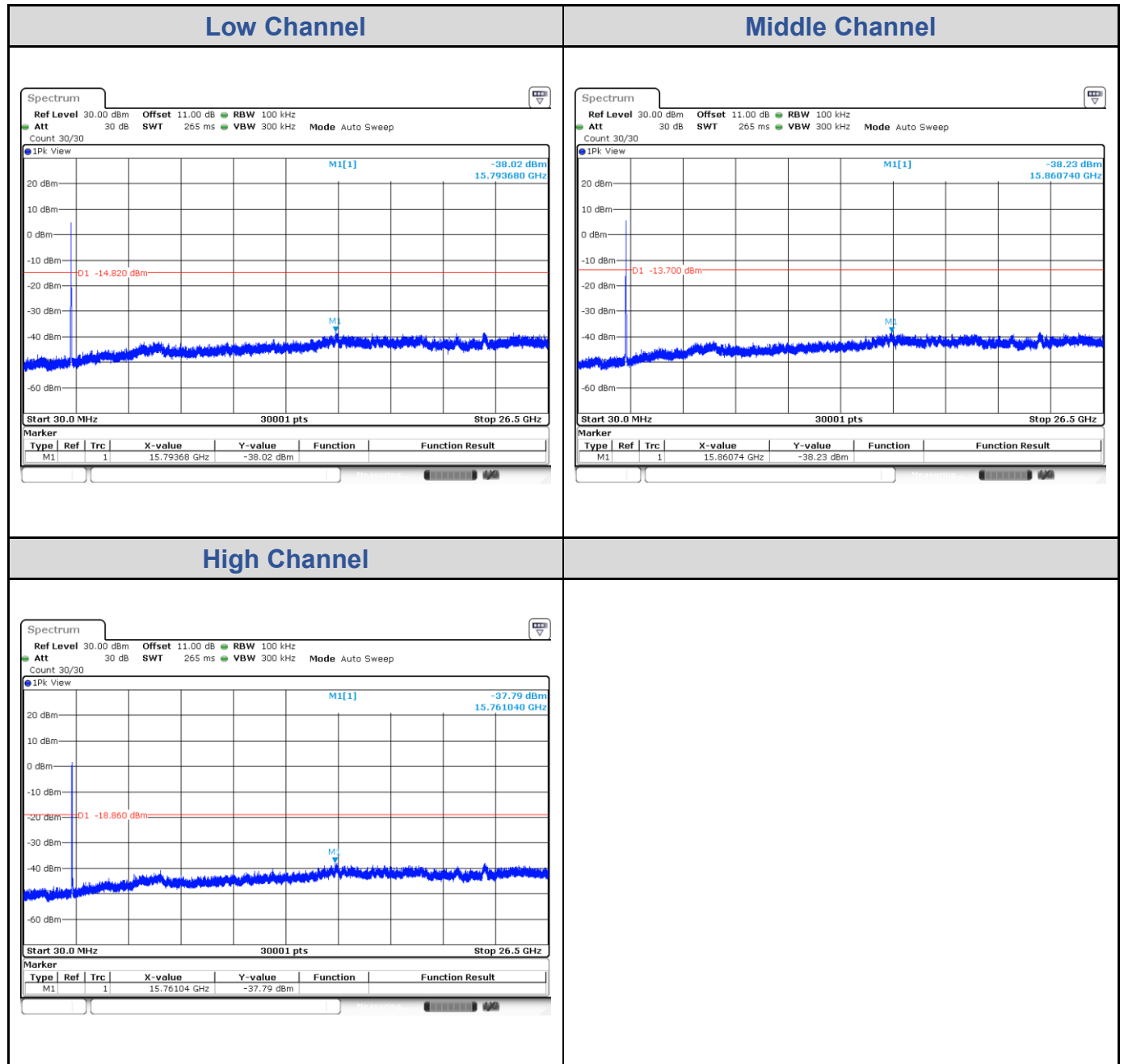

802.11n HT20

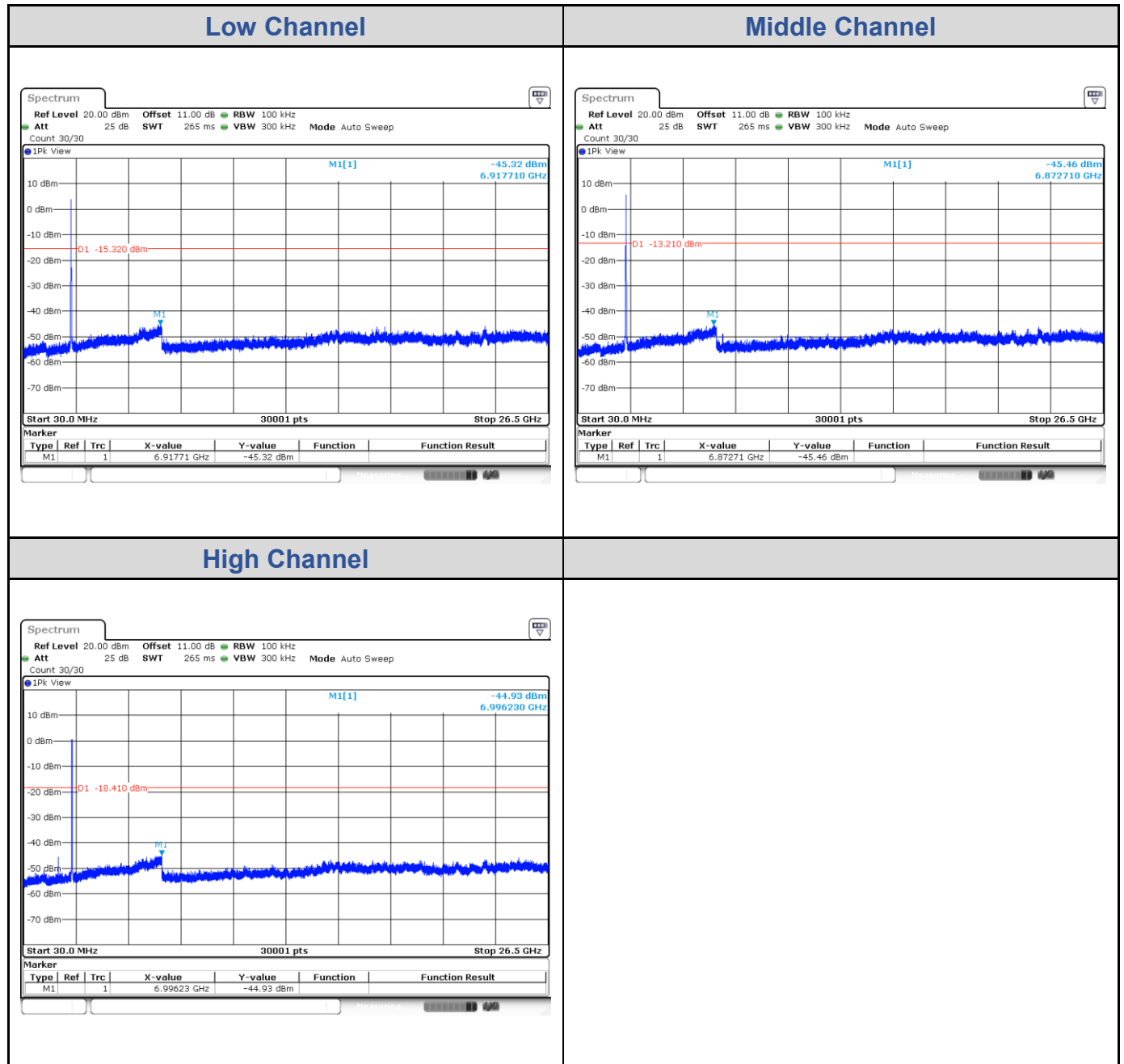

802.11n HT40

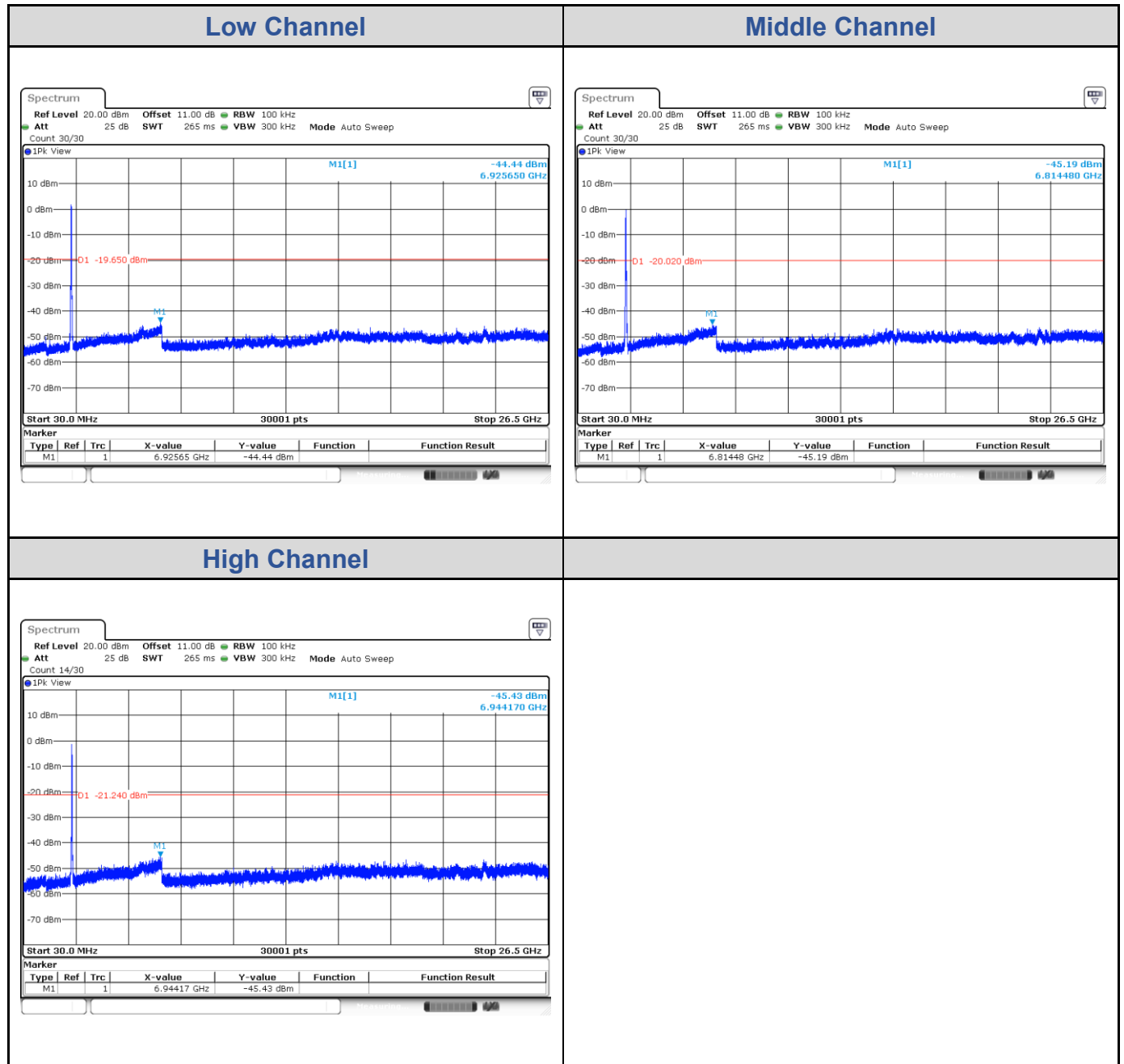

Test Result of Conducted Bandedge, Tx Mode

802.11b

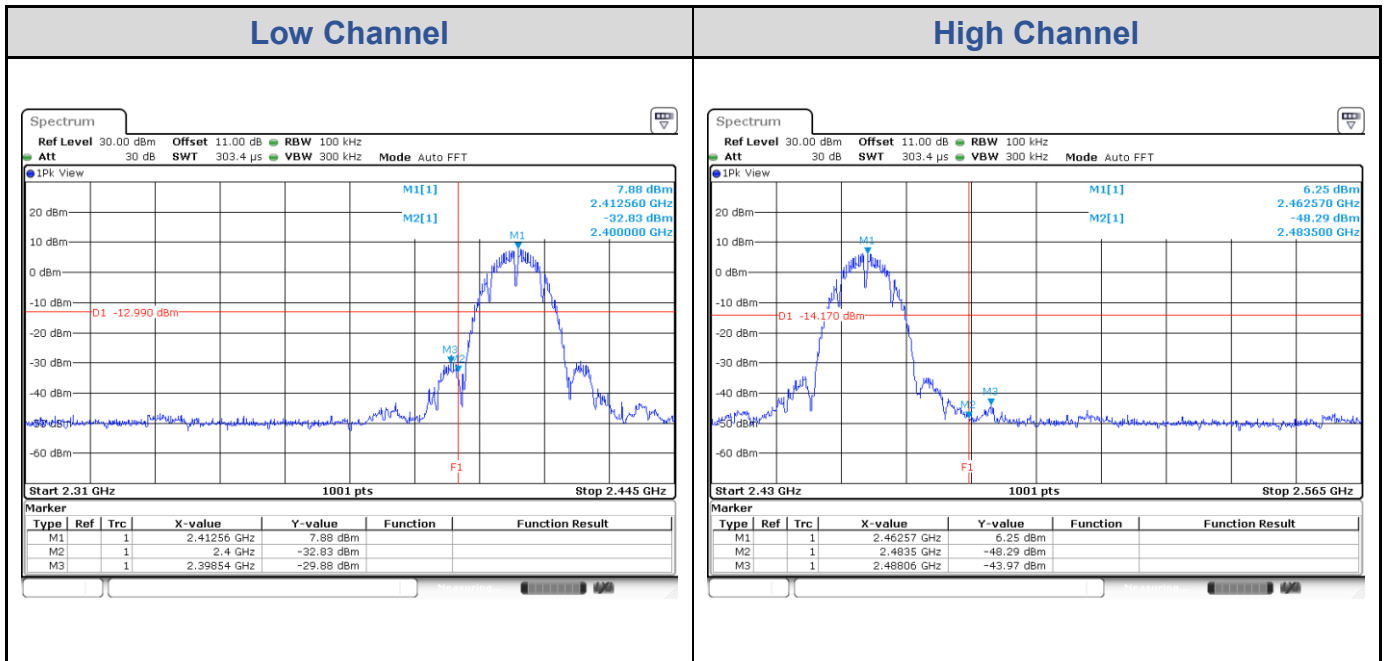

802.11g

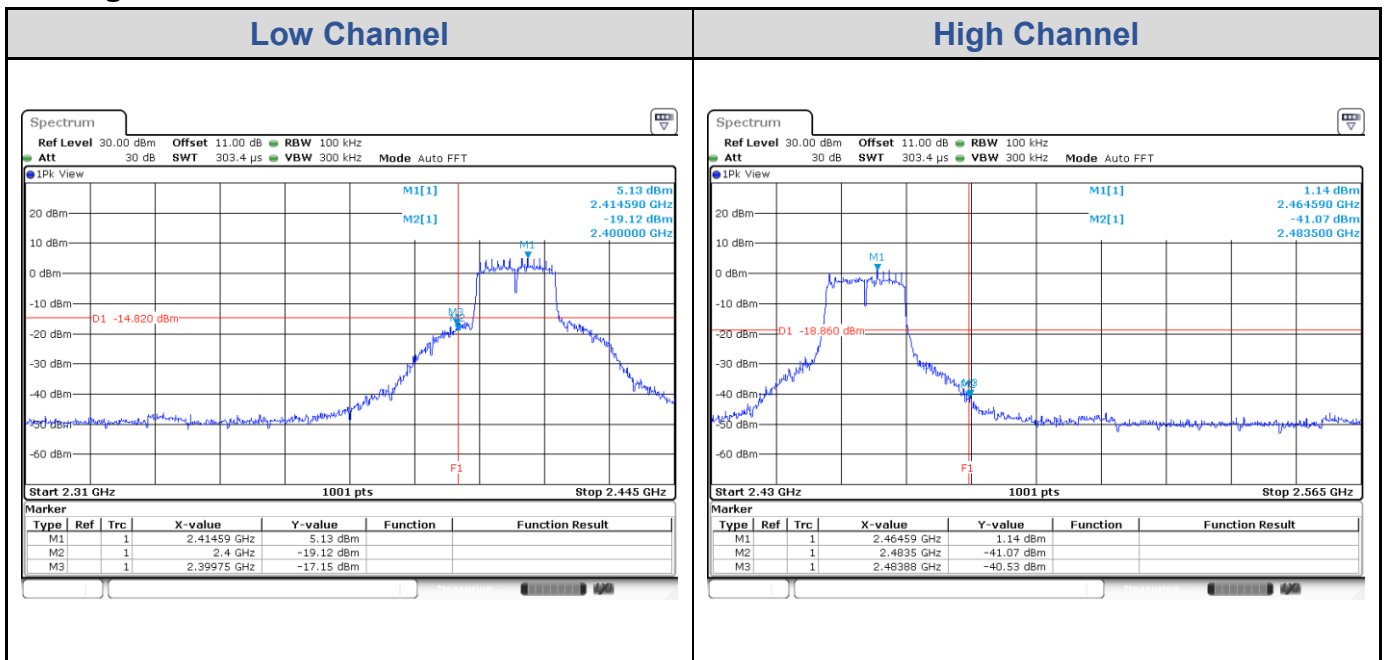

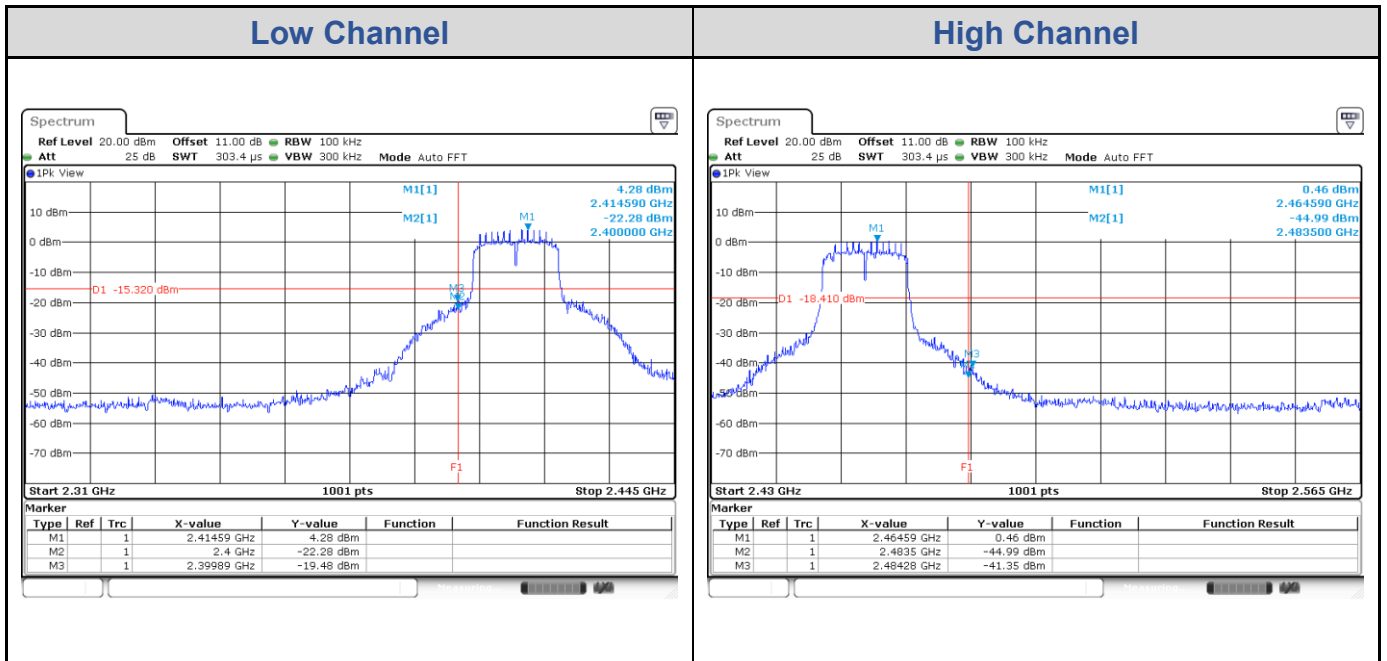
802.11n HT20

802.11n HT40
