



FCC TEST REPORT

**Test report
On Behalf of
Shenzhen Dericam Technology Co., Ltd
For
IP Camera
Model No.: S1, S1S, S1X, S2, S2S, S2X**

FCC ID: 2AAEU-S1

Prepared for : Shenzhen Dericam Technology Co., Ltd
RM533, Building A, HuaFeng Internet Creative Park, Gong He Industrial Rd, Xi Xiang Bao'AN, ShenZhen

Prepared By : Shenzhen HUAKE Testing Technology Co., Ltd.
F1-008, Tai Yi Building, No.1, Haicheng West Road, Xixiang Street, Bao'an District, Shenzhen City, China

Date of Test: August. 20, 2016 ~ August. 27, 2016

Date of Report: August. 28, 2016

Report Number: HK1600820024-E



TEST RESULT CERTIFICATION

Applicant's name : Shenzhen Dericam Technology Co., Ltd
 Address : RM533, Building A, HuaFeng Internet Creative Park, Gong He Industrial Rd, Xi Xiang Bao'AN, ShenZhen
Manufacture's Name..... : Shenzhen Dericam Technology Co., Ltd
 Address : RM533, Building A, HuaFeng Internet Creative Park, Gong He Industrial Rd, Xi Xiang Bao'AN, ShenZhen

Product description

Trade Mark: DERICAM
 Product name : IP Camera
 Model and/or type reference : S1, S1S, S1X, S2, S2S, S2X

Standards : FCC Rules and Regulations Part 15 Subpart C Section 15.247
 ANSI C63.10: 2013

This publication may be reproduced in whole or in part for non-commercial purposes as long as the Shenzhen HUAK Testing Technology Co., Ltd. is acknowledged as copyright owner and source of the material. Shenzhen HUAK Testing Technology Co., Ltd. takes no responsibility for and will not assume liability for damages resulting from the reader's interpretation of the reproduced material due to its placement and context.

Date of Test :
 Date (s) of performance of tests : **August. 20, 2016 ~ August. 27, 2016**
 Date of Issue..... : **August. 28, 2016**
 Test Result..... : **Pass**

Testing Engineer : 

 (Eric Xie)

Technical Manager : 

 (Dora Qin)

Authorized Signatory : 

 (Kait Chen)



Table of Contents	Page
1 . TEST SUMMARY	5
2 . GENERAL INFORMATION	6
2.1 GENERAL DESCRIPTION OF EUT	6
Operation of EUT during testing	7
2.2 DESCRIPTION OF TEST SETUP	7
2.3 MEASUREMENT INSTRUMENTS LIST	8
3 . CONDUCTED EMISSIONS TEST	9
3.1 Conducted Power Line Emission Limit	9
3.2 Test Setup	9
3.3 Test Procedure	9
3.4 Test Result	9
4 RADIATED EMISSION TEST	12
4.1 Radiation Limit	12
4.2 Test Setup	12
4.3 Test Procedure	13
4.4 Test Result	13
5 BAND EDGE	28
5.1 Limits	28
5.2 Test Procedure	28
5.3 Test Result	28
6 OCCUPIED BANDWIDTH MEASUREMENT	36
6.1 Test Limit	36
6.2 Test Procedure	36
6.3 Measurement Equipment Used	36
6.4 Test Result	36
7 POWER SPECTRAL DENSITY TEST	45
7.1 Test Limit	45
7.2 Test Procedure	45
7.3 Measurement Equipment Used	45
7.4 Test Result	45
8 PEAK OUTPUT POWER TEST	54
8.1 Test Limit	54
8.2 Test Procedure	54
8.3 Measurement Equipment Used	54



Table of Contents	Page
8.4 Test Result	54
9 ANTENNA REQUIREMENT	55
10 PHOTOGRAPH OF TEST	56
10.1 Radiated Emission	56
10.2 Conducted Emission	57



1. TEST SUMMARY

1.1 TEST PROCEDURES AND RESULTS

DESCRIPTION OF TEST	RESULT
CONDUCTED EMISSIONS TEST	COMPLIANT
RADIATED EMISSION TEST	COMPLIANT
BAND EDGE	COMPLIANT
OCCUPIED BANDWIDTH MEASUREMENT	COMPLIANT
POWER SPECTRAL DENSITY	COMPLIANT
PEAK OUTPUT POWER _{Peak}	COMPLIANT
ANTENNA REQUIREMENT	COMPLIANT

1.2 TEST FACILITY

Test Firm : Dongguan Dongdian Testing Service Co., Ltd
Certificated by FCC, Registration No.: 270092

Address No.17 Zongbu road 2, Songshan Lake Sci&Tech Park, DongGuan
City, Guangdong province,523808 China

1.3 MEASUREMENT UNCERTAINTY

Measurement Uncertainty	
Conducted Emission Expanded Uncertainty	= 2.23dB, k=2
Radiated emission expanded uncertainty(9kHz-30MHz)	= 3.08dB, k=2
Radiated emission expanded uncertainty(30MHz-1000MHz)	= 4.42dB, k=2
Radiated emission expanded uncertainty(Above 1GHz)	= 4.06dB, k=2



2. GENERAL INFORMATION

2.1 GENERAL DESCRIPTION OF EUT

Equipment	IP Camera
Model Name	S1
Serial No	S1S, S1X, S2, S2S, S2X
Model Difference	All model's the function, software and electric circuit are the same, only with a product color and model named different. Test sample model: S1.
FCC ID	2AAEU-S1
Antenna Type	Integral Antenna
Antenna Gain	1 dBi
BT Operation frequency	802.11b/g/n 20:2412~2462 MHz 802.11n 40: 2422~2452MHz
Number of Channels	802.11b/g/n20: 11CH 802.11n 40: 7CH
Modulation Type	CCK/OFDM/DBPSK/DAPSK
Power Source	AC Adapter mode:ADS-25FSG-12 12018GPCN
Power Rating	DC 12V for adapter with AC 120V/60Hz



2.1.1 Carrier Frequency of Channels

Channel List for 802.11b/g/n(20MHz)							
Channel	Frequency (MHz)	Channel	Frequency (MHz)	Channel	Frequency (MHz)	Channel	Frequency (MHz)
01	2412	04	2427	07	2442	10	2457
02	2417	05	2432	08	2447	11	2462
03	2422	06	2437	09	2452		

Channel List for 802.11n(40MHz)							
Channel	Frequency (MHz)	Channel	Frequency (MHz)	Channel	Frequency (MHz)	Channel	Frequency (MHz)
03	2422	06	2437	09	2452		
04	2427	07	2442				
05	2432	08	2447				

Operation of EUT during testing

Operating Mode

The mode is used: **Transmitting mode for 802.11b/g/n(20MHz)**

Low Channel: 2412MHz

Middle Channel: 2437MHz

High Channel: 2462MHz

Transmitting mode for 802.11n(40MHz)

Low Channel: 2422MHz

Middle Channel: 2437MHz

High Channel: 2452MHz

2.2 DESCRIPTION OF TEST SETUP

Operation of EUT during conducted and Radiation testing:

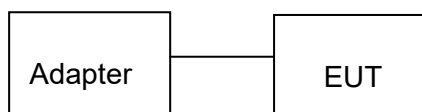



2.3 MEASUREMENT INSTRUMENTS LIST

Item	Equipment	Manufacturer	Model No.	Serial No.	Last Cal.	Cal. Interval
1.	EMI Receiver	Rohde & Schwarz	ESCI	100627	Feb. 19, 2016	1 Year
2.	LISN	SchwarzBeck	NSLK 8126	8126377	Feb. 19, 2016	1 Year
3.	RF Switching Unit	Compliance Direction	RSU-M2	38303	Feb. 19, 2016	1 Year
4.	EMI Test Software ES-K1	Rohde & Schwarz	N/A	N/A	N/A	N/A
5.	EMI Test Receiver	Rohde & Schwarz	ESCI	100627	Feb. 19, 2016	1 Year
6.	Trilog Broadband Antenna	Schwarzbeck	VULB9163	VULB 9163-289	Feb. 19, 2016	1 Year
7.	Pre-amplifier	Compliance Direction	PAP-0203	22008	Feb. 19, 2016	1 Year
8.	EMI Test Software EZ-EMC	SHURPLE	N/A	N/A	N/A	N/A
9.	EMI Receiver	Rohde & Schwarz	ESCI	100627	Feb. 19, 2016	1 Year
10.	LISN	SchwarzBeck	NSLK 8126	8126377	Feb. 19, 2016	1 Year
11.	RF Switching Unit	Compliance Direction	RSU-M2	38303	Feb. 19, 2016	1 Year
12.	EMI Test Software ES-K1	Rohde & Schwarz	N/A	N/A	N/A	N/A
13.	EMI Receiver	Rohde & Schwarz	ESCI	100627	Feb. 19, 2016	1 Year
14.	EMI Receiver	Rohde & Schwarz	ESCI	100627	Feb. 19, 2016	1 Year
15.	LISN	SchwarzBeck	NSLK 8126	8126377	Feb. 19, 2016	1 Year
16.	RF Switching Unit	Compliance Direction	RSU-M2	38303	Feb. 19, 2016	1 Year
17.	EMI Test Software ES-K1	Rohde & Schwarz	N/A	N/A	N/A	N/A
18.	Power Meter	R&S	NRVD	SEL0069	Feb. 19, 2016	1 Year
19.	Power Sensor	R&S	URV5-Z2	SEL0071	Feb. 19, 2016	1 Year
20.	Power Sensor	R&S	URV5-Z2	SEL0072	Feb. 19, 2016	1 Year
21.	Software EMC32	R&S	EMC32-S	SEL0082	N/A	N/A
22.	Log-periodic Antenna	Amplifier Reasearch	AS180	SEL0073	N/A	N/A
23.	Antenna Tripod	Amplifier Reasearch	TS1000A	SEL0074	N/A	N/A
24.	High Gain Horn Antenna(0.8-5GHz)	Amplifier Reasearch	AT4002A	SEL0075	N/A	N/A
25.	Spectrum analyzer	Agilent	N9020A	MY499110 048	Feb. 19, 2016	1 Year
26.	Spectrum analyzer	Agilent	E4407B	MY461843 26	Feb. 19, 2016	1 Year



3. CONDUCTED EMISSIONS TEST

3.1 Conducted Power Line Emission Limit

For unintentional device, according to § 15.107(a) Line Conducted Emission Limits is as following

Frequency (MHz)	Maximum RF Line Voltage (dBµV)			
	CLASS A		CLASS B	
	Q.P.	Ave.	Q.P.	Ave.
0.15 - 0.50	79	66	66-56*	56-46*
0.50 - 5.00	73	60	56	46
5.00 - 30.0	73	60	60	50

* Decreasing linearly with the logarithm of the frequency

For intentional device, according to §15.207(a) Line Conducted Emission Limit is same as above table.

3.2 Test Setup

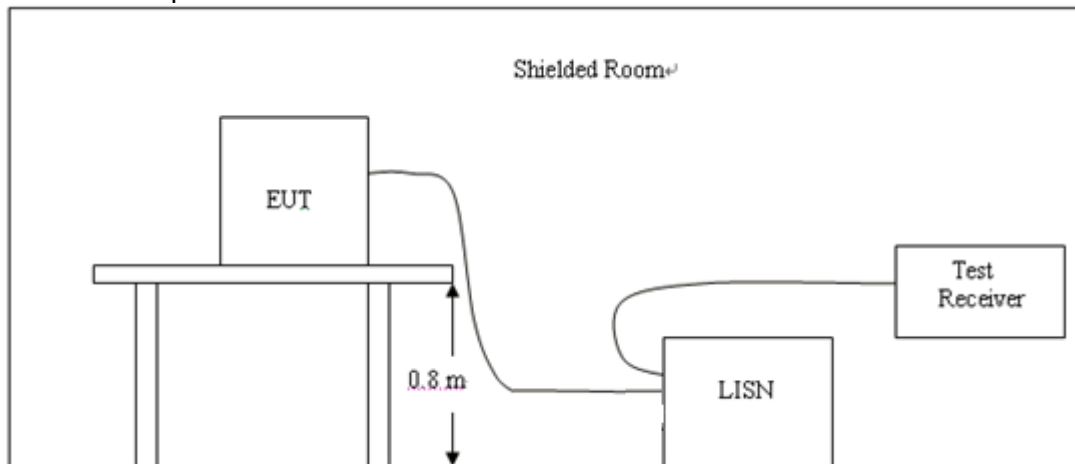

3.3 Test Procedure

- 1, The equipment was set up as per the test configuration to simulate typical actual usage per the user's manual. The EUT is a tabletop system, a wooden table with a height of 0.8 meters is used and is placed on the ground plane as per ANSI C63.10.
- 2, Support equipment, if needed, was placed as per ANSI C63.10.
- 3, All I/O cables were positioned to simulate typical actual usage as per ANSI C63.10.
- 4, If a EUT received DC power from the USB Port of Notebook PC, the PC's adapter received AC120V/60Hz power through a Line Impedance Stabilization Network (LISN) which supplied power source and was grounded to the ground plane.
- 5, All support equipments received AC power from a second LISN, if any.
- 6, The EUT test program was started. Emissions were measured on each current carrying line of the EUT using a spectrum Analyzer / Receiver connected to the LISN powering the EUT. The LISN has two monitoring points: Line 1 (Hot Side) and Line 2 (Neutral Side). Two scans were taken: one with Line 1 connected to Analyzer / Receiver and Line 2 connected to a 50 ohm load; the second scan had Line 1 connected to a 50 ohm load and Line 2 connected to the Analyzer / Receiver.
- 7, Analyzer / Receiver scanned from 150 KHz to 30MHz for emissions in each of the test modes.

3.4 Test Result

PASS

All the test modes completed for test.

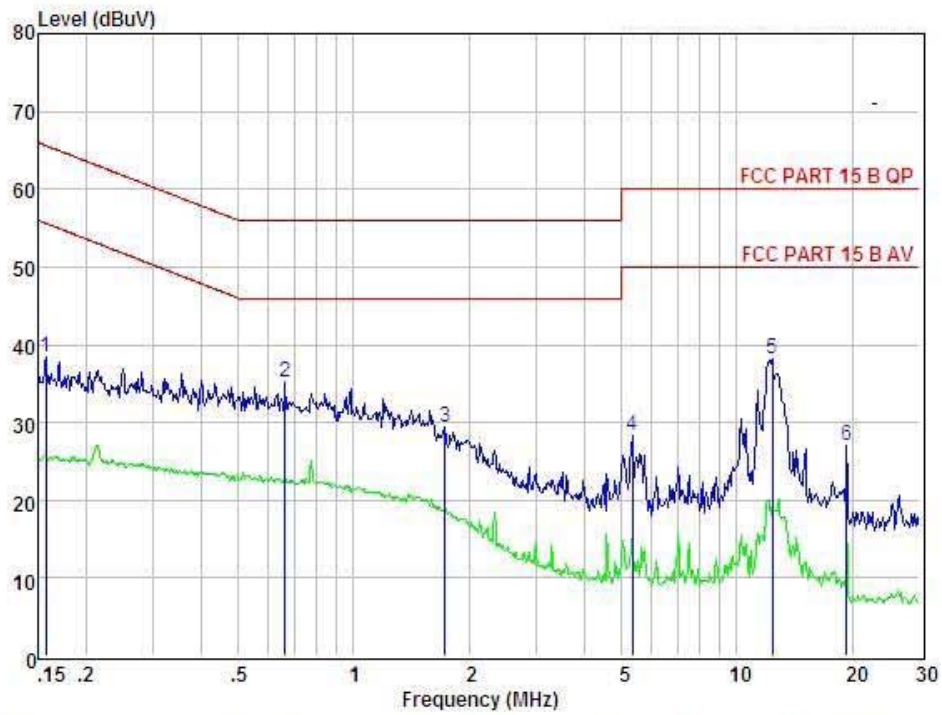

Condition		: FCC PART 15 B QP				POL: LINE	Temp: 25.7 °C	Hum: 51 %		
Item	Freq MHz	Read Level dBuV	LISN Factor dB	Preamp Factor dB	Cable Loss dB	Level dBuV	Limit dBuV	Margin dBuV	Remark	
1	0.157	28.78	0.03	-9.52	0.10	38.30	65.60	-27.30	Peak	
2	0.661	25.58	0.00	-9.59	0.10	35.17	56.00	-20.83	Peak	
3	1.734	19.64	0.05	-9.70	0.10	29.34	56.00	-26.66	Peak	
4	5.333	18.47	0.08	-9.94	0.12	28.41	60.00	-31.59	Peak	
5	12.384	28.19	0.24	-9.90	0.22	38.09	60.00	-21.91	Peak	
6	19.326	17.19	0.37	-9.81	0.38	27.00	60.00	-33.00	Peak	

Remark: Level = Read Level + LISN Factor - Preamp Factor + Cable Loss

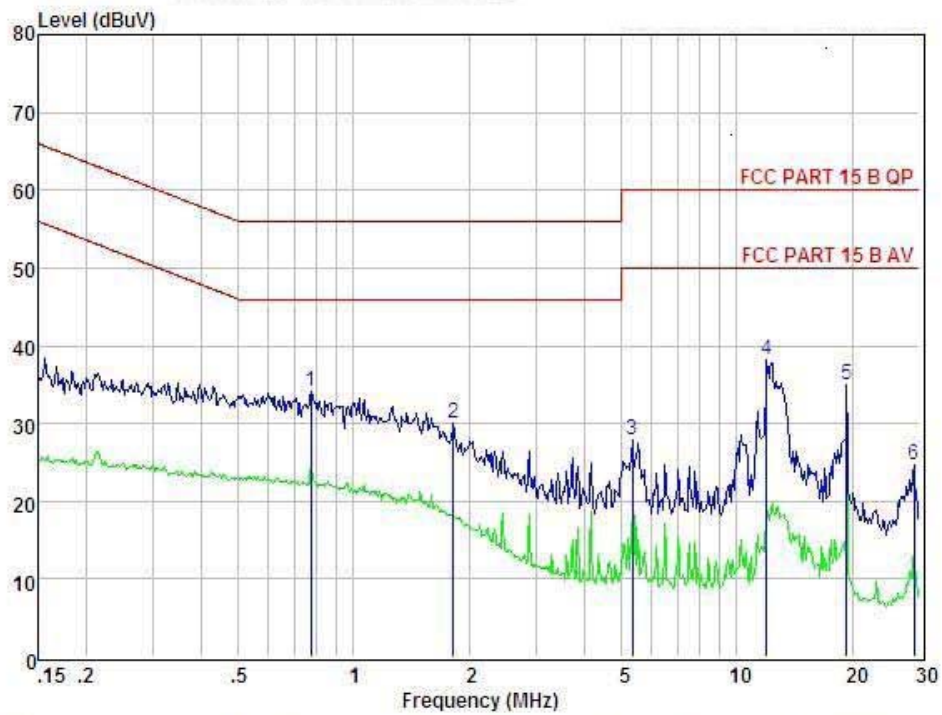

Condition		: FCC PART 15 B QP			POL: NEUTRAL	Temp: 25.7 °C	Hum: 51 %		
Item	Freq MHz	Read Level dBuV	LISN Factor dB	Preamp Factor dB	Cable Loss dB	Level dBuV	Limit dBuV	Margin dBuV	Remark
1	0.775	24.48	0.03	-9.60	0.10	34.08	56.00	-21.92	Peak
2	1.819	20.22	0.00	-9.70	0.10	29.92	56.00	-26.08	Peak
3	5.333	18.01	0.05	-9.94	0.10	27.95	60.00	-32.05	Peak
4	11.996	28.22	0.08	-9.90	0.12	38.12	60.00	-21.88	Peak
5	19.326	25.14	0.24	-9.81	0.22	34.95	60.00	-25.05	Peak
6	29.061	14.70	0.37	-9.86	0.38	24.56	60.00	-35.44	Peak

Remark: Level = Read Level + LISN Factor - Preamp Factor + Cable Loss

4 RADIATED EMISSION TEST

4.1 Radiation Limit

For unintentional device, according to § 15.109(a), except for Class A digital devices, the field strength of radiated emissions from unintentional radiators at a distance of 3 meters shall not exceed the following values:

Frequency (MHz)	Distance (Meters)	Radiated (dB μ V/m)	Radiated (μ V/m)
30-88	3	40	100
88-216	3	43.5	150
216-960	3	46	200
Above 960	3	54	500

For intentional device, according to § 15.209(a), the general requirement of field strength of radiated emissions from intentional radiators at a distance of 3 meters shall not exceed the above table.

4.2 Test Setup

(1) Radiated Emission Test-Up Frequency Below 30MHz

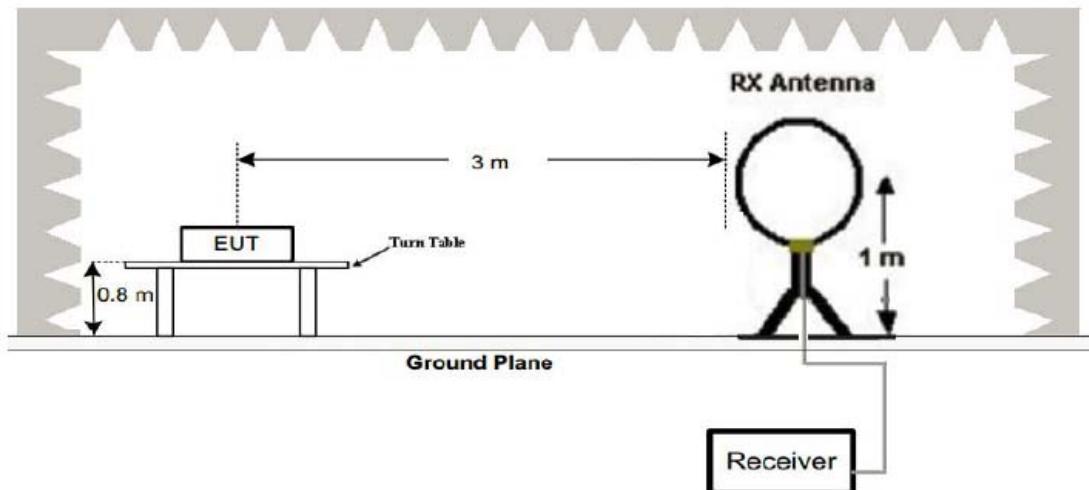

(2) Radiated Emission Test-Up Frequency 30MHz~1GHz

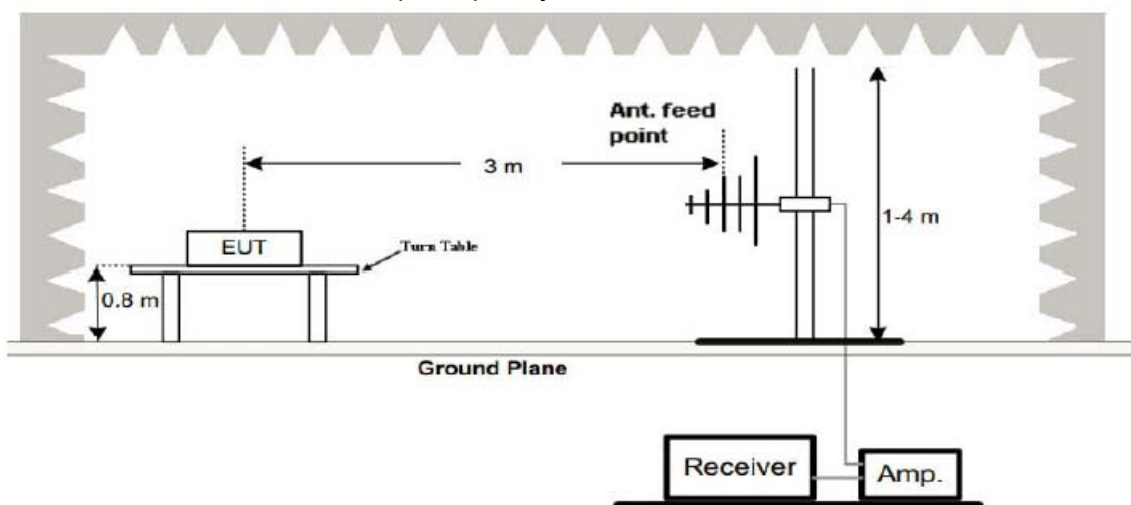

(3) Radiated Emission Test-Up Frequency Above 1GHz

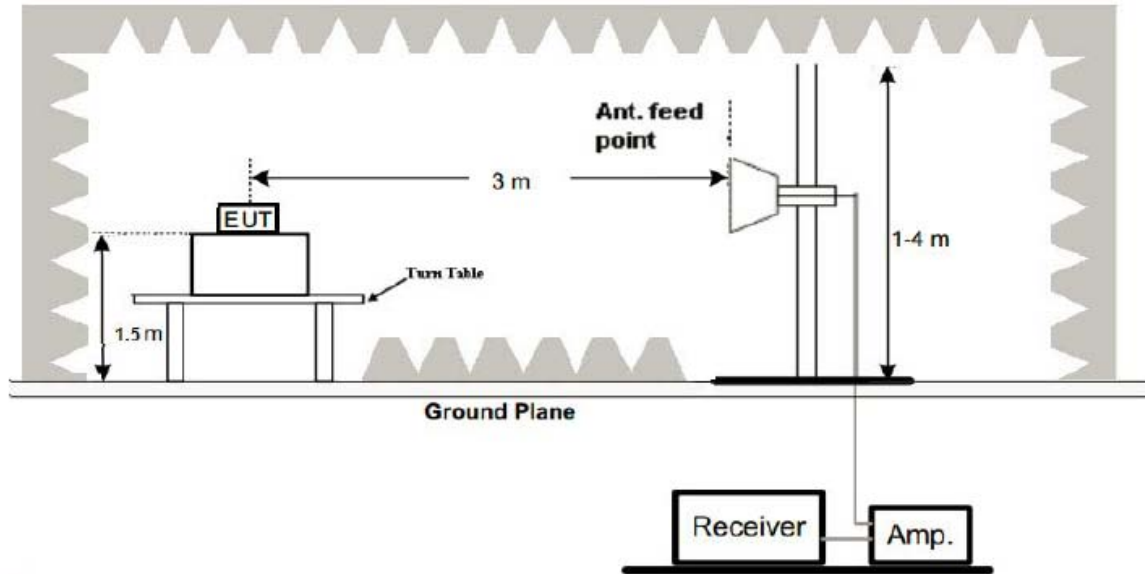

4.3 Test Procedure

1. Below 1GHz measurement the EUT is placed on turntable which is 0.8m above ground plane. And above 1GHz measurement EUT was placed on low permittivity and low tangent turn table which is 1.5m above ground plane.
2. The turntable shall be rotated for 360 degrees to determine the position of maximum emission level.
3. EUT is set 3m away from the receiving antenna, which is varied from 1m to 4m to find out the highest emissions.
4. Maximum procedure was performed on the six highest emissions to ensure EUT compliance.
5. And also, each emission was to be maximized by changing the polarization of receiving antenna both horizontal and vertical.
6. Repeat above procedures until the measurements for all frequencies are complete.
7. The test frequency range from 9KHz to 25GHz per FCC PART 15.33(a).

Note:

For battery operated equipment, the equipment tests shall be performed using a new battery.

4.4 Test Result

PASS

All the test modes completed for test. The worst case of Radiated Emission; the test data of this mode was reported.



Below 1GHz Test Results:
Antenna polarity: H

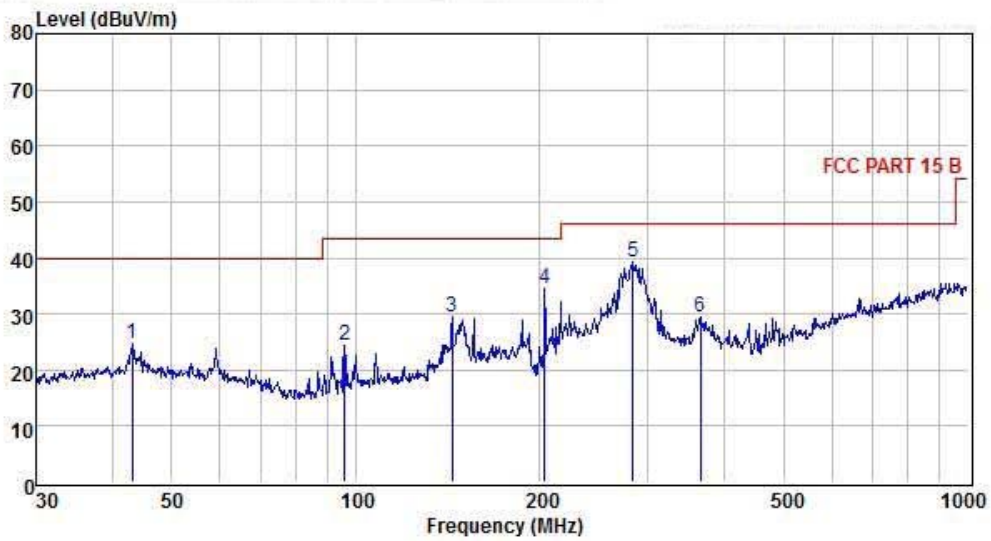

Condition : FCC PART 15 B POL: HORIZONTAL

Item	Freq MHz	Read Level dBuV	Antenna Factor dB	Preamp Factor dB	Cable Loss dB	Level dBuV	Limit dBuV	Margin dBuV	Remark
1	43.05	41.09	13.79	30.40	0.14	24.62	40.00	-15.38	Peak
2	95.76	44.21	9.87	30.19	0.41	24.30	43.50	-19.20	Peak
3	143.83	44.55	13.77	29.39	0.38	29.31	43.50	-14.19	Peak
4	203.52	52.92	9.97	28.79	0.41	34.51	43.50	-8.99	Peak
5	283.98	54.18	12.45	28.08	0.64	39.19	46.00	-6.81	Peak
6	365.54	42.16	14.16	27.58	0.78	29.52	46.00	-16.48	Peak

Remark: Level = Read Level + Antenna Factor - Preamp Factor + Cable Loss



Antenna polarity: V

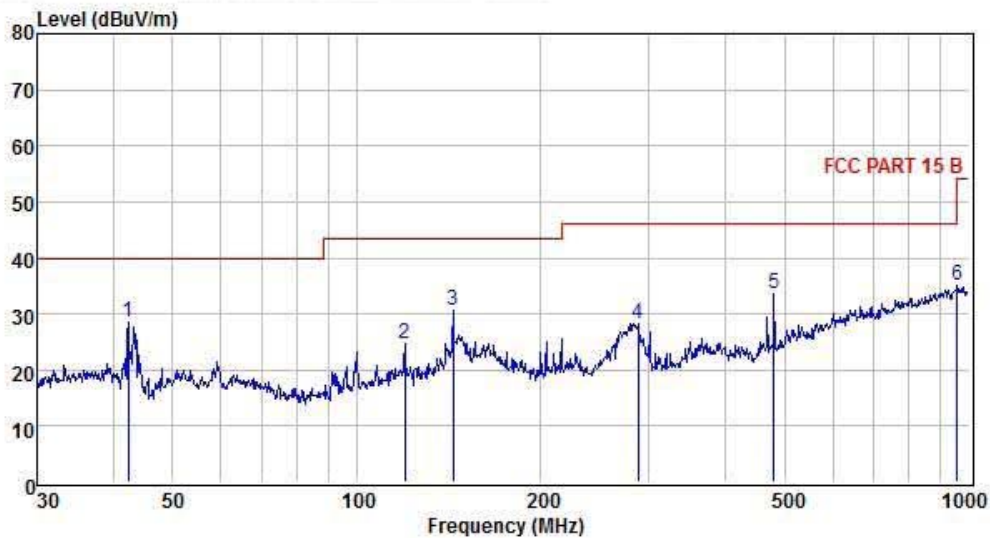

Condition : FCC PART 15 B POL: VERTICAL

Item	Freq MHz	Read Level dBuV	Antenna Factor dB	Preamp Factor dB	Cable Loss dB	Level dBuV	Limit dBuV	Margin dBuV	Remark
1	42.30	44.99	13.93	30.40	0.14	28.66	40.00	-11.34	Peak
2	119.86	41.85	12.06	29.68	0.36	24.59	43.50	-18.91	Peak
3	143.83	46.02	13.77	29.39	0.38	30.78	43.50	-12.72	Peak
4	287.99	43.20	12.54	28.06	0.66	28.34	46.00	-17.66	Peak
5	480.53	43.69	16.28	27.20	0.81	33.58	46.00	-12.42	Peak
6	958.79	35.84	22.16	25.01	1.97	34.96	46.00	-11.04	Peak

Remark: Level = Read Level + Antenna Factor - Preamp Factor + Cable Loss

Remark:

- (1) Measuring frequencies from 9 KHz to the 1 GHz, Radiated emission test from 9KHz to 30MHz was verified, and no any emission was found except system noise floor.
- (2) * denotes emission frequency which appearing within the Restricted Bands specified in provision of 15.205, then the general radiated emission limits in 15.209 apply.
- (3) The IF bandwidth of EMI Test Receiver between 30MHz to 1GHz was 120KHz, 1 MHz for measuring above 1 GHz, below 30MHz was 10KHz.



Above 1 GHz Test Results:

LOW CH1 (802.11b Mode)/2412
Horizontal:

Frequency	Meter Reading	Factor	Emission Level	Limits	Margin	Detector Type
(MHz)	(dB μ V)	(dB)	(dB μ V/m)	(dB μ V/m)	(dB)	
4824	59.81	-3.64	56.17	74	-17.83	peak
4824	45.05	-3.64	41.41	54	-12.59	AVG
7236	52.47	-0.95	51.52	74	-22.48	peak
7236	37.30	-0.95	36.35	54	-17.65	AVG
---	---	---	---	---	---	---
---	---	---	---	---	---	---

Remark: Factor = Antenna Factor + Cable Loss – Pre-amplifier.

Vertical:

Frequency	Meter Reading	Factor	Emission Level	Limits	Margin	Detector Type
(MHz)	(dB μ V)	(dB)	(dB μ V/m)	(dB μ V/m)	(dB)	
4824	58.68	-3.64	55.04	74	-18.96	peak
4824	44.13	-3.64	40.49	54	-13.51	AVG
7236	52.48	-0.95	51.53	74	-22.47	peak
7236	37.91	-0.95	36.96	54	-17.04	AVG
---	---	---	---	---	---	---
---	---	---	---	---	---	---

Remark: Factor = Antenna Factor + Cable Loss – Pre-amplifier.



MID CH6 (802.11b Mode)/2437

Horizontal:

Frequency	Meter Reading	Factor	Emission Level	Limits	Margin	Detector Type
(MHz)	(dB μ V)	(dB)	(dB μ V/m)	(dB μ V/m)	(dB)	
4874	59.28	-3.51	55.77	74	-18.23	peak
4874	43.76	-3.51	40.25	54	-13.75	AVG
7311	53.64	-0.82	52.82	74	-21.18	peak
7311	38.88	-0.82	38.06	54	-15.94	AVG
---	---	---	---	---	---	---
---	---	---	---	---	---	---

Remark: Factor = Antenna Factor + Cable Loss – Pre-amplifier.

Vertical:

Frequency	Meter Reading	Factor	Emission Level	Limits	Margin	Detector Type
(MHz)	(dB μ V)	(dB)	(dB μ V/m)	(dB μ V/m)	(dB)	
4874	58.25	-3.51	54.74	74	-19.26	peak
4874	42.14	-3.51	38.63	54	-15.37	AVG
7311	54.57	-0.82	53.75	74	-20.25	peak
7311	40.14	-0.82	39.32	54	-14.68	AVG
---	---	---	---	---	---	---
---	---	---	---	---	---	---

Remark: Factor = Antenna Factor + Cable Loss – Pre-amplifier.



HIGH CH11 (802.11b Mode)/2462
Horizontal:

Frequency	Meter Reading	Factor	Emission Level	Limits	Margin	Detector Type
(MHz)	(dB μ V)	(dB)	(dB μ V/m)	(dB μ V/m)	(dB)	
4924	60.08	-3.43	56.65	74	-17.35	peak
4924	44.61	-3.43	41.18	54	-12.82	AVG
7386	53.31	-0.75	52.56	74	-21.44	peak
7386	38.68	-0.75	37.93	54	-16.07	AVG
---	---	---	---	---	---	---
---	---	---	---	---	---	---

Remark: Factor = Antenna Factor + Cable Loss – Pre-amplifier.

Vertical:

Frequency	Meter Reading	Factor	Emission Level	Limits	Margin	Detector Type
(MHz)	(dB μ V)	(dB)	(dB μ V/m)	(dB μ V/m)	(dB)	
4924	58.27	-3.43	54.84	74	-19.16	peak
4924	43.45	-3.43	40.02	54	-13.98	AVG
7386	53.01	-0.75	52.26	74	-21.74	peak
7386	39.32	-0.75	38.57	54	-15.43	AVG
---	---	---	---	---	---	---
---	---	---	---	---	---	---

Remark: Factor = Antenna Factor + Cable Loss – Pre-amplifier.

Remark:

- (1) Measuring frequencies from 1 GHz to the 25 GHz.
- (2) "F" denotes fundamental frequency; "H" denotes spurious frequency. "E" denotes band edge frequency.
- (3) * denotes emission frequency which appearing within the Restricted Bands specified in provision of 15.205, then the general radiated emission limits in 15.209 apply.
- (4) Data of measurement within this frequency range shown "---" in the table above means the reading of emissions are attenuated more than 20dB below the permissible limits or the field strength is too small to be measured.
- (5) The IF bandwidth of EMI Test Receiver between 30MHz to 1GHz was 120KHz, 1 MHz for measuring above 1 GHz, below 30MHz was 10KHz.
- (6) When the test results of Peak Detected below the limits of Average Detected, the Average Detected is not need completed. For example: Top Channel at Fundamental 73.16dBuV/m(PK Value) <93.98(AV Limit), at harmonic 53.20 dBuV/m(PK Value) <54 dBuV/m(AV Limit), the Average Detected not need to completed.



LOW CH1 (802.11g Mode)/2412
Horizontal:

Frequency	Meter Reading	Factor	Emission Level	Limits	Margin	Detector Type
(MHz)	(dB μ V)	(dB)	(dB μ V/m)	(dB μ V/m)	(dB)	
4824	58.20	-3.64	54.56	74	-19.44	peak
4824	43.57	-3.64	39.93	54	-14.07	AVG
7236	53.37	-0.95	52.42	74	-21.58	peak
7236	38.60	-0.95	37.65	54	-16.35	AVG
---	---	---	---	---	---	---
---	---	---	---	---	---	---

Remark: Factor = Antenna Factor + Cable Loss – Pre-amplifier.

Vertical:

Frequency	Meter Reading	Factor	Emission Level	Limits	Margin	Detector Type
(MHz)	(dB μ V)	(dB)	(dB μ V/m)	(dB μ V/m)	(dB)	
4824	57.21	-3.64	53.57	74	-20.43	peak
4824	41.82	-3.64	38.18	54	-15.82	AVG
7236	53.18	-0.95	52.23	74	-21.77	peak
7236	38.98	-0.95	38.03	54	-15.97	AVG
---	---	---	---	---	---	---
---	---	---	---	---	---	---

Remark: Factor = Antenna Factor + Cable Loss – Pre-amplifier.



MID CH6 (802.11g Mode)/2437
Horizontal:

Frequency	Meter Reading	Factor	Emission Level	Limits	Margin	Detector Type
(MHz)	(dB μ V)	(dB)	(dB μ V/m)	(dB μ V/m)	(dB)	
4874	60.03	-3.51	56.52	74	-17.48	peak
4874	44.35	-3.51	40.84	54	-13.16	AVG
7311	53.29	-0.82	52.47	74	-21.53	peak
7311	38.53	-0.82	37.71	54	-16.29	AVG
---	---	---	---	---	---	---
---	---	---	---	---	---	---

Remark: Factor = Antenna Factor + Cable Loss – Pre-amplifier.

Vertical:

Frequency	Meter Reading	Factor	Emission Level	Limits	Margin	Detector Type
(MHz)	(dB μ V)	(dB)	(dB μ V/m)	(dB μ V/m)	(dB)	
4874	59.05	-3.51	55.54	74	-18.46	peak
4874	44.68	-3.51	41.17	54	-12.83	AVG
7311	52.33	-0.82	51.51	74	-22.49	peak
7311	38.15	-0.82	37.33	54	-16.67	AVG
---	---	---	---	---	---	---
---	---	---	---	---	---	---

Remark: Factor = Antenna Factor + Cable Loss – Pre-amplifier.



HIGH CH11 (802.11g Mode)/2462
Horizontal:

Frequency	Meter Reading	Factor	Emission Level	Limits	Margin	Detector Type
(MHz)	(dB μ V)	(dB)	(dB μ V/m)	(dB μ V/m)	(dB)	
4924	59.19	-3.43	55.76	74	-18.24	peak
4924	43.71	-3.43	40.28	54	-13.72	AVG
7386	52.60	-0.75	51.85	74	-22.15	peak
7386	38.71	-0.75	37.96	54	-16.04	AVG
---	---	---	---	---	---	---
---	---	---	---	---	---	---

Remark: Factor = Antenna Factor + Cable Loss – Pre-amplifier.

Vertical:

Frequency	Meter Reading	Factor	Emission Level	Limits	Margin	Detector Type
(MHz)	(dB μ V)	(dB)	(dB μ V/m)	(dB μ V/m)	(dB)	
4924	58.51	-3.43	55.08	74	-18.92	peak
4924	43.12	-3.43	39.69	54	-14.31	AVG
7386	51.01	-0.75	50.26	74	-23.74	peak
7386	37.86	-0.75	37.11	54	-16.89	AVG
---	---	---	---	---	---	---
---	---	---	---	---	---	---

Remark: Factor = Antenna Factor + Cable Loss – Pre-amplifier.

Remark:

- (1) Measuring frequencies from 1 GHz to the 25 GHz.
- (2) "F" denotes fundamental frequency; "H" denotes spurious frequency. "E" denotes band edge frequency.
- (3) * denotes emission frequency which appearing within the Restricted Bands specified in provision of 15.205, then the general radiated emission limits in 15.209 apply.
- (4) Data of measurement within this frequency range shown "---" in the table above means the reading of emissions are attenuated more than 20dB below the permissible limits or the field strength is too small to be measured.
- (5) The IF bandwidth of EMI Test Receiver between 30MHz to 1GHz was 120KHz, 1 MHz for measuring above 1 GHz, below 30MHz was 10KHz.
- (6) When the test results of Peak Detected below the limits of Average Detected, the Average Detected is not need completed. For example: Top Channel at Fundamental 73.16dBuV/m(PK Value) <93.98(AV Limit), at harmonic 53.20 dBuV/m(PK Value) <54 dBuV/m(AV Limit), the Average Detected not need to completed.



LOW CH1 (802.11n/H20 Mode)/2412
Horizontal:

Frequency	Meter Reading	Factor	Emission Level	Limits	Margin	Detector Type
(MHz)	(dB μ V)	(dB)	(dB μ V/m)	(dB μ V/m)	(dB)	
4824	58.57	-3.64	54.93	74	-19.07	peak
4824	43.38	-3.64	39.74	54	-14.26	AVG
7236	51.37	-0.95	50.42	74	-23.58	peak
7236	37.63	-0.95	36.68	54	-17.32	AVG
---	---	---	---	---	---	---
---	---	---	---	---	---	---

Remark: Factor = Antenna Factor + Cable Loss – Pre-amplifier.

Vertical:

Frequency	Meter Reading	Factor	Emission Level	Limits	Margin	Detector Type
(MHz)	(dB μ V)	(dB)	(dB μ V/m)	(dB μ V/m)	(dB)	
4824	57.36	-3.64	53.72	74	-20.28	peak
4824	42.95	-3.64	39.31	54	-14.69	AVG
7236	52.52	-0.95	51.57	74	-22.43	peak
7236	38.23	-0.95	37.28	54	-16.72	AVG
---	---	---	---	---	---	---
---	---	---	---	---	---	---

Remark: Factor = Antenna Factor + Cable Loss – Pre-amplifier.



MID CH6 (802.11n/H20 Mode)/2437
Horizontal:

Frequency	Meter Reading	Factor	Emission Level	Limits	Margin	Detector Type
(MHz)	(dB μ V)	(dB)	(dB μ V/m)	(dB μ V/m)	(dB)	
4874	58.94	-3.51	55.43	74	-18.57	peak
4874	43.90	-3.51	40.39	54	-13.61	AVG
7311	53.07	-0.82	52.25	74	-21.75	peak
7311	37.88	-0.82	37.06	54	-16.94	AVG
---	---	---	---	---	---	---
---	---	---	---	---	---	---

Remark: Factor = Antenna Factor + Cable Loss – Pre-amplifier.

Vertical:

Frequency	Meter Reading	Factor	Emission Level	Limits	Margin	Detector Type
(MHz)	(dB μ V)	(dB)	(dB μ V/m)	(dB μ V/m)	(dB)	
4874	58.15	-3.51	54.64	74	-19.36	peak
4874	43.23	-3.51	39.72	54	-14.28	AVG
7311	54.05	-0.82	53.23	74	-20.77	peak
7311	39.29	-0.82	38.47	54	-15.53	AVG
---	---	---	---	---	---	---
---	---	---	---	---	---	---

Remark: Factor = Antenna Factor + Cable Loss – Pre-amplifier.



HIGH CH11 (802.11n/H20 Mode)/2462
Horizontal:

Frequency	Meter Reading	Factor	Emission Level	Limits	Margin	Detector Type
(MHz)	(dB μ V)	(dB)	(dB μ V/m)	(dB μ V/m)	(dB)	
4924	57.49	-3.43	54.06	74	-19.94	peak
4924	42.95	-3.43	39.52	54	-14.48	AVG
7386	51.27	-0.75	50.52	74	-23.48	peak
7386	37.04	-0.75	36.29	54	-17.71	AVG
---	---	---	---	---	---	---
---	---	---	---	---	---	---

Remark: Factor = Antenna Factor + Cable Loss – Pre-amplifier.

Vertical:

Frequency	Meter Reading	Factor	Emission Level	Limits	Margin	Detector Type
(MHz)	(dB μ V)	(dB)	(dB μ V/m)	(dB μ V/m)	(dB)	
4924	55.37	-3.43	51.94	74	-22.06	peak
4924	40.12	-3.43	36.69	54	-17.31	AVG
7386	50.47	-0.75	49.72	74	-24.28	peak
7386	35.93	-0.75	35.18	54	-18.82	AVG
---	---	---	---	---	---	---
---	---	---	---	---	---	---

Remark: Factor = Antenna Factor + Cable Loss – Pre-amplifier.

Remark:

- (1) Measuring frequencies from 1 GHz to the 25 GHz.
- (2) "F" denotes fundamental frequency; "H" denotes spurious frequency. "E" denotes band edge frequency.
- (3) * denotes emission frequency which appearing within the Restricted Bands specified in provision of 15.205, then the general radiated emission limits in 15.209 apply.
- (4) Data of measurement within this frequency range shown "---" in the table above means the reading of emissions are attenuated more than 20dB below the permissible limits or the field strength is too small to be measured.
- (5) The IF bandwidth of EMI Test Receiver between 30MHz to 1GHz was 120KHz, 1 MHz for measuring above 1 GHz, below 30MHz was 10KHz.
- (6) When the test results of Peak Detected below the limits of Average Detected, the Average Detected is not need completed. For example: Top Channel at Fundamental 73.16dBuV/m(PK Value) <93.98(AV Limit), at harmonic 53.20 dBuV/m(PK Value) <54 dBuV/m(AV Limit), the Average Detected not need to completed.



LOW CH3 (802.11n/H40 Mode)/2422
Horizontal:

Frequency	Meter Reading	Factor	Emission Level	Limits	Margin	Detector Type
(MHz)	(dB μ V)	(dB)	(dB μ V/m)	(dB μ V/m)	(dB)	
4924	59.89	-3.63	56.26	74	-17.74	peak
4924	44.96	-3.63	41.33	54	-12.67	AVG
7386	53.79	-0.94	52.85	74	-21.15	peak
7386	39.35	-0.94	38.41	54	-15.59	AVG
---	---	---	---	---	---	---
---	---	---	---	---	---	---

Remark: Factor = Antenna Factor + Cable Loss – Pre-amplifier.

Vertical:

Frequency	Meter Reading	Factor	Emission Level	Limits	Margin	Detector Type
(MHz)	(dB μ V)	(dB)	(dB μ V/m)	(dB μ V/m)	(dB)	
4924	58.01	-3.63	54.38	74	-19.62	peak
4924	43.32	-3.63	39.69	54	-14.31	AVG
7386	53.36	-0.94	52.42	74	-21.58	peak
7386	38.47	-0.94	37.53	54	-16.47	AVG
---	---	---	---	---	---	---
---	---	---	---	---	---	---

Remark: Factor = Antenna Factor + Cable Loss – Pre-amplifier.



MID CH6 (802.11n/H40 Mode)/2437
Horizontal:

Frequency	Meter Reading	Factor	Emission Level	Limits	Margin	Detector Type
(MHz)	(dB μ V)	(dB)	(dB μ V/m)	(dB μ V/m)	(dB)	
4874	59.72	-3.51	56.21	74	-17.79	peak
4874	44.68	-3.51	41.17	54	-12.83	AVG
7311	53.38	-0.82	52.56	74	-21.44	peak
7311	38.83	-0.82	38.01	54	-15.99	AVG
---	---	---	---	---	---	---
---	---	---	---	---	---	---

Remark: Factor = Antenna Factor + Cable Loss – Pre-amplifier.

Vertical:

Frequency	Meter Reading	Factor	Emission Level	Limits	Margin	Detector Type
(MHz)	(dB μ V)	(dB)	(dB μ V/m)	(dB μ V/m)	(dB)	
4874	59.05	-3.51	55.54	74	-18.46	peak
4874	44.80	-3.51	41.29	54	-12.71	AVG
7311	52.67	-0.82	51.85	74	-22.15	peak
7311	38.34	-0.82	37.52	54	-16.48	AVG
---	---	---	---	---	---	---
---	---	---	---	---	---	---

Remark: Factor = Antenna Factor + Cable Loss – Pre-amplifier.



HIGH CH9 (802.11n/H40 Mode)/2452
Horizontal:

Frequency	Meter Reading	Factor	Emission Level	Limits	Margin	Detector Type
(MHz)	(dB μ V)	(dB)	(dB μ V/m)	(dB μ V/m)	(dB)	
4904	59.09	-3.43	55.66	74	-18.34	peak
4904	43.92	-3.43	40.49	54	-13.51	AVG
7356	52.26	-0.75	51.51	74	-22.49	peak
7356	38.57	-0.75	37.82	54	-16.18	AVG
---	---	---	---	---	---	---
---	---	---	---	---	---	---

Remark: Factor = Antenna Factor + Cable Loss – Pre-amplifier.

Vertical:

Frequency	Meter Reading	Factor	Emission Level	Limits	Margin	Detector Type
(MHz)	(dB μ V)	(dB)	(dB μ V/m)	(dB μ V/m)	(dB)	
4904	58.16	-3.43	54.73	74	-19.27	peak
4904	43.74	-3.43	40.31	54	-13.69	AVG
7356	52.92	-0.75	52.17	74	-21.83	peak
7356	39.18	-0.75	38.43	54	-15.57	AVG
---	---	---	---	---	---	---
---	---	---	---	---	---	---

Remark: Factor = Antenna Factor + Cable Loss – Pre-amplifier.

Remark:

- (1) Measuring frequencies from 1 GHz to the 25 GHz.
- (2) "F" denotes fundamental frequency; "H" denotes spurious frequency. "E" denotes band edge frequency.
- (3) * denotes emission frequency which appearing within the Restricted Bands specified in provision of 15.205, then the general radiated emission limits in 15.209 apply.
- (4) Data of measurement within this frequency range shown "---" in the table above means the reading of emissions are attenuated more than 20dB below the permissible limits or the field strength is too small to be measured.
- (5) The IF bandwidth of EMI Test Receiver between 30MHz to 1GHz was 120KHz, 1 MHz for measuring above 1 GHz, below 30MHz was 10KHz.
- (6) When the test results of Peak Detected below the limits of Average Detected, the Average Detected is not need completed. For example: Top Channel at Fundamental 73.16dBuV/m(PK Value) <93.98(AV Limit), at harmonic 53.20 dBuV/m(PK Value) <54 dBuV/m(AV Limit), the Average Detected not need to completed.



5 BAND EDGE

5.1 Limits

FCC PART 15.247 Emissions radiated outside of the specified frequency bands, except for harmonics, shall be attenuated by at least 50 dB below the level of the fundamental or to the general radiated emission limits in §15.209, whichever is the lesser attenuation.

5.2 Test Procedure

The band edge compliance of RF radiated emission should be measured by following the guidance in ANSI C63.10 with respect to maximizing the emission by rotating the EUT, measuring the emission while the EUT is situated in three orthogonal planes (if appropriate), adjusting the measurement antenna height and polarization etc. Set RBW to 100KHz and VBM to 300KHz to measure the peak field strength and set RBW to 1MHz and VBW to 10Hz to measure the average radiated field strength. The conducted RF band edge was measured by using a spectrum analyzer. Set span wide enough to capture the highest in-band emission and the emission at the band edge. Set RBW to 100 KHz and VBW to 300 KHz, to measure the conducted peak band edge.

5.3 Test Result

PASS

Radiated Band Edge Test:
Operation Mode: 802.11b Mode TX CH Low (2412MHz)
Horizontal

Frequency (MHz)	Meter Reading (dBμV)	Factor (dB)	Emission Level (dBμV/m)	Limits (dBμV/m)	Margin (dB)	Detector Type
2390	51.75	-5.81	45.94	74	-28.06	peak
2390	/	-5.81	/	54	/	AVG
2400	61.35	-5.84	55.51	74	-18.49	peak
2400	46.89	-5.84	41.05	54	-12.95	AVG

Remark: Factor = Antenna Factor + Cable Loss – Pre-amplifier.

Vertical:

Frequency (MHz)	Meter Reading (dBμV)	Factor (dB)	Emission Level (dBμV/m)	Limits (dBμV/m)	Margin (dB)	Detector Type
2390	51.45	-5.81	45.64	74	-28.36	peak
2390	/	-5.81	/	54	/	AVG
2400	56.90	-5.84	51.06	74	-22.94	peak
2400	/	-5.84	/	54	/	AVG

Remark: Factor = Antenna Factor + Cable Loss – Pre-amplifier.



Operation Mode: TX CH High (2462MHz)
Horizontal

Frequency	Meter Reading	Factor	Emission Level	Limits	Margin	Detector Type
(MHz)	(dB μ V)	(dB)	(dB μ V/m)	(dB μ V/m)	(dB)	
2483.5	51.53	-5.65	45.88	74	-28.12	peak
2483.5	/	-5.65	/	54	/	AVG

Remark: Factor = Antenna Factor + Cable Loss – Pre-amplifier.

Vertical:

Frequency	Meter Reading	Factor	Emission Level	Limits	Margin	Detector Type
(MHz)	(dB μ V)	(dB)	(dB μ V/m)	(dB μ V/m)	(dB)	
2483.5	50.58	-5.65	44.93	74	-29.07	peak
2483.5	/	-5.65	/	54	/	AVG

Remark: Factor = Antenna Factor + Cable Loss – Pre-amplifier.

Remark: All the other emissions not reported were too low to read and deemed to comply with FCC limit.



Operation Mode: 802.11g Mode TX CH Low (2412MHz)
Horizontal

Frequency	Meter Reading	Factor	Emission Level	Limits	Margin	Detector Type
(MHz)	(dB μ V)	(dB)	(dB μ V/m)	(dB μ V/m)	(dB)	
2390	50.68	-5.81	44.87	74	-29.13	peak
2390	/	-5.81	/	54	/	AVG
2400	61.40	-5.84	55.56	74	-18.44	peak
2400	47.56	-5.84	41.72	54	-12.28	AVG

Remark: Factor = Antenna Factor + Cable Loss – Pre-amplifier.

Vertical:

Frequency	Meter Reading	Factor	Emission Level	Limits	Margin	Detector Type
(MHz)	(dB μ V)	(dB)	(dB μ V/m)	(dB μ V/m)	(dB)	
2390	51.06	-5.81	45.25	74	-28.75	peak
2390	/	-5.81	/	54	/	AVG
2400	59.92	-5.84	54.08	74	-19.92	peak
2400	44.67	-5.84	38.83	54	-15.17	AVG

Remark: Factor = Antenna Factor + Cable Loss – Pre-amplifier.



Operation Mode: TX CH High (2462MHz)
Horizontal

Frequency	Meter Reading	Factor	Emission Level	Limits	Margin	Detector Type
(MHz)	(dB μ V)	(dB)	(dB μ V/m)	(dB μ V/m)	(dB)	
2483.5	51.29	-5.65	45.64	74	-28.36	peak
2483.5	/	-5.65	/	54	/	AVG

Remark: Factor = Antenna Factor + Cable Loss – Pre-amplifier.

Vertical:

Frequency	Meter Reading	Factor	Emission Level	Limits	Margin	Detector Type
(MHz)	(dB μ V)	(dB)	(dB μ V/m)	(dB μ V/m)	(dB)	
2483.5	50.90	-5.65	45.25	74	-28.75	peak
2483.5	/	-5.65	/	54	/	AVG

Remark: Factor = Antenna Factor + Cable Loss – Pre-amplifier.

Remark: All the other emissions not reported were too low to read and deemed to comply with FCC limit.



Operation Mode: 802.11n/H20 Mode TX CH Low (2412MHz)
Horizontal

Frequency	Meter Reading	Factor	Emission Level	Limits	Margin	Detector Type
(MHz)	(dB μ V)	(dB)	(dB μ V/m)	(dB μ V/m)	(dB)	
2390	51.14	-5.81	45.33	74	-28.67	peak
2390	/	-5.81	/	54	/	AVG
2400	58.41	-5.84	52.57	74	-21.43	peak
2400	/	-5.84	/	54	/	AVG

Remark: Factor = Antenna Factor + Cable Loss – Pre-amplifier.

Vertical:

Frequency	Meter Reading	Factor	Emission Level	Limits	Margin	Detector Type
(MHz)	(dB μ V)	(dB)	(dB μ V/m)	(dB μ V/m)	(dB)	
2390	50.75	-5.81	44.94	74	-29.06	peak
2390	/	-5.81	/	54	/	AVG
2400	56.42	-5.84	50.58	74	-23.42	peak
2400	/	-5.84	/	54	/	AVG

Remark: Factor = Antenna Factor + Cable Loss – Pre-amplifier.



Operation Mode: TX CH High (2462MHz)
Horizontal

Frequency	Meter Reading	Factor	Emission Level	Limits	Margin	Detector Type
(MHz)	(dB μ V)	(dB)	(dB μ V/m)	(dB μ V/m)	(dB)	
2483.5	51.49	-5.65	45.84	74	-28.16	peak
2483.5	/	-5.65	/	54	/	AVG

Remark: Factor = Antenna Factor + Cable Loss – Pre-amplifier.

Vertical:

Frequency	Meter Reading	Factor	Emission Level	Limits	Margin	Detector Type
(MHz)	(dB μ V)	(dB)	(dB μ V/m)	(dB μ V/m)	(dB)	
2483.5	51.18	-5.65	45.53	74	-28.47	peak
2483.5	/	-5.65	/	54	/	AVG

Remark: Factor = Antenna Factor + Cable Loss – Pre-amplifier.

Remark: All the other emissions not reported were too low to read and deemed to comply with FCC limit.



Operation Mode: 802.11n/H40 Mode TX CH Low (2422MHz)
Horizontal

Frequency	Meter Reading	Factor	Emission Level	Limits	Margin	Detector Type
(MHz)	(dB μ V)	(dB)	(dB μ V/m)	(dB μ V/m)	(dB)	
2390	51.18	-5.81	45.37	74	-28.63	peak
2390	/	-5.81	/	54	/	AVG
2400	57.36	-5.84	51.52	74	-22.48	peak
2400	/	-5.84	/	54	/	AVG

Remark: Factor = Antenna Factor + Cable Loss – Pre-amplifier.

Vertical:

Frequency	Meter Reading	Factor	Emission Level	Limits	Margin	Detector Type
(MHz)	(dB μ V)	(dB)	(dB μ V/m)	(dB μ V/m)	(dB)	
2390	51.27	-5.81	44.65	74	-29.35	peak
2390	/	-5.81	/	54	/	AVG
2400	57.35	-5.84	50.26	74	-23.74	peak
2400	/	-5.84	/	54	/	AVG

Remark: Factor = Antenna Factor + Cable Loss – Pre-amplifier.



Operation Mode: TX CH High (2452MHz)
Horizontal

Frequency	Meter Reading	Factor	Emission Level	Limits	Margin	Detector Type
(MHz)	(dB μ V)	(dB)	(dB μ V/m)	(dB μ V/m)	(dB)	
2483.5	51.13	-5.65	45.48	74	-28.52	peak
2483.5	/	-5.65	/	54	/	AVG

Remark: Factor = Antenna Factor + Cable Loss – Pre-amplifier.

Vertical:

Frequency	Meter Reading	Factor	Emission Level	Limits	Margin	Detector Type
(MHz)	(dB μ V)	(dB)	(dB μ V/m)	(dB μ V/m)	(dB)	
2483.5	50.78	-5.65	45.13	74	-28.87	peak
2483.5	/	-5.65	/	54	/	AVG

Remark: Factor = Antenna Factor + Cable Loss – Pre-amplifier.

Remark: All the other emissions not reported were too low to read and deemed to comply with FCC limit.



6 OCCUPIED BANDWIDTH MEASUREMENT

6.1 Test Limit

FCC Part15 (15.247) , Subpart C				
Section	Test Item	Limit	Frequency Range (MHz)	Result
15.247(a)(2)	Bandwidth	$\geq 500\text{KHz}$ (6dB bandwidth)	2400-2483.5	PASS

6.2 Test Procedure

1. The EUT was placed on a turn table which is 0.8m above ground plane.
2. Set EUT as normal operation.
3. Based on FCC Part15 C Section 15.247: RBW= 100KHz. VBW= 300 KHz.
4. The useful radiated emission from the EUT was detected by the spectrum analyser with peak detector.

6.3 Measurement Equipment Used

Same as Radiated Emission Measurement

6.4 Test Result

PASS

All the test modes completed for test.



TX 802.11b Mode			
Frequency	6dB Bandwidth (MHz)	Channel Separation (MHz)	Result
2412 MHz	10.08	>=500KHz	PASS
2437 MHz	9.113	>=500KHz	PASS
2462 MHz	9.079	>=500KHz	PASS

CH: 2412MHz

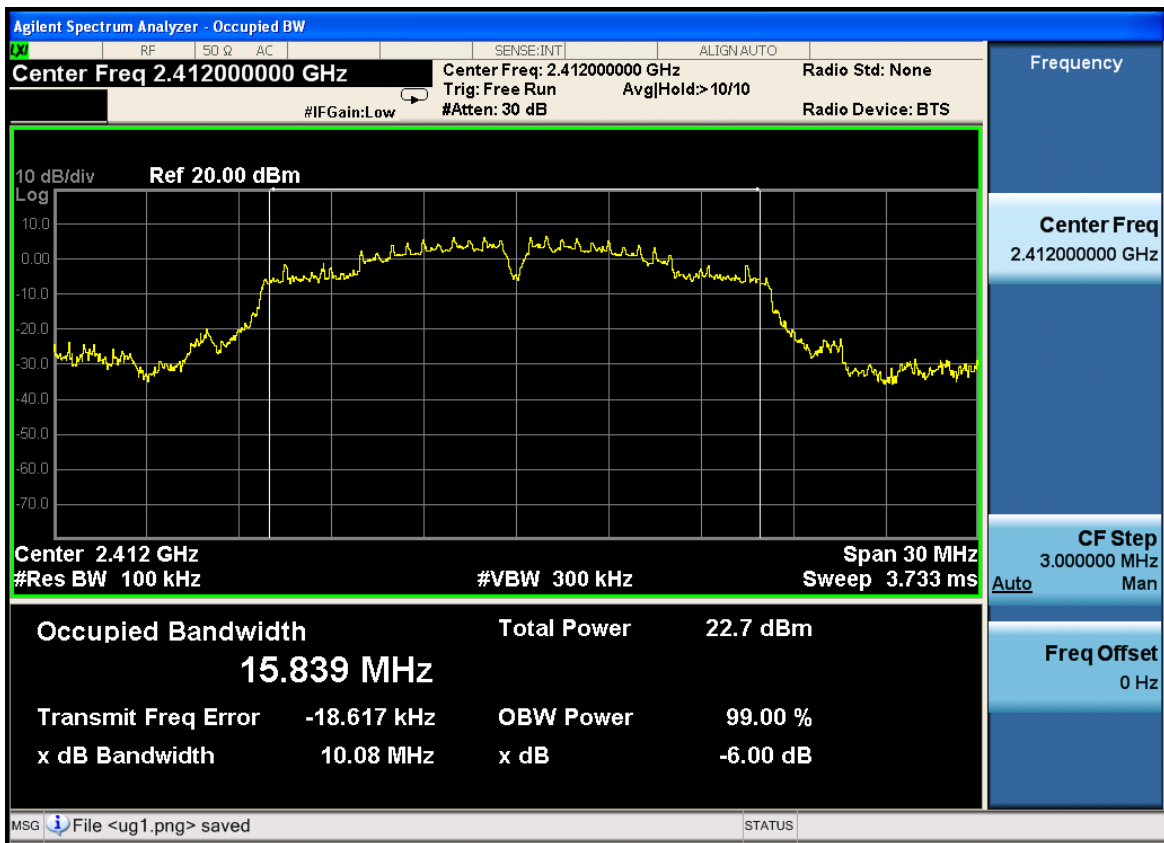



CH: 2437MHz

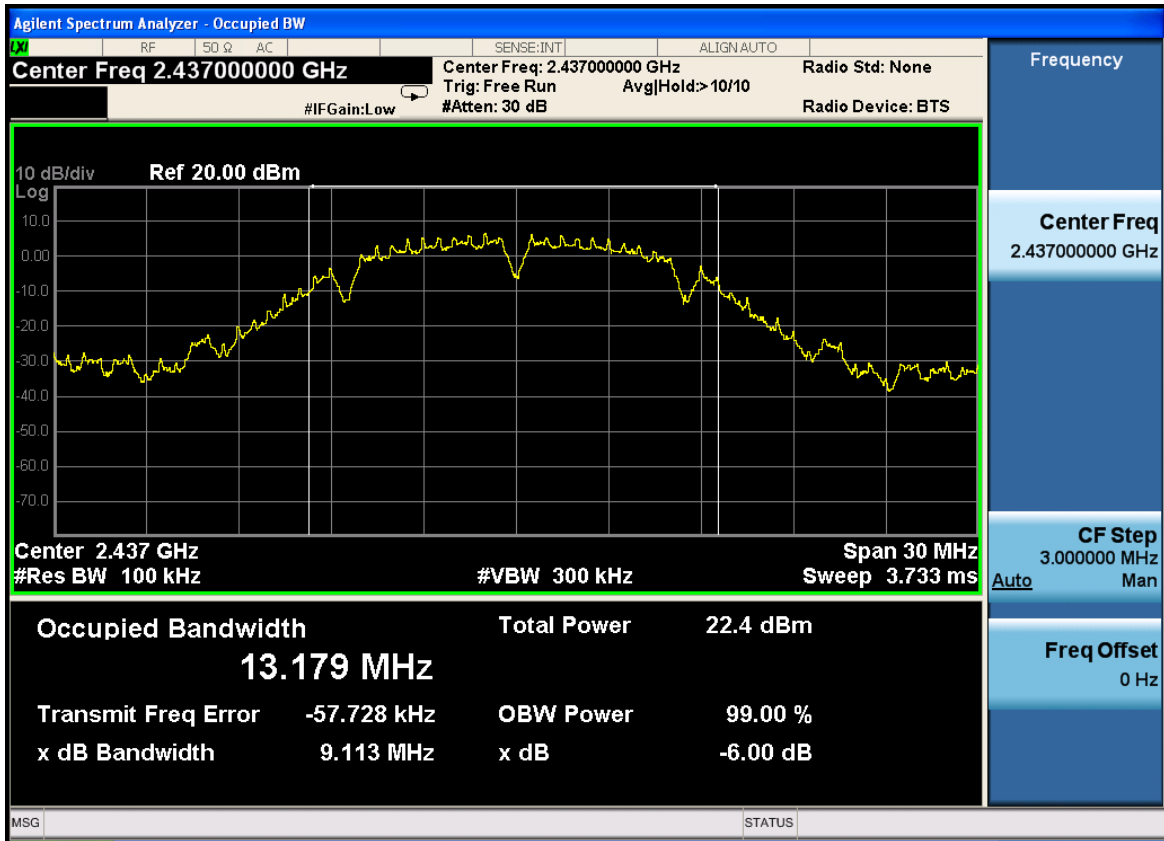

CH: 2462MHz

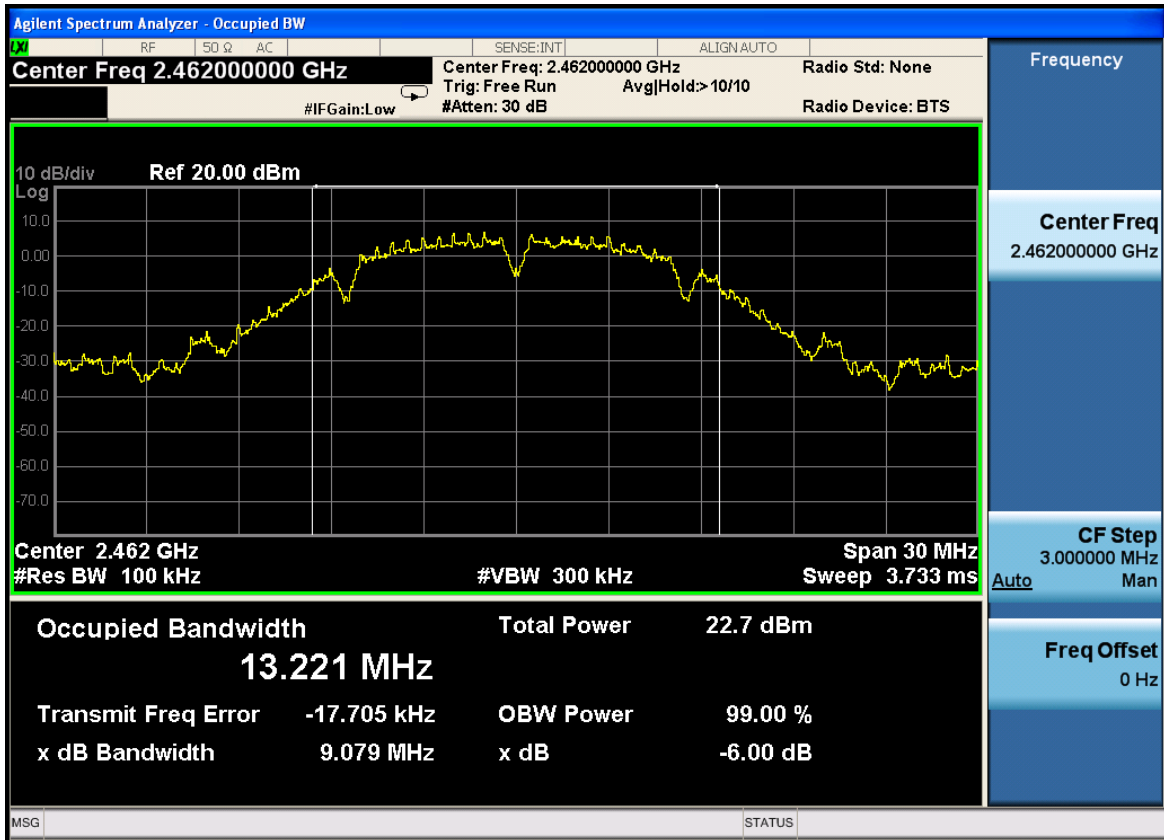



TX 802.11g Mode			
Frequency	6dB Bandwidth (MHz)	Channel Separation (MHz)	Result
2412 MHz	15.08	>=500KHz	PASS
2437 MHz	15.45	>=500KHz	PASS
2462 MHz	15.12	>=500KHz	PASS

CH: 2412MHz

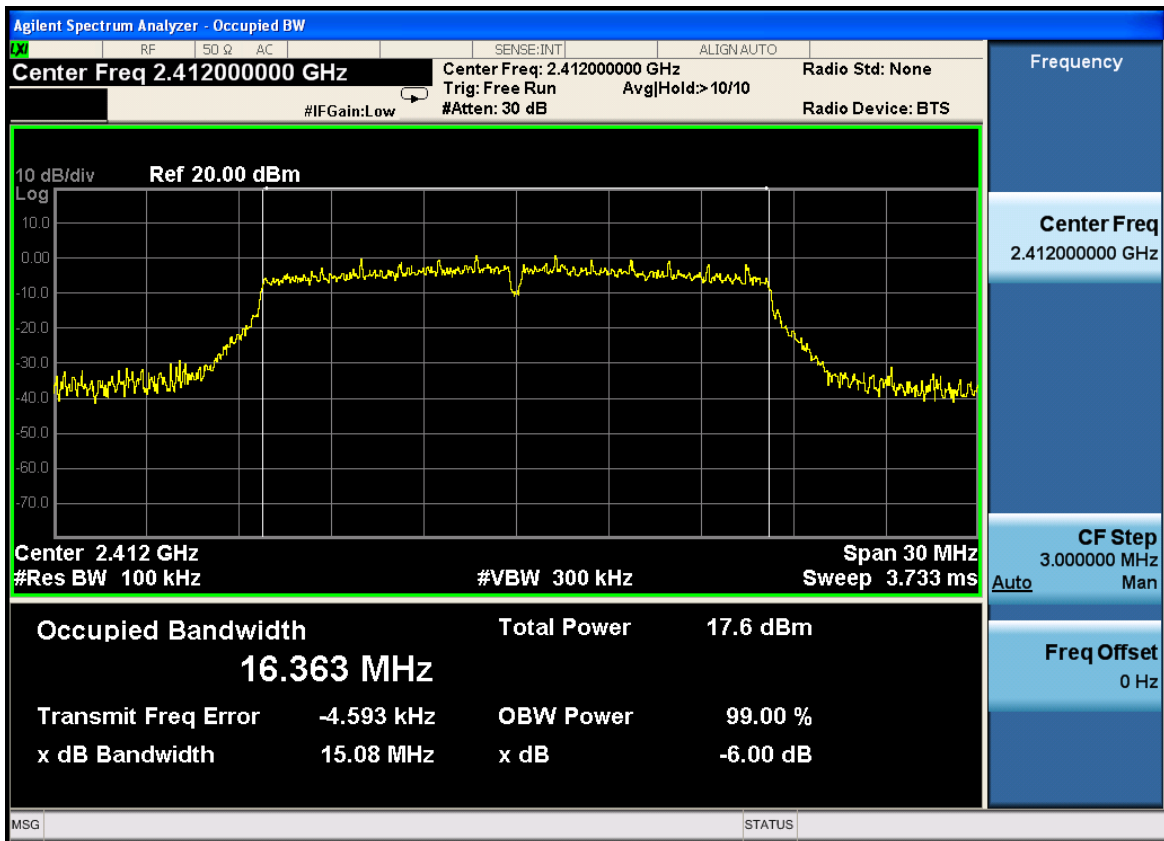



CH: 2437MHz

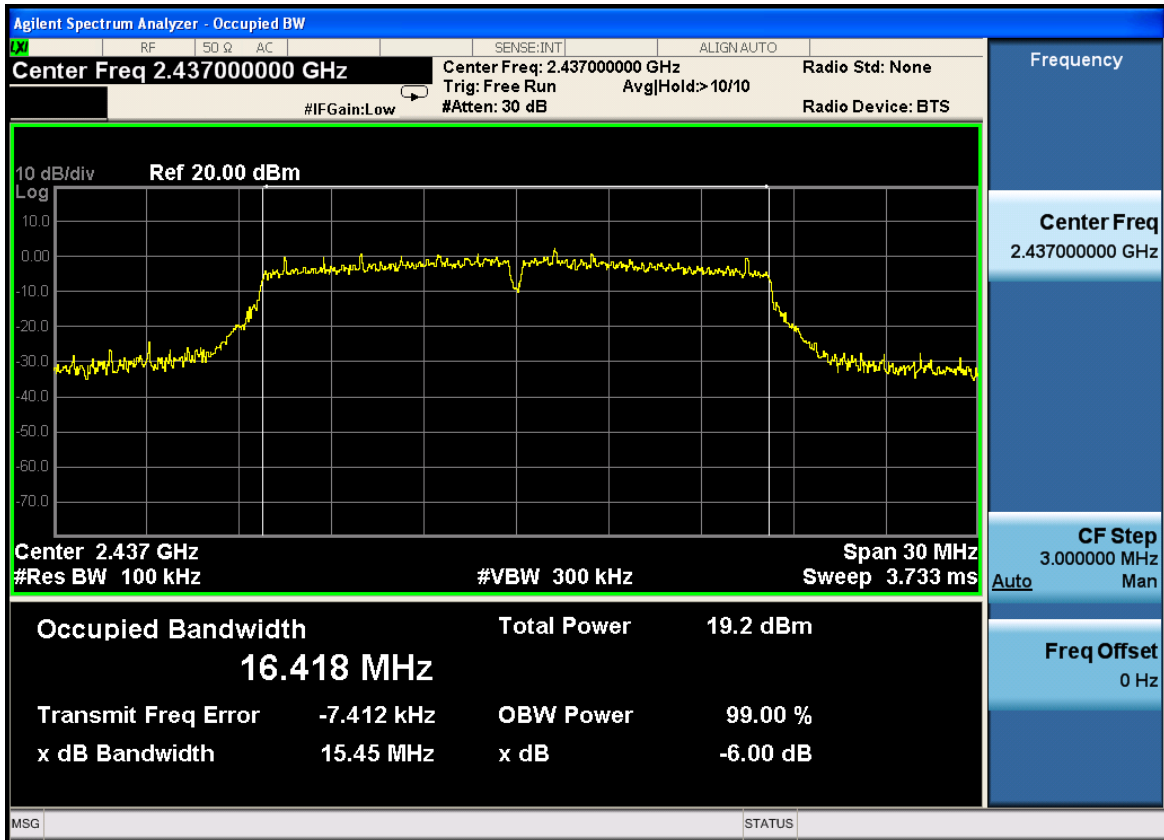

CH: 2462MHz

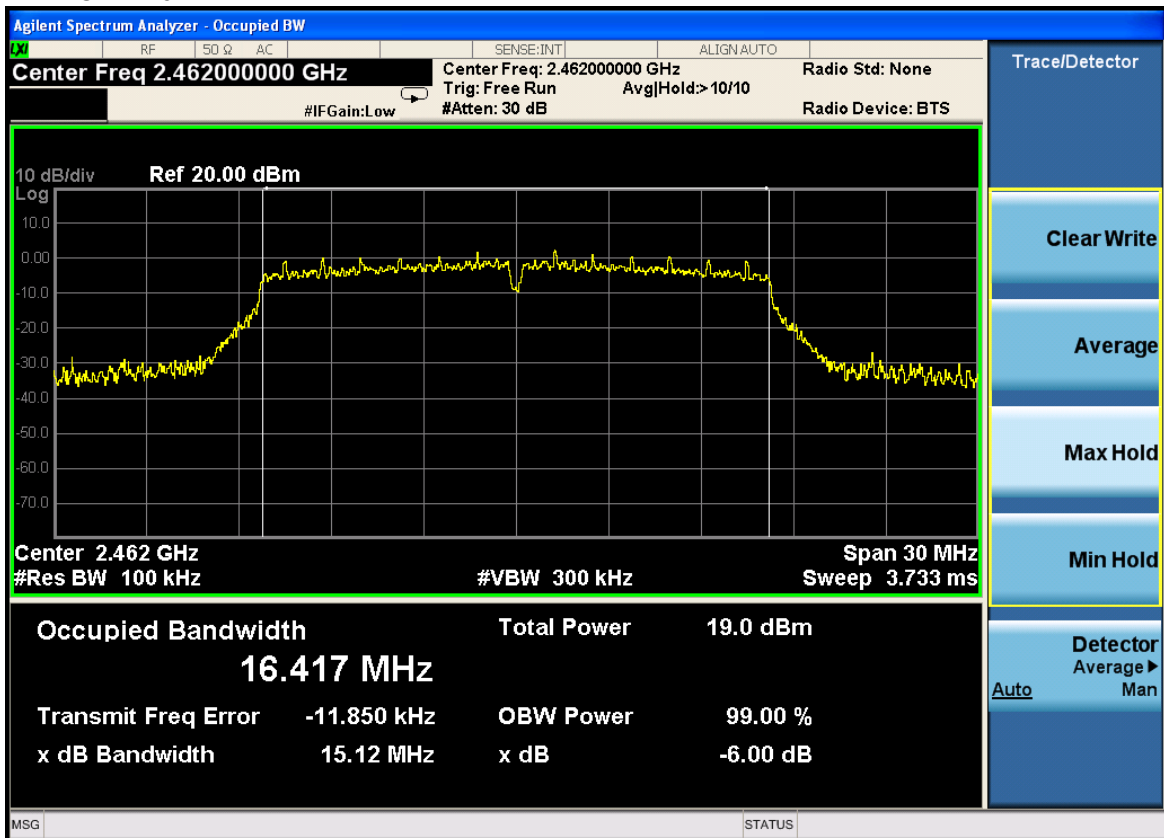



TX 802.11n/HT20 Mode			
Frequency	6dB Bandwidth (MHz)	Channel Separation (MHz)	Result
2412 MHz	16.51	>=500KHz	PASS
2437 MHz	15.08	>=500KHz	PASS
2462 MHz	15.05	>=500KHz	PASS

CH: 2412MHz

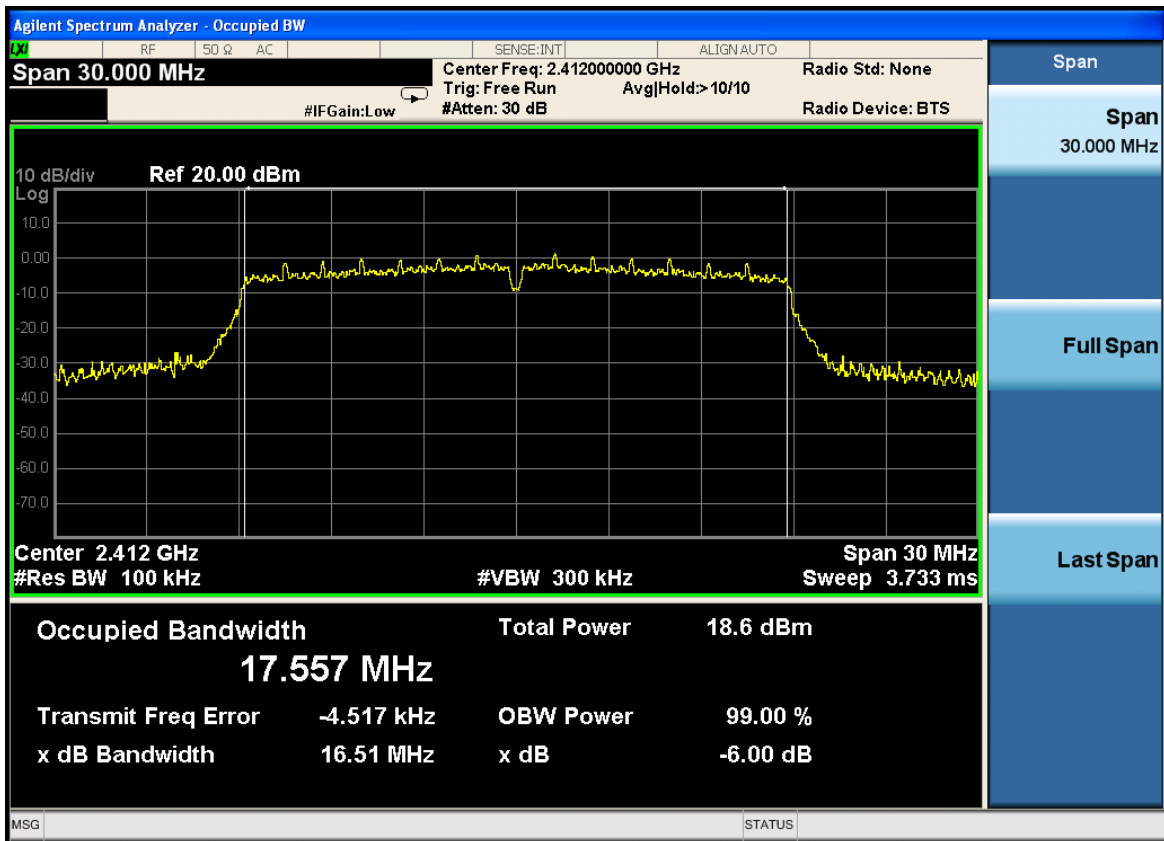



CH: 2437MHz

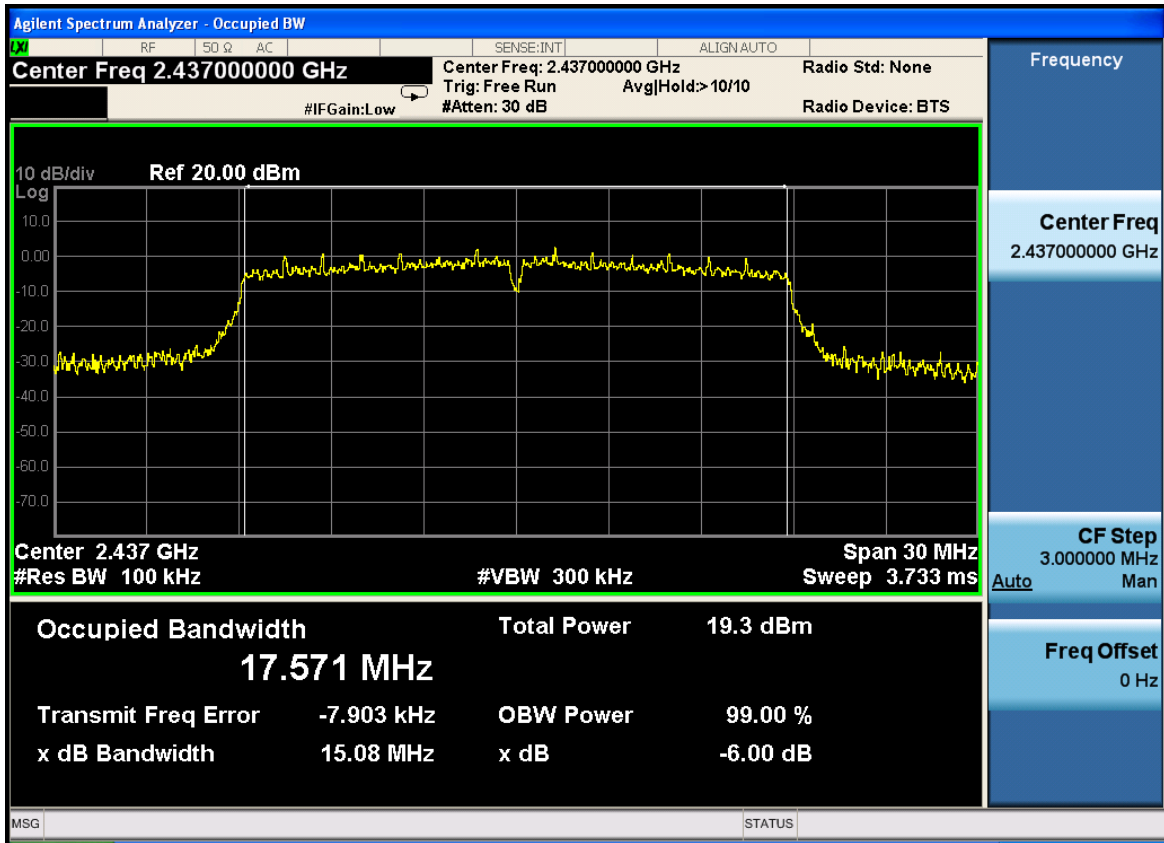

CH: 2462MHz

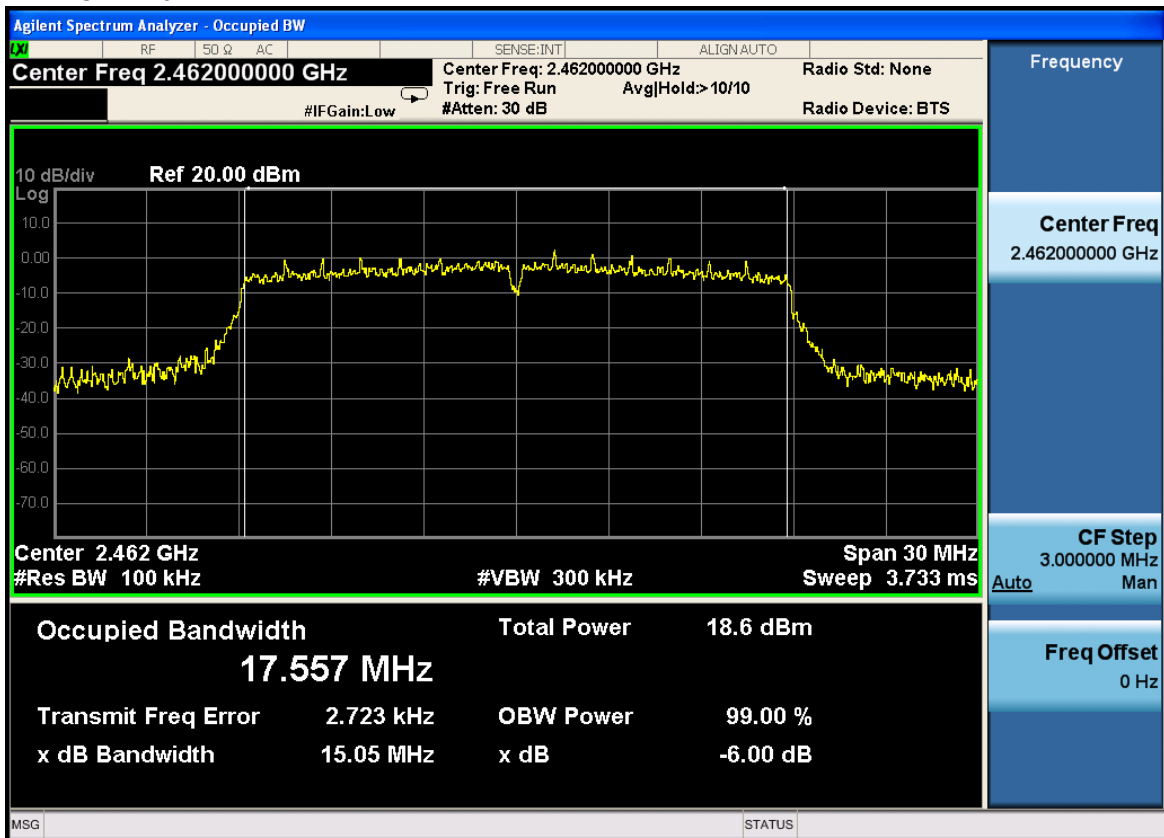



TX 802.11n/HT40 Mode			
Frequency	6dB Bandwidth (MHz)	Channel Separation (MHz)	Result
2422 MHz	35.13	>=500KHz	PASS
2437 MHz	35.17	>=500KHz	PASS
2452 MHz	35.19	>=500KHz	PASS

CH: 2422MHz

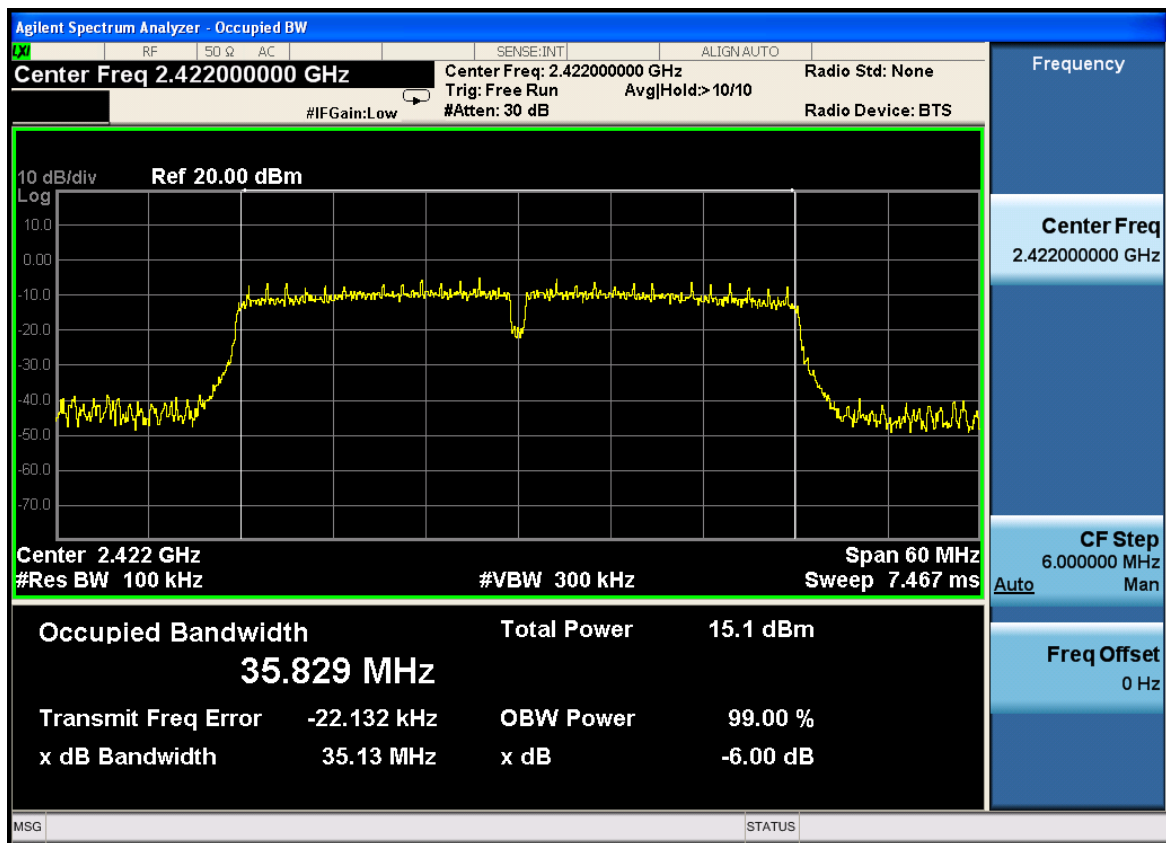



CH: 2437MHz

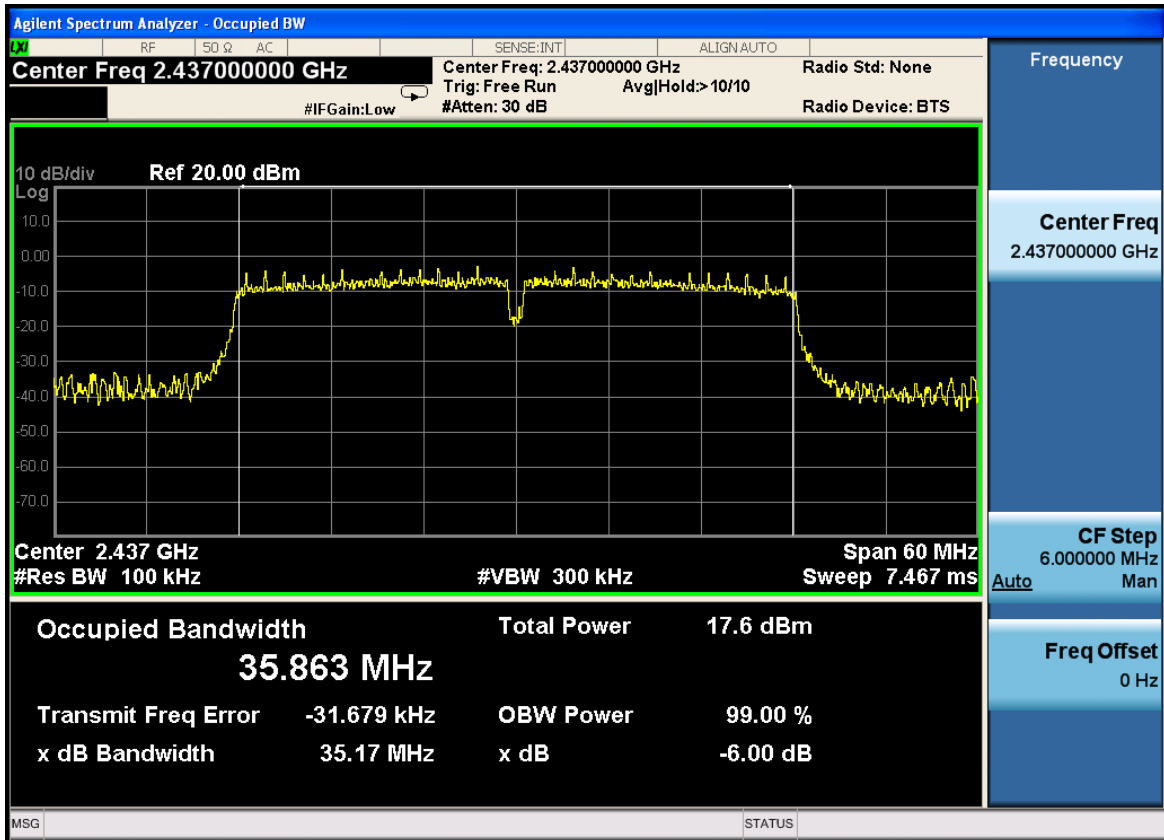

CH: 2452MHz

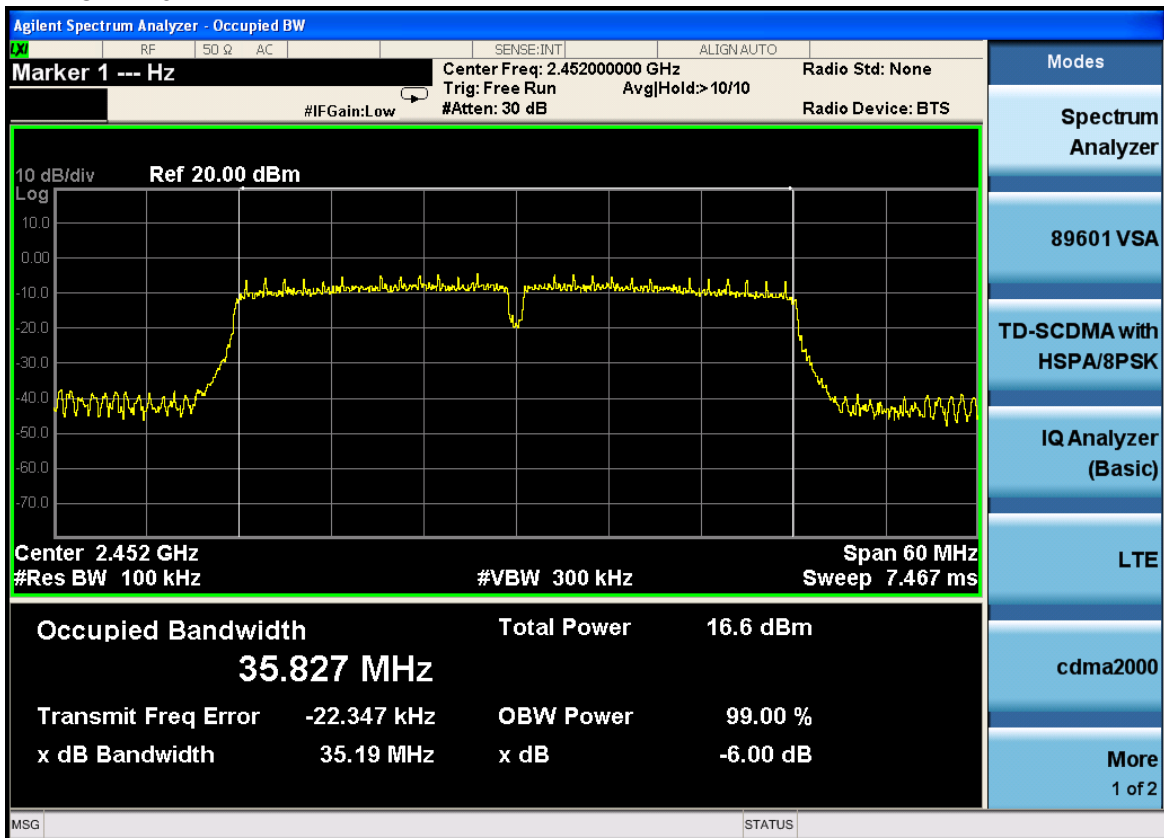



7 POWER SPECTRAL DENSITY TEST

7.1 Test Limit

FCC Part15 (15.247) , Subpart C				
Section	Test Item	Limit	Frequency Range (MHz)	Result
15.247	Power Spectral Density	8 dBm (in any 3KHz)	2400-2483.5	PASS

7.2 Test Procedure

1. The EUT was placed on a turn table which is 0.8m above ground plane.
2. Set EUT as normal operation.
3. Based on FCC Part15 C Section 15.247: RBW= 3KHz. VBW= 10 KHz, Span=3MHz.
4. The useful radiated emission from the EUT was detected by the spectrum analyser with peak detector.

7.3 Measurement Equipment Used

Same as Radiated Emission Measurement

7.4 Test Result

PASS

All the test modes completed for test.



TX 802.11b Mode			
Frequency	Power Density (dBm)	Limit (dBm)	Result
2412 MHz	-3.104	8	PASS
2437 MHz	-0.744	8	PASS
2462 MHz	-2.920	8	PASS

CH: 2412MHz

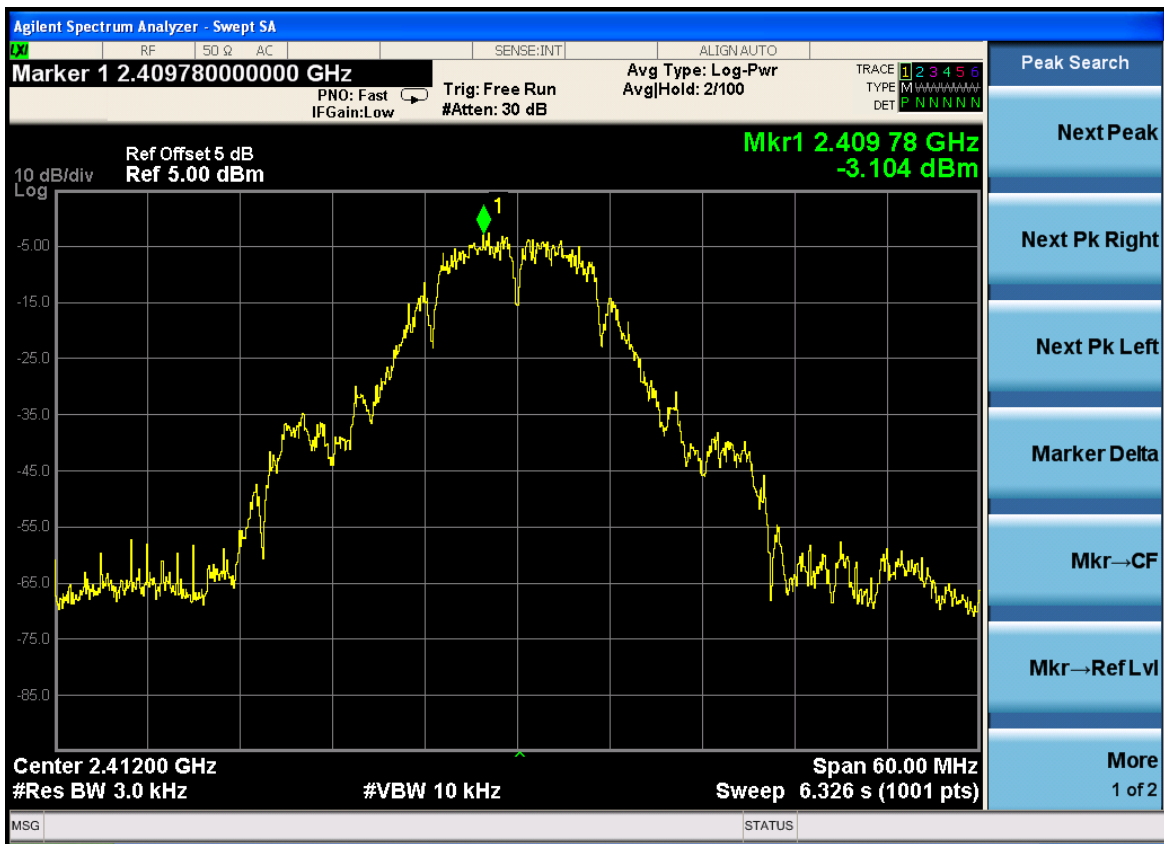



CH: 2437MHz

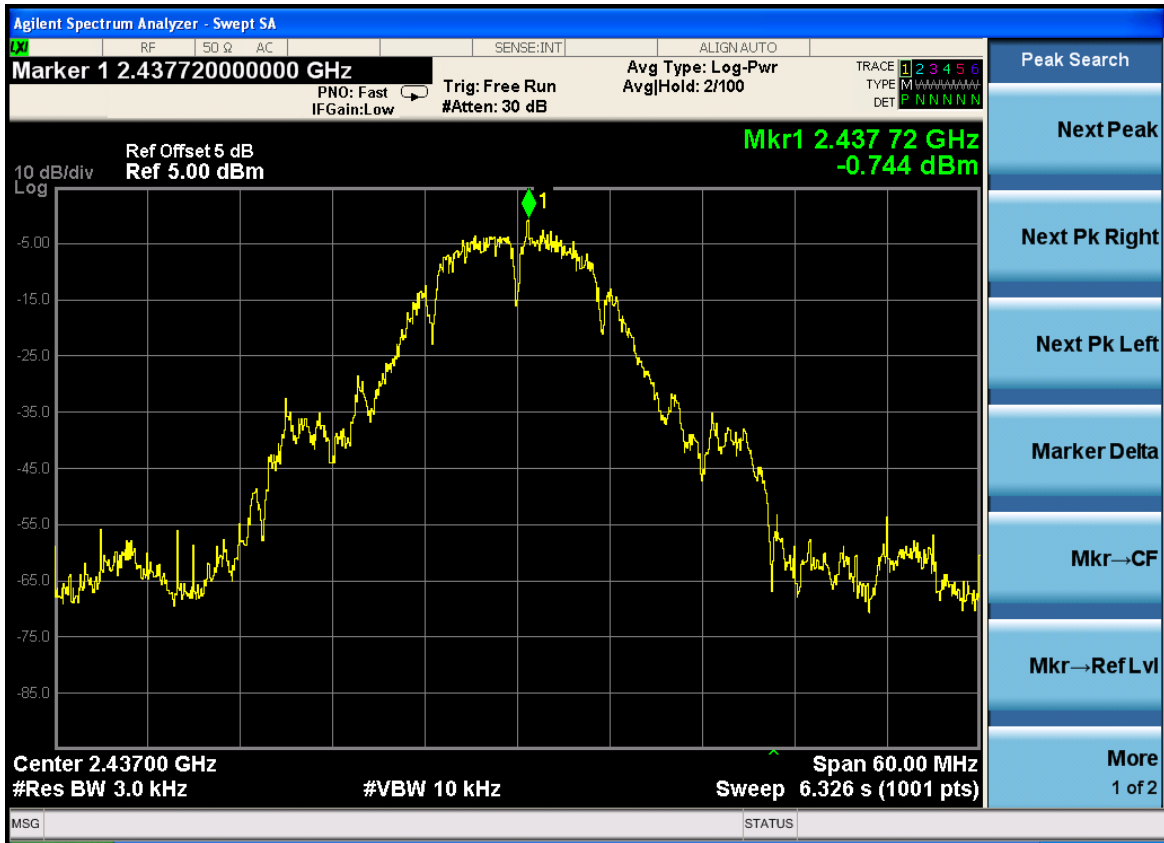

CH: 2462MHz

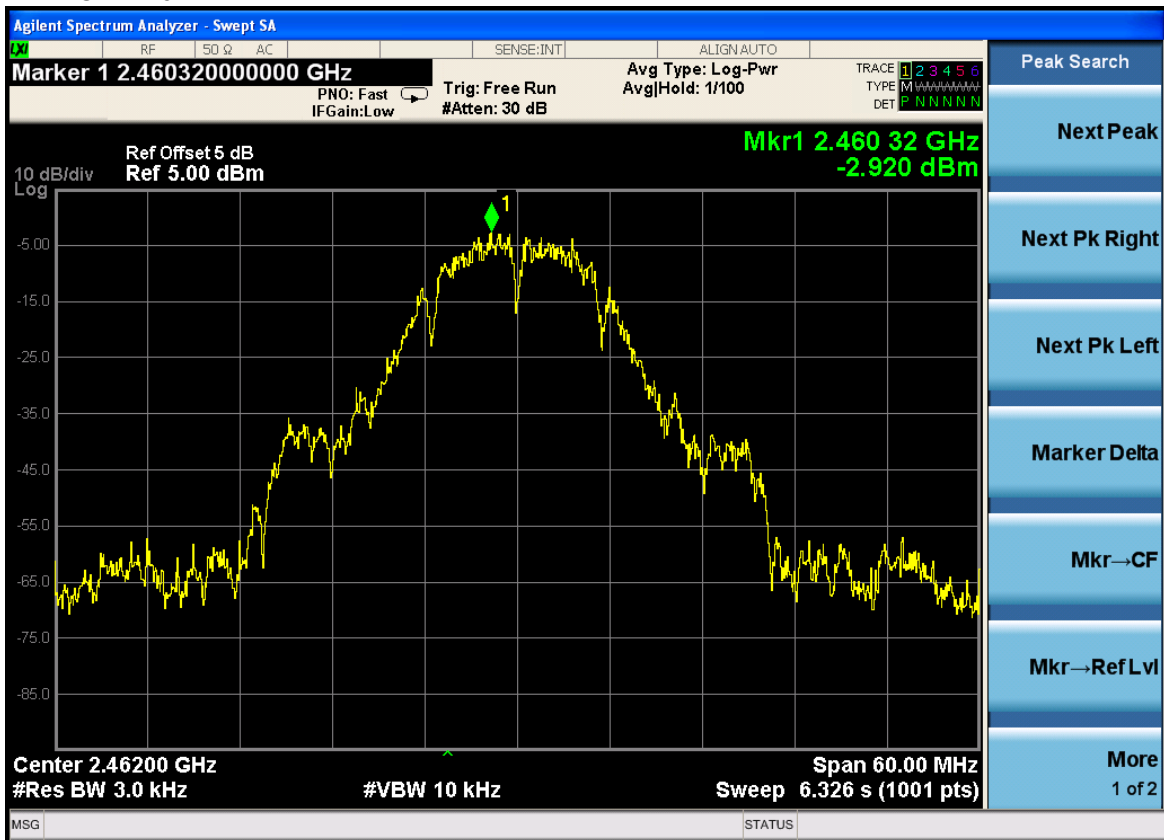



TX 802.11g Mode			
Frequency	Power Density (dBm)	Limit (dBm)	Result
2412 MHz	-3.265	8	PASS
2437 MHz	-0.330	8	PASS
2462 MHz	-2.848	8	PASS

CH: 2412MHz

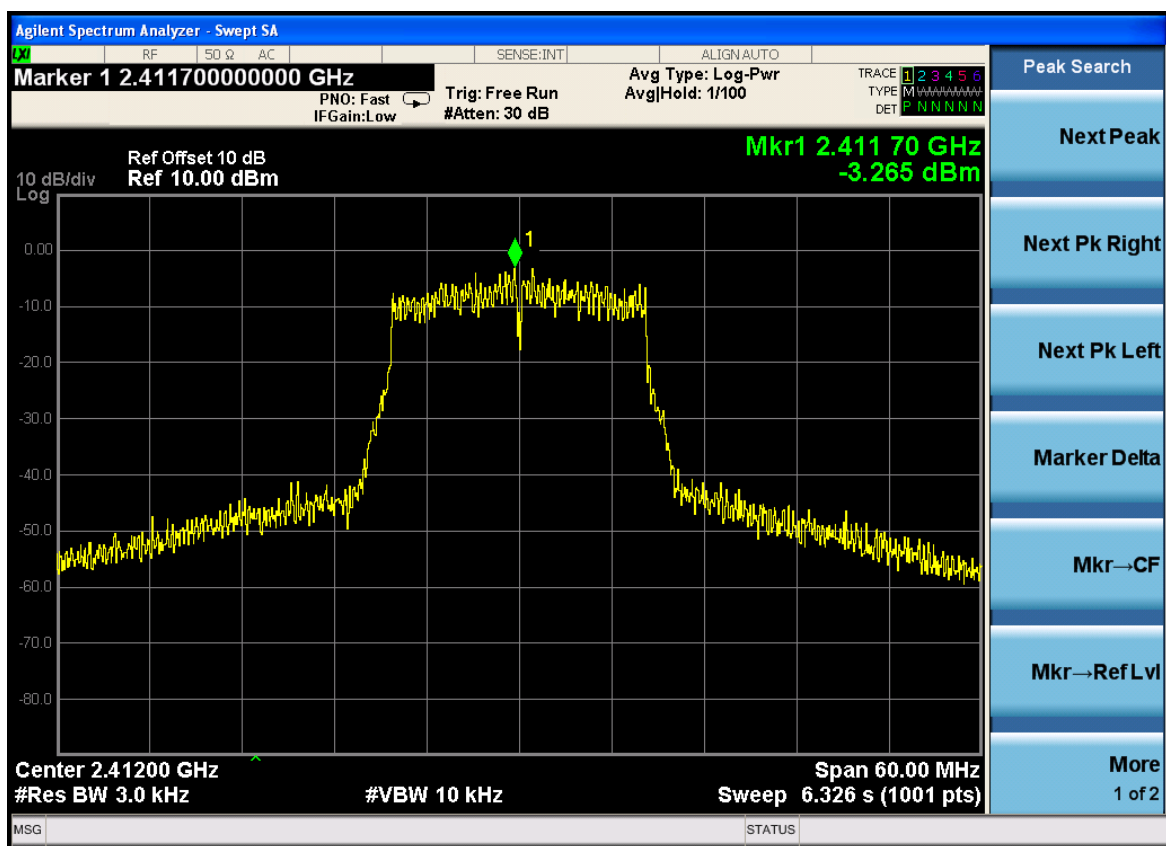



CH: 2437MHz

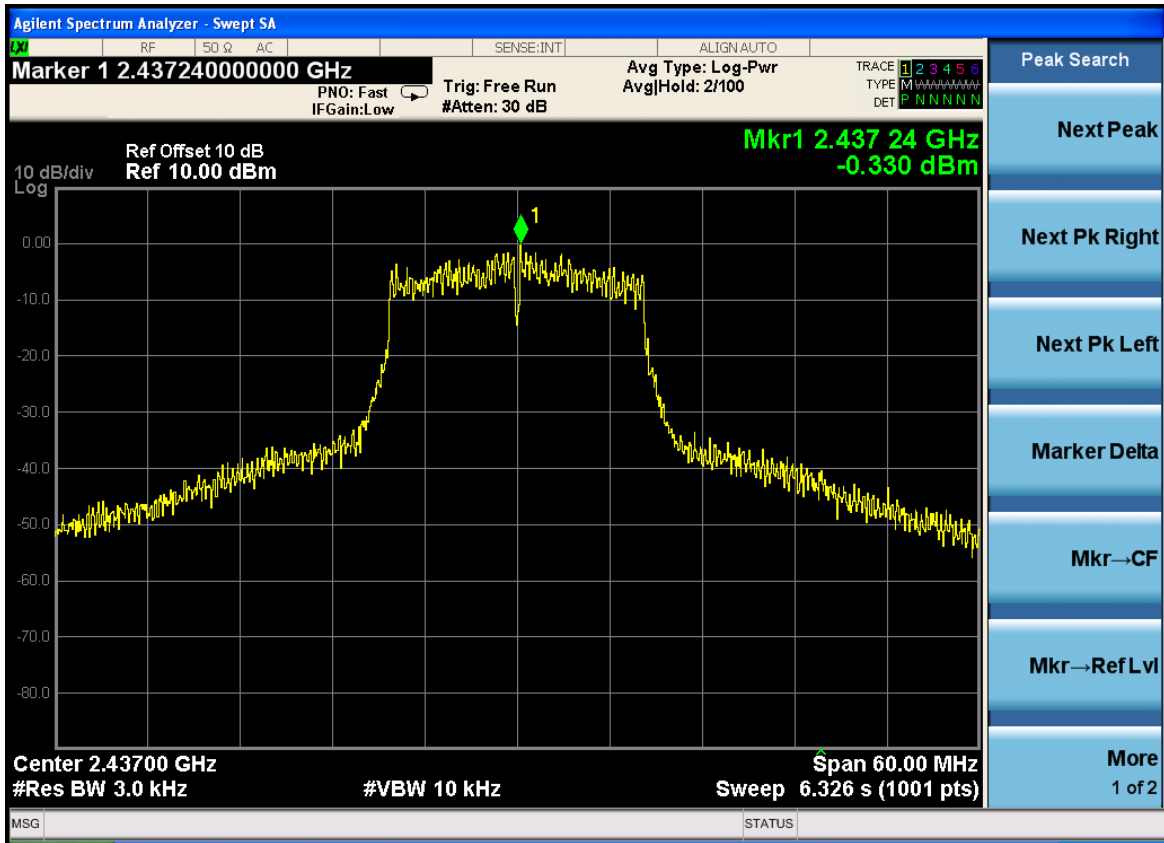

CH: 2462MHz

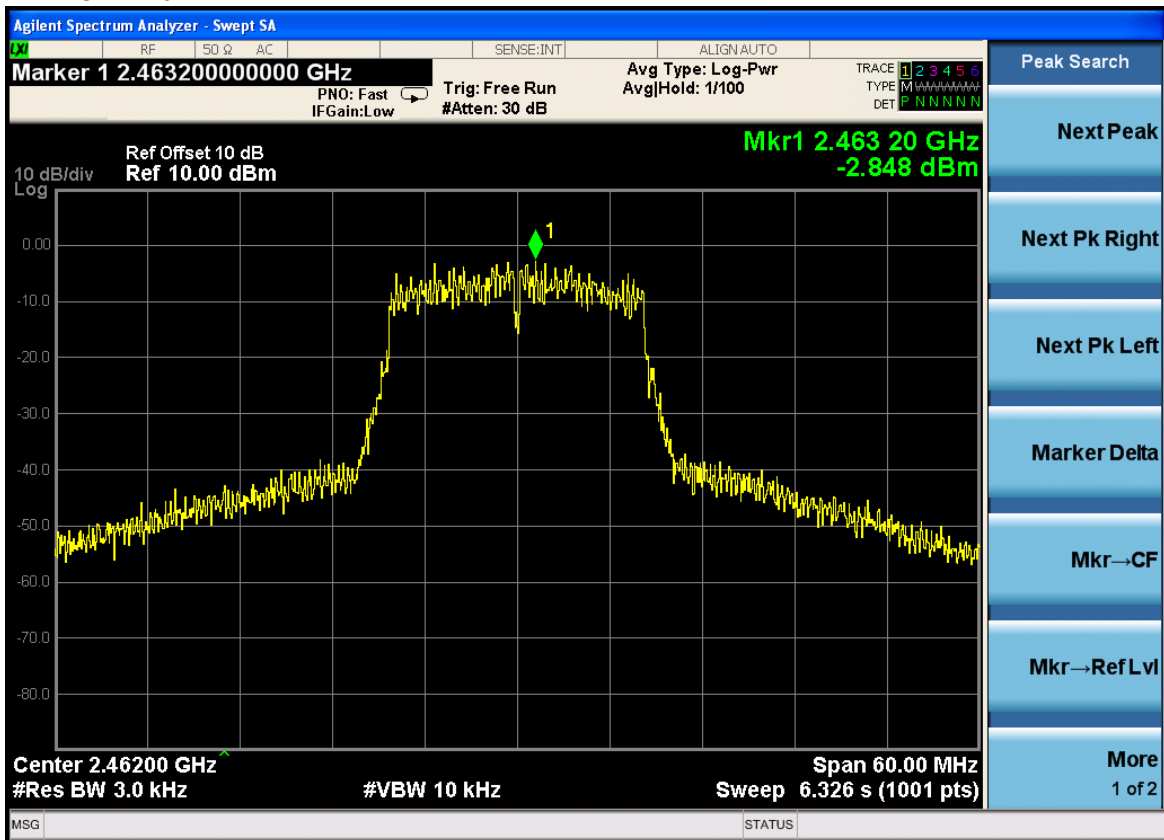



TX 802.11n/HT20 Mode			
Frequency	Power Density (dBm)	Limit (dBm)	Result
2412 MHz	-3.492	8	PASS
2437 MHz	-2.835	8	PASS
2462 MHz	-0.673	8	PASS

CH: 2412MHz

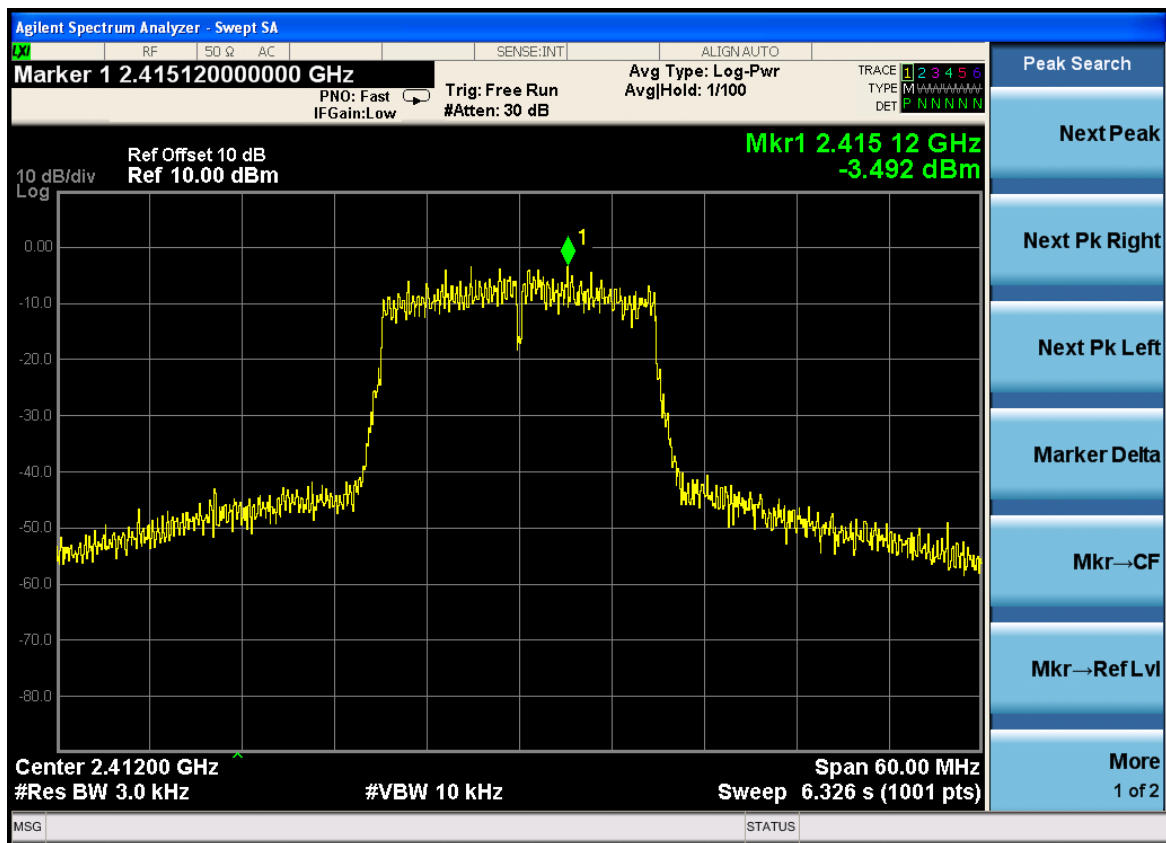



CH: 2437MHz

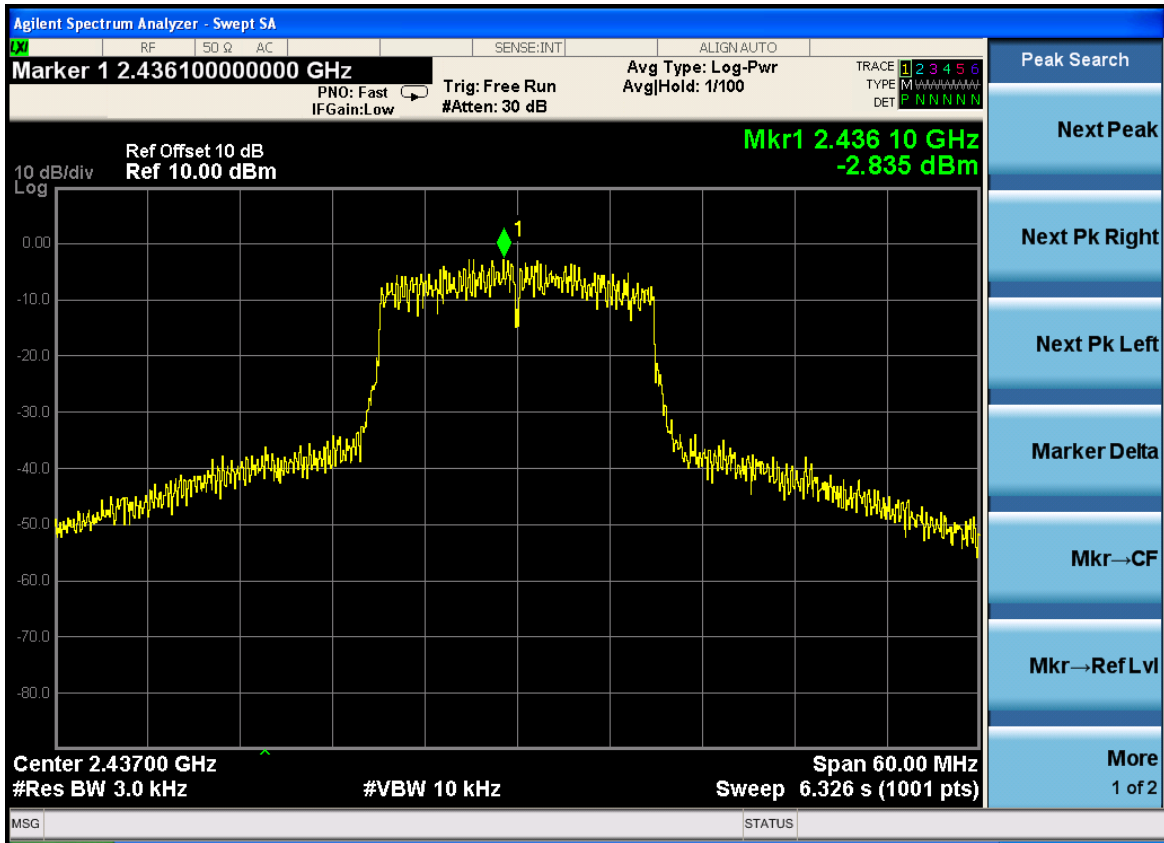

CH: 2462MHz

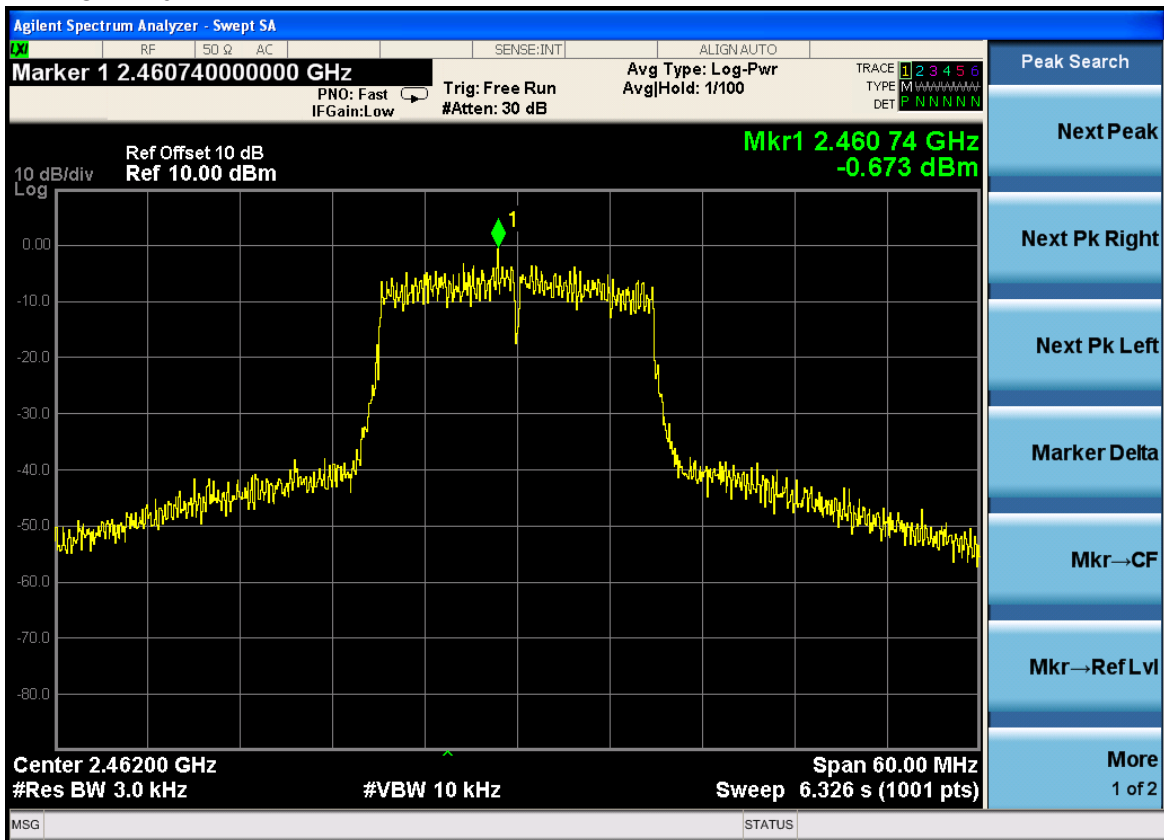



TX 802.11n/HT40 Mode			
Frequency	Power Density (dBm)	Limit (dBm)	Result
2422 MHz	-7.478	8	PASS
2437 MHz	-6.323	8	PASS
2452 MHz	-8.541	8	PASS

CH: 2422MHz

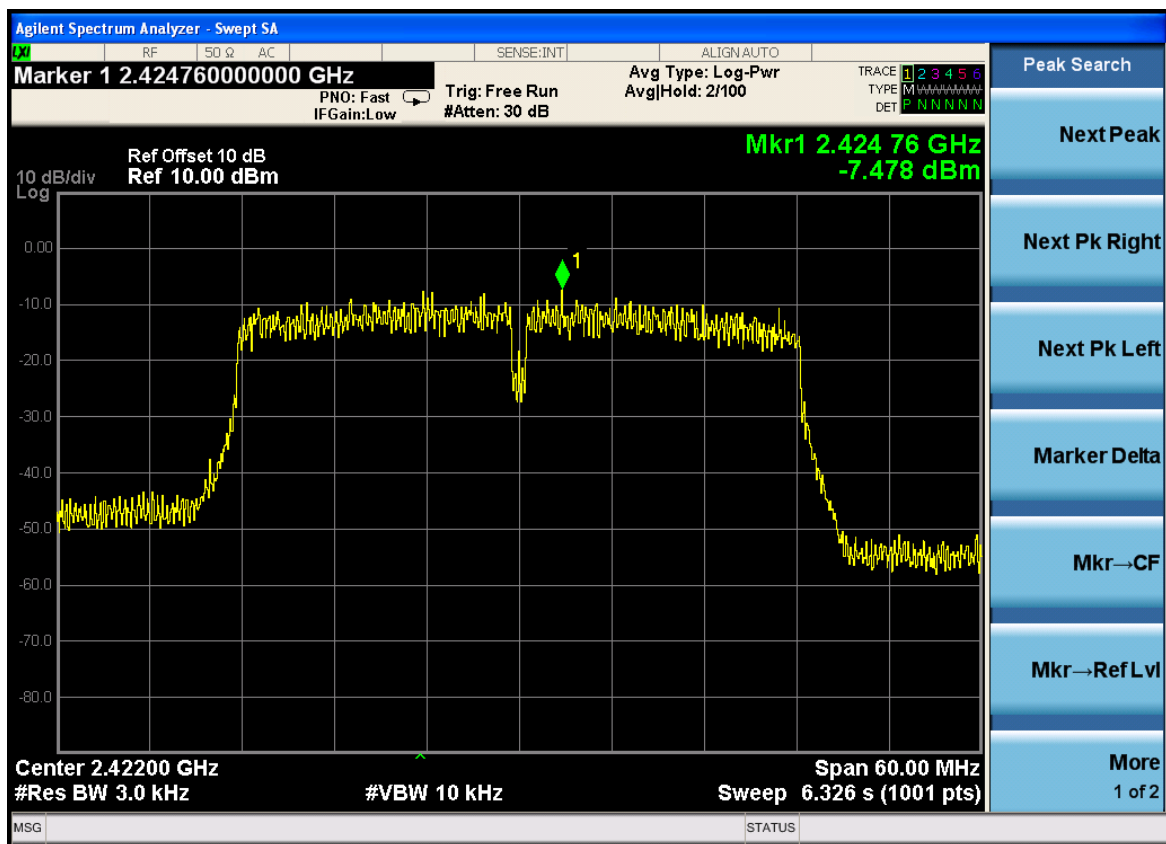



CH: 2437MHz

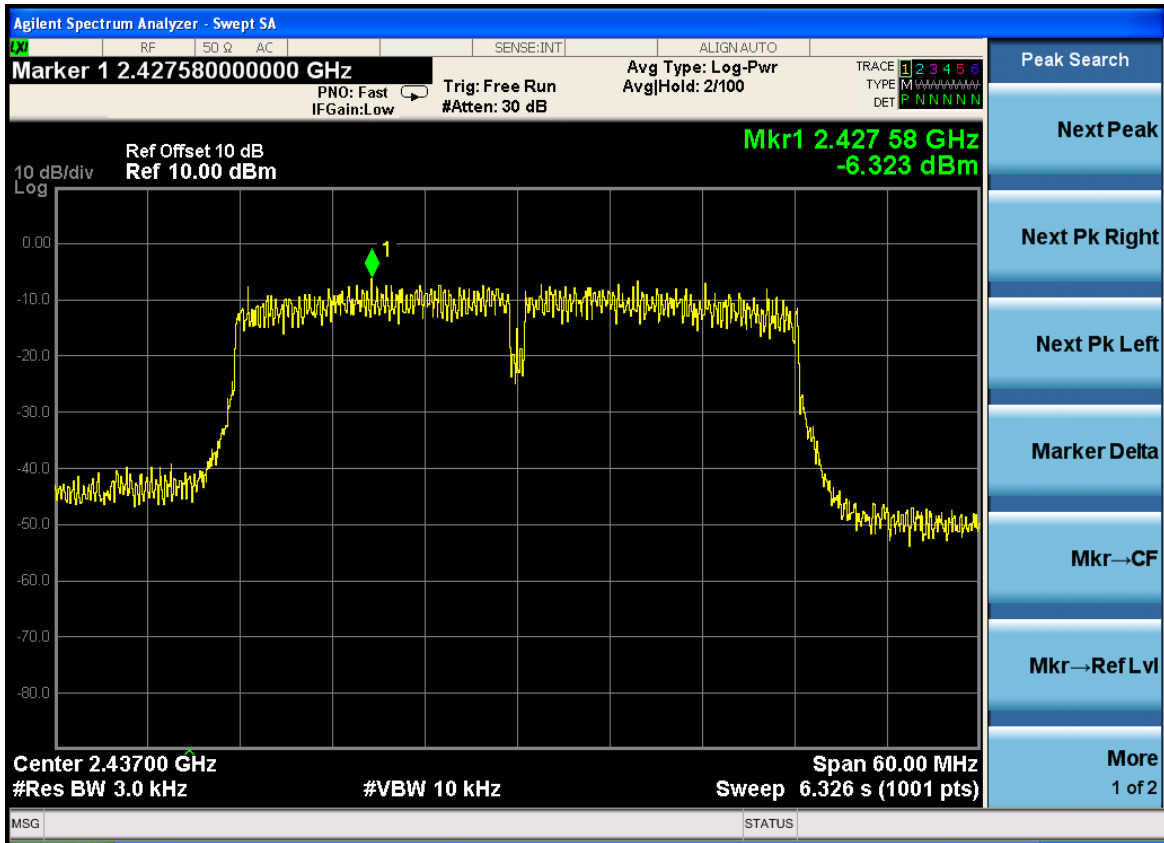

CH: 2452MHz

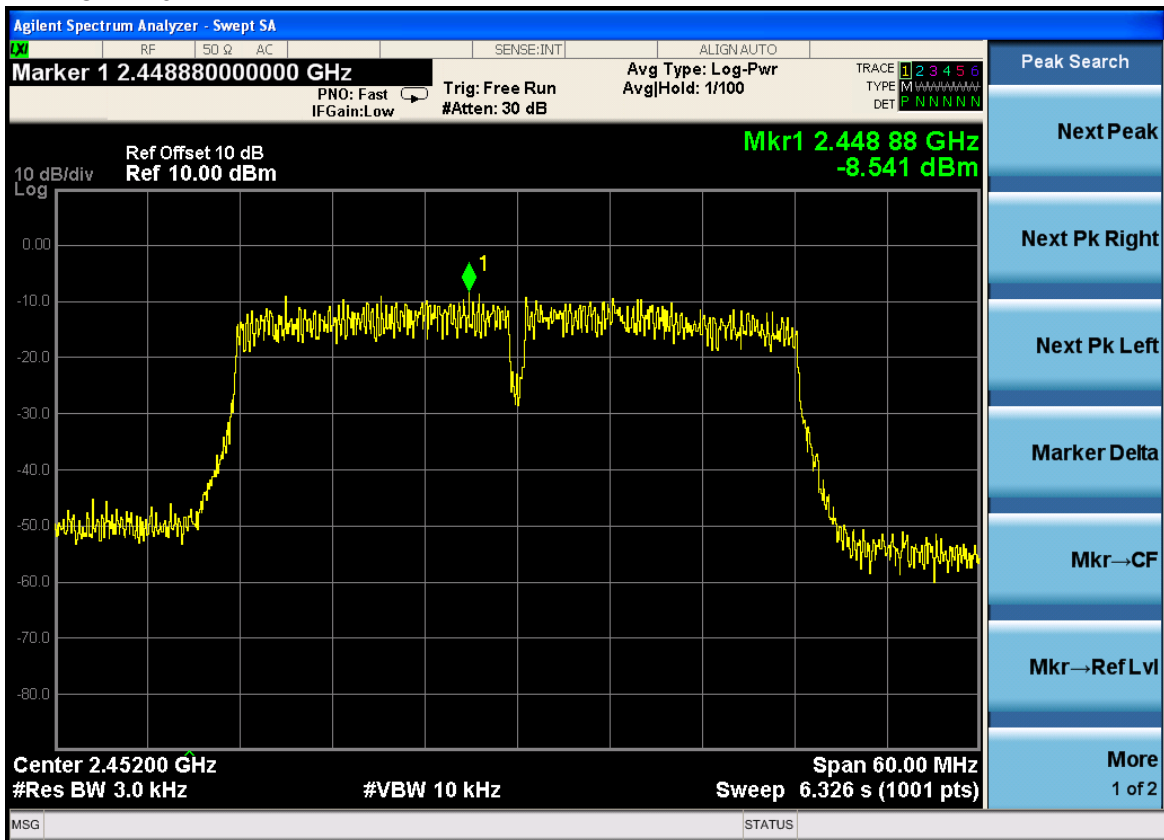



8 PEAK OUTPUT POWER TEST

8.1 Test Limit

FCC Part15 (15.247) , Subpart C				
Section	Test Item	Limit	Frequency Range (MHz)	Result
15.247(b)(3)	Peak Output Power	1 watt or 30dBm	2400-2483.5	PASS

8.2 Test Procedure

1. The EUT was placed on a turn table which is 0.8m above ground plane.
2. The EUT was directly connected to the Power meter.

8.3 Measurement Equipment Used

Same as Radiated Emission Measurement

8.4 Test Result

PASS

All the test modes completed for test.

TX 802.11b Mode			
Test	Frequency	Maximum Peak Conducted Output Power	LIMIT
Channe	(MHz)	(dBm)	dBm
CH01	2412	16.17	30
CH06	2437	16.58	30
CH11	2462	16.26	30
TX 802.11g Mode			
CH01	2412	14.51	30
CH06	2437	14.47	30
CH11	2462	14.68	30
TX 802.11n20 Mode			
CH01	2412	14.33	30
CH06	2437	14.42	30
CH11	2462	14.31	30
TX 802.11n40 Mode			
CH03	2422	12.15	30
CH06	2437	12.13	30
CH09	2452	12.26	30

9 ANTENNA REQUIREMENT

Standard Applicable

For intentional device, according to FCC 47 CFR Section 15.203, an intentional radiator shall be designed to ensure that no antenna other than that furnished by the responsible party shall be used with the device. And according to FCC 47 CFR Section 15.249, if transmitting antennas of directional gain greater than 6dBi are used, the power shall be reduced by the amount in dB that the directional gain of the antenna exceeds 6dBi.

Refer to statement below for compliance.

The manufacturer may design the unit so that the user can replace a broken antenna, but the use of a standard antenna jack or electrical connector is prohibited. Further, this requirement does not apply to intentional radiators that must be professionally installed.

Antenna Connected Construction

The antenna used in this product is a Integral Antenna, The directional gains of antenna used for transmitting is 1dBi.

ANTENNA

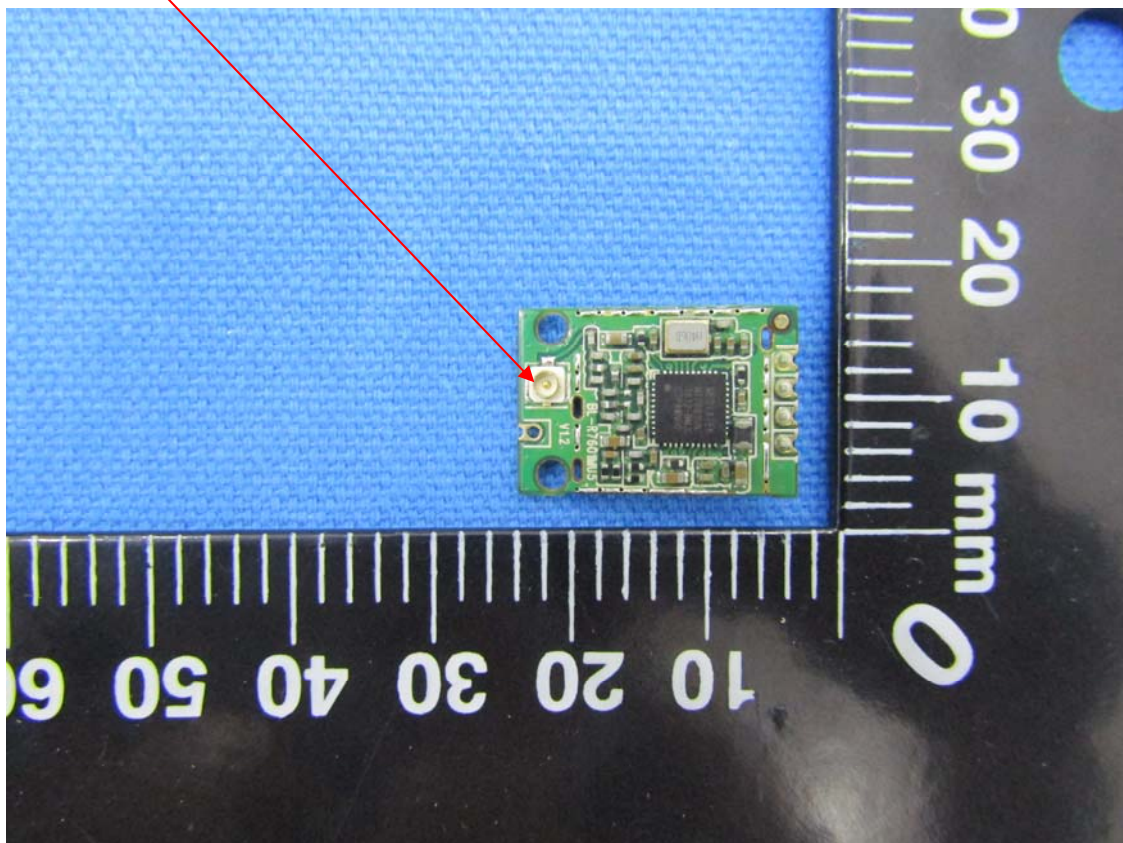

10 PHOTOGRAPH OF TEST

10.1 Radiated Emission





10.2 Conducted Emission

