



Hermon Laboratories Ltd.
Harakevet Industrial Zone, Binyamina 30500,
Israel
Tel. +972-4-6288001
Fax. +972-4-6288277
E-mail: mail@hermonlabs.com

TEST REPORT

ACCORDING TO: FCC CFR 47 Part 15 subpart C, section 15.231 (e) and subpart B;
RSS-210 issue 8 Annex 1, ICES-003 Issue 5:2012

FOR:

CartaSense Ltd.
Wireless Gateway Ethernet
Model: Ethernet USG
FCC ID:2AAEP-LANUSG01
IC:11128A-LANUSG01

This report is in conformity with ISO/IEC 17025. The "A2LA Accredited" symbol endorsement applies only to the tests and calibrations that are listed in the scope of Hermon Laboratories accreditation. The test results relate only to the items tested. This test report shall not be reproduced in any form except in full with the written approval of Hermon Laboratories Ltd.

Table of contents

1	Applicant information	3
2	Equipment under test attributes	3
3	Manufacturer information	3
4	Test details	3
5	Tests summary	4
6	EUT description	5
6.1	General information	5
6.2	Ports and lines	5
6.3	Test configuration	5
6.4	Changes made in EUT	6
6.5	Transceiver characteristics	7
7	Transmitter tests according to 47CFR part 15 subpart C requirements	8
7.1	Periodic operation requirements	8
7.2	Field strength of emissions	14
7.3	Occupied bandwidth test	34
7.4	Conducted emissions	38
7.5	Antenna requirements	41
8	Emissions tests according to 47CFR part 15 subpart B and ICES-003 requirements	42
8.1	Conducted emissions	42
8.2	Radiated emission measurements	46
9	APPENDIX A Test equipment and ancillaries used for tests	54
10	APPENDIX B Measurement uncertainties	55
11	APPENDIX C Test laboratory description	56
12	APPENDIX D Specification references	56
13	APPENDIX E Test equipment correction factors	57
14	APPENDIX F Abbreviations and acronyms	66

1 Applicant information

Client name: CartaSense Ltd.
Address: 6 Ravnitzki St., Industrial Zone Segula, Petah-Tikva 49277, Israel
Telephone: +972 3934 1543
Fax: +972 3930 0877
E-mail: aviv.peled@cartasense.com
Contact name: Mr. Aviv Peled

2 Equipment under test attributes

Product name: Wireless Gateway Ethernet
Product type: Transceiver
Model(s): Ethernet USG
Serial number: 000001418, 000001419
Hardware version: 13
Software release: 4.83
Receipt date 3/11/2013

3 Manufacturer information

Manufacturer name: CartaSense Ltd.
Address: 6 Ravnitzki St., Industrial Zone Segula, Petah-Tikva 49277, Israel
Telephone: +972 3934 1543
Fax: +972 3930 0877
E-Mail: aviv.peled@cartasense.com
Contact name: Mr. Aviv Peled

4 Test details



Project ID: 24192
Location: Hermon Laboratories Ltd. Harakevet Industrial Zone, Binyamina 30500, Israel
Test started: 3/11/2013
Test completed: 3/21/2013
Test specification(s): FCC 47CFR part 15, subpart C, §15.231(e); subpart B;
RSS-210 issue 8 Annex 1, RSS-Gen issue 3; ICES-003 Issue 5:2012

5 Tests summary

Test	Status
Transmitter characteristics	
FCC Part 15, Section 231(e) / RSS-210, Section A1.1.5, Periodic operation requirements	Pass
FCC Part 15, Section 231(e) / RSS-210, Section A1.1.5, Field strength of emissions	Pass
FCC Part 15, Section 231(c) / RSS-210, Section A1.1.3, Occupied bandwidth	Pass
FCC Part 15, Section 207 / RSS-Gen, Section 7.2.4, Conducted emission	Pass
FCC Part 15, Section 203 / RSS-Gen, Section 7.1.2, Antenna requirements	Pass
Unintentional emissions	
FCC section 15.107 / ICES-003, Section 6.1 class B Conducted emission at AC power port	Pass
FCC section 15.109 / ICES-003, Section 6.2 class B, Radiated emission	Pass

Testing was completed against all relevant requirements of the test standard. The results obtained indicate that the product under test complies in full with the requirements tested.

The test results relate only to the items tested. Pass/ fail decision was based on nominal values.

	Name and Title	Date	Signature
Tested by:	Mr. S.Samokha , test engineer	March 21, 2013	
Reviewed by:	Mrs. M. Cherniavsky, certification engineer	May 26, 2013	
Approved by:	Mr. M. Nikishin, EMC and Radio group manager	June 5, 2014	

6 EUT description

6.1 General information

The EUT, a wireless gateway, acts as an access point for the wireless sensor network. It manages the wireless sensors, collects measurements from the sensors network and sends the measurements to a server over the internet (using wireless cellular connection). The device includes Ethernet modem, XportPro, manufactured by Lantronix. The EUT is powered by 12 VDC obtained from AC/DC adapter. The AC/DC adapter manufactured by Shenzhen Fujia Appliance, model FJ-SW1201000U was used throughout the testing. The EUT is equipped with 3.7V internal battery.

6.2 Ports and lines

Port type	Port description	Connected from	Connected to	Qty.	Cable type	Cable length	Indoor / outdoor
Power	AC power	AC/DC adapter	AC mains	1	Unshielded	1.5 m	Indoor
Power	DC power	EUT	AC/DC adapter	1	Unshielded	1.5 m	Indoor
Telecom	Ethernet	EUT	Network	1	Shielded	3 m	Indoor
Signal	RF	EUT	Antenna	1	Coax	3 m	Indoor
Signal	USB*	EUT	Open circuit	1	Shielded	1.2 m	Indoor
Signal	D-Type 25 pin*	EUT	Not connected	1	NA	NA	NA

* Used for debugging only.

6.3 Test configuration

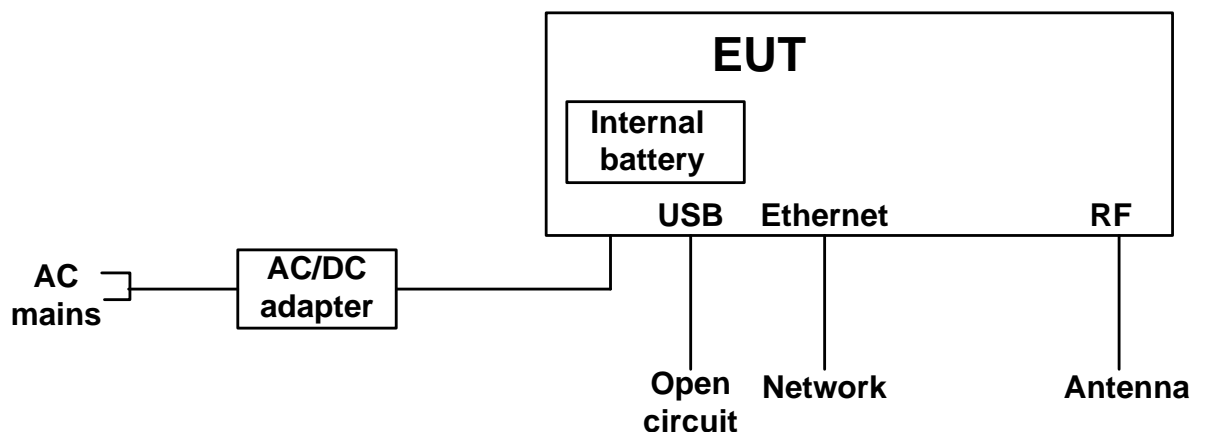

6.4 Changes made in EUT

To withstand the standard requirements, the following changes were made in the EUT during the testing.

- 1) Two capacitors (one of 100pF and the second one of 10pF) were installed at pins 1&2 of XportPro as shown in Photograph 6.4.1.
- 2) Two capacitors (one of 100pF and the second one of 10pF) were installed at pins 2&CH of XportPro as shown in Photograph 6.4.1.

It is manufacturer responsibility to implement the changes in the production version of the EUT. In any case the test report applies to the tested item only.

Photograph 6.4.1 Changes made in the EUT

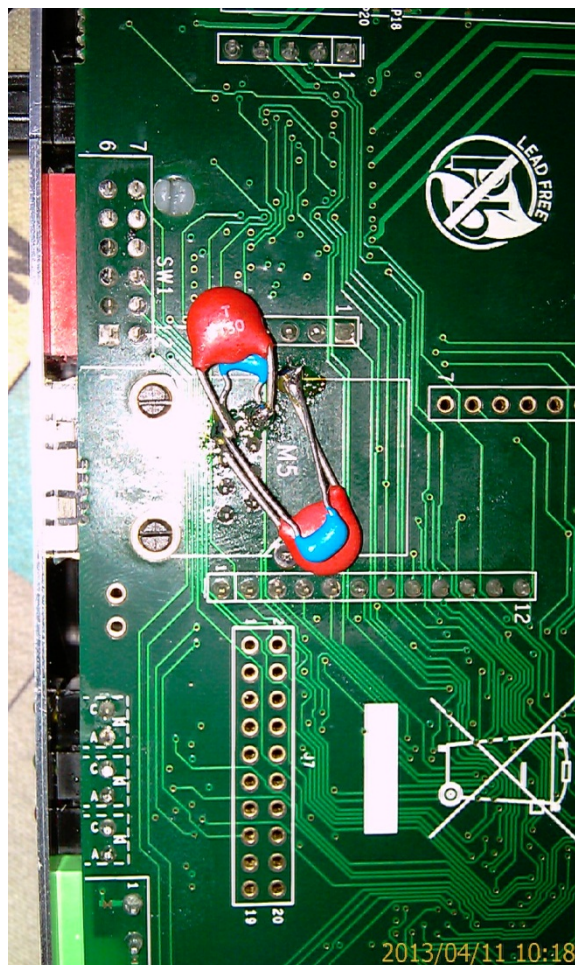



6.5 Transceiver characteristics

Type of equipment						
X	Stand-alone (Equipment with or without its own control provisions)					
	Combined equipment (Equipment where the radio part is fully integrated within another type of equipment)					
	Plug-in card (Equipment intended for a variety of host systems)					
Operating frequencies		433.75 MHz, 433.90 MHz, 434.05 MHz, 434.20 MHz				
Maximum rated output power		Field strength at 3 m distance		83.9 dB(μV/m)		
Is transmitter output power variable?		X	No			
			continuous variable			
			stepped variable with stepsize		dB	
		Yes	minimum RF power		dBm	
		maximum RF power		dBm		
Antenna connection						
X	unique coupling	standard connector	integral	X	with temporary RF connector without temporary RF connector	
Antenna/s technical characteristics						
Type	Manufacturer	Model number		Antenna gain		
Omni-directional	Panorama Antennas	MD-T2-3SMAP-FAKRA		2 dBi		
Omni-directional	YueYoung Electronics	YUE-CZ-433-2		2 dBi		
Transmitter aggregate data rate/s		19.2 kbps				
Type of modulation		GFSK				
Modulating test signal (baseband)		PRBS				
Maximum transmitter duty cycle		0.85 %				
Transmitter power source						
X	Battery	Nominal rated voltage	3.7 VDC	Battery type	Lithium	
X	DC	Nominal rated voltage	12 VDC via AC/DC adapter			
	AC mains	Nominal rated voltage		Frequency		
Common power source for transmitter and receiver			X	yes	no	



Test specification:	FCC Part 15, Section 231(e) / RSS-210, Section A1.1.5, Periodic operation requirements		
Test procedure:	Supplier declaration		
Test mode:	Compliance	Verdict:	PASS
Date(s):	3/12/2013		
Temperature: 24.0 °C	Air Pressure: 1013 hPa	Relative Humidity: 39 %	Power Supply: 120 VAC
Remarks:			

7 Transmitter tests according to 47CFR part 15 subpart C and RSS-210 requirements

7.1 Periodic operation requirements

7.1.1 General

The EUT was verified for compliance with periodic operation requirements listed below:

- Continuous transmissions such as voice, video and the radio control of toys are not permitted;
- Duration of each transmission shall not be greater than 1 second;
- Silent period between transmissions shall be at least 30 times the duration of the transmission;
- Silent period between transmissions shall be in no case less than 10 seconds.

The rationale for compliance with the above requirements was either test results or supplier declaration. The summary of results is provided in Table 7.1.1.

7.1.2 Test procedure for transmitter shut down test

7.1.2.1 The EUT was set up as shown in Figure 7.1.1.

7.1.2.2 The spectrum analyzer center frequency was adjusted to the EUT carrier, span set to zero and video triggered for transmission.

7.1.2.3 The transmitter was activated either manually or automatically. Once manually operated transmitter was activated, the switch was immediately released.

7.1.2.4 The transmission time was captured and shown in the associated plots. The test results were recorded in **Error! Reference source not found.**

Figure 7.1.1 Setup for transmitter shut down test





Test specification:	FCC Part 15, Section 231(e) / RSS-210, Section A1.1.5, Periodic operation requirements		
Test procedure:	Supplier declaration		
Test mode:	Compliance	Verdict: PASS	
Date(s):	3/12/2013		
Temperature: 24.0 °C	Air Pressure: 1013 hPa	Relative Humidity: 39 %	Power Supply: 120 VAC
Remarks:			

Table 7.1.1 Periodic operation requirements

Requirement	Rationale	Verdict
Continuous transmissions are not permitted	Supplier declaration	Comply
Duration of each transmission shall not be greater than 1 second	Plot 7.1.1	Comply
Silent period between transmissions shall be at least 30 times the duration of the transmission	Plot 7.1.5, Plot 7.1.6	Comply
Silent period between transmissions shall be in no case less than 10 seconds	Plot 7.1.6	Comply

Plot 7.1.1 Transmitter pulse duration

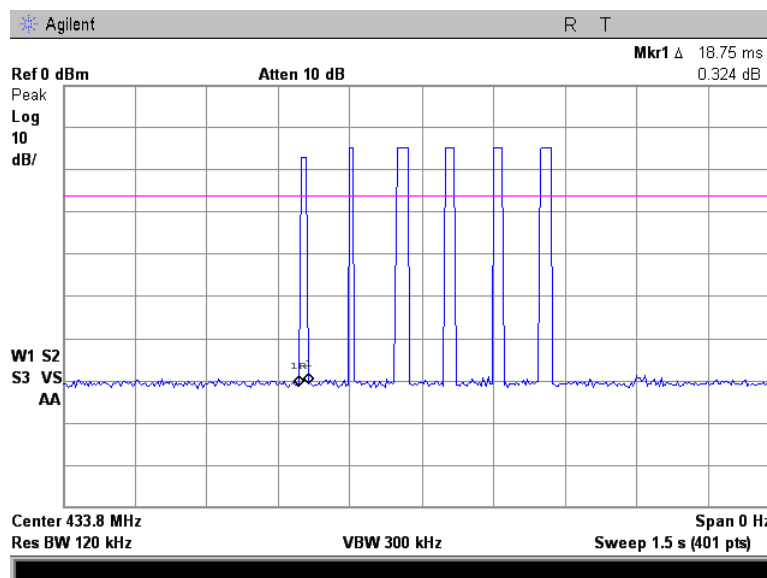



Test specification:	FCC Part 15, Section 231(e) / RSS-210, Section A1.1.5, Periodic operation requirements		
Test procedure:	Supplier declaration		
Test mode:	Compliance	Verdict: PASS	
Date(s):	3/12/2013		
Temperature: 24.0 °C	Air Pressure: 1013 hPa	Relative Humidity: 39 %	Power Supply: 120 VAC
Remarks:			

Plot 7.1.2 Transmitter pulse duration

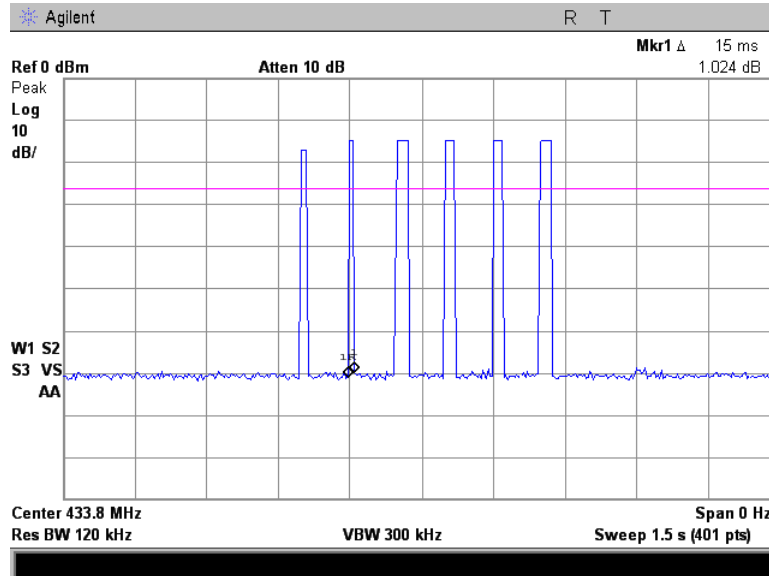

Plot 7.1.3 Transmitter pulse duration

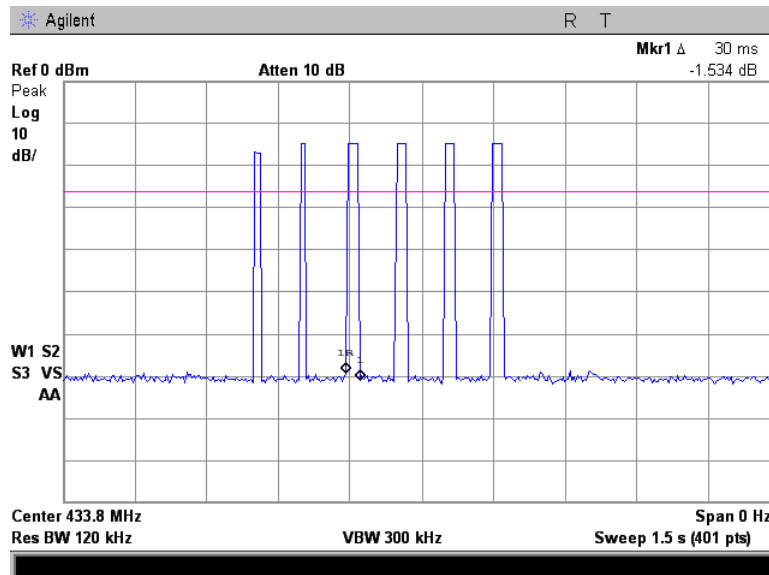



Test specification:	FCC Part 15, Section 231(e) / RSS-210, Section A1.1.5, Periodic operation requirements		
Test procedure:	Supplier declaration		
Test mode:	Compliance	Verdict: PASS	
Date(s):	3/12/2013		
Temperature: 24.0 °C	Air Pressure: 1013 hPa	Relative Humidity: 39 %	Power Supply: 120 VAC
Remarks:			

Plot 7.1.4 Transmission pulse period

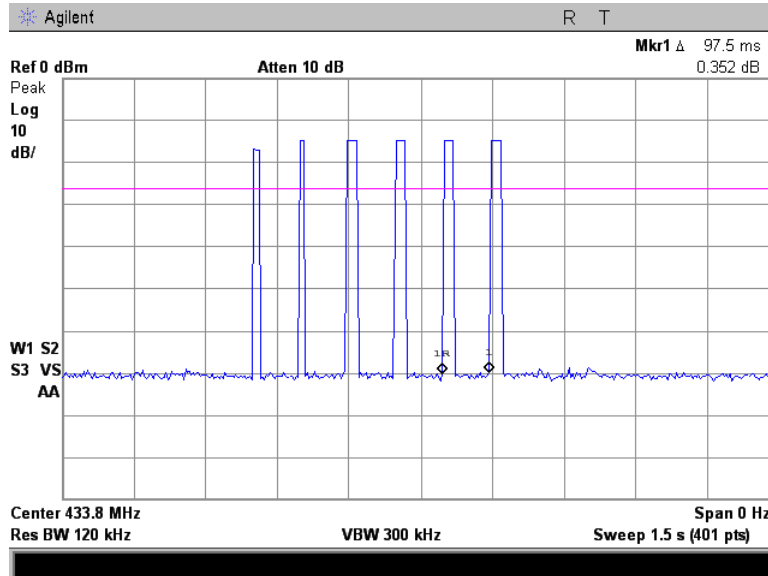



Test specification:	FCC Part 15, Section 231(e) / RSS-210, Section A1.1.5, Periodic operation requirements		
Test procedure:	Supplier declaration		
Test mode:	Compliance	Verdict:	PASS
Date(s):	3/12/2013		
Temperature: 24.0 °C	Air Pressure: 1013 hPa	Relative Humidity: 39 %	Power Supply: 120 VAC
Remarks:			

Plot 7.1.5 Transmission burst duration

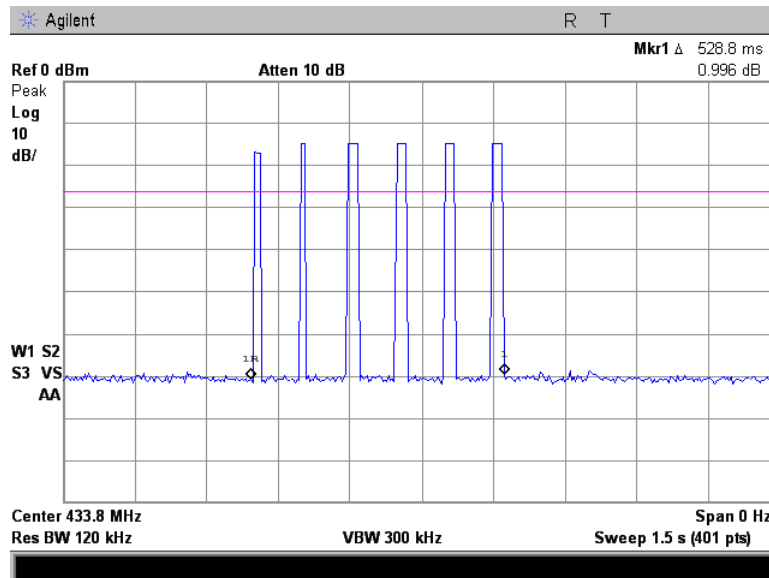

Plot 7.1.6 Transmission burst period

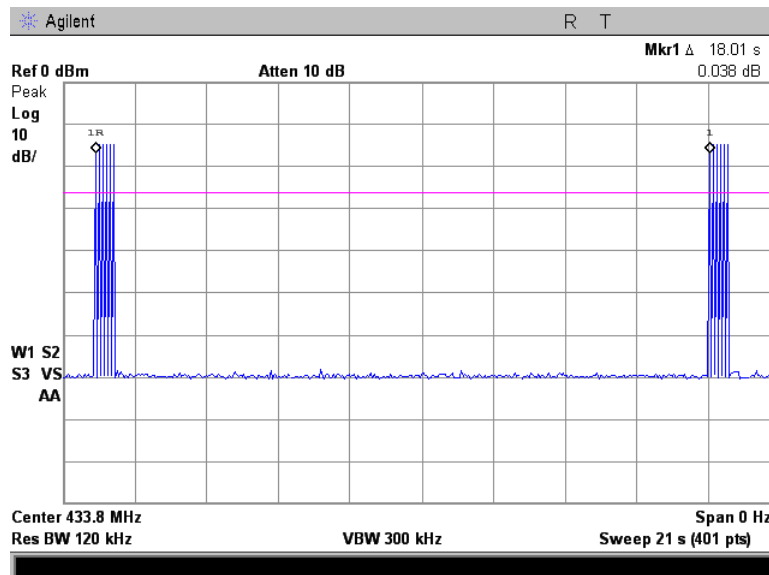



HERMON LABORATORIES

Test specification:	FCC Part 15, Section 231(e) / RSS-210, Section A1.1.5, Periodic operation requirements		
Test procedure:	Supplier declaration		
Test mode:	Compliance	Verdict:	PASS
Date(s):	3/12/2013		
Temperature: 24.0 °C	Air Pressure: 1013 hPa	Relative Humidity: 39 %	Power Supply: 120 VAC
Remarks:			

Table 7.1.2 Total duration of transmissions

Pulse duration, ms	Pulse period, ms	Total transmission duration, ms	Silent period between transmissions, s	Silent period between transmissions limit, s	Margin, s	Verdict
30	97.75	153.75	18.01	10.0	-8.0	Pass

Reference numbers of test equipment used

HL 2909	HL 3787	HL 4273				
---------	---------	---------	--	--	--	--

Full description is given in Appendix A.



Test specification:		FCC Part 15, Section 231(e) / RSS-210, Section A1.1.5, Field strength of emissions	
Test procedure:		ANSI C63.4, Section 13.1.4	
Test mode:		Compliance	
Date(s):		3/17/2013	
Temperature: 23.2 °C		Air Pressure: 1018 hPa	
Remarks:		Relative Humidity: 41 %	
		Power Supply: 120 VAC	
Verdict: PASS			

7.2 Field strength of emissions

7.2.1 General

This test was performed to measure field strength of fundamental and spurious emissions from the EUT. Specification test limits are given in Table 7.2.1 and Table 7.2.2.

Table 7.2.1 Radiated fundamental emission limits

Fundamental frequency, MHz	Field strength at 3 m, dB(μV/m)	
	Peak	Average
433.75	92.9	72.9
434.20	92.9	72.9

Table 7.2.2 Radiated spurious emissions limits

Frequency, MHz	Field strength at 3 m, dB(μV/m)				
	Within restricted bands			Outside restricted bands	
	Peak	Quasi Peak	Average	Peak	Average
0.009 – 0.090	148.5 – 128.5	NA	128.5 – 108.5**	72.9	52.9
0.090 – 0.110	NA	108.5 – 106.8**	NA		
0.110 – 0.490	126.8 – 113.8	NA	106.8 – 93.8**		
0.490 – 1.705	NA	73.8 – 63.0**	NA		
1.705 – 30.0*		69.5			
30 – 88		40.0			
88 – 216		43.5			
216 – 960		46.0			
960 - 1000		54.0			
Above 1000	74.0	NA	54.0		

*- The limit for 3 m test distance was calculated using the inverse square distance extrapolation factor as follows:

$$\text{Lim}_{S_2} = \text{Lim}_{S_1} + 40 \log (S_1/S_2),$$

where S_1 and S_2 – standard defined and test distance respectively in meters.

**- The limit decreases linearly with the logarithm of frequency.

The limit for spurious emissions was 20 dB lower than fundamental emission limit.

The above limits provided in terms of average values, peak limit was 20 dB above the average limit.

Note 2: The above field strength limits applied from the lowest radio frequency generated in the device, without going below 9 kHz up to the tenth harmonic of the highest fundamental frequency.



Test specification:		FCC Part 15, Section 231(e) / RSS-210, Section A1.1.5, Field strength of emissions	
Test procedure:		ANSI C63.4, Section 13.1.4	
Test mode:		Compliance	
Date(s):		3/17/2013	
Temperature: 23.2 °C		Air Pressure: 1018 hPa	Relative Humidity: 41 %
Remarks:		Verdict: PASS	
		Power Supply: 120 VAC	

7.2.2 Test procedure for spurious emission field strength measurements in 9 kHz to 30 MHz band

7.2.2.1 The EUT was set up as shown in Figure 7.2.1 The worst test results (the lowest margins) were recorded in Table 7.2.3, Table 7.2.5 and shown in the associated plots.

7.2.2.2 Figure 7.2.1, energized and the performance check was conducted.

7.2.2.3 The specified frequency range was investigated with antenna connected to spectrum analyzer/ EMI receiver. To find maximum radiation the turntable was rotated 360° and the measuring antenna was rotated around its vertical axis.

7.2.2.4 The worst test results (the lowest margins) were recorded in Table 7.2.3, Table 7.2.5 and shown in the associated plots.

7.2.3 Test procedure for spurious emission field strength measurements above 30 MHz

7.2.3.1 The EUT was set up as shown in Figure 7.2.2, energized and the performance check was conducted.

7.2.3.2 The specified frequency range was investigated with antenna connected to spectrum analyzer/ EMI receiver. To find maximum radiation the turntable was rotated 360°, the measuring antenna height was changed from 1 to 4 m, its polarization was switched from vertical to horizontal.

7.2.3.3 The worst test results (the lowest margins) were recorded in Table 7.2.3, Table 7.2.5 and shown in the associated plots.

Figure 7.2.1 Setup for spurious emission field strength measurements below 30 MHz

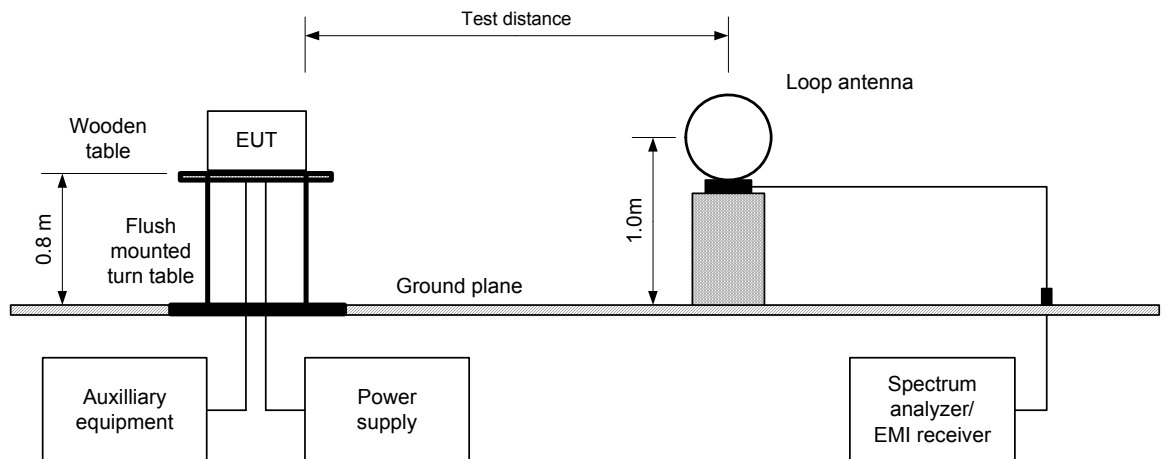



Test specification:	FCC Part 15, Section 231(e) / RSS-210, Section A1.1.5, Field strength of emissions		
Test procedure:	ANSI C63.4, Section 13.1.4		
Test mode:	Compliance	Verdict:	PASS
Date(s):	3/17/2013		
Temperature: 23.2 °C	Air Pressure: 1018 hPa	Relative Humidity: 41 %	Power Supply: 120 VAC
Remarks:			

Figure 7.2.2 Setup for spurious emission field strength measurements above 30 MHz

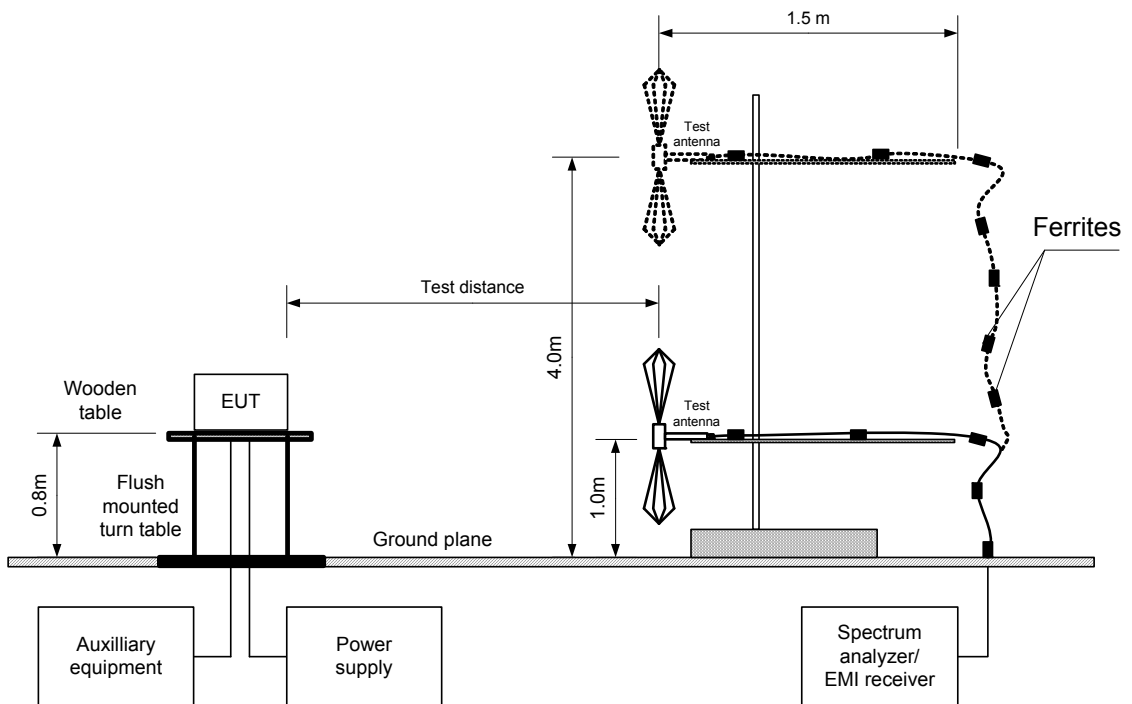



Test specification: FCC Part 15, Section 231(e) / RSS-210, Section A1.1.5, Field strength of emissions			
Test procedure: ANSI C63.4, Section 13.1.4			
Test mode: Compliance		Verdict: PASS	
Date(s): 3/17/2013			
Temperature: 23.2 °C	Air Pressure: 1018 hPa	Relative Humidity: 41 %	Power Supply: 120 VAC
Remarks:			

Table 7.2.3 Field strength of fundamental emission, spurious emissions outside restricted bands and within restricted bands at frequencies above 1 GHz

TEST DISTANCE: 3 m
 EUT POSITION: Typical (Vertical)
 MODULATION: FSK
 MODULATING SIGNAL: PRBS
 BIT RATE: 19.2 kbps
 TRANSMITTER OUTPUT POWER SETTINGS: Maximum
 INVESTIGATED FREQUENCY RANGE: 0.009 - 4500 MHz
 DETECTOR USED: Peak
 RESOLUTION BANDWIDTH: 1.0 kHz (9 kHz – 150 kHz)
 9.0 kHz (150 kHz – 30 MHz)
 120 kHz (30 MHz – 1000 MHz)
 1.0 MHz (above 1000 MHz)
 VIDEO BANDWIDTH: ≥ Resolution bandwidth
 TEST ANTENNA TYPE: Active loop (9 kHz – 30 MHz)
 Biconilog (30 MHz – 1000 MHz)
 Double ridged guide (above 1000 MHz)

F, MHz	Antenna		Azimuth, degrees*	Peak field strength			Average field strength				Verdict
	Pol.	Height, m		Measured, dB(μV/m)	Limit, dB(μV/m)	Margin, dB**	Measured, dB(μV/m)	Calculated, dB(μV/m)	Limit, dB(μV/m)	Margin, dB**	
Fundamental emission***											
433.705	Vert	1.1	94	83.90	92.9	-9.00	80.51	70.27	72.9	-2.63	Pass
434.155	Vert	1.0	76	83.87	92.9	-9.03	80.47	70.23	72.9	-2.67	
Spurious emissions											
Low frequency 433.75 MHz											
867.415	Vert	1.0	119	49.69	72.9	-23.21	49.69	39.45	52.9	-13.45	Pass
1301.462	Vert	1.2	298	60.81	74.0	-13.19	60.81	50.57	54.0	-3.43	
868.490	Vert	1.0	119	49.28	72.9	-23.62	49.28	39.04	52.9	-13.86	
1302.475	Vert	1.2	298	59.73	74.0	-14.27	59.73	49.49	54.0	-4.51	

*- EUT front panel refers to 0 degrees position of turntable.
 **- Margin = dB below (negative if above) specification limit.

Table 7.2.4 Average factor calculation

Transmission pulse		Transmission burst		Transmission train duration, ms	Average factor, dB
Duration, ms	Period, ms	Duration, ms	Period, s		
30.0	97.5	528.8	18.01	NA	-10.24

*- Average factor was calculated as follows

for pulse train shorter than 100 ms:

$$Average\ factor = 20 \times \log_{10} \left(\frac{Pulse\ duration}{Pulse\ period} \times \frac{Burst\ duration}{Train\ duration} \times Number\ of\ bursts\ within\ pulse\ train \right)$$

for pulse train longer than 100 ms:

$$Average\ factor = 20 \times \log_{10} \left(\frac{Pulse\ duration}{Pulse\ period} \times \frac{Burst\ duration}{100\ ms} \times Number\ of\ bursts\ within\ 100\ ms \right)$$

Reference numbers of test equipment used

HL 0446	HL 0604	HL 1984	HL 2780	HL 2871	HL 4353	
---------	---------	---------	---------	---------	---------	--

Full description is given in Appendix A.



Test specification: FCC Part 15, Section 231(e) / RSS-210, Section A1.1.5, Field strength of emissions	
Test procedure: ANSI C63.4, Section 13.1.4	
Test mode: Compliance	Verdict: PASS
Date(s): 3/17/2013	
Temperature: 23.2 °C	Air Pressure: 1018 hPa
Remarks:	

Table 7.2.5 Field strength of emissions below 1 GHz within restricted bands

TEST DISTANCE: 3 m
 EUT POSITION: Typical (Vertical)
 MODULATION: FSK
 MODULATING SIGNAL: PRBS
 BIT RATE: 19.2 kbps
 TRANSMITTER OUTPUT POWER SETTINGS: Maximum
 INVESTIGATED FREQUENCY RANGE: 0.009 – 1000 MHz
 DETECTOR USED: Peak
 RESOLUTION BANDWIDTH: 1.0 kHz (9 kHz – 150 kHz)
 9.0 kHz (150 kHz – 30 MHz)
 120 kHz (30 MHz – 1000 MHz)
 VIDEO BANDWIDTH: ≥ Resolution bandwidth
 TEST ANTENNA TYPE: Active loop (9 kHz – 30 MHz)
 Biconilog (30 MHz – 1000 MHz)

Frequency, MHz	Peak emission, dB(µV/m)	Quasi-peak			Antenna polarization	Antenna height, m	Turn-table position**, degrees	Verdict
		Measured emission, dB(µV/m)	Limit, dB(µV/m)	Margin, dB*				
Low frequency 433.75 MHz								
74.93	38.14	31.90	40.0	-8.10	Vert	1.0	335	Pass
115.40	37.88	32.74	43.5	-10.76	Vert	1.0	339	
403.70	37.57	36.34	46.0	-9.66	Vert	1.0	66	
960.007	40.53	38.09	54.0	-15.91	Vert	1.1	97	
High frequency 434.20 MHz								
75.04	38.84	31.85	40.0	-8.15	Vert	1.0	335	Pass
112.70	35.19	29.19	43.5	-14.31	Vert	1.0	339	
132.60	38.64	33.22	43.5	-10.28	Vert	1.0	260	
404.20	40.05	37.85	46.0	-8.15	Vert	1.0	86	
960.007	40.53	38.09	54.0	-15.91	Vert	1.1	97	

*- Margin = Measured emission - specification limit.
 **- EUT front panel refer to 0 degrees position of turntable.

Reference numbers of test equipment used

HL 0604	HL 2780	HL 2871	HL 4353			
---------	---------	---------	---------	--	--	--

Full description is given in Appendix A.



Test specification:		FCC Part 15, Section 231(e) / RSS-210, Section A1.1.5, Field strength of emissions			
Test procedure:		ANSI C63.4, Section 13.1.4			
Test mode:		Compliance		Verdict: PASS	
Date(s):		3/17/2013			
Temperature: 23.2 °C		Air Pressure: 1018 hPa		Relative Humidity: 41 %	
Remarks:		Power Supply: 120 VAC			

Table 7.2.6 Restricted bands according to FCC 15, Section 205

MHz	MHz	MHz	MHz	MHz	GHz
0.09 - 0.11	8.37625 - 8.38675	73 - 74.6	399.9 - 410	2690 - 2900	10.6 - 12.7
0.495 - 0.505	8.41425 - 8.41475	74.8 - 75.2	608 - 614	3260 - 3267	13.25 - 13.4
2.1735 - 2.1905	12.290 - 12.293	108 - 121.94	960 - 1240	3332 - 3339	14.47 - 14.5
4.125 - 4.128	12.51975 - 12.52025	123 - 138	1300 - 1427	3345.8 - 3358	15.35 - 16.2
4.17725 - 4.17775	12.57675 - 12.57725	149.9 - 150.05	1435 - 1626.5	3600 - 4400	17.7 - 21.4
4.20725 - 4.20775	13.36 - 13.41	156.52475 - 156.52525	1645.5 - 1646.5	4500 - 5150	22.01 - 23.12
6.215 - 6.218	16.420 - 16.423	156.7 - 156.9	1660 - 1710	5350 - 5460	23.6 - 24
6.26775 - 6.26825	16.69475 - 16.69525	162.0125 - 167.17	1718.8 - 1722.2	7250 - 7750	31.2 - 31.8
6.31175 - 6.31225	16.80425 - 16.80475	167.72 - 173.2	2200 - 2300	8025 - 8500	36.43 - 36.5
8.291 - 8.294	25.5 - 25.67	240 - 285	2310 - 2390	9000 - 9200	Above 38.6
8.362 - 8.366	37.5 - 38.25	322 - 335.4	2483.5 - 2500	9300 - 9500	

Table 7.2.7 Restricted bands according to RSS-210, Section 2.7

MHz	MHz	MHz	MHz	MHz	GHz
0.09 - 0.11	8.291 - 8.294	16.80425 - 16.80475	399.9 - 410	3260 - 3267	10.6 - 12.7
2.1735 - 2.190	8.362 - 8.366	25.5 - 25.67	608 - 614	3332 - 3339	13.25 - 13.4
3.020 - 3.026	8.37625 - 8.38675	37.5 - 38.25	960 - 1427	3345.8 - 3358	14.47 - 14.5
4.125 - 4.128	8.41425 - 8.41475	73 - 74.6	1435 - 1626.5	3500 - 4400	15.35 - 16.2
4.17725 - 4.17775	12.290 - 12.293	74.8 - 75.2	1645.5 - 1646.5	4500 - 5150	17.7 - 21.4
4.20725 - 4.20775	12.51975 - 12.52025	108 - 138	1660 - 1710	5350 - 5460	22.01 - 23.12
5.677 - 5.683	12.57675 - 12.57725	156.52475 - 156.52525	1718.8 - 1722.2	7250 - 7750	23.6 - 24.0
6.215 - 6.218	13.36 - 13.41	156.7 - 156.9	2200 - 2300	8025 - 8500	31.2 - 31.8
6.26775 - 6.26825	16.42 - 16.423	240 - 285	2310 - 2390	9000 - 9200	36.43 - 36.5
6.31175 - 6.31225	16.69475 - 16.69525	322 - 335.4	2655 - 2900	9300 - 9500	Above 38.6



HERMON LABORATORIES

Test specification: FCC Part 15, Section 231(e) / RSS-210, Section A1.1.5, Field strength of emissions			
Test procedure: ANSI C63.4, Section 13.1.4			
Test mode: Compliance	Verdict: PASS		
Date(s): 3/17/2013			
Temperature: 23.2 °C	Air Pressure: 1018 hPa	Relative Humidity: 41 %	Power Supply: 120 VAC
Remarks:			

Plot 7.2.1 Radiated emission measurements at the low carrier frequency

TEST SITE:
TEST DISTANCE:
INPUT VOLTAGE:
EUT POSITION:
ANTENNA POLARIZATION:
DETECTOR: Peak

Semi anechoic chamber
3 m
Unom
Typical (Vertical)
Vertical
DETECTOR: Average

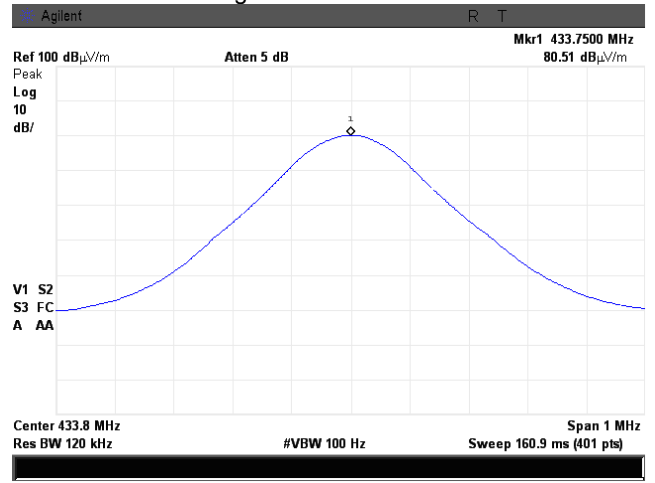
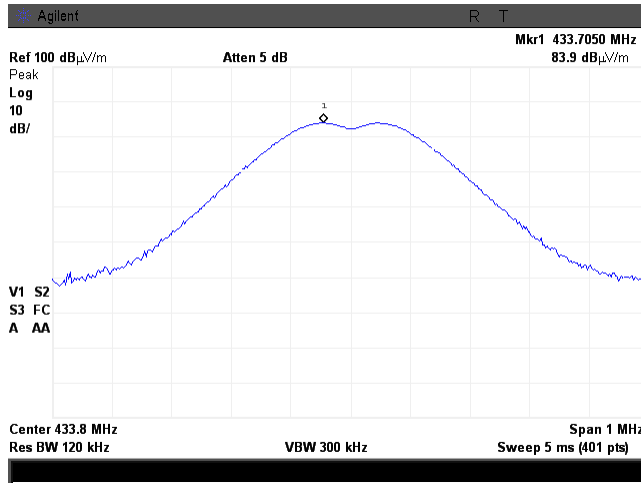

Plot 7.2.2 Radiated emission measurements at the low carrier frequency

TEST SITE:
TEST DISTANCE:
INPUT VOLTAGE:
EUT POSITION:
ANTENNA POLARIZATION:
DETECTOR: Peak

Semi anechoic chamber
3 m
Unom
Typical (Vertical)
Horizontal
DETECTOR: Average

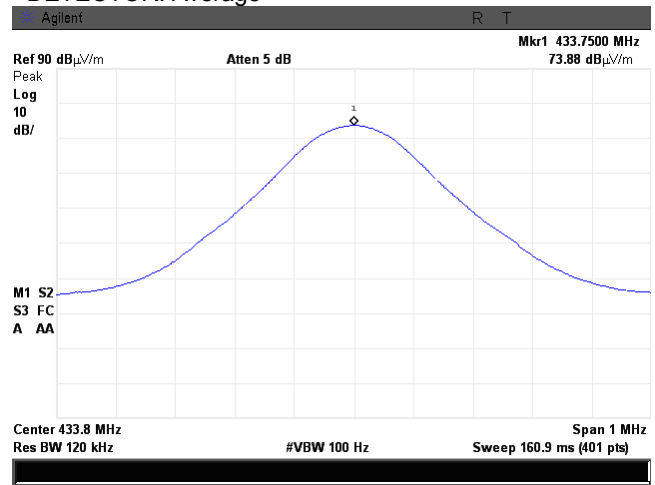
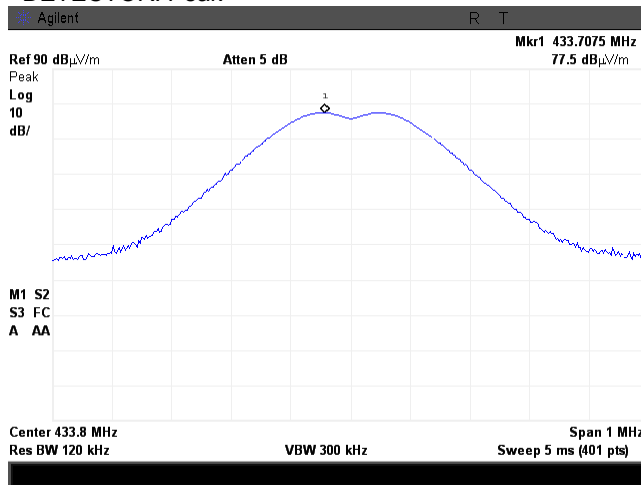



HERMON LABORATORIES

Test specification: FCC Part 15, Section 231(e) / RSS-210, Section A1.1.5, Field strength of emissions			
Test procedure: ANSI C63.4, Section 13.1.4			
Test mode: Compliance	Verdict: PASS		
Date(s): 3/17/2013			
Temperature: 23.2 °C	Air Pressure: 1018 hPa	Relative Humidity: 41 %	Power Supply: 120 VAC
Remarks:			

Plot 7.2.3 Radiated emission measurements at the high carrier frequency

TEST SITE:
TEST DISTANCE:
INPUT VOLTAGE:
EUT POSITION:
ANTENNA POLARIZATION:
DETECTOR: Peak

Semi anechoic chamber
3 m
Unom
Typical (Vertical)
Vertical
DETECTOR: Average

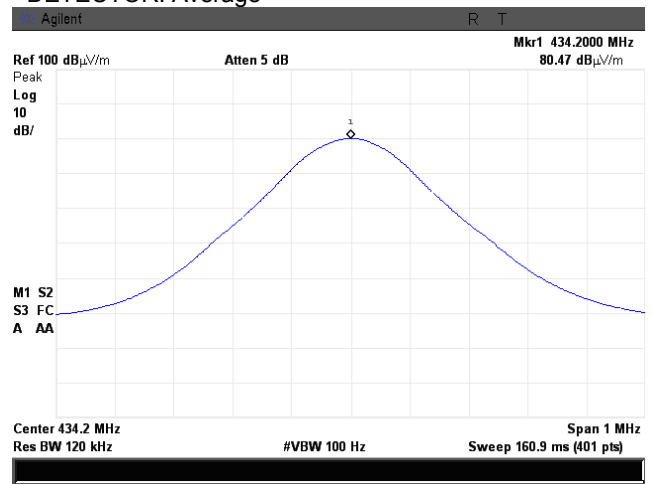
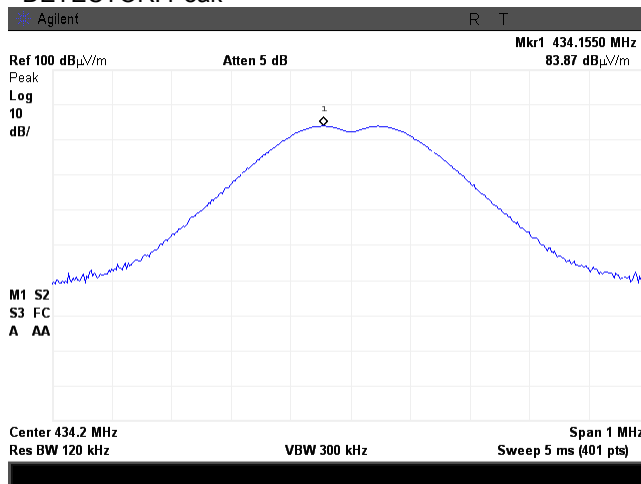

Plot 7.2.4 Radiated emission measurements at the high carrier frequency

TEST SITE:
TEST DISTANCE:
INPUT VOLTAGE:
EUT POSITION:
ANTENNA POLARIZATION:
DETECTOR: Peak

Semi anechoic chamber
3 m
Unom
Typical (Vertical)
Horizontal
DETECTOR: Average

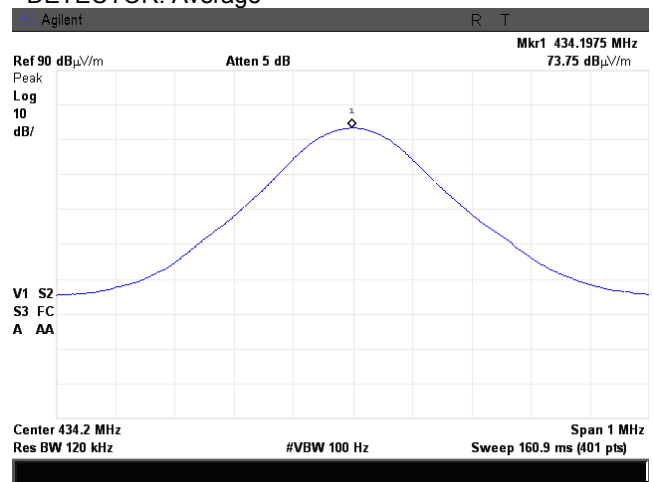
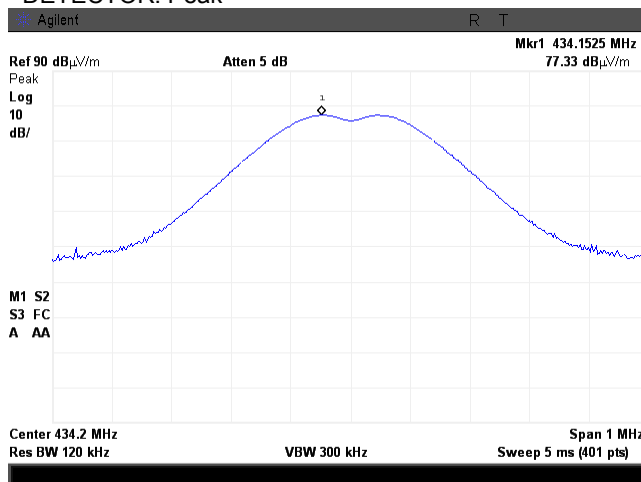



Test specification:	FCC Part 15, Section 231(e) / RSS-210, Section A1.1.5, Field strength of emissions		
Test procedure:	ANSI C63.4, Section 13.1.4		
Test mode:	Compliance	Verdict: PASS	
Date(s):	3/17/2013		
Temperature: 23.2 °C	Air Pressure: 1018 hPa	Relative Humidity: 41 %	Power Supply: 120 VAC
Remarks:			

Plot 7.2.5 Radiated emission measurements from 9 to 150 kHz at the low carrier frequency

TEST SITE: Semi anechoic chamber
 TEST DISTANCE: 3 m
 ANTENNA POLARIZATION: Vertical
 EUT POSITION: Typical (Vertical)

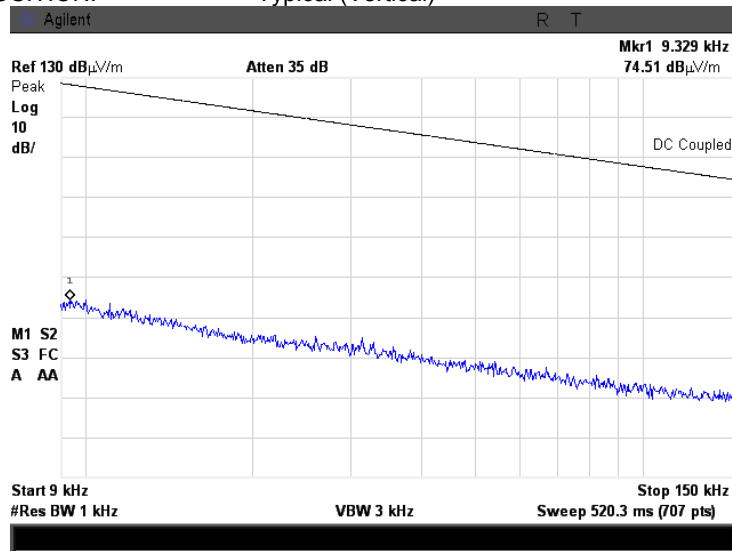

Plot 7.2.6 Radiated emission measurements from 9 to 150 kHz at the high carrier frequency

TEST SITE: Semi anechoic chamber
 TEST DISTANCE: 3 m
 ANTENNA POLARIZATION: Vertical
 EUT POSITION: Typical (Vertical)

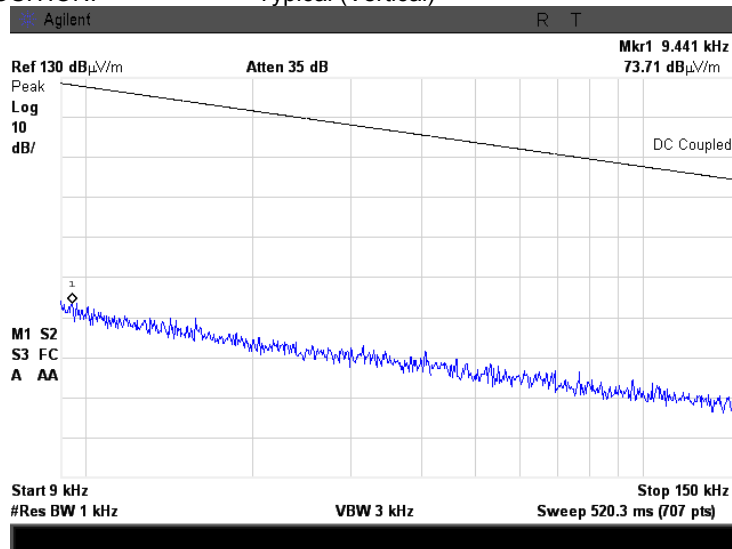



Test specification:	FCC Part 15, Section 231(e) / RSS-210, Section A1.1.5, Field strength of emissions		
Test procedure:	ANSI C63.4, Section 13.1.4		
Test mode:	Compliance	Verdict: PASS	
Date(s):	3/17/2013		
Temperature: 23.2 °C	Air Pressure: 1018 hPa	Relative Humidity: 41 %	Power Supply: 120 VAC
Remarks:			

Plot 7.2.7 Radiated emission measurements from 0.15 to 30 MHz at the low carrier frequency

TEST SITE: Semi anechoic chamber
 TEST DISTANCE: 3 m
 ANTENNA POLARIZATION: Vertical
 EUT POSITION: Typical (Vertical)

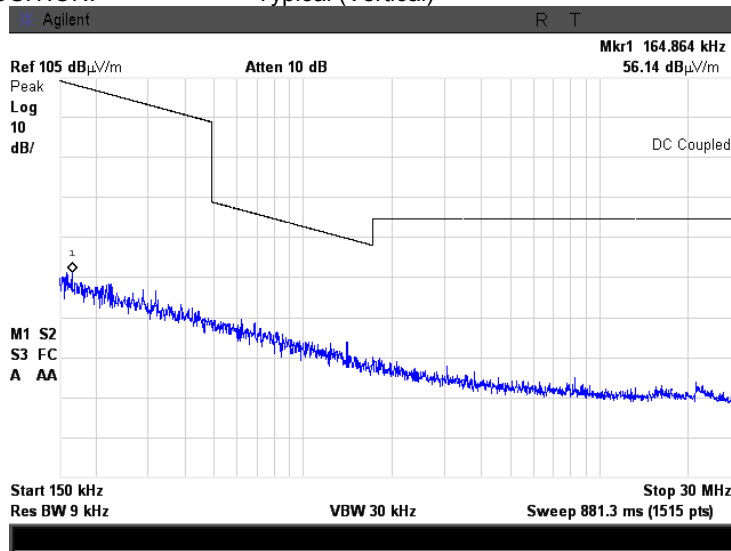

Plot 7.2.8 Radiated emission measurements from 0.15 to 30 MHz at the high carrier frequency

TEST SITE: Semi anechoic chamber
 TEST DISTANCE: 3 m
 ANTENNA POLARIZATION: Vertical
 EUT POSITION: Typical (Vertical)

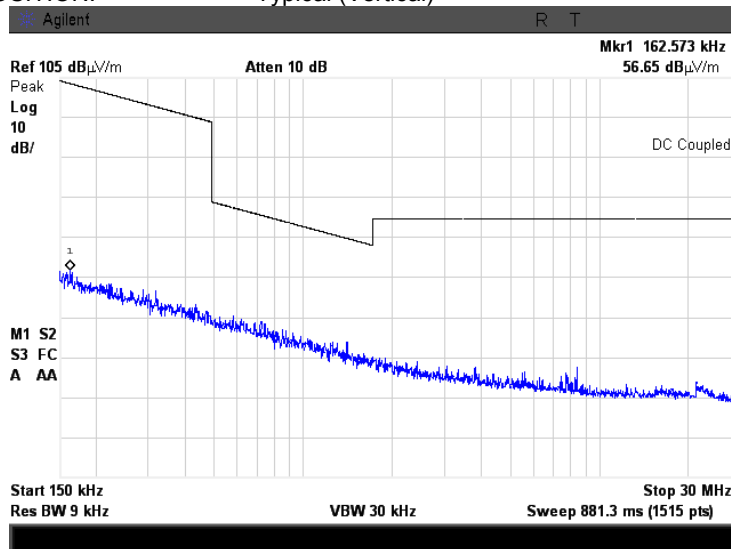



Test specification:	FCC Part 15, Section 231(e) / RSS-210, Section A1.1.5, Field strength of emissions		
Test procedure:	ANSI C63.4, Section 13.1.4		
Test mode:	Compliance	Verdict: PASS	
Date(s):	3/17/2013		
Temperature: 23.2 °C	Air Pressure: 1018 hPa	Relative Humidity: 41 %	Power Supply: 120 VAC
Remarks:			

Plot 7.2.9 Radiated emission measurements from 30 to 600 MHz at the low carrier frequency

TEST SITE: Semi anechoic chamber
 TEST DISTANCE: 3 m
 ANTENNA POLARIZATION: Vertical and Horizontal
 EUT POSITION: Typical (Vertical)

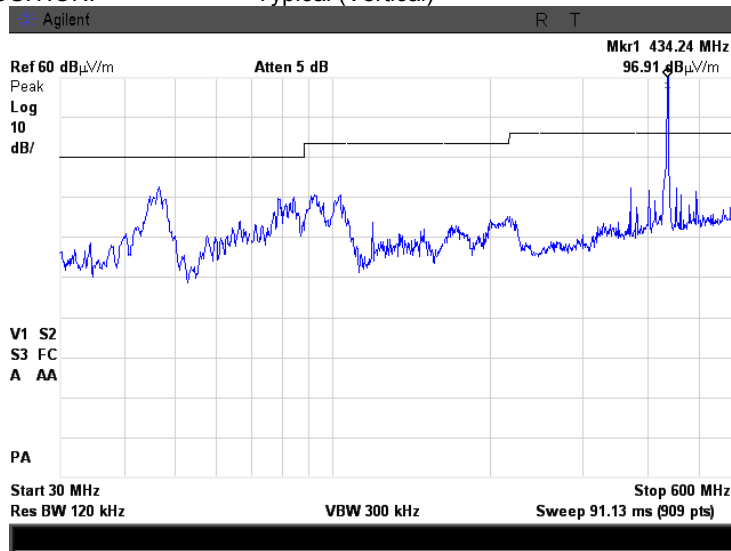

Plot 7.2.10 Radiated emission measurements from 30 to 600 MHz at the high carrier frequency

TEST SITE: Semi anechoic chamber
 TEST DISTANCE: 3 m
 ANTENNA POLARIZATION: Vertical and Horizontal
 EUT POSITION: Typical (Vertical)

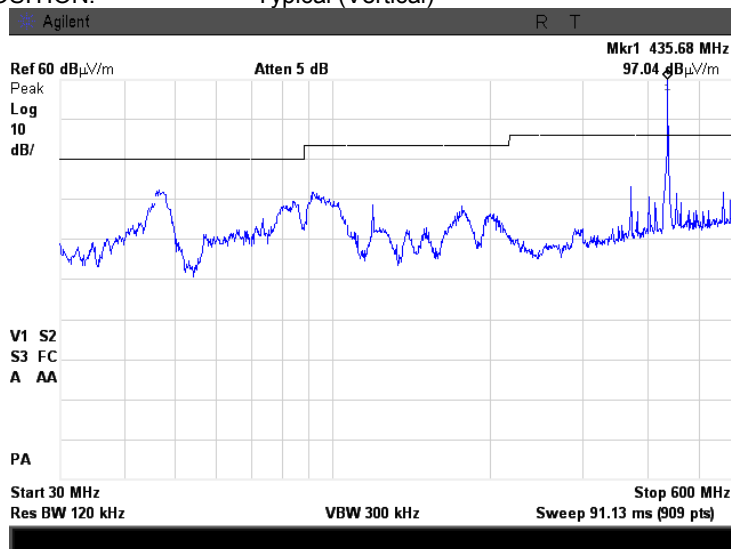



Test specification:	FCC Part 15, Section 231(e) / RSS-210, Section A1.1.5, Field strength of emissions		
Test procedure:	ANSI C63.4, Section 13.1.4		
Test mode:	Compliance	Verdict:	PASS
Date(s):	3/17/2013		
Temperature: 23.2 °C	Air Pressure: 1018 hPa	Relative Humidity: 41 %	Power Supply: 120 VAC
Remarks:			

Plot 7.2.11 Radiated emission measurements from 600 to 1000 MHz at the low carrier frequency

TEST SITE: Semi anechoic chamber
 TEST DISTANCE: 3 m
 ANTENNA POLARIZATION: Vertical and Horizontal
 EUT POSITION: Typical (Vertical)

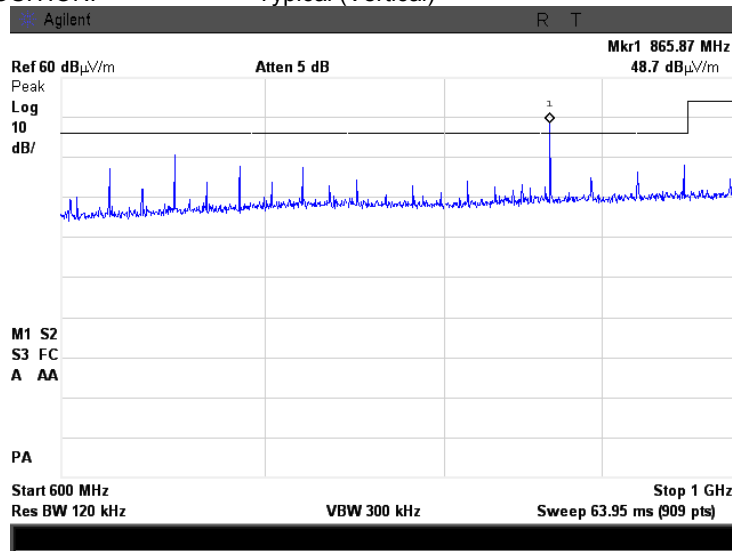

Plot 7.2.12 Radiated emission measurements from 600 to 1000 MHz at the high carrier frequency

TEST SITE: Semi anechoic chamber
 TEST DISTANCE: 3 m
 ANTENNA POLARIZATION: Vertical and Horizontal
 EUT POSITION: Typical (Vertical)

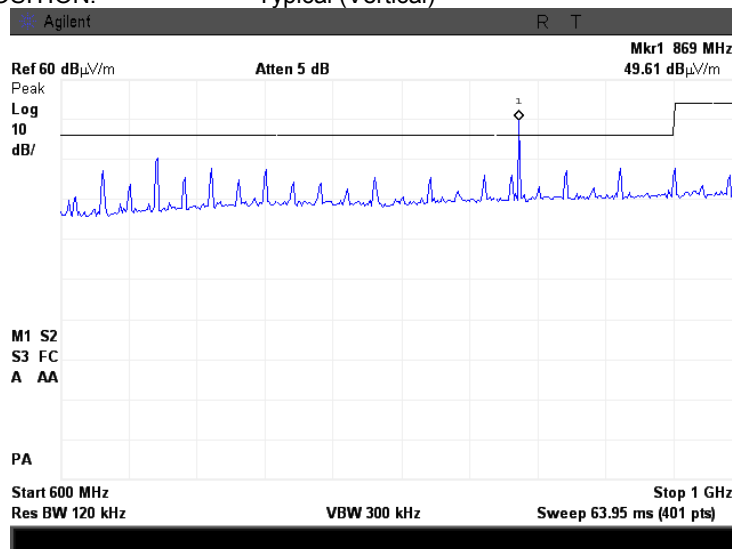



Test specification:	FCC Part 15, Section 231(e) / RSS-210, Section A1.1.5, Field strength of emissions		
Test procedure:	ANSI C63.4, Section 13.1.4		
Test mode:	Compliance	Verdict: PASS	
Date(s):	3/17/2013		
Temperature: 23.2 °C	Air Pressure: 1018 hPa	Relative Humidity: 41 %	Power Supply: 120 VAC
Remarks:			

Plot 7.2.13 Radiated emission measurements from 1000 to 4500 MHz at the low carrier frequency

TEST SITE: Semi anechoic chamber
 TEST DISTANCE: 3 m
 ANTENNA POLARIZATION: Vertical and Horizontal
 EUT POSITION: Typical (Vertical)

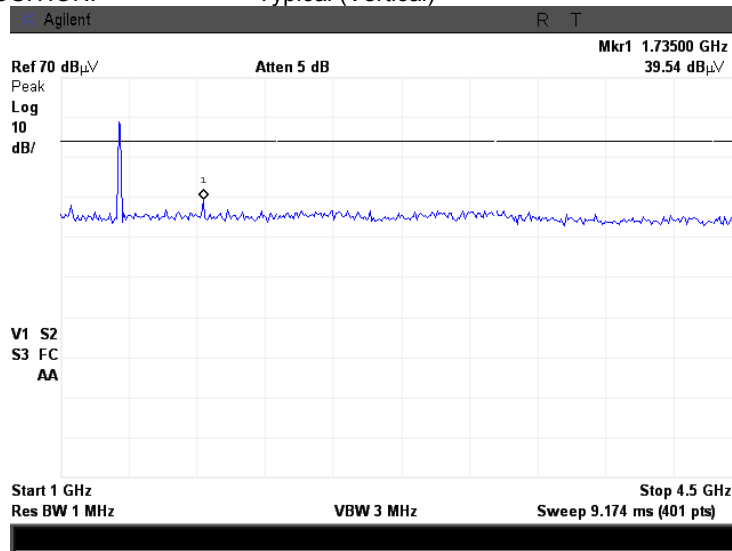

Plot 7.2.14 Radiated emission measurements from 1000 to 4500 MHz at the high carrier frequency

TEST SITE: Semi anechoic chamber
 TEST DISTANCE: 3 m
 ANTENNA POLARIZATION: Vertical and Horizontal
 EUT POSITION: Typical (Vertical)

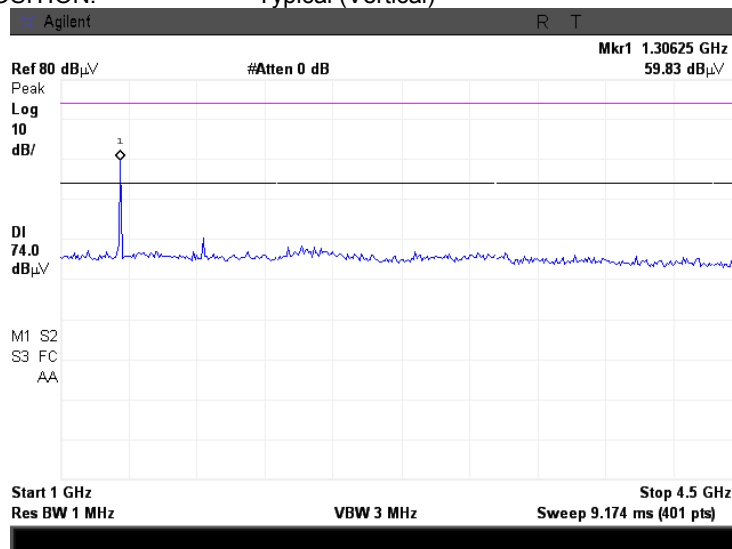



HERMON LABORATORIES

Test specification: FCC Part 15, Section 231(e) / RSS-210, Section A1.1.5, Field strength of emissions			
Test procedure: ANSI C63.4, Section 13.1.4			
Test mode: Compliance	Verdict: PASS		
Date(s): 3/17/2013			
Temperature: 23.2 °C	Air Pressure: 1018 hPa	Relative Humidity: 41 %	Power Supply: 120 VAC
Remarks:			

Plot 7.2.15 Radiated emission measurements at the second harmonic frequency at the low carrier frequency

TEST SITE:
TEST DISTANCE:
EUT POSITION:
ANTENNA POLARIZATION: Vertical

Semi anechoic chamber
3 m
Typical (Vertical)
ANTENNA POLARIZATION: Horizontal

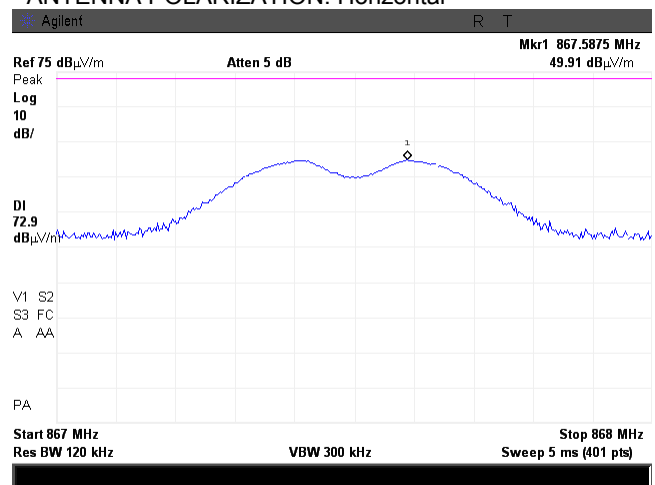
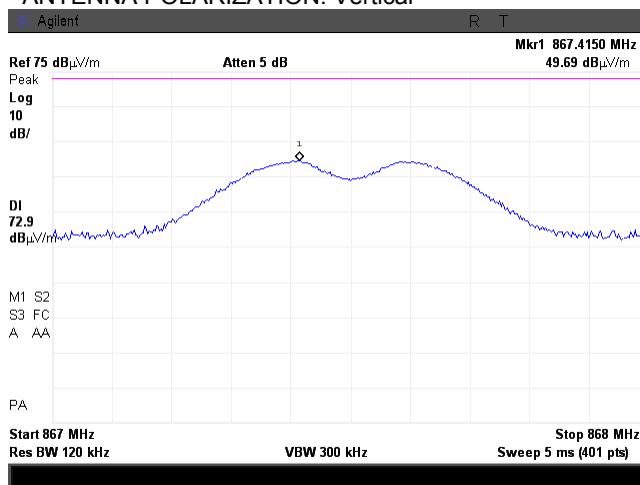

Plot 7.2.16 Radiated emission measurements at the second harmonic frequency at the high carrier frequency

TEST SITE:
TEST DISTANCE:
EUT POSITION:
ANTENNA POLARIZATION: Vertical

Semi anechoic chamber
3 m
Typical (Vertical)
ANTENNA POLARIZATION: Horizontal

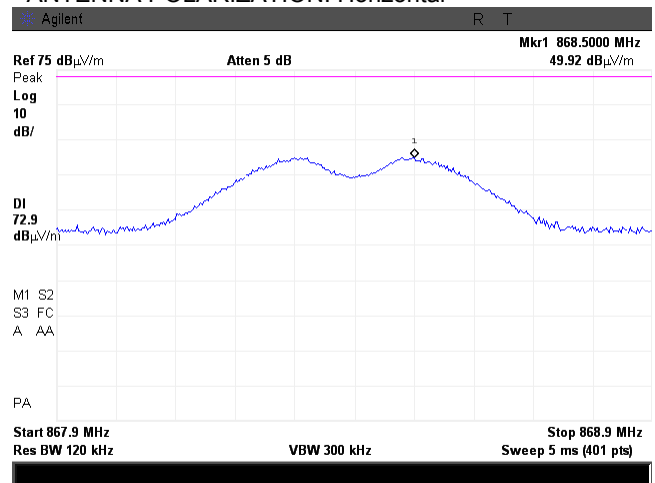
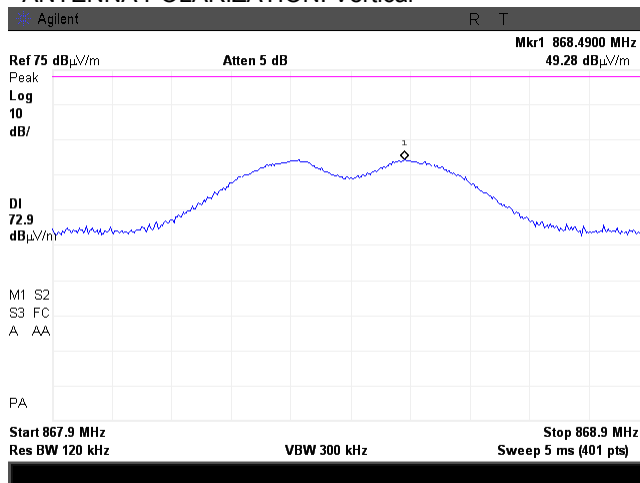



HERMON LABORATORIES

Test specification: FCC Part 15, Section 231(e) / RSS-210, Section A1.1.5, Field strength of emissions			
Test procedure: ANSI C63.4, Section 13.1.4			
Test mode: Compliance	Verdict: PASS		
Date(s): 3/17/2013			
Temperature: 23.2 °C	Air Pressure: 1018 hPa	Relative Humidity: 41 %	Power Supply: 120 VAC
Remarks:			

Plot 7.2.17 Radiated emission measurements at the third harmonic frequency at the low carrier frequency

TEST SITE:
TEST DISTANCE:
EUT POSITION:
ANTENNA POLARIZATION: Vertical

Semi anechoic chamber
3 m
Typical (Vertical)
ANTENNA POLARIZATION: Horizontal

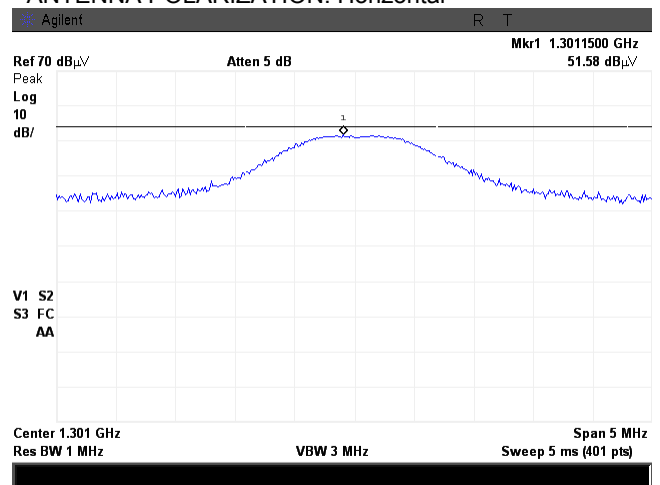
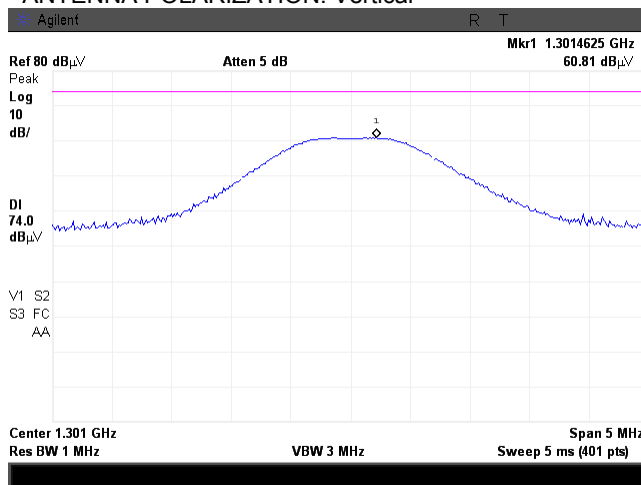

Plot 7.2.18 Radiated emission measurements at the third harmonic frequency at the high carrier frequency

TEST SITE:
TEST DISTANCE:
EUT POSITION:
ANTENNA POLARIZATION: Vertical

Semi anechoic chamber
3 m
Typical (Vertical)
ANTENNA POLARIZATION: Horizontal

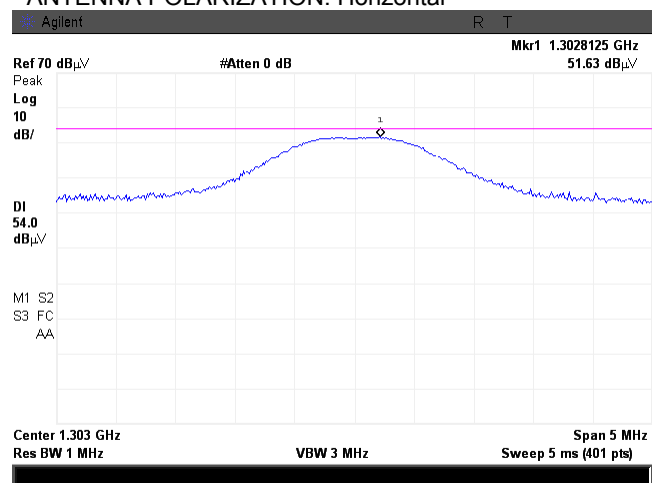
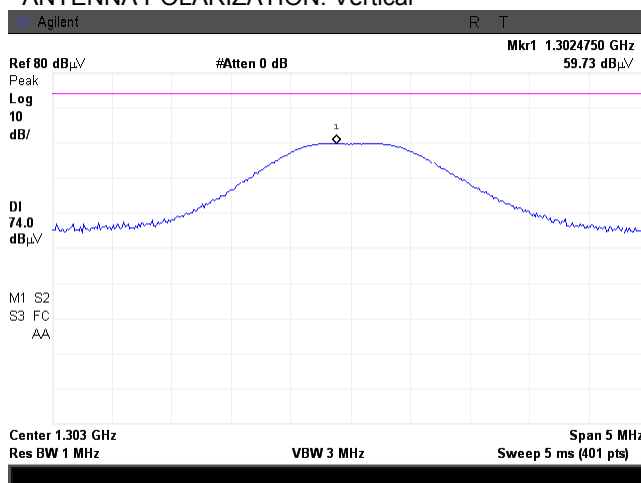



Test specification:	FCC Part 15, Section 231(e) / RSS-210, Section A1.1.5, Field strength of emissions		
Test procedure:	ANSI C63.4, Section 13.1.4		
Test mode:	Compliance	Verdict:	PASS
Date(s):	3/17/2013		
Temperature: 23.2 °C	Air Pressure: 1018 hPa	Relative Humidity: 41 %	Power Supply: 120 VAC
Remarks:			

Plot 7.2.19 Radiated emission measurements at the fourth harmonic frequency at the low carrier frequency

TEST SITE: Semi anechoic chamber
 TEST DISTANCE: 3 m
 EUT POSITION: Typical (Vertical)
 ANTENNA POLARIZATION: Vertical and Horizontal

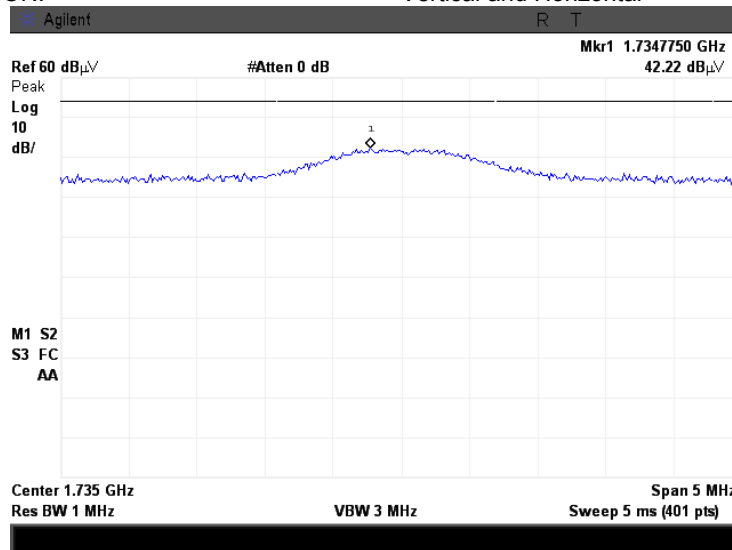

Plot 7.2.20 Radiated emission measurements at the fourth harmonic frequency at the high carrier frequency

TEST SITE: Semi anechoic chamber
 TEST DISTANCE: 3 m
 EUT POSITION: Typical (Vertical)
 ANTENNA POLARIZATION: Vertical and Horizontal

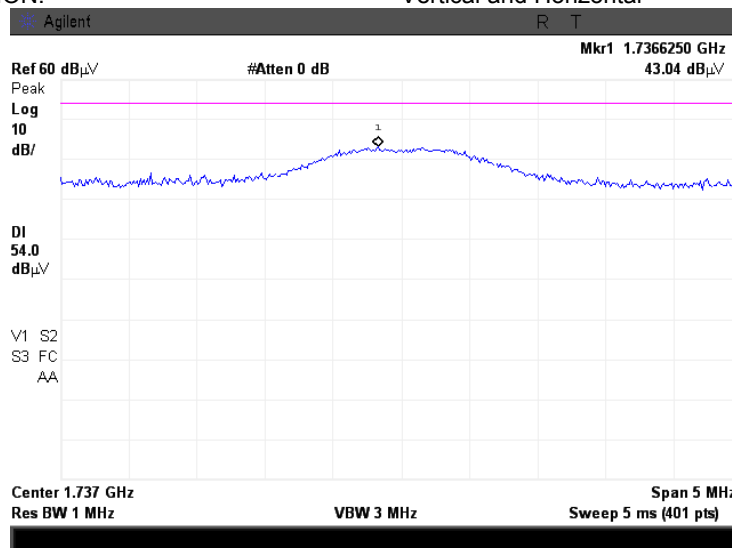



HERMON LABORATORIES

Test specification:		FCC Part 15, Section 231(e) / RSS-210, Section A1.1.5, Field strength of emissions	
Test procedure:		ANSI C63.4, Section 13.1.4	
Test mode:		Compliance	
Date(s):		3/17/2013	
Temperature: 23.2 °C		Air Pressure: 1018 hPa	
Remarks:		Verdict: PASS	
		Relative Humidity: 41 %	
		Power Supply: 120 VAC	

Plot 7.2.21 Radiated emission measurements at the fifth harmonic frequency at the low carrier frequency

TEST SITE: Semi anechoic chamber
TEST DISTANCE: 3 m
EUT POSITION: Typical (Vertical)
ANTENNA POLARIZATION: Vertical and Horizontal

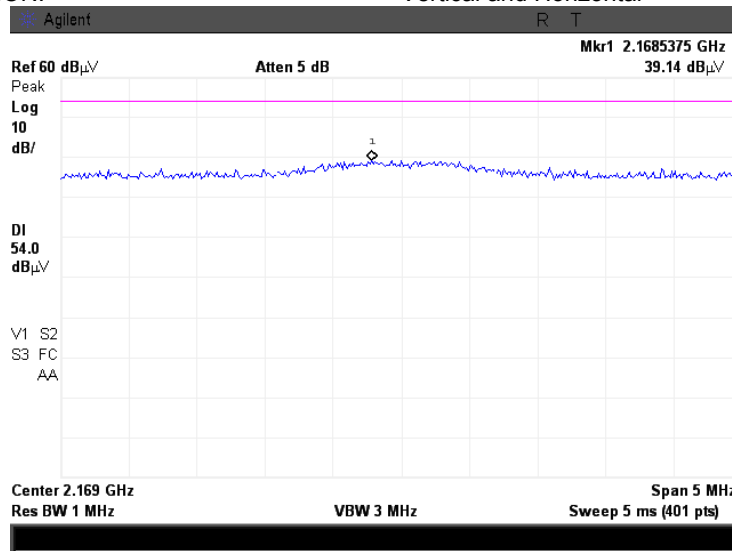

Plot 7.2.22 Radiated emission measurements at the fifth harmonic frequency at the high carrier frequency

TEST SITE: Semi anechoic chamber
TEST DISTANCE: 3 m
EUT POSITION: Typical (Vertical)
ANTENNA POLARIZATION: Vertical and Horizontal

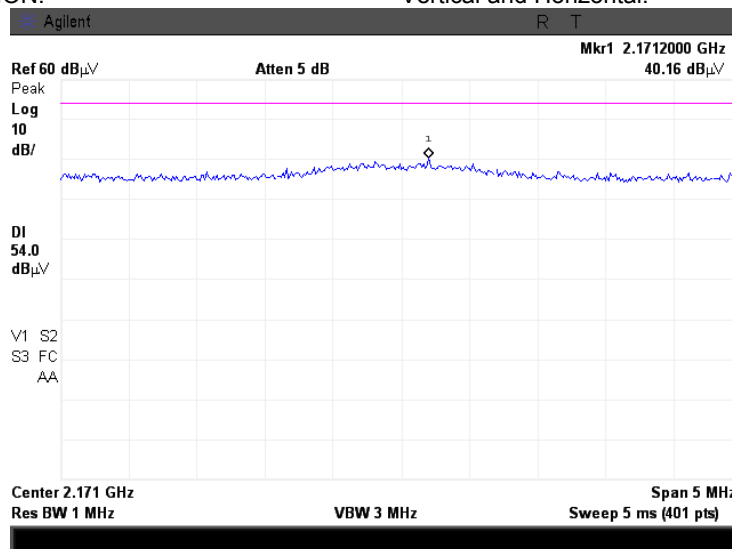



Test specification:	FCC Part 15, Section 231(e) / RSS-210, Section A1.1.5, Field strength of emissions		
Test procedure:	ANSI C63.4, Section 13.1.4		
Test mode:	Compliance	Verdict:	PASS
Date(s):	3/17/2013		
Temperature: 23.2 °C	Air Pressure: 1018 hPa	Relative Humidity: 41 %	Power Supply: 120 VAC
Remarks:			

Plot 7.2.23 Transmitter pulse duration

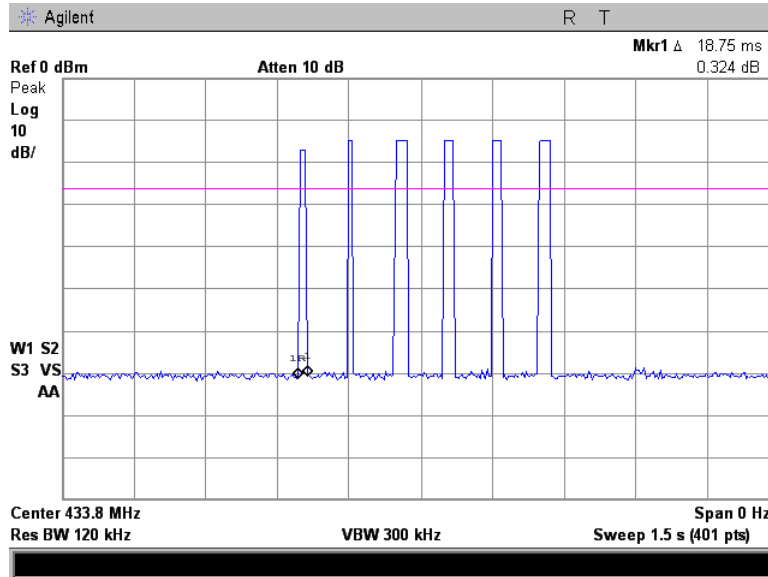

Plot 7.2.24 Transmitter pulse duration

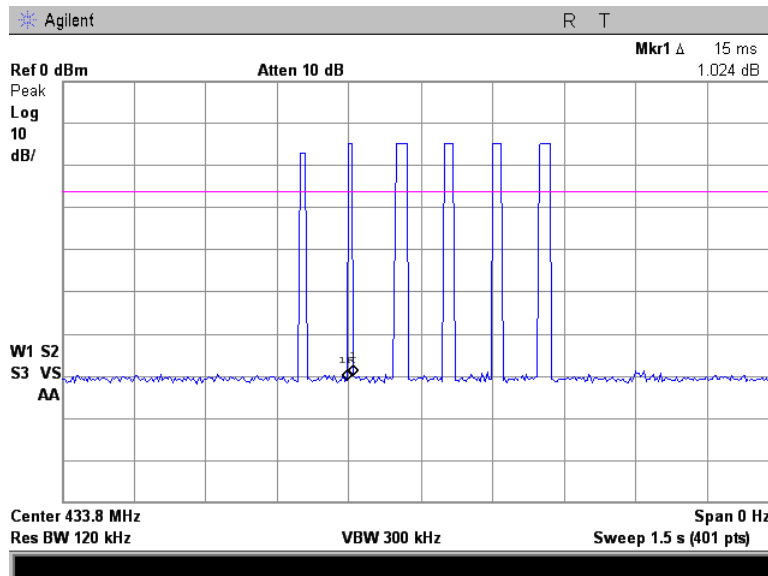



Test specification:	FCC Part 15, Section 231(e) / RSS-210, Section A1.1.5, Field strength of emissions		
Test procedure:	ANSI C63.4, Section 13.1.4		
Test mode:	Compliance	Verdict:	PASS
Date(s):	3/17/2013		
Temperature: 23.2 °C	Air Pressure: 1018 hPa	Relative Humidity: 41 %	Power Supply: 120 VAC
Remarks:			

Plot 7.2.25 Transmitter pulse duration

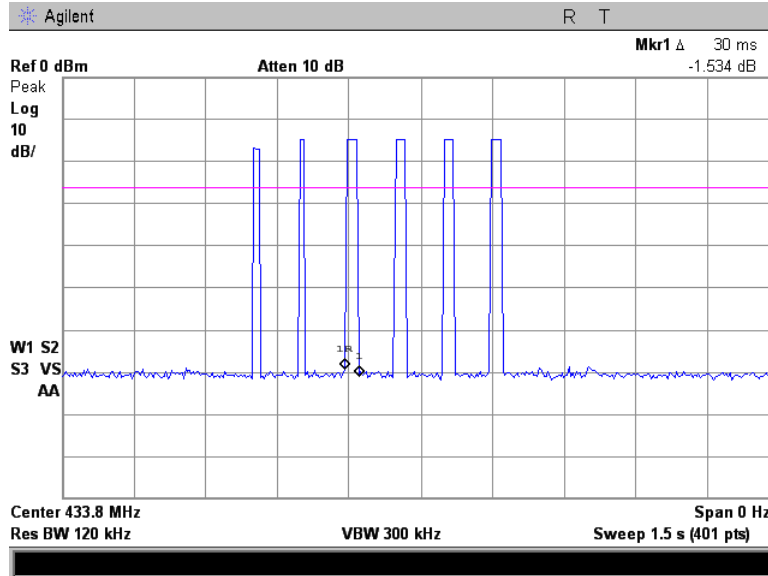

Plot 7.2.26 Transmission pulse period

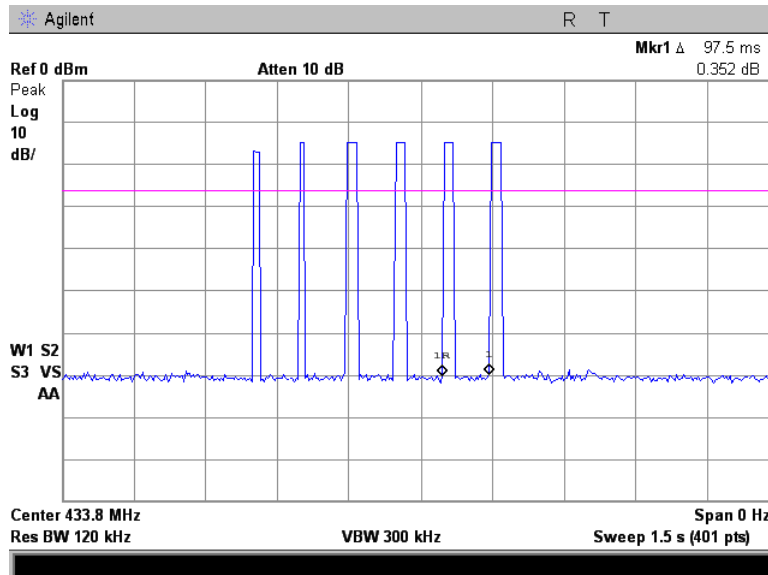



HERMON LABORATORIES

Test specification:	FCC Part 15, Section 231(e) / RSS-210, Section A1.1.5, Field strength of emissions		
Test procedure:	ANSI C63.4, Section 13.1.4		
Test mode:	Compliance	Verdict:	PASS
Date(s):	3/17/2013		
Temperature: 23.2 °C	Air Pressure: 1018 hPa	Relative Humidity: 41 %	Power Supply: 120 VAC
Remarks:			

Plot 7.2.27 Transmission burst duration

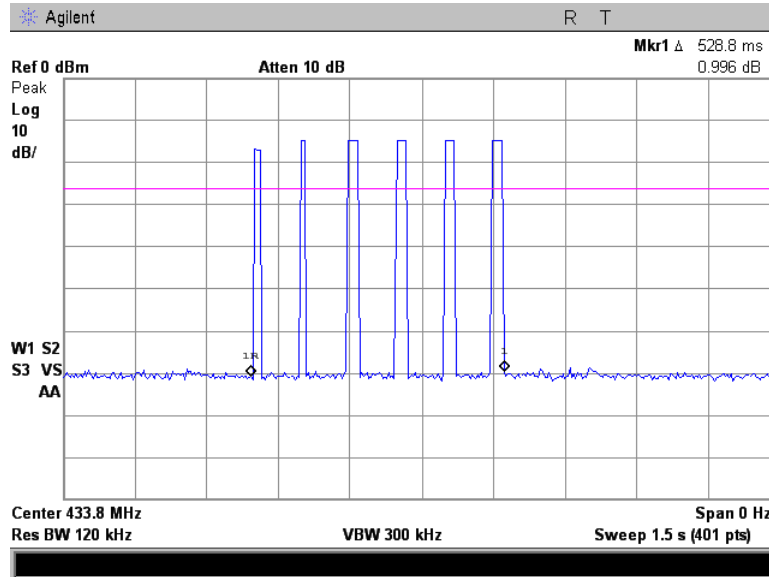

Plot 7.2.28 Transmission burst period

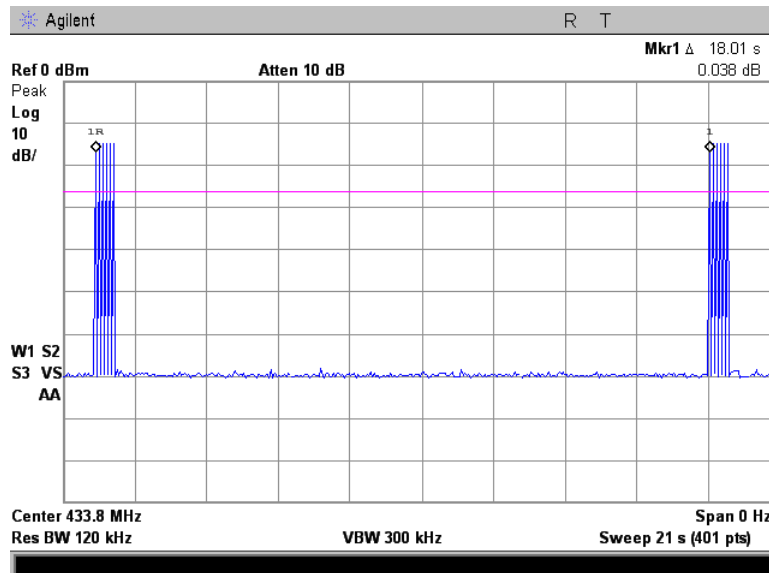



Test specification:	FCC Part 15, Section 231(c) / RSS-210, Section A1.1.3, Occupied bandwidth		
Test procedure:	ANSI C63.4, Section 13.1.7		
Test mode:	Compliance	Verdict:	PASS
Date(s):	3/11/2013		
Temperature: 22.3 °C	Air Pressure: 1015 hPa	Relative Humidity: 44 %	Power Supply: 120 VAC
Remarks:			

7.3 Occupied bandwidth test

7.3.1 General

This test was performed to measure transmitter occupied bandwidth. Specification test limits are given in Table 7.3.1.

Table 7.3.1 Occupied bandwidth limits

Assigned frequency, MHz	Modulation envelope reference points*, dBc	Maximum allowed bandwidth, % of the carrier frequency
70 - 900	20.0	0.25
Above 900		0.50

*- Modulation envelope reference points provided in terms of attenuation below modulated carrier.

7.3.2 Test procedure

7.3.2.1 The EUT was set up as shown in Figure 7.3.1, energized and its proper operation was checked.

7.3.2.2 The EUT was set to transmit modulated carrier.

7.3.2.3 The transmitter occupied bandwidth was measured with spectrum analyzer as frequency delta between reference points on modulation envelope and provided in Table 7.3.2 and the associated plots.

Figure 7.3.1 Occupied bandwidth test setup

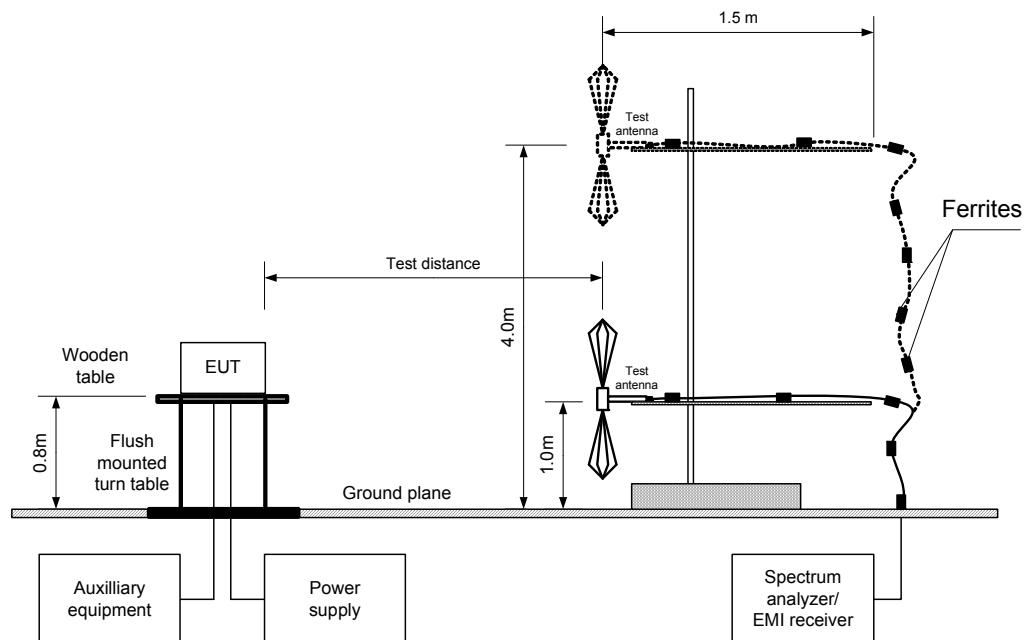



Test specification:	FCC Part 15, Section 231(c) / RSS-210, Section A1.1.3, Occupied bandwidth		
Test procedure:	ANSI C63.4, Section 13.1.7		
Test mode:	Compliance	Verdict:	PASS
Date(s):	3/11/2013		
Temperature: 22.3 °C	Air Pressure: 1015 hPa	Relative Humidity: 44 %	Power Supply: 120 VAC
Remarks:			

Table 7.3.2 Occupied bandwidth test results

DETECTOR USED: Peak hold
 RESOLUTION BANDWIDTH: 10 kHz
 VIDEO BANDWIDTH: 30 kHz
 MODULATION: FSK
 MODULATING SIGNAL: PRBS
 BIT RATE: 19.2 kbps

MODULATION ENVELOPE REFERENCE POINTS: 20 dBc

Carrier frequency, MHz	Occupied bandwidth, kHz	Limit		Margin, kHz	Verdict
		% of the carrier frequency	kHz		
433.75	198.75	0.25	1084	-885.25	Pass
434.20	198.70	0.25	1085	-886.30	Pass

MODULATION ENVELOPE REFERENCE POINTS: 99% power

Carrier frequency, MHz	Occupied bandwidth, kHz	Limit		Margin, kHz	Verdict
		% of the carrier frequency	kHz		
433.75	234.75	0.25	1084	-849.25	Pass
434.20	234.70	0.25	1085	-850.30	Pass

Reference numbers of test equipment used

HL 0604	HL 2909	HL 4351	HL 4353				
---------	---------	---------	---------	--	--	--	--

Full description is given in Appendix A.



Test specification: FCC Part 15, Section 231(c) / RSS-210, Section A1.1.3, Occupied bandwidth			
Test procedure: ANSI C63.4, Section 13.1.7			
Test mode: Compliance			Verdict: PASS
Date(s): 3/11/2013			
Temperature: 22.3 °C	Air Pressure: 1015 hPa	Relative Humidity: 44 %	Power Supply: 120 VAC
Remarks:			

Plot 7.3.1 Occupied bandwidth test result at the low frequency, 20 dBc

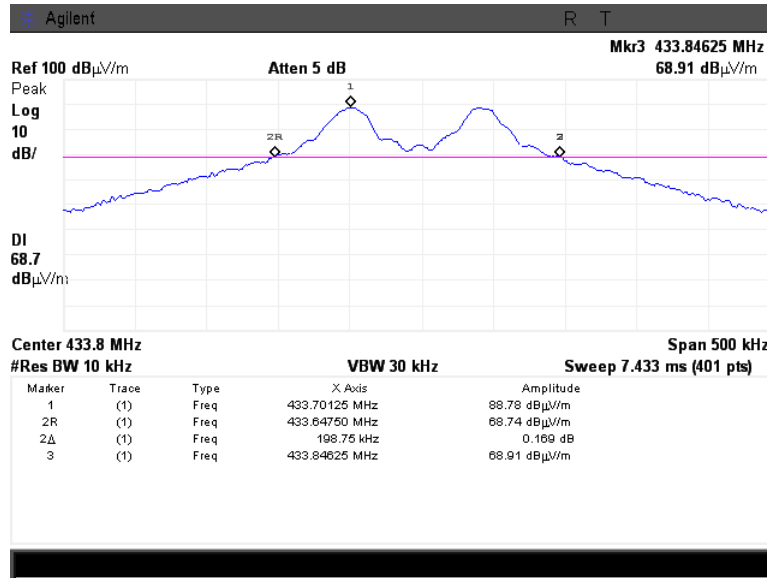

Plot 7.3.2 Occupied bandwidth test result at the high frequency, 20 dBc

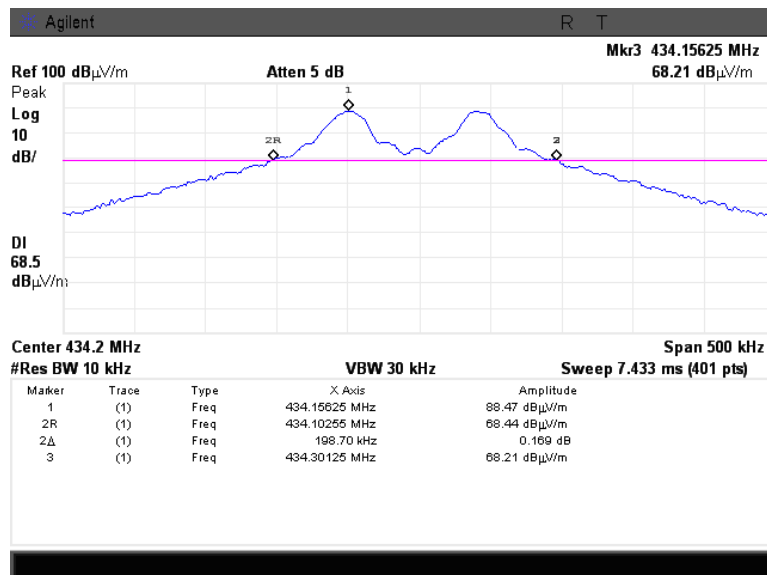



HERMON LABORATORIES

Test specification: FCC Part 15, Section 231(c) / RSS-210, Section A1.1.3, Occupied bandwidth	
Test procedure: ANSI C63.4, Section 13.1.7	
Test mode: Compliance	Verdict: PASS
Date(s): 3/11/2013	
Temperature: 22.3 °C	Air Pressure: 1015 hPa
	Relative Humidity: 44 %
	Power Supply: 120 VAC
Remarks:	

Plot 7.3.3 Occupied bandwidth test result at the low frequency, 99% power

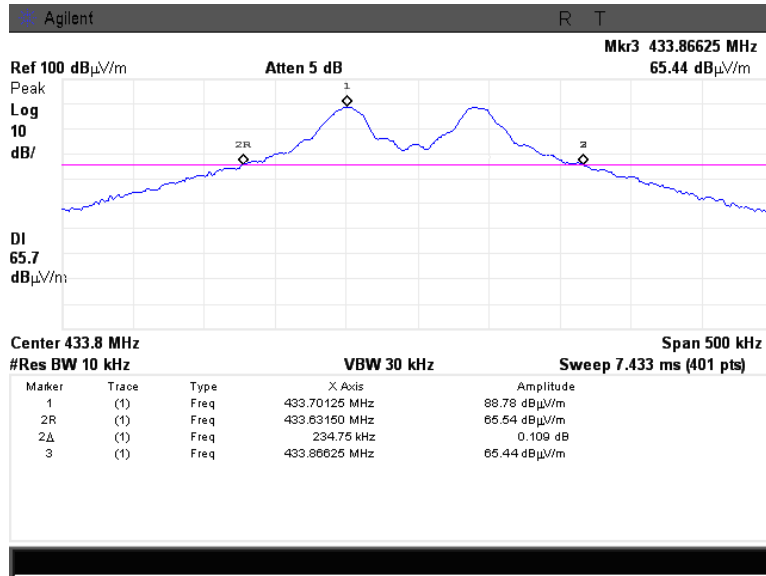

Plot 7.3.4 Occupied bandwidth test result at the high frequency, 99% power

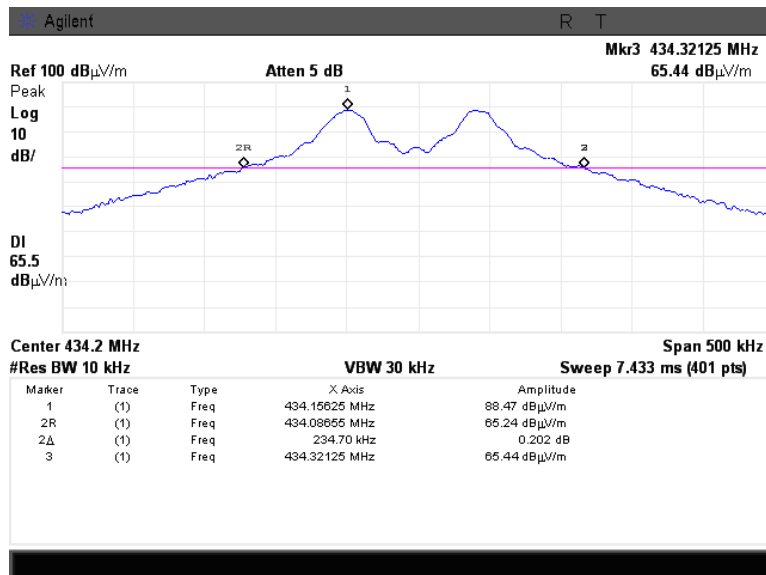



Test specification:		FCC Part 15, Section 207 / RSS-Gen, Section 7.2.4, Conducted emission	
Test procedure:		ANSI C63.4, Section 13.1.3	
Test mode:		Compliance	
Date(s):		3/20/2013	
Temperature: 23 °C		Air Pressure: 1014 hPa	
Remarks:		Verdict: PASS	
		Relative Humidity: 36 %	
		Power Supply: 120 VAC	

7.4 Conducted emissions

7.4.1 General

This test was performed to measure common mode conducted emissions at the power port. Specification test limits are given in Table 7.4.1.

Table 7.4.1 Limits for conducted emissions

Frequency, MHz	Class B limit, dB(μV)	
	QP	AVRG
0.15 - 0.5	66 - 56*	56 - 46*
0.5 - 5.0	56	46
5.0 - 30	60	50

* - The limit decreases linearly with the logarithm of frequency.

7.4.2 Test procedure

7.4.2.1 The EUT was set up as shown in Figure 7.4.1 and associated photographs, energized and the performance check was conducted.

7.4.2.2 The measurements were performed at power terminals with the LISN, connected to a spectrum analyzer while unused coaxial connector of the LISN was terminated with 50 Ohm.

7.4.2.3 The position of the device cables was varied to determine maximum emission level.

7.4.2.4 The worst test results (the lowest margins) were recorded in Table 7.4.2 and shown in the associated plots.

Figure 7.4.1 Setup for conducted emission measurements, table-top equipment

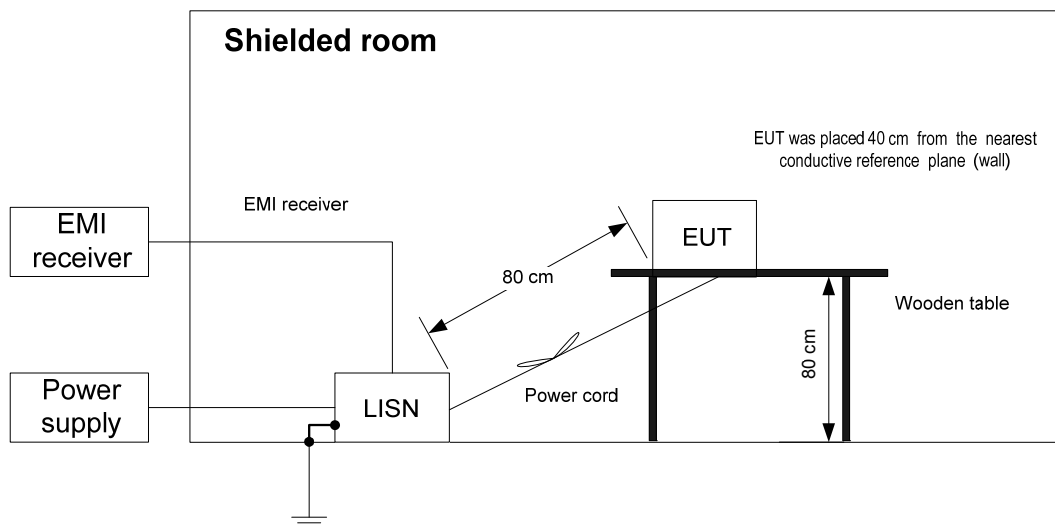



Test specification: FCC Part 15, Section 207 / RSS-Gen, Section 7.2.4, Conducted emission			
Test procedure: ANSI C63.4, Section 13.1.3			
Test mode: Compliance		Verdict: PASS	
Date(s): 3/20/2013			
Temperature: 23 °C	Air Pressure: 1014 hPa	Relative Humidity: 36 %	Power Supply: 120 VAC
Remarks:			

Table 7.4.2 Conducted emission test results

LINE: AC mains
 EUT OPERATING MODE: Transmit
 EUT SET UP: TABLE-TOP
 TEST SITE: SHIELDED ROOM
 FREQUENCY RANGE: 150 kHz - 30 MHz
 RESOLUTION BANDWIDTH: 9 kHz

Frequency, MHz	Peak emission, dB(µV)	Quasi-peak			Average			Line ID	Verdict
		Measured emission, dB(µV)	Limit, dB(µV)	Margin, dB*	Measured emission, dB(µV)	Limit, dB(µV)	Margin, dB*		
0.187063	51.42	48.84	64.19	-15.35	37.04	54.19	-17.15	L1	Pass
0.586888	53.23	48.38	56.00	-7.62	40.45	46.00	-5.55		
2.281025	52.51	47.77	56.00	-8.23	37.81	46.00	-8.19		
3.455795	49.52	42.68	56.00	-13.32	35.91	46.00	-10.09		
5.045728	49.69	46.71	60.00	-13.29	39.43	50.00	-10.57		
12.069635	54.56	48.48	60.00	-11.52	37.05	50.00	-12.95	L2	Pass
0.586570	53.28	48.17	56.00	-7.83	40.46	46.00	-5.54		
0.865605	48.59	42.81	56.00	-13.19	34.35	46.00	-11.65		
2.247220	51.72	46.48	56.00	-9.52	36.31	46.00	-9.69		
3.596023	51.33	45.35	56.00	-10.65	37.89	46.00	-8.11		
4.907073	51.19	45.46	56.00	-10.54	39.21	46.00	-6.79		
12.316890	59.31	47.36	60.00	-12.64	38.39	50.00	-11.61		

*- Margin = Measured emission - specification limit.

Reference numbers of test equipment used

HL 0580	HL 1425	HL 1513	HL 2888	HL 3612			
---------	---------	---------	---------	---------	--	--	--

Full description is given in Appendix A.



HERMON LABORATORIES

Test specification: FCC Part 15, Section 207 / RSS-Gen, Section 7.2.4, Conducted emission	
Test procedure:	ANSI C63.4, Section 13.1.3
Test mode:	Compliance
Date(s):	3/20/2013
Temperature: 23 °C	Air Pressure: 1014 hPa
Relative Humidity: 36 %	Power Supply: 120 VAC
Remarks:	

Plot 7.4.1 Conducted emission measurements

LINE: L1
EUT OPERATING MODE: Transmit
LIMIT: QUASI-PEAK, AVERAGE
DETECTOR: PEAK



ACTV DET: PEAK
MEAS DET: PEAK QP AVG
MKR 10.13 MHz
51.24 dBµV

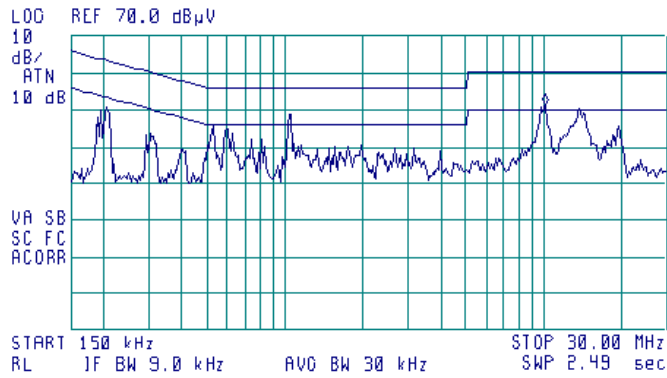

Plot 7.4.2 Conducted emission measurements

LINE: L2
EUT OPERATING MODE: Transmit
LIMIT: QUASI-PEAK, AVERAGE
DETECTOR: PEAK



ACTV DET: PEAK
MEAS DET: PEAK QP AVG
MKR 13.71 MHz
50.82 dBµV

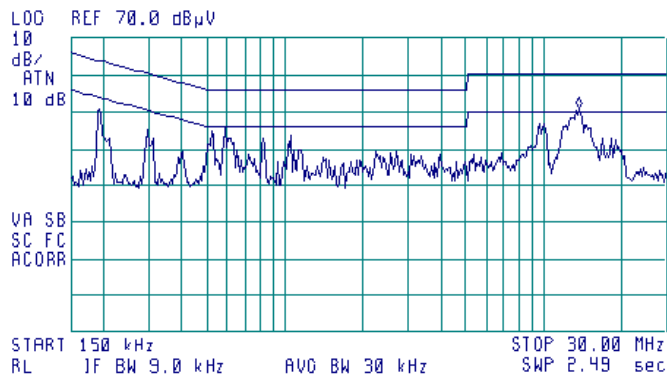



Test specification:	FCC Part 15, Section 203 / RSS-Gen, Section 7.1.4, Antenna requirements		
Test procedure:	Visual inspection / supplier declaration		
Test mode:	Compliance	Verdict:	PASS
Date(s):	3/20/2013		
Temperature: 22.3 °C	Air Pressure: 1014 hPa	Relative Humidity: 36 %	Power Supply: 120 VAC
Remarks:			

7.5 Antenna requirements

The EUT was verified for compliance with antenna requirements. A transmitter shall be designed to ensure that no antenna other than that furnished by the responsible party will be used with the device. It may be either permanently attached or employs a unique antenna connector for every antenna proposed for use with the EUT. This requirement does not apply to professionally installed transmitters. The rationale for compliance with the above requirements was either visual inspection results or supplier declaration. The summary of results is provided in Table 7.5.1.

Table 7.5.1 Antenna requirements

Requirement	Rationale	Verdict
The transmitter antenna is permanently attached	NA	Comply
The transmitter employs a unique antenna connector	Visual inspection	
The transmitter requires professional installation	NA	

Photograph 7.5.1 Antenna assembly





Test specification:	FCC Section 15.107/ICES-003 Section 6.1 Class B, AC power lines conducted emissions		
Test procedure:	ANSI C63.4, Section 11.5		
Test mode:	Compliance	Verdict:	PASS
Date(s):	3/21/2013		
Temperature: 23 °C	Air Pressure: 1015 hPa	Relative Humidity: 41 %	Power Supply: 120 VAC
Remarks:			

8 Emissions tests according to 47CFR part 15 subpart B and ICES-003 requirements

8.1 Conducted emissions

8.1.1 General

This test was performed to measure common mode conducted emissions at the EUT power port. The specification test limits are given in Table 8.1.1.

Table 8.1.1 Limits for conducted emissions

Frequency, MHz	Class B limit, dB(μV)		Class A limit, dB(μV)	
	QP	AVRG	QP	AVRG
0.15 – 0.5	66 – 56*	56 – 46*	79	66
0.5 – 5.0	56	46	73	60
5.0 – 30	60	50	73	60

* The limit decreases linearly with the logarithm of frequency.

8.1.2 Test procedure

8.1.2.1 The EUT was set up as shown in Figure 8.1.1 and the associated photographs, energized and the EUT performance was checked.

8.1.2.2 The measurements were performed at the EUT power terminals with the LISN, connected to the EMI receiver in the frequency range referred to in Table 8.1.2. The unused coaxial connector of the LISN was terminated with 50 Ohm.

8.1.2.3 The position of the EUT cables was varied to find the highest emission.

8.1.2.4 The worst test results with respect to the limits were recorded in Table 8.1.2 and shown in the associated plots.

Figure 8.1.1 Setup for conducted emission measurements, table-top EUT

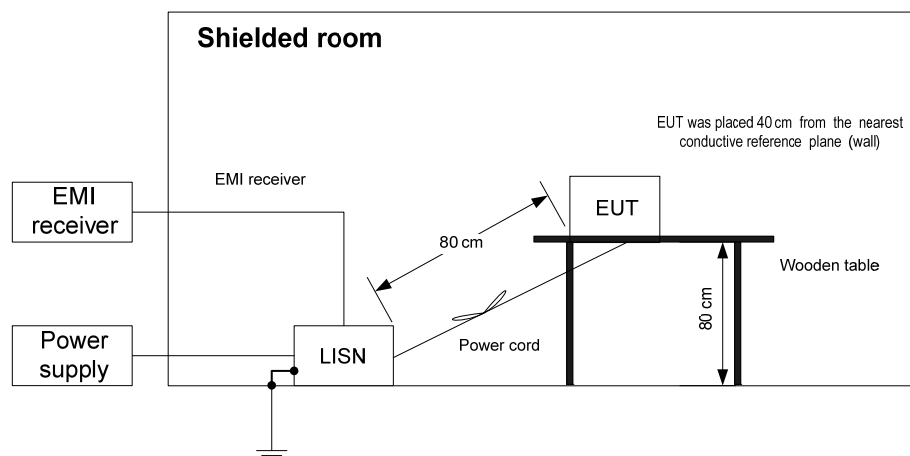



Test specification:	FCC Section 15.107/ICES-003 Section 6.1 Class B, AC power lines conducted emissions		
Test procedure:	ANSI C63.4, Section 11.5		
Test mode:	Compliance	Verdict:	PASS
Date(s):	3/21/2013		
Temperature: 23 °C	Air Pressure: 1015 hPa	Relative Humidity: 41 %	Power Supply: 120 VAC
Remarks:			

Photograph 8.1.1 Setup for conducted emissions measurements



Photograph 8.1.2 Setup for conducted emissions measurements





Test specification:	FCC Section 15.107/ICES-003 Section 6.1 Class B, AC power lines conducted emissions		
Test procedure:	ANSI C63.4, Section 11.5		
Test mode:	Compliance	Verdict:	PASS
Date(s):	3/21/2013		
Temperature: 23 °C	Air Pressure: 1015 hPa	Relative Humidity: 41 %	Power Supply: 120 VAC
Remarks:			

Table 8.1.2 Conducted emission test results

LINE: AC mains
LIMIT: Class B
EUT SET UP: TABLE-TOP
TEST SITE: SHIELDED ROOM
DETECTORS USED: PEAK / QUASI-PEAK / AVERAGE
FREQUENCY RANGE: 150 kHz - 30 MHz
RESOLUTION BANDWIDTH: 9 kHz

Frequency, MHz	Peak emission, dB(μV)	Quasi-peak			Average			Line ID	Verdict
		Measured emission, dB(μV)	Limit, dB(μV)	Margin, dB*	Measured emission, dB(μV)	Limit, dB(μV)	Margin, dB*		
0.187063	51.42	48.84	64.19	-15.35	37.04	54.19	-17.15	L1	Pass
0.586888	53.23	48.38	56.00	-7.62	40.45	46.00	-5.55		
2.281025	52.51	47.77	56.00	-8.23	37.81	46.00	-8.19		
3.455795	49.52	42.68	56.00	-13.32	35.91	46.00	-10.09		
5.045728	49.69	46.71	60.00	-13.29	39.43	50.00	-10.57		
12.069635	54.56	48.48	60.00	-11.52	37.05	50.00	-12.95		
0.586570	53.28	48.17	56.00	-7.83	40.46	46.00	-5.54	L2	Pass
0.865605	48.59	42.81	56.00	-13.19	34.35	46.00	-11.65		
2.247220	51.72	46.48	56.00	-9.52	36.31	46.00	-9.69		
3.596023	51.33	45.35	56.00	-10.65	37.89	46.00	-8.11		
4.907073	51.19	45.46	56.00	-10.54	39.21	46.00	-6.79		
12.316890	59.31	47.36	60.00	-12.64	38.39	50.00	-11.61		

*- Margin = Measured emission - specification limit.

Reference numbers of test equipment used

HL 0580	HL 1425	HL 1513	HL 2888	HL 3612			
---------	---------	---------	---------	---------	--	--	--

Full description is given in Appendix A.



HERMON LABORATORIES

Test specification:		FCC Section 15.107/ICES-003 Section 6.1 Class B, AC power lines conducted emissions	
Test procedure:		ANSI C63.4, Section 11.5	
Test mode:		Compliance	
Date(s):		3/21/2013	
Temperature: 23 °C		Air Pressure: 1015 hPa	
Relative Humidity: 41 %		Power Supply: 120 VAC	
Remarks:			
		Verdict: PASS	

Plot 8.1.1 Conducted emission measurements

LINE: L1
LIMIT: QUASI-PEAK, AVERAGE
DETECTOR: PEAK



ACTV DET: PEAK
MEAS DET: PEAK OP AVG
MKR 13.53 MHz
54.66 dBµV

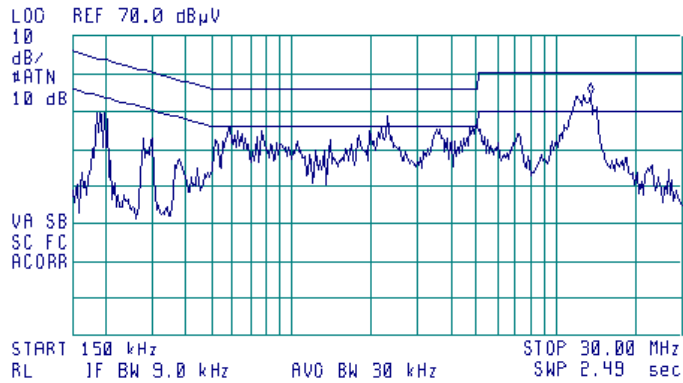

Plot 8.1.2 Conducted emission measurements

LINE: L2
LIMIT: QUASI-PEAK, AVERAGE
DETECTOR: PEAK



ACTV DET: PEAK
MEAS DET: PEAK OP AVG
MKR 11.76 MHz
57.10 dBµV

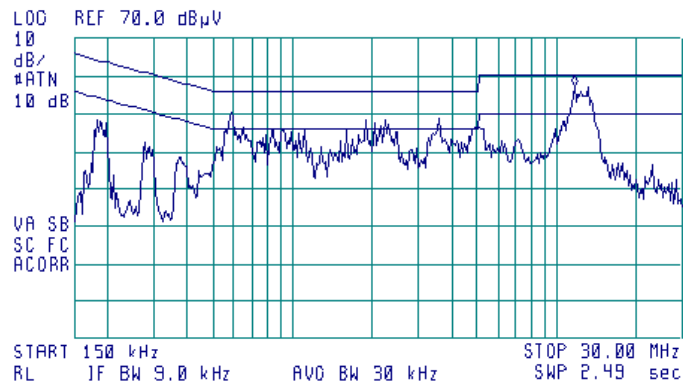



Test specification:	FCC Section 15.109/ ICES-003 Section 6.2 Class B, Radiated emission		
Test procedure:	ANSI C63.4, Section 11.6		
Test mode:	Compliance	Verdict:	PASS
Date(s):	3/21/2013		
Temperature: 23 °C	Air Pressure: 1015 hPa	Relative Humidity: 43 %	Power Supply: 120 VAC
Remarks:			

8.2 Radiated emission measurements

8.2.1 General

This test was performed to measure radiated emissions from the EUT enclosure. The specification test limits are given in Table 8.2.1.

Table 8.2.1 Radiated emission test limits

Frequency, MHz	Class B limit, dB(μ V/m)		Class A limit, dB(μ V/m)	
	10 m distance	3 m distance	10 m distance	3 m distance
30 - 88	29.5*	40.0	39.0	49.5*
88 - 216	33.0*	43.5	43.5	54.0*
216 - 960	35.5*	46.0	46.4	56.9*
Above 960	43.5*	54.0	49.5	60.0*

* The limit for test distance other than specified was calculated using the inverse linear distance extrapolation factor as follows: $Lim_{S_2} = Lim_{S_1} + 20 \log(S_1/S_2)$, where S_1 and S_2 – standard defined and test distance respectively in meters.

8.2.2 Test procedure

- 8.2.2.1** The EUT was set up as shown in Figure 8.2.1 and the associated photographs, energized and the EUT performance was checked.
- 8.2.2.2** The preliminary measurements were performed in the anechoic chamber at 3 m test distance. The specified frequency range was investigated with the antenna connected to the EMI receiver. To find the highest emission the turntable was rotated 360° and the measuring antenna height was swept from 1 to 4 m in both, vertical and horizontal polarizations. The EUT cables position was varied to maximize emission.
- 8.2.2.3** The EUT was set up as shown in Figure 8.2.2 and the associated photographs, energized and the EUT performance was checked.
- 8.2.2.4** The final measurements were performed at the open area test site at 10 m test distance with the antenna connected to the EMI receiver. The EUT wires and cables were arranged to produce the highest emission as it was found during the preliminary measurements. The frequencies, produced the highest emissions with respect to the limits during the preliminary test were investigated. To find the highest emission the turntable was rotated 360° and the measuring antenna height was swept from 1 to 4 m in both, vertical and horizontal polarizations. At frequencies, where the high ambient noise was encountered, the final measurements were taken at 3 m distance.
- 8.2.2.5** The worst test results with respect to the limits were recorded in Table 8.2.2 and shown in the associated plots.



Test specification:	FCC Section 15.109/ ICES-003 Section 6.2 Class B, Radiated emission		
Test procedure:	ANSI C63.4, Section 11.6		
Test mode:	Compliance	Verdict:	PASS
Date(s):	3/21/2013		
Temperature: 23 °C	Air Pressure: 1015 hPa	Relative Humidity: 43 %	Power Supply: 120 VAC
Remarks:			

Figure 8.2.1 Setup for radiated emission measurements in anechoic chamber, table-top EUT

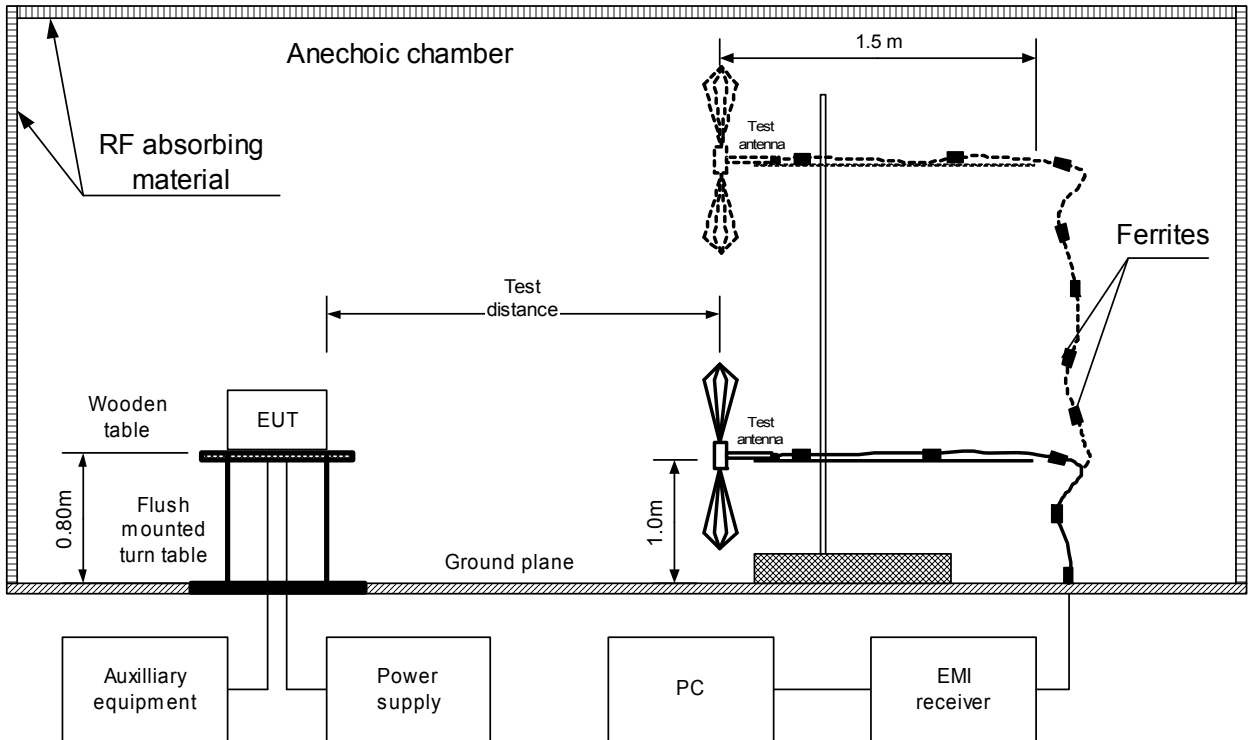



Test specification:	FCC Section 15.109/ ICES-003 Section 6.2 Class B, Radiated emission		
Test procedure:	ANSI C63.4, Section 11.6		
Test mode:	Compliance	Verdict:	PASS
Date(s):	3/21/2013		
Temperature: 23 °C	Air Pressure: 1015 hPa	Relative Humidity: 43 %	Power Supply: 120 VAC
Remarks:			

Photograph 8.2.1 Setup for radiated emission measurements

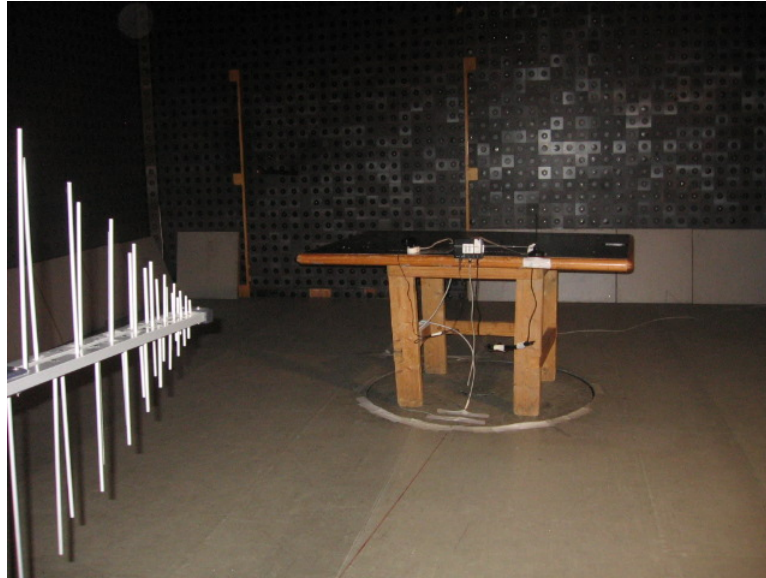

Photograph 8.2.2 Setup for radiated emission measurements





Test specification:	FCC Section 15.109/ ICES-003 Section 6.2 Class B, Radiated emission		
Test procedure:	ANSI C63.4, Section 11.6		
Test mode:	Compliance	Verdict:	PASS
Date(s):	3/21/2013		
Temperature: 23 °C	Air Pressure: 1015 hPa	Relative Humidity: 43 %	Power Supply: 120 VAC
Remarks:			

Figure 8.2.2 Setup for radiated emission measurements at OATS, table-top EUT

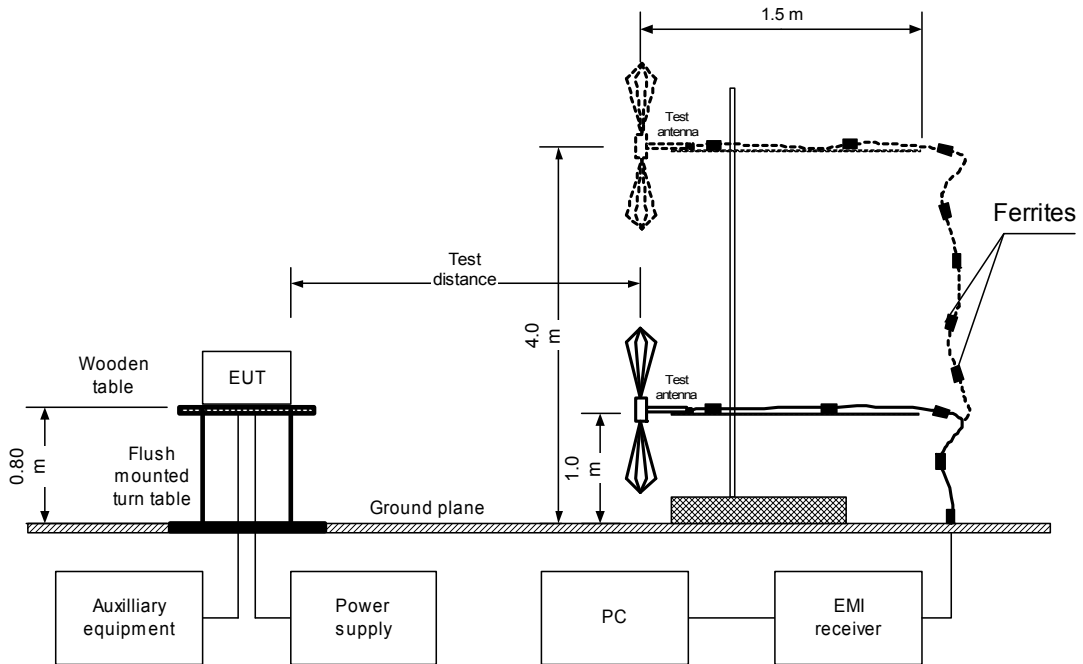

Photograph 8.2.3 Setup for final radiated emission measurements





Test specification:	FCC Section 15.109/ ICES-003 Section 6.2 Class B, Radiated emission		
Test procedure:	ANSI C63.4, Section 11.6		
Test mode:	Compliance	Verdict:	PASS
Date(s):	3/21/2013		
Temperature: 23 °C	Air Pressure: 1015 hPa	Relative Humidity: 43 %	Power Supply: 120 VAC
Remarks:			

Photograph 8.2.4 Setup for final radiated emission measurements



Photograph 8.2.5 Setup for final radiated emission measurements, EUT cabling





Test specification: FCC Section 15.109/ ICES-003 Section 6.2 Class B, Radiated emission			
Test procedure: ANSI C63.4, Section 11.6			
Test mode: Compliance		Verdict: PASS	
Date(s): 3/21/2013			
Temperature: 23 °C	Air Pressure: 1015 hPa	Relative Humidity: 43 %	Power Supply: 120 VAC
Remarks:			

Table 8.2.2 Radiated emission test results

EUT SET UP: TABLE-TOP
 DETECTORS USED: PEAK / QUASI-PEAK
 FREQUENCY RANGE: 30 MHz – 1000 MHz
 RESOLUTION BANDWIDTH: 120 kHz

TEST SITE: OATS
 TEST DISTANCE: 10 m

Frequency, MHz	Peak emission, dB(μV/m)	Quasi-peak			Antenna polarization	Antenna height, m	Turn-table position**, degrees	Verdict
		Measured emission, dB(μV/m)	Limit, dB(μV/m)	Margin, dB*				
499.858	37.38	33.97	35.50	-1.53	V	1.0	316	Pass
666.475	36.73	33.90	35.50	-1.60	H	1.6	300	
749.775	37.23	32.80	35.50	-2.70	H	1.2	0	
833.125	37.60	34.90	35.50	-0.60	H	1.1	0	

TEST SITE: Semi-anechoic chamber
 TEST DISTANCE: 3 m

Frequency, MHz	Peak emission, dB(μV/m)	Quasi-peak			Antenna polarization	Antenna height, m	Turn-table position**, degrees	Verdict
		Measured emission, dB(μV/m)	Limit, dB(μV/m)	Margin, dB*				
31.000	41.05	33.11	40.00	-6.89	V	1.0	0	Pass
115.450	42.66	36.01	43.50	-7.49	V	1.1	90	

TEST SITE: Semi-anechoic chamber
 TEST DISTANCE: 3 m
 DETECTORS USED: PEAK / AVERAGE
 FREQUENCY RANGE: 1000 MHz – 6000 MHz
 RESOLUTION BANDWIDTH: 1000 kHz

Frequency, MHz	Peak			Average			Antenna polarization	Antenna height, m	Turn-table position**, degrees	Verdict
	Measured emission, dB(μV/m)	Limit, dB(μV/m)	Margin, dB*	Measured emission, dB(μV/m)	Limit, dB(μV/m)	Margin, dB*				
No emissions were found										Pass

*- Margin = Measured emission - specification limit.
 **- EUT front panel refer to 0 degrees position of turntable.

Reference numbers of test equipment used

HL 0032	HL 0034	HL 0604	HL 0684	HL 0788	HL 0812	HL 0813	HL 1425
HL 1554	HL 1984	HL 2780	HL 2871	HL 4353			

Full description is given in Appendix A.



Test specification: FCC Section 15.109/ ICES-003 Section 6.2 Class B, Radiated emission			
Test procedure: ANSI C63.4, Section 11.6			
Test mode: Compliance	Verdict: PASS		
Date(s): 3/21/2013			
Temperature: 23 °C	Air Pressure: 1015 hPa	Relative Humidity: 43 %	Power Supply: 120 VAC
Remarks:			

Plot 8.2.1 Radiated emission measurements in 30 - 1000 MHz range, vertical antenna polarization

TEST SITE: Semi Anechoic chamber
TEST DISTANCE: 3 m

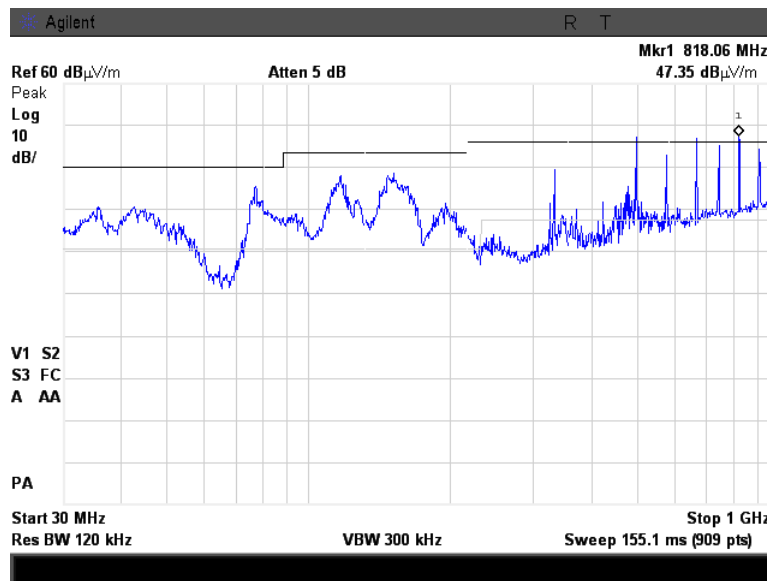

Plot 8.2.2 Radiated emission measurements in 30 - 1000 MHz range, horizontal antenna polarization

TEST SITE: Semi Anechoic chamber
TEST DISTANCE: 3 m

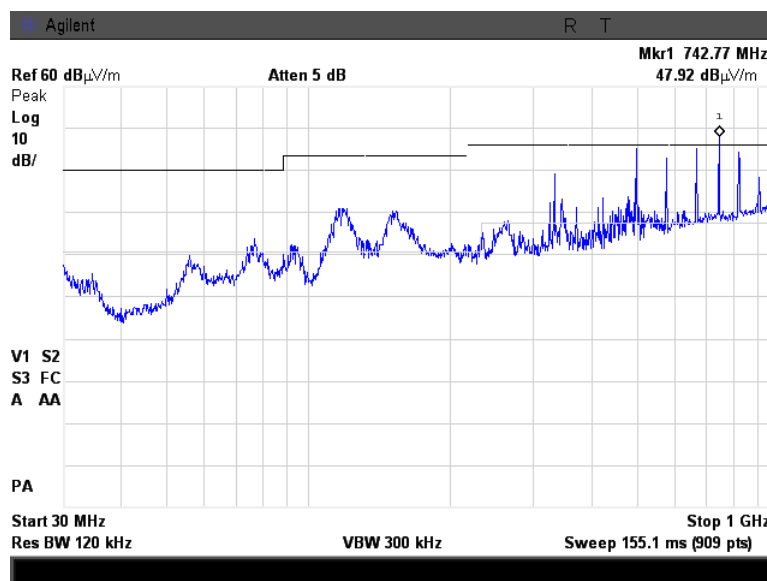



HERMON LABORATORIES

Test specification: FCC Section 15.109/ ICES-003 Section 6.2 Class B, Radiated emission			
Test procedure: ANSI C63.4, Section 11.6			
Test mode: Compliance	Verdict: PASS		
Date(s): 3/21/2013			
Temperature: 23 °C	Air Pressure: 1015 hPa	Relative Humidity: 43 %	Power Supply: 120 VAC
Remarks:			

Plot 8.2.3 Radiated emission measurements in 1000 – 6000 MHz range, vertical antenna polarization

TEST SITE:
TEST DISTANCE:

Semi Anechoic chamber
3 m

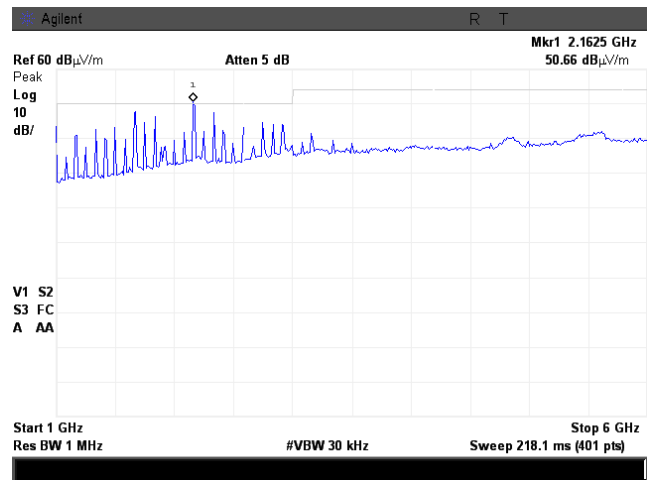
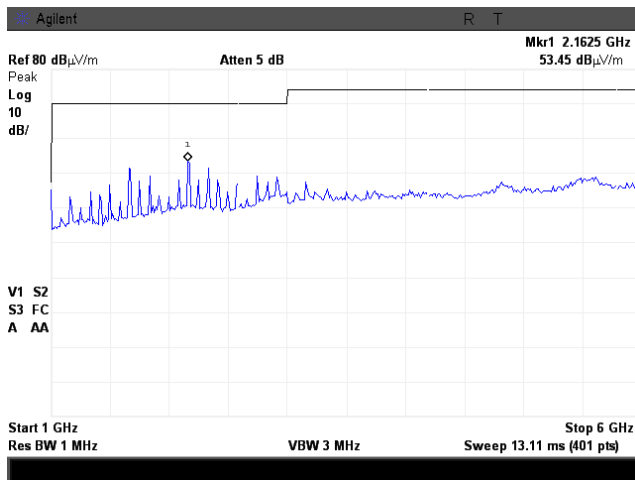

Plot 8.2.4 Radiated emission measurements in 1000 – 6000 MHz range, horizontal antenna polarization

TEST SITE:
TEST DISTANCE:

Semi Anechoic chamber
3 m

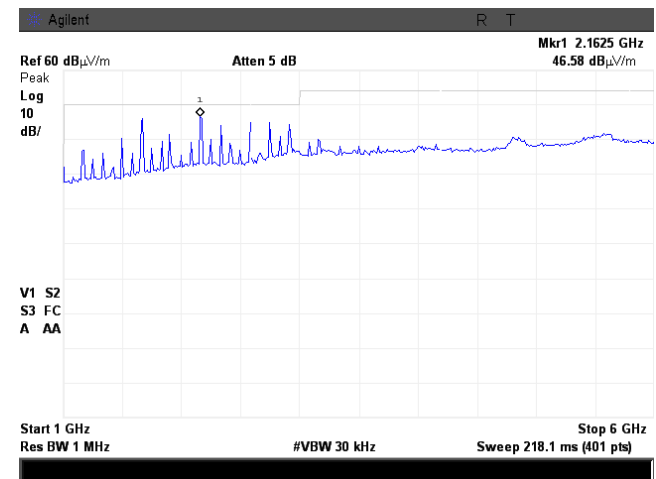
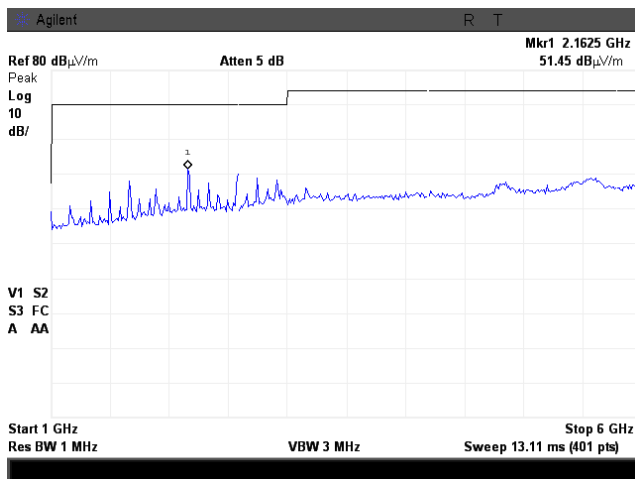

**9 APPENDIX A Test equipment and ancillaries used for tests**

HL No	Description	Manufacturer	Model	Ser. No.	Last Cal./ Check	Due Cal./ Check
0446	Antenna, Loop, Active, 10 kHz - 30 MHz	EMCO	6502	2857	03-Jul-12	03-Jul-13
0604	Antenna BiconiLog Log-Periodic/T Bow-TIE, 26 - 2000 MHz	EMCO	3141	9611-1011	20-May-12	20-May-14
0580	DC block adaptor 10 kHz - 2.2 GHz	Anritsu	MA8601 A	580	28-Nov-12	28-Nov-13
1425	EMI Receiver, 9 kHz - 2.9 GHz, System: HL1426, HL1427	Agilent Technologies	8542E	3710A002 22, 3705A002 04	26-Aug-12	26-Aug-13
1513	Cable RF, 8 m, BNC/BNC	Belden	M17/167 MIL-C-17	1513	02-Sep-12	02-Sep-13
1984	Antenna, Double-Ridged Waveguide Horn, 1-18 GHz, 300 W	EMC Test Systems	3115	9911-5964	07-Dec-12	07-Dec-13
2780	EMC analyzer, 100 Hz to 26.5 GHz	Agilent Technologies	E7405A	MY451024 62	09-Jul-12	09-Jul-13
2871	Microwave Cable Assembly, 18 GHz, 6.4 m, SMA - SMA	Huber-Suhner	198-8155- 00	2871	04-Dec-12	04-Dec-13
2888	LISN Two-line V-Network 50 Ohm / 50 uH + 5 Ohm, 16A, MIL STD 461E, CISPR 16-1	Rolf Heine	NNB- 2/16Z	02/10018	19-Mar-13	19-Mar-14
2909	Spectrum analyzer, ESA-E, 100 Hz to 26.5 GHz	Agilent Technologies	E4407B	MY414447 62	20-Dec-12	20-Dec-13
3612	Cable RF, 17.5 m, N type-N type	Teldor	RG-214/U	NA	02-Dec-12	02-Dec-13
3787	Precision Fixed Attenuator, 50 Ohm, 5 W, 10 dB, DC to 18 GHz	Mini-Circuits	BW- S10W5+	NA	04-Dec-12	04-Dec-13
4273	Test Cable , DC-18 GHz, 1.8 m, SMA/M - N/M	Mini-Circuits	CBL-6FT- SMNM+	70045	26-Nov-12	26-Nov-13
4351	Low Loss Armored Test Cable, DC - 18 GHz, 6.2 m, N type-M/N type-M	MegaPhase	NC29- N1N1-244	12025101 001	06-Mar-13	06-Mar-14
4353	Low Loss Armored Test Cable, DC - 18 GHz, 6.2 m, N type-M/N type-M	MegaPhase	NC29- N1N1-244	12025101 003	06-Mar-13	06-Mar-14

10 APPENDIX B Measurement uncertainties

Expanded uncertainty at 95% confidence in Hermon Labs EMC measurements

Test description	Expanded uncertainty
Conducted emissions with LISN	9 kHz to 150 kHz: ± 3.9 dB 150 kHz to 30 MHz: ± 3.8 dB
Radiated emissions at 10 m measuring distance Horizontal polarization Vertical polarization	Biconilog antenna: ± 5.0 dB Biconical antenna: ± 5.0 dB Log periodic antenna: ± 5.1 dB Double ridged horn antenna: ± 5.3 dB Biconilog antenna: ± 5.5 dB Biconical antenna: ± 5.5 dB Log periodic antenna: ± 5.6 dB Double ridged horn antenna: ± 5.8 dB
Radiated emissions at 3 m measuring distance Horizontal polarization Vertical polarization	Biconilog antenna: ± 5.3 dB Biconical antenna: ± 5.0 dB Log periodic antenna: ± 5.3 dB Double ridged horn antenna: ± 5.3 dB Biconilog antenna: ± 6.0 dB Biconical antenna: ± 5.7 dB Log periodic antenna: ± 6.0 dB Double ridged horn antenna: ± 6.0 dB
Conducted emissions at RF antenna connector	9 kHz to 2.9 GHz: ± 2.6 dB 2.9 GHz to 6.46 GHz: ± 3.5 dB 6.46 GHz to 13.2 GHz: ± 4.3 dB 13.2 GHz to 22.0 GHz: ± 5.0 dB 22.0 GHz to 26.8 GHz: ± 5.5 dB 26.8 GHz to 40.0 GHz: ± 4.8 dB
Duty cycle, timing (Tx ON / OFF) and average factor measurements	± 1.0 %
Occupied bandwidth	± 8.0 %

Hermon Laboratories is accredited by A2LA for calibration according to present requirements of ISO/IEC 17025 and NCSL Z540-1. The accreditation is granted to perform calibration of parameters that are listed in the Scope of Hermon Laboratories Accreditation.

Hermon Laboratories calibrates its reference and transfer standards by calibration laboratories accredited to ISO/IEC 17025 by a mutually recognized Accreditation Body or by a recognized national metrology institute. All reference and transfer standards used in the calibration system are traceable to national or international standards.

In-house calibration of all test and measurement equipment is performed on a regular basis according to Hermon Laboratories calibration procedures, manufacturer calibration/verification procedures or procedures defined in the relevant standards. The Hermon Laboratories test and measurement equipment is calibrated within the tolerances specified by the manufacturers and/or by the relevant standards.

11 APPENDIX C Test laboratory description

Tests were performed at Hermon Laboratories Ltd., which is a fully independent, private, EMC, safety, environmental and telecommunication testing facility.

Hermon Laboratories is listed by the Federal Communications Commission (USA) for all parts of Code of Federal Regulations 47 (CFR 47), Registration Numbers 90624 for OATS and 90623 for the anechoic chamber; by Industry Canada for electromagnetic emissions (file numbers IC 2186A-1 for OATS, IC 2186A-2 for anechoic chamber, IC 2186A-3 for full-anechoic chamber for RE measurements above 1 GHz), certified by VCCI, Japan (the registration numbers are R-808 for OATS, R-1082 for anechoic chamber, G-27 for full-anechoic chamber for RE measurements above 1 GHz, C-845 for conducted emissions site, T-1606 for conducted emissions at telecommunication ports), has a status of a Telefication - Listed Testing Laboratory, Certificate No. L138/00. The laboratory is accredited by American Association for Laboratory Accreditation (USA) according to ISO/IEC 17025 for electromagnetic compatibility, product safety, telecommunications testing and environmental simulation (for exact scope please refer to Certificate No. 839.01). The FCC Designation Number is US1003.

Address: P.O. Box 23, Binyamina 30500, Israel.
Telephone: +972 4628 8001
Fax: +972 4628 8277
e-mail: mail@hermonlabs.com
website: www.hermonlabs.com

Person for contact: Mr. Alex Usoskin, CEO.

12 APPENDIX D Specification references

FCC 47CFR part 15: 2012	Radio Frequency Devices
ANSI C63.2: 1996	American National Standard for Instrumentation-Electromagnetic Noise and Field Strength, 10 kHz to 40 GHz-Specifications
ANSI C63.4: 2003	American National Standard for Methods of Measurement of Radio-Noise Emissions from Low-Voltage Electrical and Electronic Equipment in the Range of 9 kHz to 40 GHz
RSS-210 Issue 8: 2010	Low Power Licence- Exempt Radiocommunication Devices
RSS-Gen Issue 3: 2010	General Requirements and Information for the Certification of Radiocommunication Equipment
ICES-003: 2012, Issue 5	Spectrum Management and Telecommunications Policy. Interference-Causing Equipment Standard. Information Technology Equipment (ITE) – Limits and methods of measurement



13 APPENDIX E Test equipment correction factors

Antenna factor
Active loop antenna
Model 6502, S/N 2857, HL 0446

Frequency, MHz	Magnetic antenna factor, dB	Electric antenna factor, dB
0.009	-32.8	18.7
0.010	-33.8	17.7
0.020	-38.3	13.2
0.050	-41.1	10.4
0.075	-41.3	10.2
0.100	-41.6	9.9
0.150	-41.7	9.8
0.250	-41.6	9.9
0.500	-41.8	9.8
0.750	-41.9	9.7
1.000	-41.4	10.1
2.000	-41.5	10.0
3.000	-41.4	10.2
4.000	-41.4	10.1
5.000	-41.5	10.1
10.000	-41.9	9.6
15.000	-41.9	9.6
20.000	-42.2	9.3
25.000	-42.8	8.7
30.000	-44.0	7.5

Antenna factor in dB(1/m) is to be added to receiver meter reading in dB(μ V) to convert it into field intensity in dB(μ V/m).



Antenna factor
Biconilog antenna EMCO Model 3141
Ser.No.1011, HL 0604

Frequency, MHz	Antenna Factor, dB(1/m)
26	7.8
28	7.8
30	7.8
40	7.2
60	7.1
70	8.5
80	9.4
90	9.8
100	9.7
110	9.3
120	8.8
130	8.7
140	9.2
150	9.8
160	10.2
170	10.4
180	10.4
190	10.3
200	10.6
220	11.6
240	12.4
260	12.8
280	13.7
300	14.7
320	15.2
340	15.4
360	16.1
380	16.4
400	16.6
420	16.7
440	17.0
460	17.7
480	18.1
500	18.5
520	19.1
540	19.5
560	19.8
580	20.6
600	21.3
620	21.5
640	21.2
660	21.4
680	21.9
700	22.2
720	22.2
740	22.1
760	22.3
780	22.6
800	22.7
820	22.9
840	23.1
860	23.4
880	23.8
900	24.1
920	24.1

Frequency, MHz	Antenna Factor, dB(1/m)
940	24.0
960	24.1
980	24.5
1000	24.9
1020	25.0
1040	25.2
1060	25.4
1080	25.6
1100	25.7
1120	26.0
1140	26.4
1160	27.0
1180	27.0
1200	26.7
1220	26.5
1240	26.5
1260	26.5
1280	26.6
1300	27.0
1320	27.8
1340	28.3
1360	28.2
1380	27.9
1400	27.9
1420	27.9
1440	27.8
1460	27.8
1480	28.0
1500	28.5
1520	28.9
1540	29.6
1560	29.8
1580	29.6
1600	29.5
1620	29.3
1640	29.2
1660	29.4
1680	29.6
1700	29.8
1720	30.3
1740	30.8
1760	31.1
1780	31.0
1800	30.9
1820	30.7
1840	30.6
1860	30.6
1880	30.6
1900	30.6
1920	30.7
1940	30.9
1960	31.2
1980	31.6
2000	32.0

Antenna factor in dB(1/m) is to be added to receiver meter reading in dB(μ V) to convert it into field intensity in dB(μ V/m).



Antenna factor
Double-ridged wave guide horn antenna
Model 3115, S/N 9911-5964, HL1984

Frequency, MHz	Antenna factor, dB(1/m)
1000.0	24.7
1500.0	25.7
2000.0	27.6
2500.0	28.9
3000.0	31.2
3500.0	32.0
4000.0	32.5
4500.0	32.7
5000.0	33.6
5500.0	35.1
6000.0	35.4
6500.0	34.9
7000.0	36.1
7500.0	37.8
8000.0	38.0
8500.0	38.1
9000.0	39.1
9500.0	38.3
10000.0	38.6
10500.0	38.2
11000.0	38.7
11500.0	39.5
12000.0	40.0
12500.0	40.4
13000.0	40.5
13500.0	41.1
14000.0	41.6
14500.0	41.7
15000.0	38.7
15500.0	38.2
16000.0	38.8
16500.0	40.5
17000.0	42.5
17500.0	45.9
18000.0	49.4

Antenna factor in dB(1/m) is to be added to receiver meter reading in dB(μ V) to convert it into field strength in dB(μ V/m).



Correction factor
Line impedance stabilization network
Model NNB-2/16Z, Rolf Heine, HL 2888

Frequency, kHz	Correction factor, dB	
	L	N
150	21.92	21.74
170	21.52	21.36
200	21.06	20.85
250	20.88	20.68
300	20.92	20.70
350	20.96	20.77
400	20.96	20.74
500	20.92	20.69
600	20.85	20.63
700	20.78	20.58
800	20.73	20.52
900	20.68	20.50
1000	20.67	20.45
1200	20.61	20.43
1500	20.56	20.33
2000	20.54	20.32
2500	20.51	20.33
3000	20.53	20.29
4000	20.46	20.30
5000	20.53	20.33
7000	20.54	20.32
10000	20.62	20.36
15000	20.78	20.49
20000	20.94	20.63
30000	21.37	20.95

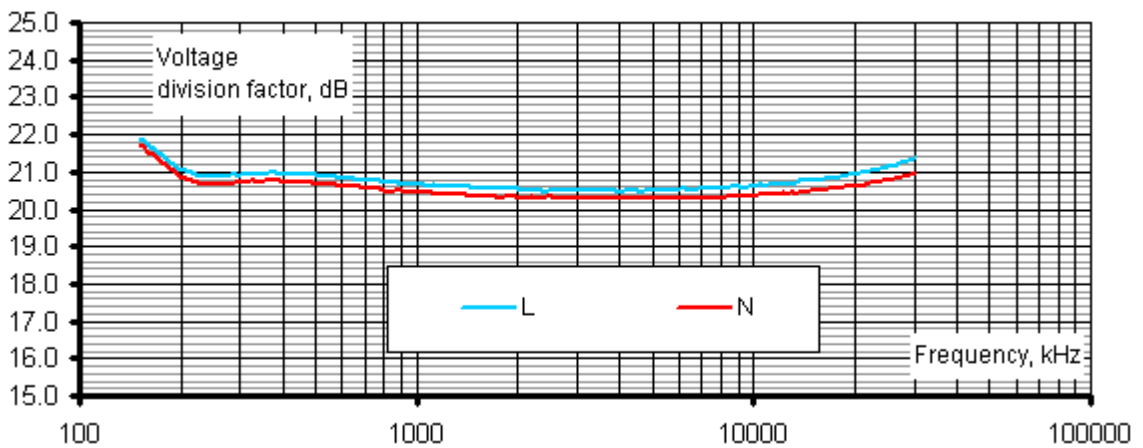



Cable loss
Cable coaxial, Huber-Suhner, 18 GHz, 6.4 m, SMA - SMA, model 198-8155-00,
HL 2871

Frequency, MHz	Cable loss, dB	Frequency, MHz	Cable loss, dB	Frequency, MHz	Cable loss, dB
10	0.12	5750	2.34	12000	3.55
30	0.14	6000	2.39	12250	3.61
100	0.27	6250	2.46	12500	3.67
250	0.45	6500	2.52	12750	3.74
500	0.63	6750	2.58	13000	3.79
750	0.76	7000	2.64	13250	3.82
1000	0.89	7250	2.68	13500	3.83
1250	1.01	7500	2.73	13750	3.83
1500	1.12	7750	2.78	14000	3.88
1750	1.23	8000	2.83	14250	3.93
2000	1.32	8250	2.88	14500	3.96
2250	1.41	8500	2.94	14750	4.01
2500	1.49	8750	2.97	15000	4.00
2750	1.58	9000	3.02	15250	4.01
3000	1.66	9250	3.07	15500	4.00
3250	1.73	9500	3.13	15750	4.13
3500	1.80	9750	3.18	16000	4.22
3750	1.87	10000	3.21	16250	4.29
4000	1.93	10250	3.26	16500	4.29
4250	2.01	10500	3.30	16750	4.32
4500	2.06	10750	3.36	17000	4.37
4750	2.12	11000	3.39	17250	4.45
5000	2.17	11250	3.44	17500	4.49
5250	2.24	11500	3.48	17750	4.53
5500	2.29	11750	3.52	18000	4.55



Cable loss
Cable coaxial, RG-214/U, N type-N type, 17 m
Teldor, HL 3612

Frequency, MHz	Cable loss, dB
0.1	0.05
0.5	0.07
1	0.10
3	0.22
5	0.29
10	0.39
30	0.68
50	0.90
100	1.27
150	1.58
200	1.80
250	2.12
300	2.36
350	2.60
400	2.82
450	2.99
500	3.23
550	3.40
600	3.56
650	3.71
700	3.90
750	4.04
800	4.23
850	4.39
900	4.55
950	4.65
1000	4.79



Cable loss
Test cable, Mini-Circuits, S/N 70045, 18 GHz, 1.8 m, SMA/M - N/M
CBL-6FT-SMNM+, HL 4273

Frequency, MHz	Cable loss, dB	Frequency, MHz	Cable loss, dB	Frequency, MHz	Cable loss, dB	Frequency, MHz	Cable loss, dB
10	0.09	4800	1.76	9800	2.70	14800	3.59
30	0.11	4900	1.78	9900	2.71	14900	3.59
50	0.14	5000	1.81	10000	2.73	15000	3.60
100	0.20	5100	1.82	10100	2.75	15100	3.63
200	0.30	5200	1.86	10200	2.76	15200	3.67
300	0.38	5300	1.89	10300	2.79	15300	3.70
400	0.45	5400	1.92	10400	2.81	15400	3.68
500	0.50	5500	1.96	10500	2.82	15500	3.70
600	0.55	5600	2.00	10600	2.83	15600	3.71
700	0.60	5700	2.03	10700	2.87	15700	3.77
800	0.65	5800	2.04	10800	2.87	15800	3.75
900	0.69	5900	2.07	10900	2.88	15900	3.77
1000	0.73	6000	2.10	11000	2.89	16000	3.79
1100	0.77	6100	2.10	11100	2.91	16100	3.85
1200	0.80	6200	2.11	11200	2.92	16200	3.82
1300	0.84	6300	2.11	11300	2.94	16300	3.83
1400	0.88	6400	2.14	11400	2.95	16400	3.88
1500	0.92	6500	2.15	11500	2.98	16500	3.89
1600	0.95	6600	2.15	11600	3.00	16600	3.92
1700	0.98	6700	2.16	11700	3.02	16700	3.88
1800	1.01	6800	2.19	11800	3.04	16800	3.95
1900	1.04	6900	2.22	11900	3.08	16900	3.91
2000	1.07	7000	2.24	12000	3.09	17000	3.97
2100	1.09	7100	2.26	12100	3.12	17100	3.92
2200	1.13	7200	2.29	12200	3.13	17200	3.94
2300	1.15	7300	2.32	12300	3.16	17300	3.94
2400	1.18	7400	2.36	12400	3.17	17400	3.98
2500	1.21	7500	2.39	12500	3.19	17500	3.93
2600	1.24	7600	2.41	12600	3.20	17600	3.95
2700	1.27	7700	2.43	12700	3.21	17700	3.96
2800	1.30	7800	2.46	12800	3.21	17800	3.97
2900	1.34	7900	2.49	12900	3.22	17900	3.96
3000	1.36	8000	2.52	13000	3.22	18000	3.97
3100	1.38	8100	2.52	13100	3.24		
3200	1.41	8200	2.54	13200	3.24		
3300	1.45	8300	2.59	13300	3.27		
3400	1.46	8400	2.61	13400	3.28		
3500	1.49	8500	2.60	13500	3.31		
3600	1.51	8600	2.63	13600	3.31		
3700	1.55	8700	2.65	13700	3.35		
3800	1.34	8800	2.65	13800	3.37		
3900	1.36	8900	2.65	13900	3.40		
4000	1.38	9000	2.66	14000	3.43		
4100	1.41	9100	2.66	14100	3.45		
4200	1.45	9200	2.67	14200	3.46		
4300	1.46	9300	2.67	14300	3.46		
4400	1.49	9400	2.67	14400	3.49		
4500	1.51	9500	2.68	14500	3.50		
4600	1.55	9600	2.69	14600	3.50		
4700	1.34	9700	2.69	14700	3.52		



Cable loss
Low Loss Armored Test Cable, MegaPhase, 18 GHz, 6.2 m, N type-M/N type-M,
NC29-N1N1-244S/N 12025101 001,
HL 4351

Frequency, MHz	Cable loss, dB	Frequency, MHz	Cable loss, dB
50	0.21	9000	2.86
100	0.28	9500	2.96
300	0.49	10000	3.05
500	0.63	10500	3.12
1000	0.90	11000	3.18
1500	1.10	11500	3.24
2000	1.29	12000	3.30
2500	1.44	12500	3.37
3000	1.58	13000	3.45
3500	1.71	13500	3.53
4000	1.84	14000	3.58
4500	1.95	14500	3.66
5000	2.05	15000	3.73
5500	2.17	15500	3.79
6000	2.29	16000	3.87
6500	2.39	16500	3.94
7000	2.47	17000	3.98
7500	2.56	17500	4.07
8000	2.70	18000	4.14
8500	2.77		



Cable loss
Low Loss Armored Test Cable, MegaPhase, 18 GHz, 6.2 m, N type-M/N type-M,
NC29-N1N1-244S/N 12025101 003,
HL 4353

Frequency, MHz	Cable loss, dB	Frequency, MHz	Cable loss, dB
50	0.20	9000	2.71
100	0.27	9500	2.81
300	0.47	10000	2.90
500	0.61	10500	2.97
1000	0.87	11000	3.06
1500	1.07	11500	3.13
2000	1.24	12000	3.20
2500	1.39	12500	3.26
3000	1.53	13000	3.34
3500	1.65	13500	3.39
4000	1.77	14000	3.47
4500	1.89	14500	3.54
5000	1.99	15000	3.62
5500	2.07	15500	3.69
6000	2.20	16000	3.76
6500	2.30	16500	3.83
7000	2.39	17000	3.86
7500	2.51	17500	3.94
8000	2.58	18000	4.02
8500	2.65		



14 APPENDIX F Abbreviations and acronyms

A	ampere
AC	alternating current
A/m	ampere per meter
AVRG	average (detector)
cm	centimeter
dB	decibel
dBm	decibel referred to one milliwatt
dB(μ V)	decibel referred to one microvolt
dB(μ V/m)	decibel referred to one microvolt per meter
dB(μ A)	decibel referred to one microampere
DC	direct current
EIRP	equivalent isotropically radiated power
ERP	effective radiated power
EUT	equipment under test
F	frequency
GHz	gigahertz
GND	ground
H	height
HL	Hermon laboratories
Hz	hertz
k	kilo
kHz	kilohertz
LO	local oscillator
m	meter
MHz	megahertz
min	minute
mm	millimeter
ms	millisecond
μ s	microsecond
NA	not applicable
OATS	open area test site
Ω	Ohm
PS	power supply
ppm	part per million (10^{-6})
QP	quasi-peak
RE	radiated emission
RF	radio frequency
rms	root mean square
Rx	receive
s	second
T	temperature
Tx	transmit
V	volt

END OF DOCUMENT