



FCC TEST REPORT

FCC ID: 2AAD8-U1835

On Behalf of

HAOLIYUAN (SHENZHEN) ELECTRONIC CO., LTD

802.11ac Wireless USB Adapter

Model No.: U1835

Prepared for : HAOLIYUAN (SHENZHEN) ELECTRONIC CO., LTD
Address : 3/F, Building A1, Junfeng Industrial Park Yonghe Road, Fuyong,
Bao'an District, Shenzhen, Guangdong, China

Prepared By : Shenzhen Alpha Product Testing Co., Ltd.
Address : Building i, No.2, Lixin Road, Fuyong Street, Bao'an District, 518103,
Shenzhen, Guangdong, China

Report Number : T1881968 02
Date of Receipt : December 24, 2018
Date of Test : December 24, 2018 –February 21, 2019
Date of Report : February 21, 2019
Version Number : REV0

TABLE OF CONTENTS

Description	Page
1. Summary of Standards And Results-----	6
1.1. Description of Standards and Results -----	6
2. General Information -----	7
2.1. Description of Device (EUT)-----	7
2.2. Accessories of Device (EUT) -----	8
2.3. Tested Supporting System Details -----	8
2.4. Block Diagram of connection between EUT and simulators -----	8
2.5. Test Mode Description -----	9
2.6. Test Conditions -----	10
2.7. Test Facility -----	10
2.8. Measurement Uncertainty -----	11
2.9. Test Equipment List -----	12
3. Spurious Emission -----	13
3.1. Test Limits -----	13
3.2. Test Procedure -----	13
3.3. Test Setup -----	14
3.4. Test Results -----	15
4. Power line Conducted Emission -----	22
4.1. Test Limits -----	22
4.2. Test Procedure -----	22
4.3. Test Setup -----	22
4.4. Test Results -----	23
5. Conducted Maximum Output Power -----	25
5.1. Test limits -----	25
5.2. Test Procedure -----	25
5.3. Test Setup -----	25
5.4. Test Results -----	25
6. Peak Power Spectral Density-----	27
6.1. Test limits -----	27
6.2. Test Procedure -----	27
6.3. Test Setup -----	27
6.4. Test Results -----	28
7. Bandwidth-----	35
7.1. Test limits -----	35
7.2. Test Procedure -----	35
7.3. Test Setup -----	35
7.4. Test Results -----	35
8. Band Edge Check-----	45
8.1. Test limits -----	45
8.2. Test Procedure -----	45
8.3. Test Setup -----	45
8.4. Test Results -----	45

- 9. Antenna Requirement ----- 56**
 - 9.1. Standard Requirement----- 56
 - 9.2. Antenna Connected Construction----- 56
 - 9.3. Results ----- 56
- 10. Test setup photo ----- 57**
 - 10.1. Photos of Radiated emission ----- 57
 - 10.2. Photos of Conducted Emission test----- 58
- 11. Test setup photo ----- 59**

TEST REPORT DECLARATION

Applicant : HAOLIYUAN (SHENZHEN) ELECTRONIC CO., LTD
 Address : 3/F, Building A1, Junfeng Industrial Park Yonghe Road, Fuyong, Bao'an District, Shenzhen, Guangdong, China
 Manufacturer : HAOLIYUAN (SHENZHEN) ELECTRONIC CO., LTD
 Address : 3/F, Building A1, Junfeng Industrial Park Yonghe Road, Fuyong, Bao'an District, Shenzhen, Guangdong, China
 EUT Description : 802.11ac Wireless USB Adapter
 (A) Model No. : U1835
 (B) Trademark : N/A

Measurement Standard Used:

FCC Rules and Regulations Part 15 Subpart C Section 15.247: 2017
ANSI C63.10:2013

The device described above is tested by Shenzhen Alpha Product Testing Co., Ltd. to determine the maximum emission levels emanating from the device. The maximum emission levels are compared to the FCC Part 15 Subpart C limits both conducted and radiated emissions. The test results are contained in this test report and Shenzhen Alpha Product Testing Co., Ltd. is assumed of full responsibility for the accuracy and completeness of these tests.

After the test, our opinion is that EUT compliance with the requirement of the above standards.

This report applies to above tested sample only. This report shall not be reproduced in parts without written approval of Shenzhen Alpha Product Testing Co., Ltd.

Tested by (name + signature).....: Reak Yang
 Project Engineer 

Approved by (name + signature).....: Simple Guan
 Project Manager 

Date of issue.....: February 21, 2019

Revision History

Revision	Issue Date	Revisions	Revised By
00	February 21, 2019	Initial released Issue	Simple Guan

1. SUMMARY OF STANDARDS AND RESULTS

1.1. Description of Standards and Results

The EUT have been tested according to the applicable standards as referenced below:

Test Item	Test Requirement	Standards Paragraph	Result
Conducted Emission	FCC PART 15:2017	15.207	P
6dB Bandwidth	FCC PART 15:2017	15.247 (a)(2)	P
Output Power	FCC PART 15:2017	15.247 (b)(3)	P
Radiated Spurious Emission	FCC PART 15:2017	15.247 (c)	P
Conducted Spurious & Band Edge Emission	FCC PART 15:2017	15.247 (d)	P
Power Spectral Density	FCC PART 15:2017	15.247 (e)	P
Radiated Band Edge Emission	FCC PART 15:2017	15.205	P
Antenna Requirement	FCC PART 15:2017	15.203	P
Note:	1. P is an abbreviation for Pass. 2. F is an abbreviation for Fail. 3. N/A is an abbreviation for Not Applicable.		

2. GENERAL INFORMATION

2.1. Description of Device (EUT)

Description	: 802.11ac Wireless USB Adapter
Model Number	: U1835
Diff	: N/A
Trademark	: N/A
Test Voltage	: DC 5V by USB port
Operation frequency	: 2412MHz-2462MHz for IEEE 802.11 b, g, n/HT20, 2422MHz~2452MHz for IEEE802.11n/HT40
Channel No.	: 802.11b/802.11g /802.11n(HT20): 11 802.11(HT40): 7
Modulation type	: IEEE 802.11b: DSSS(CCK,DQPSK,DBPSK) IEEE 802.11g: OFDM(64QAM, 16QAM, QPSK, BPSK) IEEE 802.11n :OFDM(64QAM, 16QAM, QPSK, BPSK)
Antenna Type	: ANT1: PCB Antenna, Maximum Gain is 3.0dBi ANT2: PCB Antenna, Maximum Gain is 3.0dBi ANT3: PCB Antenna, Maximum Gain is 3.0dBi ANTAUX: PCB Antenna, Receiving function only
Note	: Between ANT1, ANT2 and ANT3, only one antenna randomly transmits 5G Wi-Fi signals. The product does not have MIMO technology. And ANTAUX only has the function of receiving.
Software version	: 1030.28
Hardware version	: V1.1

2.2. Accessories of Device (EUT)

Accessories1 : /
Manufacturer : /
Model : /
Power supply : /

2.3. Tested Supporting System Details

No.	Description	Manufacturer	Model	Serial Number	Certification or DOC
1	Notebook	ACER	ZQT	N/A	DOC

2.4. Block Diagram of connection between EUT and simulators

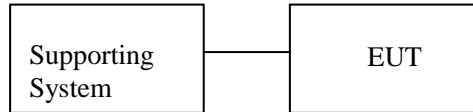

2.5. Test Mode Description

Duty cycle :100% Keeping TX			
Mode	data rate (Mbps)(see Note)	Channel	Frequency (MHz)
IEEE 802.11b	1	Low :CH1	2412
	1	Middle: CH6	2437
	1	High: CH11	2462
IEEE 802.11g	6	Low :CH1	2412
	6	Middle: CH6	2437
	6	High: CH11	2462
IEEE 802.11 n/HT20 with 2.4G	6.5	Low :CH1	2412
	6.5	Middle: CH6	2437
	6.5	High: CH11	2462
IEEE 802.11 n/HT40 with 2.4G	13	Low :CH3	2422
	13	Middle: CH6	2437
	13	High: CH9	2452

Note: According exploratory test, EUT will have maximum output power in those data rate. so those data rate were used for all test.

Channel list:					
For IEEE 802.11b, g, n/HT20 and IEEE 802.11 n/HT40 with 2.4G					
Channel	Frequency (MHz)	Channel	Frequency (MHz)	Channel	Frequency (MHz)
CH1	2412	CH5	2432	CH9	2452
CH2	2417	CH6	2437	CH10	2457
CH3	2422	CH7	2442	CH11	2462
CH4	2427	CH8	2447		

Setting output power (Max)			
802.11b	802.11g	802.11n(HT20)	802.11n(HT40)
12dBm	12dBm	12dBm	12dBm

2.6. Test Conditions

Items	Required	Actual
Temperature range:	15-35°C	27°C
Humidity range:	25-75%	56%
Pressure range:	86-106kPa	980kPa

2.7. Test Facility

Shenzhen Alpha Product Testing Co., Ltd
Building i, No.2, Lixin Road, Fuyong Street, Bao'an District, 518103,
Shenzhen, Guangdong, China

June 21, 2018 File on Federal Communication Commission
Registration Number: 293961

July 25, 2017 Certificated by IC
Registration Number: 12135A

2.8.Measurement Uncertainty

(95% confidence levels, k=2)

Item	Uncertainty
Uncertainty for Power point Conducted Emissions Test	2.74dB
Uncertainty for Radiation Emission test in 3m chamber (below 30MHz)	2.13 dB(Polarize: V)
	2.57dB(Polarize: H)
Uncertainty for Radiation Emission test in 3m chamber (30MHz to 1GHz)	3.77dB(Polarize: V)
	3.80dB(Polarize: H)
Uncertainty for Radiation Emission test in 3m chamber (1GHz to 25GHz)	4.16dB(Polarize: H)
	4.13dB(Polarize: V)
Uncertainty for radio frequency	5.4×10^{-8}
Uncertainty for conducted RF Power	0.37dB
Uncertainty for temperature	0.2°C
Uncertainty for humidity	1%
Uncertainty for DC and low frequency voltages	0.06%

2.9. Test Equipment List

Equipment	Manufacture	Model No.	Serial No.	Last cal.	Cal Interval
3m Semi-Anechoic	ETS-LINDGREN	N/A	SEL0017	2018.09.21	1 Year
Spectrum analyzer	Agilent	E4407B	MY46185649	2018.09.21	1 Year
Receiver	R&S	ESCI	1166.5950K03-1011	2018.09.21	1 Year
Receiver	R&S	ESCI	101202	2018.09.21	1 Year
Bilog Antenna	Schwarzbeck	VULB 9168	VULB9168-438	2018.04.13	2 Year
Horn Antenna	EMCO	3115	640201028-06	2018.04.13	2 Year
Active Loop Antenna	Beijing Daze	ZN30900A	SEL0097	2018.04.13	2 Year
Cable	Resenberger	N/A	No.1	2018.09.21	1 Year
Cable	SCHWARZBECK	N/A	No.2	2018.09.21	1 Year
Cable	SCHWARZBECK	N/A	No.3	2018.09.21	1 Year
Pre-amplifier	Schwarzbeck	BBV9743	9743-019	2018.09.21	1 Year
Pre-amplifier	R&S	AFS33-18002650-30-8P-44	SEL0080	2018.09.21	1 Year
Temperature controller	Terchy	MHQ	120	2018.09.21	1 Year
L.I.S.N.#1	Schwarzbeck	NSLK8126	8126466	2018.09.21	1 Year
L.I.S.N.#2	ROHDE&SCHWARZ	ENV216	101043	2018.09.21	1 Year
20db Attenuator	ICPROBING	IATS1	82347	2018.09.21	1 Year
Horn Antenna	SCHWARZBECK	BBHA 9170	BBHA 9170294	2018.04.13	2 Year
Power Meter	Anritsu	ML2487A	6K00001491	2018.09.21	1 Year

3. SPURIOUS EMISSION

3.1. Test Limits

Frequencies (MHz)	Field Strength (micorvolts/meter)	Measurement Distance (meters)
0.009~0.490	2400/F(KHz)	300
0.490~1.705	24000/F(KHz)	30
1.705~30.0	30	30
30~88	100	3
88~216	150	3
216~960	200	3
Above 960	500	3

Harmonic emissions limits comply with below 54 dBuV/m at 3m. Other emissions radiated outside of the specified frequency bands, except for harmonics, shall be attenuated by at least 50 dB below the level of the fundamental or comply with the radiated emissions limits specified in section 15.209(a) limit in the table below has to be followed.

NOTE:

- a) The tighter limit applies at the band edges.
- b) Emission Level(dB uV/m)=20log Emission Level(Uv/m)

3.2. Test Procedure

The measuring distance of 3m shall be used for measurements at frequency up to 1GHz and above 1GHz, The EUT was placed on a rotating 0.8 m high above ground, The table was rotated 360 degrees to determine the position of the highest radiation

The Test antenna shall vary between 1m and 4m,Both Horizontal and Vertical antenna are set of make measurement.

The initial step in collecting conducted emission data is a spectrum analyzer Peak detector mode pre-scanning the measurement frequency range. Significant Peaks are then marked. and then Qusia Peak Detector mode premeasured

If Peak value comply with QP limit Below 1GHz.The EUT deemed to comply with QP limit. But the Peak value and average value both need to comply with applicable limit above 1GHz.

For the actual test configuration, please see the test setup photo.

3.3. Test Setup

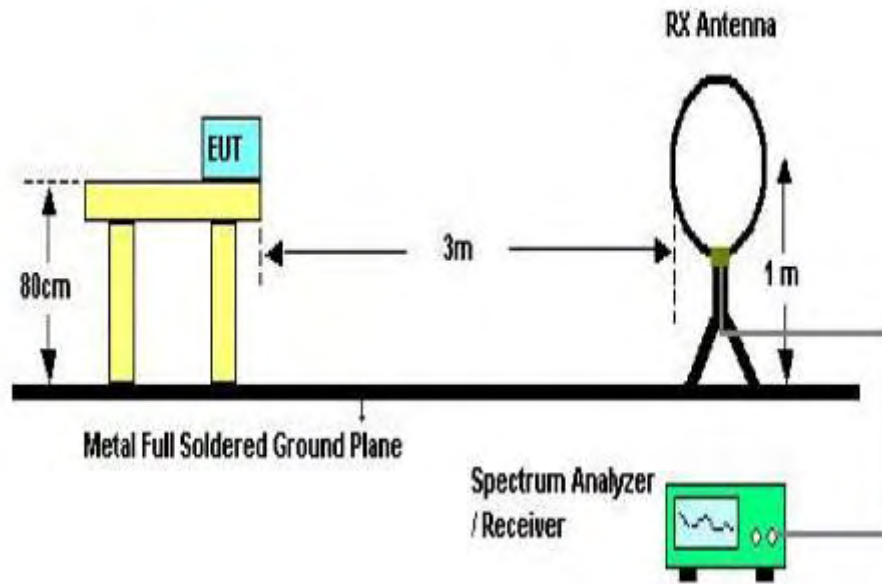

Below 30MHz Test Setup

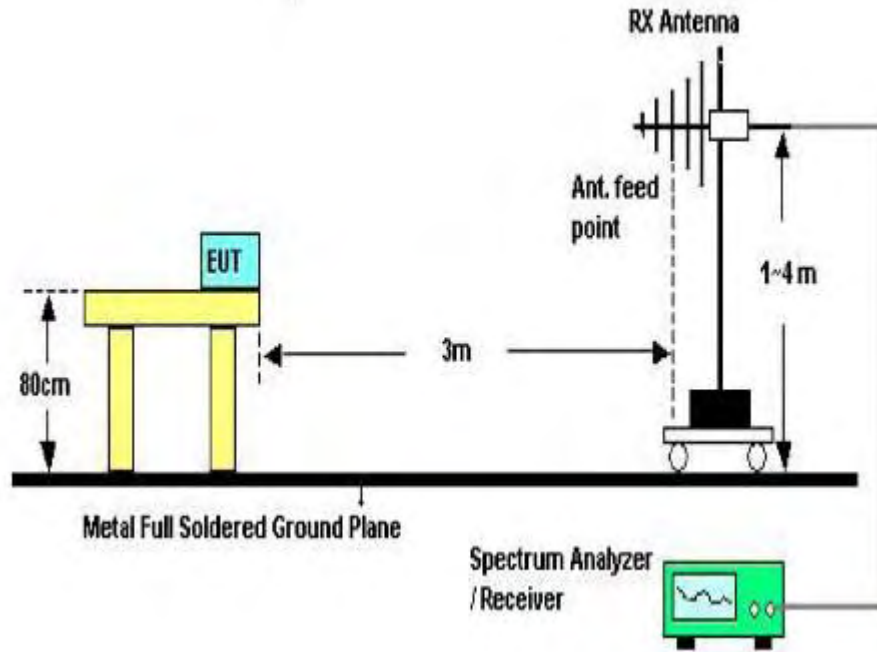

Above 30MHz Test Setup

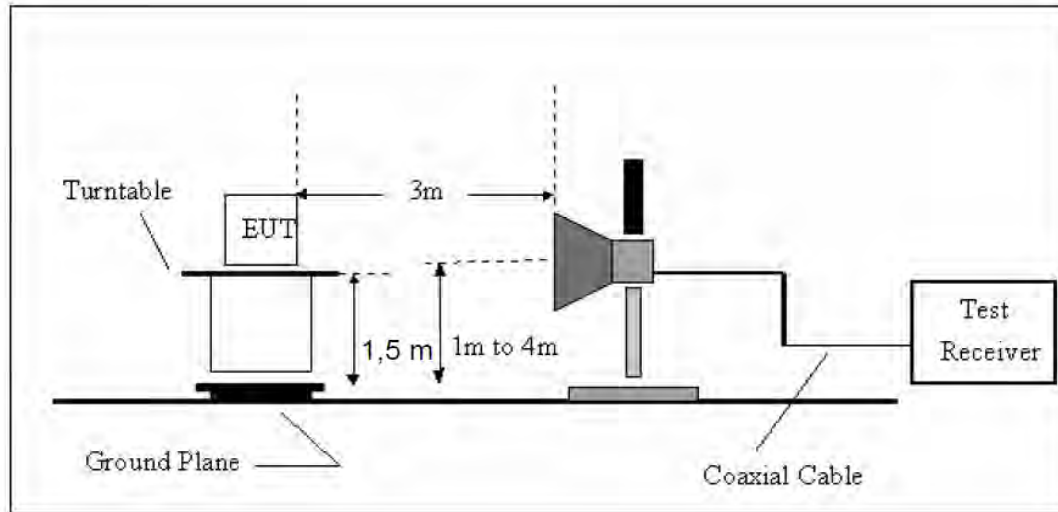

Above 1GHz Test Setup

3.4. Test Results

Test Condition

Continual Transmitting in maximum power.

9KHz~150KHz	RBW200Hz	VBW1KHz
150KHz~30MHz	RBW9KHz	VBW 30KHz
30MHz~1GHz	RBW120KHz	VBW 300KHz
Above1GHz	RBW1MHz	VBW 3MHz

We have scanned the 10th harmonic from 9 kHz to the EUT.

Detailed information please see the following page.

From 9KHz to 30MHz: Conclusion: PASS

Note:1.The amplitude of spurious emissions which are attenuated by more than 20dB below the permissible value has no need to be reported.

2.Only show the test data of the worst Channel in this report.

Test result for 802.11 n/HT40 (High Channel, ANT1), AC 120V/ 60Hz
Vertical

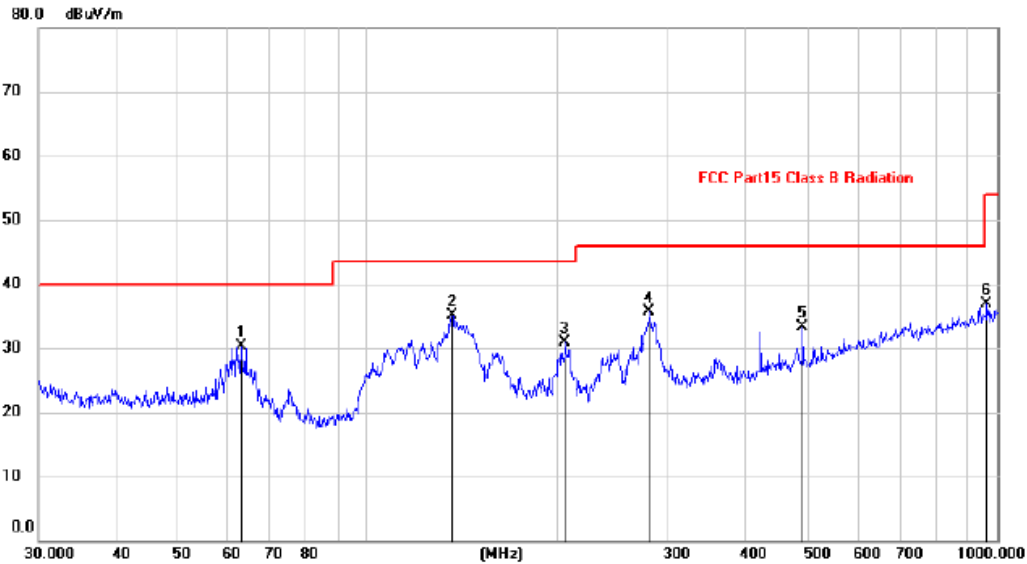

No. Mk.	Freq. MHz	Reading Level dBuV	Correct Factor dB	Measurement dBuV/m	Limit dBuV/m	Margin dB	Antenna Height cm	Table Degree	Detector	Comment
1	62.8708	17.35	12.90	30.25	40.00	-9.75			peak	
2 *	135.9822	20.68	14.44	35.12	43.50	-8.38			peak	
3	206.3976	19.47	11.49	30.96	43.50	-12.54			peak	
4	280.0237	21.54	14.13	35.67	46.00	-10.33			peak	
5	490.7447	14.68	18.70	33.38	46.00	-12.62			peak	
6	965.5421	11.55	25.44	36.99	54.00	-17.01			peak	

Note: 1. *:Maximum data; x:Over limit; !:over margin.

2.Measurement=Reading Level+Correct Factor; Correct Factor=Antenna Factor+Cable Loss.

Horizontal

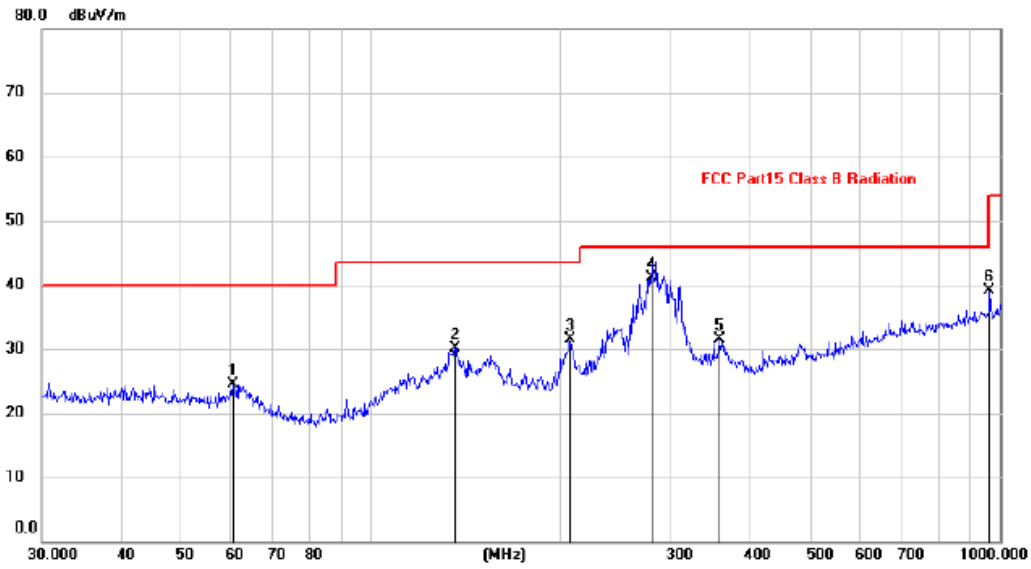

No.	Mk.	Freq.	Reading Level	Correct Factor	Measurement	Limit	Margin	Antenna Height	Table Degree
		MHz	dBuV	dB	dBuV/m	dBuV/m	dB	cm	degree
1		60.2801	10.94	13.49	24.43	40.00	-15.57	peak	
2		135.9822	15.76	14.44	30.20	43.50	-13.30	peak	
3		207.1226	19.94	11.51	31.45	43.50	-12.05	peak	
4	*	280.0237	26.93	14.13	41.06	46.00	-4.94	QP	
5		357.9287	15.55	15.97	31.52	46.00	-14.48	peak	
6		965.5421	13.65	25.44	39.09	54.00	-14.91	peak	

Note: 1. *:Maximum data; x:Over limit; !:over margin.

2. Measurement=Reading Level+Correct Factor; Correct Factor=Antenna Factor+Cable Loss.

From 1G-25GHz

Test Mode: IEEE 802.11b TX Low (worst case : ANT1)									
Freq (MHz)	Read Level (dBuV/m)	Polar (H/V)	Antenna Factor (dB/m)	Cable loss(dB)	Amp Factor (dB)	Result (dBuV/m)	Limit (dBuV/m)	Margin (dB)	Remark
4824	42.44	V	33.98	10.22	34.25	52.39	74	21.61	PK
4824	32.77	V	33.98	10.22	34.25	42.72	54	11.28	AV
7236	/	/	/	/	/	/	/	/	/
9648	/	/	/	/	/	/	/	/	/
4824	42.30	H	33.98	10.22	34.25	52.25	74	21.75	PK
4824	32.20	H	33.98	10.22	34.25	42.15	54	11.85	AV
7236	/	/	/	/	/	/	/	/	/
9648	/	/	/	/	/	/	/	/	/
Test Mode: IEEE 802.11b TX Mid									
4874	42.38	V	33.98	10.22	34.25	52.33	74	21.67	PK
4874	32.79	V	33.98	10.22	34.25	42.74	54	11.26	AV
7311	/	/	/	/	/	/	/	/	/
9748	/	/	/	/	/	/	/	/	/
4874	42.32	H	33.98	10.22	34.25	52.27	74	21.73	PK
4874	31.36	H	33.98	10.22	34.25	41.31	54	12.69	AV
7311	/	/	/	/	/	/	/	/	/
9748	/	/	/	/	/	/	/	/	/
Test Mode: IEEE 802.11b TX High									
4924	42.36	V	33.98	10.22	34.25	52.31	74	21.69	PK
4924	32.72	V	33.98	10.22	34.25	42.67	54	11.33	AV
7386	/	/	/	/	/	/	/	/	/
9848	/	/	/	/	/	/	/	/	/
4924	42.82	H	33.98	10.22	34.25	52.77	74	21.23	PK
4924	32.10	H	33.98	10.22	34.25	42.05	54	11.95	AV
7386	/	/	/	/	/	/	/	/	/
9848	/	/	/	/	/	/	/	/	/
Note:									
1, Result = Read level + Antenna factor + cable loss-Amp factor									
2, All the other emissions not reported were too low to read and deemed to comply with FCC limit.									

Test Mode: IEEE 802.11g TX Low (worst case : ANT1)									
Freq (MHz)	Read Level (dBuV/m)	Polar (H/V)	Antenna Factor (dB/m)	Cable loss(dB)	Amp Factor (dB)	Result (dBuV/m)	Limit (dBuV/m)	Margin (dB)	Remark
4824	42.61	V	33.98	10.22	34.25	52.56	74	21.44	PK
4824	33.02	V	33.98	10.22	34.25	42.97	54	11.03	AV
7236	/	/	/	/	/	/	/	/	/
9648	/	/	/	/	/	/	/	/	/
4824	42.84	H	33.98	10.22	34.25	52.79	74	21.21	PK
4824	31.47	H	33.98	10.22	34.25	41.42	54	12.58	AV
7236	/	/	/	/	/	/	/	/	/
9648	/	/	/	/	/	/	/	/	/
Test Mode: IEEE 802.11g TX Mid									
4874	42.26	V	33.98	10.22	34.25	52.21	74	21.79	PK
4874	32.31	V	33.98	10.22	34.25	42.26	54	11.74	AV
7311	/	/	/	/	/	/	/	/	/
9748	/	/	/	/	/	/	/	/	/
4874	42.17	H	33.98	10.22	34.25	52.12	74	21.88	PK
4874	32.18	H	33.98	10.22	34.25	42.13	54	11.87	AV
7311	/	/	/	/	/	/	/	/	/
9748	/	/	/	/	/	/	/	/	/
Test Mode: IEEE 802.11g TX High									
4924	42.28	V	33.98	10.22	34.25	52.23	74	21.77	PK
4924	32.17	V	33.98	10.22	34.25	42.12	54	11.88	AV
7386	/	/	/	/	/	/	/	/	/
9848	/	/	/	/	/	/	/	/	/
4924	42.38	H	33.98	10.22	34.25	52.33	74	21.67	PK
4924	31.68	H	33.98	10.22	34.25	41.63	54	12.37	AV
7386	/	/	/	/	/	/	/	/	/
9848	/	/	/	/	/	/	/	/	/
Note:									
1, Result = Read level + Antenna factor + cable loss-Amp factor									
2, All the other emissions not reported were too low to read and deemed to comply with FCC limit.									

Test Mode: IEEE 802.11n HT20 TX Low (ANT1)									
Freq (MHz)	Read Level (dBuV/m)	Polar (H/V)	Antenna Factor (dB/m)	Cable loss(dB)	Amp Factor (dB)	Result (dBuV/m)	Limit (dBuV/m)	Margin (dB)	Remark
4824	42.59	V	33.98	10.22	34.25	52.54	74	21.46	PK
4824	32.72	V	33.98	10.22	34.25	42.67	54	11.33	AV
7236	/	/	/	/	/	/	/	/	/
9648	/	/	/	/	/	/	/	/	/
4824	42.17	H	33.98	10.22	34.25	52.12	74	21.88	PK
4824	31.99	H	33.98	10.22	34.25	41.94	54	12.06	AV
7236	/	/	/	/	/	/	/	/	/
9648	/	/	/	/	/	/	/	/	/
Test Mode: IEEE 802.11n HT20 TX Mid (ANT1)									
4874	42.58	V	33.98	10.22	34.25	52.53	74	21.47	PK
4874	33.07	V	33.98	10.22	34.25	43.02	54	10.98	AV
7311	/	/	/	/	/	/	/	/	/
9748	/	/	/	/	/	/	/	/	/
4874	42.43	H	33.98	10.22	34.25	52.38	74	21.62	PK
4874	31.55	H	33.98	10.22	34.25	41.50	54	12.50	AV
7311	/	/	/	/	/	/	/	/	/
9748	/	/	/	/	/	/	/	/	/
Test Mode: IEEE 802.11n HT20 TX High (ANT1)									
4924	42.12	V	33.98	10.22	34.25	52.07	74	21.93	PK
4924	32.45	V	33.98	10.22	34.25	42.40	54	11.60	AV
7386	/	/	/	/	/	/	/	/	/
9848	/	/	/	/	/	/	/	/	/
4924	42.78	H	33.98	10.22	34.25	52.73	74	21.27	PK
4924	31.84	H	33.98	10.22	34.25	41.79	54	12.21	AV
7386	/	/	/	/	/	/	/	/	/
9848	/	/	/	/	/	/	/	/	/
Note:									
1, Result = Read level + Antenna factor + cable loss-Amp factor									
2, All the other emissions not reported were too low to read and deemed to comply with FCC limit.									

Test Mode: IEEE 802.11n HT40 TX Low (ANT1)									
Freq (MHz)	Read Level (dBUV/m)	Polar (H/V)	Antenna Factor (dB/m)	Cable loss(dB)	Amp Factor (dB)	Result (dBUV/m)	Limit (dBUV/m)	Margin (dB)	Remark
4844	42.03	V	33.98	10.22	34.25	51.98	74	22.02	PK
4844	32.17	V	33.98	10.22	34.25	42.12	54	11.88	AV
7266	/	/	/	/	/	/	/	/	/
9688	/	/	/	/	/	/	/	/	/
4844	42.14	H	33.98	10.22	34.25	52.09	74	21.91	PK
4844	32.12	H	33.98	10.22	34.25	42.07	54	11.93	AV
7266	/	/	/	/	/	/	/	/	/
9688	/	/	/	/	/	/	/	/	/
Test Mode: IEEE 802.11n HT40 TX Mid (ANT1)									
4874	42.56	V	33.98	10.22	34.25	52.51	74	21.49	PK
4874	32.37	V	33.98	10.22	34.25	42.32	54	11.68	AV
7311	/	/	/	/	/	/	/	/	/
9748	/	/	/	/	/	/	/	/	/
4874	42.89	H	33.98	10.22	34.25	52.84	74	21.16	PK
4874	32.22	H	33.98	10.22	34.25	42.17	54	11.83	AV
7311	/	/	/	/	/	/	/	/	/
9748	/	/	/	/	/	/	/	/	/
Test Mode: IEEE 802.11n HT40 TX High (ANT1)									
4904	42.75	V	33.98	10.22	34.25	52.70	74	21.30	PK
4904	32.90	V	33.98	10.22	34.25	42.85	54	11.15	AV
7356	/	/	/	/	/	/	/	/	/
9808	/	/	/	/	/	/	/	/	/
4904	42.18	H	33.98	10.22	34.25	52.13	74	21.87	PK
4904	31.99	H	33.98	10.22	34.25	41.94	54	12.06	AV
7356	/	/	/	/	/	/	/	/	/
9808	/	/	/	/	/	/	/	/	/
Note:									
1, Result = Read level + Antenna factor + cable loss-Amp factor									
2, All the other emissions not reported were too low to read and deemed to comply with FCC limit.									

Note: All models have been tested to reflect the data of the worst models.

4. POWER LINE CONDUCTED EMISSION

4.1. Test Limits

Frequency MHz	Limits dB(μ V)	
	Quasi-peak Level	Average Level
0.15 -0.50	66 -56*	56 - 46*
0.50 -5.00	56	46
5.00 -30.00	60	50

- Notes: 1. *Decreasing linearly with logarithm of frequency.
 2. The lower limit shall apply at the transition frequencies.
 3. The limit decreases in line with the logarithm of the frequency in the rang of 0.15 to 0.50 MHz.

4.2. Test Procedure

The EUT is put on the plane 0.8m high above the ground by insulating support and is connected to the power mains through a line impedance stabilization network (L.I.S.N.). This provides a 50ohm coupling impedance for the EUT system. Please refer the block diagram of the test setup and photographs. Both sides of AC lines are checked to find out the maximum conducted emission. In order to find the maximum emission levels, the relative positions of equipment and all of the interface cables shall be changed according to ANSI C63.10:2013 on Conducted Emission Measurement.

The bandwidth of test receiver is set at 9 kHz.

4.3. Test Setup

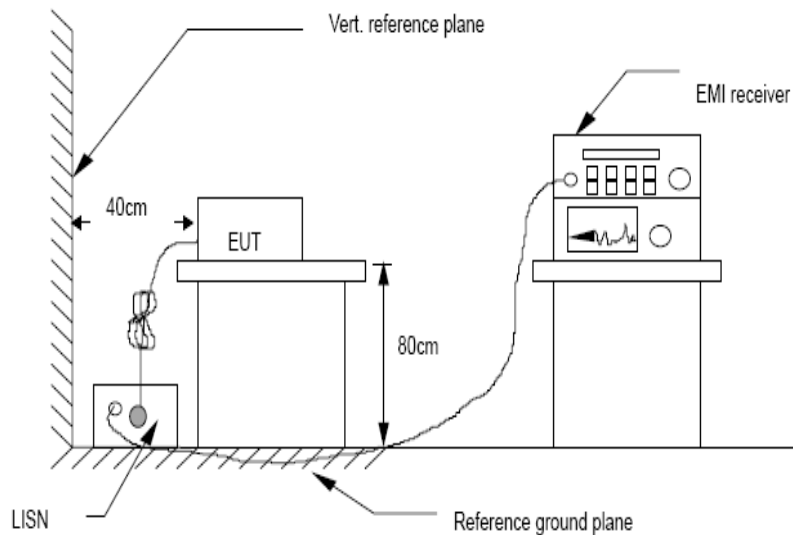

4.4. Test Results

Test result for 802.11b (High Channel: ANT1), AC 120V/ 60Hz

Line:

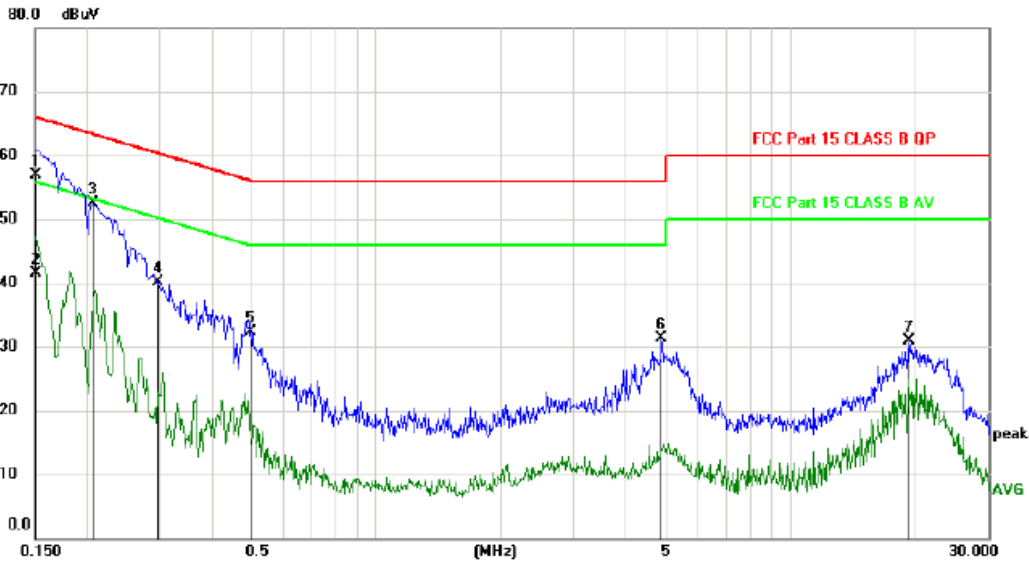

No.	Mk.	Freq. MHz	Reading Level dBuV	Correct Factor dB	Measure- ment dBuV	Limit dBuV	Margin dB	Detector	Comment
1	*	0.1500	47.16	9.73	56.89	66.00	-9.11	QP	
2		0.1500	31.81	9.73	41.54	56.00	-14.46	AVG	
3		0.2070	42.68	9.74	52.42	63.32	-10.90	peak	
4		0.2940	30.39	9.76	40.15	60.41	-20.26	peak	
5		0.4980	22.44	9.78	32.22	56.03	-23.81	peak	
6		4.8750	21.09	10.18	31.27	56.00	-24.73	peak	
7		19.2360	20.37	10.49	30.86	60.00	-29.14	peak	

Neutral:

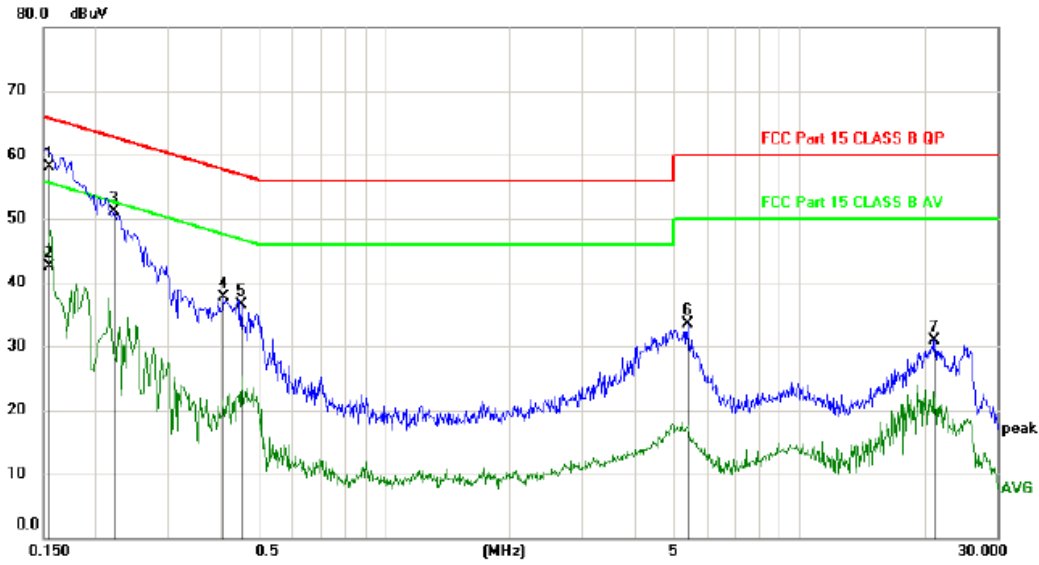

No.	Mk.	Freq. MHz	Reading Level dBuV	Correct Factor dB	Measure- ment dBuV	Limit dBuV	Margin dB	Detector	Comment
1	*	0.1548	48.40	9.73	58.13	65.74	-7.61	QP	
2		0.1548	32.70	9.73	42.43	55.74	-13.31	AVG	
3		0.2220	41.29	9.75	51.04	62.74	-11.70	peak	
4		0.4080	27.90	9.77	37.67	57.69	-20.02	peak	
5		0.4500	26.74	9.78	36.52	56.88	-20.36	peak	
6		5.3760	23.27	10.20	33.47	60.00	-26.53	peak	
7		21.2070	20.44	10.55	30.99	60.00	-29.01	peak	

*:Maximum data x:Over limit !:over margin

Note: Measurement=Reading Level+Correc Factor. Factor=(LISN or ISN or PLC or Current Probe)Factor+Cable

Note: All models have been tested to reflect the data of the worst models.

5. CONDUCTED MAXIMUM OUTPUT POWER

5.1. Test limits

Please refer section 15.247.

Regulation 15.247(b) The limit of Maximum Peak Output Power Measurement is 1 W(30dBm)

5.2. Test Procedure

Details see the KDB558074 D01 Meas Guidance V05R01

5.2.1 Place the EUT on the table and set it in transmitting mode.

5.2.2 Connected the EUT's antenna port to peak power meter by 20dB attenuator.

5.2.3 Measure out each mode and each bands peak output power of EUT.

Note: The cable loss and attenuator loss were offset into measure device as amplitude offset.

5.3. Test Setup

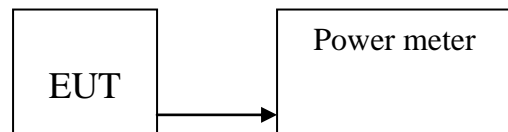

5.4. Test Results

PASS

Detailed information please see the following page.

Mode	Frequency (MHz)	PK Output power(dBm)			Limit (dBm)	Result
		ANT1	ANT2	ANT3		
IEEE 802.11 b	CH1: 2412	5.50	5.48	5.33	30	PASS
	CH6: 2437	5.25	5.24	5.01	30	PASS
	CH11: 2462	4.60	4.37	4.20	30	PASS
IEEE 802.11 g	CH1: 2412	5.80	5.90	5.85	30	PASS
	CH6: 2437	4.50	4.56	4.44	30	PASS
	CH11: 2462	4.30	4.28	4.37	30	PASS
IEEE 802.11 n/HT20	CH1: 2412	4.09	4.15	4.17	30	PASS
	CH6: 2437	4.39	4.42	4.44	30	PASS
	CH11: 2462	4.18	4.25	4.27	30	PASS
IEEE 802.11 n/HT40	CH3: 2422	4.55	4.58	4.55	30	PASS
	CH6: 2437	4.32	4.80	4.89	30	PASS
	CH9: 2452	4.39	4.45	4.46	30	PASS

6. PEAK POWER SPECTRAL DENSITY

6.1. Test limits

6.1.1 Please refer section 15.247.

6.1.2 For direct sequence systems, the peak power spectral density conducted from the intentional radiator to the antenna shall not be greater than 8dBm in any 3kHz band during any time interval of continuous transmission.

6.1.3 The direct sequence operating of the hybrid system, with the frequency hopping operation turned off, shall comply with the power density requirements of paragraph (d) of this section.

6.2. Test Procedure

Details see the KDB558074 D01 Meas Guidance V05R01

6.2.1 Place the EUT on the table and set it in transmitting mode.

6.2.2 Remove the antenna from the EUT and then connect a low loss RF cable from the antenna port to the spectrum analyzer.

6.2.3 Set the spectrum analyzer as $RBW = 3\text{kHz}$ (Set the RBW to: $3\text{ kHz} \leq RBW \leq 100\text{ kHz}$), $VBW = 10\text{kHz}$ (Set the $VBW \geq 3 \times RBW$), $\text{span} = 1.5 \times \text{DTS bandwidth}$., detail see the test plot.

6.2.4 Record the max reading.

6.2.5 Repeat the above procedure until the measurements for all frequencies are completed.

6.3. Test Setup

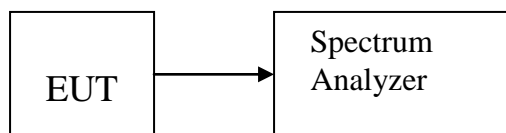

6.4. Test Results

Mode	Frequency (MHz)	Power Spectral Density (dBm)			Limit (dBm)	Result
		ANT1	ANT2	ANT3		
IEEE 802.11 b	Lowest	-18.448	-18.556	-18.588	8	PASS
	Middle	-18.127	-18.036	-18.103	8	PASS
	Highest	-18.136	-18.481	-18.100	8	PASS
IEEE 802.11 g	Lowest	-12.299	-12.072	-12.299	8	PASS
	Middle	-12.068	-11.939	-12.088	8	PASS
	Highest	-12.176	-12.203	-12.176	8	PASS
IEEE 802.11 n/HT20	Lowest	-12.242	-12.053	-12.242	8	PASS
	Middle	-11.863	-12.172	-12.134	8	PASS
	Highest	-12.134	-12.257	-12.253	8	PASS
IEEE 802.11 n/HT40	Lowest	-12.203	-12.239	-12.203	8	PASS
	Middle	-12.228	-12.180	-12.228	8	PASS
	Highest	-12.385	-12.231	-12.385	8	PASS

ANT1:

802.11b	802.11g
---------	---------

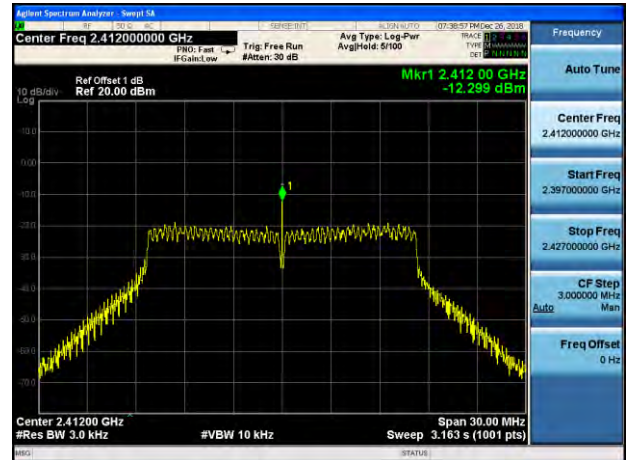
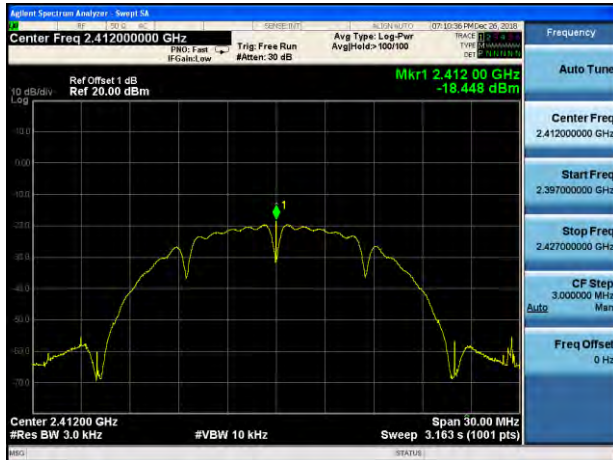

Lowest channel

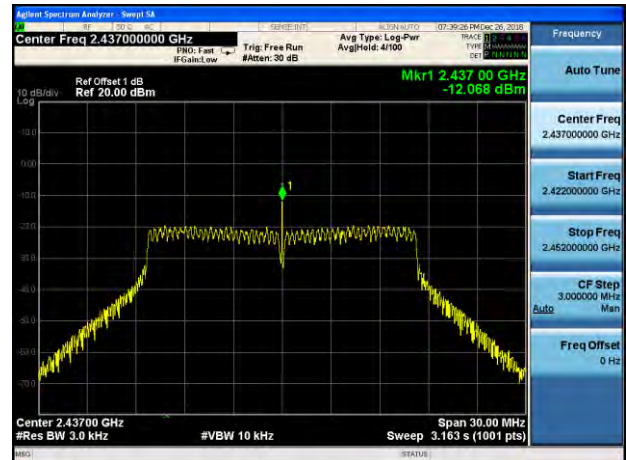

Middle channel

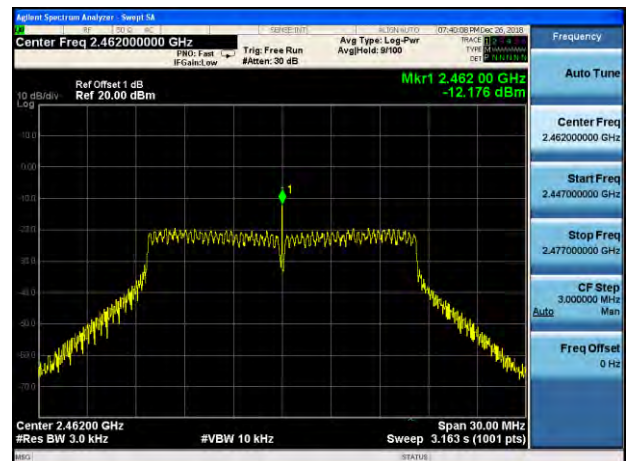

Highest channel

ANT1:

802.11n(HT20)	802.11n(HT40)
---------------	---------------

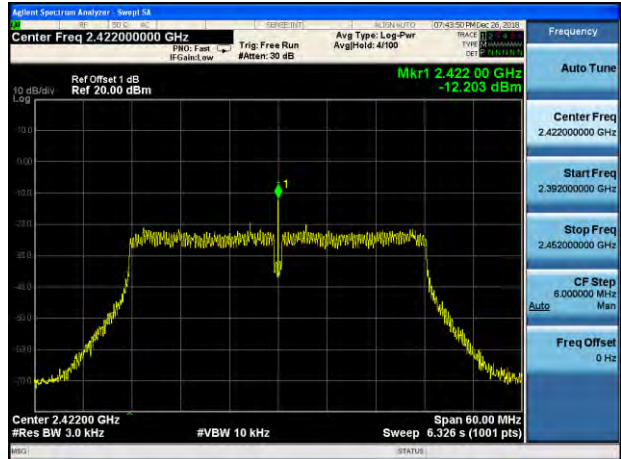
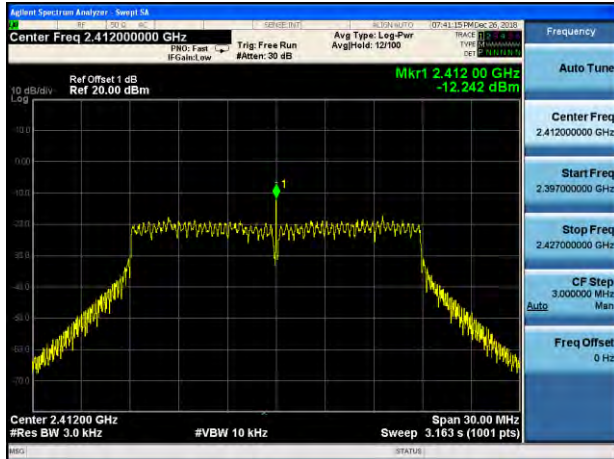

Lowest channel

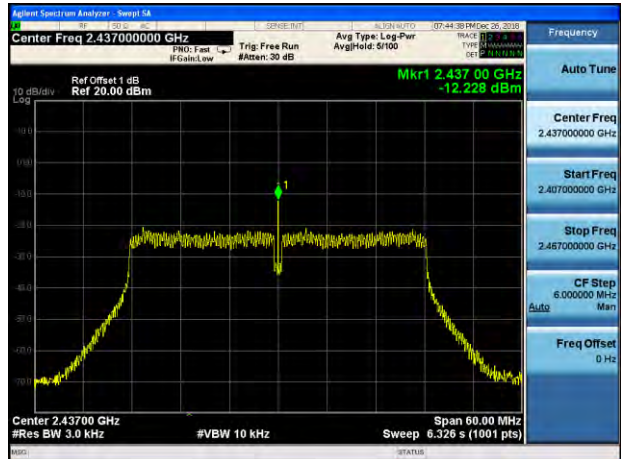
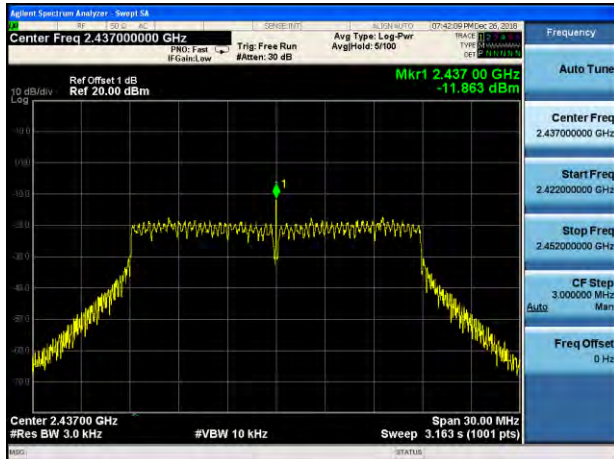

Middle channel

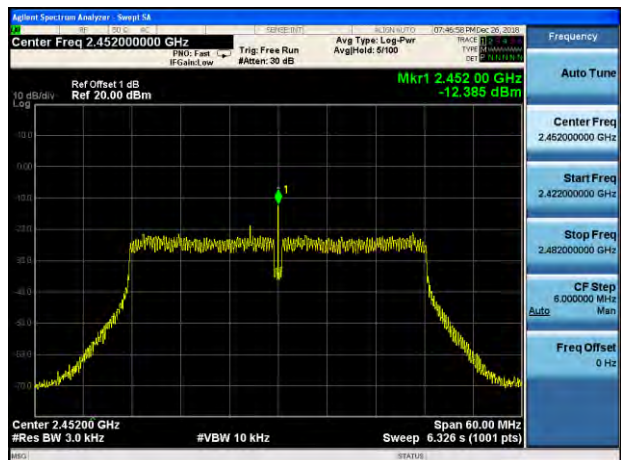
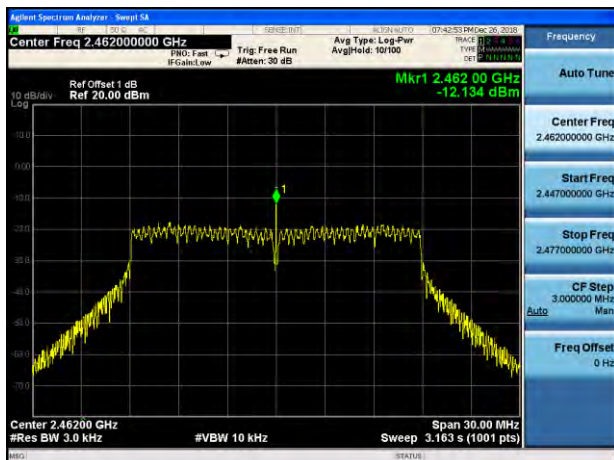

Highest channel

ANT2:

802.11b	802.11g
---------	---------

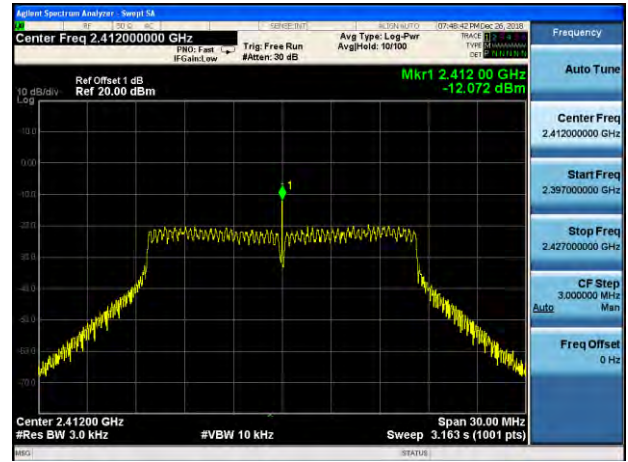

Lowest channel

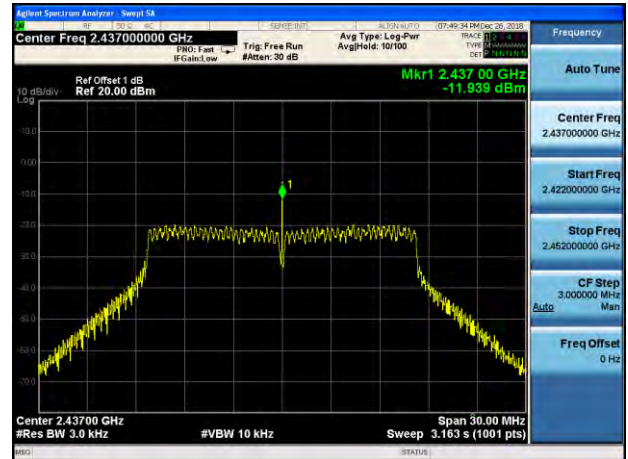

Middle channel

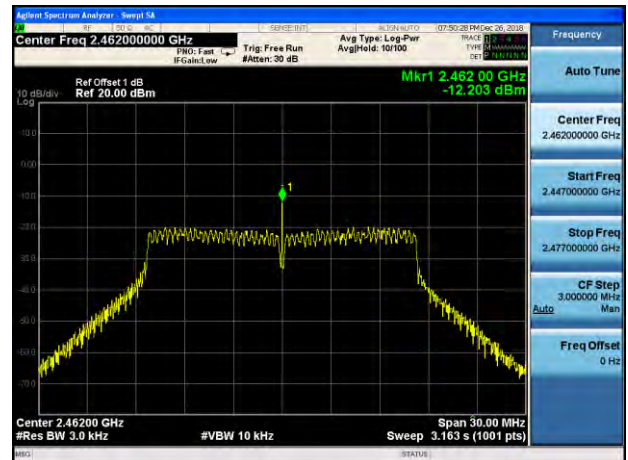

Highest channel

ANT2:

802.11n(HT20)	802.11n(HT40)
---------------	---------------

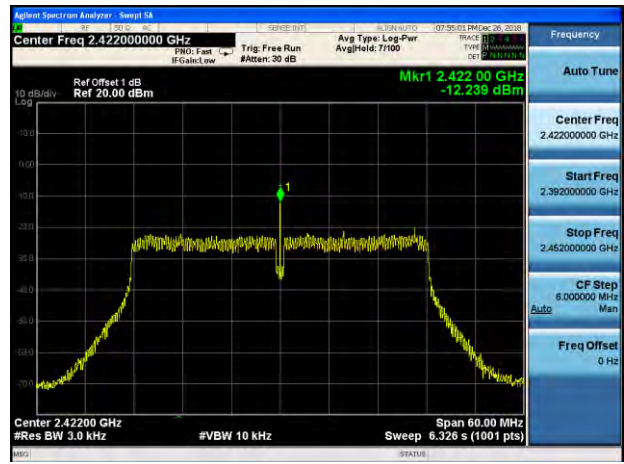
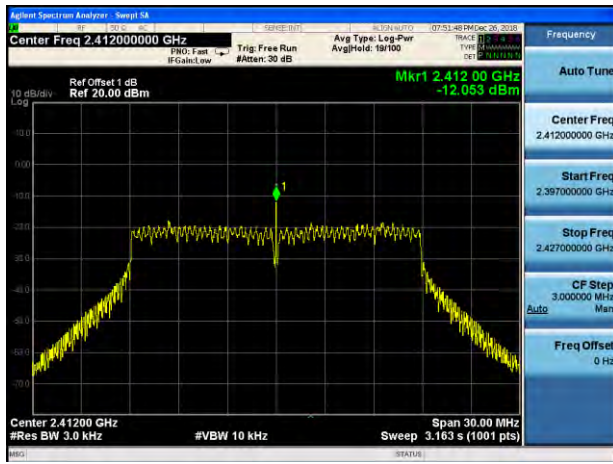

Lowest channel

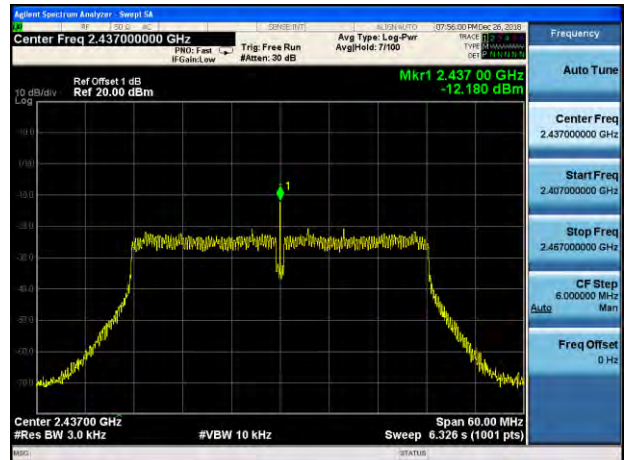
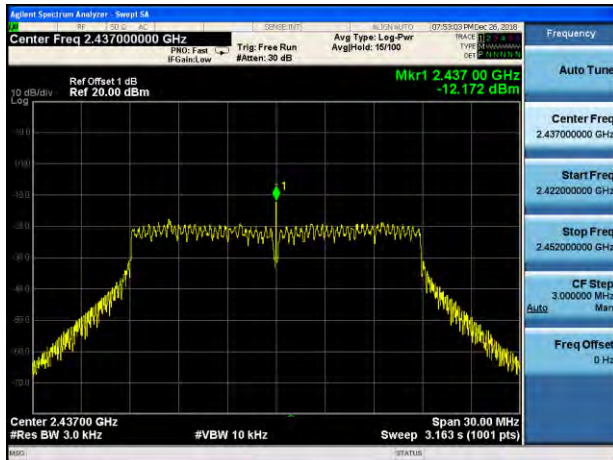

Middle channel

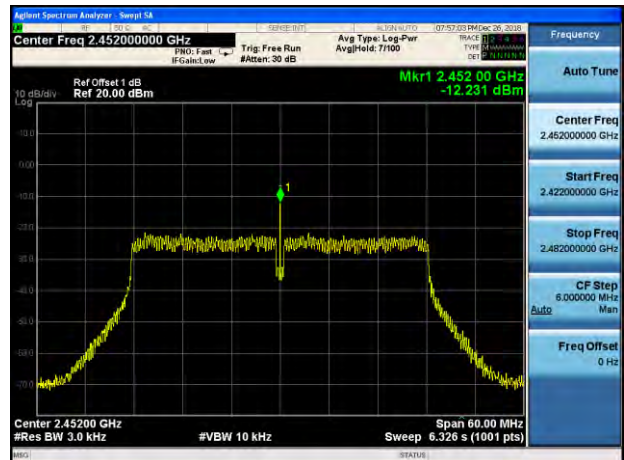
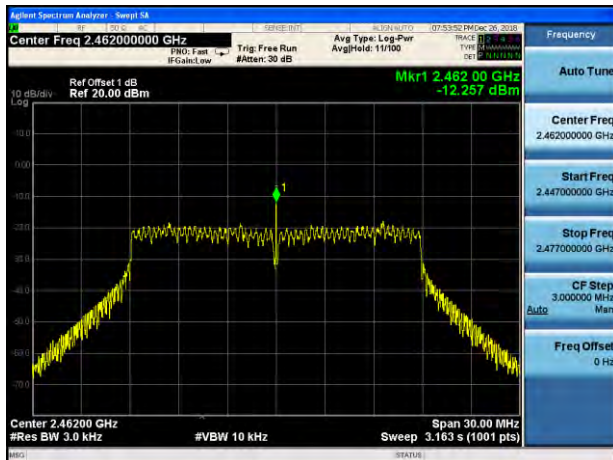

Highest channel

ANT3:

802.11b	802.11g
---------	---------

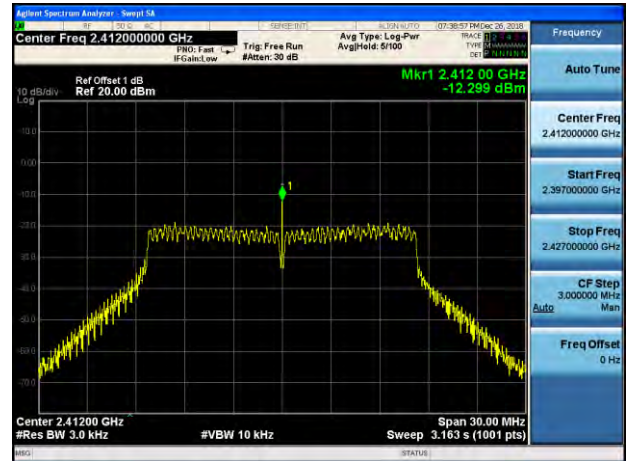

Lowest channel

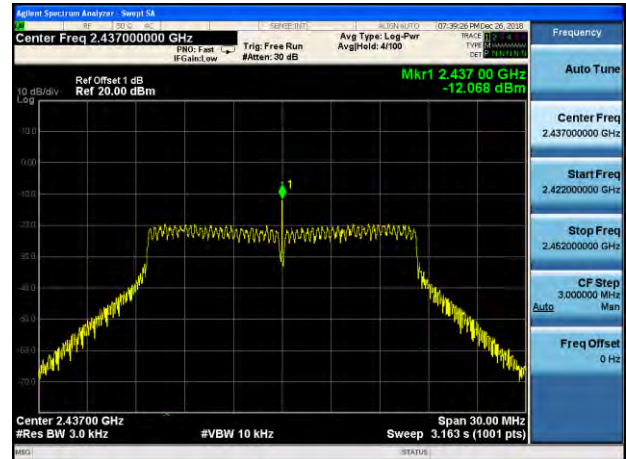

Middle channel

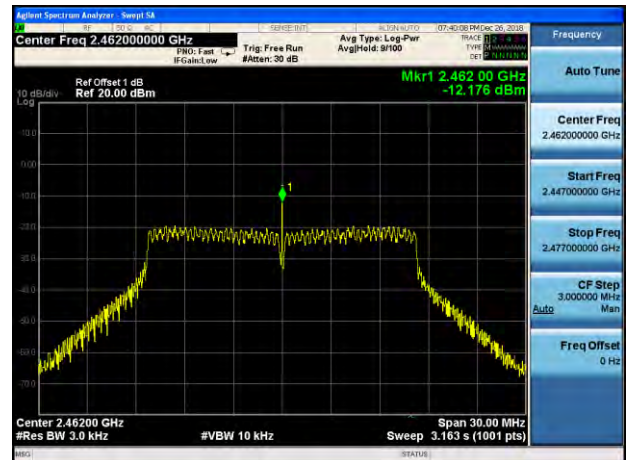

Highest channel

ANT3:

802.11n(HT20)	802.11n(HT40)
---------------	---------------

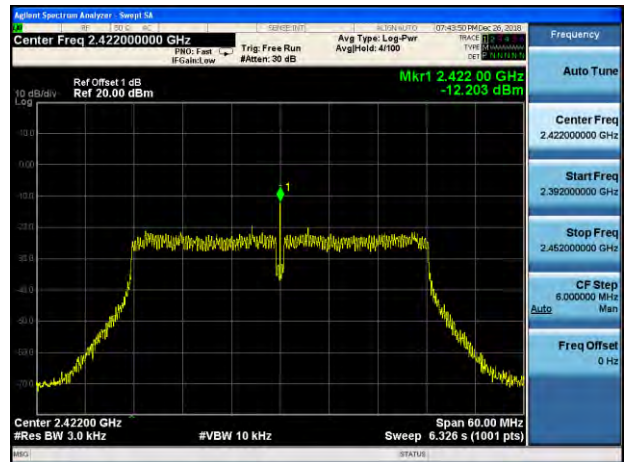
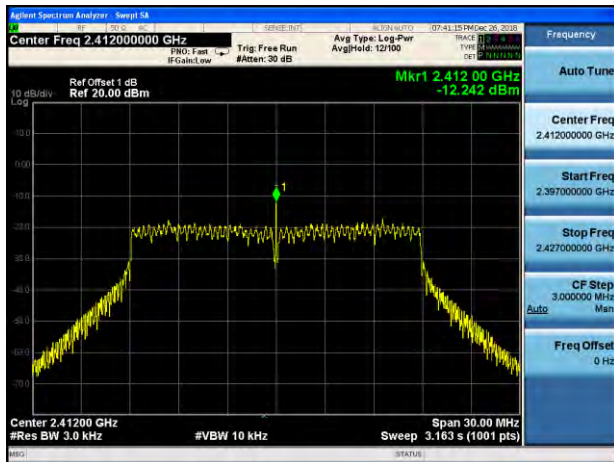

Lowest channel

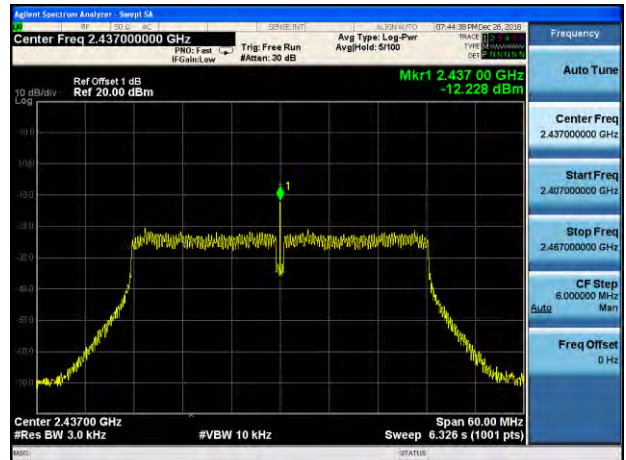
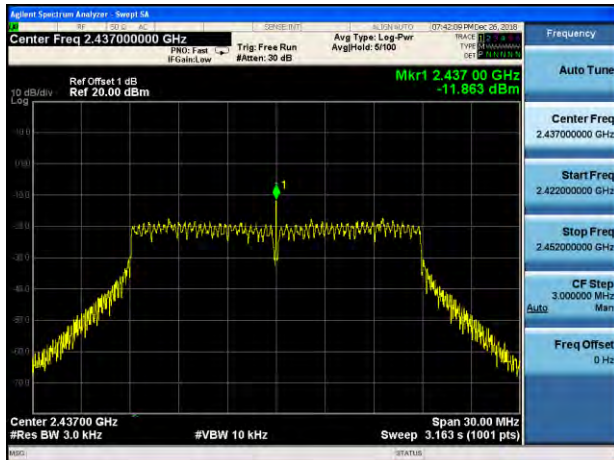

Middle channel

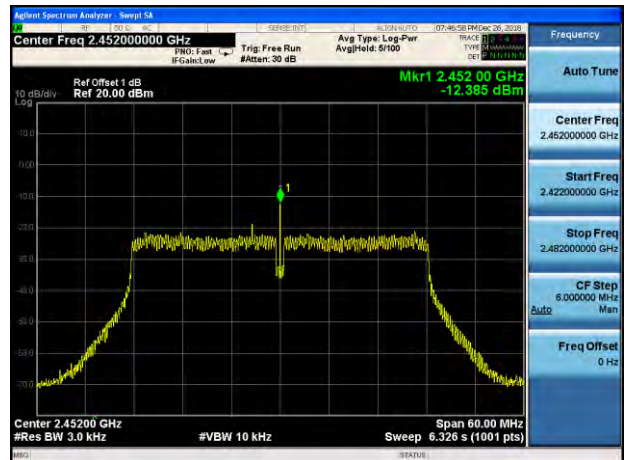
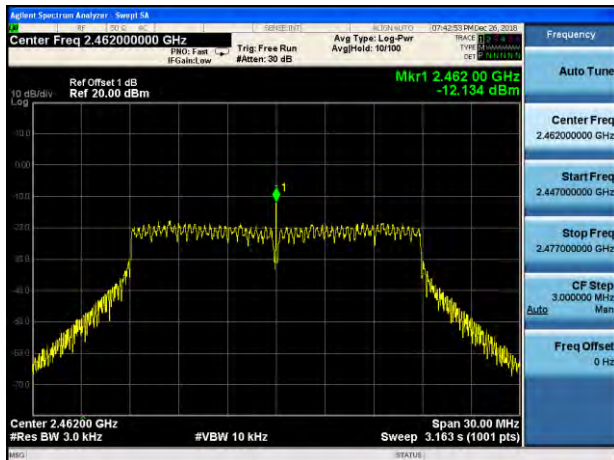

Highest channel

7. BANDWIDTH

7.1. Test limits

Please refer section 15.247

For direct sequence systems, the minimum 6dB bandwidth shall be at least 500 kHz.

7.2. Test Procedure

Details see the KDB558074 D01 Meas Guidance V05R01

- a) The bandwidth is measured at an amplitude level reduced 20dB from the reference level. The reference level is the level of the highest amplitude signal observed from the transmitter at the fundamental frequency. Once the reference level is established, the equipment is conditioned with typical modulating signal to produce the worst-case (i.e. the widest) bandwidth.
- b) The test receiver set $RBW = 100\text{kHz}$, $VBW \geq 3 * RBW = 300\text{kHz}$, Peak Detector, Sweep time set auto, detail see the test plot.

7.3. Test Setup

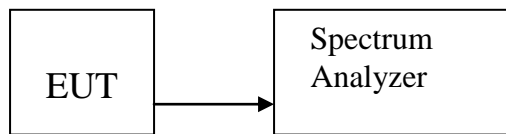

7.4. Test Results

ANT1:

IEEE 802.11b:					
Channel	Frequency (MHz)	6dB Bandwidth (MHz)	99% Occupied Bandwidth (MHz)	Limit (MHz)	Result
Low	2412	10.15	15.198	0.5	PASS
Mid	2437	10.15	15.185	0.5	PASS
High	2462	10.16	15.234	0.5	PASS
IEEE 802.11g					
Channel	Frequency (MHz)	6dB Bandwidth (MHz)	99% Occupied Bandwidth (MHz)	Limit (MHz)	Result
Low	2412	16.60	16.537	0.5	PASS
Mid	2437	16.59	16.526	0.5	PASS
High	2462	16.60	16.513	0.5	PASS
IEEE 802.11n/HT20					
Channel	Frequency (MHz)	6dB Bandwidth (MHz)	99% Occupied Bandwidth (MHz)	Limit (MHz)	Result
Low	2412	17.84	17.716	0.5	PASS
Mid	2437	17.81	17.724	0.5	PASS
High	2462	17.81	17.726	0.5	PASS
IEEE 802.11n/HT40					
Channel	Frequency (MHz)	6dB Bandwidth (MHz)	99% Occupied Bandwidth (MHz)	Limit (MHz)	Result
Low	2422	36.59	36.221	0.5	PASS
Mid	2437	36.58	36.230	0.5	PASS
High	2452	36.57	36.230	0.5	PASS

IEEE 802.11b: **IEEE 802.11g:**

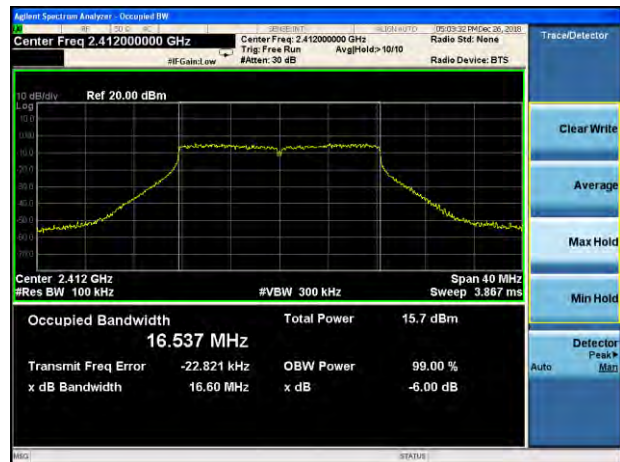

Lowest channel



Middle channel

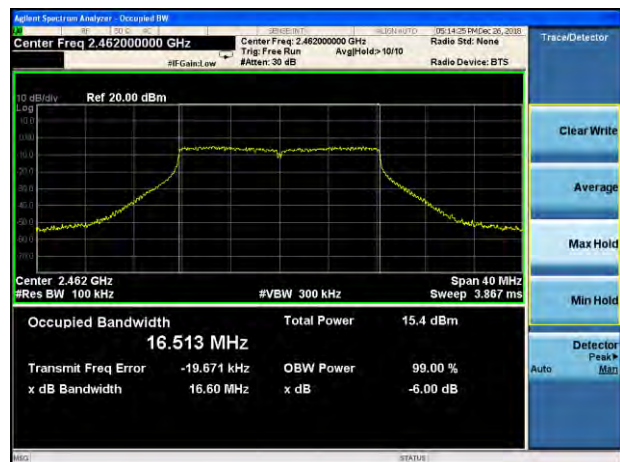

Highest channel

IEEE 802.11n/HT20 **IEEE 802.11n/HT40**



Lowest channel



Middle channel



Highest channel

ANT2:

IEEE 802.11b:					
Channel	Frequency (MHz)	6dB Bandwidth (MHz)	99% Occupied Bandwidth (MHz)	Limit (MHz)	Result
Low	2412	10.14	15.175	0.5	PASS
Mid	2437	10.15	15.178	0.5	PASS
High	2462	10.13	15.169	0.5	PASS
IEEE 802.11g					
Channel	Frequency (MHz)	6dB Bandwidth (MHz)	99% Occupied Bandwidth (MHz)	Limit (MHz)	Result
Low	2412	16.57	16.528	0.5	PASS
Mid	2437	16.60	16.506	0.5	PASS
High	2462	16.60	16.514	0.5	PASS
IEEE 802.11n/HT20					
Channel	Frequency (MHz)	6dB Bandwidth (MHz)	99% Occupied Bandwidth (MHz)	Limit (MHz)	Result
Low	2412	17.82	17.718	0.5	PASS
Mid	2437	17.81	17.717	0.5	PASS
High	2462	17.84	17.721	0.5	PASS
IEEE 802.11n/HT40					
Channel	Frequency (MHz)	6dB Bandwidth (MHz)	99% Occupied Bandwidth (MHz)	Limit (MHz)	Result
Low	2422	36.55	36.227	0.5	PASS
Mid	2437	36.54	36.204	0.5	PASS
High	2452	36.59	36.216	0.5	PASS

IEEE 802.11b: **IEEE 802.11g:**



Lowest channel

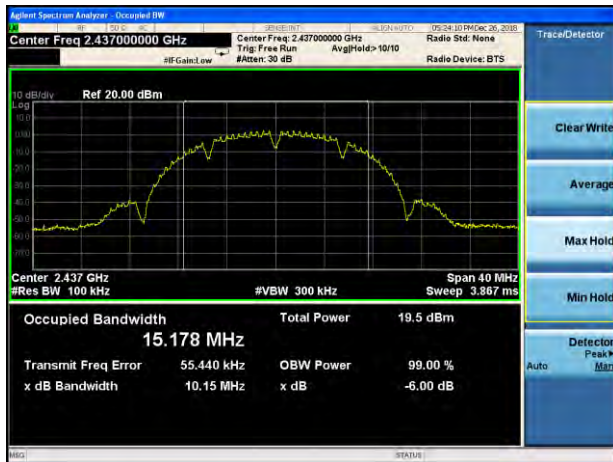

Middle channel



Highest channel

IEEE 802.11n/HT20 **IEEE 802.11n/HT40**

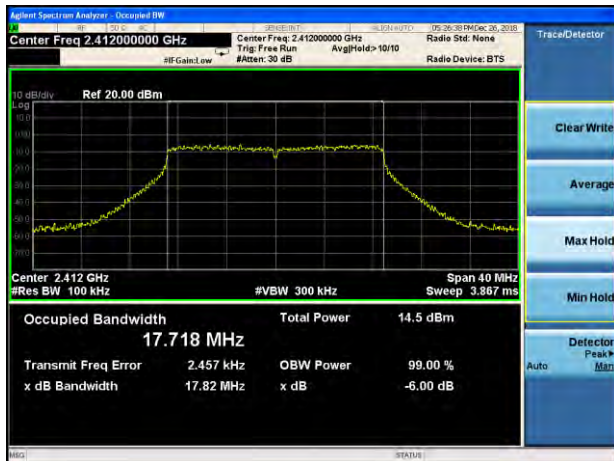

Lowest channel

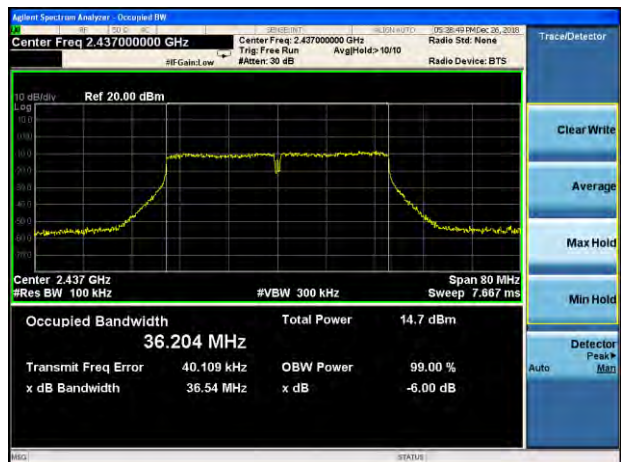

Middle channel



Highest channel

ANT3:

IEEE 802.11b:					
Channel	Frequency (MHz)	6dB Bandwidth (MHz)	99% Occupied Bandwidth (MHz)	Limit (MHz)	Result
Low	2412	10.15	15.170	0.5	PASS
Mid	2437	10.14	15.177	0.5	PASS
High	2462	10.13	15.167	0.5	PASS
IEEE 802.11g					
Channel	Frequency (MHz)	6dB Bandwidth (MHz)	99% Occupied Bandwidth (MHz)	Limit (MHz)	Result
Low	2412	16.60	16.499	0.5	PASS
Mid	2437	16.58	16.517	0.5	PASS
High	2462	16.61	16.534	0.5	PASS
IEEE 802.11n/HT20					
Channel	Frequency (MHz)	6dB Bandwidth (MHz)	99% Occupied Bandwidth (MHz)	Limit (MHz)	Result
Low	2412	17.83	17.711	0.5	PASS
Mid	2437	17.83	17.715	0.5	PASS
High	2462	17.85	17.721	0.5	PASS
IEEE 802.11n/HT40					
Channel	Frequency (MHz)	6dB Bandwidth (MHz)	99% Occupied Bandwidth (MHz)	Limit (MHz)	Result
Low	2422	36.57	36.238	0.5	PASS
Mid	2437	36.54	36.209	0.5	PASS
High	2452	36.54	36.202	0.5	PASS

IEEE 802.11b:	IEEE 802.11g:
---------------	---------------



Lowest channel



Middle channel



Highest channel

IEEE 802.11n/HT20 **IEEE 802.11n/HT40**



Lowest channel



Middle channel

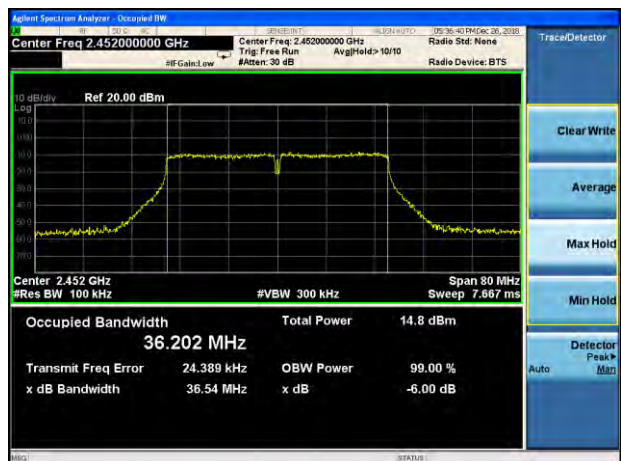

Highest channel

8. BAND EDGE CHECK

8.1. Test limits

Please refer section 15.247

All the lower and upper band-edges emissions appearing within 2310MHz to 2390MHz and 2483.5MHz to 2500MHz restricted frequency bands shall not exceed the limits shown in 15.209, all the other emissions outside operation frequency band 2400MHz to 2483.5MHz and 5725MHz to 5850MHz shall be at least 20dB below the fundamental emissions, or comply with 15.209 limits.

8.2. Test Procedure

Details see the KDB558074 D01 Meas Guidance V05R01

8.2.1 Put the EUT on a 1.5m high table, power on the EUT. Emissions were scanned and measured rotating the EUT to 360 degrees, Find the maximum Emission

8.2.2 Check the spurious emissions out of band.

8.2.3 RBW 1MHz, VBW 3MHz, peak detector for peak value , RBW 1MHz ,VBW 10Hz , RMS detector for AV value.

8.3. Test Setup

Same as 5.2.2.

8.4. Test Results

PASS.

Detailed information please see the following page.

Note: All modes have been tested, and only show the test plots of the ANT1.

Worst case : ANT1

Test Mode: IEEE 802.11b-Low

Polarization: Vertical

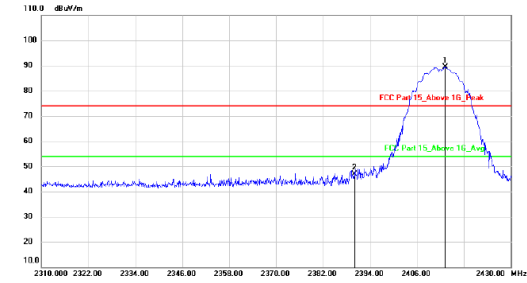

No.	Mk.	Freq.	Reading Level	Correct Factor	Measurement	Limit	Margin	Antenna Height	Table Degree	Comment
		MHz	dBuV	dB	dBuV/m	dBuV/m	dB	cm	degree	
1	*	2413.200	92.67	-3.41	89.26	74.00	15.26			peak
2		2390.000	50.34	-3.40	46.94	74.00	-27.06			peak

Polarization: Horizontal

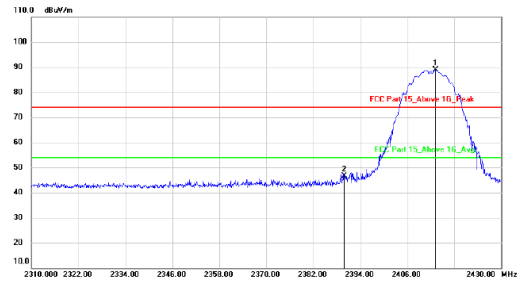

No.	Mk.	Freq.	Reading Level	Correct Factor	Measurement	Limit	Margin	Antenna Height	Table Degree	Comment
		MHz	dBuV	dB	dBuV/m	dBuV/m	dB	cm	degree	
1	*	2413.200	92.32	-3.41	88.91	74.00	14.91			peak
2		2390.000	49.96	-3.40	46.56	74.00	-27.44			peak

Test Mode: IEEE 802.11b-High

Polarization: Vertical

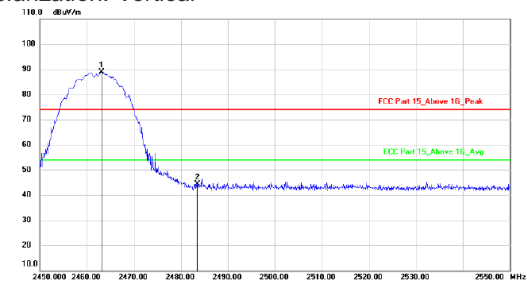

No.	Mk.	Freq.	Reading Level	Correct Factor	Measurement	Limit	Margin	Antenna Height	Table Degree	Comment
		MHz	dBuV	dB	dBuV/m	dBuV/m	dB	cm	degree	
1	*	2463.100	92.16	-3.40	88.76	74.00	14.76			peak
2		2483.500	47.79	-3.38	44.41	74.00	-29.59			peak

Polarization: Horizontal

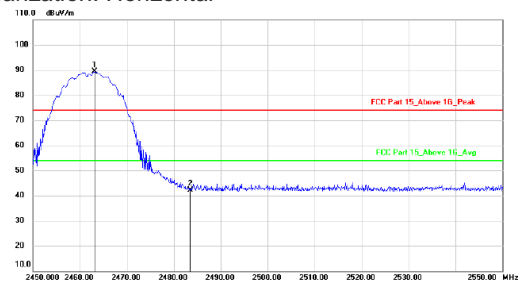

No.	Mk.	Freq.	Reading Level	Correct Factor	Measurement	Limit	Margin	Antenna Height	Table Degree	Comment
		MHz	dBuV	dB	dBuV/m	dBuV/m	dB	cm	degree	
1	*	2463.100	92.67	-3.40	89.27	74.00	15.27			peak
2		2483.500	45.43	-3.38	42.05	74.00	-31.95			peak

Worst case : ANT1

Test Mode: IEEE 802.11g-Low

Polarization: Vertical

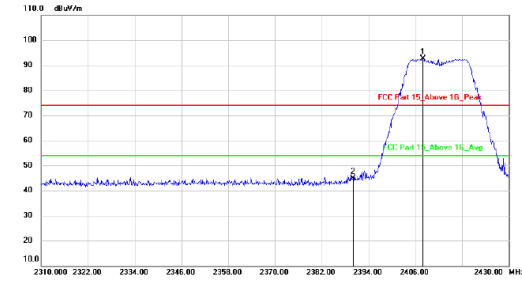

No. Mk.	Freq. MHz	Reading Level dBuV	Correct Factor dB	Measurement dBuV/m	Limit dBuV/m	Margin dB	Antenna Height cm	Table Degree	Comment
1 *	2407.920	96.14	-3.40	92.74	74.00	18.74			peak
2	2390.000	48.27	-3.40	44.87	74.00	-29.13			peak

Polarization: Horizontal

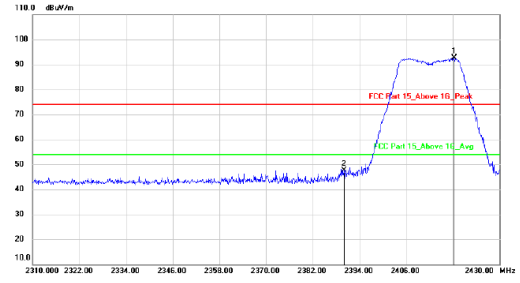

No. Mk.	Freq. MHz	Reading Level dBuV	Correct Factor dB	Measurement dBuV/m	Limit dBuV/m	Margin dB	Antenna Height cm	Table Degree	Comment
1 *	2418.360	95.98	-3.41	92.57	74.00	18.57			peak
2	2390.000	50.98	-3.40	47.58	74.00	-26.42			peak

Test Mode: IEEE 802.11g-High

Polarization: Vertical

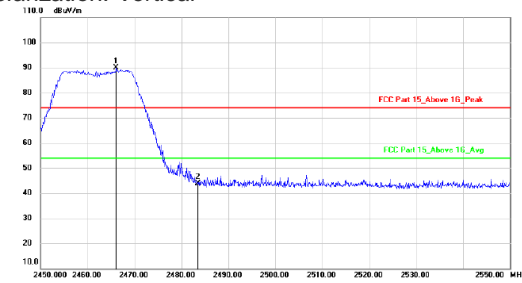

No. Mk.	Freq. MHz	Reading Level dBuV	Correct Factor dB	Measurement dBuV/m	Limit dBuV/m	Margin dB	Antenna Height cm	Table Degree	Comment
1 *	2466.100	93.27	-3.39	89.88	74.00	15.88			peak
2	2483.500	47.24	-3.38	43.86	74.00	-30.14			peak

Polarization: Horizontal

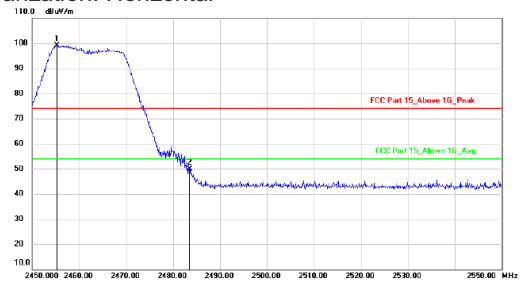

No. Mk.	Freq. MHz	Reading Level dBuV	Correct Factor dB	Measurement dBuV/m	Limit dBuV/m	Margin dB	Antenna Height cm	Table Degree	Comment
1 *	2455.300	102.53	-3.39	99.14	74.00	25.14			peak
2	2483.500	53.19	-3.38	49.81	74.00	-24.19			peak

Test Mode: IEEE 802.11n(HT20)-Low
Polarization: Vertical

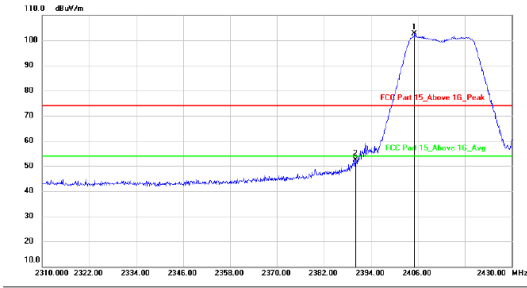

No. Mk.	Freq. MHz	Reading Level dBu/V	Correct Factor dB	Measurement dBu/m	Limit dBu/m	Margin dB	Antenna Height cm	Table Degree	Comment
1 *	2405.160	105.98	-3.41	102.57	74.00	28.57			peak
2	2390.000	55.90	-3.40	52.50	74.00	-21.50			peak

Polarization: Horizontal

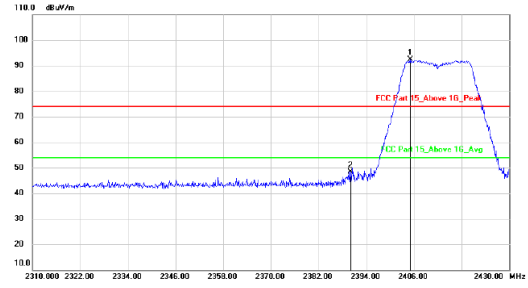

No. Mk.	Freq. MHz	Reading Level dBu/V	Correct Factor dB	Measurement dBu/m	Limit dBu/m	Margin dB	Antenna Height cm	Table Degree	Comment
1 *	2405.040	95.67	-3.41	92.26	74.00	18.26			peak
2	2390.000	51.86	-3.40	48.46	74.00	-25.54			peak

Test Mode: IEEE 802.11n(HT20)-High
Polarization: Vertical

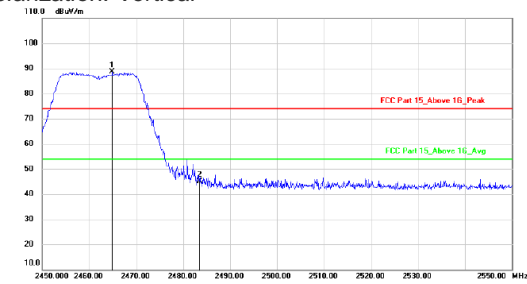

No. Mk.	Freq. MHz	Reading Level dBu/V	Correct Factor dB	Measurement dBu/m	Limit dBu/m	Margin dB	Antenna Height cm	Table Degree	Comment
1 *	2464.900	91.97	-3.39	88.58	74.00	14.58			peak
2	2483.500	48.49	-3.38	45.11	74.00	-28.89			peak

Polarization: Horizontal

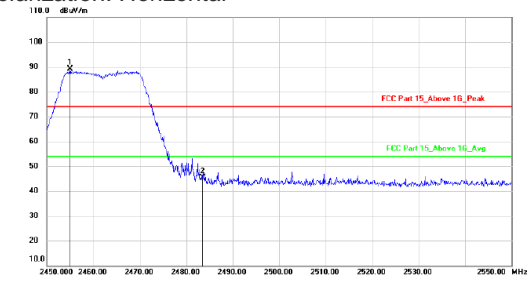

No. Mk.	Freq. MHz	Reading Level dBu/V	Correct Factor dB	Measurement dBu/m	Limit dBu/m	Margin dB	Antenna Height cm	Table Degree	Comment
1 *	2455.000	92.42	-3.39	89.03	74.00	15.03			peak
2	2483.500	48.75	-3.38	45.37	74.00	-28.63			peak

Worst case : ANT1

Test Mode: IEEE 802.11n(HT40)-Low

Polarization: Vertical

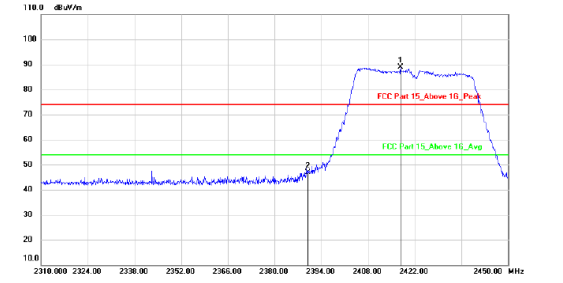

No. Mk.	Freq. MHz	Reading Level dBuV	Correct Factor dB	Measurement dBuV/m	Limit dBuV/m	Margin dB	Antenna Height cm	Table Degree	Comment
1 *	2417.800	92.33	-3.41	88.92	74.00	14.92			peak
2	2390.000	50.27	-3.40	46.87	74.00	-27.13			peak

Polarization: Horizontal

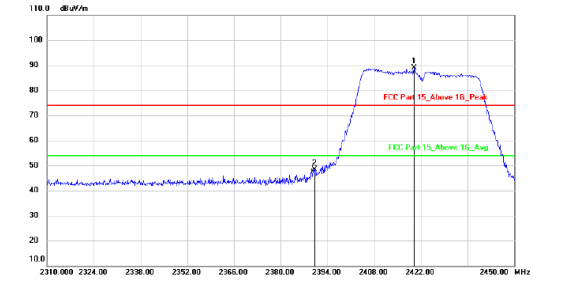

No. Mk.	Freq. MHz	Reading Level dBuV	Correct Factor dB	Measurement dBuV/m	Limit dBuV/m	Margin dB	Antenna Height cm	Table Degree	Comment
1 *	2420.040	92.22	-3.41	88.81	74.00	14.81			peak
2	2390.000	51.85	-3.40	48.45	74.00	-25.55			peak

Test Mode: IEEE 802.11n(HT40)-High

Polarization: Vertical

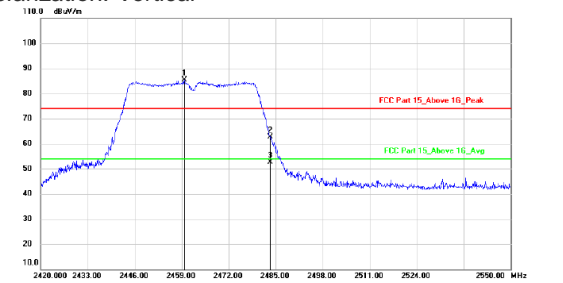

No. Mk.	Freq. MHz	Reading Level dBuV	Correct Factor dB	Measurement dBuV/m	Limit dBuV/m	Margin dB	Antenna Height cm	Table Degree	Comment
1 *	2459.780	88.68	-3.39	85.29	74.00	11.29			peak
2	2483.500	65.97	-3.38	62.59	74.00	-11.41			peak
3	2483.500	56.01	-3.38	52.63	54.00	-1.37			AVG

Polarization: Horizontal

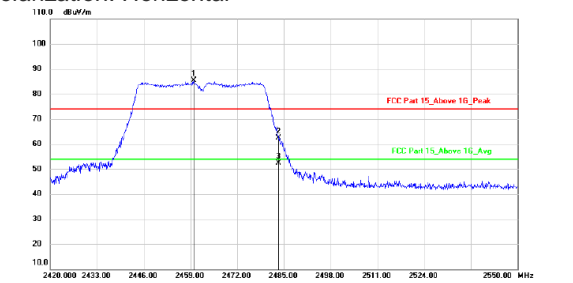

No. Mk.	Freq. MHz	Reading Level dBuV	Correct Factor dB	Measurement dBuV/m	Limit dBuV/m	Margin dB	Antenna Height cm	Table Degree	Comment
1 *	2459.910	88.83	-3.39	85.44	74.00	11.44			peak
2	2483.500	65.84	-3.38	62.46	74.00	-11.54			peak
3	2483.500	55.88	-3.38	52.50	54.00	-1.50			AVG

Note: 1. *:Maximum data; x:Over limit; !:over margin.

2.Measurement=Reading Level+Correct Factor; Correct Factor=Antenna Factor+Cable Loss.

ANT1:

Test mode: 802.11b

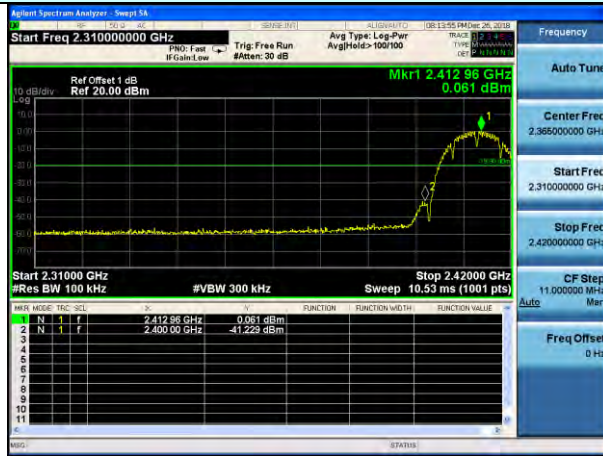

Lowest channel

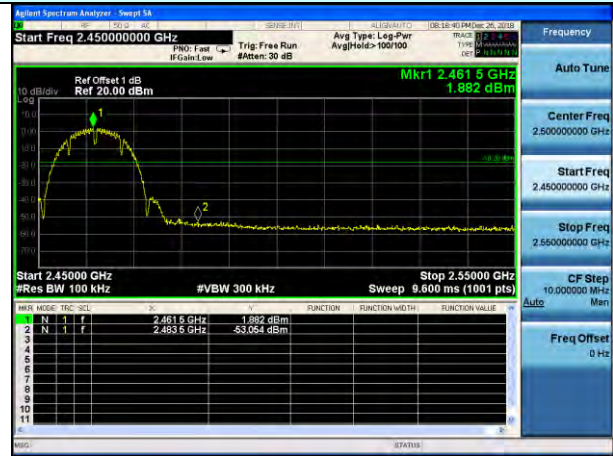

Highest channel

Test mode: 802.11g

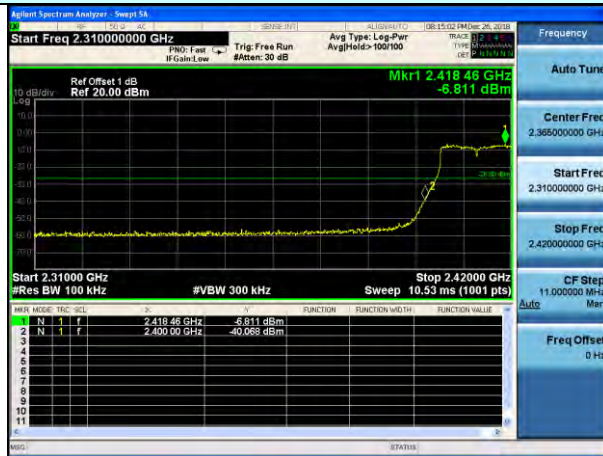

Lowest channel

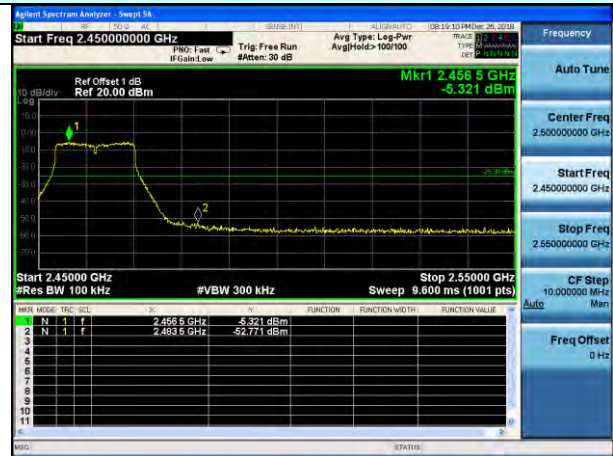

Highest channel

Test mode: 802.11n(HT20)

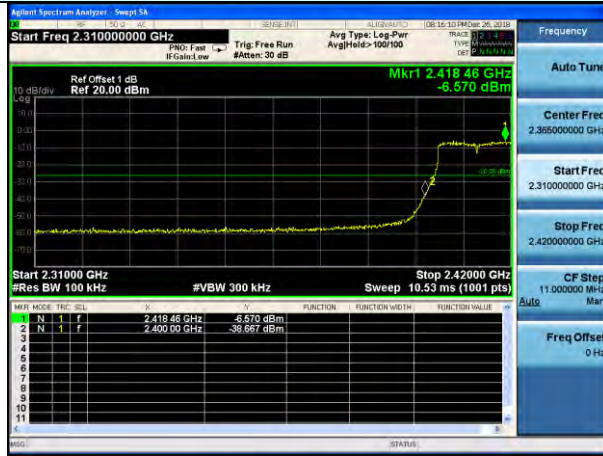

Lowest channel

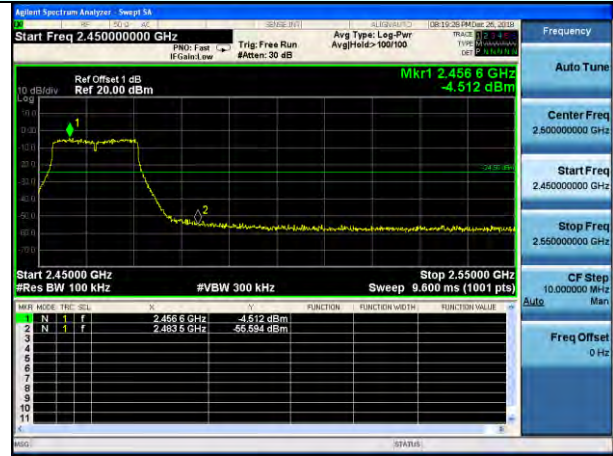

Highest channel

Test mode: 802.11n(HT40)



Lowest channel



Highest channel

ANT2:

Test mode: 802.11b

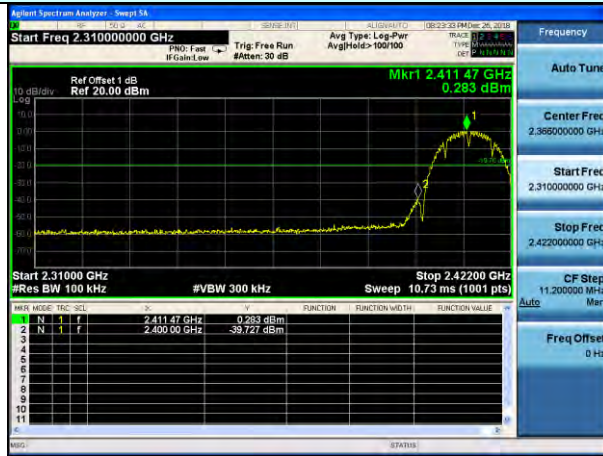

Lowest channel



Highest channel

Test mode: 802.11g

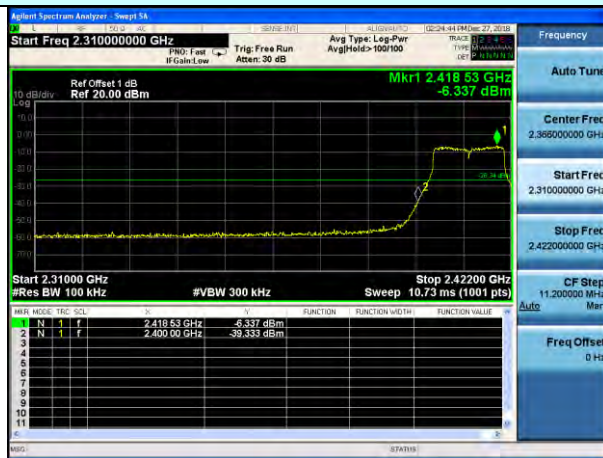

Lowest channel

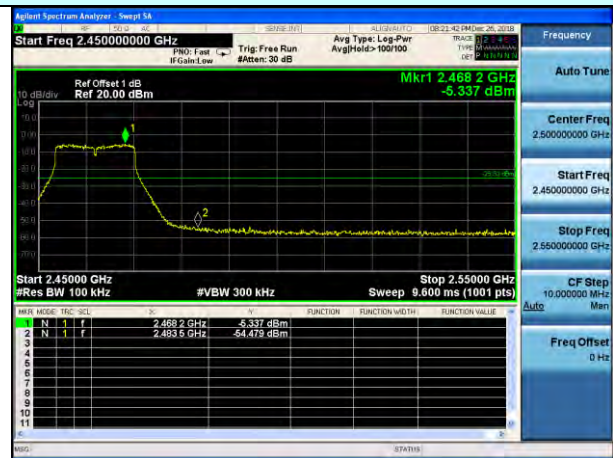

Highest channel

Test mode: 802.11n(HT20)

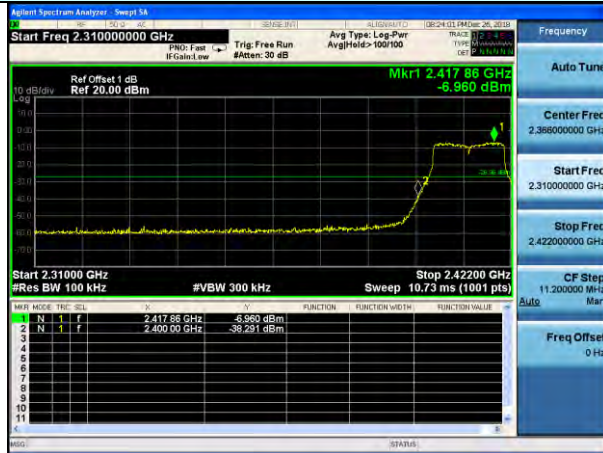

Lowest channel

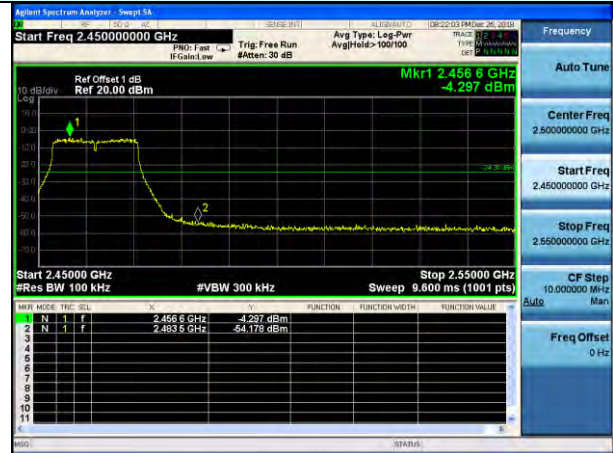

Highest channel

Test mode: 802.11n(HT40)

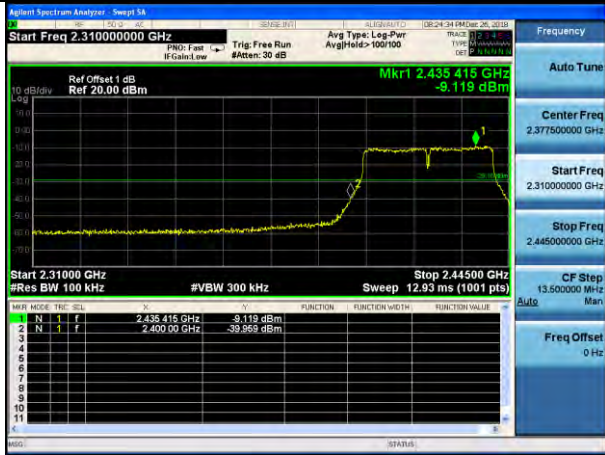

Lowest channel



Highest channel

ANT3:

Test mode: 802.11b

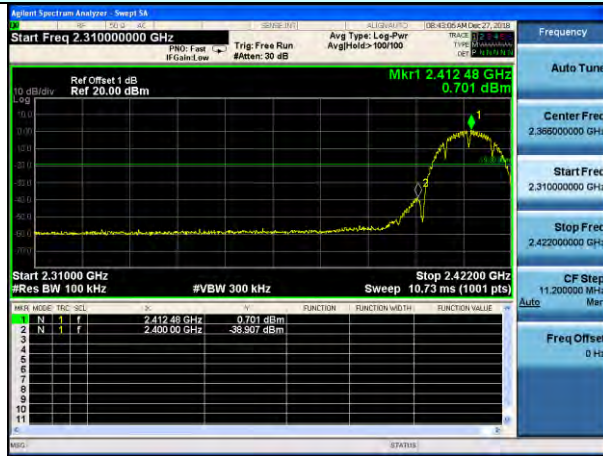

Lowest channel



Highest channel

Test mode: 802.11g

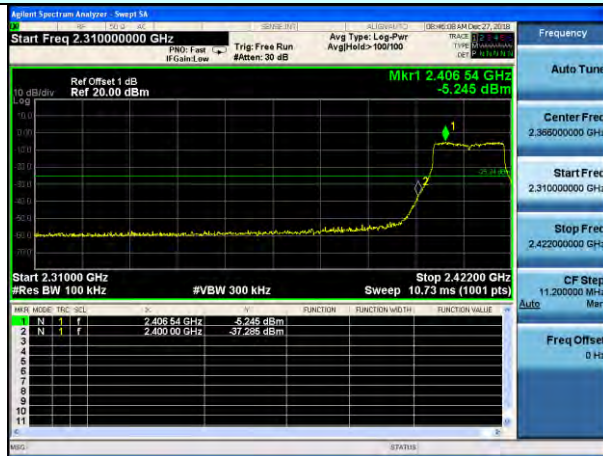

Lowest channel

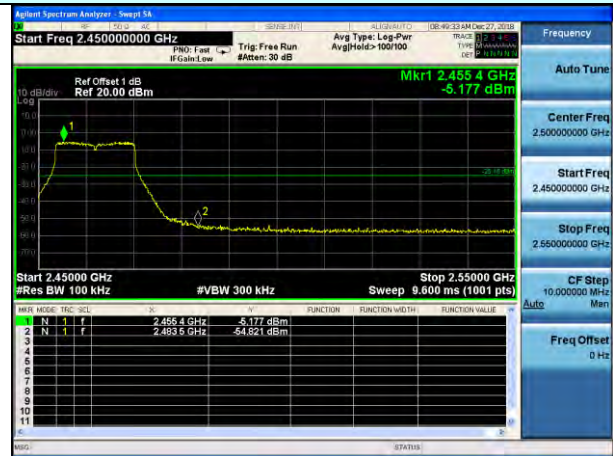

Highest channel

Test mode: 802.11n(HT20)



Lowest channel



Highest channel

Test mode: 802.11n(HT40)

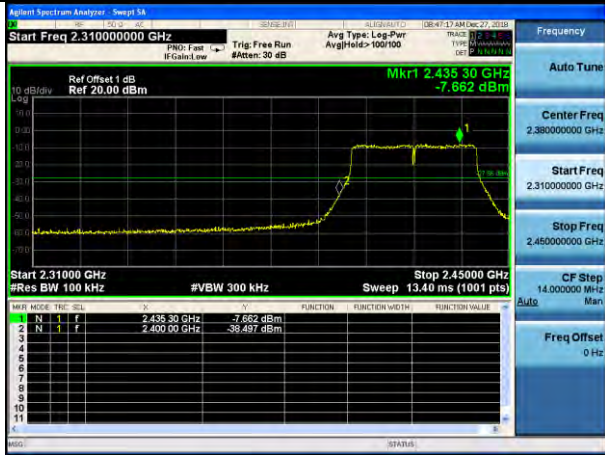

Lowest channel



Highest channel

9. ANTENNA REQUIREMENT

9.1. Standard Requirement

An intentional radiator shall be designed to ensure that no antenna other than that furnished by the responsible party shall be used with the device. The use of a permanently attached antenna or of an antenna that uses a unique coupling to the intentional radiator shall be considered sufficient to comply with the provisions of this Section. The manufacturer may design the unit so that a broken antenna can be replaced by the user, but the use of a standard antenna jack or electrical connector is prohibited.

9.2. Antenna Connected Construction

The antenna used for transmitting is permanently attached and no consideration of replacement. Please see EUT photo for details.

9.3. Results

The 2.4G Wifi have one PCB antennas & one external antenna. It complies with the standard requirement.

Antenna Connector Impedance: 50Ω

10. TEST SETUP PHOTO

10.1. Photos of Radiated emission

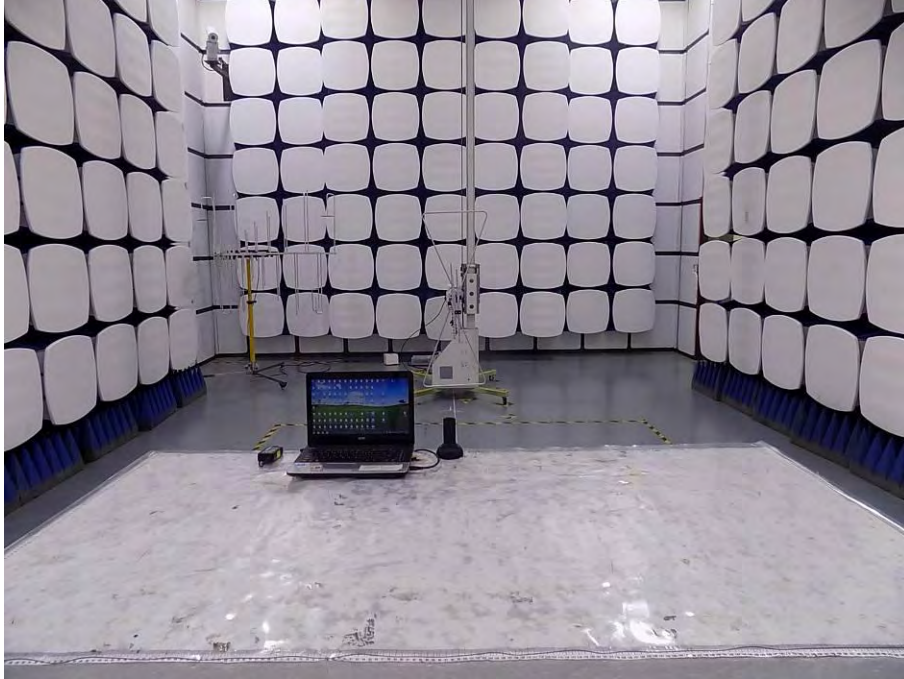

10.2.Photos of Conducted Emission test



11. TEST SETUP PHOTO







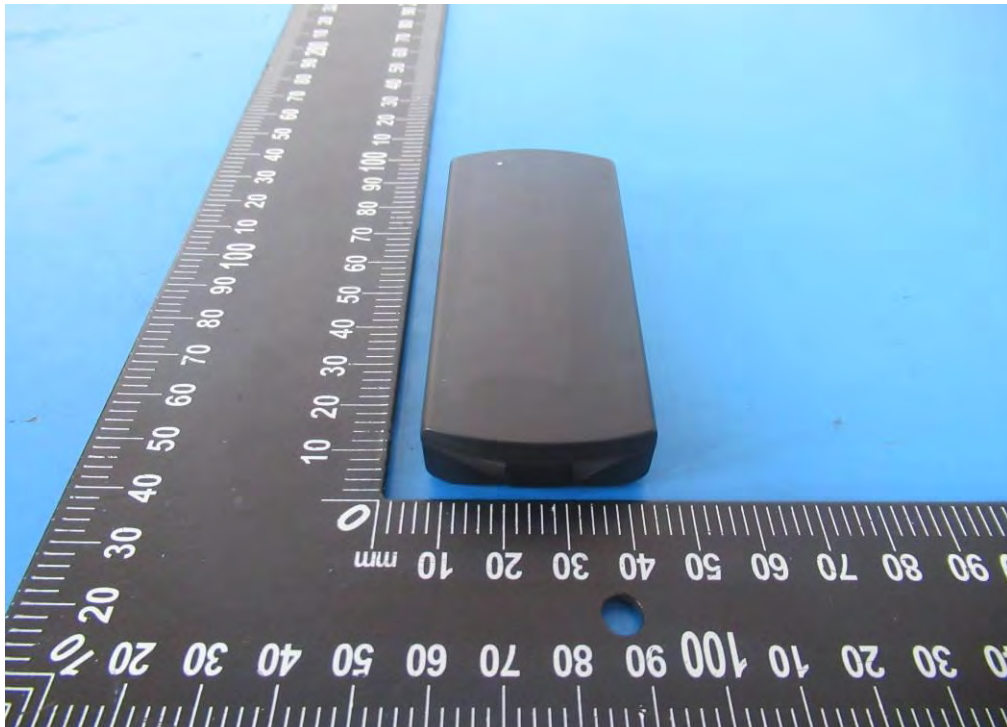

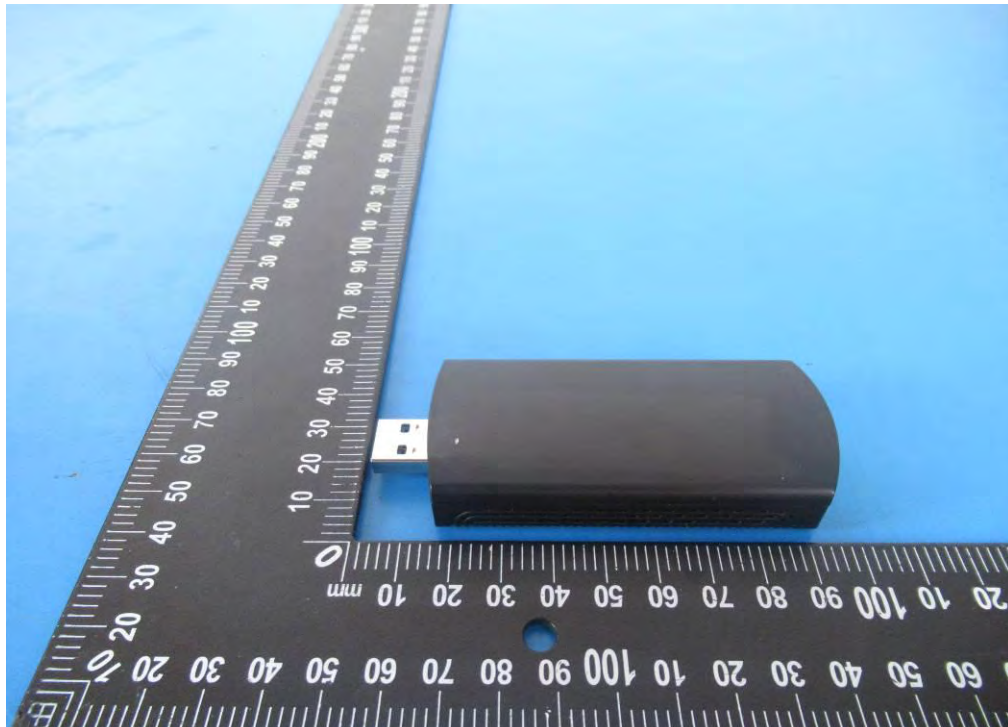
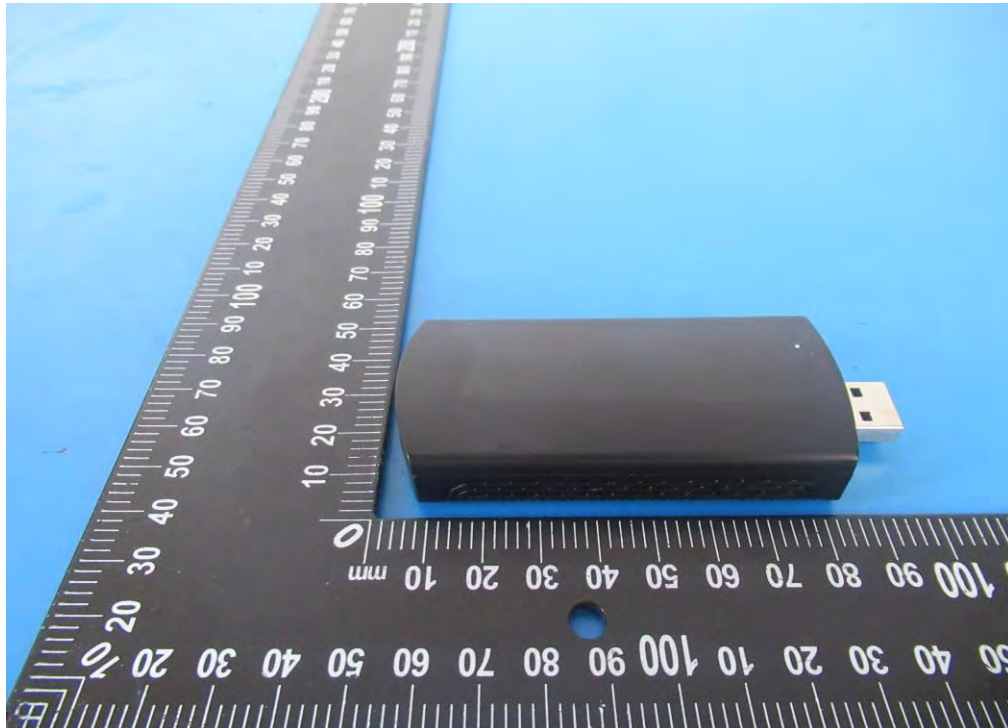

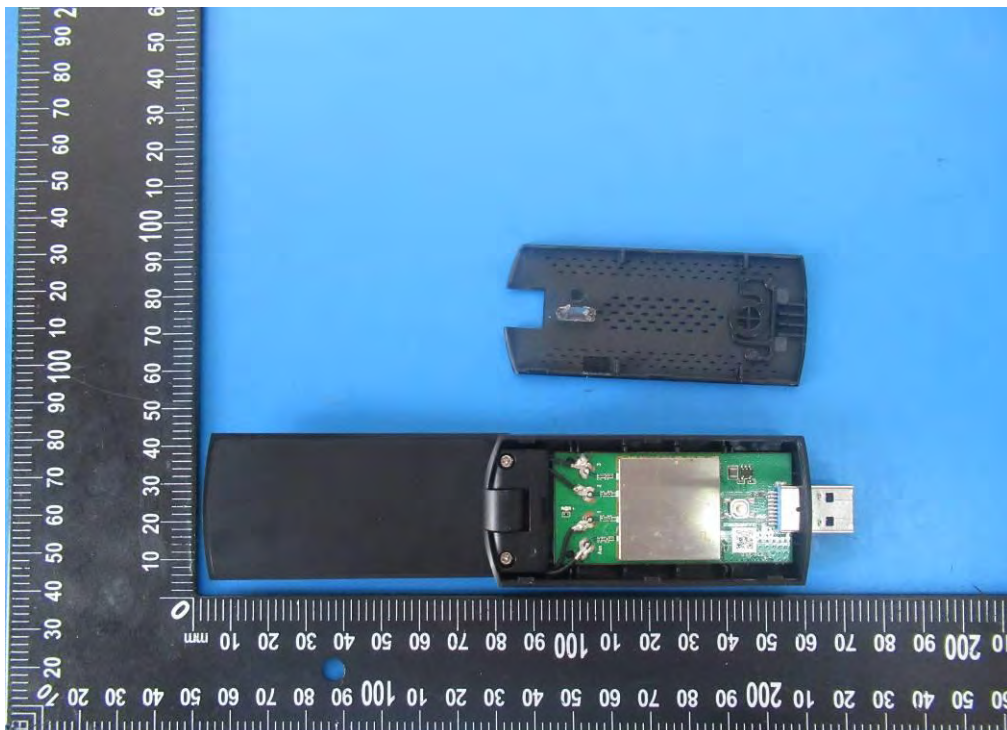

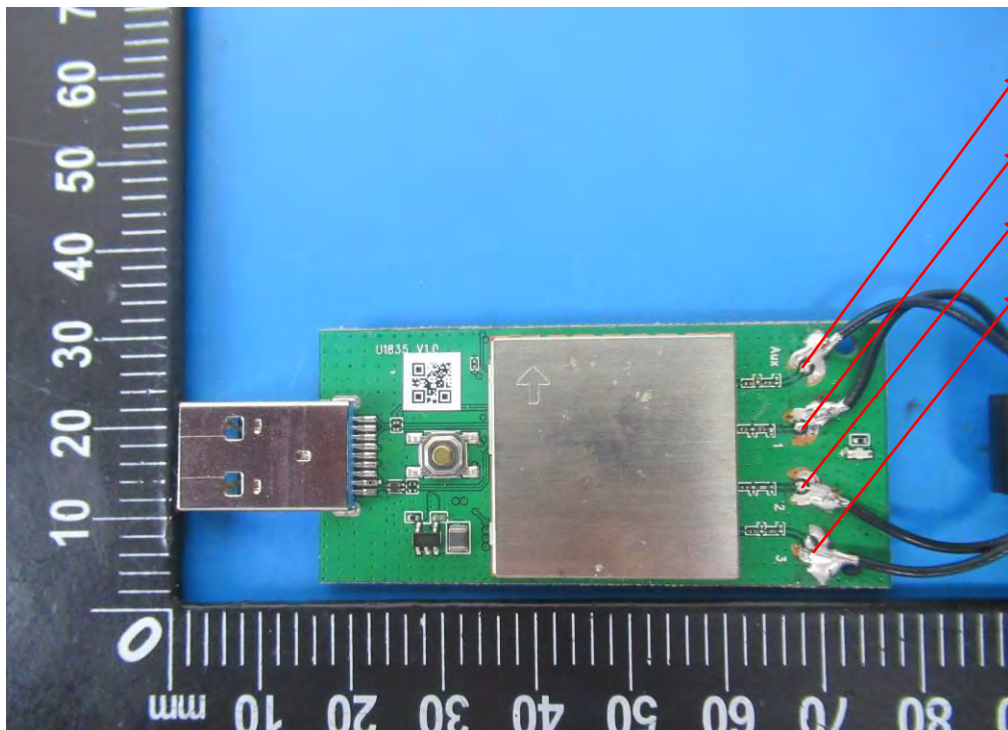
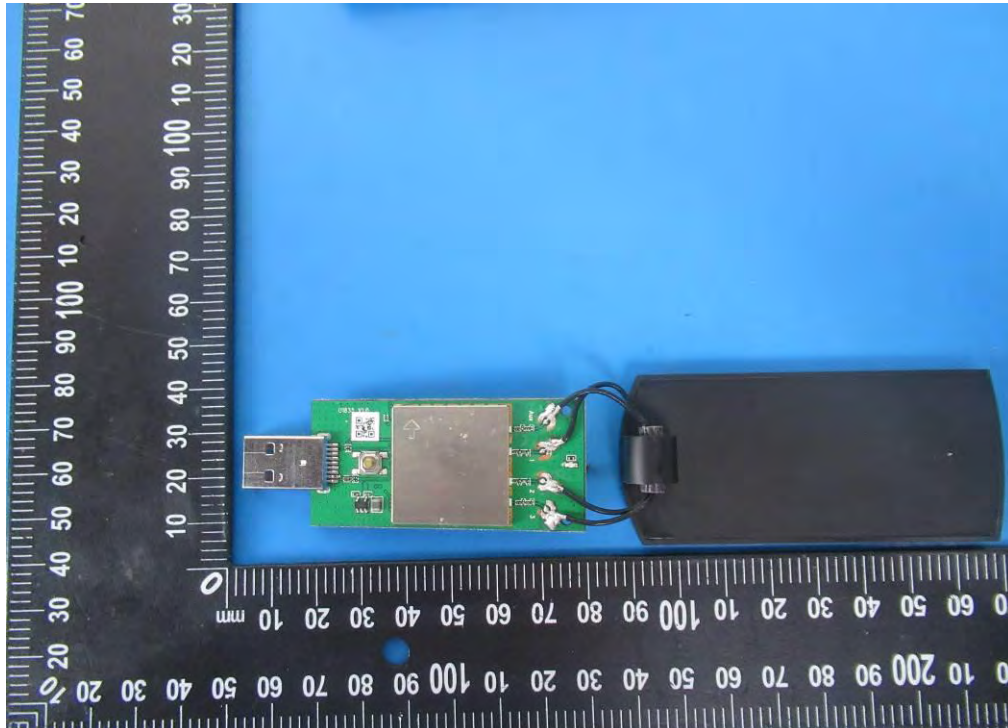

- ANT AUX
- ANT1
- ANT2
- ANT3

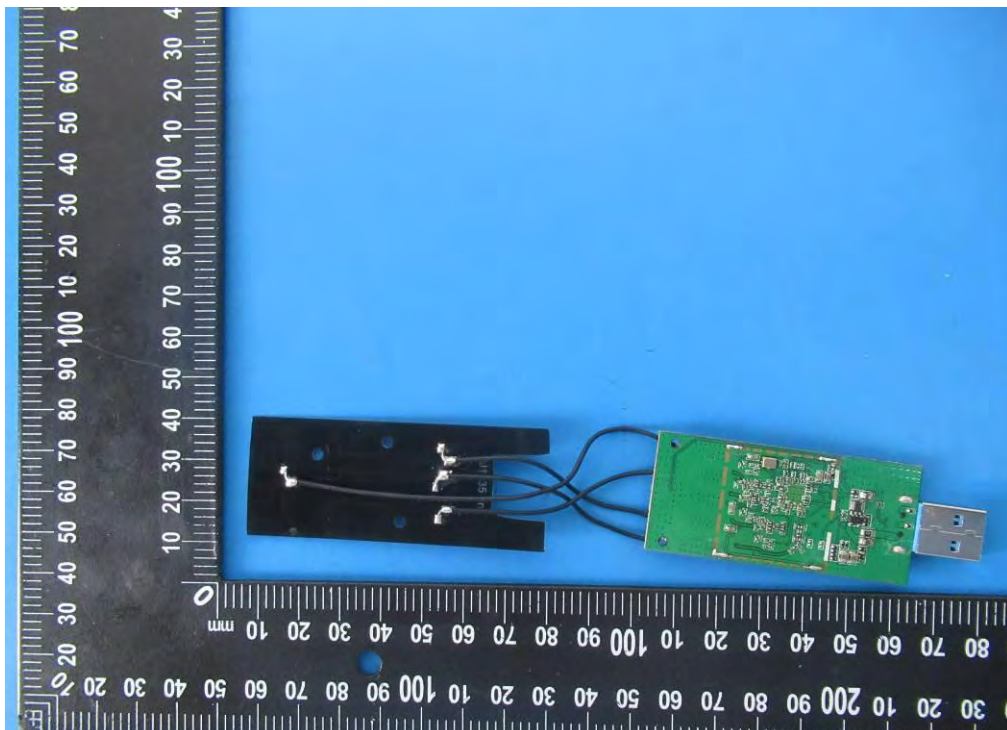
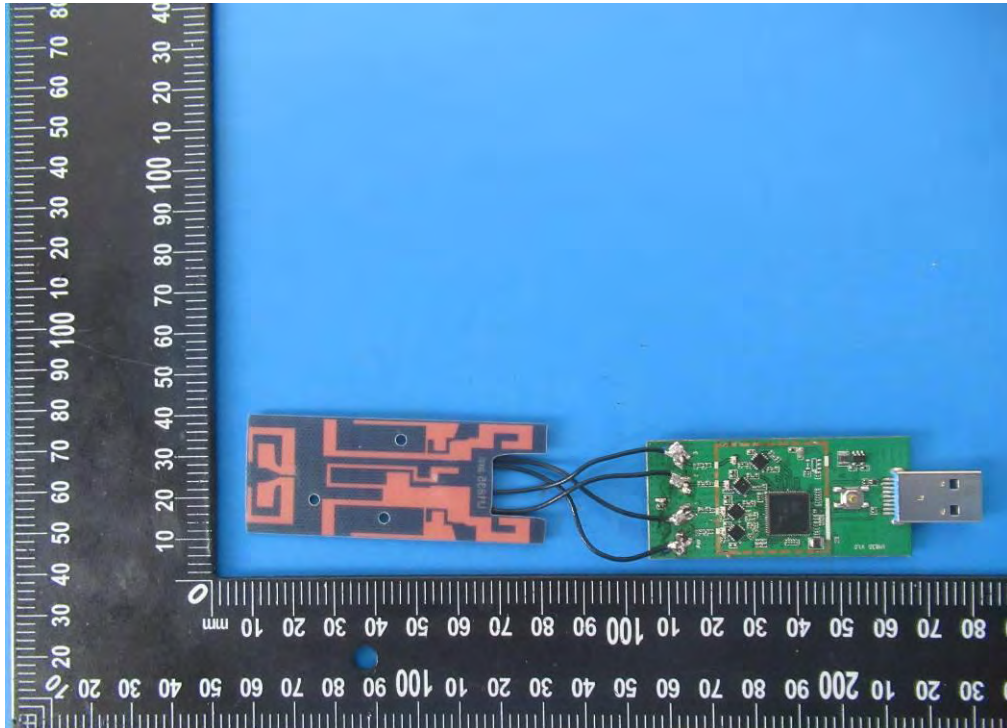

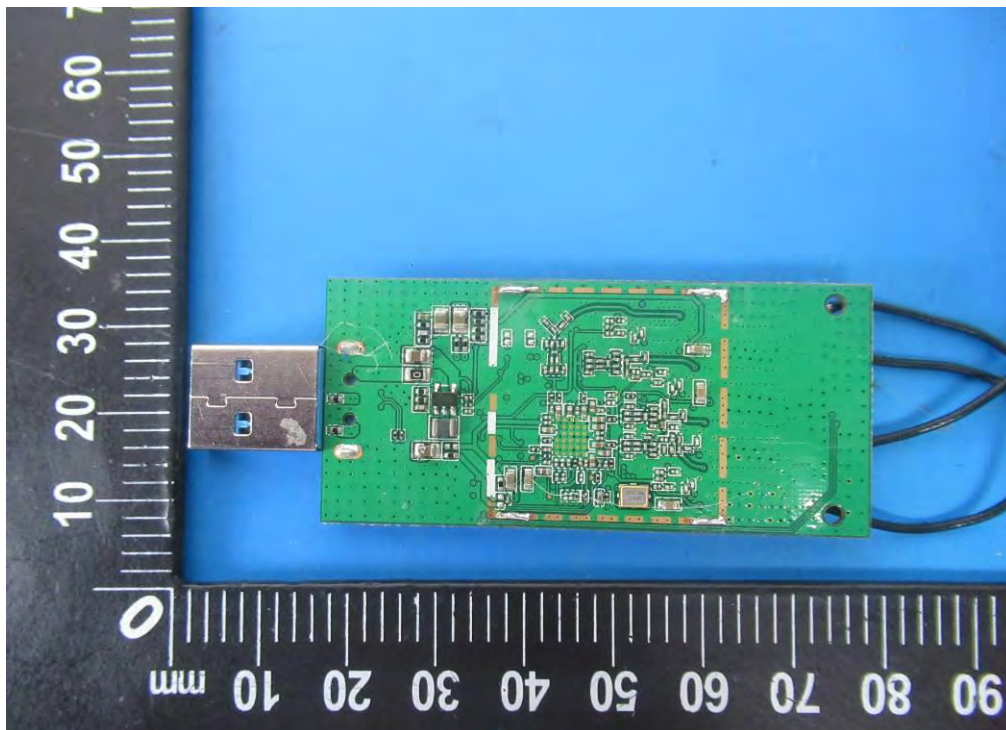
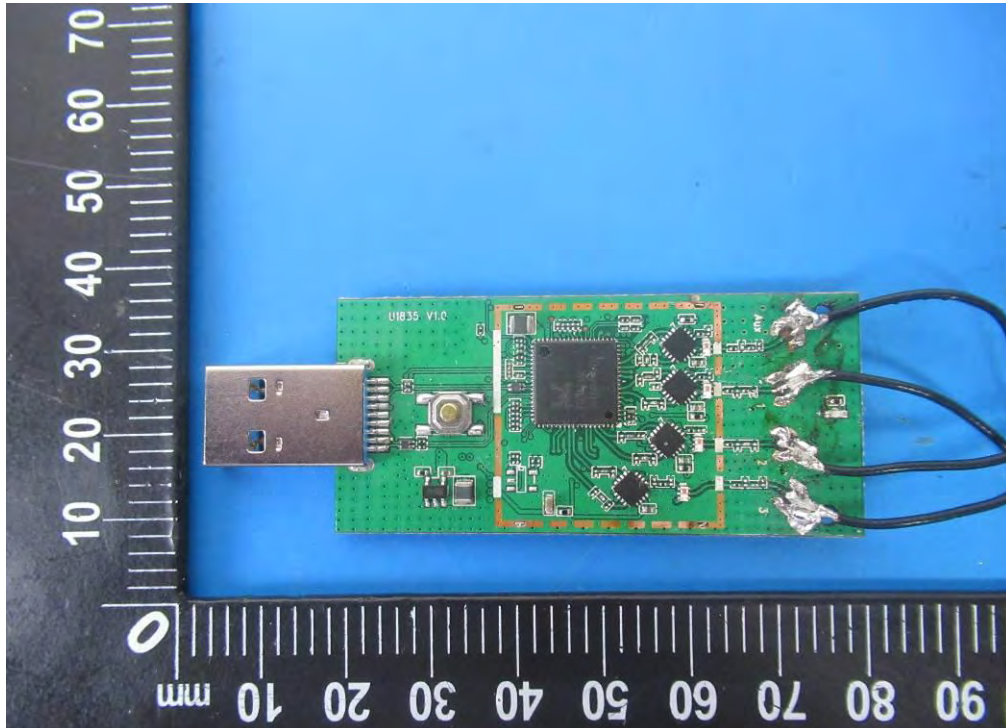

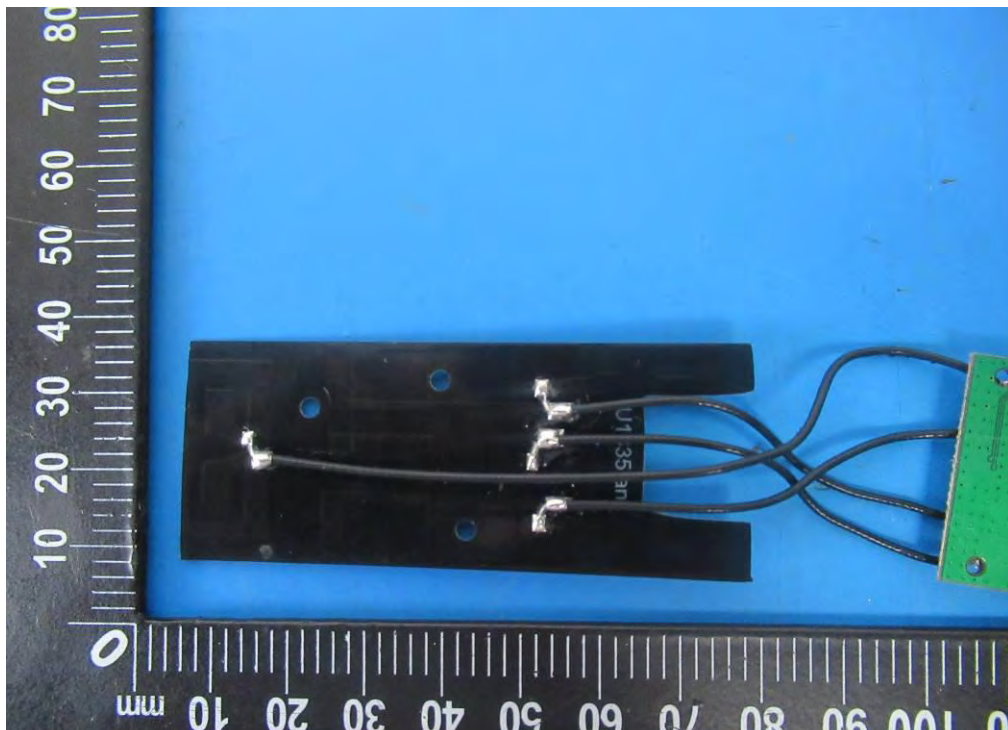
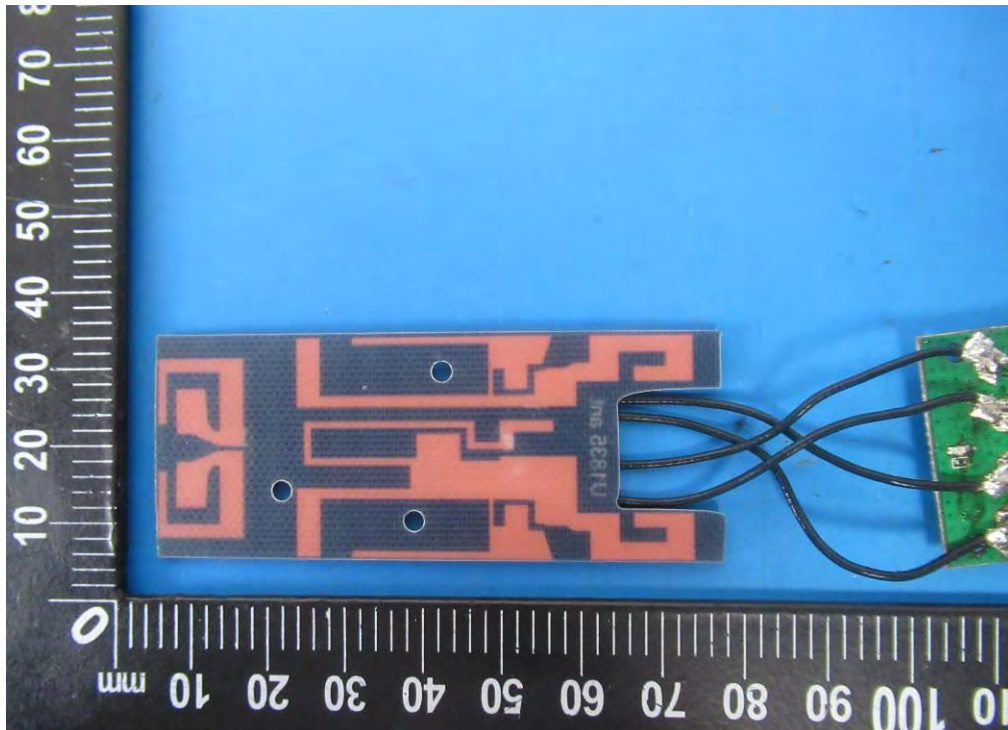

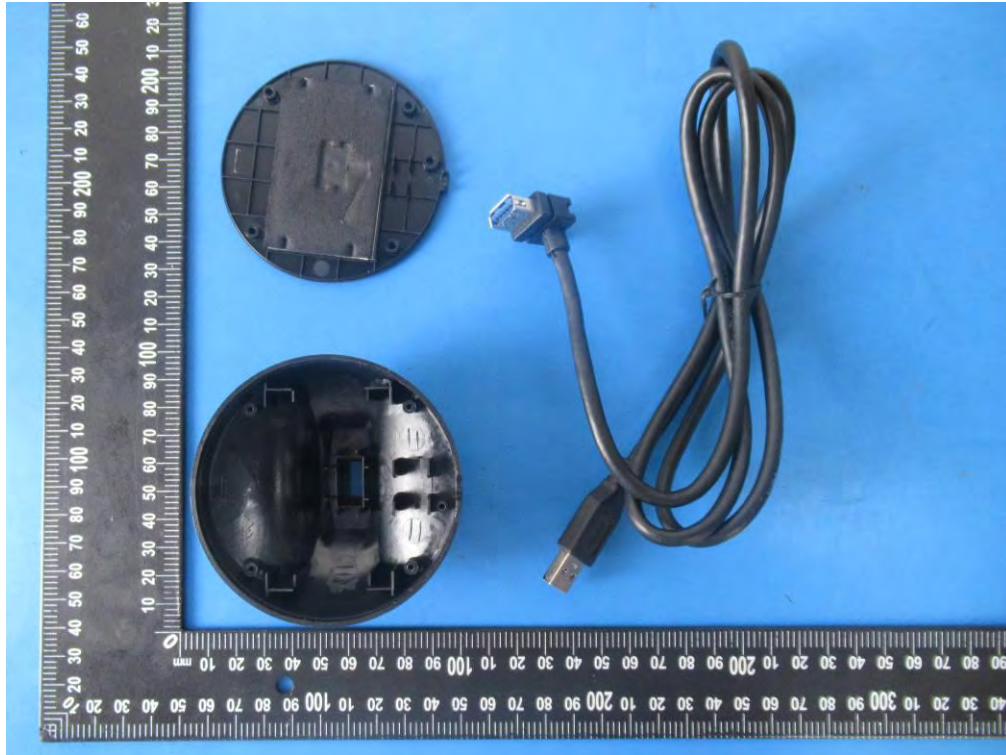

-----THE END OF REPORT-----