



# TEST REPORT

**FCC ID: 2AAD8-U0631**

**Applicant** : HAOLIYUAN(SHENZHEN) ELECTRONIC CO.,LTD  
**Address** : 3/F,Building A1, Junfeng Industrial Park, Yonghe Road, Fuyong, Bao' an District, Shenzhen, Guangdong, China

**Equipment under Test (EUT):**

**Name** : Mini 802.11ac Wireless USB Adapter  
**Model** : U0631

**Standards** : FCC PART 15, SUBPART C : 2015 (Section 15.247)  
RSS-247 ISSUE 1 MAY 2015  
ANSI C63.4:2014 ; ANSI C63.10:2013

**Report No.** : T1862098 01  
**Date of Test** : October 21, 2016 - November 02, 2016  
**Date of Issue** : November 02, 2016

<b>Test Result :</b>	<b>PASS *</b>
----------------------	---------------

\* In the configuration tested, the EUT complied with the standards specified above

Authorized Signature

(Mark Zhu)  
General Manager

The manufacture should ensure that all the products in series production are in conformity with the product sample detailed in this report. If the product in this report is used in any configuration other than that detailed in the report, the manufacturer must ensure the new system complies with all relevant standards. Any mention of Shenzhen Alpha Product Testing Co., Ltd. Or test done by Shenzhen Alpha Product Testing Co., Ltd. Approvals in connection with, distribution or use of the product described in this report must be approved by Shenzhen Alpha Product Testing Co., Ltd. Approvals in writing.

## TABLE OF CONTENT

Description	Page
<b>1 General Information -----</b>	<b>5</b>
1.1 Description of Device (EUT) -----	5
1.2 Description of Test Facility -----	6
<b>2 EMC Equipment List -----</b>	<b>6</b>
<b>3 Test Procedure-----</b>	<b>7</b>
<b>4 Summary of Measurement-----</b>	<b>8</b>
4.1 Summary of test result-----	8
4.2 Test connection -----	8
4.3 Assistant equipment used for test-----	9
4.4 Test mode -----	9
4.5 Channel list -----	9
4.6 Test Conditions -----	10
4.7 Measurement Uncertainty (95% confidence levels, k=2)-----	10
<b>5 Spurious Emission-----</b>	<b>11</b>
5.1 Radiation Emission -----	11
5.1.1 Radiation Emission Limits(15.209) -----	11
5.1.2 Test Setup -----	11
5.1.3 Test Procedure-----	13
5.1.4 Test Equipment Setting For emission test Result-----	14
5.1.5 Test Condition -----	14
5.1.6 Test Result -----	14
<b>6 POWER LINE CONDUCTED EMISSION-----</b>	<b>29</b>
6.1 Conducted Emission Limits(15.207)-----	29
6.2 Test Setup -----	29
6.3 Test Procedure-----	30
6.4 Test Results -----	30
<b>7 Conducted Maximum Output Power -----</b>	<b>33</b>
7.1 Test limit -----	33
7.2 Test Procedure-----	33
7.3 Test Setup -----	33
7.4 Test Results -----	33
<b>8 PEAK POWER SPECTRAL DENSITY-----</b>	<b>35</b>
8.1 Test limit -----	35
8.2 Method of measurement -----	35
8.3 Test Setup -----	35
8.4 Test Results -----	36
<b>9 Bandwidth -----</b>	<b>44</b>
9.1 Test limit -----	44
9.2 Method of measurement -----	44
9.3 Test Setup -----	44
9.4 Test Results -----	44

---

<b>10</b>	<b>Band Edge Check</b>	<b>52</b>
10.1	Test limit	52
10.2	Test Procedure	52
10.3	Test Setup	52
10.4	Test Result	52
<b>11</b>	<b>Antenna Requirement</b>	<b>65</b>
11.1	Standard Requirement	65
11.2	Antenna Connected Construction	65
11.3	Result	65
<b>12</b>	<b>Test setup photo</b>	<b>66</b>
12.1	Photos of Radiated emission	66
12.2	Photos of Conducted Emission test	67
<b>13</b>	<b>Photographs of EUT</b>	<b>68</b>

### TEST REPORT VERIFICATION

Applicant : HAOLIYUAN(SHENZHEN) ELECTRONIC CO.,LTD  
 Manufacturer : HAOLIYUAN(SHENZHEN) ELECTRONIC CO.,LTD  
 EUT Description : Mini 802.11ac Wireless USB Adapter  
 (A) Model No. : U0631  
 (B) Trademark : N/A  
 (C) Ratings Supply : DC 5V from USB Port  
 (D)Test Voltage : DC 5V from USB Port



Measurement Standard Used:

FCC Rules and Regulations Part 15 Subpart C 2015, ANSI C63.10-2013

The device described above is tested by Shenzhen Alpha Product Testing Co., Ltd. to determine the maximum emission levels emanating from the device. The maximum emission levels are compared to the FCC Part 15 Subpart C limits both conducted and radiated emissions. The test results are contained in this test report and Shenzhen Alpha Product Testing Co., Ltd. is assumed of full responsibility for the accuracy and completeness of these tests.

After the test, our opinion is that EUT compliance with the requirement of the above standards.

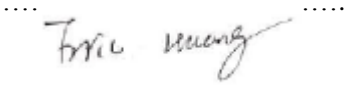
This report applies to above tested sample only. This report shall not be reproduced in parts without written approval of Shenzhen Alpha Product Testing Co., Ltd.

Tested by (name + signature).....:	Eric Huang Test Engineer	.....  .....
Approved by (name + signature).....:	Simple Guan Project Manager	.....  .....
Date of issue.....	November 02, 2016	

# 1 General Information

## 1.1 Description of Device (EUT)

Trade Name : N/A

EUT : Mini 802.11ac Wireless USB Adapter

Model No. : U0631

DIFF. : N/A

Antenna Type : Integrated antenna :2.81 dBi

Operation : IEEE 802.11b/g: 2412MHz-2462MHz  
Frequency : IEEE 802.11n HT20: 2412MHz-2462MHz  
IEEE 802.11n HT40: 2422MHz-2452MHz  
IEEE 802.11b/g:11Channels

Channel number : IEEE 802.11n HT20: 11 Channels  
IEEE 802.11n HT40: 7 Channels  
IEEE 802.11b: DSSS(CCK,DQPSK,DBPSK)

Modulation type : IEEE 802.11g: OFDM(64QAM, 16QAM, QPSK, BPSK)  
IEEE 802.11n :OFDM(64QAM, 16QAM, QPSK, BPSK)

Power Supply : DC 5V from USB Port

Applicant : HAOLIYUAN(SHENZHEN) ELECTRONIC CO.,LTD

Address : 3/F,Building A1, Junfeng Industrial Park, Yonghe Road, Fuyong, Bao' an District, Shenzhen, Guangdong, China

Manufacturer : HAOLIYUAN(SHENZHEN) ELECTRONIC CO.,LTD

Address : 3/F,Building A1, Junfeng Industrial Park, Yonghe Road, Fuyong, Bao' an District, Shenzhen, Guangdong, China

## 1.2 Description of Test Facility

Shenzhen Alpha Product Testing Co., Ltd  
 Building B, East Area of Nanchang Second, Industrial Zone, Gushu 2nd Road,  
 Bao'an, Shenzhen, China

August 11, 2014 File on Federal Communication Commission  
 Registration Number: 203110

July 18, 2014 Certificated by IC  
 Registration Number: 12135A

## 2 EMC Equipment List

Equipment	Manufacture	Model No.	Serial No.	Last cal. Due to	Cal Interval
3m Semi-Anechoic	CHENYU	N/A	N/A	2018.01.18	2Year
Spectrum analyzer	Agilent	E4407B	MY46185649	2017.01.16	1Year
Receiver	R&S	ESPI	101873	2017.01.16	1Year
Receiver	R&S	ESCI	101165	2017.01.16	1Year
Bilog Antenna	SCHWARZBECK	VULB 9168	VULB9168-438	2018.01.18	2Year
Horn Antenna	SCHWARZBECK	BBHA 9120 D	BBHA 9120 D(1201)	2017.01.20	2Year
Cable	Resenberger	N/A	No.1	2017.01.16	1Year
Cable	SCHWARZBECK	N/A	No.2	2017.01.16	1Year
Cable	SCHWARZBECK	N/A	No.3	2017.01.16	1Year
Pre-amplifier	HP	HP8347A	2834A00455	2017.01.18	1Year
Pre-amplifier	Agilent	8449B	3008A02664	2017.01.18	1Year
vector Signal Generator	Agilent	N5182A	MY49060042	2016.11.16	1 Year
vector Signal Generator	Agilent	E4438C	US44271917	2016.11.16	1 Year
X-series USB Peak and Average Power Sensor	Agilent	U2021XA	MY54080020	2016.11.16	1 Year

X-series USB Peak and Average Power Sensor	Agilent	U2021XA	MY54110001	2016.11.16	1 Year
Signal Analyzer	Agilent	N9020A	MY48030494	2016.11.16	1 Year
L.I.S.N.#1	Schwarzbeck	NSLK8126	8126466	2017.01.16	1 Year
L.I.S.N.#2	ROHDE&SCHWARZ	ENV216	101043	2017.01.16	1 Year

### 3 Test Procedure

**POWER LINE CONDUCTED INTERFERENCE:** The test procedure used was ANSI Standard ANSI C63.4:2014 using a 50 u H LISN. Both Lines were observed. The bandwidth of the receiver was 10kHz with an appropriate sweep speed. The ambient temperature of the EUT was 25°C with a humidity of 58%.

**RADIATION INTERFERENCE:** The test procedure used was ANSI Standard ANSI C63.4:2014 using a ANRITSU spectrum analyzer with a pre-selector. The analyzer was calibrated in dB above a micro volt at the output of the antenna. The resolution bandwidth was 100kHz and the video bandwidth was 300 kHz up to 1 GHz and 1 MHz with a video BW of 3MHz above 1 GHz. The ambient temperature of the EUT was 25°C with a humidity of 58%.

**FORMULA OF CONVERSION FACTORS:** The Field Strength at 3m was established by adding the meter reading of the spectrum analyzer (which is set to read in units of dBuV) to the antenna correction factor supplied by the antenna manufacturer and cable loss. The antenna correction factors and cable loss are stated in terms of dB. The gain of the Pre-selector was accounted for in the Spectrum Analyzer Meter Reading.

Example:

Freq (MHz) METER READING + ACF + CABLE = FS

33.20 dBuV + 10.36 dB + 0.9 dB= 44.46 dBuV/m @ 3m

**ANSI STANDARD ANSI C63.4:2014 10.1.7 MEASUREMENT PROCEDURES:** The EUT was placed on a table 80 cm high and with dimensions of 1m by 1.5m. The EUT was placed in the center of the table (1.5m side). The table used for radiated measurements is capable of continuous rotation. When an emission was found, the table was rotated to produce the maximum signal strength. At this point, the antenna was raised and lowered from 1m to 4m. The antenna was placed in both the horizontal and vertical planes. The situation was similar for the conducted measurement except that the table did not rotate. The EUT was setup as described in ANSI Standard ANSI C63.4:2014 10.1.7 with the EUT 40 cm from the vertical ground wall.

## 4 Summary of Measurement

### 4.1 Summary of test result

Test Item	Test Requirement	Standards Paragraph	Result
Spurious Emission	FCC PART 15 : 2014 & IC RSS-247	Section 15.247&15.209 & RSS-247 Section 5.5	Compliance
Conduction Emission	FCC PART 15 : 2015 & IC RSS Gen 8.8	Section 15.207	Compliance
Bandwidth Test	FCC PART 15 : 2015 & IC RSS-247	Section 15.247& RSS-247 5.2	Compliance
Peak Power	FCC PART 15 : 2015 & IC RSS-247	Section 15.247 & RSS-247 5.4(4)	Compliance
Power Density	FCC PART 15 : 2015 & IC RSS-247	Section 15.247 & Section 5.2(2)	Compliance
Band Edge	FCC PART 15 : 2015 & IC RSS-247	Section 15.247 & Section 5.5	Compliance
Antenna Requirement	FCC PART 15 : 2015 & IC RSS Gen 8.3	Section 15.203	Compliance

Note: The EUT has been tested as an independent unit. And Continual Transmitting in maximum power (The adapter be used during Test)

### 4.2 Test connection





### 4.3 Assistant equipment used for test

Description	:	Tablet PC
Manufacturer	:	N/A
Model No.	:	IT15V090080X

### 4.4 Test mode

Dutycycle :100% Keeping TX			
Mode	data rate (Mbps)(see Note)	Channel	Frequency (MHz)
IEEE 802.11b	1	Low :CH1	2412
	1	Middle: CH6	2437
	1	High: CH11	2462
IEEE 802.11g	6	Low :CH1	2412
	6	Middle: CH6	2437
	6	High: CH11	2462
IEEE 802.11 n/HT20 with 2.4G	6.5	Low :CH1	2412
	6.5	Middle: CH6	2437
	6.5	High: CH11	2462
IEEE 802.11 n/HT40 with 2.4G	13.5	Low :CH3	2422
	13.5	Middle:CH6	2437
	13.5	High:CH9	2452

Note: According exploratory test, EUT will have maximum output power in those data rate. so those data rate were used for all test.

### 4.5 Channel list

For IEEE 802.11b/g and IEEE 802.11n/HT20 with 2.4G					
Channel	Frequency (MHz)	Channel	Frequency (MHz)	Channel	Frequency (MHz)
CH1	2412	CH5	2432	CH9	2452
CH2	2417	CH6	2437	CH10	2457
CH3	2422	CH7	2442	CH11	2462
CH4	2427	CH8	2447		

For IEEE 802.11n/HT40 with 2.4G					
Channel	Frequency (MHz)	Channel	Frequency (MHz)	Channel	Frequency (MHz)
CH1	/	CH5	2432	CH9	2452
CH2	/	CH6	2437	/	/
CH3	2422	CH7	2442	/	/
CH4	2427	CH8	2447	/	/

#### 4.6 Test Conditions

Temperature range	21-25°C
Humidity range	40-75%
Pressure range	86-106kPa

#### 4.7 Measurement Uncertainty (95% confidence levels, k=2)

Item	MU	Remark
Uncertainty for Power point Conducted Emissions Test	2.42dB	
Uncertainty for Radiation Emission test in 3m chamber (below 30MHz)	2.13 dB	Polarize: V
	2.57dB	Polarize: H
Uncertainty for Radiation Emission test in 3m chamber (30MHz to 1GHz)	3.54dB	Polarize: V
	4.1dB	Polarize: H
Uncertainty for Radiation Emission test in 3m chamber (1GHz to 25GHz)	2.08dB	Polarize: H
	2.56dB	Polarize: V
Uncertainty for radio frequency	$1 \times 10^{-9}$	
Uncertainty for conducted RF Power	0.65dB	
Uncertainty for temperature	0.2°C	
Uncertainty for humidity	1%	
Uncertainty for DC and low frequency voltages	0.06%	

## 5 Spurious Emission

### 5.1 Radiation Emission

#### 5.1.1 Radiation Emission Limits(15.209)

Frequencies (MHz)	Field Strength (micorvolts/meter)	Measurement Distance (meters)
0.009~0.490	2400/F(KHz)	300
0.490~1.705	24000/F(KHz)	30
1.705~30.0	30	30
30~88	100	3
88~216	150	3
216~960	200	3
Above 960	500	3

Harmonic emissions limits comply with below 54 dBuV/m at 3m. Other emissions radiated outside of the specified frequency bands, except for harmonics, shall be attenuated by at least 50 dB below the level of the fundamental or comply with the radiated emissions limits specified in section 15.209(a) limit in the table below has to be followed.

**NOTE:**

- a) The tighter limit applies at the band edges.
- b) Emission Level(dB uV/m)=20log Emission Level(Uv/m)

#### 5.1.2 Test Setup

See the next page

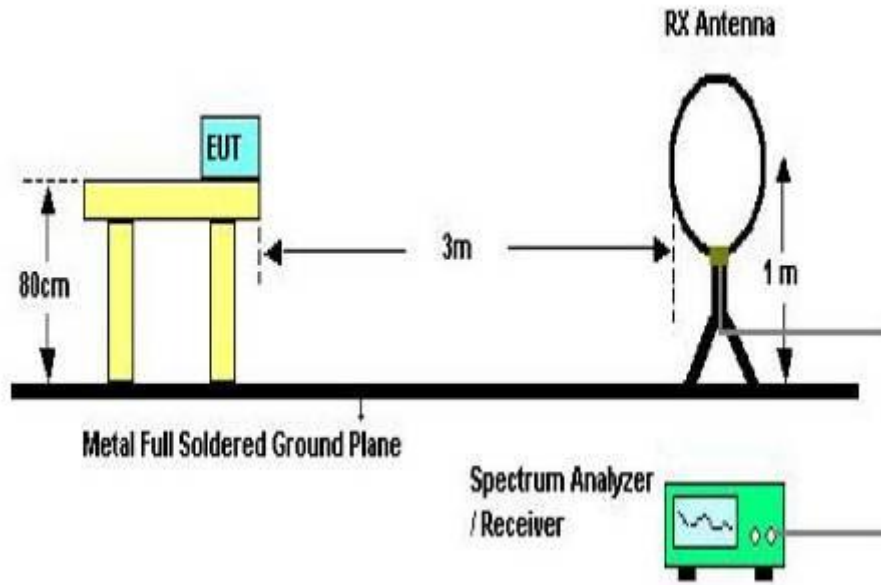

Below 30MHz Test Setup

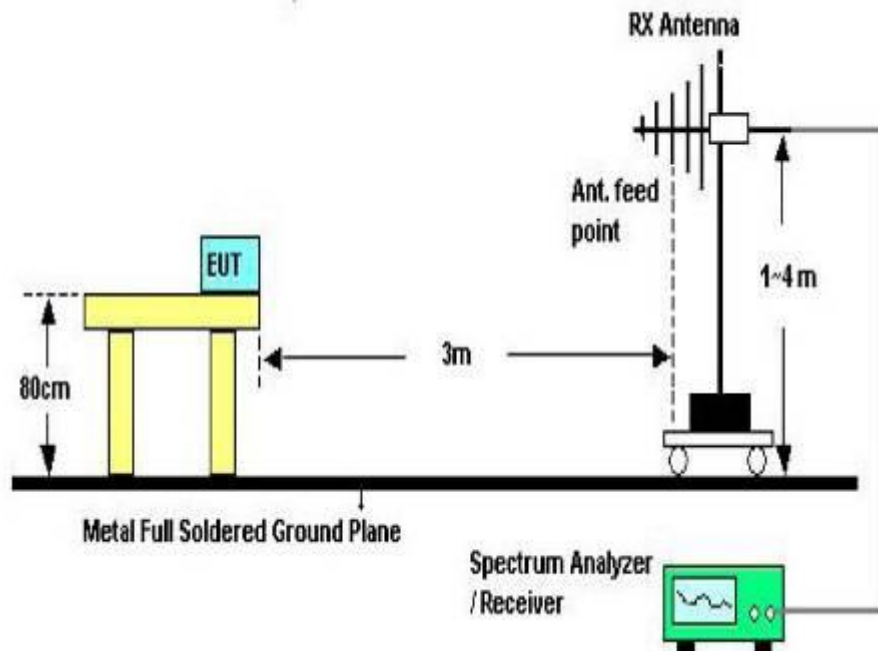

Above 30MHz Test Setup

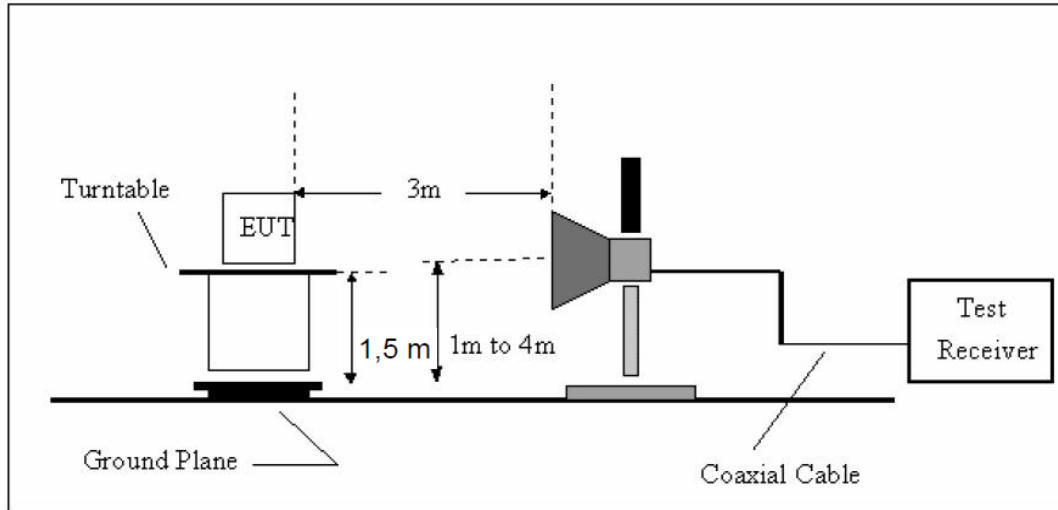

Above 1GHz Test Setup

### 5.1.3 Test Procedure

- a) The measuring distance of 3m shall be used for measurements at frequency up to 1GHz and above 1GHz, The EUT was placed on a rotating 0.8 m high above ground, The table was rotated 360 degrees to determine the position of the highest radiation
- b) The Test antenna shall vary between 1m and 4m, Both Horizontal and Vertical antenna are set of make measurement.
- c) The initial step in collecting conducted emission data is a spectrum analyzer Peak detector mode pre-scanning the measurement frequency range. Significant Peaks are then marked. And then Qusia Peak Detector mode premeasured
- d) If Peak value comply with QP limit Below 1GHz.The EUT deemed to comply with QP limit. But the Peak value and average value both need to comply with applicable limit above 1GHz.
- e) For the actual test configuration, please see the test setup photo.

#### 5.1.4 Test Equipment Setting For emission test Result

9KHz~150KHz	RBW 200Hz	VBW1KHz
150KHz~30MHz	RBW 9KHz	VBW 30KHz
30MHz~1GHz	RBW 120KHz	VBW 300KHz
Above 1GHz	RBW 1MHz	VBW 3MHz

#### 5.1.5 Test Condition

Continual Transmitting in maximum power.

#### 5.1.6 Test Result

We have scanned the 9KHz from 25GHz to the EUT.  
Detailed information please see the following page.

From 9KHz to 30MHz:      Conclusion: PASS

Note: The amplitude of spurious emissions which are attenuated by more than 20Db below the permissible value has no need to be reported.

H:

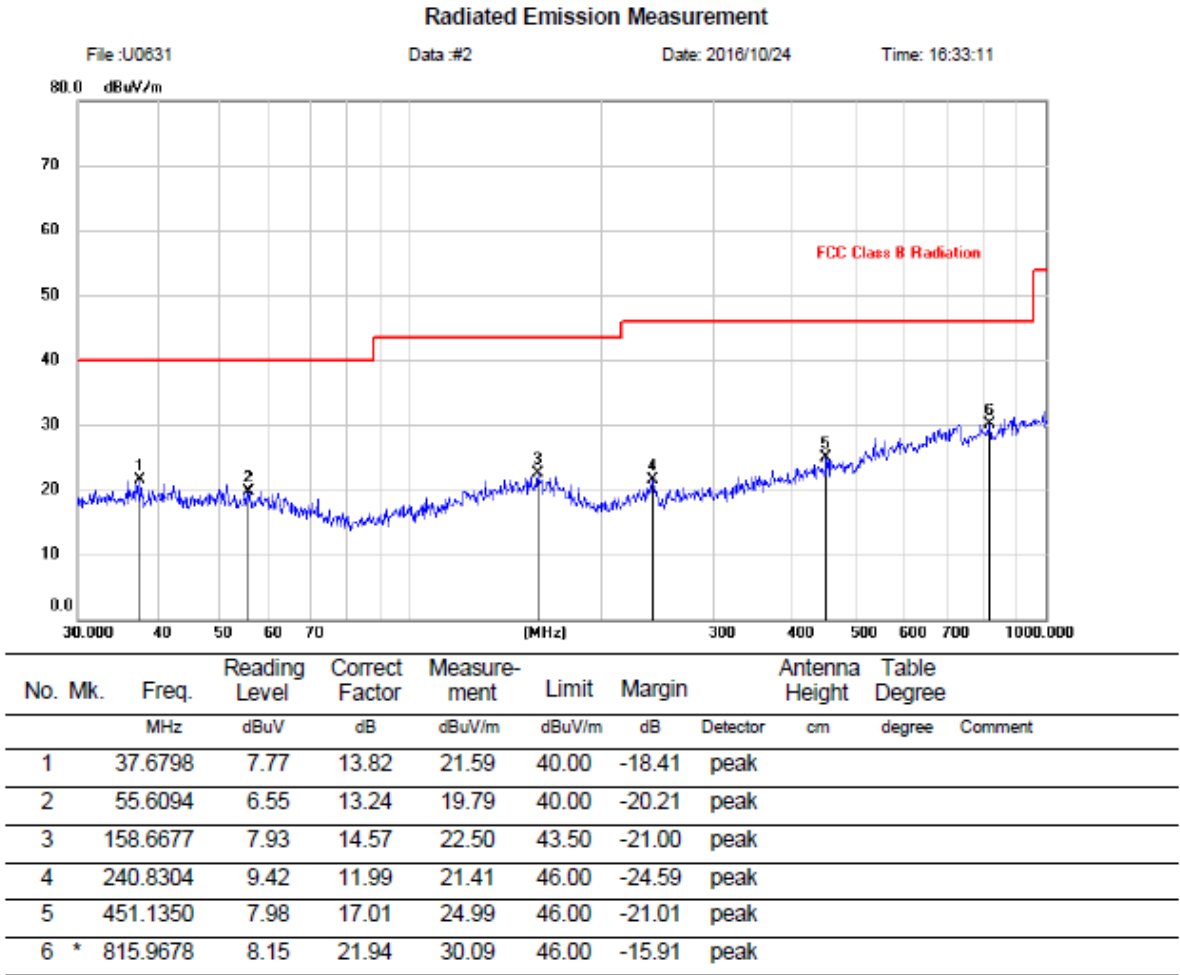

V:

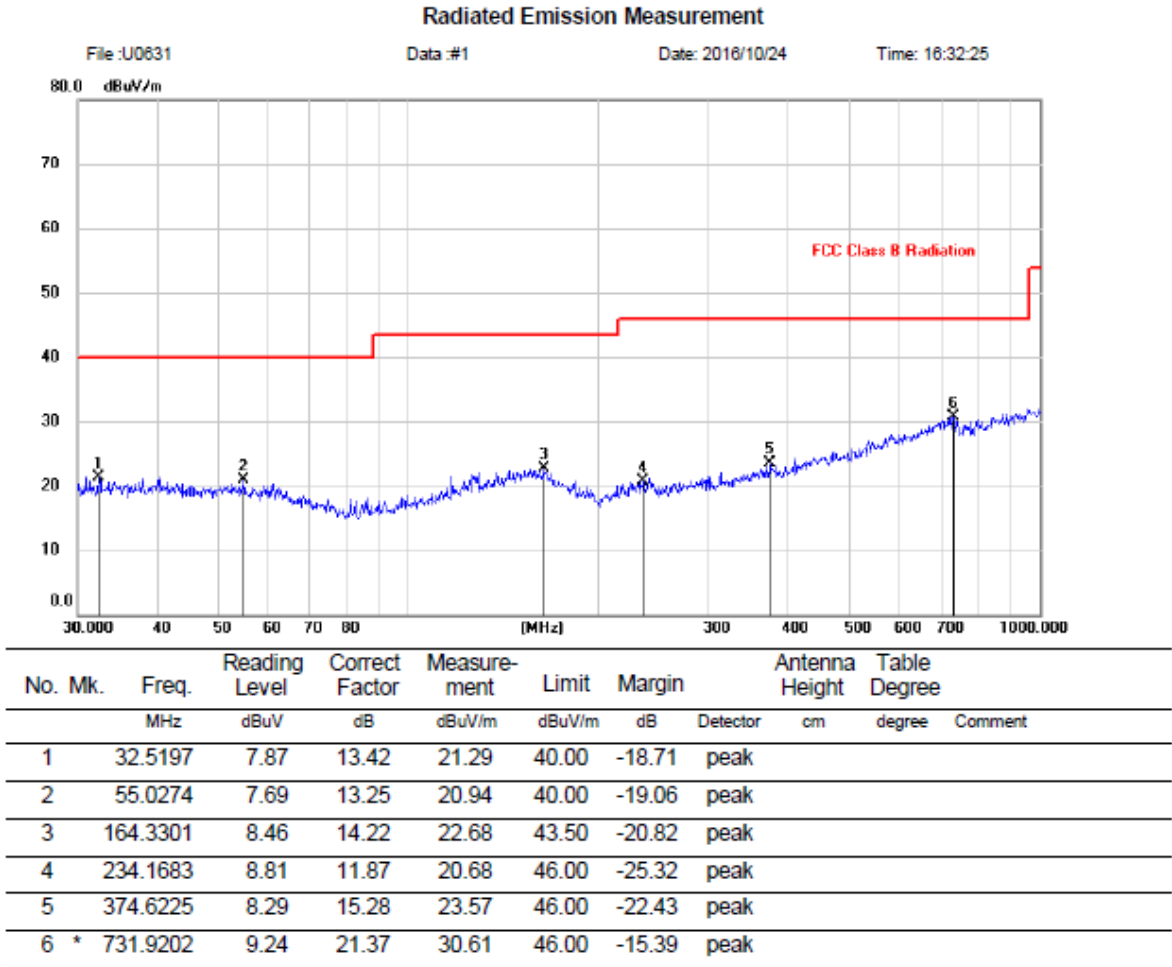

Remark: All modes and channels have been tested and only worst data of 802.11b, 2412MHz is listed in this report.



From 1G-25GHz

<b>EUT</b>	Mini 802.11ac Wireless USB Adapter	<b>Model Name</b>	U0631
<b>Temperature</b>	26°C	<b>Relative Humidity</b>	56%
<b>Pressure</b>	960hPa	<b>Test voltage</b>	DC 5V From USB port
<b>Test Mode</b>	TX Low		

IEEE 802.11b

Freq. (MHz)	Ant. Pol H/V	Peak Reading (dBuV)	AV Reading (dBuV)	Ant. / CL CF (dB)	Actual Fs		Peak Limit (dBuV/m)	AV Limit (dBuV/m)	Margin (dB)	Remark
					Peak (dBuV/m)	AV (dBuV/m)				
1103	V	42.58	---	-11.24	31.34	---	74	54	42.66	Peak
4824	V	34.96	---	0.64	35.6	---	74	54	38.4	Peak
N/A										

<b>EUT</b>	Mini 802.11ac Wireless USB Adapter	<b>Model Name</b>	U0631
<b>Temperature</b>	26°C	<b>Relative Humidity</b>	56%
<b>Pressure</b>	960hPa	<b>Test voltage</b>	DC 5V From USB port
<b>Test Mode</b>	TX Low		

Freq. (MHz)	Ant. Pol H/V	Peak Reading (dBuV)	AV Reading (dBuV)	Ant. / CL CF (dB)	Actual Fs		Peak Limit (dBuV/m)	AV Limit (dBuV/m)	Margin (dB)	Remark
					Peak (dBuV/m)	AV (dBuV/m)				
1103	H	42.1	---	-11.24	30.86	---	74	54	43.14	Peak
4824	H	34.69	---	0.64	35.33	---	74	54	38.67	Peak
N/A										

**Notes:** AV Means AV detector test data, Peak Means Peak detector test data.

Emissions attenuated more than 20 dB below the permissible value are not reported.

<b>EUT</b>	Mini 802.11ac Wireless USB Adapter	<b>Model Name</b>	U0631
<b>Temperature</b>	26°C	<b>Relative Humidity</b>	56%
<b>Pressure</b>	960hPa	<b>Test voltage</b>	DC 5V From USB port
<b>Test Mode</b>	TX Mid		

Freq. (MHz)	Ant. Pol H/V	Peak Reading (dBuV)	AV Reading (dBuV)	Ant. / CL CF (dB)	Actual Fs		Peak Limit (dBuV/m)	AV Limit (dBuV/m)	Margin (dB)	Remark
					Peak (dBuV/m)	AV (dBuV/m)				
1103	V	42.36	---	-11.24	31.12	---	74	54	42.88	Peak
4874	V	37.45	---	0.76	38.21	---	74	54	35.79	Peak

<b>EUT</b>	Mini 802.11ac Wireless USB Adapter	<b>Model Name</b>	U0631
<b>Temperature</b>	26°C	<b>Relative Humidity</b>	56%
<b>Pressure</b>	960hPa	<b>Test voltage</b>	DC 5V From USB port
<b>Test Mode</b>	TX Mid		

Freq. (MHz)	Ant. Pol H/V	Peak Reading (dBuV)	AV Reading (dBuV)	Ant. / CL CF (dB)	Actual Fs		Peak Limit (dBuV/m)	AV Limit (dBuV/m)	Margin (dB)	Remark
					Peak (dBuV/m)	AV (dBuV/m)				
1103	H	41.6	---	-11.24	30.36	---	74	54	43.64	Peak
4874	H	37.87	---	0.76	38.63	---	74	54	35.37	Peak

**Notes:** AV Means AV detector test data, Peak Means Peak detector test data.

Emissions attenuated more than 20 dB below the permissible value are not reported.

<b>EUT</b>	Mini 802.11ac Wireless USB Adapter	<b>Model Name</b>	U0631
<b>Temperature</b>	26°C	<b>Relative Humidity</b>	56%
<b>Pressure</b>	960hPa	<b>Test voltage</b>	DC 5V From USB port
<b>Test Mode</b>	TX High		

Freq. (MHz)	Ant. Pol H/V	Peak Reading (dBuV)	AV Reading (dBuV)	Ant. / CL CF (dB)	Actual Fs		Peak Limit (dBuV/m)	AV Limit (dBuV/m)	Margin (dB)	Remark
					Peak (dBuV/m)	AV (dBuV/m)				
1103	V	41.5	---	-11.24	30.26	---	74	54	43.74	Peak
4924	V	32.92	---	0.87	33.79	---	74	54	40.21	Peak

<b>EUT</b>	Mini 802.11ac Wireless USB Adapter	<b>Model Name</b>	U0631
<b>Temperature</b>	26°C	<b>Relative Humidity</b>	56%
<b>Pressure</b>	960hPa	<b>Test voltage</b>	DC 5V From USB port
<b>Test Mode</b>	TX High		

Freq. (MHz)	Ant. Pol H/V	Peak Reading (dBuV)	AV Reading (dBuV)	Ant. / CL CF (dB)	Actual Fs		Peak Limit (dBuV/m)	AV Limit (dBuV/m)	Margin (dB)	Remark
					Peak (dBuV/m)	AV (dBuV/m)				
1103	H	41.91	---	-11.24	30.67	---	74	54	43.33	Peak
4924	H	31.76	---	0.87	32.63	---	74	54	41.37	Peak

**Notes:** AV Means AV detector test data, Peak Means Peak detector test data.

Emissions attenuated more than 20 dB below the permissible value are not reported.

IEEE 802.11 g:

<b>EUT</b>	Mini 802.11ac Wireless USB Adapter	<b>Model Name</b>	U0631
<b>Temperature</b>	26°C	<b>Relative Humidity</b>	56%
<b>Pressure</b>	960hPa	<b>Test voltage</b>	DC 5V From USB port
<b>Test Mode</b>	TX Low		

Freq. (MHz)	Ant. Pol H/V	Peak Reading (dBuV)	AV Reading (dBuV)	Ant. / CL CF (dB)	Actual Fs		Peak Limit (dBuV/m)	AV Limit (dBuV/m)	Margin (dB)	Remark
					Peak (dBuV/m)	AV (dBuV/m)				
1145	V	42.38	---	-11.24	31.14	---	74	54	42.86	Peak
2586	V	44.45	---	-7.13	37.32	---	74	54	36.68	Peak
3062	V	42.51	---	-5.74	36.77	---	74	54	37.23	Peak
4824	V	42.11	---	0.64	42.75	---	74	54	31.25	Peak
N/A										

<b>EUT</b>	Mini 802.11ac Wireless USB Adapter	<b>Model Name</b>	U0631
<b>Temperature</b>	26°C	<b>Relative Humidity</b>	56%
<b>Pressure</b>	960hPa	<b>Test voltage</b>	DC 5V From USB port
<b>Test Mode</b>	TX Low		

Freq. (MHz)	Ant. Pol H/V	Peak Reading (dBuV)	AV Reading (dBuV)	Ant. / CL CF (dB)	Actual Fs		Peak Limit (dBuV/m)	AV Limit (dBuV/m)	Margin (dB)	Remark
					Peak (dBuV/m)	AV (dBuV/m)				
1294	H	41.72	---	-10.96	30.76	---	74	54	43.24	Peak
2038	H	41.91	---	-8.58	33.33	---	74	54	40.67	Peak
3483	H	40.81	---	-4.95	35.86	---	74	54	38.14	Peak
4824	H	39.61	---	0.64	40.25	---	74	54	33.75	Peak
N/A										

**Notes:** AV Means AV detector test data, Peak Means Peak detector test data.

Emissions attenuated more than 20 dB below the permissible value are not reported.

<b>EUT</b>	Mini 802.11ac Wireless USB Adapter	<b>Model Name</b>	U0631
<b>Temperature</b>	26°C	<b>Relative Humidity</b>	56%
<b>Pressure</b>	960hPa	<b>Test voltage</b>	DC 5V From USB port
<b>Test Mode</b>	TX Mid		

Freq. (MHz)	Ant. Pol H/V	Peak Reading (dBuV)	AV Reading (dBuV)	Ant. / CL CF (dB)	Actual Fs		Peak Limit (dBuV/m)	AV Limit (dBuV/m)	Margin (dB)	Remark
					Peak (dBuV/m)	AV (dBuV/m)				
1374	V	41.91	---	-10.43	31.48	---	74	54	42.52	Peak
2589	V	42.5	---	-7.13	35.37	---	74	54	38.63	Peak
3365	V	41.88	---	-5.18	36.7	---	74	54	37.3	Peak
4874	V	41.1	---	0.76	41.86	---	74	54	32.14	Peak

<b>EUT</b>	Mini 802.11ac Wireless USB Adapter	<b>Model Name</b>	U0631
<b>Temperature</b>	26°C	<b>Relative Humidity</b>	56%
<b>Pressure</b>	960hPa	<b>Test voltage</b>	DC 5V From USB port
<b>Test Mode</b>	TX Mid		

Freq. (MHz)	Ant. Pol H/V	Peak Reading (dBuV)	AV Reading (dBuV)	Ant. / CL CF (dB)	Actual Fs		Peak Limit (dBuV/m)	AV Limit (dBuV/m)	Margin (dB)	Remark
					Peak (dBuV/m)	AV (dBuV/m)				
1321	H	41.91	---	-10.84	31.07	---	74	54	42.93	Peak
2314	H	42.61	---	-7.46	35.15	---	74	54	38.85	Peak
3577	H	40.9	---	-4.76	36.14	---	74	54	37.86	Peak
4874	H	38.61	---	0.76	39.37	---	74	54	34.63	Peak

**Notes:** AV Means AV detector test data, Peak Means Peak detector test data.

Emissions attenuated more than 20 dB below the permissible value are not reported.

<b>EUT</b>	Mini 802.11ac Wireless USB Adapter	<b>Model Name</b>	U0631
<b>Temperature</b>	26°C	<b>Relative Humidity</b>	56%
<b>Pressure</b>	960hPa	<b>Test voltage</b>	DC 5V From USB port
<b>Test Mode</b>	TX High		

Freq. (MHz)	Ant. Pol H/V	Peak Reading (dBuV)	AV Reading (dBuV)	Ant. / CL CF (dB)	Actual Fs		Peak Limit (dBuV/m)	AV Limit (dBuV/m)	Margin (dB)	Remark
					Peak (dBuV/m)	AV (dBuV/m)				
1302	V	41.91	---	-10.84	31.07	---	74	54	42.93	Peak
2982	V	42.45	---	-5.86	36.59	---	74	54	37.41	Peak
3831	V	41.51	---	-3.96	37.55	---	74	54	36.45	Peak
4924	V	39.91	---	0.87	40.78	---	74	54	33.22	Peak

<b>EUT</b>	Mini 802.11ac Wireless USB Adapter	<b>Model Name</b>	U0631
<b>Temperature</b>	26°C	<b>Relative Humidity</b>	56%
<b>Pressure</b>	960hPa	<b>Test voltage</b>	DC 5V From USB port
<b>Test Mode</b>	TX High		

Freq. (MHz)	Ant. Pol H/V	Peak Reading (dBuV)	AV Reading (dBuV)	Ant. / CL CF (dB)	Actual Fs		Peak Limit (dBuV/m)	AV Limit (dBuV/m)	Margin (dB)	Remark
					Peak (dBuV/m)	AV (dBuV/m)				
1446	H	42.09	---	-10.29	31.8	---	74	54	42.2	Peak
2198	H	40.91	---	-8.24	32.67	---	74	54	41.33	Peak
3905	H	42.01	---	-3.68	38.33	---	74	54	35.67	Peak
4924	H	39.49	---	0.87	40.36	---	74	54	33.64	Peak

**Notes:** AV Means AV detector test data, Peak Means Peak detector test data.

Emissions attenuated more than 20 dB below the permissible value are not reported.

## IEEE 802.11n/HT20 with 2.4G

<b>EUT</b>	Mini 802.11ac Wireless USB Adapter	<b>Model Name</b>	U0631
<b>Temperature</b>	26°C	<b>Relative Humidity</b>	56%
<b>Pressure</b>	960hPa	<b>Test voltage</b>	DC 5V From USB port
<b>Test Mode</b>	TX Low		

Freq. (MHz)	Ant. Pol H/V	Peak Reading (dBuV)	AV Reading (dBuV)	Ant. / CL CF (dB)	Actual Fs		Peak Limit (dBuV/m)	AV Limit (dBuV/m)	Margin (dB)	Remark
					Peak (dBuV/m)	AV (dBuV/m)				
1492	V	42.09	---	-10.27	31.82	---	74	54	42.18	Peak
2671	V	41.68	---	-6.94	34.74	---	74	54	39.26	Peak
3948	V	41.87	---	-3.68	38.19	---	74	54	35.81	Peak
4824	V	40.62	---	0.64	41.26	---	74	54	32.74	Peak
N/A										

<b>EUT</b>	Mini 802.11ac Wireless USB Adapter	<b>Model Name</b>	U0631
<b>Temperature</b>	26°C	<b>Relative Humidity</b>	56%
<b>Pressure</b>	960hPa	<b>Test voltage</b>	DC 5V From USB port
<b>Test Mode</b>	TX Low		

Freq. (MHz)	Ant. Pol H/V	Peak Reading (dBuV)	AV Reading (dBuV)	Ant. / CL CF (dB)	Actual Fs		Peak Limit (dBuV/m)	AV Limit (dBuV/m)	Margin (dB)	Remark
					Peak (dBuV/m)	AV (dBuV/m)				
1451	H	42.12	---	-10.27	31.85	---	74	54	42.15	Peak
2839	H	42.39	---	-6.17	36.22	---	74	54	37.78	Peak
3607	H	41.96	---	-4.52	37.44	---	74	54	36.56	Peak
4824	H	40.88	---	0.64	41.52	---	74	54	32.48	Peak
N/A										

**Notes:** AV Means AV detector test data, Peak Means Peak detector test data.

Emissions attenuated more than 20 dB below the permissible value are not reported.

<b>EUT</b>	Mini 802.11ac Wireless USB Adapter	<b>Model Name</b>	U0631
<b>Temperature</b>	26°C	<b>Relative Humidity</b>	56%
<b>Pressure</b>	960hPa	<b>Test voltage</b>	DC 5V From USB port
<b>Test Mode</b>	TX Mid		

Freq. (MHz)	Ant. Pol H/V	Peak Reading (dBuV)	AV Reading (dBuV)	Ant. / CL CF (dB)	Actual Fs		Peak Limit (dBuV/m)	AV Limit (dBuV/m)	Margin (dB)	Remark
					Peak (dBuV/m)	AV (dBuV/m)				
1262	V	41.81	---	-10.96	30.85	---	74	54	43.15	Peak
2013	V	42.25	---	-8.58	33.67	---	74	54	40.33	Peak
3798	V	41.49	---	-4.07	37.42	---	74	54	36.58	Peak
4874	V	40.61	---	0.76	41.37	---	74	54	32.63	Peak

<b>EUT</b>	Mini 802.11ac Wireless USB Adapter	<b>Model Name</b>	U0631
<b>Temperature</b>	26°C	<b>Relative Humidity</b>	56%
<b>Pressure</b>	960hPa	<b>Test voltage</b>	DC 5V From USB port
<b>Test Mode</b>	TX Mid		

Freq. (MHz)	Ant. Pol H/V	Peak Reading (dBuV)	AV Reading (dBuV)	Ant. / CL CF (dB)	Actual Fs		Peak Limit (dBuV/m)	AV Limit (dBuV/m)	Margin (dB)	Remark
					Peak (dBuV/m)	AV (dBuV/m)				
1511	H	41.71	---	-10.14	31.57	---	74	54	42.43	Peak
2353	H	41.87	---	-7.59	34.28	---	74	54	39.72	Peak
3266	H	42.14	---	-5.39	36.75	---	74	54	37.25	Peak
4874	H	40.88	---	0.76	41.64	---	74	54	32.36	Peak

**Notes:** AV Means AV detector test data, Peak Means Peak detector test data.

Emissions attenuated more than 20 dB below the permissible value are not reported.



<b>EUT</b>	Mini 802.11ac Wireless USB Adapter	<b>Model Name</b>	U0631
<b>Temperature</b>	26°C	<b>Relative Humidity</b>	56%
<b>Pressure</b>	960hPa	<b>Test voltage</b>	DC 5V From USB port
<b>Test Mode</b>	TX High		

Freq. (MHz)	Ant. Pol H/V	Peak Reading (dBuV)	AV Reading (dBuV)	Ant. / CL CF (dB)	Actual Fs		Peak Limit (dBuV/m)	AV Limit (dBuV/m)	Margin (dB)	Remark
					Peak (dBuV/m)	AV (dBuV/m)				
1477	V	43.14	---	-10.27	32.87	---	74	54	41.13	Peak
2703	V	42.02	---	-6.43	35.59	---	74	54	38.41	Peak
3561	V	41.91	---	-4.76	37.15	---	74	54	36.85	Peak
4924	V	40.74	---	0.87	41.61	---	74	54	32.39	Peak

<b>EUT</b>	Mini 802.11ac Wireless USB Adapter	<b>Model Name</b>	U0631
<b>Temperature</b>	26°C	<b>Relative Humidity</b>	56%
<b>Pressure</b>	960hPa	<b>Test voltage</b>	DC 5V From USB port
<b>Test Mode</b>	TX High		

Freq. (MHz)	Ant. Pol H/V	Peak Reading (dBuV)	AV Reading (dBuV)	Ant. / CL CF (dB)	Actual Fs		Peak Limit (dBuV/m)	AV Limit (dBuV/m)	Margin (dB)	Remark
					Peak (dBuV/m)	AV (dBuV/m)				
1503	H	41.69	---	-10.14	31.55	---	74	54	42.45	Peak
3588	H	41.99	---	-4.96	37.03	---	74	54	36.97	Peak
4153	H	41.8	---	-2.48	39.32	---	74	54	34.68	Peak
4924	H	39.85	---	0.87	40.72	---	74	54	33.28	Peak

**Notes:** AV Means AV detector test data, Peak Means Peak detector test data.

Emissions attenuated more than 20 dB below the permissible value are not reported.

## IEEE 802.11n/HT40 with 2.4G

<b>EUT</b>	Mini 802.11ac Wireless USB Adapter	<b>Model Name</b>	U0631
<b>Temperature</b>	26°C	<b>Relative Humidity</b>	56%
<b>Pressure</b>	960hPa	<b>Test voltage</b>	DC 5V From USB port
<b>Test Mode</b>	TX Low		

Freq. (MHz)	Ant. Pol H/V	Peak Reading (dBuV)	AV Reading (dBuV)	Ant. / CL CF (dB)	Actual Fs		Peak Limit (dBuV/m)	AV Limit (dBuV/m)	Margin (dB)	Remark
					Peak (dBuV/m)	AV (dBuV/m)				
1551	V	42.15	---	-10.07	32.08	---	74	54	41.92	Peak
2695	V	42.02	---	-6.94	35.08	---	74	54	38.92	Peak
3463	V	41.31	---	-4.95	36.36	---	74	54	37.64	Peak
4844	V	39.9	---	0.64	40.54	---	74	54	33.46	Peak
N/A										

<b>EUT</b>	Mini 802.11ac Wireless USB Adapter	<b>Model Name</b>	U0631
<b>Temperature</b>	26°C	<b>Relative Humidity</b>	56%
<b>Pressure</b>	960hPa	<b>Test voltage</b>	DC 5V From USB port
<b>Test Mode</b>	TX Low		

Freq. (MHz)	Ant. Pol H/V	Peak Reading (dBuV)	AV Reading (dBuV)	Ant. / CL CF (dB)	Actual Fs		Peak Limit (dBuV/m)	AV Limit (dBuV/m)	Margin (dB)	Remark
					Peak (dBuV/m)	AV (dBuV/m)				
1542	H	41.92	---	-10.14	31.78	---	74	54	42.22	Peak
2358	H	41.78	---	-7.59	34.19	---	74	54	39.81	Peak
3096	H	42.19	---	-5.74	36.45	---	74	54	37.55	Peak
4844	H	40.59	---	0.64	41.23	---	74	54	32.77	Peak
N/A										

**Notes:** AV Means AV detector test data, Peak Means Peak detector test data.

Emissions attenuated more than 20 dB below the permissible value are not reported.

<b>EUT</b>	Mini 802.11ac Wireless USB Adapter	<b>Model Name</b>	U0631
<b>Temperature</b>	26°C	<b>Relative Humidity</b>	56%
<b>Pressure</b>	960hPa	<b>Test voltage</b>	DC 5V From USB port
<b>Test Mode</b>	TX Mid		

Freq. (MHz)	Ant. Pol H/V	Peak Reading (dBuV)	AV Reading (dBuV)	Ant. / CL CF (dB)	Actual Fs		Peak Limit (dBuV/m)	AV Limit (dBuV/m)	Margin (dB)	Remark
					Peak (dBuV/m)	AV (dBuV/m)				
1628	V	42.48	---	-9.84	32.64	---	74	54	41.36	Peak
2593	V	41.9	---	-7.13	34.77	---	74	54	39.23	Peak
3301	V	42.04	---	-5.31	36.73	---	74	54	37.27	Peak
4874	V	40.89	---	0.76	41.65	---	74	54	32.35	Peak

<b>EUT</b>	Mini 802.11ac Wireless USB Adapter	<b>Model Name</b>	U0631
<b>Temperature</b>	26°C	<b>Relative Humidity</b>	56%
<b>Pressure</b>	960hPa	<b>Test voltage</b>	DC 5V From USB port
<b>Test Mode</b>	TX Mid		

Freq. (MHz)	Ant. Pol H/V	Peak Reading (dBuV)	AV Reading (dBuV)	Ant. / CL CF (dB)	Actual Fs		Peak Limit (dBuV/m)	AV Limit (dBuV/m)	Margin (dB)	Remark
					Peak (dBuV/m)	AV (dBuV/m)				
1564	H	42.11	---	-10.07	32.04	---	74	54	41.96	Peak
2248	H	42.45	---	-8.13	34.32	---	74	54	39.68	Peak
3159	H	41.41	---	-5.52	35.89	---	74	54	38.11	Peak
4874	H	40.66	---	0.76	41.42	---	74	54	32.58	Peak

**Notes:** AV Means AV detector test data, Peak Means Peak detector test data.

Emissions attenuated more than 20 dB below the permissible value are not reported.

<b>EUT</b>	Mini 802.11ac Wireless USB Adapter	<b>Model Name</b>	U0631
<b>Temperature</b>	26°C	<b>Relative Humidity</b>	56%
<b>Pressure</b>	960hPa	<b>Test voltage</b>	DC 5V From USB port
<b>Test Mode</b>	TX High		

Freq. (MHz)	Ant. Pol H/V	Peak Reading (dBuV)	AV Reading (dBuV)	Ant. / CL CF (dB)	Actual Fs		Peak Limit (dBuV/m)	AV Limit (dBuV/m)	Margin (dB)	Remark
					Peak (dBuV/m)	AV (dBuV/m)				
1645	V	42.54	---	-9.84	32.7	---	74	54	41.3	Peak
2590	V	42.07	---	-7.13	34.94	---	74	54	39.06	Peak
3851	V	41.49	---	-3.84	37.65	---	74	54	36.35	Peak
4904	V	39.84	---	0.87	40.71	---	74	54	33.29	Peak

<b>EUT</b>	Mini 802.11ac Wireless USB Adapter	<b>Model Name</b>	U0631
<b>Temperature</b>	26°C	<b>Relative Humidity</b>	56%
<b>Pressure</b>	960hPa	<b>Test voltage</b>	DC 5V From USB port
<b>Test Mode</b>	TX High		

Freq. (MHz)	Ant. Pol H/V	Peak Reading (dBuV)	AV Reading (dBuV)	Ant. / CL CF (dB)	Actual Fs		Peak Limit (dBuV/m)	AV Limit (dBuV/m)	Margin (dB)	Remark
					Peak (dBuV/m)	AV (dBuV/m)				
1792	H	42.21	---	-9.27	32.94	---	74	54	41.06	Peak
2804	H	42.39	---	-6.17	36.22	---	74	54	37.78	Peak
3743	H	42.75	---	-4.24	38.51	---	74	54	35.49	Peak
4904	H	41.18	---	0.87	42.05	---	74	54	31.95	Peak

**Notes:** AV Means AV detector test data, Peak Means Peak detector test data.

Emissions attenuated more than 20 dB below the permissible value are not reported.

## 6 POWER LINE CONDUCTED EMISSION

### 6.1 Conducted Emission Limits(15.207)

Frequency MHz	Limits dB( $\mu$ V)	
	Quasi-peak Level	Average Level
0.15 -0.50	66 -56*	56 - 46*
0.50 -5.00	56	46
5.00 -30.00	60	50

Notes: 1. \*Decreasing linearly with logarithm of frequency.

2. The lower limit shall apply at the transition frequencies.

3.The limit decreases in line with the logarithm of the frequency in the rang of 0.15 to 0.50 MHz.

### 6.2 Test Setup

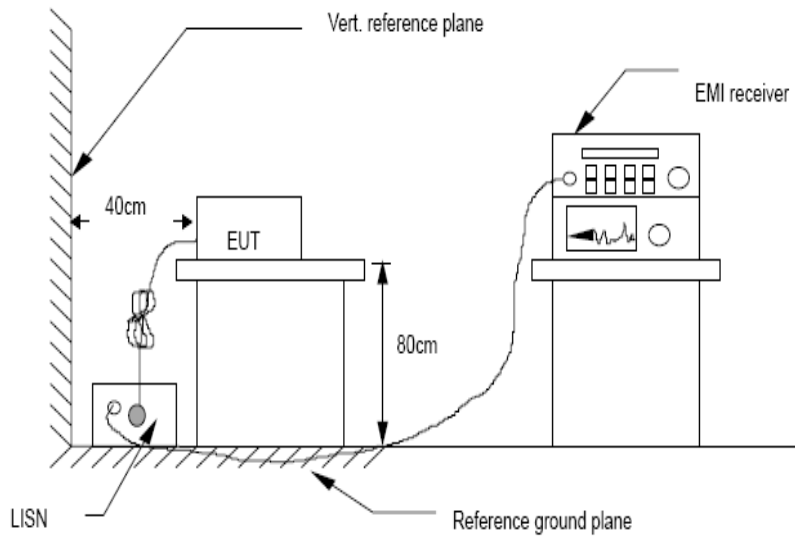

### 6.3 Test Procedure

The EUT is put on the plane 0.8m high above the ground by insulating support and is connected to the power mains through a line impedance stabilization network (L.I.S.N.). This provides a 50ohm coupling impedance for the EUT system. Please refer the block diagram of the test setup and photographs. Both sides of AC lines are checked to find out the maximum conducted emission. In order to find the maximum emission levels, the relative positions of equipment and all of the interface cables shall be changed according to ANSI C63.4:2014 on Conducted Emission Measurement. The bandwidth of test receiver is set at 9 kHz.

### 6.4 Test Results

Worse case is reported only

**PASS**

Detailed information please see the following page.

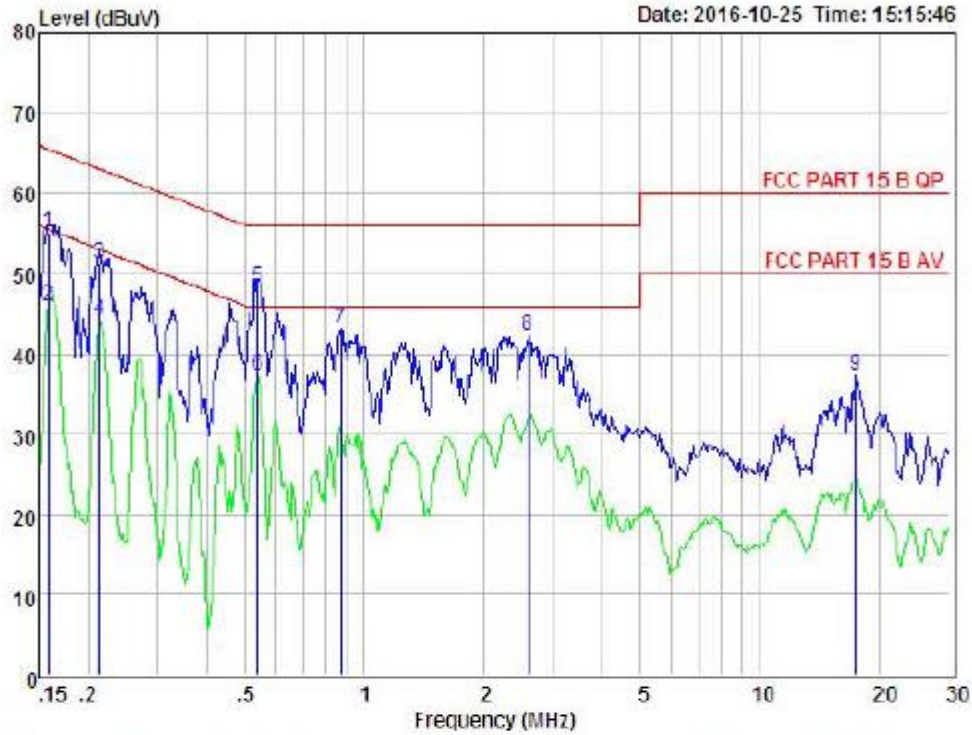

Condition : FCC PART 15 B QP      POL: LINE      Temp: 25°C      Hum: 51 %  
 EUT : Mini 802.11ac Wireless USB Adapter  
 Model No : U0631  
 Test Mode :  
 Power : DC 5V from PC with AC 120V/60Hz  
 Test Engineer : Eric  
 Remark :

Item	Freq MHz	Read Level	LISN Factor dB	Preamp Factor dB	Cable Loss dB	Level dBuV	Limit dBuV	Margin dBuV	Remark
1	0.159	45.41	0.03	-9.52	0.10	55.06	65.52	-10.46	QP
2	0.159	36.25	0.03	-9.52	0.10	45.90	55.52	-9.62	Average
3	0.214	41.35	0.03	-9.52	0.10	51.20	63.05	-11.85	QP
4	0.214	34.63	0.03	-9.52	0.10	44.28	53.05	-8.77	Average
5	0.538	36.62	0.03	-9.58	0.10	48.33	56.00	-7.67	QP
6	0.538	27.54	0.03	-9.58	0.10	37.25	46.00	-8.75	Average
7	0.871	33.34	0.04	-9.62	0.10	43.10	56.00	-12.90	Peak
8	2.594	32.23	0.06	-9.76	0.11	42.16	56.00	-13.84	Peak
9	17.475	26.96	0.28	-9.82	0.30	37.36	60.00	-22.64	Peak

Remark: Level = Read Level + LISN Factor - Preamp Factor + Cable Loss

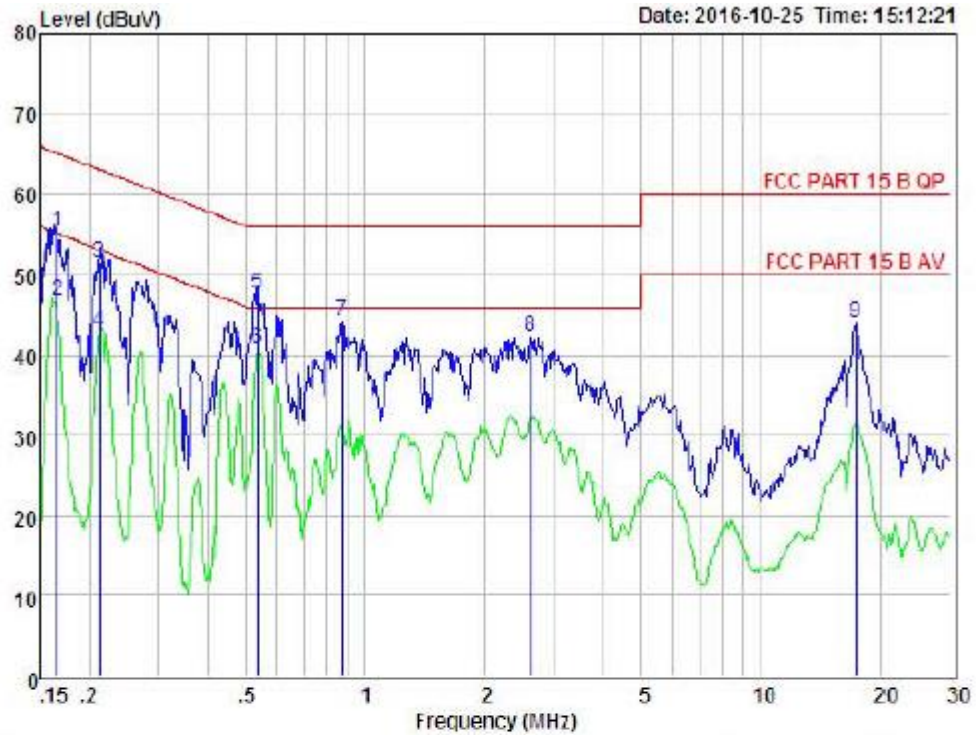

Condition : FCC PART 15 B QP POL: NEUTRAL Temp: 25°C Hum: 51 %  
 EUT : Mini 802.11ac Wireless USB Adapter  
 Model No : U0631  
 Test Mode :  
 Power : DC 5V from PC with AC 120V/60Hz  
 Test Engineer : Eric  
 Remark :

Item	Freq MHz	Read Level dBuV	LISN Factor dB	Preamp Factor dB	Cable Loss dB	Level dBuV	Limit dBuV	Margin dBuV	Remark
1	0.166	45.59	0.03	-9.52	0.10	55.24	65.16	-9.92	QP
2	0.166	37.11	0.03	-9.52	0.10	46.76	55.16	-8.40	Average
3	0.213	41.80	0.03	-9.52	0.10	51.45	63.10	-11.65	QP
4	0.213	33.23	0.03	-9.52	0.10	42.88	53.10	-10.22	Average
5	0.333	37.87	0.03	-9.58	0.10	47.58	56.00	-8.42	QP
6	0.535	31.01	0.03	-9.58	0.10	40.72	46.00	-5.28	Average
7	0.871	34.32	0.04	-9.82	0.10	44.08	56.00	-11.92	Peak
8	2.622	32.33	0.06	-9.76	0.11	42.26	56.00	-13.74	Peak
9	17.383	33.67	0.28	-9.82	0.30	44.07	60.00	-15.93	Peak

Remark: Level = Read Level + LISN Factor - Preamp Factor + Cable Loss

Remark: All modes and channels have been tested and only worst data of 802.11b, 2412MHz is listed in this report.



## 7 Conducted Maximum Output Power

### 7.1 Test limit

Please refer section 15.247.

Regulation 15.247(b) The limit of Maximum Peak Output Power Measurement is 1W(30dBm)

### 7.2 Test Procedure

Details see the KDB558074 Meas Guidance V03

7.2.1 Place the EUT on the table and set it in transmitting mode.

7.2.2 Connected the EUT's antenna port to peak power meter by 20dB attenuator.

7.2.3 Measure out each mode and each bands peak output power of EUT.

Note: The cable loss and attenuator loss were offset into measure device as amplitude offset.

Details see the KDB558074 DTS Meas Guidance V03

### 7.3 Test Setup

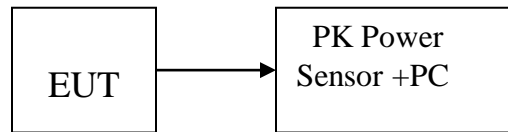

### 7.4 Test Results

**PASS**

Detailed information please see the following page.

EUT: Mini 802.11ac Wireless USB Adapter M/N: U0631			
Test date: 2016-10-25		Test site: RF site	Tested by: Simple Guan
Mode	Frequency (MHz)	PK Output power(dBm)	Limit (dBm)
IEEE 802.11 b	CH1: 2412	8.02	30
	CH6: 2437	8.01	30
	CH11: 2462	8.02	30
IEEE 802.11 g	CH1: 2412	8.04	30
	CH6: 2437	8.11	30
	CH11: 2462	8.21	30
IEEE 802.11 n/HT20 with 2.4G	CH1: 2412	8.37	30
	CH6: 2437	8.12	30
	CH11: 2462	8.02	30
IEEE 802.11 n/HT40 with 2.4G	CH1: 2422	8.03	30
	CH4: 2437	8.05	30
	CH7: 2452	8.02	30
Conclusion: PASS			

## 8 PEAK POWER SPECTRAL DENSITY

### 8.1 Test limit

8.1.1 Please refer section 15.247.

8.1.2 For direct sequence systems, the peak power spectral density conducted from the intentional radiator to the antenna shall not be greater than 8dBm in any 3kHz band during any time interval of continuous transmission.

8.1.3 The direct sequence operating of the hybrid system, with the frequency hopping operation turned off, shall comply with the power density requirements of paragraph (d) of this section.

### 8.2 Method of measurement

Details see the KDB558074 DTS Meas Guidance V03

8.2.1 Place the EUT on the table and set it in transmitting mode.

8.2.2 Remove the antenna from the EUT and then connect a low loss RF cable from the antenna port to the spectrum analyzer.

8.2.3 Set the spectrum analyzer as RBW = 3kHz, VBW = 10kHz, span=5-30%EBW, detail see the test plot.

8.2.4 Record the max reading.

8.2.5 Repeat the above procedure until the measurements for all frequencies are completed.

### 8.3 Test Setup

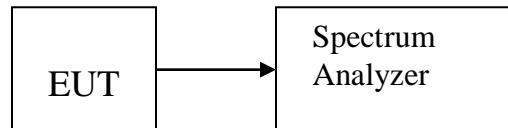

## 8.4 Test Results

**PASS.**

Detailed information please see the following page.

EUT: Mini 802.11ac Wireless USB Adapter M/N: U0631				
Test date: 2016-10-25		Test site: RF site		Tested by: Simple Guan
Mode	Frequency (MHz)	PK Output power(dBm)	Limit (dBm)	Result
IEEE 802.11 b	CH1: 2412	-24.041	8	PASS
	CH6: 2437	-22.533	8	PASS
	CH11: 2462	-22.831	8	PASS
IEEE 802.11 g	CH1: 2412	-24.400	8	PASS
	CH6: 2437	-24.709	8	PASS
	CH11: 2462	-24.302	8	PASS
IEEE 802.11 n/HT20 with 2.4G	CH1: 2412	-22.860	8	PASS
	CH6: 2437	-25.029	8	PASS
	CH11: 2462	-24.020	8	PASS
IEEE 802.11 n/HT40 with 2.4G	CH1: 2422	-28.143	8	PASS
	CH4: 2437	-28.103	8	PASS
	CH7: 2452	-28.750	8	PASS
Conclusion: PASS				

IEEE 802.11b :  
CH Low :

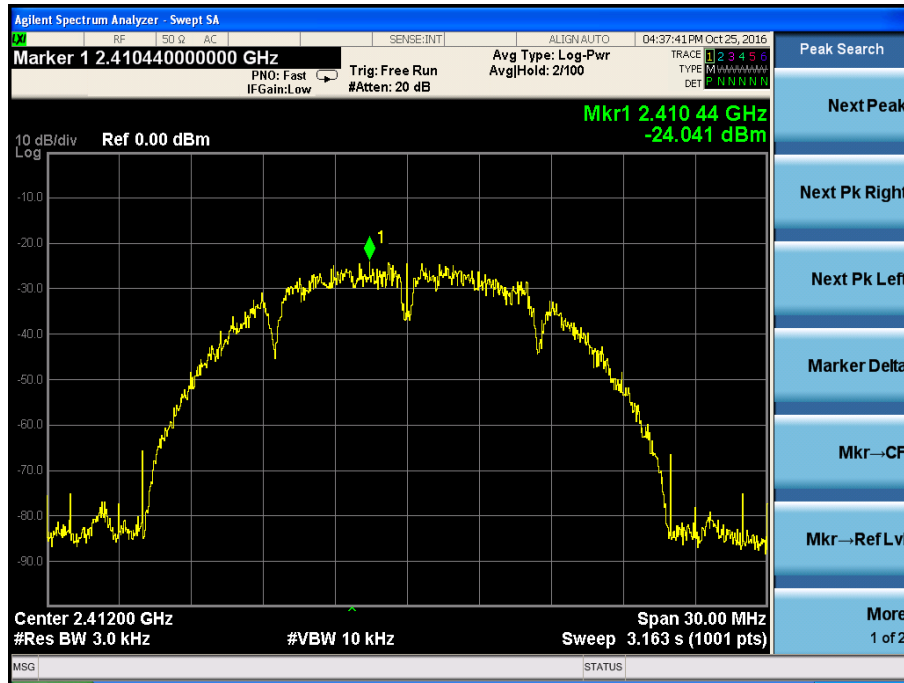

CH Mid:



CH Hig:

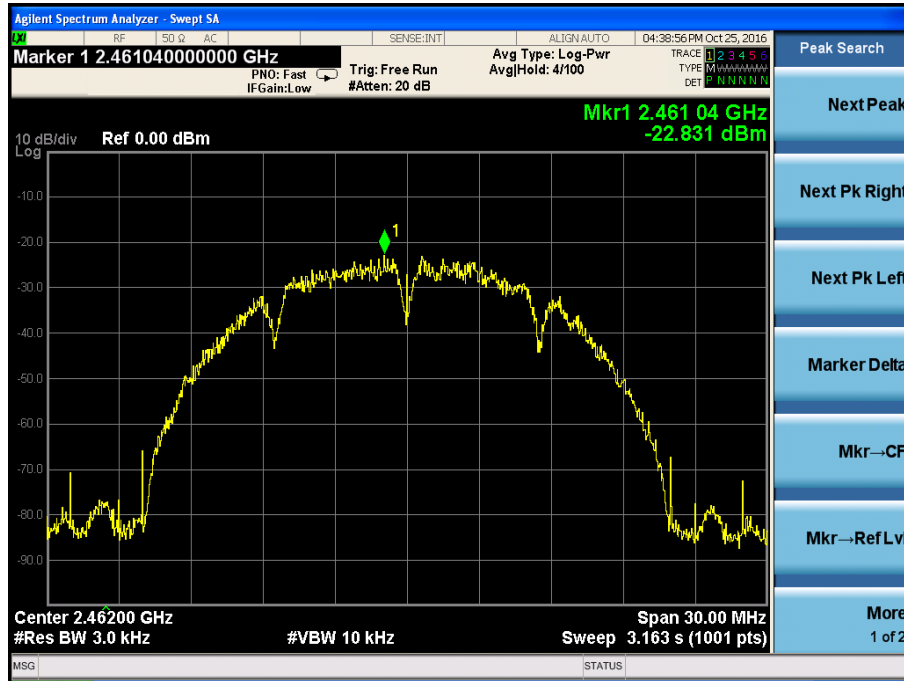

IEEE 802.11g :  
CH Low

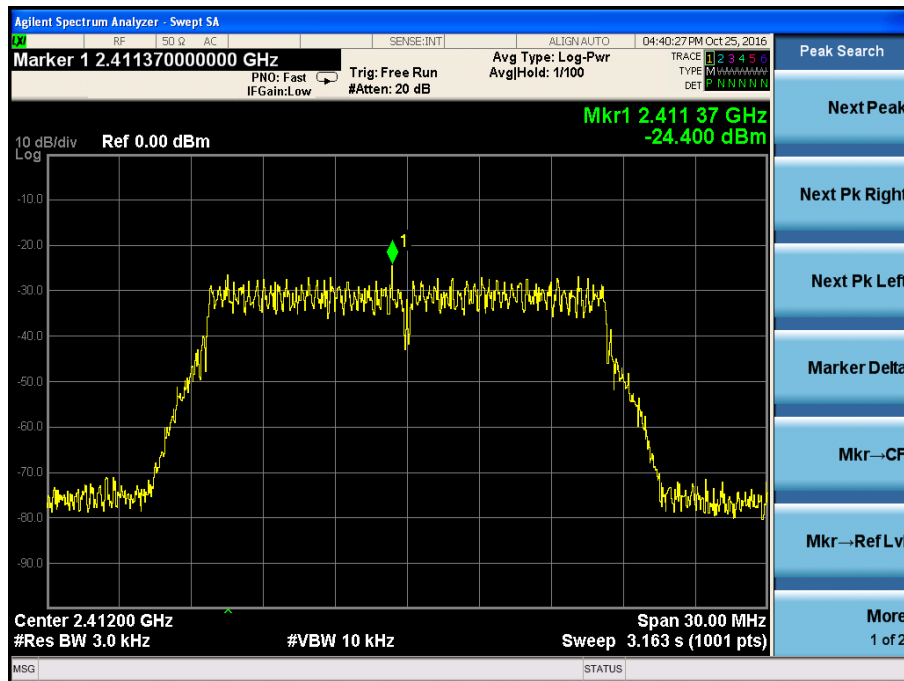

CH Mid:

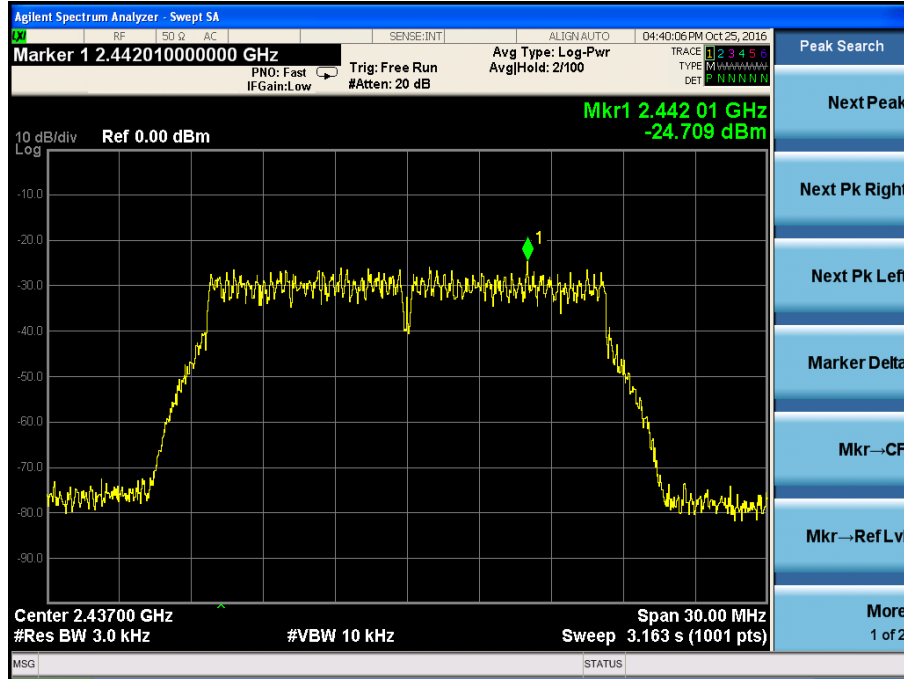

CH Hig:

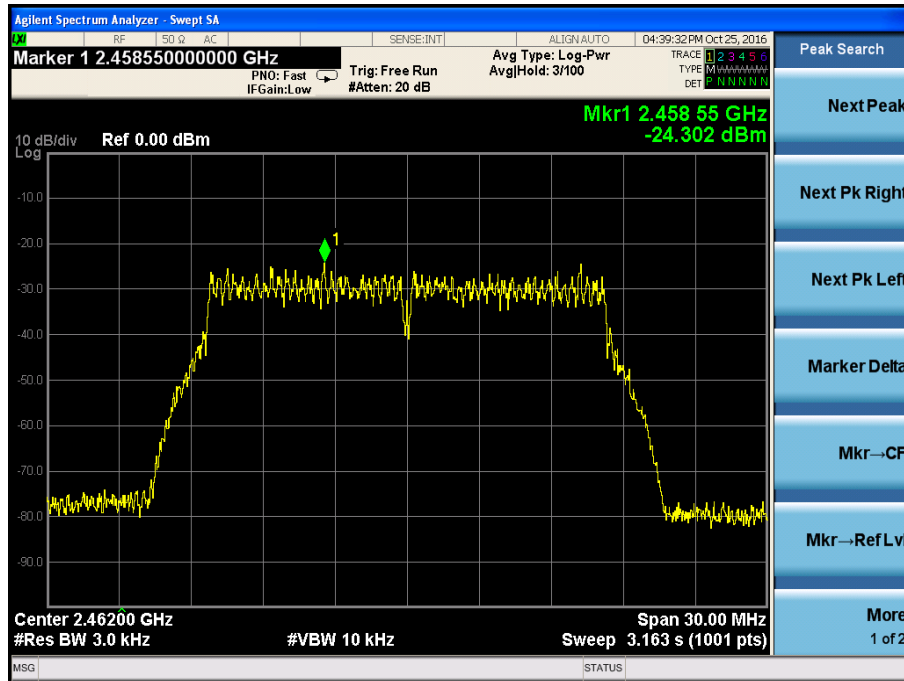



IEEE 802.11n HT20 :  
CH Low :

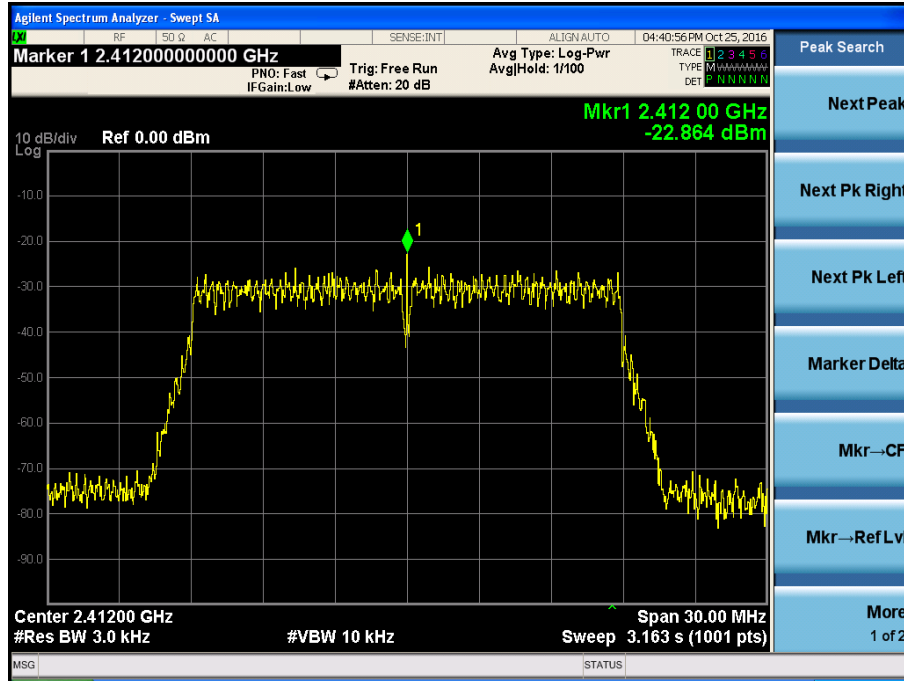

CH Mid:

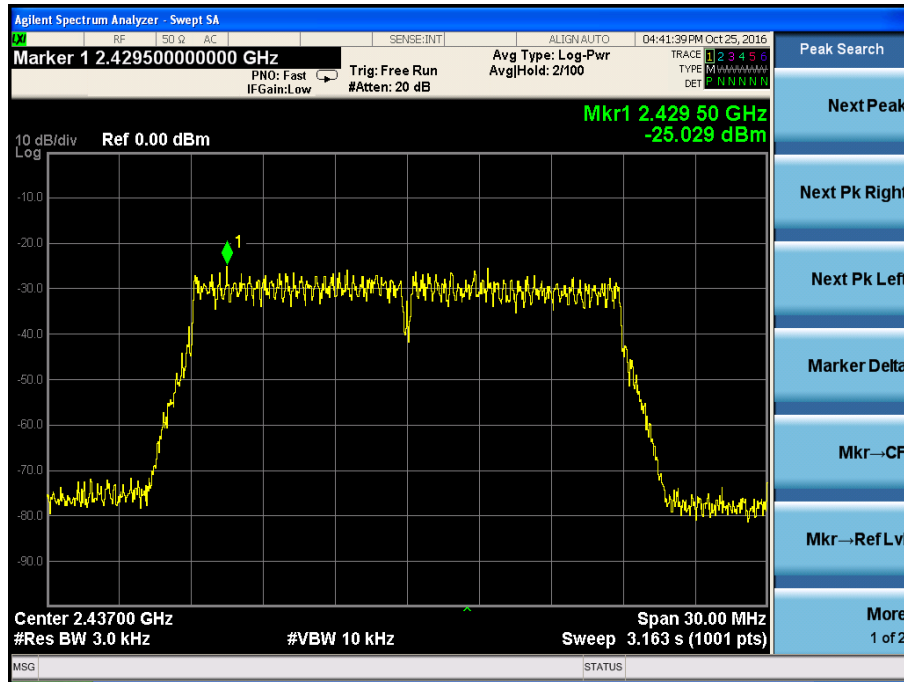

CH Hig:

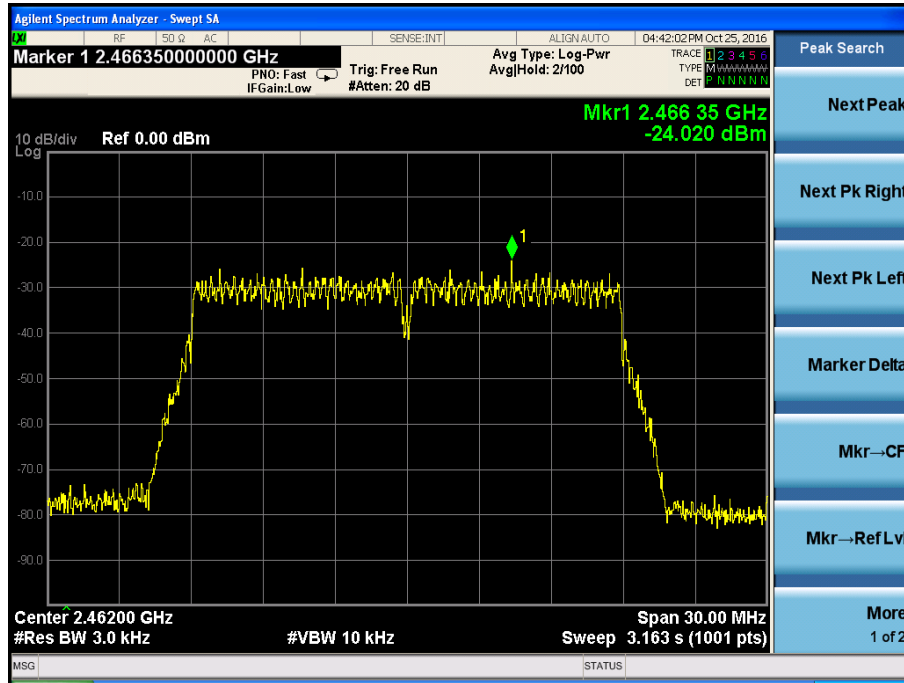

IEEE 802.11n HT40 :

CH Low :

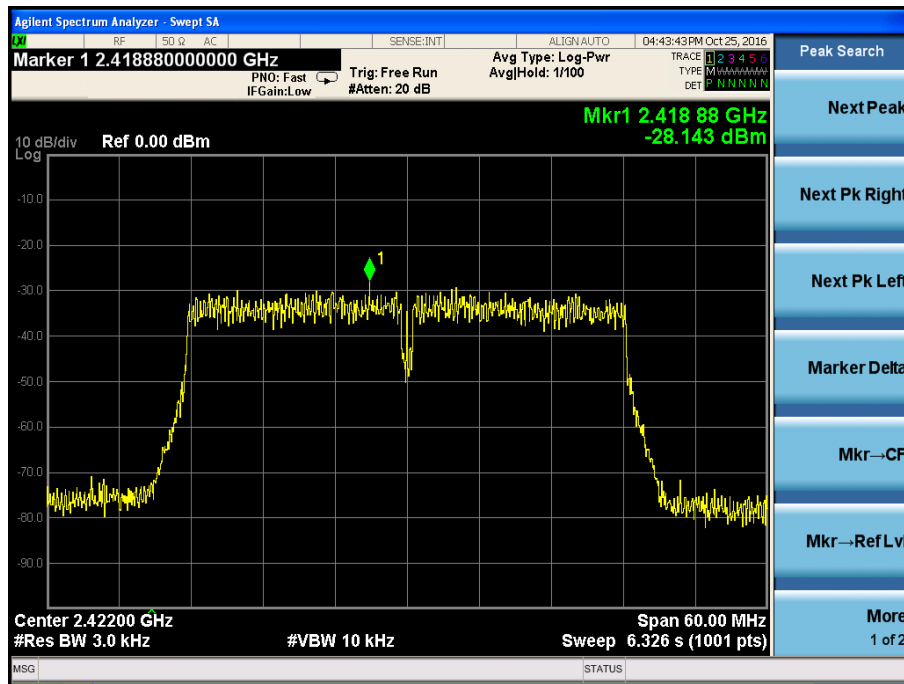

CH Mid:

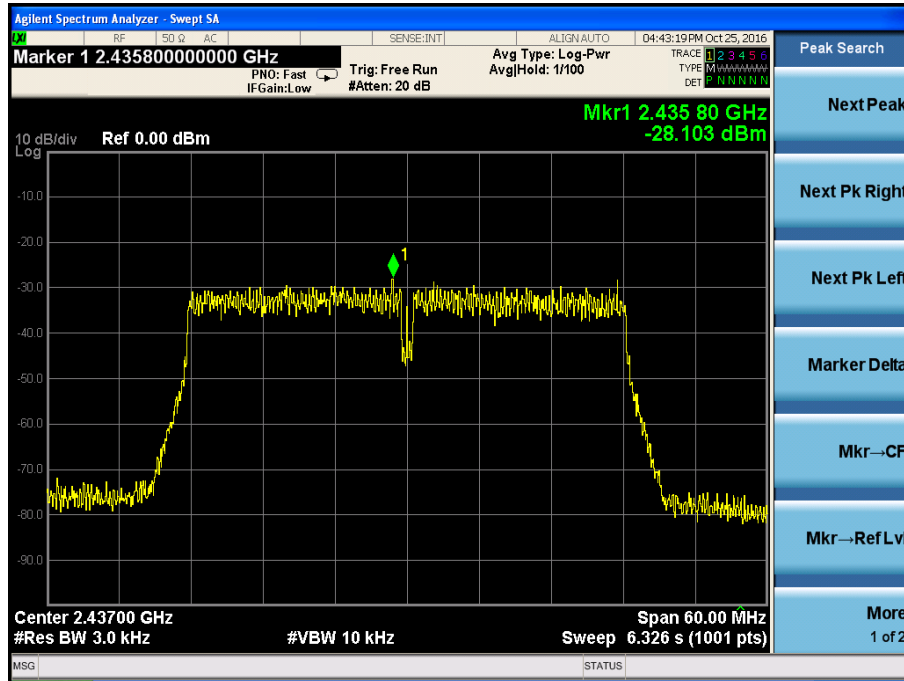

CH Hig:

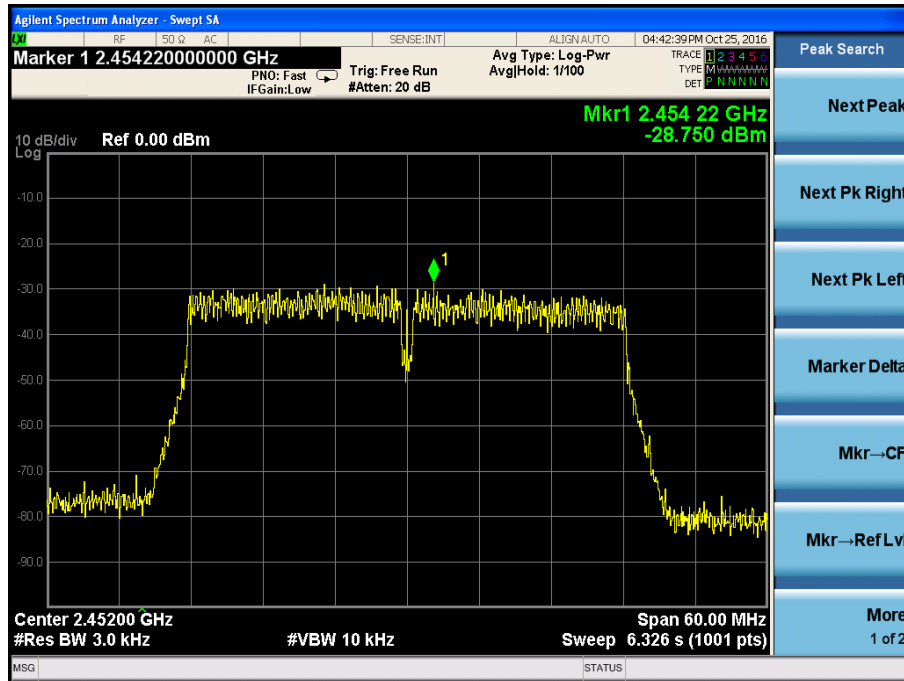

## 9 Bandwidth

### 9.1 Test limit

Please refer section 15.247

For direct sequence systems, the minimum 6dB bandwidth shall be at least 500 kHz.

### 9.2 Method of measurement

Details see the KDB558074 D01 Meas Guidance

- a) The bandwidth is measured at an amplitude level reduced 20dB from the reference level. The reference level is the level of the highest amplitude signal observed from the transmitter at the fundamental frequency. Once the reference level is established, the equipment is conditioned with typical modulating signal to produce the worst-case (i.e. the widest) bandwidth.
- b) The test receiver set  $RBW = 1-5 \% EBW$ ,  $VBW \geq 3RBW$ , Peak Detector, Sweep time set auto, detail see the test plot.

### 9.3 Test Setup

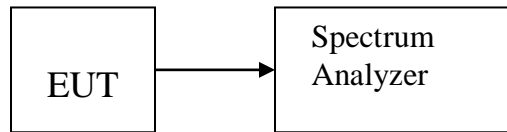

### 9.4 Test Results

PASS.

Detailed information please see the following page.

Channel	Frequency (MHz)	6dB Bandwidth (MHz)	99% Occupied Bandwidth (MHz)	Limit (MHz)	Result
IEEE 802.11b:					
Low	2412	10.11	14.221	0.5	PASS
Mid	2437	10.08	14.251	0.5	PASS
High	2462	10.08	14.216	0.5	PASS
IEEE 802.11g					
Low	2412	16.39	16.495	0.5	PASS
Mid	2437	16.41	16.486	0.5	PASS
High	2462	16.41	16.497	0.5	PASS
IEEE 802.11n/HT20:					
Low	2412	17.60	17.639	0.5	PASS
Mid	2437	17.62	17.635	0.5	PASS
High	2462	17.61	17.650	0.5	PASS
IEEE 802.11n/HT40:					
Low	2422	35.83	35.990	0.5	PASS
Mid	2437	35.76	36.000	0.5	PASS
High	2452	36.08	36.005	0.5	PASS

IEEE 802.11b:  
CH Low :

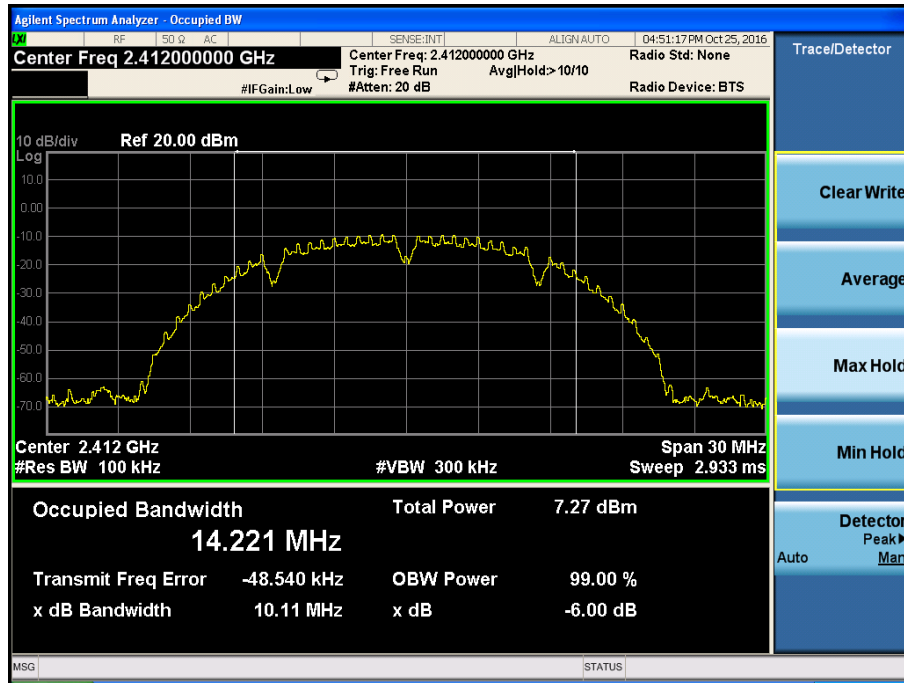

CH Mid :

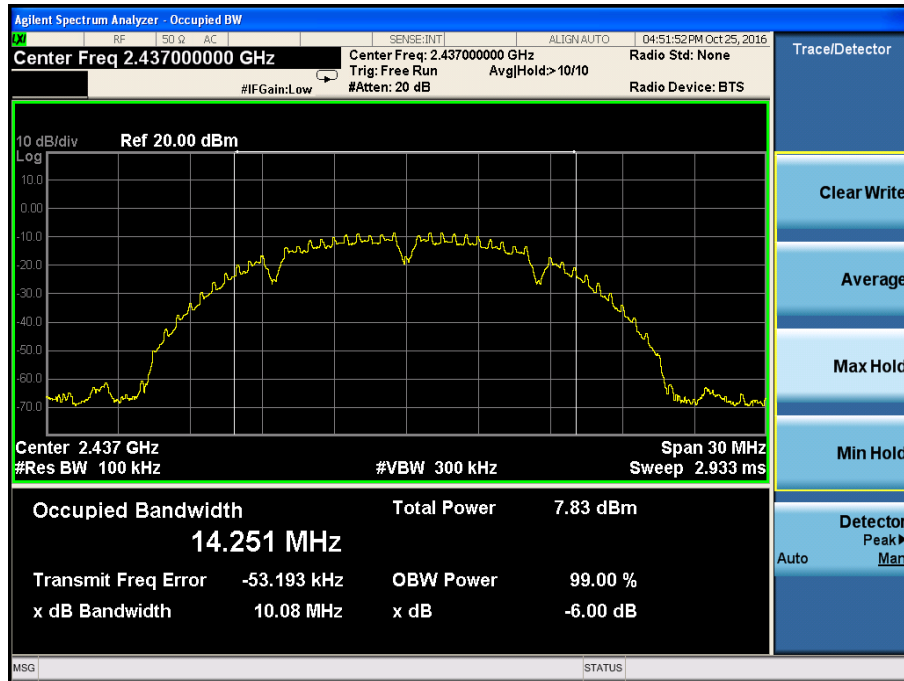

CH High :

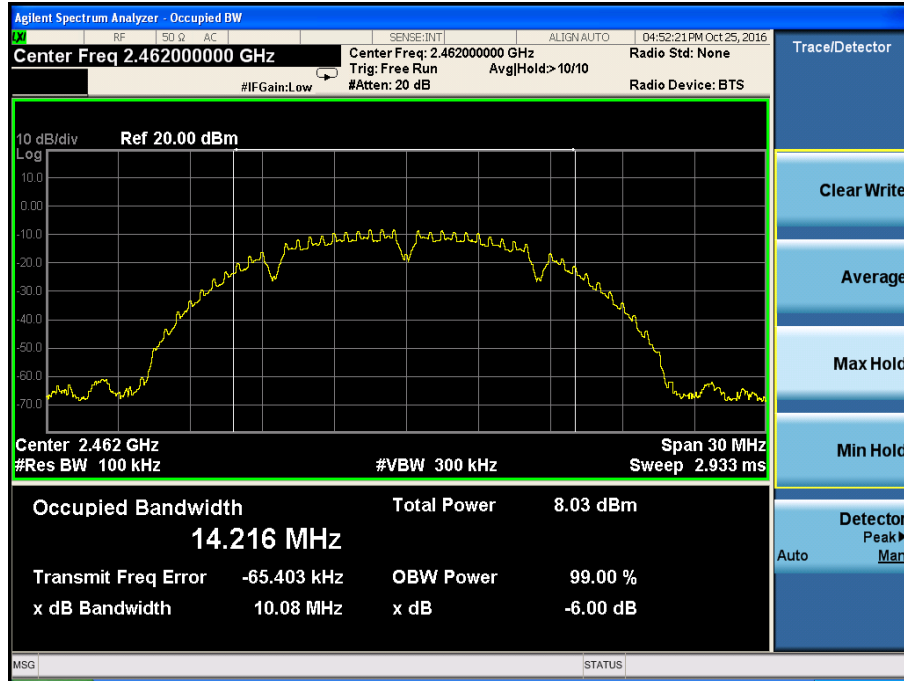

IEEE 802.11g:

CH Low :

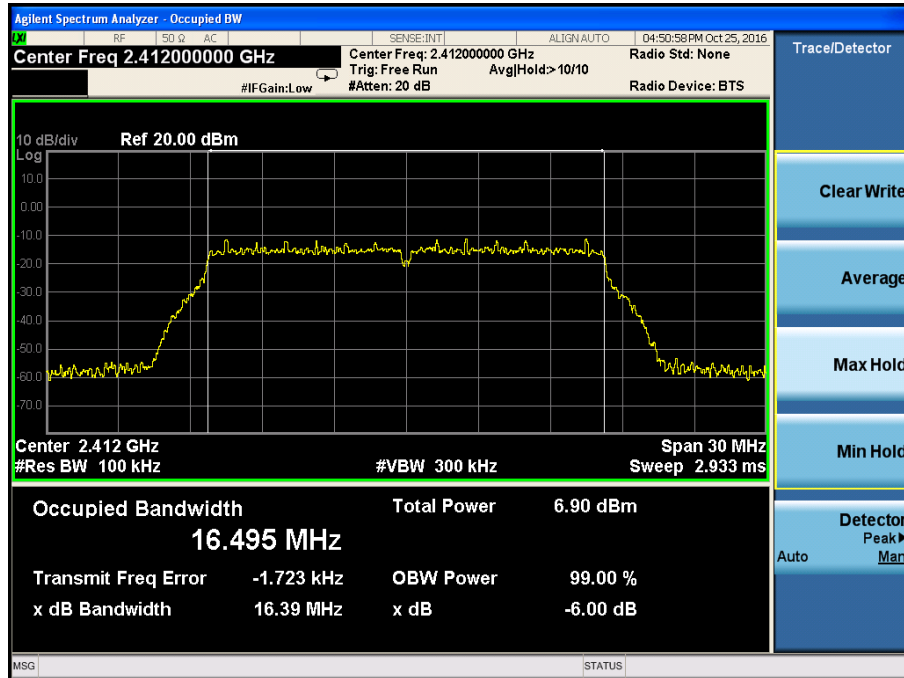

CH Mid:

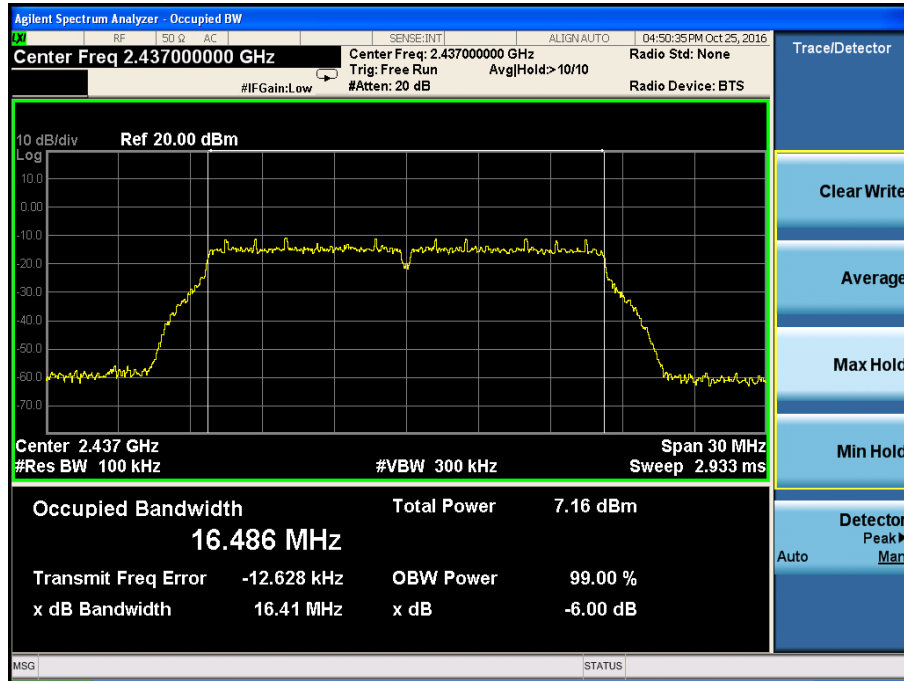

CH Hig:

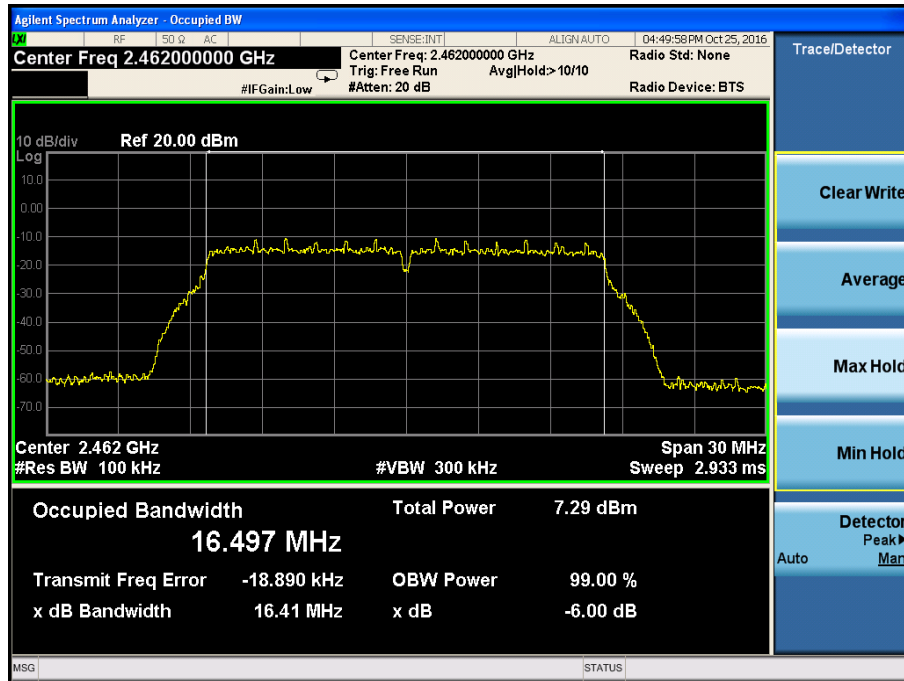



IEEE 802.11n HT20:  
CH Low :

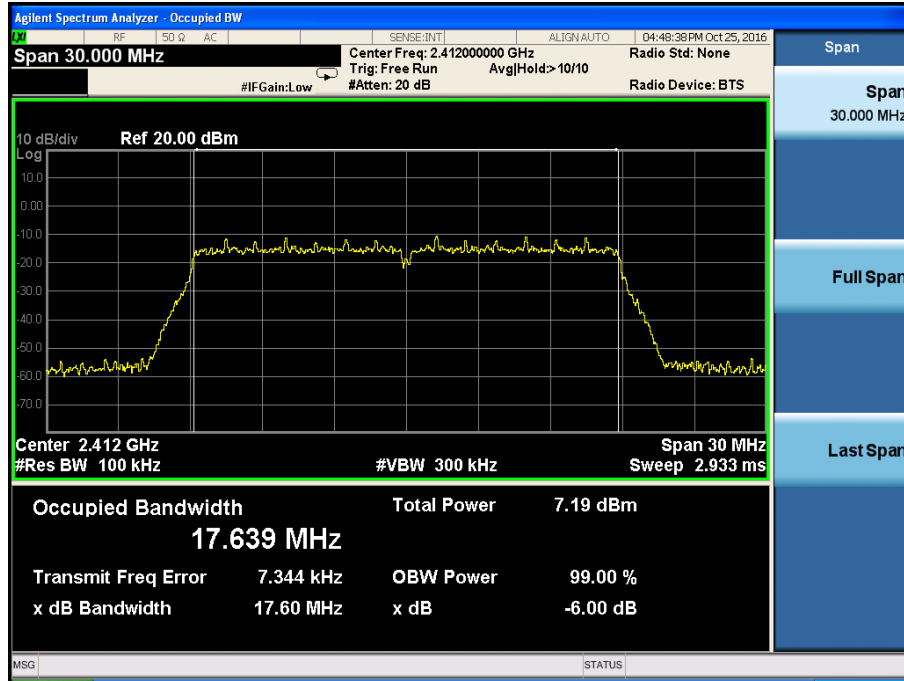

CH Mid :

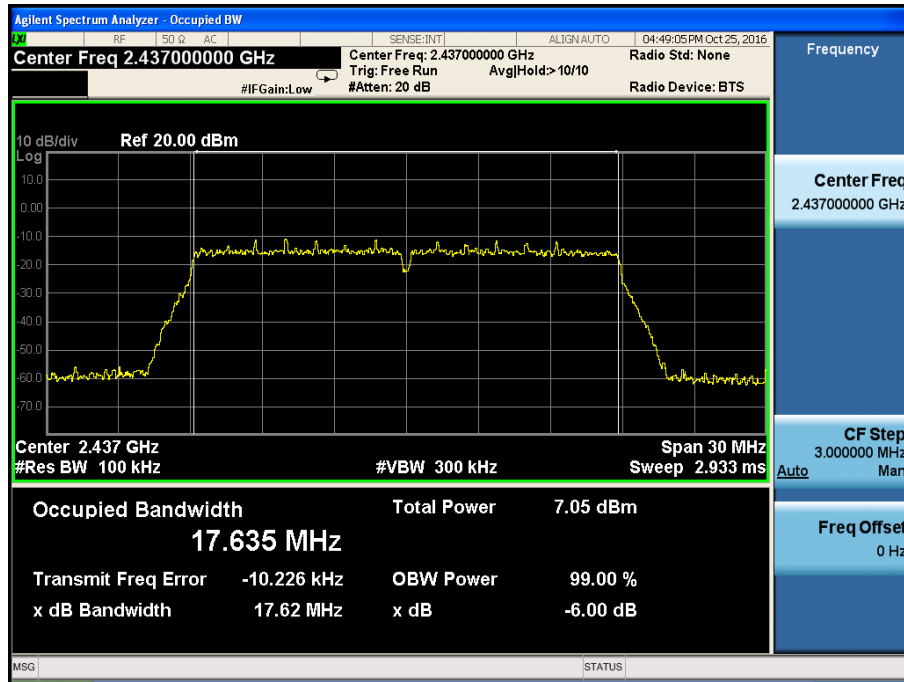

CH High :

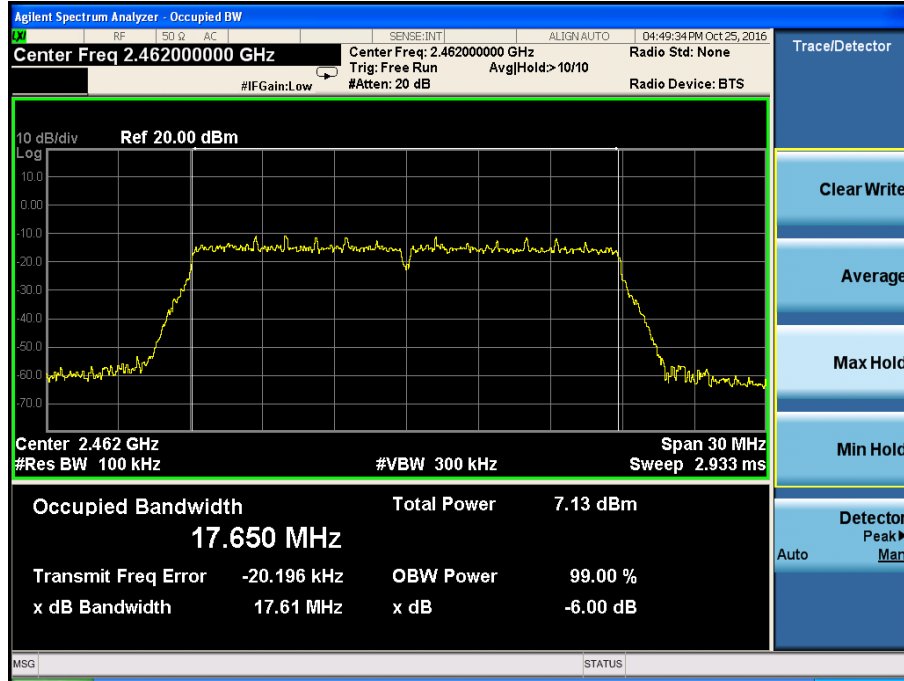

IEEE 802.11n/HT40:

CH Low :

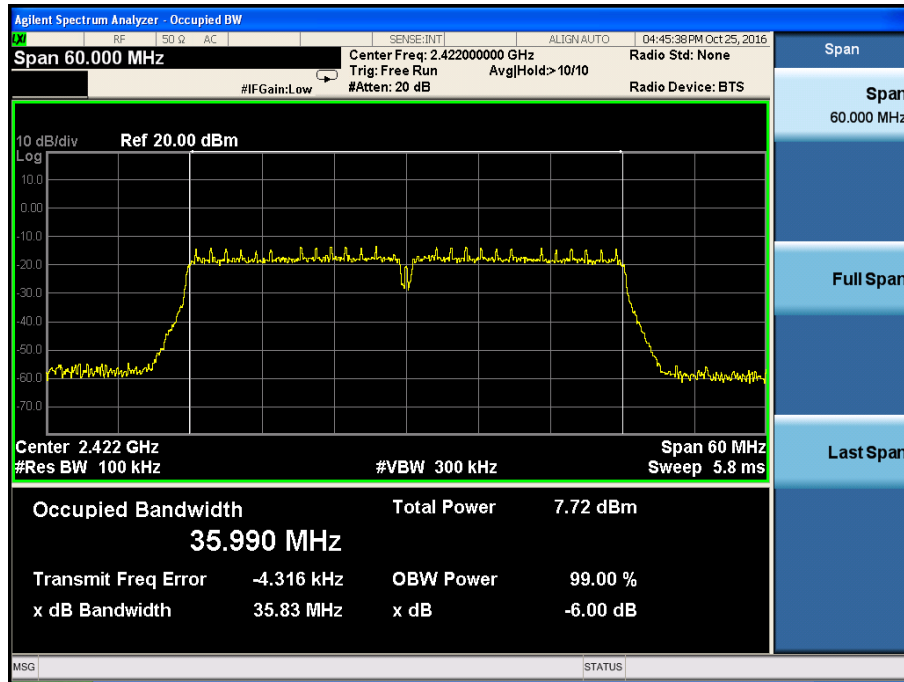

CH Mid:

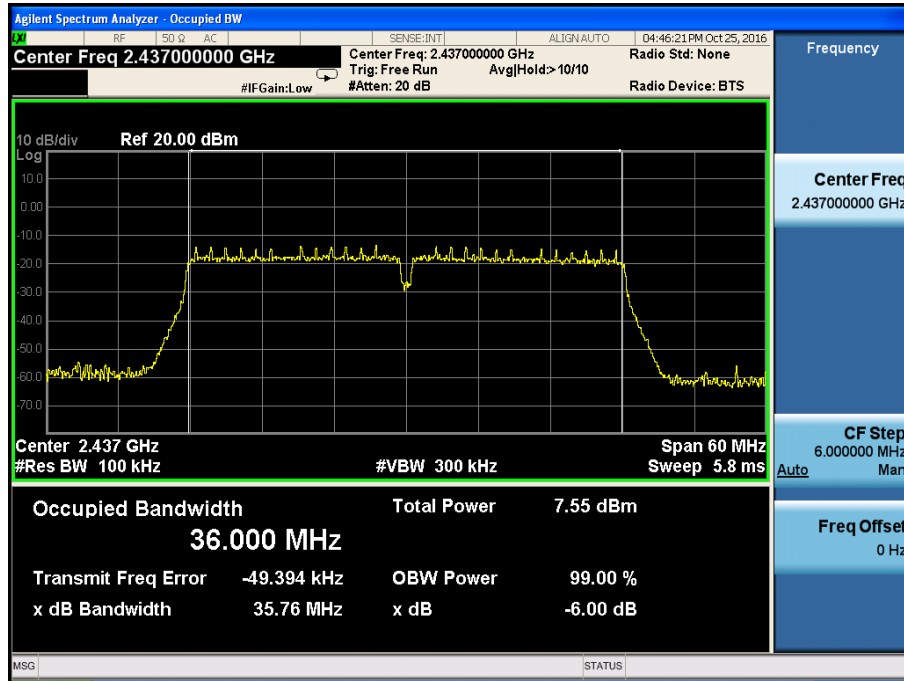

CH High :

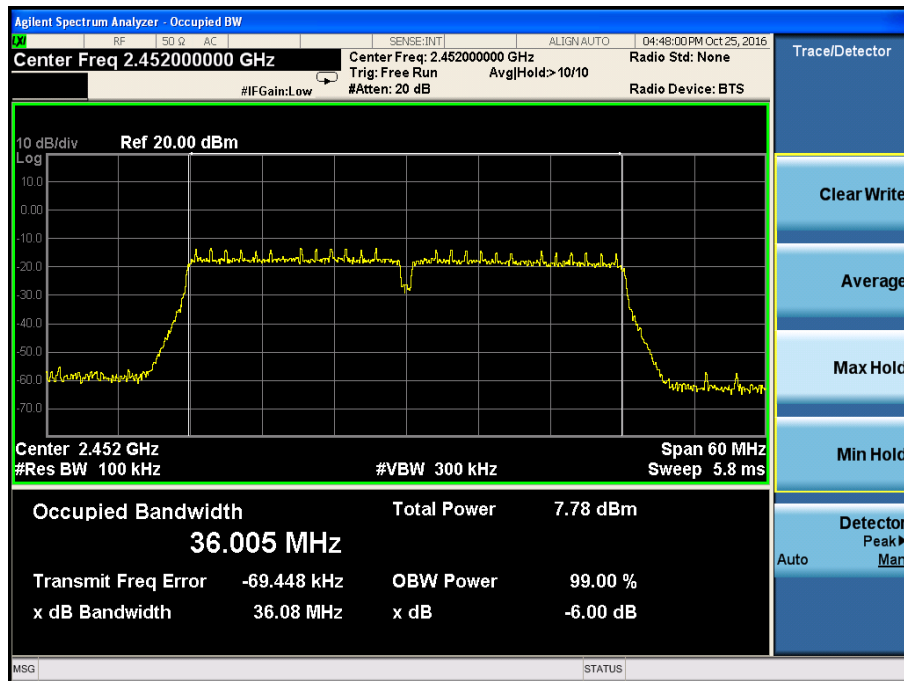

## 10 Band Edge Check

### 10.1 Test limit

Please refer section 15.247

All the lower and upper band-edges emissions appearing within 2310MHz to 2390MHz and 2483.5MHz to 2500MHz restricted frequency bands shall not exceed the limits shown in 15.209, all the other emissions outside operation frequency band 2400MHz to 2483.5MHz and 5725MHz to 5850MHz shall be at least 20dB below the fundamental emissions, or comply with 15.209 limits.

### 10.2 Test Procedure

12.2.1 Put the EUT on a 0.8m high table, power on the EUT. Emissions were scanned and measured rotating the EUT to 360 degrees, Find the maximum Emission

12.2.2 Check the spurious emissions out of band.

12.2.3 RBW 1MHz ,VBW 3MHz ,peak detector for peak value , RBW 1MHz ,VBW 3MHz , RMS detector for AV value.

### 10.3 Test Setup

Same as 5.2.2.

### 10.4 Test Result

PASS.

Detailed information please see the following page.

Radiated Method:  
IEEE 802.11b CH LOW

Band Edge Test result								
EUT: Mini 802.11ac Wireless USB Adapter					M/N: U0631			
Power: DC 5V From USB port								
Test date: 2016-10-25 Test site: 3m Chamber Tested by: Store								
Test mode: TX Low								
Antenna polarity: Vertical								
Freq (MHz)	Read Level (dBUV/m)	Antenna Factor (dB/m)	Cable loss(dB)	Amp Factor (dB)	Result (dBUV/m)	Limit (dBUV/m)	Margin (dB)	Remark
2390	43.28	27.62	3.92	34.97	39.85	74	34.15	<b>PK</b>
2390	--	27.62	3.92	34.97	--	54	--	<b>AV</b>
Antenna Polarity: Horizontal								
2390	41.91	27.62	3.92	34.97	38.48	74	35.52	<b>PK</b>
2390	--	27.62	3.92	34.97	--	54	--	<b>AV</b>
Note:								
1, Spectrum Set for PK measure: RBW=1MHz, VBW=1MHz, Sweep time=Auto, Detector: PK								
2, Spectrum Set for AV measure: RBW=1MHz, VBW=3MHz, Sweep time=Auto, Detector: RMS								
3, Result = Read level + Antenna factor + cable loss-Amp factor								
4, All the other emissions not reported were too low to read and deemed to comply with FCC limit.								

## IEEE 802.11b CH High

Band Edge Test result								
EUT: Mini 802.11ac Wireless USB Adapter					M/N: U0631			
Power: DC 5V From USB port								
Test date: 2016-10-25 Test site: 3m Chamber Tested by: Store								
Test mode: TX High								
Antenna polarity: Vertical								
Freq (MHz)	Read Level (dBUV/m)	Antenna Factor (dB/m)	Cable loss(dB)	Amp Factor (dB)	Result (dBUV/m)	Limit (dBUV/m)	Margin (dB)	Remark
2483.5	43.12	27.89	4	34.97	40.04	74	33.96	<b>PK</b>
2483.5	--	27.89	4	34.97	--	54	--	AV
Antenna Polarity: Horizontal								
2483.5	42.32	27.89	4	34.97	39.24	74	34.76	<b>PK</b>
2483.5	--	27.89	4	34.97	--	54	--	AV
Note:								
1, Spectrum Set for PK measure: RBW=1MHz, VBW=1MHz, Sweep time=Auto, Detector: PK								
2, Spectrum Set for AV measure: RBW=1MHz, VBW=3MHz, Sweep time=Auto, Detector: RMS								
3, Result = Read level + Antenna factor + cable loss-Amp factor								
4, All the other emissions not reported were too low to read and deemed to comply with FCC limit.								

IEEE 802.11g CH LOW

Band Edge Test result								
EUT: Mini 802.11ac Wireless USB Adapter					M/N: U0631			
Power: DC 5V From USB port								
Test date: 2016-10-25			Test site: 3m Chamber		Tested by: Store			
Test mode: TX Low								
Antenna polarity: Vertical								
Freq (MHz)	Read Level (dBUV/m)	Antenna Factor (dB/m)	Cable loss(dB)	Amp Factor (dB)	Result (dBUV/m)	Limit (dBUV/m)	Margin (dB)	Remark
2390	41.78	27.62	3.92	34.97	38.35	74	35.65	<b>PK</b>
2390	--	27.62	3.92	34.97	--	54	--	AV
Antenna Polarity: Horizontal								
2390	42.73	27.62	3.92	34.97	39.3	74	34.7	<b>PK</b>
2390	--	27.62	3.92	34.97	--	54	--	AV
Note:								
1, Spectrum Set for PK measure: RBW=1MHz, VBW=1MHz, Sweep time=Auto, Detector: PK								
2, Spectrum Set for AV measure: RBW=1MHz, VBW=3MHz, Sweep time=Auto, Detector: RMS								
3, Result = Read level + Antenna factor + cable loss-Amp factor								
4, All the other emissions not reported were too low to read and deemed to comply with FCC limit.								

IEEE 802.11g CH High

Band Edge Test result								
EUT: Mini 802.11ac Wireless USB Adapter					M/N: U0631			
Power: DC 5V From USB port								
Test date: 2016-10-25			Test site: 3m Chamber		Tested by: Store			
Test mode: TX High								
Antenna polarity: Vertical								
Freq (MHz)	Read Level (dBUV/m)	Antenna Factor (dB/m)	Cable loss(dB)	Amp Factor (dB)	Result (dBUV/m)	Limit (dBUV/m)	Margin (dB)	Remark
2483.5	42.25	27.89	4	34.97	39.17	74	34.83	<b>PK</b>
2483.5		--	--	--	--	54	--	AV
Antenna Polarity: Horizontal								
2483.5	42.47	27.89	4	34.97	39.39	74	34.61	<b>PK</b>
2483.5		--	--	--	--	54	--	AV
Note:								
1, Spectrum Set for PK measure: RBW=1MHz, VBW=1MHz, Sweep time=Auto, Detector: PK								
2, Spectrum Set for AV measure: RBW=1MHz, VBW=3MHz, Sweep time=Auto, Detector: RMS								
3, Result = Read level + Antenna factor + cable loss-Amp factor								
4, All the other emissions not reported were too low to read and deemed to comply with FCC limit.								



IEEE 802.11n HT20 CH Low

Band Edge Test result								
EUT: Mini 802.11ac Wireless USB Adapter					M/N: U0631			
Power: DC 5V From USB port								
Test date: 2016-10-25 Test site: 3m Chamber Tested by: Store								
Test mode: TX Low								
Antenna polarity: Vertical								
Freq (MHz)	Read Level (dBUV/m)	Antenna Factor (dB/m)	Cable loss(dB)	Amp Factor (dB)	Result (dBUV/m)	Limit (dBUV/m)	Margin (dB)	Remark
2390	42.55	27.62	3.92	34.97	39.12	74	34.88	<b>PK</b>
2390	--	27.62	3.92	34.97	--	54	--	AV
Antenna Polarity: Horizontal								
2390	42.87	27.62	3.92	34.97	39.44	74	34.56	<b>PK</b>
2390	--	27.62	3.92	34.97	--	54	--	AV
Note: 1, Spectrum Set for PK measure: RBW=1MHz, VBW=1MHz, Sweep time=Auto, Detector: PK 2, Spectrum Set for AV measure: RBW=1MHz, VBW=3MHz, Sweep time=Auto, Detector: RMS 3, Result = Read level + Antenna factor + cable loss-Amp factor 4, All the other emissions not reported were too low to read and deemed to comply with FCC limit.								

## IEEE 802.11n HT20 CH High

Band Edge Test result								
EUT: Mini 802.11ac Wireless USB Adapter					M/N: U0631			
Power: DC 5V From USB port								
Test date: 2016-10-25 Test site: 3m Chamber Tested by: Store								
Test mode: TX High								
Antenna polarity: Vertical								
Freq (MHz)	Read Level (dBUV/m)	Antenna Factor (dB/m)	Cable loss(dB)	Amp Factor (dB)	Result (dBUV/m)	Limit (dBUV/m)	Margin (dB)	Remark
2483.5	41.96	27.89	4	34.97	38.88	74	35.12	PK
2483.5		--	--	--	--	54	--	AV
Antenna Polarity: Horizontal								
2483.5	42.4	27.89	4	34.97	39.32	74	34.68	PK
2483.5		--	--	--	--	54	--	AV
Note:								
1, Spectrum Set for PK measure: RBW=1MHz, VBW=1MHz, Sweep time=Auto, Detector: PK								
2, Spectrum Set for AV measure: RBW=1MHz, VBW=3MHz, Sweep time=Auto, Detector: RMS								
3, Result = Read level + Antenna factor + cable loss-Amp factor								
4, All the other emissions not reported were too low to read and deemed to comply with FCC limit.								

IEEE 802.11n HT40 CH Low

Band Edge Test result								
EUT: Mini 802.11ac Wireless USB Adapter					M/N: U0631			
Power: DC 5V From USB port								
Test date: 2016-10-25 Test site: 3m Chamber Tested by: Store								
Test mode: TX Low								
Antenna polarity: Vertical								
Freq (MHz)	Read Level (dBUV/m)	Antenna Factor (dB/m)	Cable loss(dB)	Amp Factor (dB)	Result (dBUV/m)	Limit (dBUV/m)	Margin (dB)	Remark
2390	42.55	27.62	3.92	34.97	39.12	74	34.88	<b>PK</b>
2390	--	27.62	3.92	34.97	--	54	--	AV
Antenna Polarity: Horizontal								
2390	42.51	27.62	3.92	34.97	39.08	74	34.92	<b>PK</b>
2390	--	27.62	3.92	34.97	--	54	--	AV
Note:								
1, Spectrum Set for PK measure: RBW=1MHz, VBW=1MHz, Sweep time=Auto, Detector: PK								
2, Spectrum Set for AV measure: RBW=1MHz, VBW=3MHz, Sweep time=Auto, Detector: RMS								
3, Result = Read level + Antenna factor + cable loss-Amp factor								
4, All the other emissions not reported were too low to read and deemed to comply with FCC limit.								

IEEE 802.11n HT40 CH High

Band Edge Test result								
EUT: Mini 802.11ac Wireless USB Adapter					M/N: U0631			
Power: DC 5V From USB port								
Test date: 2016-10-25 Test site: 3m Chamber Tested by: Store								
Test mode: TX High								
Antenna polarity: Vertical								
Freq (MHz)	Read Level (dBUV/m)	Antenna Factor (dB/m)	Cable loss(dB)	Amp Factor (dB)	Result (dBUV/m)	Limit (dBUV/m)	Margin (dB)	Remark
2483.5	41.8	27.89	4	34.97	38.72	74	35.28	PK
2483.5		--	--	--	--	54	--	AV
Antenna Polarity: Horizontal								
2483.5	42.57	27.89	4	34.97	39.49	74	34.51	PK
2483.5		--	--	--	--	54	--	AV
Note:								
1, Spectrum Set for PK measure: RBW=1MHz, VBW=1MHz, Sweep time=Auto, Detector: PK								
2, Spectrum Set for AV measure: RBW=1MHz, VBW=3MHz, Sweep time=Auto, Detector: RMS								
3, Result = Read level + Antenna factor + cable loss-Amp factor								
4, All the other emissions not reported were too low to read and deemed to comply with FCC limit.								

802.11b

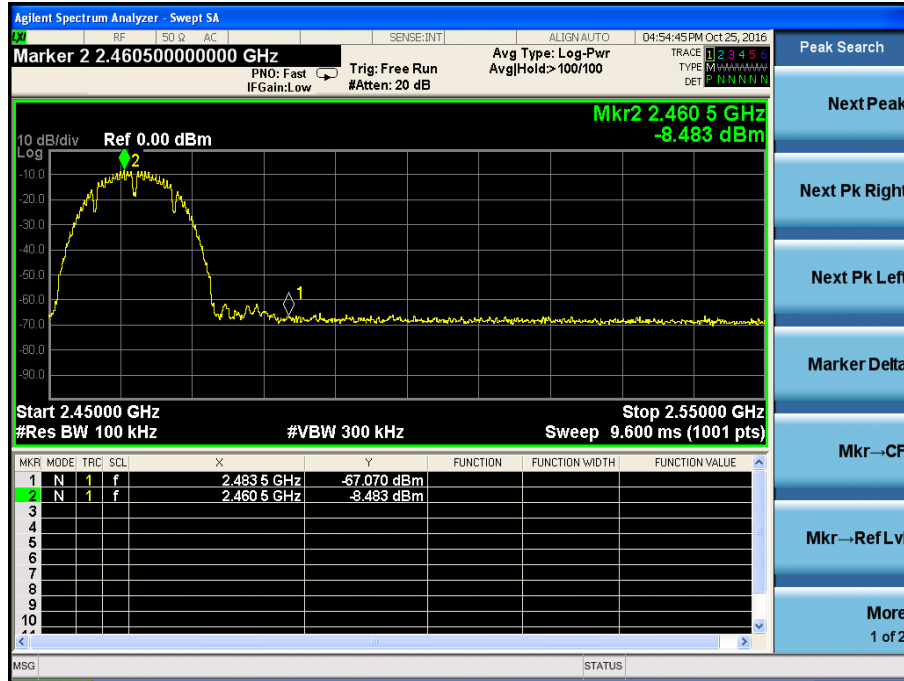
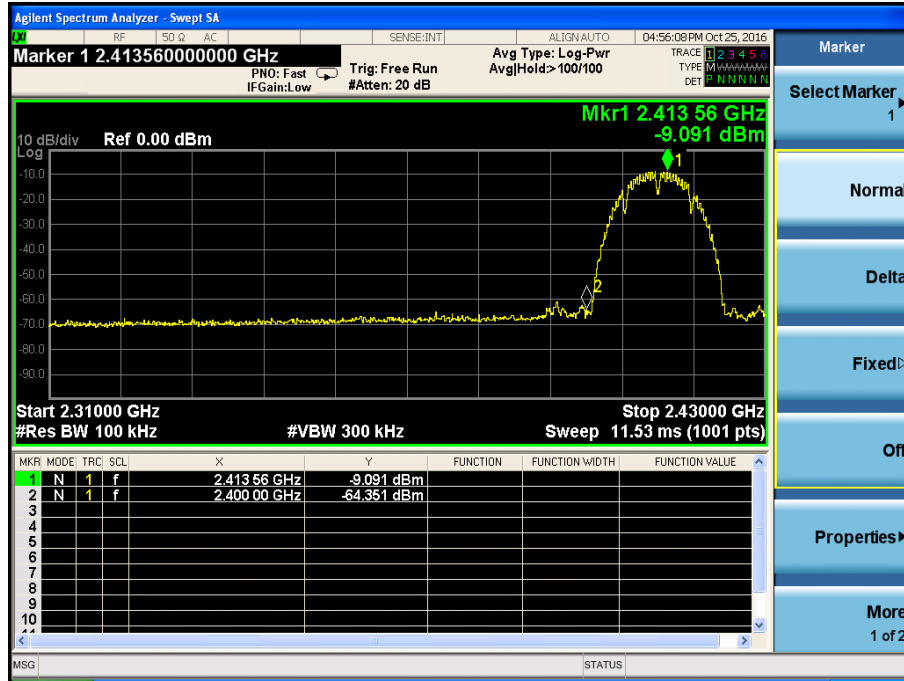

802.11g

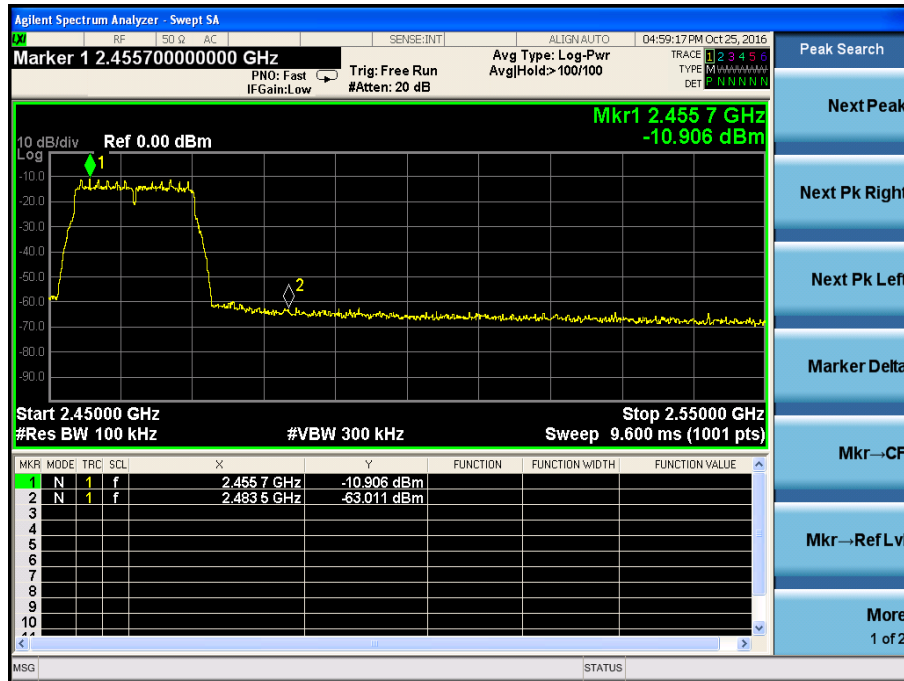
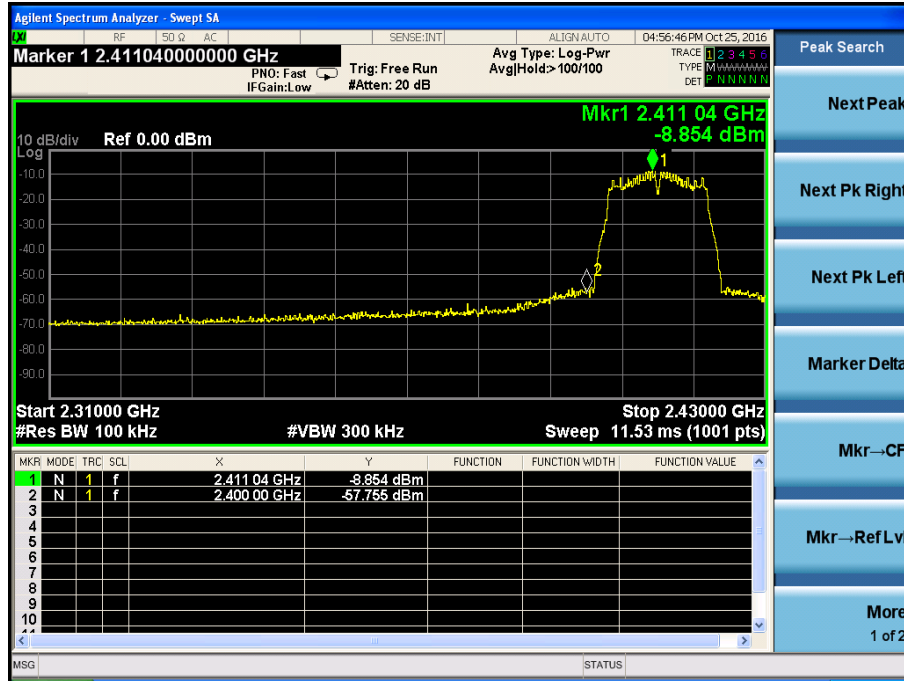

802.11n HT20

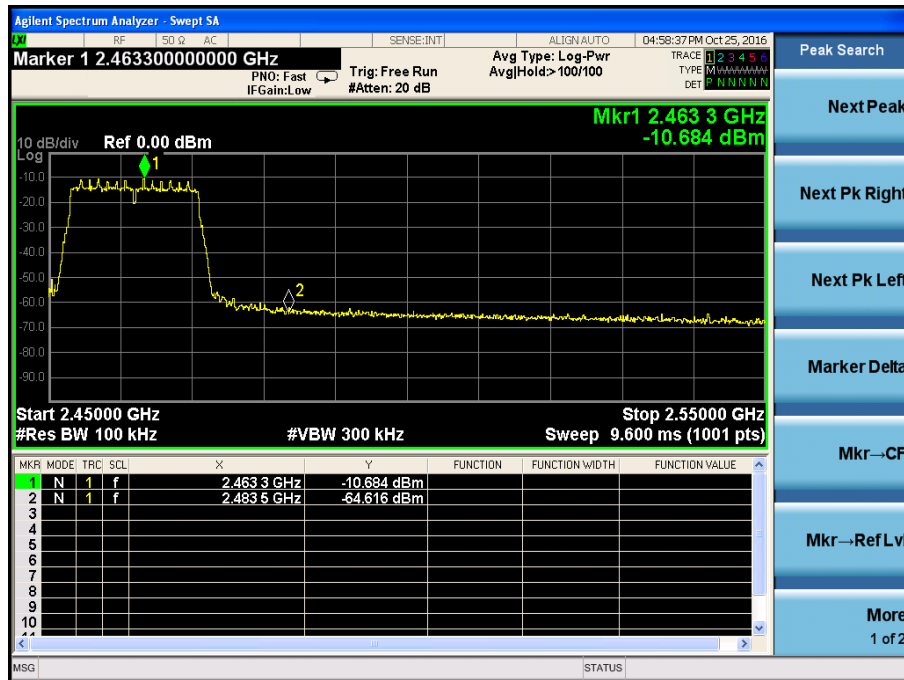
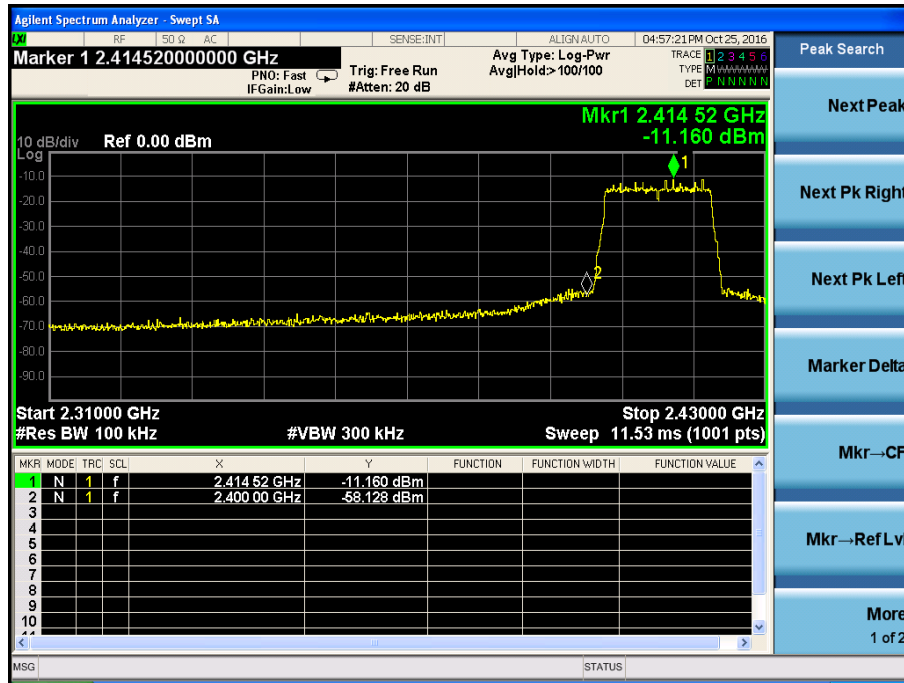





## 11 Antenna Requirement

### 11.1 Standard Requirement

An intentional radiator shall be designed to ensure that no antenna other than that furnished by the responsible party shall be used with the device. The use of a permanently attached antenna or of an antenna that uses a unique coupling to the intentional radiator shall be considered sufficient to comply with the provisions of this Section. The manufacturer may design the unit so that a broken antenna can be replaced by the user, but the use of a standard antenna jack or electrical connector is prohibited.

### 11.2 Antenna Connected Construction

The antenna connector is unique antenna and no consideration of replacement. Please see EUT photo for details.

### 11.3 Result

The EUT antenna is unique Antenna. It comply with the standard requirement.

## 12 Test setup photo

### 12.1 Photos of Radiated emission

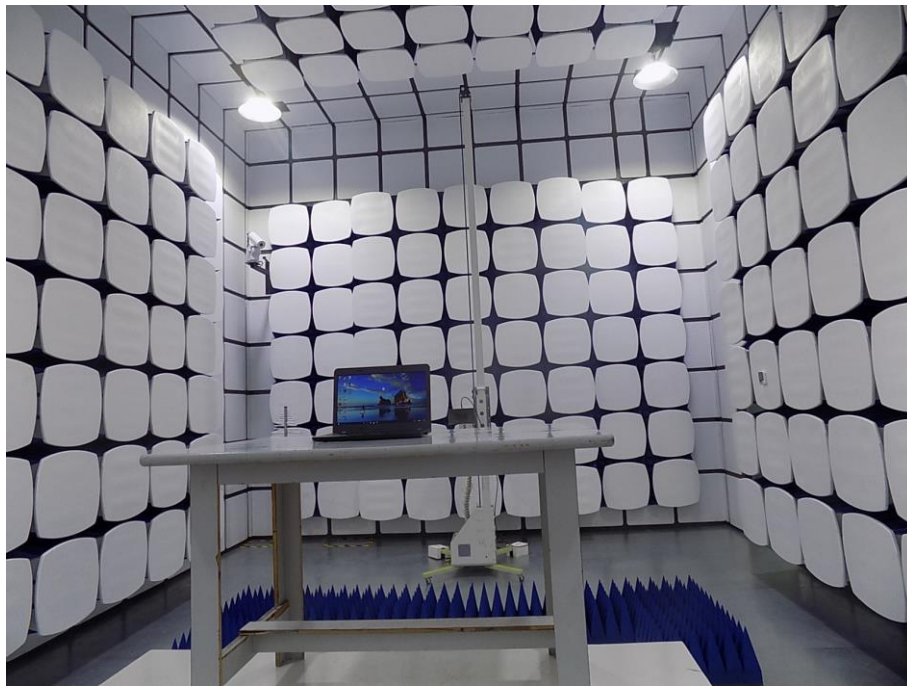
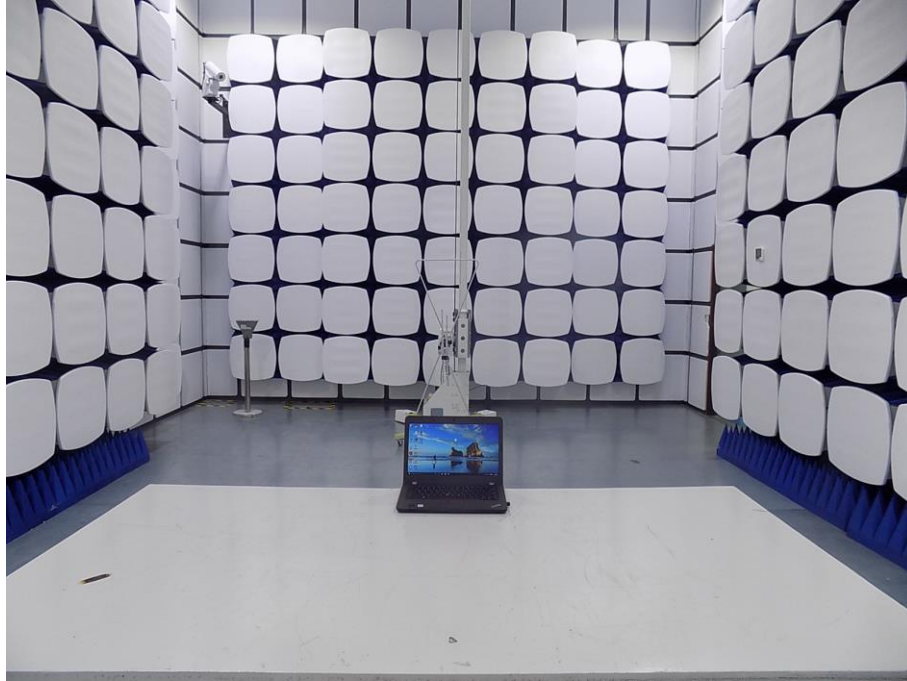

12.2 Photos of Conducted Emission test

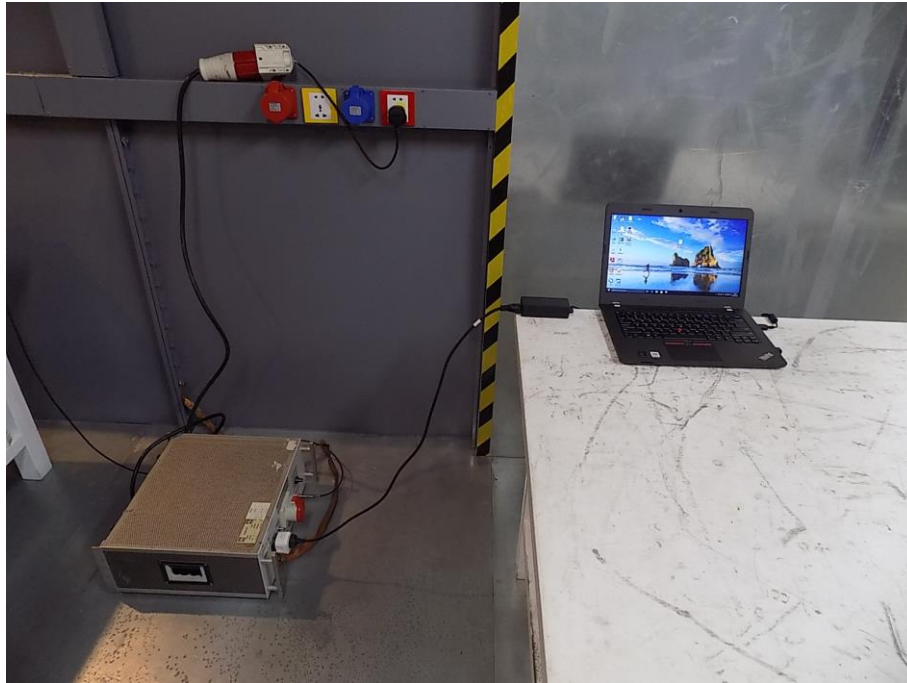

### 13 Photographs of EUT

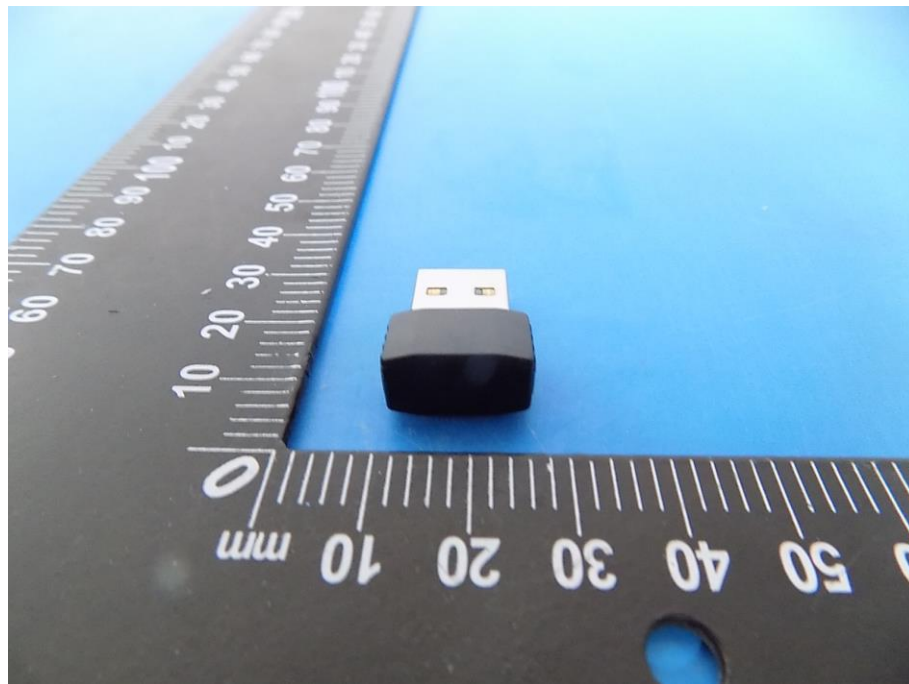
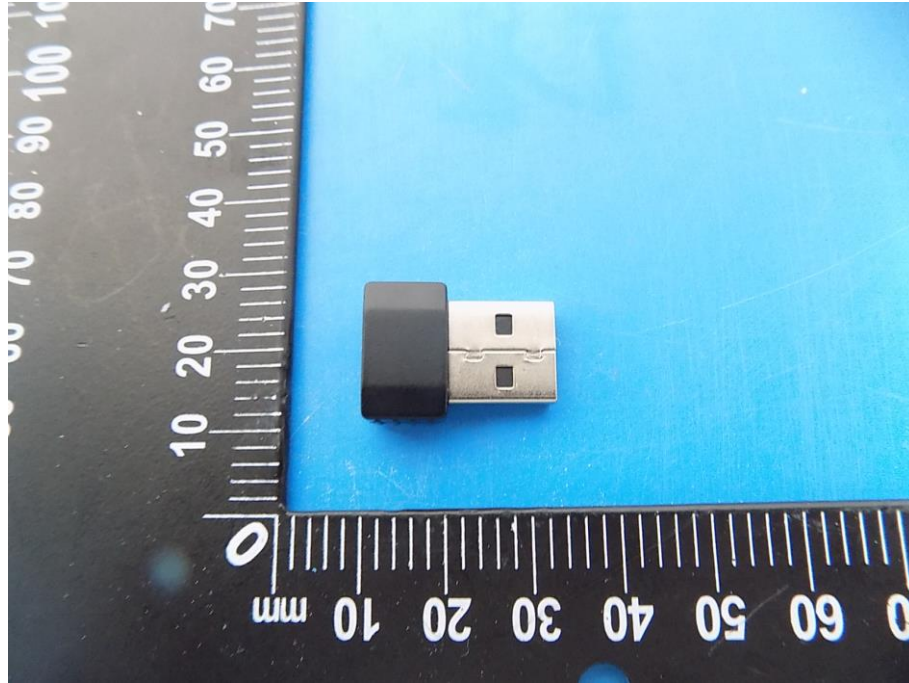

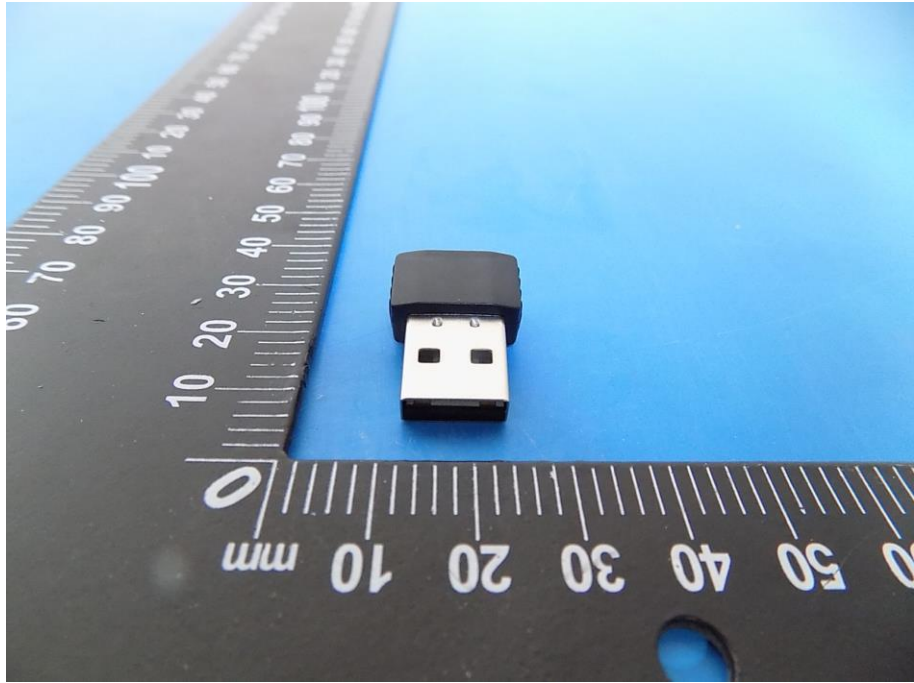
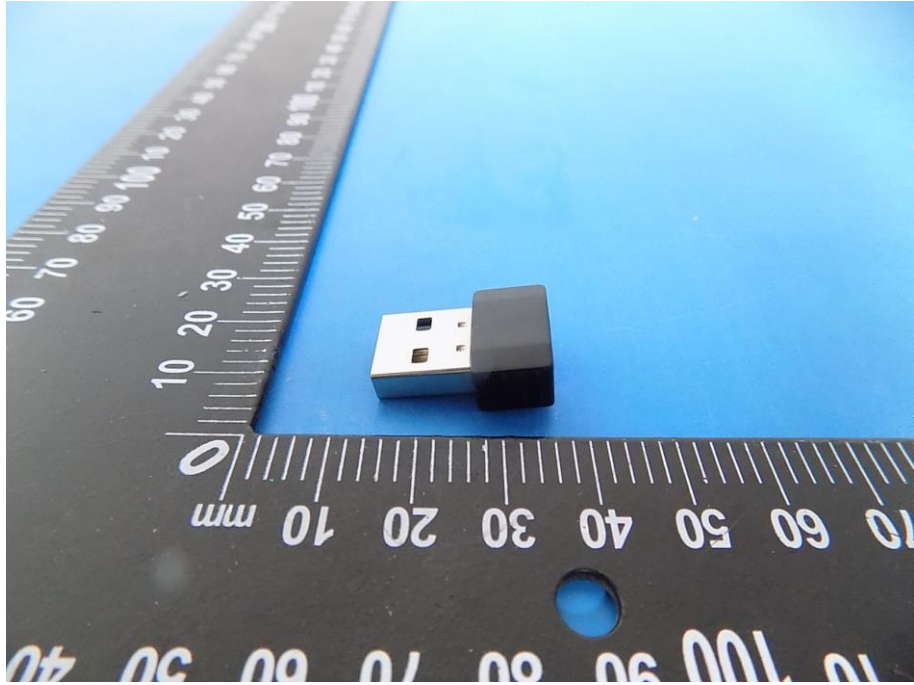

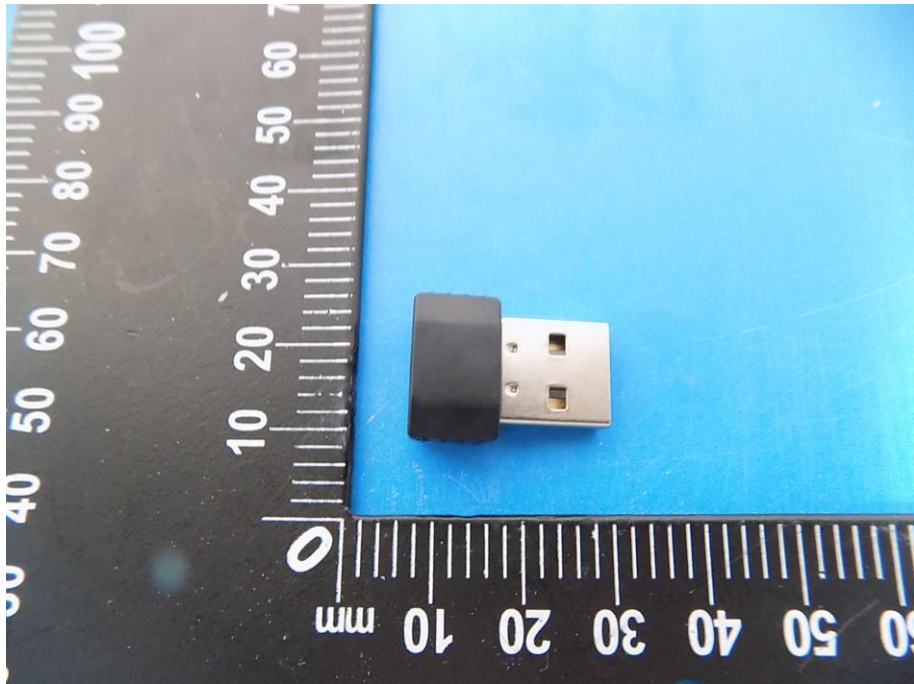
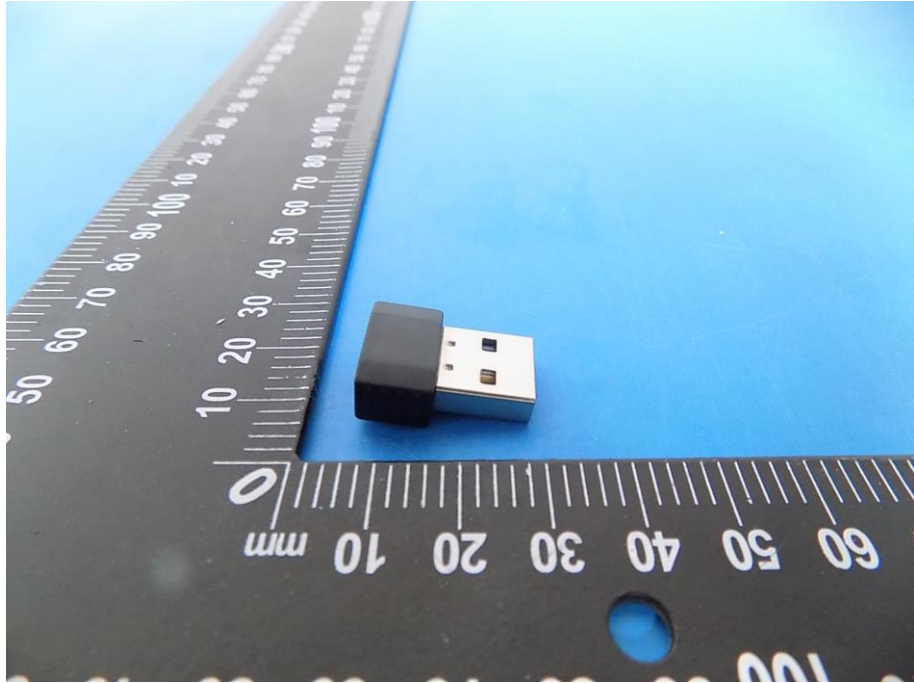

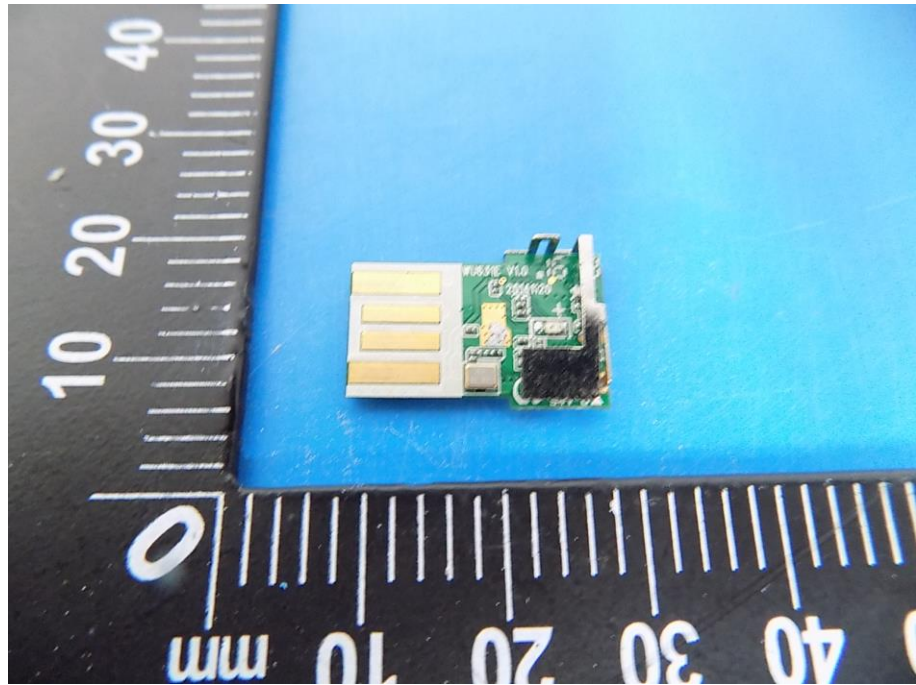
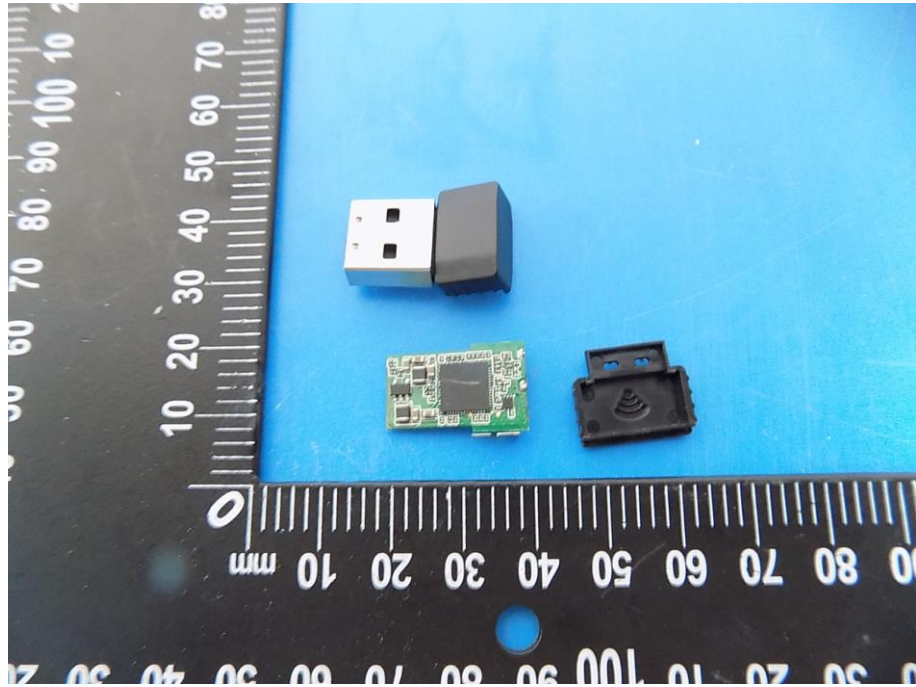

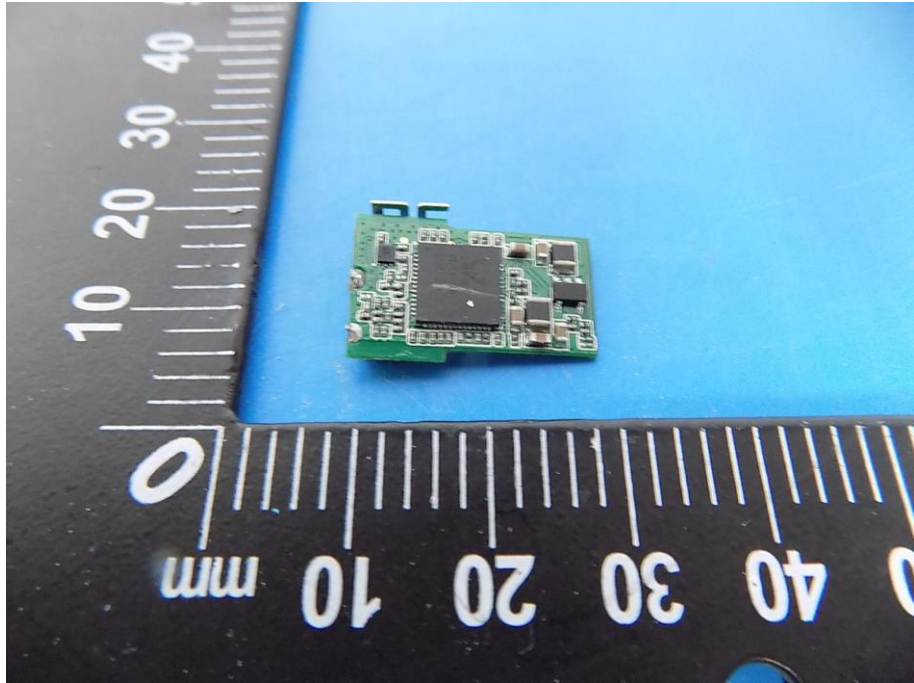

-----END OF THE REPORT-----