



FCC TEST REPORT

FCC ID: 2AAD8-PA1002T

On Behalf of

HAOLIYUAN (SHENZHEN) ELECTRONIC CO., LTD

Smart Plug

Model No.: PA1002T, PA1002E

Prepared for : HAOLIYUAN (SHENZHEN) ELECTRONIC CO., LTD
Address : 3/F, Building A1, Junfeng Industrial Park Yonghe Road, Fuyong,
Bao'an District, Shenzhen, Guangdong, China

Prepared By : Shenzhen Alpha Product Testing Co., Ltd.
Address : Building i, No.2, Lixin Road, Fuyong Street, Bao'an District, 518103,
Shenzhen, Guangdong, China

Report Number : T1881561 01
Date of Receipt : September 30, 2018
Date of Test : September 30, 2018-October 22, 2018
Date of Report : October 22, 2018
Version Number : REV0

TABLE OF CONTENTS

| Description | Page |
|--|-----------|
| 1. Summary of Standards And Results----- | 6 |
| 1.1. Description of Standards and Results ----- | 6 |
| 2. General Information ----- | 7 |
| 2.1. Description of Device (EUT)----- | 7 |
| 2.2. Accessories of Device (EUT) ----- | 8 |
| 2.3. Tested Supporting System Details ----- | 8 |
| 2.4. Block Diagram of connection between EUT and simulators----- | 8 |
| 2.5. Test Mode Description----- | 9 |
| 2.6. Test Conditions ----- | 10 |
| 2.7. Test Facility----- | 10 |
| 2.8. Measurement Uncertainty ----- | 11 |
| 2.9. Test Equipment List ----- | 12 |
| 3. Spurious Emission ----- | 13 |
| 3.1. Test Limits ----- | 13 |
| 3.2. Test Procedure ----- | 13 |
| 3.3. Test Setup----- | 14 |
| 3.4. Test Results ----- | 15 |
| 4. Power line Conducted Emission ----- | 22 |
| 4.1. Test Limits ----- | 22 |
| 4.2. Test Procedure ----- | 22 |
| 4.3. Test Setup----- | 22 |
| 4.4. Test Results ----- | 23 |
| 5. Conducted Maximum Output Power ----- | 25 |
| 5.1. Test limits----- | 25 |
| 5.2. Test Procedure ----- | 25 |
| 5.3. Test Setup----- | 25 |
| 5.4. Test Results ----- | 25 |
| 6. Peak Power Spectral Density ----- | 27 |
| 6.1. Test limits----- | 27 |
| 6.2. Test Procedure ----- | 27 |
| 6.3. Test Setup----- | 27 |
| 6.4. Test Results ----- | 28 |
| 7. Bandwidth ----- | 31 |
| 7.1. Test limits----- | 31 |
| 7.2. Test Procedure ----- | 31 |
| 7.3. Test Setup----- | 31 |
| 7.4. Test Results ----- | 31 |
| 8. Band Edge Check ----- | 35 |
| 8.1. Test limits----- | 35 |
| 8.2. Test Procedure ----- | 35 |
| 8.3. Test Setup----- | 35 |
| 8.4. Test Results ----- | 35 |

| | |
|---|-----------|
| 9. Antenna Requirement | 42 |
| 9.1. Standard Requirement | 42 |
| 9.2. Antenna Connected Construction | 42 |
| 9.3. Results | 42 |
| 10. Test setup photo | 43 |
| 10.1. Photos of Radiated emission | 43 |
| 10.2. Photos of Conducted Emission test | 44 |
| 11. EUT photo | 45 |

TEST REPORT DECLARATION

Applicant : HAOLIYUAN (SHENZHEN) ELECTRONIC CO., LTD
 Address : 3/F, Building A1, Junfeng Industrial Park Yonghe Road, Fuyong, Bao'an District, Shenzhen, Guangdong, China
 Manufacturer : HAOLIYUAN (SHENZHEN) ELECTRONIC CO., LTD
 Address : 3/F, Building A1, Junfeng Industrial Park Yonghe Road, Fuyong, Bao'an District, Shenzhen, Guangdong, China
 EUT Description : Smart Plug
 (A) Model No. : PA1002T, PA1002E
 (B) Trademark : N/A

Measurement Standard Used:

FCC Rules and Regulations Part 15 Subpart C Section 15.247: 2017, ANSI C63.10:2013

The device described above is tested by Shenzhen Alpha Product Testing Co., Ltd. to determine the maximum emission levels emanating from the device. The maximum emission levels are compared to the FCC Part 15 Subpart C limits both conducted and radiated emissions. The test results are contained in this test report and Shenzhen Alpha Product Testing Co., Ltd. is assumed of full responsibility for the accuracy and completeness of these tests.

After the test, our opinion is that EUT compliance with the requirement of the above standards.

This report applies to above tested sample only. This report shall not be reproduced in parts without written approval of Shenzhen Alpha Product Testing Co., Ltd.

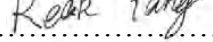
Tested by (name + signature).....: Reak Yang
 Project Engineer 

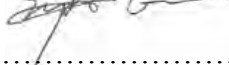
Approved by (name + signature).....: Simple Guan
 Project Manager 

Date of issue.....: October 22, 2018

Revision History

| Revision | Issue Date | Revisions | Revised By |
|----------|------------------|------------------------|-------------|
| 00 | October 22, 2018 | Initial released Issue | Simple Guan |

1. SUMMARY OF STANDARDS AND RESULTS

1.1. Description of Standards and Results

The EUT have been tested according to the applicable standards as referenced below :

| Test Item | Test Requirement | Standards Paragraph | Result |
|---|---|----------------------------|---------------|
| Conducted Emission | FCC PART 15:2017 | 15.207 | P |
| 6dB Bandwidth | FCC PART 15:2017 | 15.247 (a)(2) | P |
| Output Power | FCC PART 15:2017 | 15.247 (b)(3) | P |
| Radiated Spurious Emission | FCC PART 15:2017 | 15.247 (c) | P |
| Conducted Spurious & Band Edge Emission | FCC PART 15:2017 | 15.247 (d) | P |
| Power Spectral Density | FCC PART 15:2017 | 15.247 (e) | P |
| Radiated Band Edge Emission | FCC PART 15:2017 | 15.205 | P |
| Antenna Requirement | FCC PART 15:2017 | 15.203 | P |
| Note: | 1. P is an abbreviation for Pass. 2. F is an abbreviation for Fail. 3. N/A is an abbreviation for Not Applicable. | | |

2. GENERAL INFORMATION

2.1. Description of Device (EUT)

| | |
|---------------------|---|
| Description | : Smart Plug |
| Model Number | : PA1002T, PA1002E |
| Diff | : There is no difference between all the models, except the model number, this report performs the model PA1002T. |
| Trademark | : N/A |
| Test Voltage | : AC 110V/120V, /60Hz, 10A |
| Operation frequency | : 2412MHz-2462MHz for IEEE 802.11 b, g,n/HT20, 2422MHz~2452MHz for IEEE802.11n/HT40 |
| Channel No. | : 802.11b/802.11g /802.11n(HT20): 11 802.11(HT40): 7 |
| Modulation type | : IEEE 802.11b: DSSS(CCK,DQPSK,DBPSK) IEEE 802.11g: OFDM(64QAM, 16QAM, QPSK, BPSK) IEEE 802.11n :OFDM(64QAM, 16QAM, QPSK, BPSK) |
| Antenna Type | : PCB Antenna, Maximum Gain is 0dBi |
| Software version | : E2S_P1.0 |
| Hardware version | : PA1002-PWRV10 |

2.2. Accessories of Device (EUT)

Accessories1 : /
Manufacturer : /
Model : /
Power supply : /

2.3. Tested Supporting System Details

| No. | Description | Manufacturer | Model | Serial Number | Certification or DOC |
|-----|-------------|--------------|-------|---------------|----------------------|
| 1 | Bulb | -- | -- | -- | -- |

2.4. Block Diagram of connection between EUT and simulators

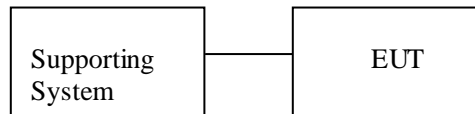

2.5. Test Mode Description

| Duty cycle :100% Keeping TX | | | |
|------------------------------|----------------------------|-------------|-----------------|
| Mode | data rate (Mbps)(see Note) | Channel | Frequency (MHz) |
| IEEE 802.11b | 1 | Low :CH1 | 2412 |
| | 1 | Middle: CH6 | 2437 |
| | 1 | High: CH11 | 2462 |
| IEEE 802.11g | 6 | Low :CH1 | 2412 |
| | 6 | Middle: CH6 | 2437 |
| | 6 | High: CH11 | 2462 |
| IEEE 802.11 n/HT20 with 2.4G | 6.5 | Low :CH1 | 2412 |
| | 6.5 | Middle: CH6 | 2437 |
| | 6.5 | High: CH11 | 2462 |
| IEEE 802.11 n/HT40 with 2.4G | 13 | Low :CH3 | 2422 |
| | 13 | Middle: CH6 | 2437 |
| | 13 | High: CH9 | 2452 |

Note: According exploratory test, EUT will have maximum output power in those data rate. so those data rate were used for all test.

| Channel list: | | | | | |
|--|-----------------|---------|-----------------|---------|-----------------|
| For IEEE 802.11b, g, n/HT20 and IEEE 802.11 n/HT40 with 2.4G | | | | | |
| Channel | Frequency (MHz) | Channel | Frequency (MHz) | Channel | Frequency (MHz) |
| CH1 | 2412 | CH5 | 2432 | CH9 | 2452 |
| CH2 | 2417 | CH6 | 2437 | CH10 | 2457 |
| CH3 | 2422 | CH7 | 2442 | CH11 | 2462 |
| CH4 | 2427 | CH8 | 2447 | | |

| Setting output power (Max) | | | |
|----------------------------|---------|---------------|---------------|
| 802.11b | 802.11g | 802.11n(HT20) | 802.11n(HT40) |
| 15dBm | 15dBm | 14dBm | 14dBm |

2.6. Test Conditions

| Items | Required | Actual |
|--------------------|-----------|--------|
| Temperature range: | 15-35°C | 27°C |
| Humidity range: | 25-75% | 56% |
| Pressure range: | 86-106kPa | 980kPa |

2.7. Test Facility

Shenzhen Alpha Product Testing Co., Ltd
Building i, No.2, Lixin Road, Fuyong Street, Bao'an District, 518103,
Shenzhen, Guangdong, China

June 21, 2018 File on Federal Communication Commission
Registration Number: 293961

July 25, 2017 Certificated by IC
Registration Number: 12135A

2.8.Measurement Uncertainty

(95% confidence levels, k=2)

| Item | Uncertainty |
|--|----------------------|
| Uncertainty for Power point Conducted Emissions Test | 2.74dB |
| Uncertainty for Radiation Emission test in 3m chamber (below 30MHz) | 2.13 dB(Polarize: V) |
| | 2.57dB(Polarize: H) |
| Uncertainty for Radiation Emission test in 3m chamber (30MHz to 1GHz) | 3.77dB(Polarize: V) |
| | 3.80dB(Polarize: H) |
| Uncertainty for Radiation Emission test in 3m chamber (1GHz to 25GHz) | 4.16dB(Polarize: H) |
| | 4.13dB(Polarize: V) |
| Uncertainty for radio frequency | 5.4×10^{-8} |
| Uncertainty for conducted RF Power | 0.37dB |
| Uncertainty for temperature | 0.2°C |
| Uncertainty for humidity | 1% |
| Uncertainty for DC and low frequency voltages | 0.06% |

2.9. Test Equipment List

| Equipment | Manufacture | Model No. | Serial No. | Last cal. | Cal Interval |
|------------------------|----------------|-------------------------|-------------------|------------|--------------|
| 3m Semi-Anechoic | ETS-LINDGREN | N/A | SEL0017 | 2018.09.21 | 1 Year |
| Spectrum analyzer | Agilent | E4407B | MY46185649 | 2018.09.21 | 1 Year |
| Receiver | R&S | ESCI | 1166.5950K03-1011 | 2018.09.21 | 1 Year |
| Receiver | R&S | ESCI | 101202 | 2018.09.21 | 1 Year |
| Bilog Antenna | Schwarzbeck | VULB 9168 | VULB9168-438 | 2018.09.29 | 2Year |
| Horn Antenna | EMCO | 3115 | 640201028-06 | 2018.09.29 | 2Year |
| Active Loop Antenna | Beijing Daze | ZN30900A | SEL0097 | 2018.09.29 | 2Year |
| Cable | Resenberger | N/A | No.1 | 2018.09.21 | 1 Year |
| Cable | SCHWARZBECK | N/A | No.2 | 2018.09.21 | 1 Year |
| Cable | SCHWARZBECK | N/A | No.3 | 2018.09.21 | 1 Year |
| Pre-amplifier | Schwarzbeck | BBV9743 | 9743-019 | 2018.09.21 | 1 Year |
| Pre-amplifier | R&S | AFS33-18002650-30-8P-44 | SEL0080 | 2018.09.21 | 1 Year |
| Temperature controller | Terchy | MHQ | 120 | 2018.09.21 | 1 Year |
| L.I.S.N.#1 | Schwarzbeck | NSLK8126 | 8126466 | 2018.09.21 | 1 Year |
| L.I.S.N.#2 | ROHDE&SCHWARZ | ENV216 | 101043 | 2018.09.21 | 1 Year |
| 20db Attenuator | ICPROBING | IATS1 | 82347 | 2018.09.21 | 1 Year |
| 18-40 Horn Antenna | 18-40G antenna | Sas-574 | 571 | 2018.3.14 | 3 Year |
| Power Meter | Anritsu | ML2487A | 6K00001491 | 2018.09.21 | 1 Year |

3. SPURIOUS EMISSION

3.1. Test Limits

| Frequencies (MHz) | Field Strength (microrvolts/meter) | Measurement Distance (meters) |
|-------------------|------------------------------------|-------------------------------|
| 0.009~0.490 | 2400/F(KHz) | 300 |
| 0.490~1.705 | 24000/F(KHz) | 30 |
| 1.705~30.0 | 30 | 30 |
| 30~88 | 100 | 3 |
| 88~216 | 150 | 3 |
| 216~960 | 200 | 3 |
| Above 960 | 500 | 3 |

Harmonic emissions limits comply with below 54 dBuV/m at 3m. Other emissions radiated outside of the specified frequency bands, except for harmonics, shall be attenuated by at least 50 dB below the level of the fundamental or comply with the radiated emissions limits specified in section 15.209(a) limit in the table below has to be followed.

NOTE:

- a) The tighter limit applies at the band edges.
- b) Emission Level(dB uV/m)=20log Emission Level(Uv/m)

3.2. Test Procedure

The measuring distance of 3m shall be used for measurements at frequency up to 1GHz and above 1GHz, The EUT was placed on a rotating 0.8 m high above ground, The table was rotated 360 degrees to determine the position of the highest radiation

The Test antenna shall vary between 1 m and 4m,Both Horizontal and Vertical antenna are set o f make measurement.

The initial step in collecting conducted emission data is a spectrum analyzer Peak detector mode pre-scanning the measurement frequency range. Significant Peaks are then marked. and then Qusia Peak Detector mode premeasured

If Peak value comply with QP limit Below 1GHz.The EUT deemed to comply with QP limit. But the Peak value and average value both need to comply with applicable limit above 1GHz.

For the actual test configuration, please see the test setup photo.

3.3. Test Setup

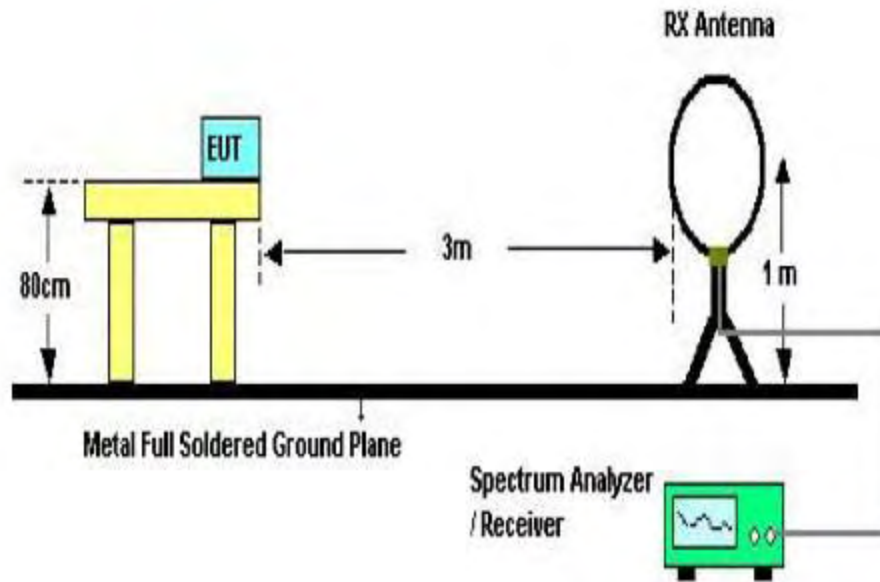

Below 30MHz Test Setup

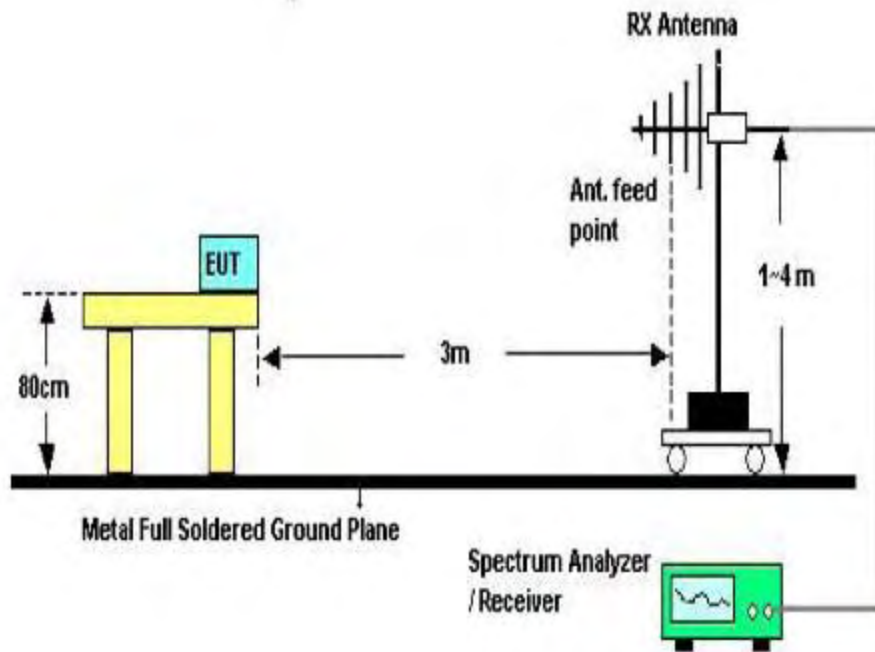

Above 30MHz Test Setup

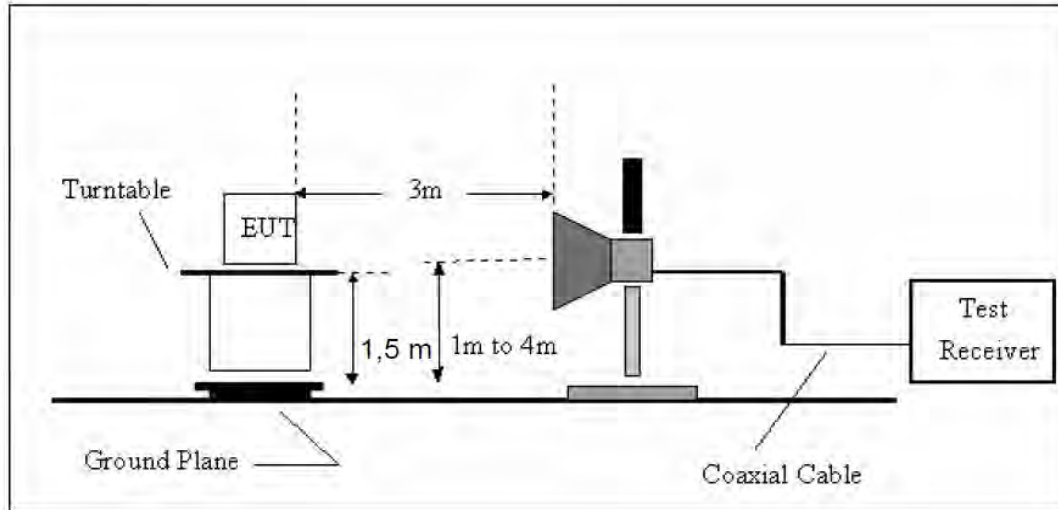

Above 1GHz Test Setup

3.4. Test Results

Test Condition

Continual Transmitting in maximum power.

| | | |
|--------------|-----------|------------|
| 9KHz~150KHz | RBW200Hz | VBW1KHz |
| 150KHz~30MHz | RBW9KHz | VBW 30KHz |
| 30MHz~1GHz | RBW120KHz | VBW 300KHz |
| Above1GHz | RBW1MHz | VBW 3MHz |

We have scanned the 10th harmonic from 9 kHz to the EUT.

Detailed information please see the following page.

From 9KHz to 30MHz: Conclusion: PASS

Note:1.The amplitude of spurious emissions which are attenuated by more than 20dB below the permissible value has no need to be reported.

2.Only show the test data of the worst Channel in this report.

Test result for 802.11b (High Channel), AC 120V/ 60Hz
Vertical

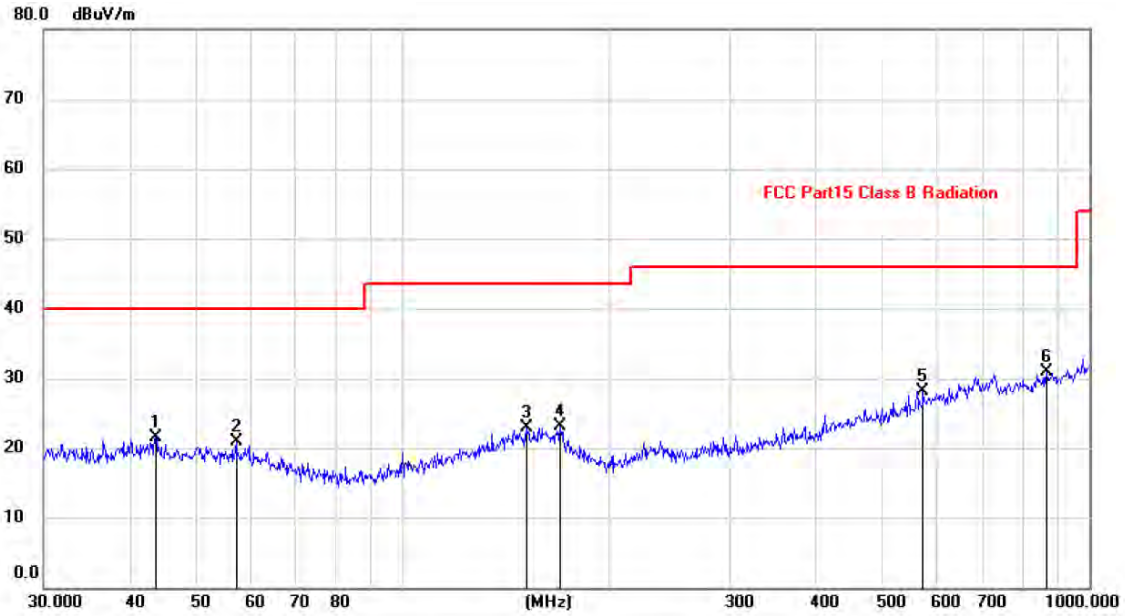

| No. | Mk. | Freq. | Reading Level | Correct Factor | Measurement | Limit | Margin | Antenna Height | Table Degree | |
|-----|-----|----------|---------------|----------------|-------------|--------|--------|----------------|--------------|---------|
| | | MHz | dBuV | dB | dBuV/m | dBuV/m | dB | cm | degree | Comment |
| 1 | | 43.6584 | 7.65 | 13.90 | 21.55 | 40.00 | -18.45 | | | peak |
| 2 | | 57.1914 | 7.91 | 13.07 | 20.98 | 40.00 | -19.02 | | | peak |
| 3 | | 151.5972 | 8.36 | 14.56 | 22.92 | 43.50 | -20.58 | | | peak |
| 4 | | 169.5990 | 9.21 | 13.80 | 23.01 | 43.50 | -20.49 | | | peak |
| 5 | | 572.6144 | 8.99 | 19.09 | 28.08 | 46.00 | -17.92 | | | peak |
| 6 | * | 866.0879 | 8.21 | 22.62 | 30.83 | 46.00 | -15.17 | | | peak |

Note: 1. *:Maximum data; x:Over limit; !:over margin.

2.Measurement=Reading Level+Correct Factor; Correct Factor=Antenna Factor+Cable Loss.

Horizontal

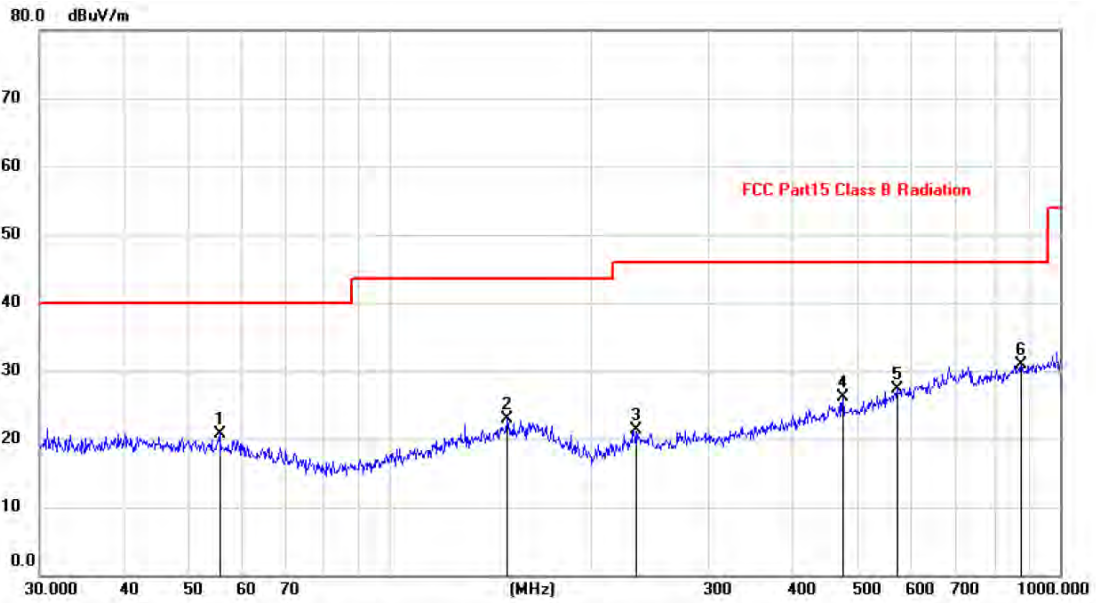

| No. | Mk. | Freq. | Reading Level | Correct Factor | Measurement | Limit | Margin | Antenna Height | Table Degree | |
|-----|-----|----------|---------------|----------------|-------------|--------|--------|----------------|--------------|---------|
| | | MHz | dBuV | dB | dBuV/m | dBuV/m | dB | cm | degree | Comment |
| 1 | | 55.6094 | 7.56 | 13.24 | 20.80 | 40.00 | -19.20 | | | peak |
| 2 | | 149.4857 | 8.37 | 14.52 | 22.89 | 43.50 | -20.61 | | | peak |
| 3 | | 231.7179 | 9.41 | 11.82 | 21.23 | 46.00 | -24.77 | | | peak |
| 4 | | 473.8347 | 9.08 | 17.04 | 26.12 | 46.00 | -19.88 | | | peak |
| 5 | | 570.6100 | 8.10 | 19.13 | 27.23 | 46.00 | -18.77 | | | peak |
| 6 | * | 875.2470 | 8.06 | 22.83 | 30.89 | 46.00 | -15.11 | | | peak |

Note: 1. *: Maximum data; x: Over limit; !: over margin.

2. Measurement=Reading Level+Correct Factor; Correct Factor=Antenna Factor+Cable Loss.

From 1G-25GHz

| Test Mode: IEEE 802.11b TX Low | | | | | | | | | |
|---|---------------------|-------------|-----------------------|----------------|-----------------|-----------------|----------------|-------------|--------|
| Freq (MHz) | Read Level (dBuV/m) | Polar (H/V) | Antenna Factor (dB/m) | Cable loss(dB) | Amp Factor (dB) | Result (dBuV/m) | Limit (dBuV/m) | Margin (dB) | Remark |
| 4824 | 45.77 | V | 33.95 | 10.18 | 34.26 | 55.64 | 74 | 18.36 | PK |
| 4824 | 34.64 | V | 33.95 | 10.18 | 34.26 | 44.51 | 54 | 9.49 | AV |
| 7236 | / | | | | | | | | |
| 9648 | / | | | | | | | | |
| 4824 | 43.16 | H | 33.95 | 10.18 | 34.26 | 53.03 | 74 | 20.97 | PK |
| 4824 | 33.55 | H | 33.95 | 10.18 | 34.26 | 43.42 | 54 | 10.58 | AV |
| 7236 | | | | | | | | | |
| 9648 | | | | | | | | | |
| Test Mode: IEEE 802.11b TX Mid | | | | | | | | | |
| 4874 | 43.18 | V | 33.93 | 10.2 | 34.29 | 53.02 | 74 | 20.98 | PK |
| 4874 | 34.13 | V | 33.93 | 10.2 | 34.29 | 43.97 | 54 | 10.03 | AV |
| 7311 | / | | | | | | | | |
| 9748 | / | | | | | | | | |
| 4874 | 42.82 | H | 33.93 | 10.2 | 34.29 | 52.66 | 74 | 21.34 | PK |
| 4874 | 33.88 | H | 33.93 | 10.2 | 34.29 | 43.72 | 54 | 10.28 | AV |
| 7311 | | | | | | | | | |
| 9748 | | | | | | | | | |
| Test Mode: IEEE 802.11b TX High | | | | | | | | | |
| 4924 | 42.86 | V | 33.98 | 10.22 | 34.25 | 52.81 | 74 | 21.19 | PK |
| 4924 | 33.40 | V | 33.98 | 10.22 | 34.25 | 43.35 | 54 | 10.65 | AV |
| 7386 | / | | | | | | | | |
| 9848 | / | | | | | | | | |
| 4924 | 43.27 | H | 33.98 | 10.22 | 34.25 | 53.22 | 74 | 20.78 | PK |
| 4924 | 32.66 | H | 33.98 | 10.22 | 34.25 | 42.61 | 54 | 11.39 | AV |
| 7386 | | | | | | | | | |
| 9848 | | | | | | | | | |
| Note: | | | | | | | | | |
| 1, Result = Read level + Antenna factor + cable loss - Amp factor | | | | | | | | | |
| 2, All the other emissions not reported were too low to read and deemed to comply with FCC limit. | | | | | | | | | |

| Test Mode: IEEE 802.11g TX Low | | | | | | | | | |
|---|---------------------|-------------|-----------------------|----------------|-----------------|-----------------|----------------|-------------|--------|
| Freq (MHz) | Read Level (dBuV/m) | Polar (H/V) | Antenna Factor (dB/m) | Cable loss(dB) | Amp Factor (dB) | Result (dBuV/m) | Limit (dBuV/m) | Margin (dB) | Remark |
| 4824 | 44.33 | V | 33.95 | 10.18 | 34.26 | 54.20 | 74 | 19.80 | PK |
| 4824 | 32.14 | V | 33.95 | 10.18 | 34.26 | 42.01 | 54 | 11.99 | AV |
| 7236 | / | | | | | | | | |
| 9648 | / | | | | | | | | |
| 4824 | 44.47 | H | 33.95 | 10.18 | 34.26 | 54.34 | 74 | 19.66 | PK |
| 4824 | 35.15 | H | 33.95 | 10.18 | 34.26 | 45.02 | 54 | 8.98 | AV |
| 7236 | | | | | | | | | |
| 9648 | | | | | | | | | |
| Test Mode: IEEE 802.11g TX Mid | | | | | | | | | |
| 4874 | 42.26 | V | 33.93 | 10.2 | 34.29 | 52.10 | 74 | 21.90 | PK |
| 4874 | 35.30 | V | 33.93 | 10.2 | 34.29 | 45.14 | 54 | 8.86 | AV |
| 7311 | / | | | | | | | | |
| 9748 | / | | | | | | | | |
| 4874 | 42.29 | H | 33.93 | 10.2 | 34.29 | 52.13 | 74 | 21.87 | PK |
| 4874 | 33.03 | H | 33.93 | 10.2 | 34.29 | 42.87 | 54 | 11.13 | AV |
| 7311 | | | | | | | | | |
| 9748 | | | | | | | | | |
| Test Mode: IEEE 802.11g TX High | | | | | | | | | |
| 4924 | 43.54 | V | 33.98 | 10.22 | 34.25 | 53.49 | 74 | 20.51 | PK |
| 4924 | 35.00 | V | 33.98 | 10.22 | 34.25 | 44.95 | 54 | 9.05 | AV |
| 7386 | / | | | | | | | | |
| 9848 | / | | | | | | | | |
| 4924 | 44.40 | H | 33.98 | 10.22 | 34.25 | 54.35 | 74 | 19.65 | PK |
| 4924 | 34.46 | H | 33.98 | 10.22 | 34.25 | 44.41 | 54 | 9.59 | AV |
| 7386 | | | | | | | | | |
| 9848 | | | | | | | | | |
| Note: | | | | | | | | | |
| 1, Result = Read level + Antenna factor + cable loss - Amp factor | | | | | | | | | |
| 2, All the other emissions not reported were too low to read and deemed to comply with FCC limit. | | | | | | | | | |

| Test Mode:IEEE 802.11 n HT20 TX Low | | | | | | | | | |
|---|---------------------|-------------|-----------------------|----------------|-----------------|-----------------|----------------|-------------|--------|
| Freq (MHz) | Read Level (dBuV/m) | Polar (H/V) | Antenna Factor (dB/m) | Cable loss(dB) | Amp Factor (dB) | Result (dBuV/m) | Limit (dBuV/m) | Margin (dB) | Remark |
| 4824 | 46.45 | V | 33.95 | 10.18 | 34.26 | 56.32 | 74 | 17.68 | PK |
| 4824 | 33.12 | V | 33.95 | 10.18 | 34.26 | 42.99 | 54 | 11.01 | AV |
| 7236 | / | | | | | | | | |
| 9648 | / | | | | | | | | |
| 4824 | 45.15 | H | 33.95 | 10.18 | 34.26 | 55.02 | 74 | 18.98 | PK |
| 4824 | 34.05 | H | 33.95 | 10.18 | 34.26 | 43.92 | 54 | 10.08 | AV |
| 7236 | | | | | | | | | |
| 9648 | | | | | | | | | |
| Test Mode:IEEE 802.11 n HT20 TX Mid | | | | | | | | | |
| 4874 | 41.56 | V | 33.93 | 10.2 | 34.29 | 51.40 | 74 | 22.60 | PK |
| 4874 | 32.75 | V | 33.93 | 10.2 | 34.29 | 42.59 | 54 | 11.41 | AV |
| 7311 | / | | | | | | | | |
| 9748 | / | | | | | | | | |
| 4874 | 42.03 | H | 33.93 | 10.2 | 34.29 | 51.87 | 74 | 22.13 | PK |
| 4874 | 33.67 | H | 33.93 | 10.2 | 34.29 | 43.51 | 54 | 10.49 | AV |
| 7311 | | | | | | | | | |
| 9748 | | | | | | | | | |
| Test Mode:IEEE 802.11 n HT20 TX High | | | | | | | | | |
| 4924 | 43.12 | V | 33.98 | 10.22 | 34.25 | 53.07 | 74 | 20.93 | PK |
| 4924 | 32.61 | V | 33.98 | 10.22 | 34.25 | 42.56 | 54 | 11.44 | AV |
| 7386 | / | | | | | | | | |
| 9848 | / | | | | | | | | |
| 4924 | 41.72 | H | 33.98 | 10.22 | 34.25 | 51.67 | 74 | 22.33 | PK |
| 4924 | 33.92 | H | 33.98 | 10.22 | 34.25 | 43.87 | 54 | 10.13 | AV |
| 7386 | | | | | | | | | |
| 9848 | | | | | | | | | |
| Note: | | | | | | | | | |
| 1, Result = Read level + Antenna factor + cable loss - Amp factor | | | | | | | | | |
| 2, All the other emissions not reported were too low to read and deemed to comply with FCC limit. | | | | | | | | | |

| Test Mode:IEEE 802.11 n HT40 TX Low | | | | | | | | | |
|---|---------------------|-------------|-----------------------|----------------|-----------------|-----------------|----------------|-------------|--------|
| Freq (MHz) | Read Level (dBuV/m) | Polar (H/V) | Antenna Factor (dB/m) | Cable loss(dB) | Amp Factor (dB) | Result (dBuV/m) | Limit (dBuV/m) | Margin (dB) | Remark |
| 4844 | 42.80 | V | 33.95 | 10.18 | 34.26 | 52.67 | 74 | 21.33 | PK |
| 4844 | 33.00 | V | 33.95 | 10.18 | 34.26 | 42.87 | 54 | 11.13 | AV |
| 7266 | / | | | | | | | | |
| 9688 | / | | | | | | | | |
| 4844 | 44.96 | H | 33.95 | 10.18 | 34.26 | 54.83 | 74 | 19.17 | PK |
| 4844 | 33.29 | H | 33.95 | 10.18 | 34.26 | 43.16 | 54 | 10.84 | AV |
| 7266 | | | | | | | | | |
| 9688 | | | | | | | | | |
| Test Mode:IEEE 802.11 n HT40 TX Mid | | | | | | | | | |
| 4874 | 42.51 | V | 33.93 | 10.2 | 34.29 | 52.35 | 74 | 21.65 | PK |
| 4874 | 32.69 | V | 33.93 | 10.2 | 34.29 | 42.53 | 54 | 11.47 | AV |
| 7311 | / | | | | | | | | |
| 9748 | / | | | | | | | | |
| 4874 | 42.97 | H | 33.93 | 10.2 | 34.29 | 52.81 | 74 | 21.19 | PK |
| 4874 | 32.87 | H | 33.93 | 10.2 | 34.29 | 42.71 | 54 | 11.29 | AV |
| 7311 | | | | | | | | | |
| 9748 | | | | | | | | | |
| Test Mode:IEEE 802.11 n HT40 TX High | | | | | | | | | |
| 4904 | 42.53 | V | 33.98 | 10.22 | 34.25 | 52.48 | 74 | 21.52 | PK |
| 4904 | 33.73 | V | 33.98 | 10.22 | 34.25 | 43.68 | 54 | 10.32 | AV |
| 7356 | / | | | | | | | | |
| 9808 | / | | | | | | | | |
| 4904 | 42.16 | H | 33.98 | 10.22 | 34.25 | 52.11 | 74 | 21.89 | PK |
| 4904 | 34.26 | H | 33.98 | 10.22 | 34.25 | 44.21 | 54 | 9.79 | AV |
| 7356 | | | | | | | | | |
| 9808 | | | | | | | | | |
| Note: | | | | | | | | | |
| 1, Result = Read level + Antenna factor + cable loss - Amp factor | | | | | | | | | |
| 2, All the other emissions not reported were too low to read and deemed to comply with FCC limit. | | | | | | | | | |

4. POWER LINE CONDUCTED EMISSION

4.1. Test Limits

| Frequency MHz | Limits dB(μ V) | |
|------------------|---------------------|---------------|
| | Quasi-peak Level | Average Level |
| 0.15 -0.50 | 66 -56* | 56 - 46* |
| 0.50 -5.00 | 56 | 46 |
| 5.00 -30.00 | 60 | 50 |

- Notes: 1. *Decreasing linearly with logarithm of frequency.
 2. The lower limit shall apply at the transition frequencies.
 3. The limit decreases in line with the logarithm of the frequency in the rang of 0.15 to 0.50 MHz.

4.2. Test Procedure

The EUT is put on the plane 0.8m high above the ground by insulating support and is connected to the power mains through a line impedance stabilization network (L.I.S.N.). This provides a 50ohm coupling impedance for the EUT system. Please refer the block diagram of the test setup and photographs. Both sides of AC lines are checked to find out the maximum conducted emission. In order to find the maximum emission levels, the relative positions of equipment and all of the interface cables shall be changed according to ANSI C63.10:2013 on Conducted Emission Measurement.

The bandwidth of test receiver is set at 9 kHz.

4.3. Test Setup

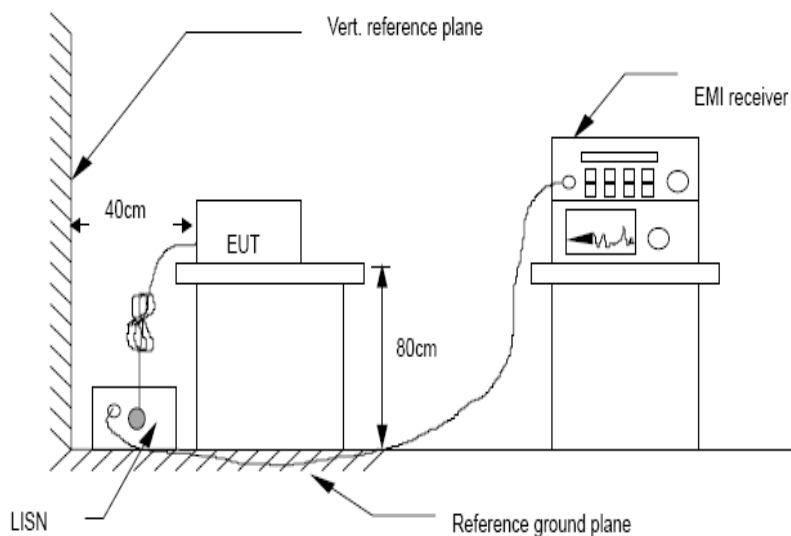

4.4. Test Results

Test result for 802.11b (High Channel), AC 120V/ 60Hz

Line:

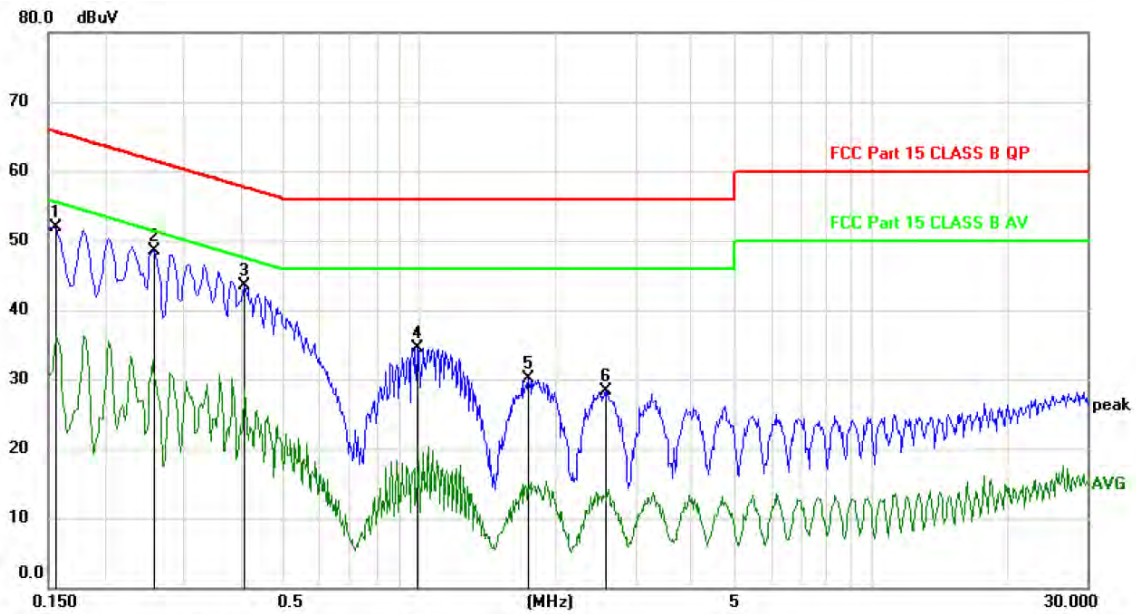

| No. | Mk. | Freq. MHz | Reading Level dBuV | Correct Factor dB | Measure- ment dBuV | Limit dBuV | Margin dB | Detector | Comment |
|-----|-----|--------------|--------------------------|-------------------------|--------------------------|---------------|--------------|----------|---------|
| 1 | | 0.1560 | 42.33 | 9.66 | 51.99 | 65.67 | -13.68 | peak | |
| 2 | * | 0.2580 | 38.82 | 9.69 | 48.51 | 61.50 | -12.99 | peak | |
| 3 | | 0.4080 | 33.74 | 9.70 | 43.44 | 57.69 | -14.25 | peak | |
| 4 | | 0.9840 | 24.78 | 9.77 | 34.55 | 56.00 | -21.45 | peak | |
| 5 | | 1.7370 | 20.21 | 9.85 | 30.06 | 56.00 | -25.94 | peak | |
| 6 | | 2.5770 | 18.44 | 9.96 | 28.40 | 56.00 | -27.60 | peak | |

*:Maximum data x:Over limit !:over margin

Note: Measurement=Reading Level+Correc Factor. Factor=(LISN or ISN or PLC or Current Probe)Factor+Cable

Neutral:

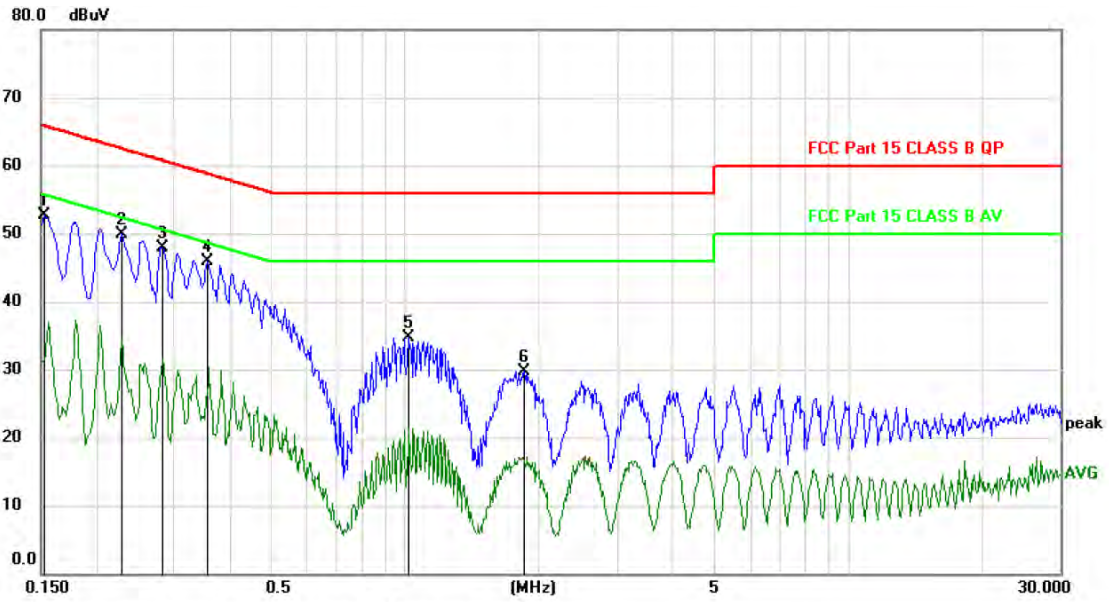

| No. | Mk. | Freq. MHz | Reading Level dBuV | Correct Factor dB | Measure- ment dBuV | Limit dBuV | Margin dB | Detector | Comment |
|-----|-----|--------------|--------------------------|-------------------------|--------------------------|---------------|--------------|----------|---------|
| 1 | | 0.1530 | 42.95 | 9.66 | 52.61 | 65.84 | -13.23 | peak | |
| 2 | * | 0.2280 | 40.30 | 9.68 | 49.98 | 62.52 | -12.54 | peak | |
| 3 | | 0.2819 | 38.31 | 9.69 | 48.00 | 60.76 | -12.76 | peak | |
| 4 | | 0.3570 | 36.11 | 9.70 | 45.81 | 58.80 | -12.99 | peak | |
| 5 | | 1.0140 | 25.02 | 9.77 | 34.79 | 56.00 | -21.21 | peak | |
| 6 | | 1.8540 | 19.87 | 9.87 | 29.74 | 56.00 | -26.26 | peak | |

*:Maximum data x:Over limit !:over margin

Note: Measurement=Reading Level+Correc Factor. Factor=(LISN or ISN or PLC or Current Probe)Factor+Cable

5. CONDUCTED MAXIMUM OUTPUT POWER

5.1. Test limits

Please refer section 15.247.

Regulation 15.247(b) The limit of Maximum Peak Output Power Measurement is 1 W(30dBm)

5.2. Test Procedure

Details see the KDB558074 D01 Meas Guidance V04

5.2.1 Place the EUT on the table and set it in transmitting mode.

5.2.2 Connected the EUT's antenna port to peak power meter by 20dB attenuator.

5.2.3 Measure out each mode and each bands peak output power of EUT.

Note: The cable loss and attenuator loss were offset into measure device as amplitude offset.

5.3. Test Setup

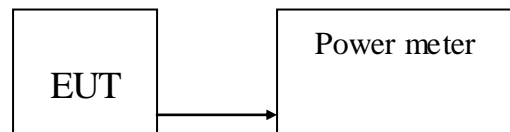

5.4. Test Results

PASS

Detailed information please see the following page.

| Mode | Frequency (MHz) | PK Output power(dBm) | Limit (dBm) | Result |
|------------------------------|-----------------|----------------------|-------------|--------|
| IEEE 802.11 b | CH1: 2412 | 14.21 | 30 | PASS |
| | CH6: 2437 | 14.66 | 30 | PASS |
| | CH11: 2462 | 14.79 | 30 | PASS |
| IEEE 802.11 g | CH1: 2412 | 14.21 | 30 | PASS |
| | CH6: 2437 | 14.15 | 30 | PASS |
| | CH11: 2462 | 14.22 | 30 | PASS |
| IEEE 802.11 n/HT20 with 2.4G | CH1: 2412 | 13.90 | 30 | PASS |
| | CH6: 2437 | 13.88 | 30 | PASS |
| | CH11: 2462 | 14.09 | 30 | PASS |
| IEEE 802.11 n/HT40 with 2.4G | CH3: 2422 | 13.53 | 30 | PASS |
| | CH6: 2437 | 13.44 | 30 | PASS |
| | CH9: 2452 | 13.84 | 30 | PASS |

6. PEAK POWER SPECTRAL DENSITY

6.1. Test limits

6.1.1 Please refer section 15.247.

6.1.2 For direct sequence systems, the peak power spectral density conducted from the intentional radiator to the antenna shall not be greater than 8dBm in any 3kHz band during any time interval of continuous transmission.

6.1.3 The direct sequence operating of the hybrid system, with the frequency hopping operation turned off, shall comply with the power density requirements of paragraph (d) of this section.

6.2. Test Procedure

Details see the KDB558074 D01 Meas Guidance V04

6.2.1 Place the EUT on the table and set it in transmitting mode.

6.2.2 Remove the antenna from the EUT and then connect a low loss RF cable from the antenna port to the spectrum analyzer.

6.2.3 Set the spectrum analyzer as $RBW = 3\text{kHz}$ (Set the RBW to: $3\text{ kHz} \leq RBW \leq 100\text{ kHz}$), $VBW = 10\text{kHz}$ (Set the $VBW \geq 3 \times RBW$), $\text{span} = 1.5 \times \text{DTS bandwidth}$, detail see the test plot.

6.2.4 Record the max reading.

6.2.5 Repeat the above procedure until the measurements for all frequencies are completed.

6.3. Test Setup

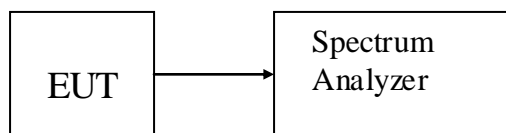

6.4. Test Results

| Test CH | Power Spectral Density (dBm) | | | | Limit (dBm/3kHz) | Result |
|---------|------------------------------|---------|---------------|---------------|------------------|--------|
| | 802.11b | 802.11g | 802.11n(HT20) | 802.11n(HT40) | | |
| Lowest | -10.526 | -14.338 | -14.041 | -18.236 | 8.00 | Pass |
| Middle | -11.744 | -14.706 | -14.931 | -17.973 | | |
| Highest | -11.867 | -15.500 | -14.595 | -19.290 | | |

802.11b 802.11g

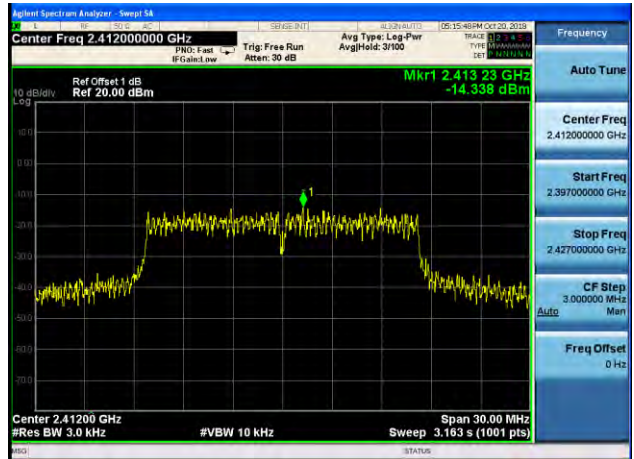
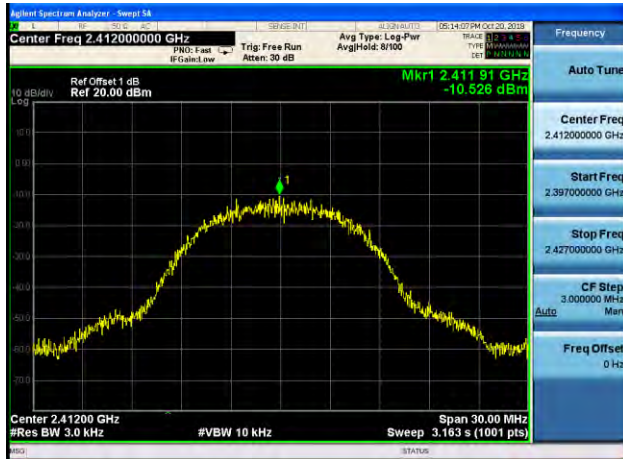

Lowest channel

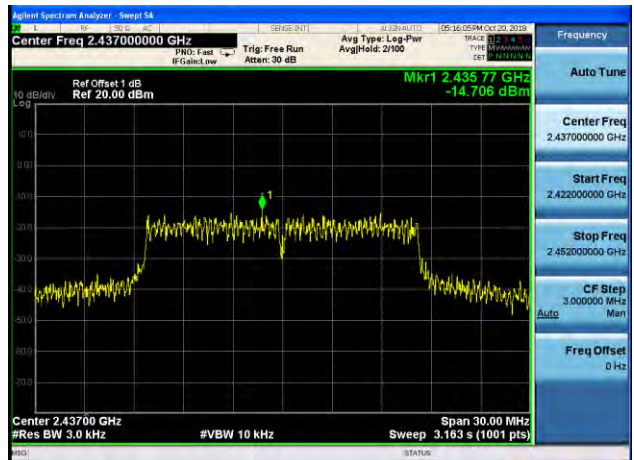

Middle channel

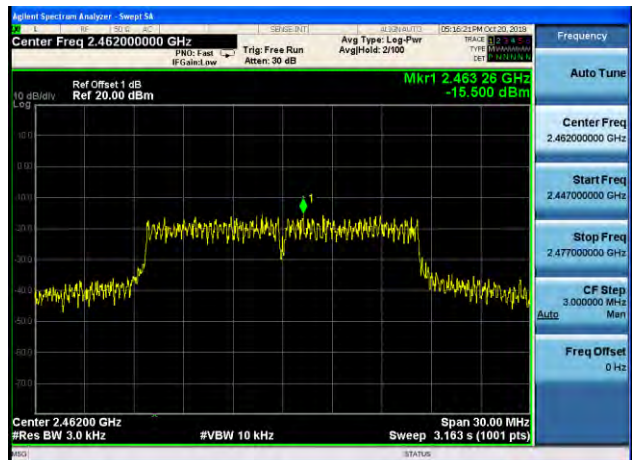
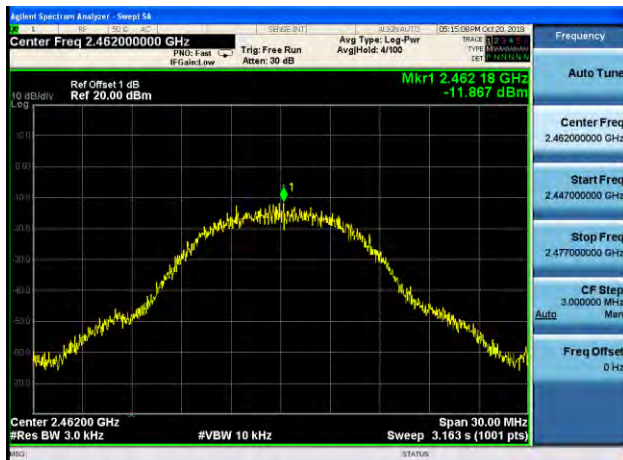

Highest channel

802.11n(HT20) 802.11n(HT40)

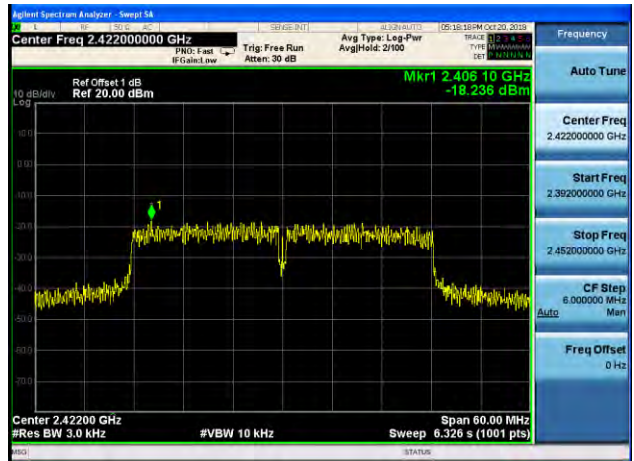
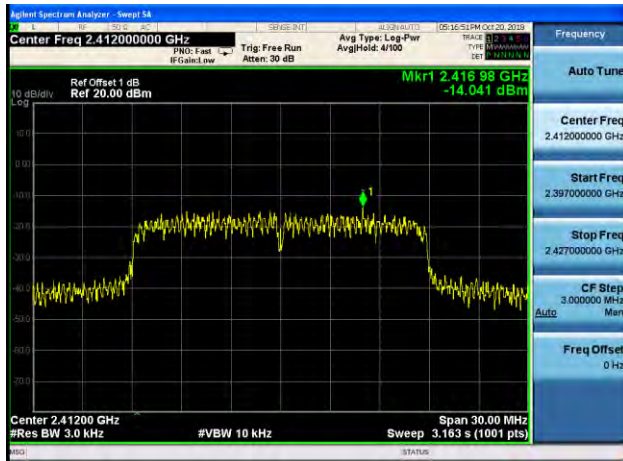

Lowest channel

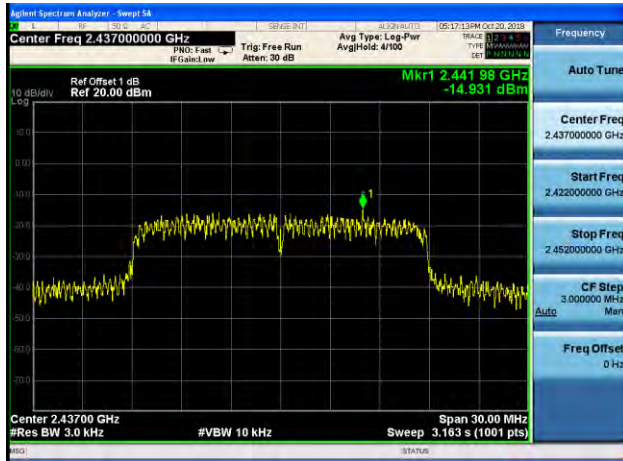

Middle channel

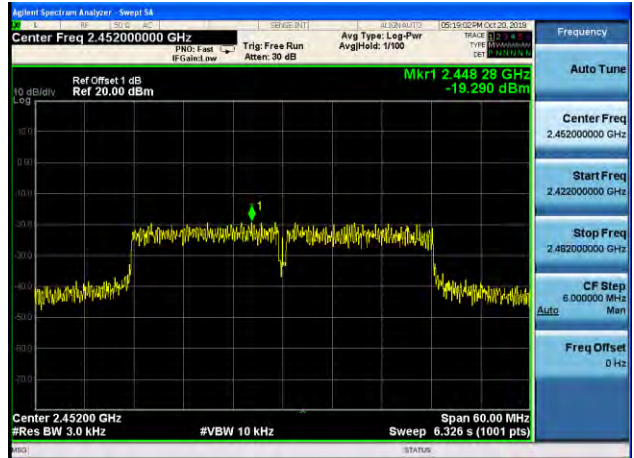
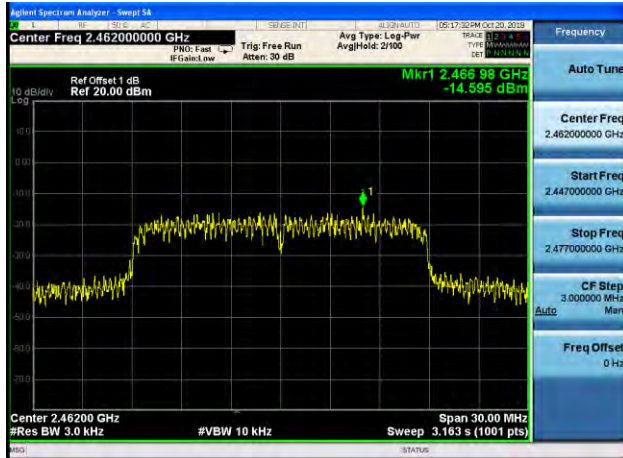

Highest channel

7. BANDWIDTH

7.1. Test limits

Please refer section 15.247

For direct sequence systems, the minimum 6dB bandwidth shall be at least 500 kHz.

7.2. Test Procedure

Details see the KDB558074 D01 Meas Guidance V04

- a) The bandwidth is measured at an amplitude level reduced 20dB from the reference level. The reference level is the level of the highest amplitude signal observed from the transmitter at the fundamental frequency. Once the reference level is established, the equipment is conditioned with typical modulating signal to produce the worst-case (i.e. the widest) bandwidth.
- b) The test receiver set $RBW = 100\text{kHz}$, $VBW \geq 3 * RBW = 300\text{kHz}$, Peak Detector, Sweep time set auto, detail see the test plot.

7.3. Test Setup

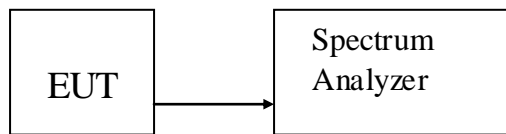

7.4. Test Results

| IEEE 802.11b: | | | | | |
|-------------------|-----------------|---------------------|------------------------------|-------------|--------|
| Channel | Frequency (MHz) | 6dB Bandwidth (MHz) | 99% Occupied Bandwidth (MHz) | Limit (MHz) | Result |
| Low | 2412 | 8.766 | 11, 050 | 0.5 | PASS |
| Mid | 2437 | 8.745 | 11.047 | 0.5 | PASS |
| High | 2462 | 7.590 | 11.084 | 0.5 | PASS |
| IEEE 802.11g | | | | | |
| Channel | Frequency (MHz) | 6dB Bandwidth (MHz) | 99% Occupied Bandwidth (MHz) | Limit (MHz) | Result |
| Low | 2412 | 16.12 | 16.343 | 0.5 | PASS |
| Mid | 2437 | 16.32 | 16.344 | 0.5 | PASS |
| High | 2462 | 16.34 | 16.361 | 0.5 | PASS |
| IEEE 802.11n/HT20 | | | | | |
| Channel | Frequency (MHz) | 6dB Bandwidth (MHz) | 99% Occupied Bandwidth (MHz) | Limit (MHz) | Result |
| Low | 2412 | 16.34 | 17.347 | 0.5 | PASS |
| Mid | 2437 | 16.11 | 17.357 | 0.5 | PASS |
| High | 2462 | 16.37 | 17.387 | 0.5 | PASS |
| IEEE 802.11n/HT40 | | | | | |
| Channel | Frequency (MHz) | 6dB Bandwidth (MHz) | 99% Occupied Bandwidth (MHz) | Limit (MHz) | Result |
| Low | 2422 | 35.56 | 36.076 | 0.5 | PASS |
| Mid | 2437 | 35.43 | 36.074 | 0.5 | PASS |
| High | 2452 | 35.42 | 36.100 | 0.5 | PASS |

IEEE 802.11b: IEEE 802.11g:

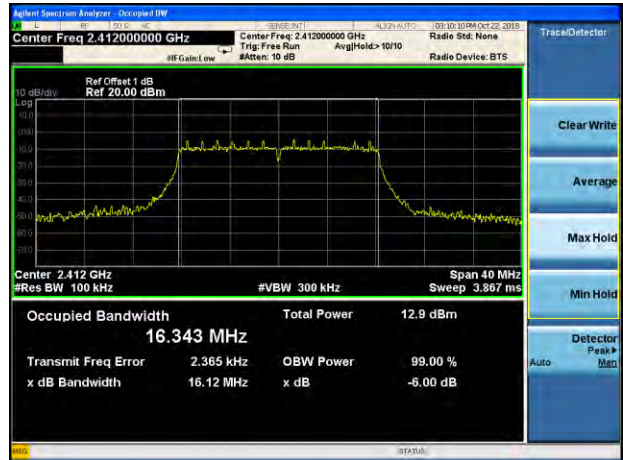

Lowest channel

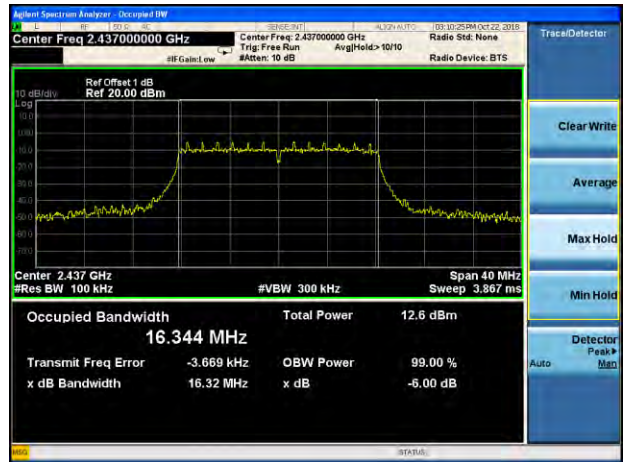

Middle channel



Highest channel

IEEE 802.11 n/HT20 **IEEE 802.11 n/HT40**

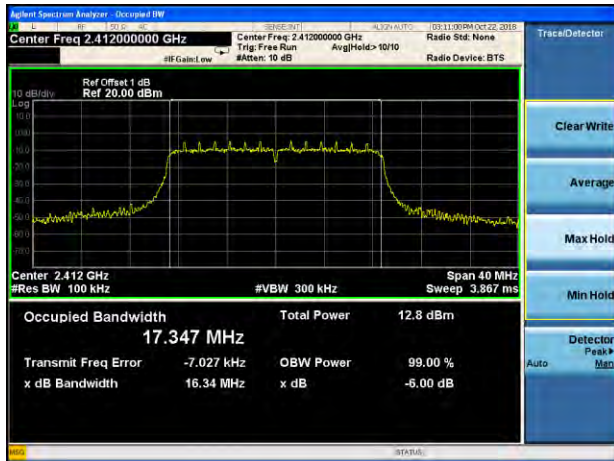

Lowest channel

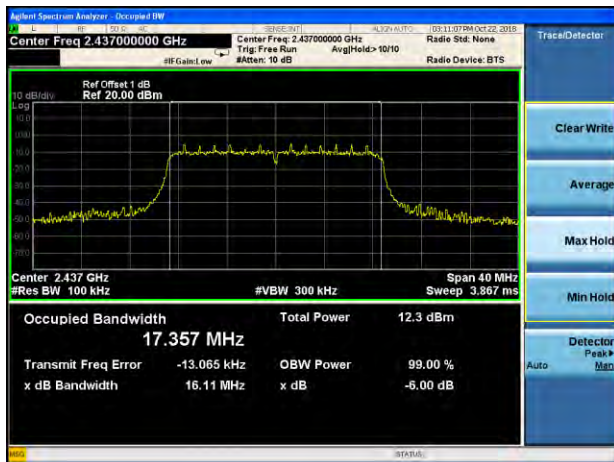

Middle channel



Highest channel

8. BAND EDGE CHECK

8.1. Test limits

Please refer section 15.247

All the lower and upper band-edges emissions appearing within 2310MHz to 2390MHz and 2483.5MHz to 2500MHz restricted frequency bands shall not exceed the limits shown in 15.209, all the other emissions outside operation frequency band 2400MHz to 2483.5MHz and 5725MHz to 5850MHz shall be at least 20dB below the fundamental emissions, or comply with 15.209 limits.

8.2. Test Procedure

Details see the KDB558074 D01 Meas Guidance V04

8.2.1 Put the EUT on a 1.5m high table, power on the EUT. Emissions were scanned and measured rotating the EUT to 360 degrees, Find the maximum Emission

8.2.2 Check the spurious emissions out of band.

8.2.3 RBW 1MHz, VBW 3MHz, peak detector for peak value , RBW 1MHz ,VBW 10Hz , RMS detector for AV value.

8.3. Test Setup

Same as 5.2.2.

8.4. Test Results

PASS.

Detailed information please see the following page.

Test Mode: IEEE 802.11b-Low
Polarization: Vertical

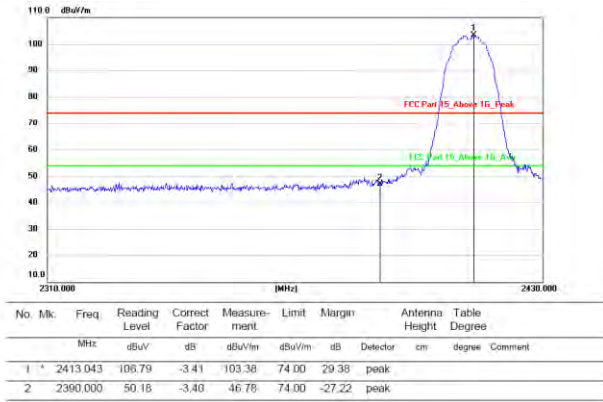

Polarization: Horizontal

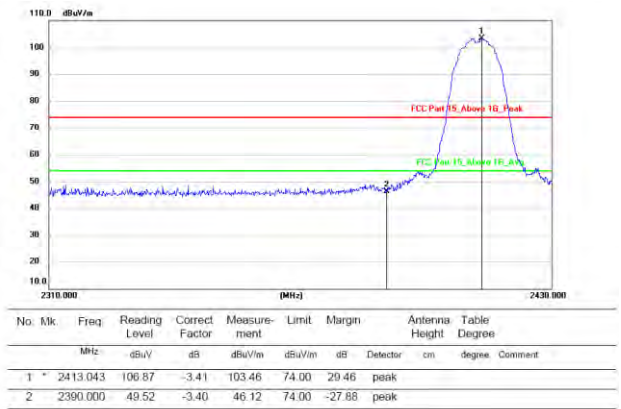

Test Mode: IEEE 802.11b-High
Polarization: Vertical

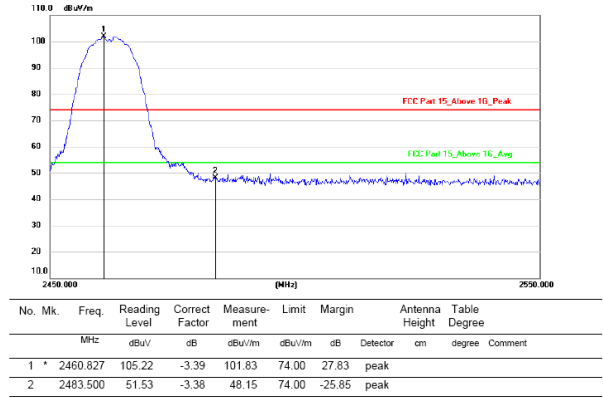

Polarization: Horizontal

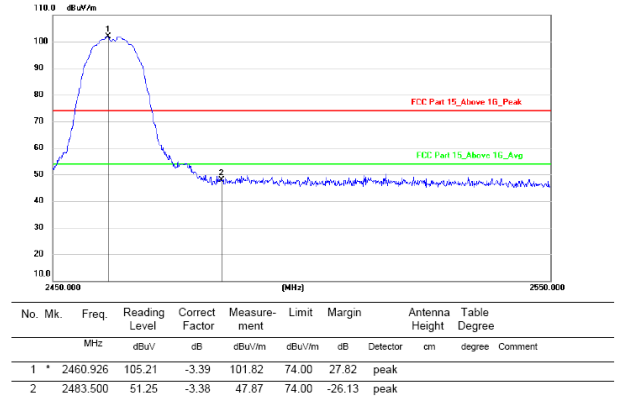

Test Mode: IEEE 802.11g-Low
Polarization: Vertical

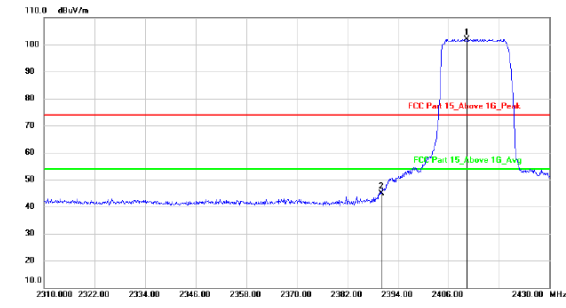

| No. | Mk. | Freq. | Reading Level | Correct Factor | Measurement | Limit | Margin | Antenna Height | Table Degree | Comment |
|-----|-----|----------|---------------|----------------|-------------|--------|--------|----------------|--------------|---------|
| | | MHz | dBuV | dB | dBuV/m | dBuV/m | dB | Detector | cm | degree |
| 1 | * | 2410.440 | 105.39 | -3.40 | 101.99 | 74.00 | 27.99 | peak | | |
| 2 | | 2390.000 | 48.29 | -3.40 | 44.89 | 74.00 | -29.11 | peak | | |

Polarization: Horizontal

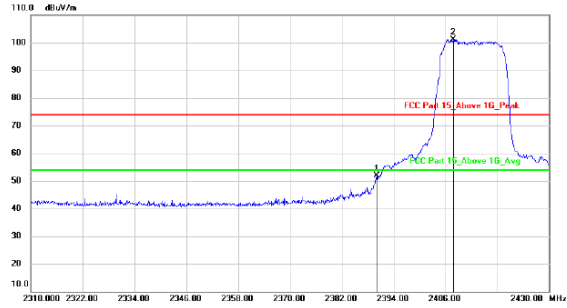

| No. | Mk. | Freq. | Reading Level | Correct Factor | Measurement | Limit | Margin | Antenna Height | Table Degree | Comment |
|-----|-----|----------|---------------|----------------|-------------|--------|--------|----------------|--------------|---------|
| | | MHz | dBuV | dB | dBuV/m | dBuV/m | dB | Detector | cm | degree |
| 1 | | 2390.000 | 55.17 | -3.40 | 51.77 | 74.00 | -22.23 | peak | | |
| 2 | * | 2407.800 | 104.59 | -3.40 | 101.19 | 74.00 | 27.19 | peak | | |

Test Mode: IEEE 802.11g-High
Polarization: Vertical

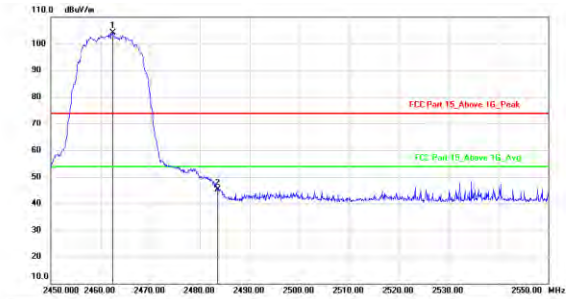

| No. | Mk. | Freq. | Reading Level | Correct Factor | Measurement | Limit | Margin | Antenna Height | Table Degree | Comment |
|-----|-----|----------|---------------|----------------|-------------|--------|--------|----------------|--------------|---------|
| | | MHz | dBuV | dB | dBuV/m | dBuV/m | dB | Detector | cm | degree |
| 1 | * | 2462.400 | 107.45 | -3.40 | 104.05 | 74.00 | 30.05 | peak | | |
| 2 | | 2483.500 | 48.50 | -3.38 | 45.12 | 74.00 | -28.88 | peak | | |

Polarization: Horizontal

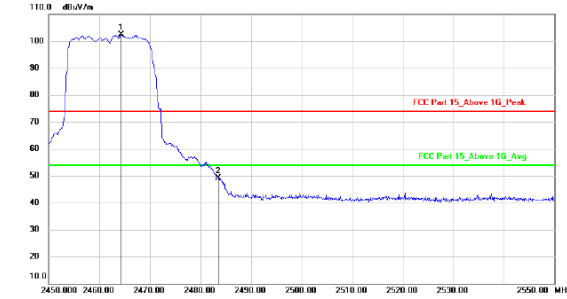

| No. | Mk. | Freq. | Reading Level | Correct Factor | Measurement | Limit | Margin | Antenna Height | Table Degree | Comment |
|-----|-----|----------|---------------|----------------|-------------|--------|--------|----------------|--------------|---------|
| | | MHz | dBuV | dB | dBuV/m | dBuV/m | dB | Detector | cm | degree |
| 1 | * | 2464.300 | 105.70 | -3.40 | 102.30 | 74.00 | 28.30 | peak | | |
| 2 | | 2483.500 | 52.60 | -3.38 | 49.22 | 74.00 | -24.78 | peak | | |

Test Mode: IEEE 802.11n20-Low
Polarization: Vertical

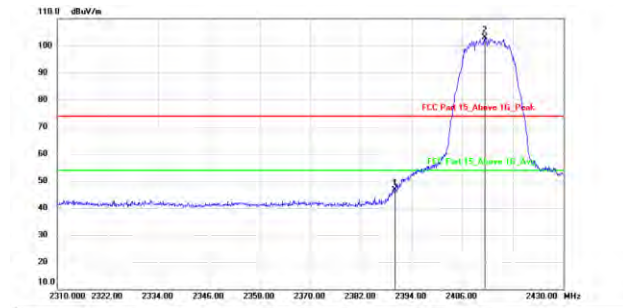

| No. | Mk. | Freq. | Reading Level | Correct Factor | Measurement | Limit | Margin | Antenna Height | Table Degree | Comment |
|-----|-----|----------|---------------|----------------|-------------|--------|--------|----------------|--------------|---------|
| | | MHz | dBuV | dB | dBuV/m | dBuV/m | dB | cm | degree | |
| 1 | * | 2390.000 | 50.02 | -3.40 | 46.62 | 74.00 | -27.38 | peak | | |
| 2 | * | 2411.400 | 106.54 | -3.40 | 103.14 | 74.00 | 29.14 | peak | | |

Polarization: Horizontal

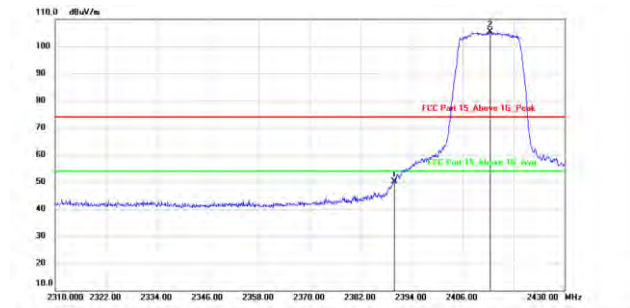

| No. | Mk. | Freq. | Reading Level | Correct Factor | Measurement | Limit | Margin | Antenna Height | Table Degree | Comment |
|-----|-----|----------|---------------|----------------|-------------|--------|--------|----------------|--------------|---------|
| | | MHz | dBuV | dB | dBuV/m | dBuV/m | dB | cm | degree | |
| 1 | * | 2390.000 | 53.49 | -3.40 | 50.09 | 74.00 | -23.91 | peak | | |
| 2 | * | 2412.480 | 108.83 | -3.41 | 105.42 | 74.00 | 31.42 | peak | | |

Test Mode: IEEE 802.11n20-High
Polarization: Vertical



| No. | Mk. | Freq. | Reading Level | Correct Factor | Measurement | Limit | Margin | Antenna Height | Table Degree | Comment |
|-----|-----|----------|---------------|----------------|-------------|--------|--------|----------------|--------------|---------|
| | | MHz | dBuV | dB | dBuV/m | dBuV/m | dB | cm | degree | |
| 1 | * | 2462.500 | 108.47 | -3.40 | 105.07 | 74.00 | 31.07 | peak | | |
| 2 | * | 2483.500 | 59.86 | -3.38 | 56.48 | 74.00 | -17.52 | peak | | |
| 3 | * | 2483.500 | 47.28 | -3.38 | 43.90 | 54.00 | -10.10 | AVG | | |

Polarization: Horizontal

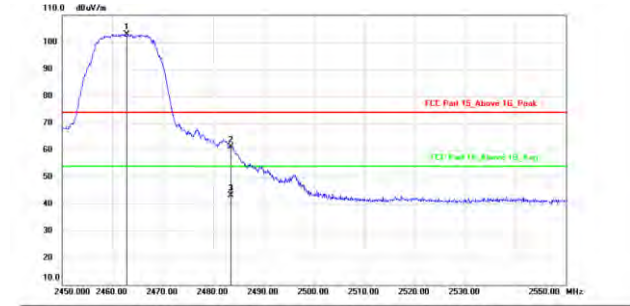

| No. | Mk. | Freq. | Reading Level | Correct Factor | Measurement | Limit | Margin | Antenna Height | Table Degree | Comment |
|-----|-----|----------|---------------|----------------|-------------|--------|--------|----------------|--------------|---------|
| | | MHz | dBuV | dB | dBuV/m | dBuV/m | dB | cm | degree | |
| 1 | * | 2462.800 | 106.37 | -3.40 | 102.97 | 74.00 | 28.97 | peak | | |
| 2 | * | 2483.500 | 64.43 | -3.38 | 61.05 | 74.00 | -12.95 | peak | | |
| 3 | * | 2483.500 | 46.58 | -3.38 | 43.20 | 54.00 | -10.80 | AVG | | |

Test Mode: IEEE 802.11n40-Low
Polarization: Vertical

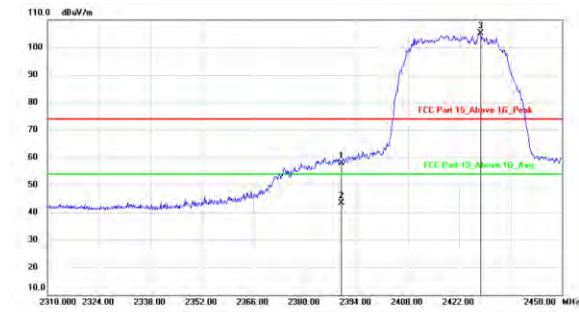

| No. | Mk. | Freq. | Reading Level | Correct Factor | Measurement | Limit | Margin | Antenna Height | Table Degree | |
|-----|-----|----------|---------------|----------------|-------------|--------|--------|----------------|--------------|---------|
| | | MHz | dBuV | dB | dBuV/m | dBuV/m | dB | cm | degree | Comment |
| 1 | | 2390.000 | 61.16 | -3.40 | 57.76 | 74.00 | -16.24 | | | peak |
| 2 | | 2390.000 | 46.79 | -3.40 | 43.39 | 54.00 | -10.61 | | | AVG |
| 3 | * | 2427.680 | 108.51 | -3.40 | 105.11 | 74.00 | 31.11 | | | peak |

Polarization: Horizontal

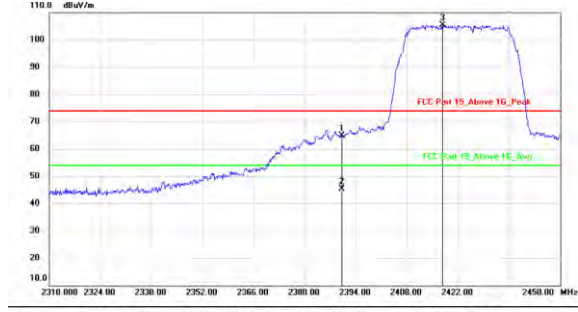

| No. | Mk. | Freq. | Reading Level | Correct Factor | Measurement | Limit | Margin | Antenna Height | Table Degree | |
|-----|-----|----------|---------------|----------------|-------------|--------|--------|----------------|--------------|---------|
| | | MHz | dBuV | dB | dBuV/m | dBuV/m | dB | cm | degree | Comment |
| 1 | | 2390.000 | 68.33 | -3.40 | 64.93 | 74.00 | -9.07 | | | peak |
| 2 | | 2390.000 | 48.71 | -3.40 | 45.31 | 54.00 | -8.69 | | | AVG |
| 3 | * | 2417.800 | 108.87 | -3.41 | 105.46 | 74.00 | 31.46 | | | peak |

Test Mode: IEEE 802.11n40-High
Polarization: Vertical

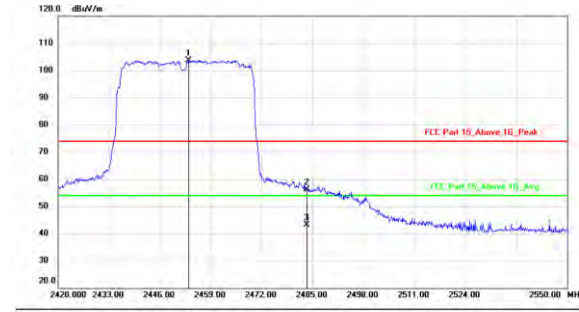

| No. | Mk. | Freq. | Reading Level | Correct Factor | Measurement | Limit | Margin | Antenna Height | Table Degree | |
|-----|-----|----------|---------------|----------------|-------------|--------|--------|----------------|--------------|---------|
| | | MHz | dBuV | dB | dBuV/m | dBuV/m | dB | cm | degree | Comment |
| 1 | * | 2453.280 | 107.11 | -3.39 | 103.72 | 74.00 | 29.72 | | | peak |
| 2 | | 2483.500 | 59.50 | -3.38 | 56.12 | 74.00 | -17.88 | | | peak |
| 3 | | 2483.500 | 46.39 | -3.38 | 43.01 | 54.00 | -10.99 | | | AVG |

Polarization: Horizontal

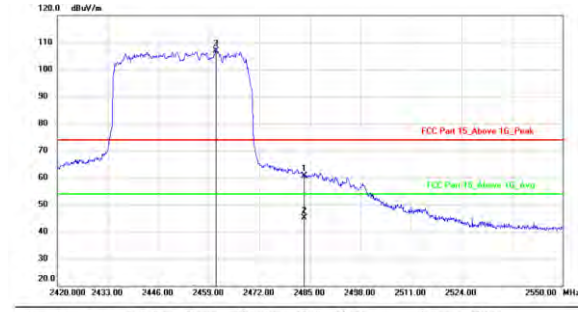

| No. | Mk. | Freq. | Reading Level | Correct Factor | Measurement | Limit | Margin | Antenna Height | Table Degree | |
|-----|-----|----------|---------------|----------------|-------------|--------|--------|----------------|--------------|---------|
| | | MHz | dBuV | dB | dBuV/m | dBuV/m | dB | cm | degree | Comment |
| 1 | | 2483.500 | 64.13 | -3.38 | 60.75 | 74.00 | -13.25 | | | peak |
| 2 | | 2483.500 | 48.63 | -3.38 | 45.25 | 54.00 | -8.75 | | | AVG |
| 3 | * | 2460.820 | 110.17 | -3.39 | 106.78 | 74.00 | 32.78 | | | peak |

Note: 1. *:Maximum data; x:Over limit; !:over margin.
2.Measurement=Reading Level+Correct Factor; Correct Factor=Antenna Factor+Cable Loss.

Test mode: 802.11b



Lowest channel



Highest channel

Test mode: 802.11g



Lowest channel



Highest channel

Test mode: 802.11n(HT20)



Lowest channel



Highest channel

Test mode: 802.11n(HT40)



Lowest channel

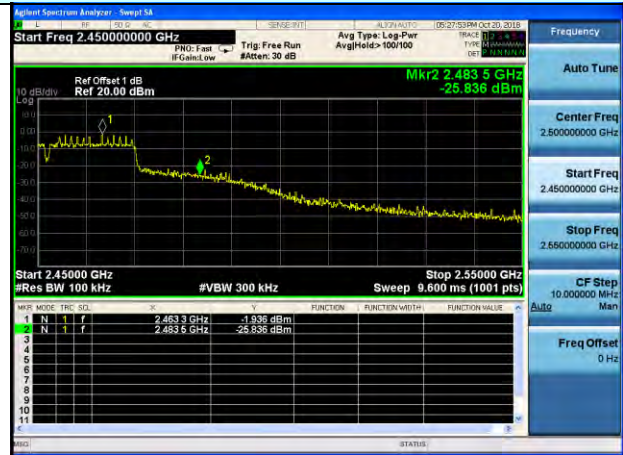

Highest channel

9. ANTENNA REQUIREMENT

9.1. Standard Requirement

An intentional radiator shall be designed to ensure that no antenna other than that furnished by the responsible party shall be used with the device. The use of a permanently attached antenna or of an antenna that uses a unique coupling to the intentional radiator shall be considered sufficient to comply with the provisions of this Section. The manufacturer may design the unit so that a broken antenna can be replaced by the user, but the use of a standard antenna jack or electrical connector is prohibited.

9.2. Antenna Connected Construction

The PCB antenna used for transmitting is 0dBi, and the antenna is on PCB board and no consideration of replacement. Please see EUT photo for details.

9.3. Results

The EUT antenna is PCB Antenna. It complies with the standard requirement.

10. TEST SETUP PHOTO

10.1. Photos of Radiated emission



10.2.Photos of Conducted Emission test



11.EUT PHOTO

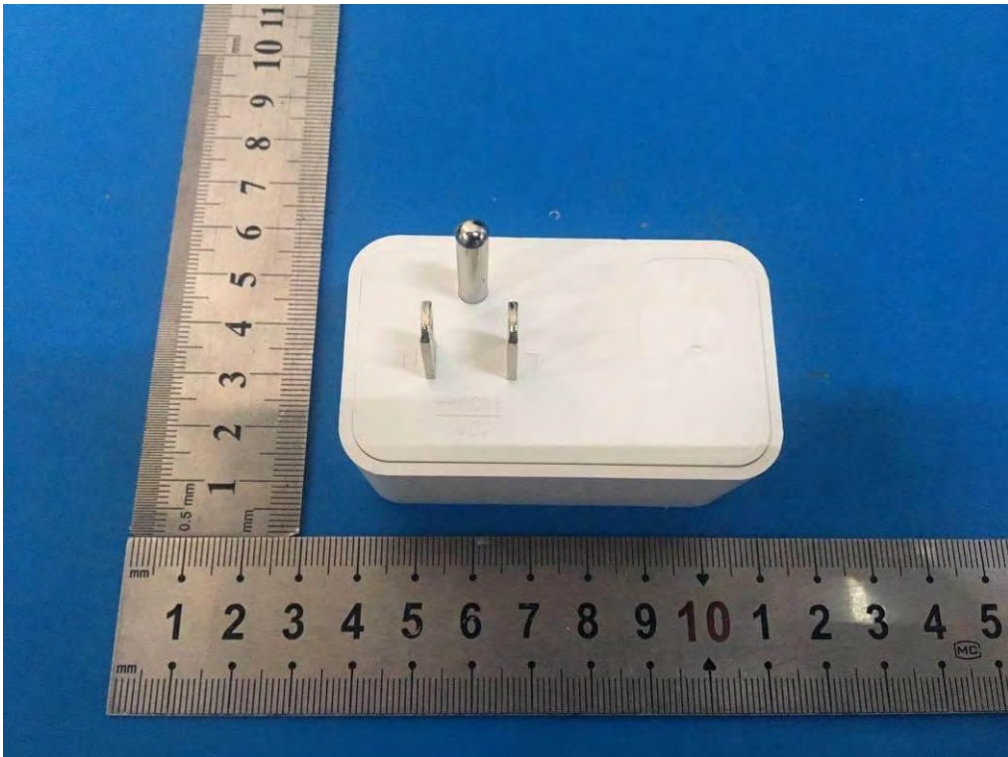

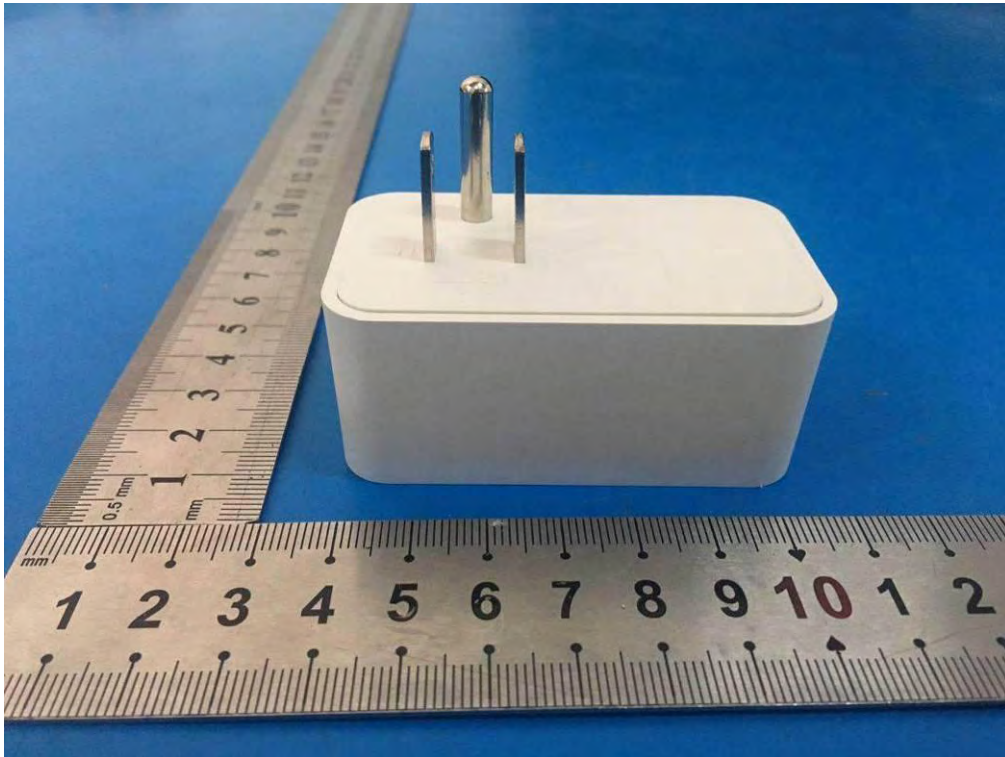

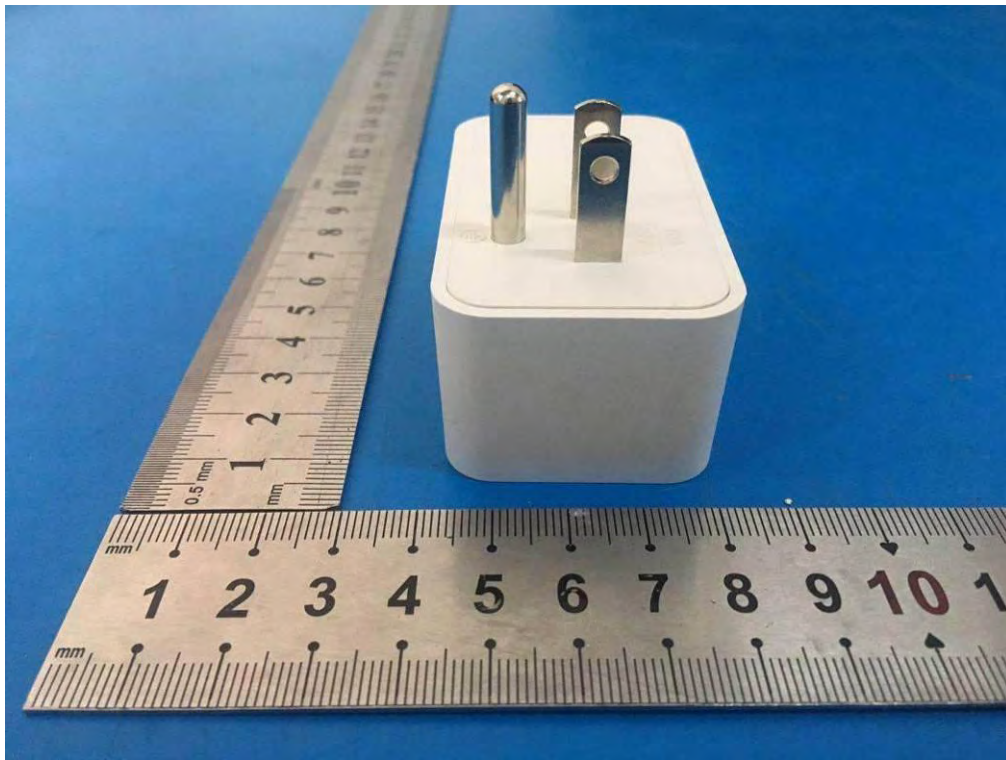

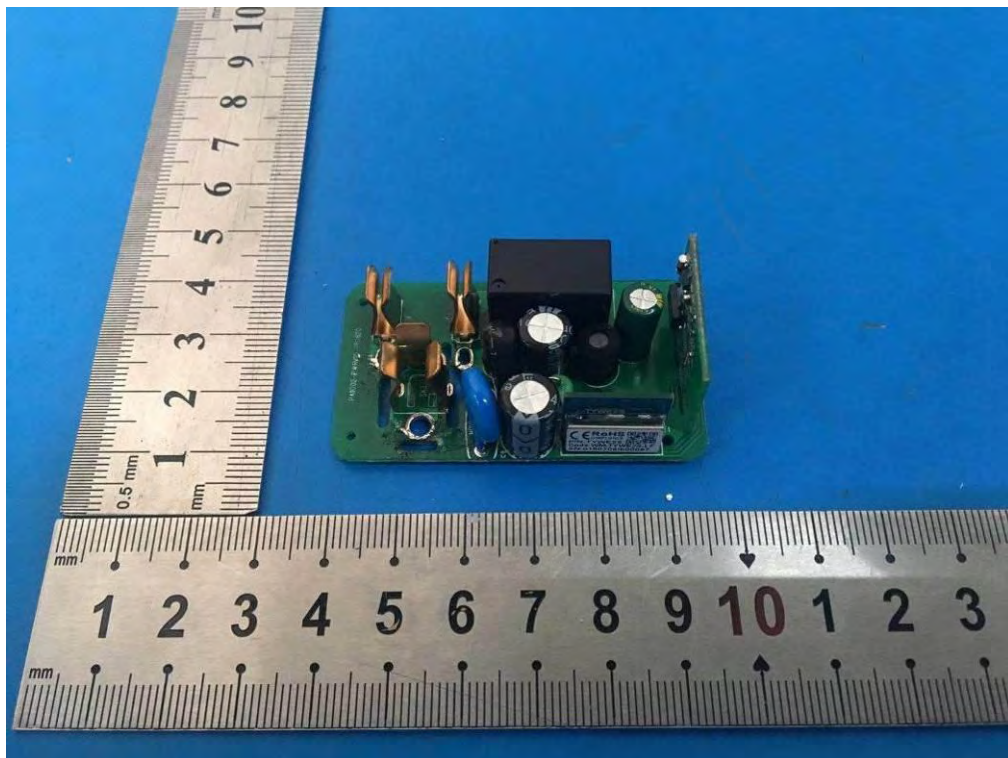

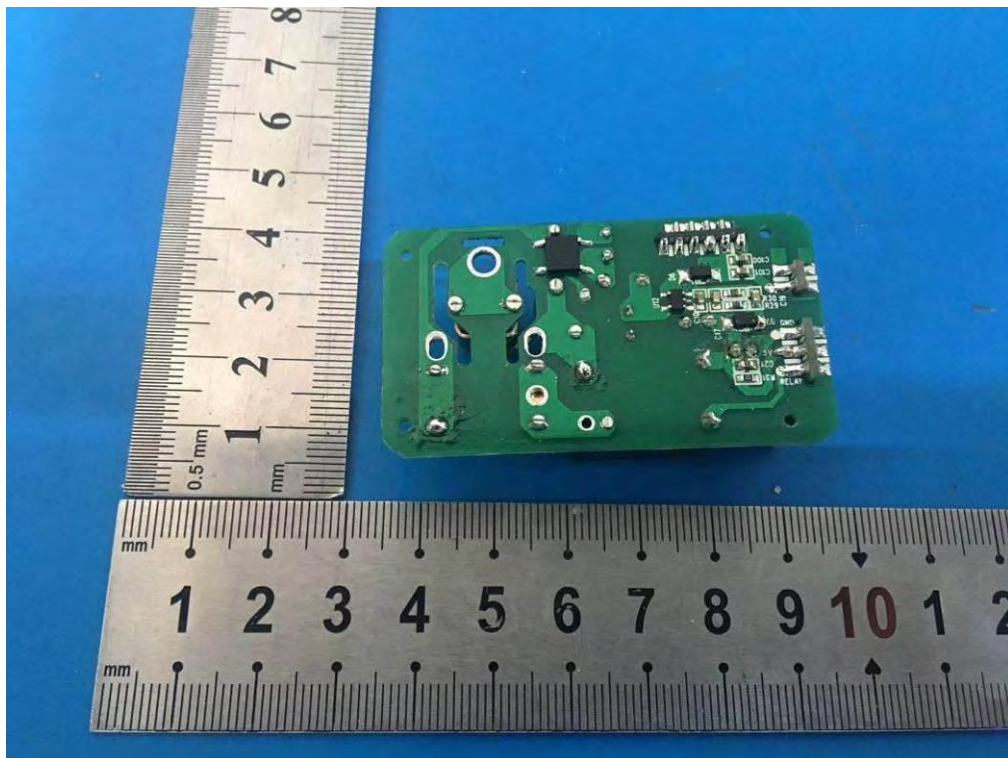
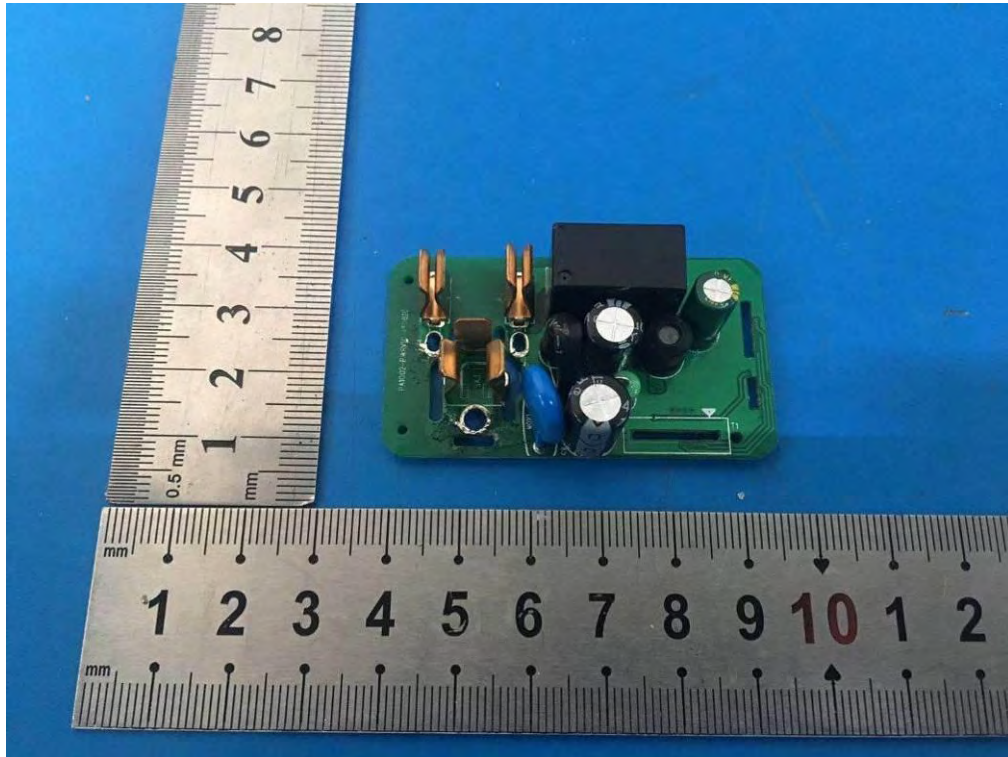

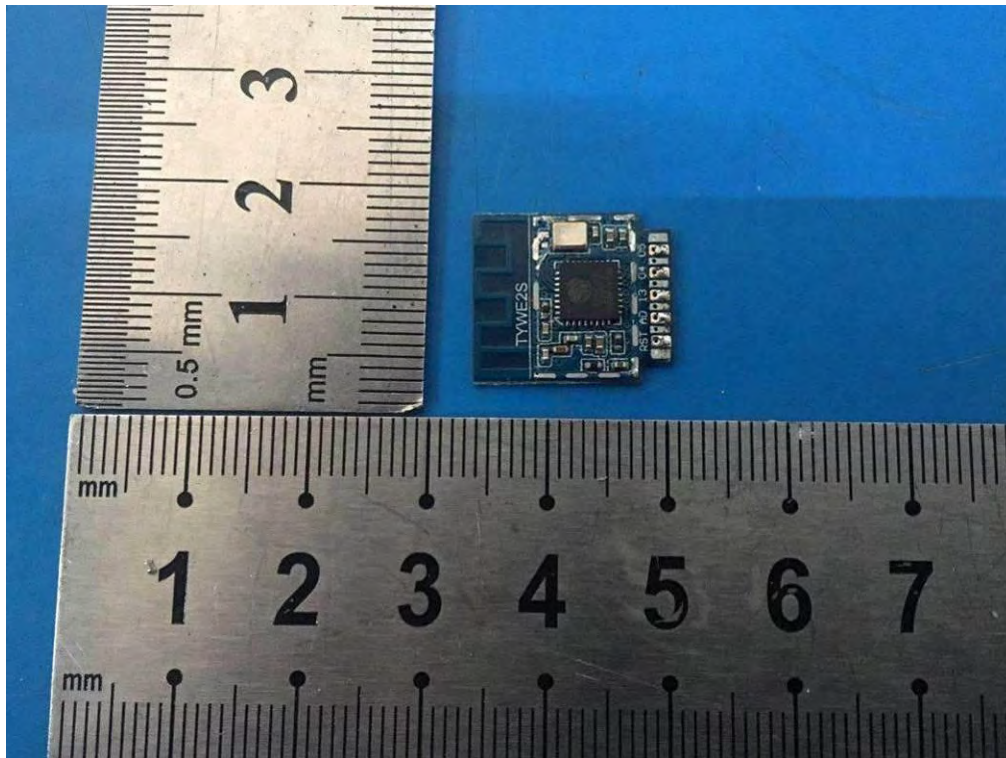
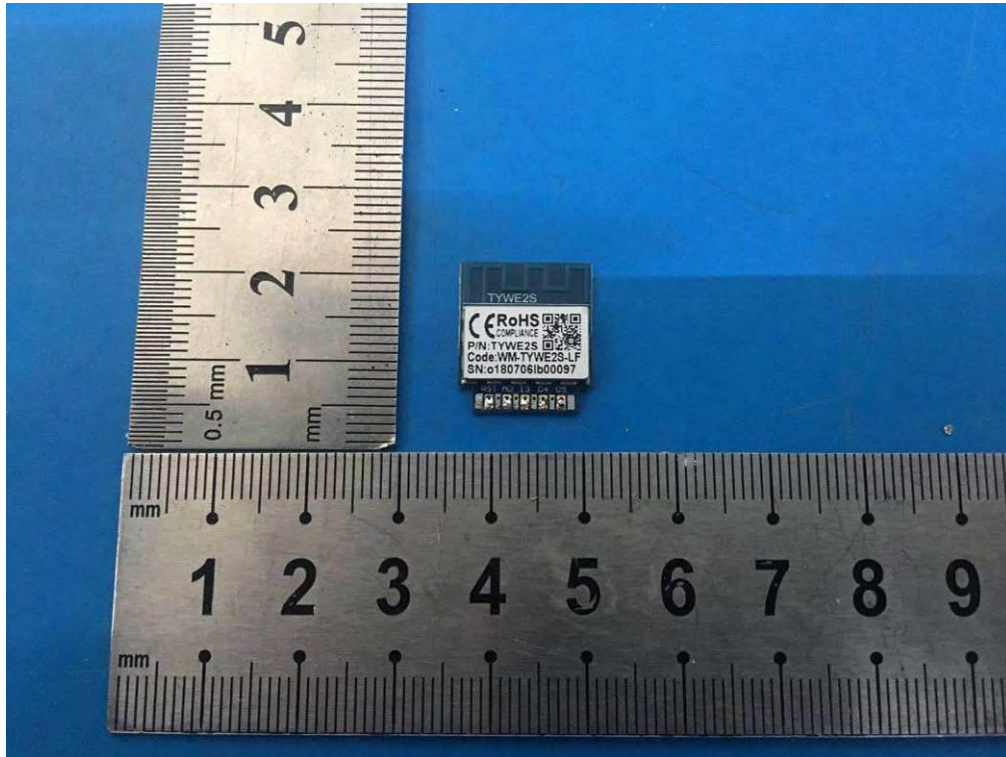

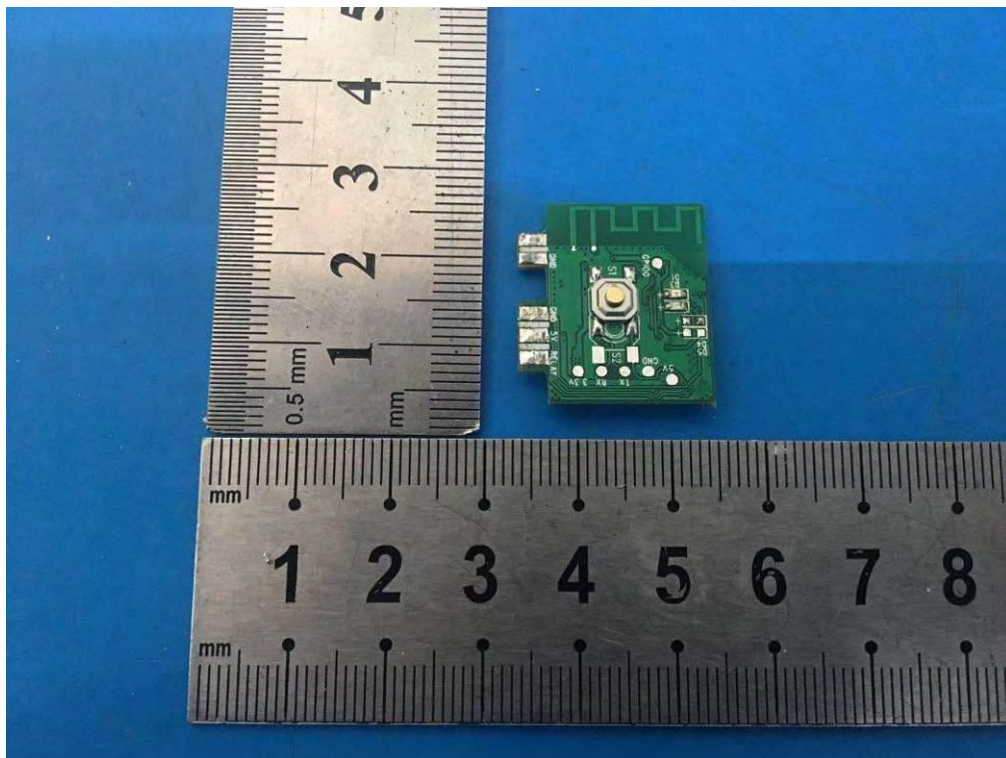
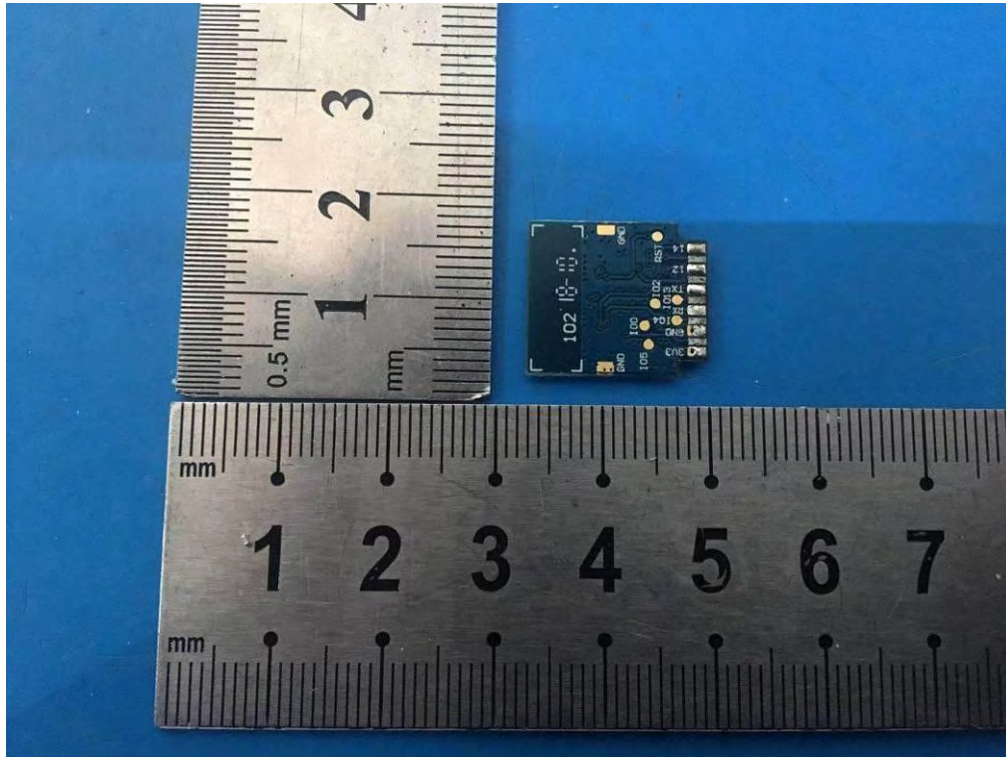

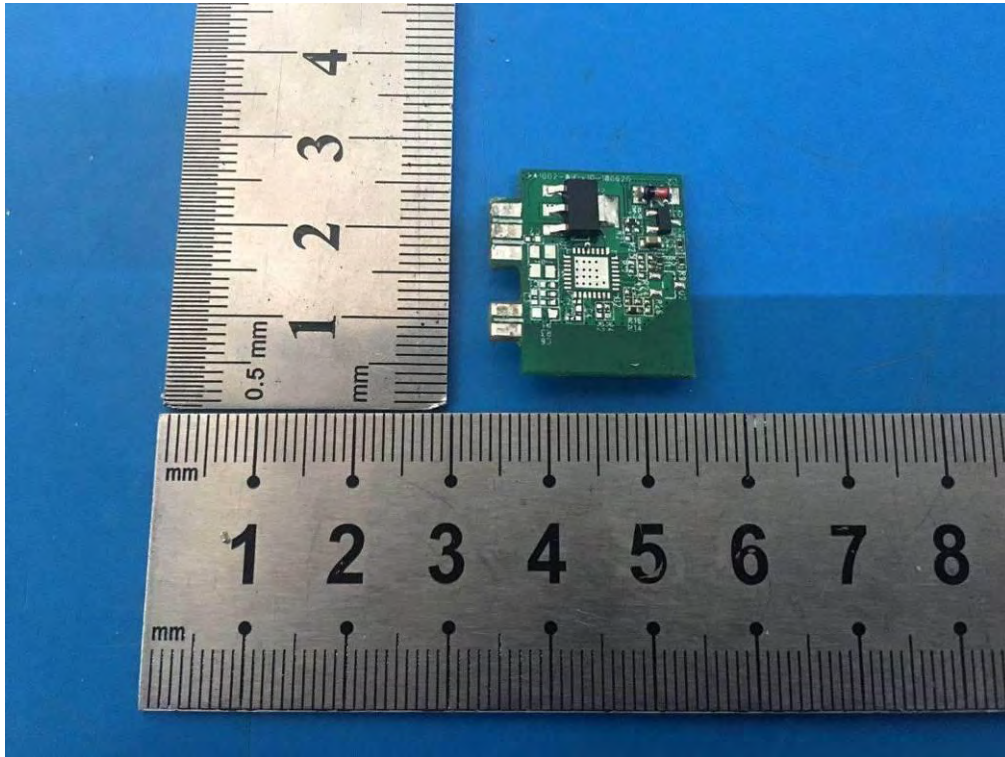

-----THE END OF REPORT-----