

FCC Test Report

Product Name	Wireless module
Model No.	LBEE5ZZ1GV-893
FCC ID.	2AAD3JA0M0P0

Applicant	ABILITY ENTERPRISE CO., LTD.
Address	4 Fl., No.8, Lane7, Wuchiuan Rd, Wugu Dist., New Taipei City 248, Taiwan, (R.O.C.)

Date of Receipt	Oct. 27, 2015
Issued Date	Dec. 03, 2015
Report No.	15B0029R-RFUSP01V00-E
Report Version	V1.0



The test results relate only to the samples tested.

The test results shown in the test report are traceable to the national/international standard through the calibration report of the equipment and evaluated measurement uncertainty herein.

This report must not be used to claim product endorsement by TAF or any agency of the government.

The test report shall not be reproduced without the written approval of QuieTek Corporation.

Test Report

Issued Date: Dec. 03, 2015

Report No.: 15B0029R-RFUSP01V00-E



Product Name	Wireless module
Applicant	ABILITY ENTERPRISE CO., LTD.
Address	4 Fl., No.8, Lane7, Wuchiuan Rd, Wugu Dist., New Taipei City 248, Taiwan, (R.O.C.)
Manufacturer	ABILITY ENTERPRISE CO., LTD.
Model No.	LBEE5ZZ1GV-893
FCC ID.	2AAD3JA0M0P0
EUT Rated Voltage	DC 3.3V
EUT Test Voltage	DC 3.3V
Trade Name	Nikon
Applicable Standard	FCC CFR Title 47 Part 15 Subpart C: 2014 ANSI C63.4: 2014, ANSI C63.10: 2013 KDB 558074 D01 DTS Meas Guidance v03r03
Test Result	Complied

Documented By :

(Senior Adm. Specialist / Joanne Lin)

Tested By :

(Engineer / Eason Chen)

Approved By :

(Director / Vincent Lin)

TABLE OF CONTENTS

Description	Page
1. GENERAL INFORMATION	4
1.1. EUT Description.....	4
1.2. Operational Description.....	6
1.3. Tested System Details.....	7
1.4. Configuration of Tested System	7
1.5. EUT Exercise Software	7
1.6. Test Facility	8
2. CONDUCTED EMISSION	9
2.1. Test Equipment	9
2.2. Test Setup	9
2.3. Limits.....	10
2.4. Test Procedure	10
2.5. Uncertainty	10
2.6. Test Result of Conducted Emission.....	11
3. PEAK POWER OUTPUT	13
3.1. Test Equipment	13
3.2. Test Setup	13
3.3. Limit	13
3.4. Test Procedure	13
3.5. Uncertainty	13
3.6. Test Result of Peak Power Output	14
4. RADIATED EMISSION	15
4.1. Test Equipment	15
4.2. Test Setup	15
4.3. Limits.....	16
4.4. Test Procedure	17
4.5. Uncertainty	17
4.6. Test Result of Radiated Emission.....	18
5. RF ANTENNA CONDUCTED TEST	22
5.1. Test Equipment	22
5.2. Test Setup	22
5.3. Limits.....	22
5.4. Test Procedure	22
5.5. Uncertainty	22
5.6. Test Result of RF Antenna Conducted Test	23
6. BAND EDGE	24
6.1. Test Equipment	24
6.2. Test Setup	24
6.3. Limit	25
6.4. Test Procedure	25
6.5. Uncertainty	25
6.6. Test Result of Band Edge	26
7. OCCUPIED BANDWIDTH (6DB BW).....	30
7.1. Test Equipment	30
7.2. Test Setup	30
7.3. Limits.....	30
7.4. Test Procedure	30
7.5. Uncertainty	30
7.6. Test Result of Occupied Bandwidth	31
8. POWER DENSITY	33
8.1. Test Equipment	33
8.2. Test Setup	33
8.3. Limits.....	33
8.4. Test Procedure	33
8.5. Uncertainty	33
8.6. Test Result of Power Density	34
9. EMI REDUCTION METHOD DURING COMPLIANCE TESTING	36
Attachment 1: EUT Test Photographs	
Attachment 2: EUT Detailed Photographs	

1. GENERAL INFORMATION

1.1. EUT Description

Product Name	Wireless module
Trade Name	Nikon
Model No.	LBEE5ZZ1GV-893
FCC ID.	2AAD3JA0M0P0
Frequency Range	2402 – 2480MHz
Channel Number	V4.0: 40CH
Type of Modulation	V4.0: GFSK(1Mbps)
Antenna Type	PCB Antenna
Channel Control	Auto
Antenna Gain	Refer to the table “Antenna List”

Antenna List

No.	Manufacturer	Part No.	Antenna Type	Peak Gain
1	Murata Manufacturing Co., Ltd.	Type1GV(LBEE5ZZ1GV)	PCB	-0.1dBi for 2.4 GHz

Note: The antenna of EUT is conform to FCC 15.203.

Center Frequency of Each Channel: (For V4.0)

Channel	Frequency	Channel	Frequency	Channel	Frequency	Channel	Frequency
Channel 00:	2402 MHz	Channel 01:	2404 MHz	Channel 02:	2406 MHz	Channel 03:	2408 MHz
Channel 04:	2410 MHz	Channel 05:	2412 MHz	Channel 06:	2414 MHz	Channel 07:	2416 MHz
Channel 08:	2418 MHz	Channel 09:	2420 MHz	Channel 10:	2422 MHz	Channel 11:	2424 MHz
Channel 12:	2426 MHz	Channel 13:	2428 MHz	Channel 14:	2430 MHz	Channel 15:	2432 MHz
Channel 16:	2434 MHz	Channel 17:	2436 MHz	Channel 18:	2438 MHz	Channel 19:	2440 MHz
Channel 20:	2442 MHz	Channel 21:	2444 MHz	Channel 22:	2446 MHz	Channel 23:	2448 MHz
Channel 24:	2450 MHz	Channel 25:	2452 MHz	Channel 26:	2454 MHz	Channel 27:	2456 MHz
Channel 28:	2458 MHz	Channel 29:	2460 MHz	Channel 30:	2462 MHz	Channel 31:	2464 MHz
Channel 32:	2466 MHz	Channel 33:	2468 MHz	Channel 34:	2470 MHz	Channel 35:	2472 MHz
Channel 36:	2474 MHz	Channel 37:	2476 MHz	Channel 38:	2478 MHz	Channel 39:	2480 MHz

Note:

1. The EUT is a Wireless module with a built-in WLAN and Bluetooth transceiver, this report for Bluetooth V4.0.
2. These tests were conducted on a sample for the purpose of demonstrating compliance of Bluetooth transmitter with Part 15 Subpart C Paragraph 15.247 for spread spectrum devices.
3. Regarding to the operation frequency, the lowest, middle and highest frequency are selected to perform the test.
4. The radiation measurements are performed in X, Y, Z axis positioning. Only the worst case is shown in the report.

Test Mode	Mode 1: Transmit - BLE (GFSK)
-----------	-------------------------------

1.3. Tested System Details

The types for all equipment, plus descriptions of all cables used in the tested system (including inserted cards) are:

Product	Manufacturer	Model No.	Serial No.	Power Cord	
1	Notebook PC	DELL	Latitude E5440	FS9TK32	Non-Shielded, 0.8m
2	LCD Monitor	ASUS	VS229HA	F4LMQS135395	Non-Shielded, 1.8m
3	Test Fixture	ABILITY	N/A	N/A	N/A

Signal Cable Type	Signal cable Description	
A	USB Cable	Shielded, 1.8m, with one ferrite core bonded.
B	HDMI Cable	Non-Shielded, 1.8m

1.4. Configuration of Tested System

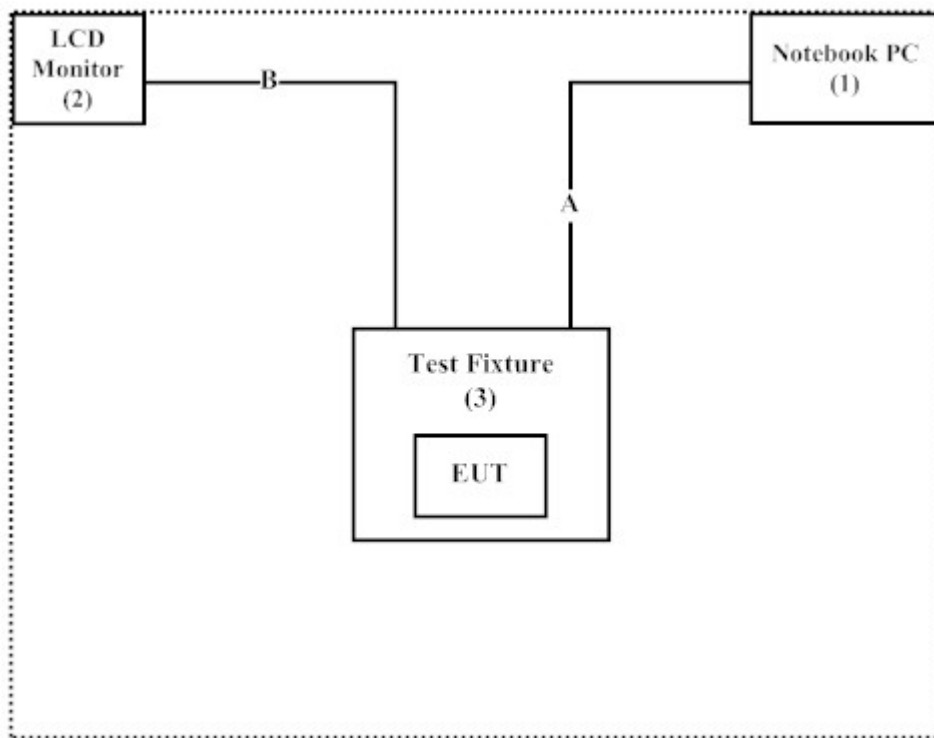

1.5. EUT Exercise Software

1. Setup the EUT as shown in Section 1.4.
2. Execute software "Sample_Project MFC Application V1.1.0.1" on the EUT.
3. Configure the test mode, the test channel, and the data rate.
4. Press "OK" to start the continuous Transmit.
5. Verify that the EUT works properly.

1.6. Test Facility

Ambient conditions in the laboratory:

Items	Required (IEC 68-1)	Actual
Temperature (°C)	15-35	20-35
Humidity (%RH)	25-75	30-65
Barometric pressure (mbar)	860-1060	950-1000

The related certificate for our laboratories about the test site and management system can be downloaded from

Quietek Corporation's Web Site: <http://www.quietek.com/chinese/about/certificates.aspx?bval=5>

The address and introduction of Quietek Corporation's laboratories can be founded in our Web site:

<http://www.quietek.com/>

Site Description: File on
 Federal Communications Commission
 FCC Engineering Laboratory
 7435 Oakland Mills Road
 Columbia, MD 21046
 Registration Number: 92195

Site Name: Quietek Corporation
 Site Address: No.5-22, Ruishukeng,
 Linkou Dist. New Taipei City 24451,
 Taiwan, R.O.C.
 TEL: 886-2-8601-3788 / FAX : 886-2-8601-3789
 E-Mail : service@quietek.com

FCC Accreditation Number: TW1014

2. Conducted Emission

2.1. Test Equipment

	Equipment	Manufacturer	Model No. / Serial No.	Last Cal.	Remark
X	Test Receiver	R & S	ESCS 30 / 825442/018	Sep., 2015	
X	Artificial Mains Network	R & S	ENV4200 / 848411/10	Feb., 2015	Peripherals
X	LISN	R & S	ESH3-Z5 / 825562/002	Feb., 2015	EUT
	DC LISN	Schwarzbeck	8226 / 176	Mar., 2015	EUT
X	Pulse Limiter	R & S	ESH3-Z2 / 357.8810.52	Feb., 2015	
	No.1 Shielded Room				

Note:

1. All equipments are calibrated every one year.
2. The test instruments marked by “X” are used to measure the final test results.

2.2. Test Setup

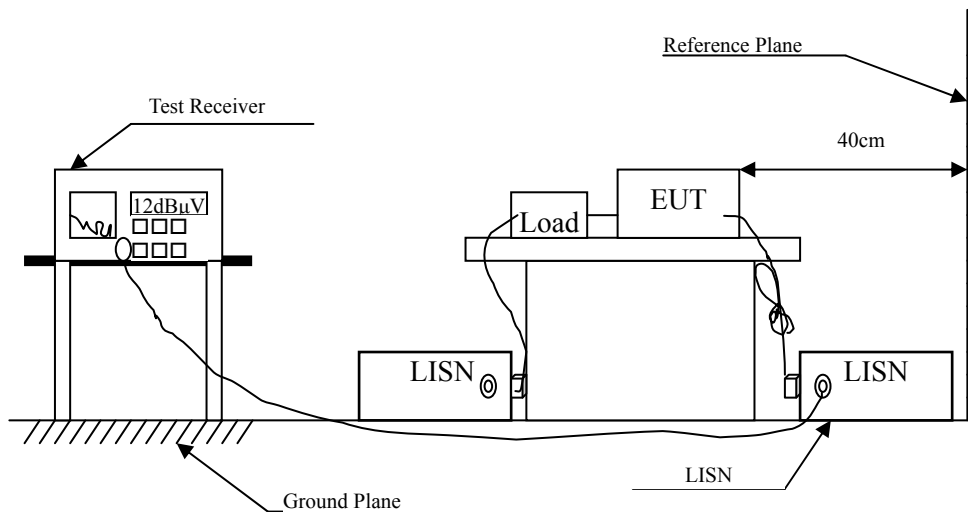

2.3. Limits

FCC Part 15 Subpart C Paragraph 15.207 (dBµV) Limit		
Frequency MHz	Limits	
	QP	AV
0.15 - 0.50	66-56	56-46
0.50-5.0	56	46
5.0 - 30	60	50

Remarks: In the above table, the tighter limit applies at the band edges.

2.4. Test Procedure

The EUT and Peripherals are connected to the main power through a line impedance stabilization network (L.I.S.N.). This provides a 50 ohm /50uH coupling impedance for the measuring equipment. The peripheral devices are also connected to the main power through a LISN that provides a 50ohm /50uH coupling impedance with 50ohm termination. (Please refer to the block diagram of the test setup and photographs.)

Both sides of A.C. line are checked for maximum conducted interference. In order to find the maximum emission, the relative positions of equipment and all the interface cables must be changed according to ANSI C63.4: 2014 on conducted measurement.

Conducted emissions were investigated over the frequency range from 0.15MHz to 30MHz using a receiver bandwidth of 9kHz.

The EUT was setup to ANSI C63.4: 2014; tested to FHSS test procedure of FCC Public Notice DA 00-705 for compliance to FCC 47CFR 15.247 requirements.

2.5. Uncertainty

± 2.26 dB

2.6. Test Result of Conducted Emission

Product : Wireless module
 Test Item : Conducted Emission Test
 Power Line : Line 1
 Test Mode : Mode 1: Transmit - BLE (GFSK)

Frequency MHz	Correct Factor dB	Reading Level dBµV	Measurement Level dBµV	Margin dB	Limit dBµV
LINE 1					
Quasi-Peak					
0.162	9.761	23.450	33.211	-32.446	65.657
0.185	9.755	27.420	37.175	-27.825	65.000
0.209	9.755	43.360	53.115	-11.199	64.314
0.224	9.757	30.670	40.427	-23.459	63.886
0.236	9.758	26.680	36.438	-27.105	63.543
0.271	9.760	22.130	31.890	-30.653	62.543
Average					
0.162	9.761	18.100	27.861	-27.796	55.657
0.185	9.755	12.620	22.375	-32.625	55.000
0.209	9.755	40.710	50.465	-3.849	54.314
0.224	9.757	22.070	31.827	-22.059	53.886
0.236	9.758	17.790	27.548	-25.995	53.543
0.271	9.760	14.650	24.410	-28.133	52.543

Note:

1. All Reading Levels are Quasi-Peak and average value.
2. "█" means the worst emission level.
3. Measurement Level = Reading Level + Correct Factor

Product : Wireless module
 Test Item : Conducted Emission Test
 Power Line : Line 2
 Test Mode : Mode 1: Transmit - BLE (GFSK)

Frequency MHz	Correct Factor dB	Reading Level dBμV	Measurement Level dBμV	Margin dB	Limit dBμV
LINE 2					
Quasi-Peak					
0.166	9.760	19.380	29.140	-36.403	65.543
0.197	9.755	27.320	37.075	-27.582	64.657
0.209	9.755	41.610	51.365	-12.949	64.314
0.224	9.757	25.830	35.587	-28.299	63.886
0.255	9.759	18.830	28.589	-34.411	63.000
0.314	9.764	27.050	36.814	-24.500	61.314
Average					
0.166	9.760	12.760	22.520	-33.023	55.543
0.197	9.755	8.590	18.345	-36.312	54.657
0.209	9.755	35.010	44.765	-9.549	54.314
0.224	9.757	8.700	18.457	-35.429	53.886
0.255	9.759	11.630	21.389	-31.611	53.000
0.314	9.764	20.990	30.754	-20.560	51.314

Note:

1. All Reading Levels are Quasi-Peak and average value.
2. "█" means the worst emission level.
3. Measurement Level = Reading Level + Correct Factor

3. Peak Power Output

3.1. Test Equipment

	Equipment	Manufacturer	Model No./Serial No.	Last Cal.
X	Power Meter	Anritsu	ML2495A/6K00003357	May, 2015
X	Power Sensor	Anritsu	MA2411B/0738448	Jun., 2015

Note: 1. All equipments are calibrated every one year.
 2. The test instruments marked by “X” are used to measure the final test results.

3.2. Test Setup

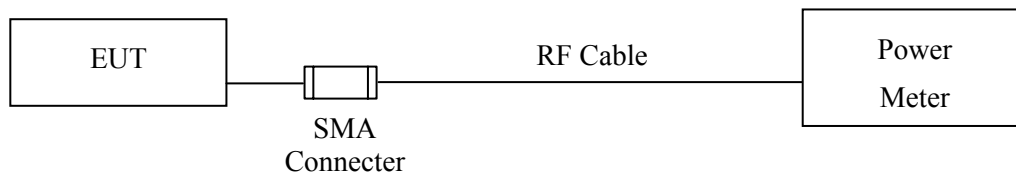

3.3. Limit

The maximum peak power shall be less 1Watt.

3.4. Test Procedure

Tested according to DTS test procedure of KDB 558074 for compliance to FCC 47CFR 15.247 requirements. The maximum peak conducted output power using KDB 558074 section 9.1.2 PKPM1 Peak power meter method.

3.5. Uncertainty

± 1.27 dB

3.6. Test Result of Peak Power Output

Product : Wireless module
 Test Item : Peak Power Output
 Test Site : No.3 OATS
 Test Mode : Mode 1: Transmit - BLE (GFSK)

Channel No.	Frequency (MHz)	Measurement (dBm)	Required Limit	Result
Channel 00	2402.00	3.85	1 Watt= 30 dBm	Pass
Channel 19	2440.00	3.98	1 Watt= 30 dBm	Pass
Channel 39	2480.00	3.99	1 Watt= 30 dBm	Pass

4. Radiated Emission

4.1. Test Equipment

The following test equipments are used during the radiated emission test:

Test Site		Equipment	Manufacturer	Model No./Serial No.	Last Cal.
Site # 3	X	Loop Antenna	Teseq	HLA6120 / 26739	Jul., 2015
	X	Bilog Antenna	Schaffner Chase	CBL6112B/2673	Sep., 2015
	X	Horn Antenna	Schwarzbeck	BBHA9120D/D305	Sep., 2015
	X	Horn Antenna	Schwarzbeck	BBHA9170/208	Jul., 2015
	X	Pre-Amplifier	Agilent	8447D/2944A09549	Sep., 2015
	X	Spectrum Analyzer	Agilent	E4407B / US39440758	May, 2015
	X	Test Receiver	R & S	ESCS 30/ 825442/018	Sep., 2015
	X	Coaxial Cable	Quietek	QTK-CABLE/ CAB5	Feb., 2015
	X	Controller	Quietek	QTK-CONTROLLER/ CTRL3	N/A
	X	Coaxial Switch	Anritsu	MP59B/6200265729	N/A

- Note:
1. All equipments are calibrated every one year.
 2. The test instruments marked by "X" are used to measure the final test results.

4.2. Test Setup

Below 1GHz

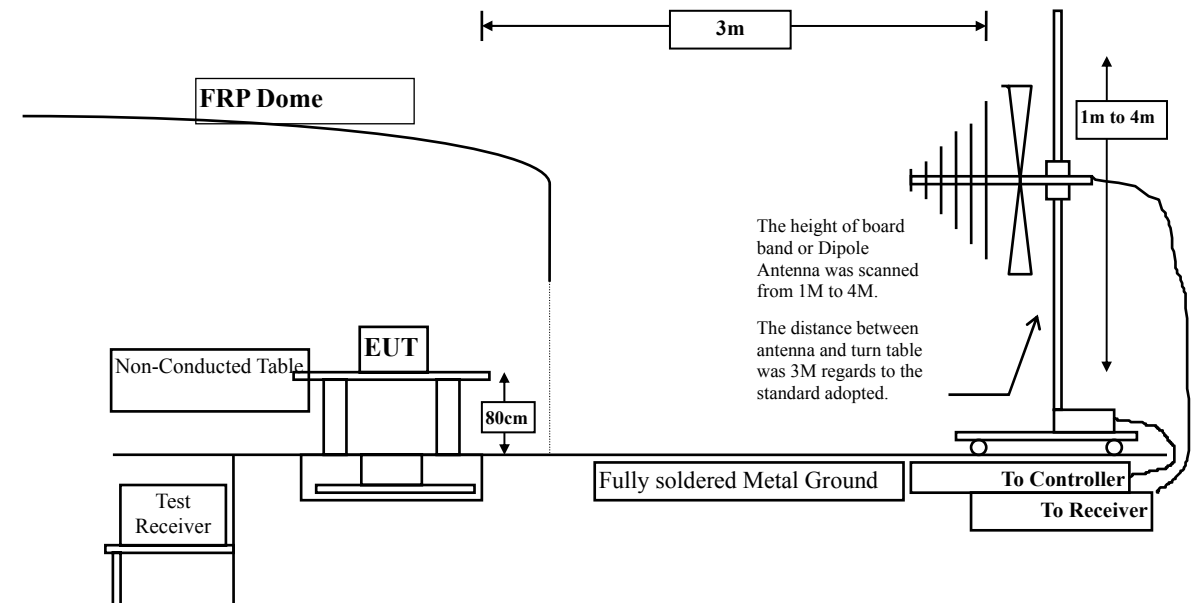

Above 1GHz

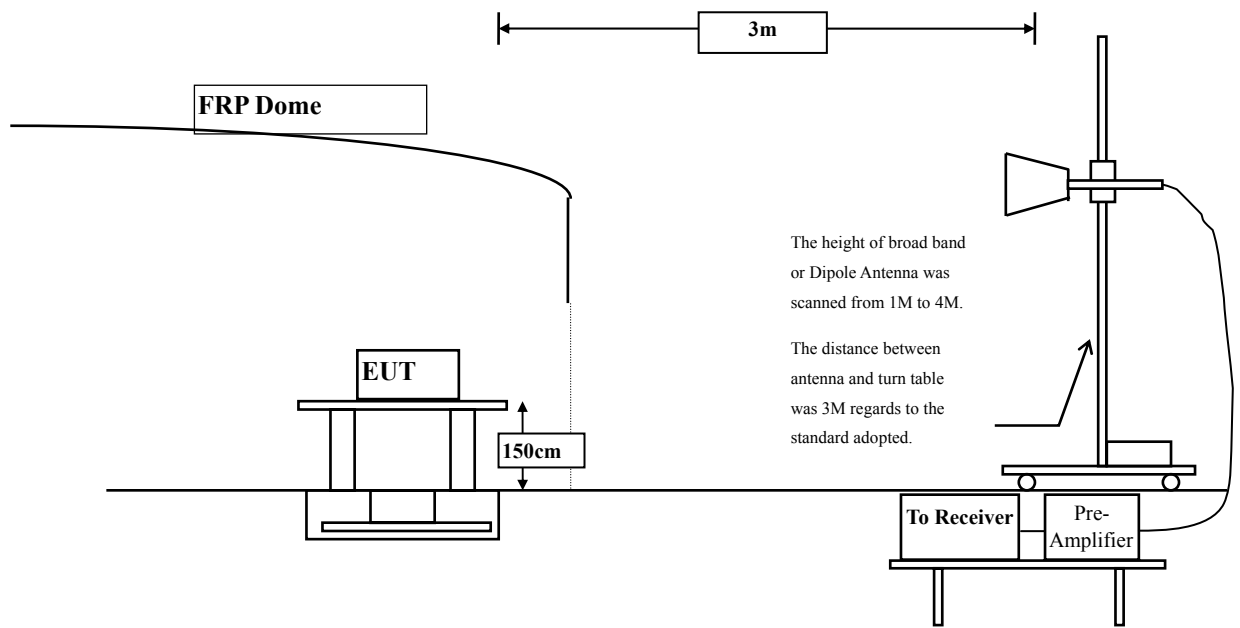

4.3. Limits

➤ General Radiated Emission Limits

Emissions radiated outside of the specified frequency bands, except for harmonics, shall be attenuated by at least 20dB below the level of the fundamental or to the general radiated emission limits in paragraph 15.209, whichever is the lesser attenuation.

FCC Part 15 Subpart C Paragraph 15.209 Limits		
Frequency MHz	Field strength (microvolts/meter)	Measurement distance (meter)
0.009-0.490	2400/F(kHz)	300
0.490-1.705	24000/F(kHz)	30
1.705-30	30	30
30-88	100	3
88-216	150	3
216-960	200	3
Above 960	500	3

- Remarks:
1. RF Voltage (dB μ V) = 20 log RF Voltage (uV)
 2. In the Above Table, the tighter limit applies at the band edges.
 3. Distance refers to the distance in meters between the measuring instrument antenna and the closed point of any part of the device or system.

4.4. Test Procedure

The EUT was setup according to ANSI C63.10: 2013 and tested according to DTS test procedure of KDB558074 for compliance to FCC 47CFR 15.247 requirements.

Measuring the frequency range below 1GHz, the EUT is placed on a turn table which is 0.8 meter above ground, when measuring the frequency range above 1GHz, the EUT is placed on a turn table which is 1.5 meter above ground.

The turn table is rotated 360 degrees to determine the position of the maximum emission level.

The EUT was positioned such that the distance from antenna to the EUT was 3 meters.

The antenna is scanned between 1 meter and 4 meters to find out the maximum emission level. This is repeated for both horizontal and vertical polarization of the antenna. In order to find the maximum emission, all of the interface cables were manipulated according to ANSI C63.10: 2013 on radiated measurement.

The resolution bandwidth below 30MHz setting on the field strength meter is 9kHz and 30MHz~1GHz is 120kHz and above 1GHz is 1MHz.

Radiated emission measurements below 30MHz are made using Loop Antenna and 30MHz~1GHz are made using broadband Bilog antenna and above 1GHz are made using Horn Antennas.

The measurement is divided into the Preliminary Measurement and the Final Measurement.

The suspected frequencies are searched for in Preliminary Measurement with the measurement antenna kept pointed at the source of the emission both in azimuth and elevation, with the polarization of the antenna oriented for maximum response. The antenna is pointed at an angle towards the source of the emission, and the EUT is rotated in both height and polarization to maximize the measured emission. The emission is kept within the illumination area of the 3 dB bandwidth of the antenna.

The worst radiated emission is measured in the Open Area Test Site on the Final Measurement.

The measurement frequency range from 9kHz - 10th Harmonic of fundamental was investigated.

4.5. Uncertainty

± 3.9 dB above 1GHz

± 3.8 dB below 1GHz

4.6. Test Result of Radiated Emission

Product : Wireless module
 Test Item : Harmonic Radiated Emission
 Test Site : No.3 OATS
 Test Mode : Mode 1: Transmit - BLE (GFSK)(2402MHz)

Frequency MHz	Correct Factor dB	Reading Level dBµV	Measurement Level dBµV/m	Margin dB	Limit dBµV/m
Horizontal					
Peak Detector:					
4804.000	2.511	44.330	46.840	-27.160	74.000
7206.000	9.511	39.360	48.871	-25.129	74.000
9608.000	10.394	38.930	49.324	-24.676	74.000
Average Detector:					
--					
Vertical					
Peak Detector:					
4804.000	2.923	43.460	46.382	-27.618	74.000
7206.000	9.988	39.340	49.329	-24.671	74.000
9608.000	10.847	38.910	49.757	-24.243	74.000
Average Detector:					
--					

Note:

1. All Readings below 1GHz are Quasi-Peak, above 1GHz are performed with peak and/or average measurements as necessary.
2. Peak measurements: RBW = 1MHz, VBW = 3 MHz, Sweep: Auto.
3. Average measurements: RBW = 1MHz, VBW = 10 Hz, Sweep: Auto.
4. Measurement Level = Reading Level + Correct Factor.
5. Correct Factor = Antenna factor + Cable loss – Amplifier gain.
6. The average measurement was not performed when the peak measured data under the limit of average detection.
7. The emission levels of other frequencies are very lower than the limit and not show in test report.

Product : Wireless module
 Test Item : Harmonic Radiated Emission
 Test Site : No.3 OATS
 Test Mode : Mode 1: Transmit - BLE (GFSK) (2440MHz)

Frequency MHz	Correct Factor dB	Reading Level dBμV	Measurement Level dBμV/m	Margin dB	Limit dBμV/m
------------------	-------------------------	--------------------------	--------------------------------	--------------	-----------------

Horizontal

Peak Detector:

4880.000	2.038	43.550	45.588	-28.412	74.000
7320.000	9.699	39.340	49.039	-24.961	74.000
9760.000	9.665	39.300	48.965	-25.035	74.000

Average

Detector:

--

Vertical

Peak Detector:

4880.000	2.499	42.400	44.899	-29.101	74.000
7320.000	10.303	40.250	50.553	-23.447	74.000
9760.000	10.299	38.390	48.690	-25.310	74.000

Average

Detector:

--

Note:

1. All Readings below 1GHz are Quasi-Peak, above 1GHz are performed with peak and/or average measurements as necessary.
2. Peak measurements: RBW = 1MHz, VBW = 3 MHz, Sweep: Auto.
3. Average measurements: RBW = 1MHz, VBW = 10 Hz, Sweep: Auto.
4. Measurement Level = Reading Level + Correct Factor.
5. Correct Factor = Antenna factor + Cable loss – Amplifier gain.
6. The average measurement was not performed when the peak measured data under the limit of average detection.
7. The emission levels of other frequencies are very lower than the limit and not show in test report.

Product : Wireless module
 Test Item : Harmonic Radiated Emission
 Test Site : No.3 OATS
 Test Mode : Mode 1: Transmit - BLE (GFSK) (2480MHz)

Frequency MHz	Correct Factor dB	Reading Level dB μ V	Measurement Level dB μ V/m	Margin dB	Limit dB μ V/m
Horizontal					
Peak Detector:					
4960.000	2.582	43.820	46.402	-27.598	74.000
7440.000	10.555	37.770	48.325	-25.675	74.000
9920.000	10.206	38.170	48.376	-25.624	74.000
Average Detector:					
--					
Vertical					
Peak Detector:					
4960.000	3.398	42.830	46.229	-27.771	74.000
7440.000	11.214	37.890	49.104	-24.896	74.000
9920.000	11.245	38.200	49.445	-24.555	74.000
Average Detector:					
--					

Note:

1. All Readings below 1GHz are Quasi-Peak, above 1GHz are performed with peak and/or average measurements as necessary.
2. Peak measurements: RBW = 1MHz, VBW = 3 MHz, Sweep: Auto.
3. Average measurements: RBW = 1MHz, VBW = 10 Hz, Sweep: Auto.
4. Measurement Level = Reading Level + Correct Factor.
5. Correct Factor = Antenna factor + Cable loss – Amplifier gain.
6. The average measurement was not performed when the peak measured data under the limit of average detection.
7. The emission levels of other frequencies are very lower than the limit and not show in test report.

Product : Wireless module
 Test Item : General Radiated Emission
 Test Site : No.3 OATS
 Test Mode : Mode 1: Transmit - BLE (GFSK) (2440MHz)

Frequency MHz	Correct Factor dB	Reading Level dBµV	Measurement Level dBµV/m	Margin dB	Limit dBµV/m
Horizontal					
125.060	-7.335	29.520	22.185	-21.315	43.500
350.100	-1.298	29.076	27.778	-18.222	46.000
491.720	1.521	25.292	26.813	-19.187	46.000
631.400	1.266	26.975	28.241	-17.759	46.000
864.200	6.329	26.267	32.596	-13.404	46.000
980.600	7.314	21.337	28.651	-25.349	54.000
Vertical					
177.440	-1.248	30.707	29.459	-14.041	43.500
367.560	-0.088	26.218	26.129	-19.871	46.000
485.900	-2.324	24.823	22.499	-23.501	46.000
610.060	2.087	22.635	24.722	-21.278	46.000
815.700	2.931	20.535	23.466	-22.534	46.000
967.020	3.889	19.504	23.393	-30.607	54.000

Note:

1. All Readings below 1GHz are Quasi-Peak, above 1GHz are performed with peak and/or average measurements as necessary.
2. Peak measurements: RBW = 1MHz, VBW = 3 MHz, Sweep: Auto.
3. Average measurements: RBW = 1MHz, VBW = 10 Hz, Sweep: Auto.
4. Measurement Level = Reading Level + Correct Factor.
5. Correct Factor = Antenna factor + Cable loss – Amplifier gain.
6. The average measurement was not performed when the peak measured data under the limit of average detection.
7. The emission levels of other frequencies are very lower than the limit and not show in test report.
8. No emission found between lowest internal used/generated frequency to 30MHz.

5. RF Antenna Conducted Test

5.1. Test Equipment

Equipment	Manufacturer	Model No./Serial No.	Last Cal.
Spectrum Analyzer	R&S	FSP40 / 100170	Jun., 2015
Spectrum Analyzer	Agilent	E4407B / US39440758	Jun., 2015
X Spectrum Analyzer	Agilent	N9010A / MY48030495	Apr., 2015

Note: 1. All equipments are calibrated every one year.
 2. The test instruments Marked “X” are used to measure the final test results.

5.2. Test Setup

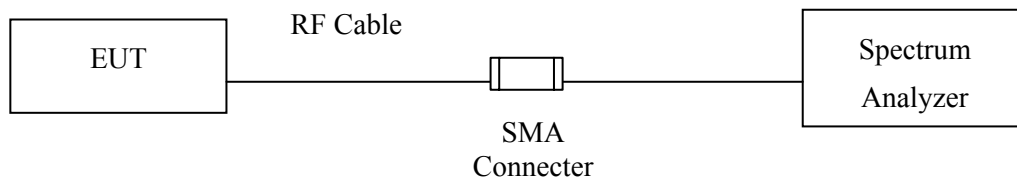

5.3. Limits

According to FCC Section 15.247(d). In any 100 kHz bandwidth outside the frequency band in which the spread spectrum or digitally modulated intentional radiator is operating, the radio frequency power that is produced by the intentional radiator shall be at least 20 dB below that in the 100 kHz bandwidth within the band that contains the highest level of the desired power, based on either an RF conducted or measurement, provided the transmitter demonstrates compliance with the peak conducted power limits. If the transmitter complies with the conducted power limits based on the use of RMS averaging over a time interval, the attenuation required under this paragraph shall be 30 dB instead of 20 dB.

5.4. Test Procedure

The EUT was tested according to DTS test procedure of KDB558074 for compliance to FCC 47CFR 15.247 requirements.

5.5. Uncertainty

± 150Hz

5.6. Test Result of RF Antenna Conducted Test

Product : Wireless module
 Test Item : RF Antenna Conducted Test
 Test Site : No.3 OATS
 Test Mode : Mode 1: Transmit - BLE (GFSK)

Figure Channel 00:

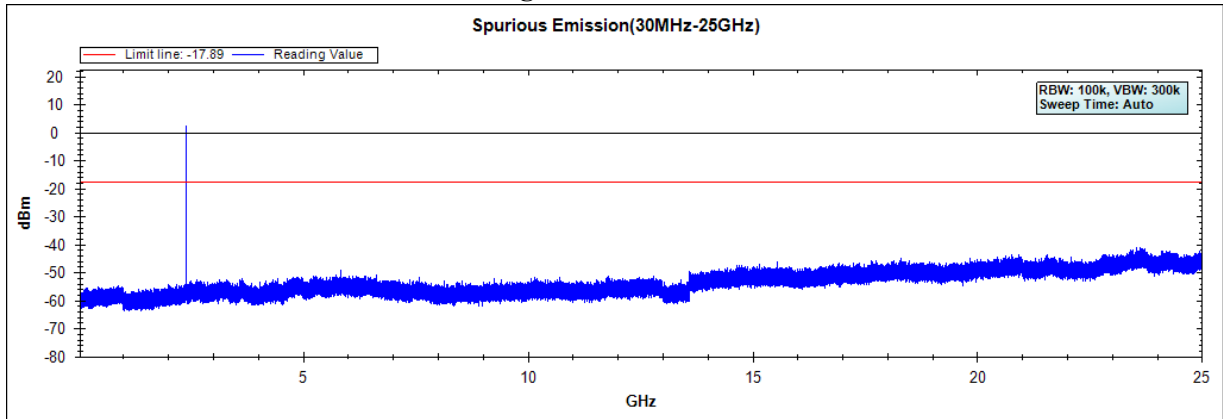

Figure Channel 19:

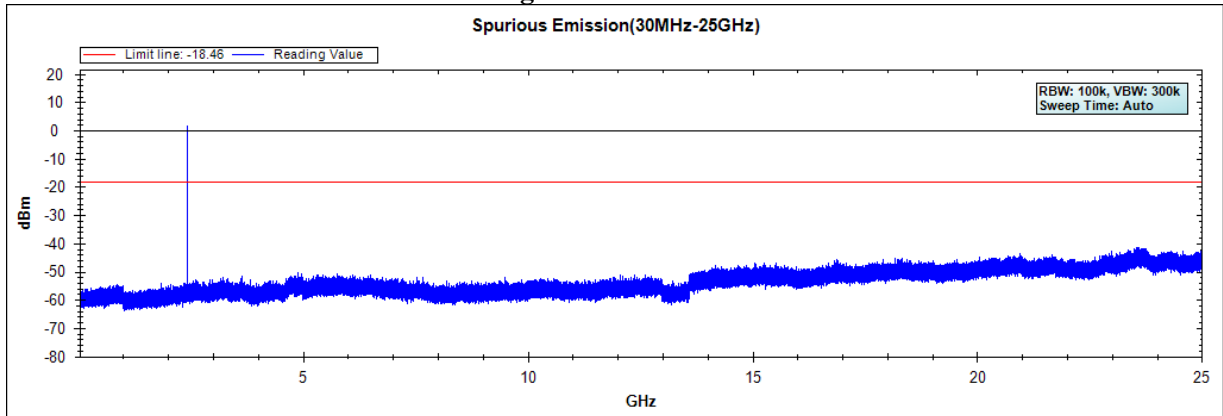
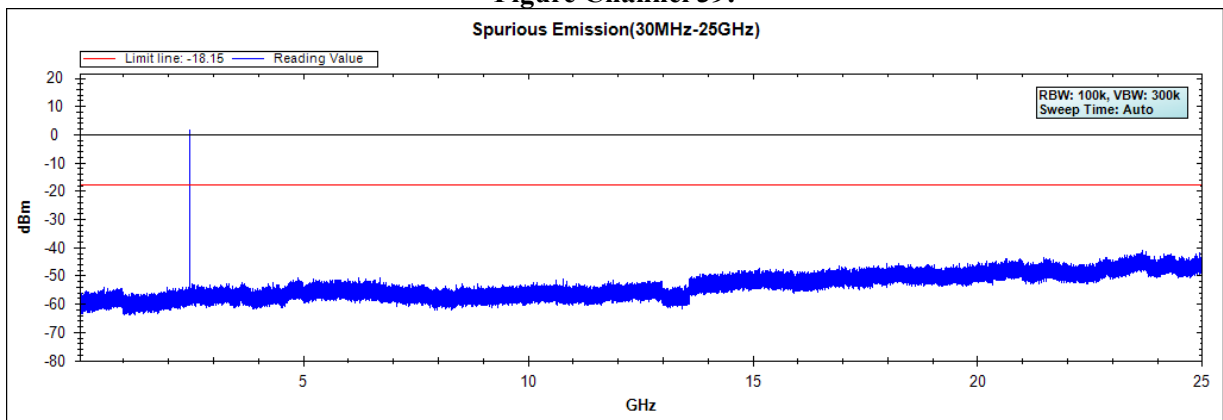

Figure Channel 39:



Note: The above test pattern is synthesized by multiple of the frequency range.

6. Band Edge

6.1. Test Equipment

RF Radiated Measurement:

The following test equipments are used during the band edge tests:

Test Site	Equipment	Manufacturer	Model No./Serial No.	Last Cal.
Site # 3	Bilog Antenna	Schaffner Chase	CBL6112B/2673	Sep., 2015
	X Horn Antenna	Schwarzbeck	BBHA9120D/D305	Sep., 2015
	Horn Antenna	Schwarzbeck	BBHA9170/208	Jul., 2015
	X Pre-Amplifier	Agilent	8447D/2944A09549	Sep., 2015
	X Spectrum Analyzer	Agilent	E4407B / US39440758	May, 2015
	Test Receiver	R & S	ESCS 30/ 825442/018	Sep., 2015
	X Coaxial Cable	Quietek	QTK-CABLE/ CAB5	Feb., 2015
	X Controller	Quietek	QTK-CONTROLLER/ CTRL3	N/A
	X Coaxial Switch	Anritsu	MP59B/6200265729	N/A

- Note: 1. All equipments are calibrated every one year.
 2. The test instruments marked by "X" are used to measure the final test results.

6.2. Test Setup

RF Radiated Measurement:

Above 1GHz

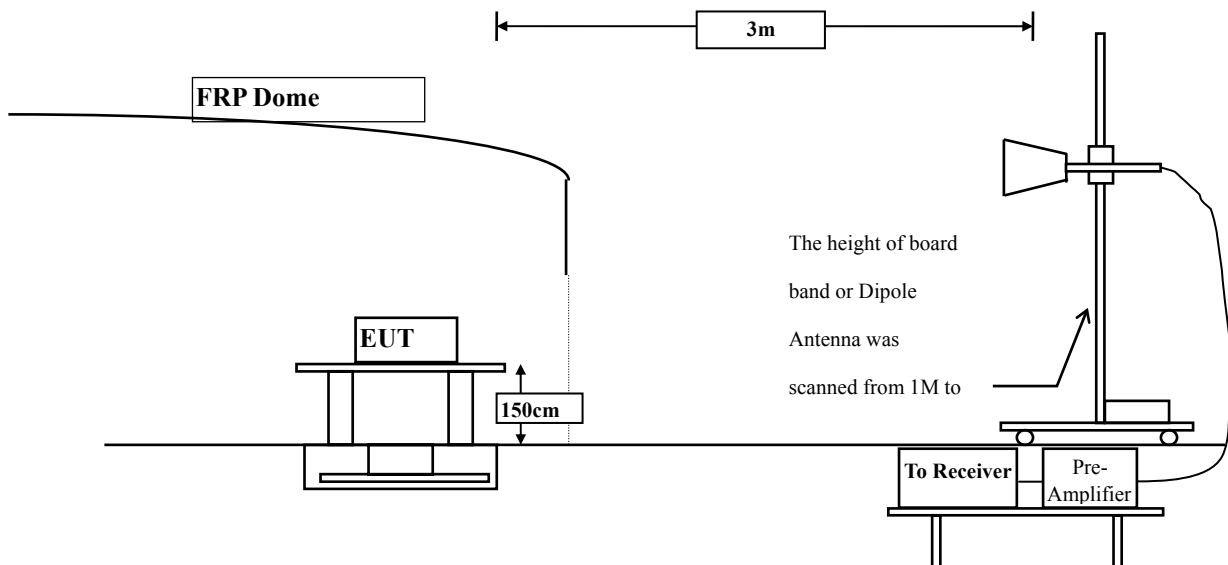

6.3. Limit

In any 100 kHz bandwidth outside the frequency band in which the spread spectrum intentional radiator is operating, the radio frequency power that is produced by the intentional radiator shall be at least 20 dB below that in the 100 kHz bandwidth within the band that contains the highest level of the desired power, based on either an RF conducted or a radiated measurement. Attenuation below the general limits specified in Section 15.209(a) is not required. In addition, radiated emissions which fall in the restricted bands, as defined in Section 15.205(a), must also comply with the radiated emission limits specified in Section 15.209(a) (see Section 15.205(c)).

6.4. Test Procedure

The EUT was setup according to ANSI C63.10, 2013 and tested according to DTS test procedure of KDB558074 for compliance to FCC 47CFR 15.247 requirements.

The EUT is placed on a turn table which is 1.5 meter above ground. The turn table is rotated 360 degrees to determine the position of the maximum emission level. The EUT was positioned such that the distance from antenna to the EUT was 3 meters.

The antenna is scanned from 1 meter to 4 meters to find out the maximum emission level. This is repeated for both horizontal and vertical polarization of the antenna. In order to find the maximum emission, all of the interface cables were manipulated according to ANSI C63.10:2013 on radiated measurement.

6.5. Uncertainty

± 3.9 dB above 1GHz

± 3.8 dB below 1GHz

6.6. Test Result of Band Edge

Product : Wireless module
 Test Item : Band Edge
 Test Site : No.3 OATS
 Test Mode : Mode 1: Transmit - BLE (GFSK) (2402MHz)

RF Radiated Measurement (Horizontal):

Channel No.	Frequency (MHz)	Correct Factor (dB)	Reading Level (dBμV)	Emission Level (dBμV/m)	Peak Limit (dBμV/m)	Average Limit (dBμV/m)	Result
00 (Peak)	2375.900	-2.750	45.075	42.326	74.00	54.00	Pass
00 (Peak)	2390.000	-2.687	43.896	41.209	74.00	54.00	Pass
00 (Peak)	2400.000	-2.660	73.870	71.210	--	--	--
00 (Peak)	2402.200	-2.657	103.215	100.558	--	--	--
00 (Average)	2390.000	-2.687	30.920	28.233	74.00	54.00	Pass
00 (Average)	2400.000	-2.660	47.933	45.273	--	--	--
00 (Average)	2402.000	-2.657	77.379	74.722	--	--	--

Figure Channel 00: Horizontal (Peak)

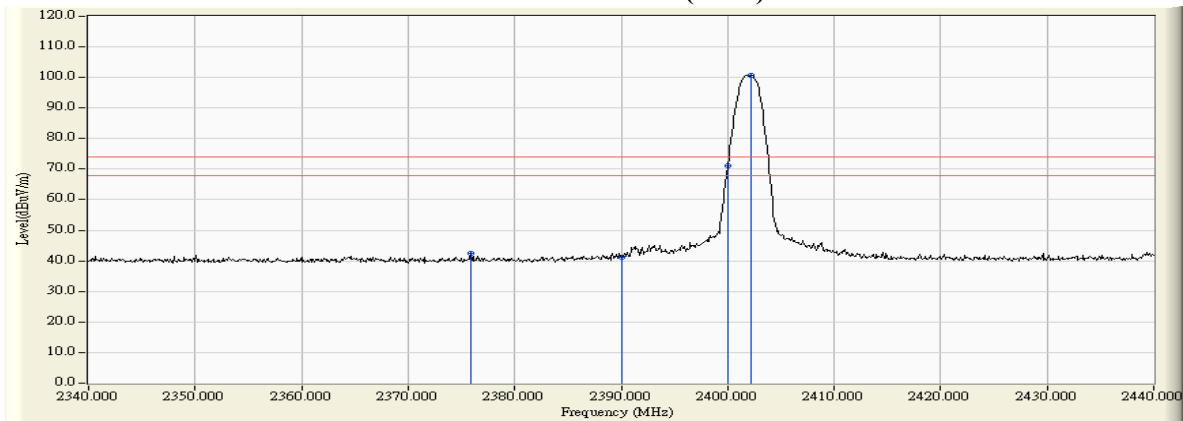
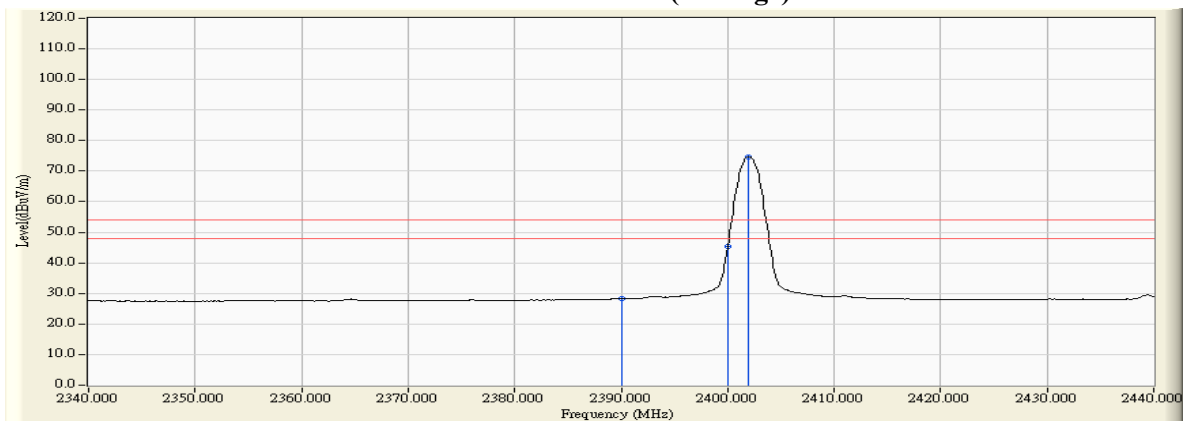

Figure Channel 00: Horizontal (Average)



Note:

1. All readings above 1GHz are performed with peak and/or average measurements as necessary.
2. Peak measurements: RBW = 1MHz, VBW = 3 MHz, Sweep: Auto.
3. Average measurements: RBW = 1MHz, VBW = 10 Hz, Sweep: Auto.
4. “ * ”, means this data is the worst emission level.
5. Measurement Level = Reading Level + Correct Factor.
6. The average measurement was not performed when the peak measured data under the limit of average detection.

Product : Wireless module
 Test Item : Band Edge
 Test Site : No.3 OATS
 Test Mode : Mode 1: Transmit - BLE (GFSK) (2402MHz)

RF Radiated Measurement (Vertical):

Channel No.	Frequency (MHz)	Correct Factor (dB)	Reading Level (dBμV)	Emission Level (dBμV/m)	Peak Limit (dBμV/m)	Average Limit (dBμV/m)	Result
00 (Peak)	2383.700	-4.138	43.963	39.825	74.00	54.00	Pass
00 (Peak)	2390.000	-4.159	43.319	39.160	74.00	54.00	Pass
00 (Peak)	2400.000	-4.171	71.482	67.311	--	--	--
00 (Peak)	2401.800	-4.171	101.153	96.982	--	--	--
00 (Average)	2390.000	-4.159	30.704	26.545	74.00	54.00	Pass
00 (Average)	2400.000	-4.171	46.545	42.374	--	--	--
00 (Average)	2402.100	-4.171	75.921	71.750	--	--	--

Figure Channel 00: Vertical (Peak)

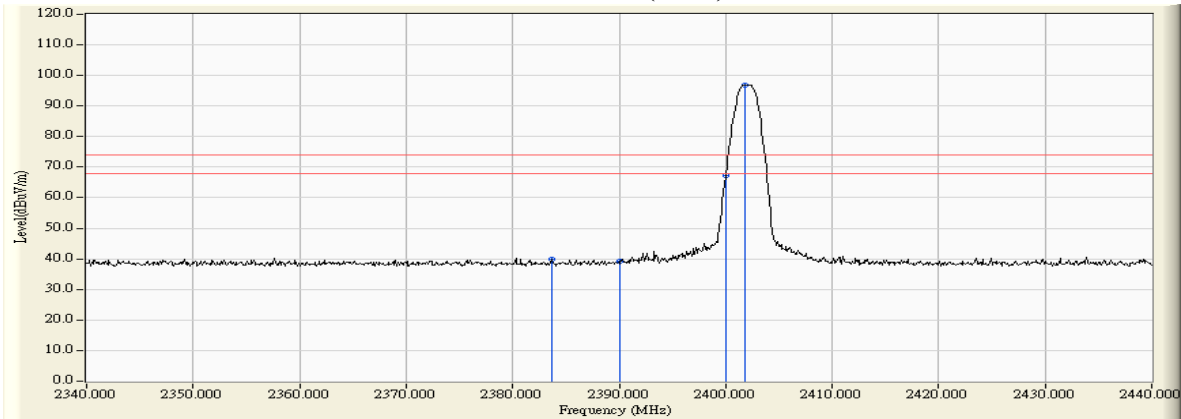
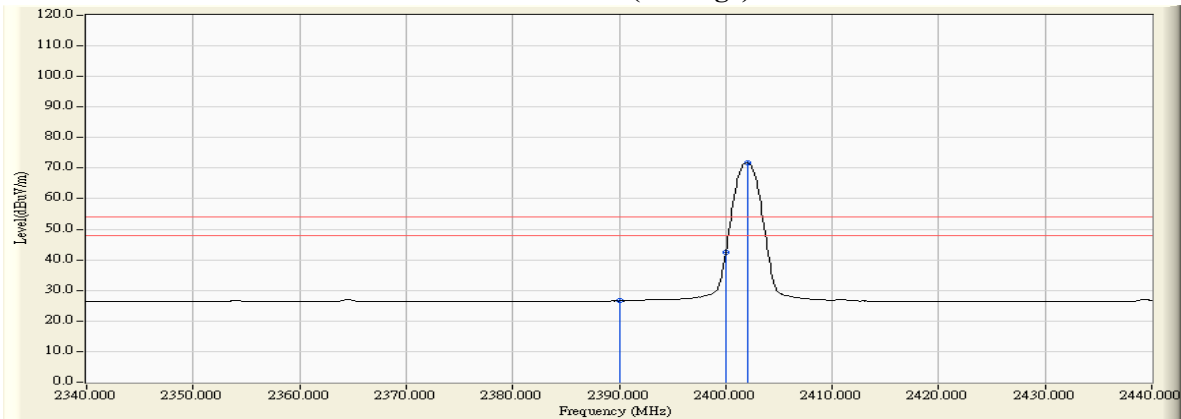

Figure Channel 00: Vertical (Average)



Note:

1. All readings above 1GHz are performed with peak and/or average measurements as necessary.
2. Peak measurements: RBW = 1MHz, VBW = 3 MHz, Sweep: Auto.
3. Average measurements: RBW = 1MHz, VBW = 10 Hz, Sweep: Auto.
4. “ * ”, means this data is the worst emission level.
5. Measurement Level = Reading Level + Correct Factor.
6. The average measurement was not performed when the peak measured data under the limit of average detection.

Product : Wireless module
 Test Item : Band Edge
 Test Site : No.3 OATS
 Test Mode : Mode 1: Transmit - BLE (GFSK) (2480MHz)

RF Radiated Measurement (Horizontal):

Channel No.	Frequency (MHz)	Correct Factor (dB)	Reading Level (dBμV)	Emission Level (dBμV/m)	Peak Limit (dBμV/m)	Average Limit (dBμV/m)	Result
39 (Peak)	2480.000	-2.605	102.726	100.121	--	--	--
39 (Peak)	2483.500	-2.601	51.355	48.753	74.00	54.00	Pass
39 (Peak)	2484.400	-2.602	51.681	49.080	74.00	54.00	Pass
39 (Average)	2480.000	-2.605	76.840	74.235	--	--	--
39 (Average)	2483.500	-2.601	33.984	31.382	74.00	54.00	Pass

Figure Channel 39: Horizontal (Peak)

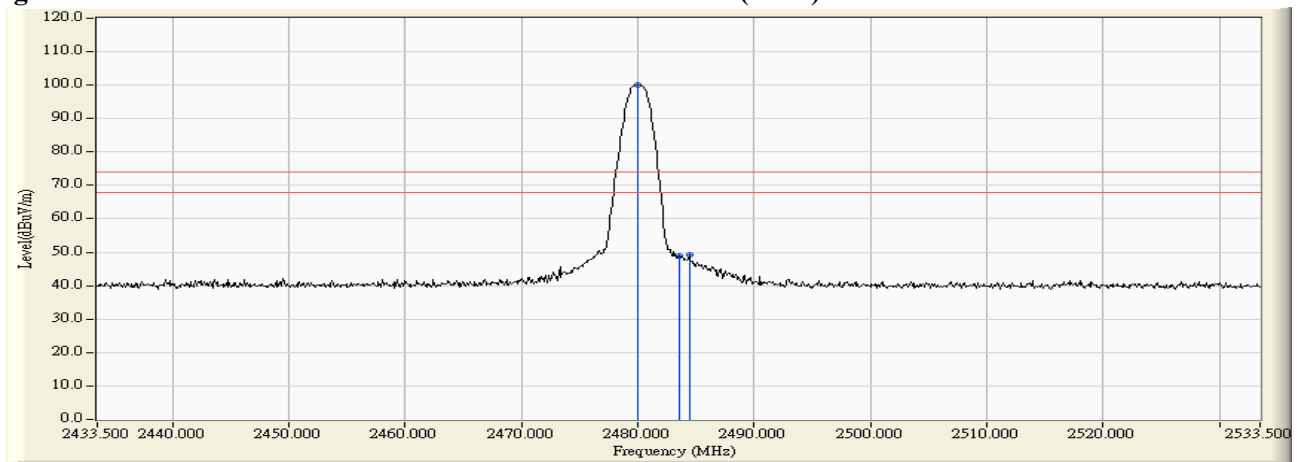
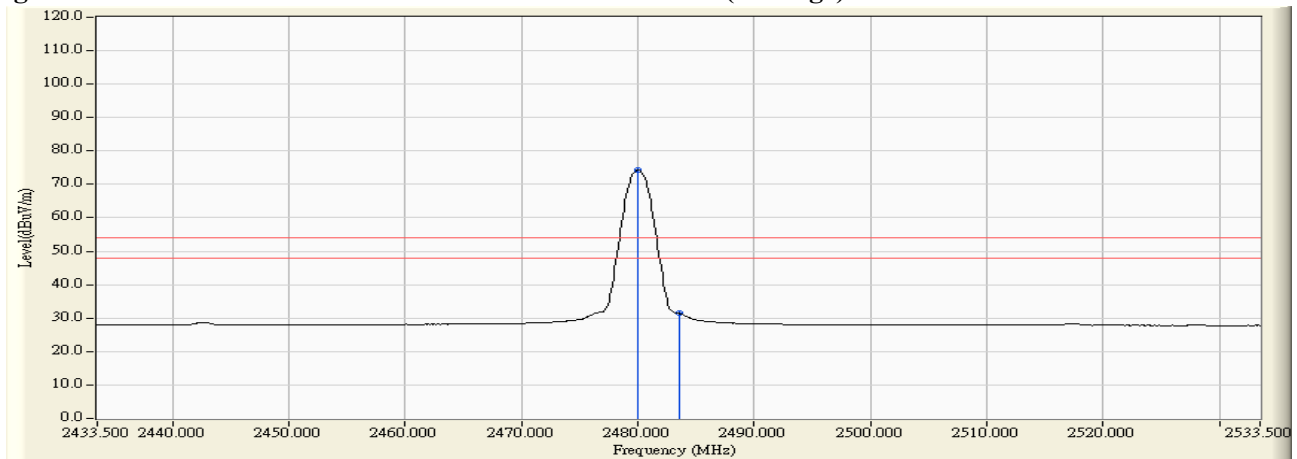

Figure Channel 39: Horizontal (Average)



Note:

1. All readings above 1GHz are performed with peak and/or average measurements as necessary.
2. Peak measurements: RBW = 1MHz, VBW = 3 MHz, Sweep: Auto.
3. Average measurements: RBW = 1MHz, VBW = 10 Hz, Sweep: Auto.
4. “ * ”, means this data is the worst emission level.
5. Measurement Level = Reading Level + Correct Factor.
6. The average measurement was not performed when the peak measured data under the limit of average detection.

Product : Wireless module
 Test Item : Band Edge
 Test Site : No.3 OATS
 Test Mode : Mode 1: Transmit - BLE (GFSK) (2480MHz)

RF Radiated Measurement (Vertical):

Channel No.	Frequency (MHz)	Correct Factor (dB)	Reading Level (dBμV)	Emission Level (dBμV/m)	Peak Limit (dBμV/m)	Average Limit (dBμV/m)	Result
39 (Peak)	2480.000	-3.978	99.733	95.755	--	--	--
39 (Peak)	2483.500	-3.966	49.017	45.050	74.00	54.00	Pass
39 (Average)	2480.000	-3.978	74.841	70.863	--	--	--
39 (Average)	2483.500	-3.966	32.690	28.723	74.00	54.00	Pass

Figure Channel 39: Vertical (Peak)

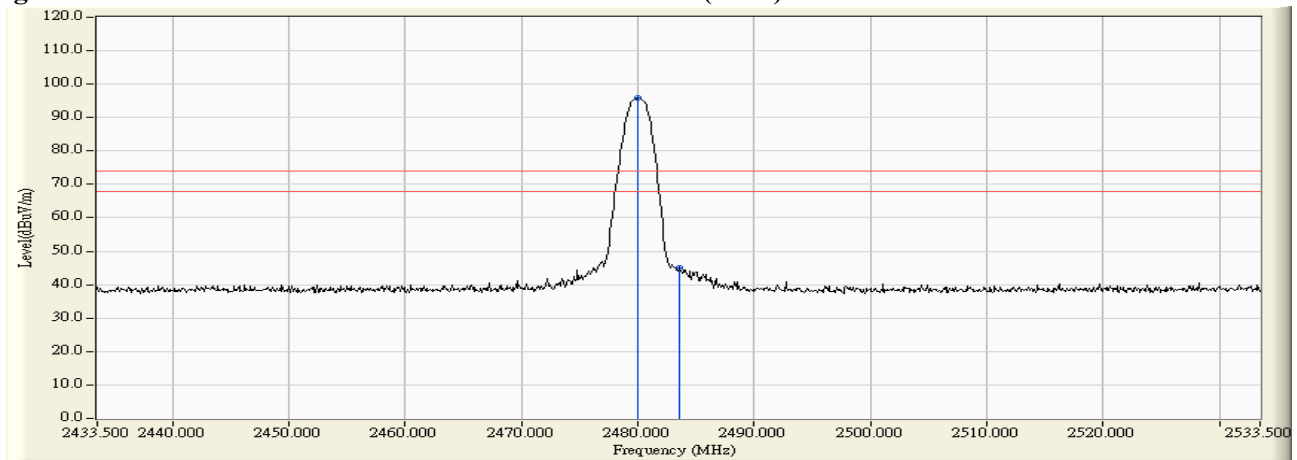
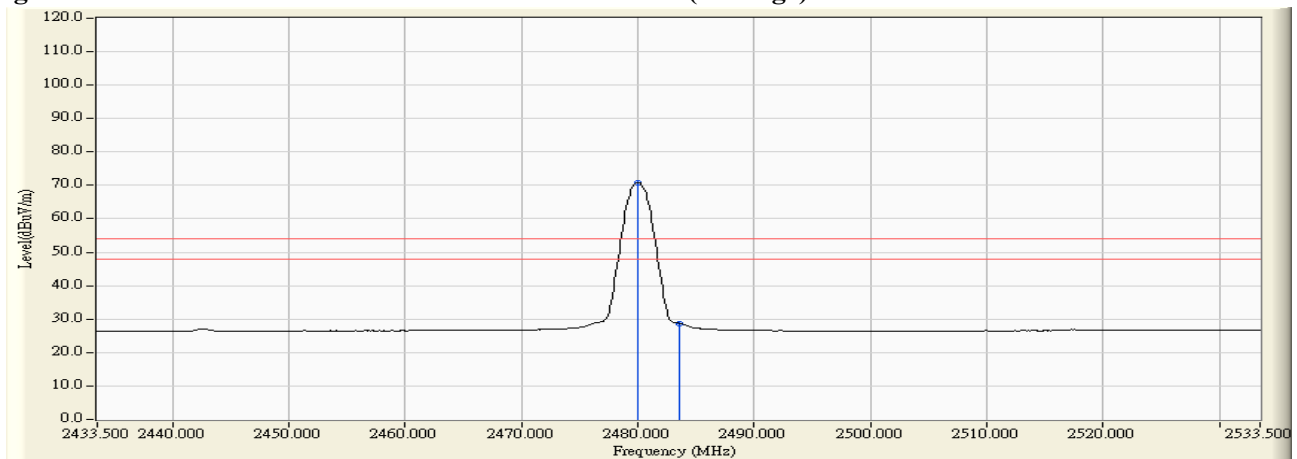

Figure Channel 39: Vertical (Average)



Note:

1. All readings above 1GHz are performed with peak and/or average measurements as necessary.
2. Peak measurements: RBW = 1MHz, VBW = 3 MHz, Sweep: Auto.
3. Average measurements: RBW = 1MHz, VBW = 10 Hz, Sweep: Auto.
4. “ * ”, means this data is the worst emission level.
5. Measurement Level = Reading Level + Correct Factor.
6. The average measurement was not performed when the peak measured data under the limit of average detection.

7. Occupied Bandwidth (6dB BW)

7.1. Test Equipment

	Equipment	Manufacturer	Model No./Serial No.	Last Cal.
	Spectrum Analyzer	R&S	FSP40 / 100170	Jun., 2015
	Spectrum Analyzer	Agilent	E4407B / US39440758	Jun., 2015
X	Spectrum Analyzer	Agilent	N9010A / MY48030495	Apr., 2015

Note:

1. All equipments are calibrated with traceable calibrations. Each calibration is traceable to the national or international standards.
2. The test instruments marked with “X” are used to measure the final test results.

7.2. Test Setup

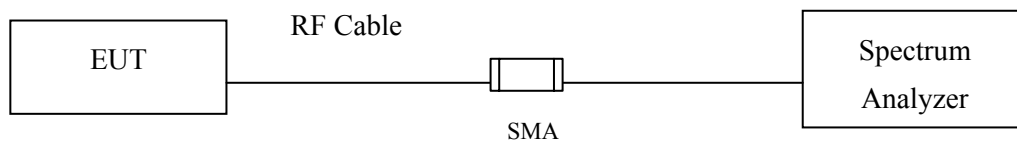

7.3. Limits

The minimum bandwidth shall be at least 500 kHz.

7.4. Test Procedure

The EUT was setup according to ANSI C63.10 2013; tested according to DTS test procedure of KDB558074 for compliance to FCC 47CFR 15.247 requirements.

Set RBW = 1-5% of the emission bandwidth, VBW ≥ 3*RBW

7.5. Uncertainty

± 150Hz

7.6. Test Result of Occupied Bandwidth

Product : Wireless module
 Test Item : Occupied Bandwidth Data
 Test Site : No.3 OATS
 Test Mode : Mode 1: Transmit - BLE (GFSK)

Channel No.	Frequency (MHz)	Measurement Level (kHz)	Required Limit (kHz)	Result
00	2402	750	>500	Pass
19	2440	740	>500	Pass
39	2480	750	>500	Pass

Figure Channel 00:

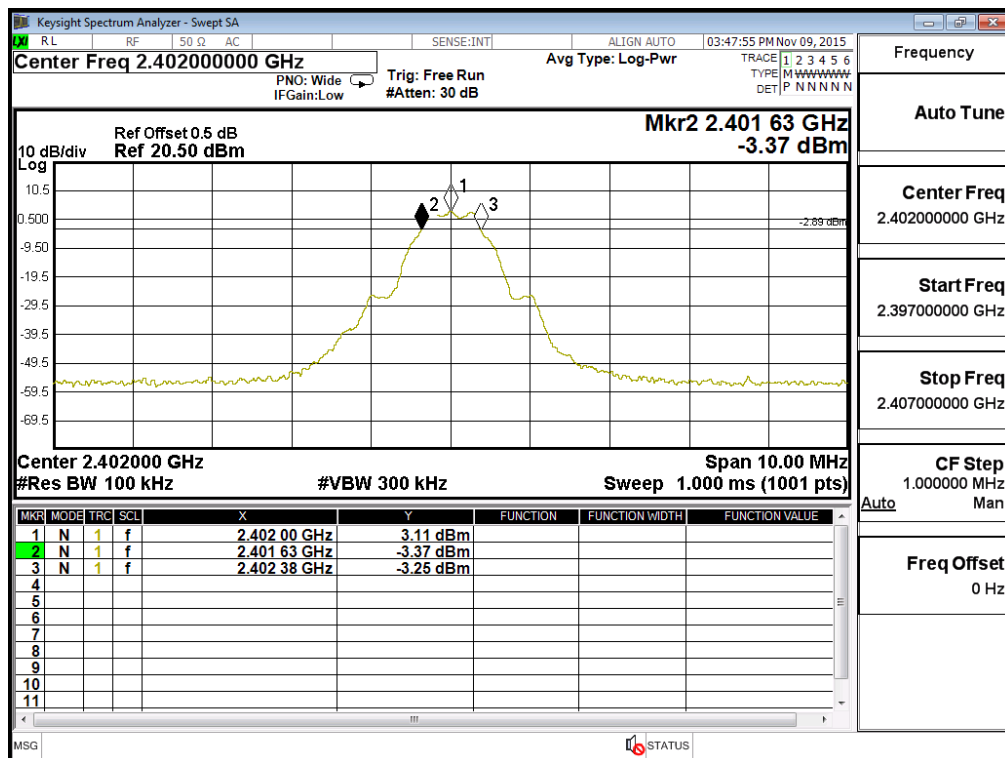

Figure Channel 19:

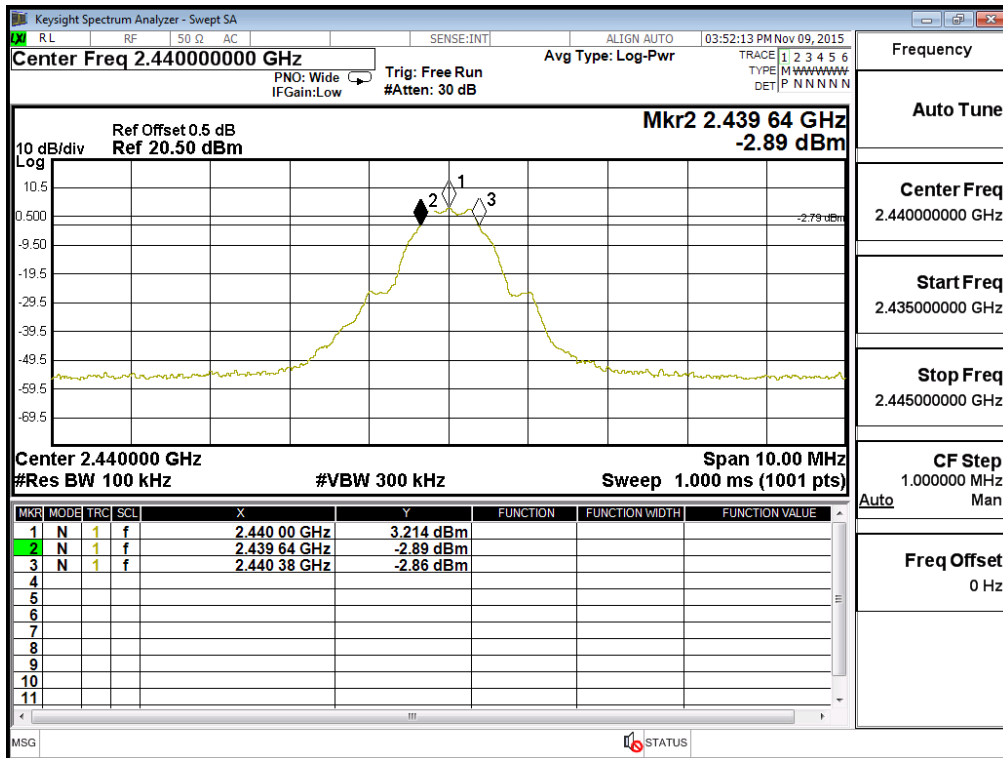
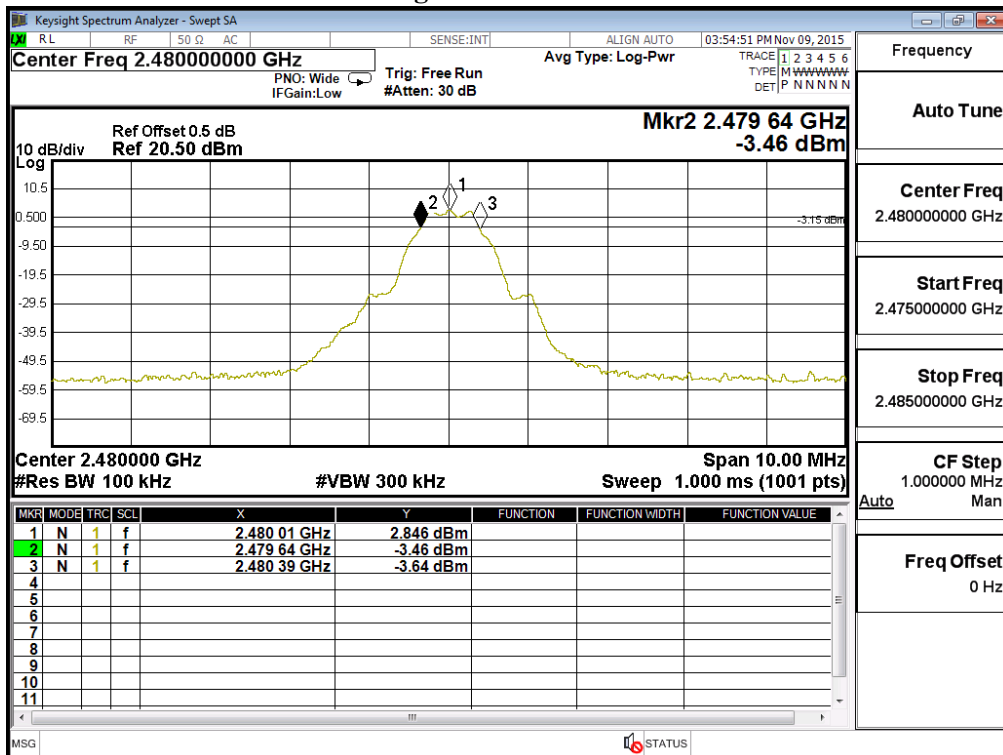

Figure Channel 39:



8. Power Density

8.1. Test Equipment

	Equipment	Manufacturer	Model No./Serial No.	Last Cal.
	Spectrum Analyzer	R&S	FSP40 / 100170	Jun., 2015
	Spectrum Analyzer	Agilent	E4407B / US39440758	Jun., 2015
X	Spectrum Analyzer	Agilent	N9010A / MY48030495	Apr., 2015

Note:

1. All equipments are calibrated with traceable calibrations. Each calibration is traceable to the national or international standards.
2. The test instruments marked with “X” are used to measure the final test results.

8.2. Test Setup

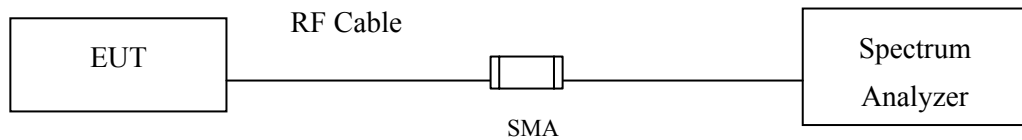

8.3. Limits

The transmitted power density averaged over any 1 second interval shall not be greater +8dBm in any 3kHz bandwidth.

8.4. Test Procedure

The EUT was setup according to ANSI C63.10: 2013, the maximum power spectral density using KDB 558074 section 10.2 PKPSD (peak PSD) method.

8.5. Uncertainty

± 1.27 dB

8.6. Test Result of Power Density

Product : Wireless module
 Test Item : Power Density Data
 Test Site : No.3 OATS
 Test Mode : Mode 1: Transmit - BLE (GFSK)

Channel No.	Frequency (MHz)	Measure Level (dBm)	Limit (dBm)	Result
00	2402	2.110	< 8dBm	Pass
19	2440	1.540	< 8dBm	Pass
39	2480	1.850	< 8dBm	Pass

Figure Channel 00:

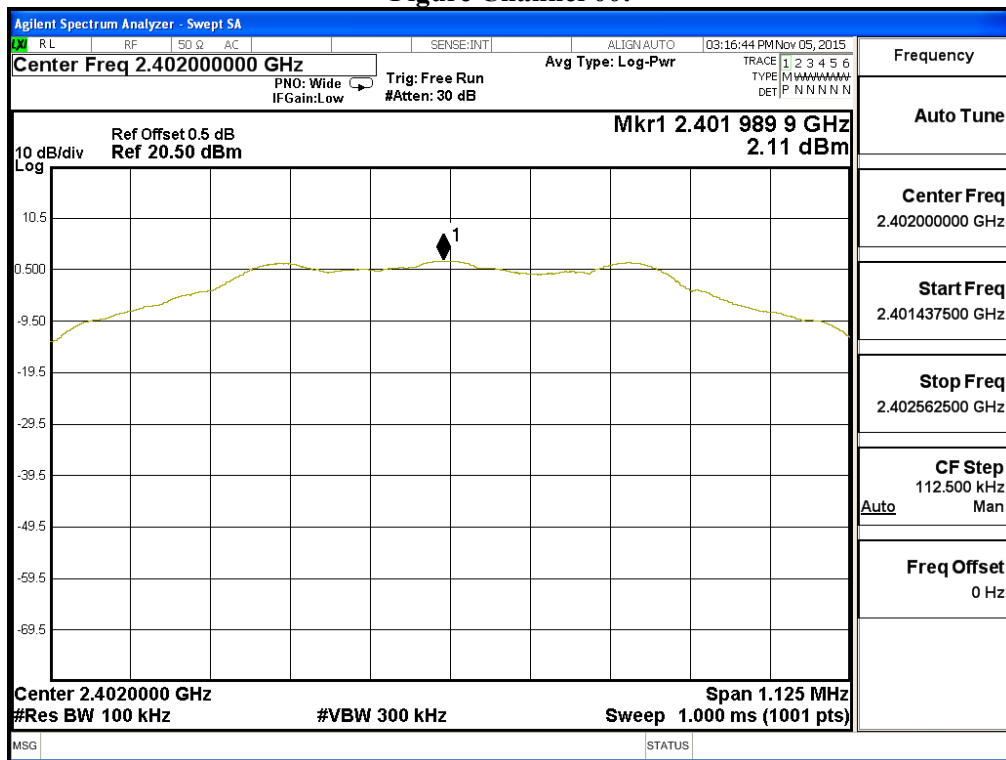

Figure Channel 19:

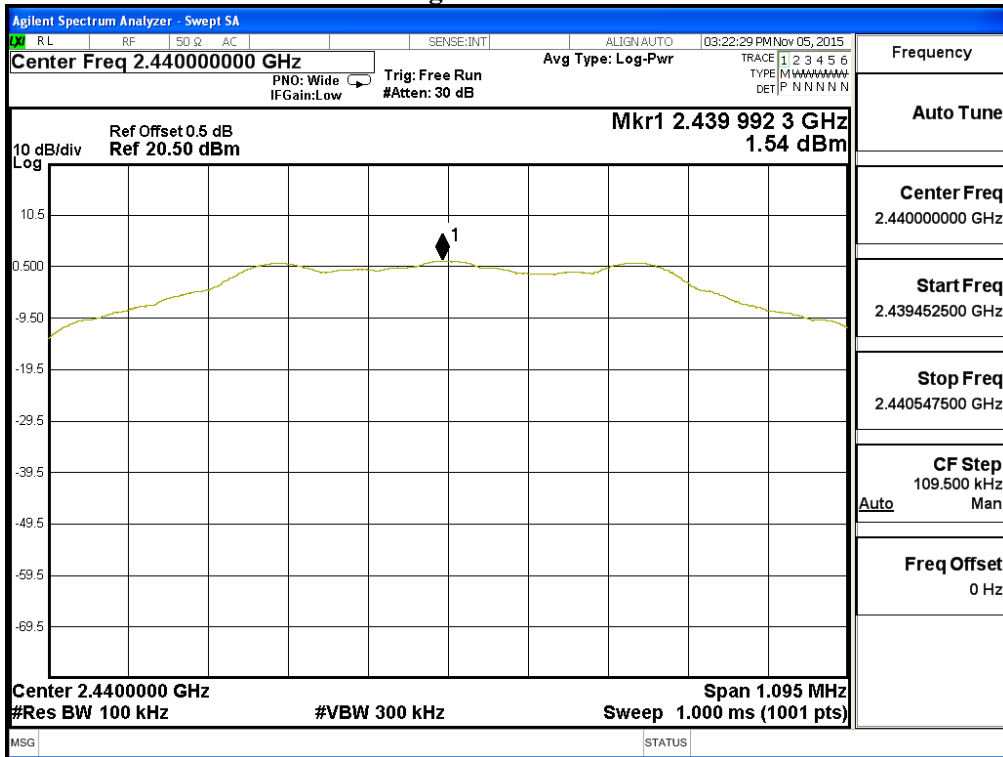
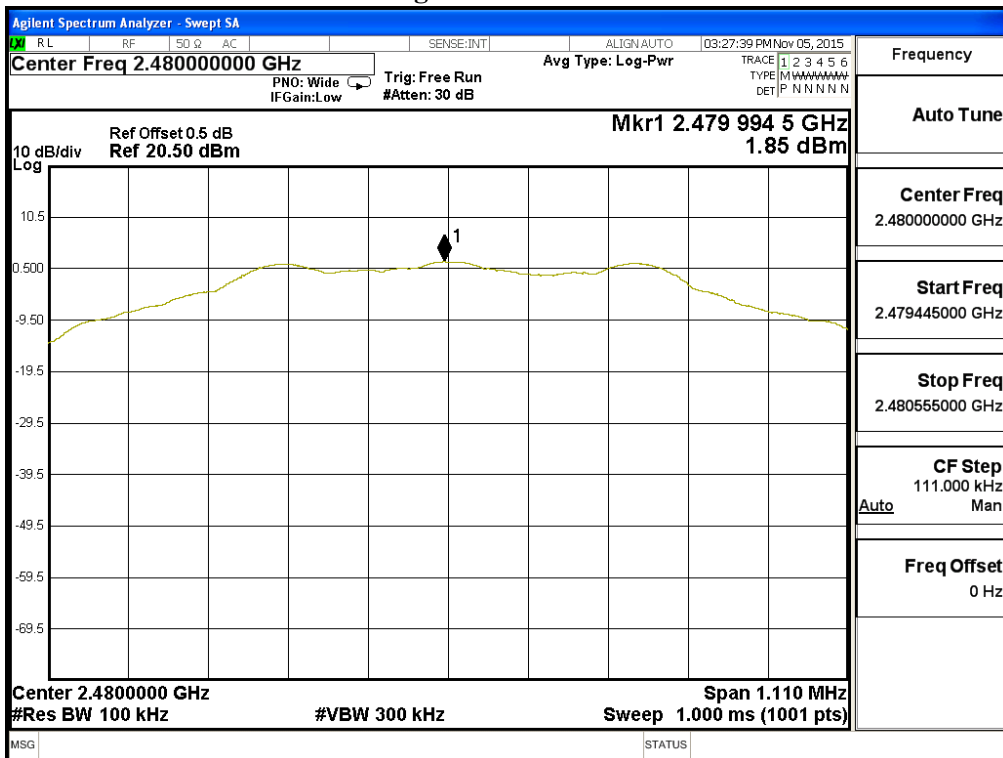

Figure Channel 39:



9. EMI Reduction Method During Compliance Testing

No modification was made during testing.

Attachment 1: EUT Test Photographs

Attachment 2: EUT Detailed Photographs