



BUREAU VERITAS

Test Report No.: RF171211W008-3



FCC TEST REPORT (Part 15, Subpart E)



Applicant:	i.safe MOBILE GmbH
Address:	i_Park Tauberfranken 10, 97922 Lauda-Koenigshofen, Germany

Manufacturer or Supplier	i.safe MOBILE GmbH
Address	i_Park Tauberfranken 10, 97922 Lauda-Koenigshofen, Germany
Product	Head Mounted Tablet
Brand Name	i.safe MOBILE
Model Name	T1100S
FCC ID	2AACZ1100S00AA
Date of tests	Feb. 28, 2018 ~ Mar. 27, 2018

The tests have been carried out according to the requirements of the following standard:

FCC Part 15, Subpart E, Section 15.407

CONCLUSION: The submitted sample was found to COMPLY with the test requirement

Prepared by Yuqiang Yin Engineer / Mobile Department	Approved by Sam Tung Manager / Mobile Department
	
Date: Mar. 28, 2018	Date: Mar. 28, 2018

This report is for your exclusive use. Any copying or replication of this report to or for any other person or entity, or use of our name or trademark, is permitted only with our prior written permission. This report sets forth our findings solely with respect to the test samples identified herein. The results set forth in this report are not indicative or representative of the quality or characteristics of the lot from which a test sample was taken or any similar or identical product unless specifically and expressly noted. Our report includes all of the tests requested by you and the results thereof based upon the information that you provided to us. You have 60 days from date of issuance of this report to notify us of any material error or omission caused by our negligence, provided, however, that such notice shall be in writing and shall specifically address the issue you wish to raise. A failure to raise such issue within the prescribed time shall constitute your unqualified acceptance of the completeness of this report, the tests conducted and the correctness of the report contents. Unless specific mention, the uncertainty of measurement has been explicitly taken into account to declare the compliance or non-compliance to the specification



TABLE OF CONTENTS

RELEASE CONTROL RECORD 4

1 SUMMARY OF TEST RESULTS..... 5

1.1 MEASUREMENT UNCERTAINTY 5

2 GENERAL INFORMATION 6

2.1 GENERAL DESCRIPTION OF EUT 6

2.2 DESCRIPTION OF TEST MODES 8

2.2.1 TEST MODE APPLICABILITY AND TESTED CHANNEL DETAIL..... 10

2.3 DUTY CYCLE OF TEST SIGNAL 13

2.4 DESCRIPTION OF SUPPORT UNITS 14

2.4.1 CONFIGURATION OF SYSTEM UNDER TEST 15

2.5 GENERAL DESCRIPTION OF APPLIED STANDARDS 15

3 TEST TYPES AND RESULTS..... 16

3.1 RADIATED EMISSION AND BANDEDGE MEASUREMENT 16

3.1.1 LIMITS OF RADIATED EMISSION AND BANDEDGE MEASUREMENT 16

3.1.2 LIMITS OF UNWANTED EMISSION 16

3.1.3 TEST INSTRUMENTS..... 17

3.1.4 TEST PROCEDURES 18

3.1.5 DEVIATION FROM TEST STANDARD 18

3.1.6 TEST SETUP 19

3.1.7 EUT OPERATING CONDITION 20

3.1.8 TEST RESULTS 21

3.2 CONDUCTED EMISSION MEASUREMENT 69

3.2.1 LIMITS OF CONDUCTED EMISSION MEASUREMENT 69

3.2.2 TEST INSTRUMENTS..... 69

3.2.3 TEST PROCEDURES 69

3.2.4 DEVIATION FROM TEST STANDARD 70

3.2.5 TEST SETUP 70

3.2.6 EUT OPERATING CONDITIONS 70

3.2.7 TEST RESULTS 71

3.3 MAXIMUM CONDUCTED OUTPUT POWER MEASUREMENT 73

3.3.1 LIMITS OF MAXIMUM CONDUCTED OUTPUT POWER MEASUREMENT 73

3.3.2 TEST SETUP 74



3.3.3	TEST INSTRUMENTS.....	74
3.3.4	TEST PROCEDURE.....	75
3.3.5	DEVIATION FROM TEST STANDARD	77
3.3.6	EUT OPERATING CONDITIONS.....	77
3.3.7	TEST RESULTS	78
3.4	MAXIMUM POWER SPECTRAL DENSITY MEASUREMENT.....	91
3.4.1	LIMITS OF MAXIMUM POWER SPECTRAL DENSITY MEASUREMENT	91
3.4.2	TEST SETUP.....	91
3.4.3	TEST INSTRUMENTS.....	91
3.4.4	TEST PROCEDURES	92
3.4.5	DEVIATION FROM TEST STANDARD	92
3.4.6	EUT OPERATING CONDITIONS.....	92
3.4.7	TEST RESULTS	93
3.5	FREQUENCY STABILITY	100
3.5.1	LIMITS OF FREQUENCY STABILITY MEASUREMENT.....	100
3.5.2	TEST SETUP.....	100
3.5.3	TEST INSTRUMENTS.....	100
3.5.4	TEST PROCEDURE.....	101
3.5.5	DEVIATION FROM TEST STANDARD	101
3.5.6	EUT OPERATING CONDITION	101
3.5.7	TEST RESULTS	102
4	PHOTOGRAPHS OF THE TEST CONFIGURATION.....	104
5	APPENDIX A – MODIFICATIONS RECORDERS FOR ENGINEERING CHANGES TO THE EUT BY THE LAB.....	105



**BUREAU
VERITAS**

Test Report No.: RF171211W008-3

RELEASE CONTROL RECORD

ISSUE NO.	REASON FOR CHANGE	DATE ISSUED
RF171211W008-3	Original release	Mar. 28, 2018



1 SUMMARY OF TEST RESULTS

The EUT has been tested according to the following specifications:

APPLIED STANDARD: FCC PART 15, SUBPART E (SECTION 15.407)			
STANDARD SECTION	TEST TYPE AND LIMIT	RESULT	REMARK
15.407(b)(5)	AC Power Conducted Emission	PASS	Meet the requirement of limit. Minimum passing margin is -18.83dB at 0.736000MHz.
15.407(b) (1/2/3/4/6)	Radiated Emission & Band Edge Measurement	PASS	Meet the requirement of limit. Minimum passing margin is -6.74dB at 5991.75MHz.
15.407(a/1/2/3)	Maximum conducted output Power	PASS	Meet the requirement of limit.
15.407(a/1/2/3)	Peak Power Spectral Density	PASS	Meet the requirement of limit.
15.407(e)	6 dB Bandwidth	PASS	Meet the requirement of limit. (U-NII-3 Band only)
15.407(g)	Frequency Stability	PASS	Meet the requirement of limit.
15.203	Antenna Requirement	PASS	No antenna connector is used.

1.1 MEASUREMENT UNCERTAINTY

Where relevant, the following measurement uncertainty levels have been estimated for tests performed on the EUT as specified in ETSI TR 100 028-2001:

MEASUREMENT	FREQUENCY	UNCERTAINTY
Conducted emissions	9kHz~30MHz	2.66dB
Radiated emissions	9KHz ~ 30MHz	2.68dB
	30MHz ~ 1GMHz	3.26dB
	1GHz ~ 18GHz	4.48dB
	18GHz ~ 40GHz	4.12dB

This uncertainty represents an expanded uncertainty expressed at approximately the 95% confidence level using a coverage factor of k = 2.



2 GENERAL INFORMATION

2.1 GENERAL DESCRIPTION OF EUT

EUT	Head Mounted Tablet
MODEL NO.	T1100S
POWER SUPPLY	5.0Vdc (adapter or host equipment) 3.8Vdc (Li-ion, battery)
MODULATION TYPE	64QAM, 16QAM, QPSK, BPSK
MODULATION TECHNOLOGY	OFDM
TRANSFER RATE	802.11a: 54.0/ 48.0/ 36.0/ 24.0/ 18.0/ 12.0/ 9.0/ 6.0Mbps 802.11n: up to MCS7 802.11ac: up to 390.0Mbps
OPERATING FREQUENCY	5180 ~ 5240MHz, 5260 ~ 5320MHz, 5500 ~ 5700MHz, 5745 ~ 5825MHz
NUMBER OF CHANNEL	5180 ~ 5240MHz: 4 for 802.11a, 802.11n (20MHz) 2 for 802.11n (40MHz) 1 for 802.11ac (80MHz) 5260 ~ 5320MHz: 4 for 802.11a, 802.11n (20MHz) 2 for 802.11n (40MHz) 1 for 802.11ac (80MHz) 5500 ~ 5700MHz: 11 for 802.11a, 802.11n (20MHz) 5 for 802.11n (40MHz) 2 for 802.11ac (80MHz) 5745 ~ 5825MHz: 5 for 802.11a, 802.11n (20MHz) 2 for 802.11n (40MHz) 1 for 802.11ac (80MHz)
AVERAGE POWER	28.054mW for 5180 ~ 5240MHz 30.200mW for 5260 ~ 5320MHz 29.923mW for 5500 ~ 5700MHz 22.336mW for 5745 ~ 5825MHz
ANTENNA TYPE	5180 ~ 5240MHz: PCB Antenna with 2dBi gain 5260 ~ 5320MHz: PCB Antenna with 1.8dBi gain 5500 ~ 5700MHz: PCB Antenna with 1.8dBi gain 5745 ~ 5825MHz: PCB Antenna with -0.7dBi gain
HW VERSION	A
SW VERSION	HMT-1.S.0-6.0.1-03.00-T
I/O PORTS	Refer to user's manual
CABLE SUPPLIED	USB cable: non-shielded, detachable, 1.0m

NOTE:



1. For a more detailed features description, please refer to the manufacturer's specifications or the user's manual.
2. The EUT matched the following USB cable:

USB CABLE	
BRAND:	i.safe MOBILE
MODEL:	X0100100
SIGNAL LINE:	1.0 METER

3. The EUT incorporates a SISO function. Physically, the EUT provides one completed transmitter and one receiver.

MODULATION MODE	TX FUNCTION
802.11a	1TX/1RX
802.11n (20MHz)	1TX/1RX
802.11n (40MHz)	1TX/1RX
802.11ac (80MHz)	1TX/1RX

4. For the test results, the EUT had been tested with all conditions. But only the worst case was shown in test report.



2.2 DESCRIPTION OF TEST MODES

FOR 5150 ~ 5250MHz

4 channels are provided for 802.11a, 802.11n (20MHz):

CHANNEL	FREQUENCY	CHANNEL	FREQUENCY
36	5180 MHz	44	5220 MHz
40	5200 MHz	48	5240 MHz

2 channels are provided for 802.11n (40MHz):

CHANNEL	FREQUENCY	CHANNEL	FREQUENCY
38	5190 MHz	46	5230 MHz

1 channel is provided for 802.11ac (80MHz):

CHANNEL	FREQUENCY	CHANNEL	FREQUENCY
42	5210 MHz		

FOR 5250 ~ 5350MHz

4 channels are provided for 802.11a, 802.11n (20MHz):

CHANNEL	FREQUENCY	CHANNEL	FREQUENCY
52	5260 MHz	60	5300 MHz
56	5280 MHz	64	5320 MHz

2 channels are provided for 802.11n (40MHz):

CHANNEL	FREQUENCY	CHANNEL	FREQUENCY
54	5270 MHz	62	5310 MHz

1 channel is provided for 802.11ac (80MHz):

CHANNEL	FREQUENCY	CHANNEL	FREQUENCY
58	5290 MHz		



FOR 5470 ~ 5725MHz

11 channels are provided for 802.11a, 802.11n (20MHz):

CHANNEL	FREQUENCY	CHANNEL	FREQUENCY
100	5500 MHz	124	5620MHz
104	5520 MHz	128	5640MHz
108	5540 MHz	132	5660 MHz
112	5560 MHz	136	5680 MHz
116	5580 MHz	140	5700 MHz
120	5600 MHz		

5 channels are provided for 802.11n (40MHz):

CHANNEL	FREQUENCY	CHANNEL	FREQUENCY
102	5510 MHz	126	5630MHz
110	5550 MHz	134	5670 MHz
118	5590 MHz		

2 channel is provided for 802.11ac (80MHz):

CHANNEL	FREQUENCY	CHANNEL	FREQUENCY
106	5530 MHz	122	5610

FOR 5725 ~ 5825MHz

5 channels are provided for 802.11a, 802.11n (20MHz):

CHANNEL	FREQUENCY	CHANNEL	FREQUENCY
149	5745 MHz	161	5805 MHz
153	5765 MHz	165	5825 MHz
157	5785 MHz		

2 channels are provided for 802.11n (40MHz):

CHANNEL	FREQUENCY	CHANNEL	FREQUENCY
151	5755 MHz	159	5795 MHz

1 channel is provided for 802.11ac (80MHz):

CHANNEL	FREQUENCY	CHANNEL	FREQUENCY
155	5775 MHz		



2.2.1 TEST MODE APPLICABILITY AND TESTED CHANNEL DETAIL

EUT CONFIGURE MODE	APPLICABLE TO				DESCRIPTION
	RE≥1G	RE<1G	PLC	APCM	
A	√	√	√	-	Powered by Adapter with wifi(5G) link
B	-	-	-	√	Powered by Battery with wifi(5G) link
C	-	-	-	-	Powered by USB with wifi(5G) link

Where **RE≥1G**: Radiated Emission above 1GHz **RE<1G**: Radiated Emission below 1GHz
PLC: Power Line Conducted Emission **APCM**: Antenna Port Conducted Measurement

NOTE:
The EUT had been pre-tested on the positioned of each 3 axis. The worst case was found when positioned on **X-plane**.
NOTE: "-" means no effect.

RADIATED EMISSION TEST (ABOVE 1GHz):

- Pre-Scan has been conducted to determine the worst-case mode from all possible combinations between available modulations, data rates and antenna ports (if EUT with antenna diversity architecture).
- Following channel(s) was (were) selected for the final test as listed below.

EUT CONFIGURE MODE	MODE	FREQ. BAND (MHz)	AVAILABLE CHANNEL	TESTED CHANNEL	MODULATION TECHNOLOGY	MODULATION TYPE	DATA RATE (Mbps)
A	802.11a	5180-5240	36 to 48	36, 40, 48	OFDM	BPSK	6.0
A	802.11n (20MHz)		36 to 48	36, 40, 48	OFDM	BPSK	MCS0
A	802.11n (40MHz)		38 to 46	38, 46	OFDM	BPSK	MCS0
A	802.11ac (80MHz)		42	42	OFDM	BPSK	V0
A	802.11a	5260-5320	52 to 64	52, 60, 64	OFDM	BPSK	6.0
A	802.11n (20MHz)		52 to 64	52, 60, 64	OFDM	BPSK	MCS0
A	802.11n (40MHz)		54 to 62	54, 62	OFDM	BPSK	MCS0
A	802.11ac (80MHz)		58	58	OFDM	BPSK	V0
A	802.11a	5500-5700	100 to 140	100, 116, 140	OFDM	BPSK	6.0
A	802.11n (20MHz)		100 to 140	100, 116, 140	OFDM	BPSK	MCS0
A	802.11n (40MHz)		102 to 134	102, 110, 134	OFDM	BPSK	MCS0
A	802.11ac (80MHz)		106	106	OFDM	BPSK	V0
A	802.11a	5725-5825	149 to 165	149, 157, 165	OFDM	BPSK	6.0
A	802.11n (20MHz)		149 to 165	149, 157, 165	OFDM	BPSK	MCS0
A	802.11n (40MHz)		151 to 159	151, 159	OFDM	BPSK	MCS0
A	802.11ac (80MHz)		155	155	OFDM	BPSK	V0



RADIATED EMISSION TEST (BELOW 1GHz):

- Pre-Scan has been conducted to determine the worst-case mode from all possible combinations between available modulations, data rates and antenna ports (if EUT with antenna diversity architecture).
- Following channel(s) was (were) selected for the final test as listed below.

EUT CONFIGURE MODE	MODE	FREQ. BAND (MHz)	AVAILABLE CHANNEL	TESTED CHANNEL	MODULATION TECHNOLOGY	MODULATION TYPE	DATA RATE (Mbps)
A	802.11a	5725-5825	149 to 165	165	OFDM	BPSK	6.0

POWER LINE CONDUCTED EMISSION TEST:

- Pre-Scan has been conducted to determine the worst-case mode from all possible combinations between available modulations, data rates and antenna ports (if EUT with antenna diversity architecture).
- Following channel(s) was (were) selected for the final test as listed below.

EUT CONFIGURE MODE	MODE	FREQ. BAND (MHz)	AVAILABLE CHANNEL	TESTED CHANNEL	MODULATION TECHNOLOGY	MODULATION TYPE	DATA RATE (Mbps)
A	802.11a	5725-5825	149 to 165	165	OFDM	BPSK	6.0

BANDEDGE MEASUREMENT:

- Pre-Scan has been conducted to determine the worst-case mode from all possible combinations between available modulations, data rates and antenna ports (if EUT with antenna diversity architecture).
- Following channel(s) was (were) selected for the final test as listed below.

EUT CONFIGURE MODE	MODE	FREQ. BAND (MHz)	AVAILABLE CHANNEL	TESTED CHANNEL	MODULATION TECHNOLOGY	MODULATION TYPE	DATA RATE (Mbps)
A	802.11a	5180-5240	36 to 48	36, 48	OFDM	BPSK	6.0
A	802.11n (20MHz)		36 to 48	36, 48	OFDM	BPSK	MCS0
A	802.11n (40MHz)		38 to 46	38, 46	OFDM	BPSK	MCS0
A	802.11ac (80MHz)		42	42	OFDM	BPSK	V0
A	802.11a	5260-5320	52 to 64	52, 64	OFDM	BPSK	6.0
A	802.11n (20MHz)		52 to 64	52, 64	OFDM	BPSK	MCS0
A	802.11n (40MHz)		54 to 62	54, 62	OFDM	BPSK	MCS0
A	802.11ac (80MHz)		58	58	OFDM	BPSK	V0
A	802.11a	5500-5700	100 to 140	100, 140	OFDM	BPSK	6.0
A	802.11n (20MHz)		100 to 140	100, 140	OFDM	BPSK	MCS0
A	802.11n (40MHz)		102 to 134	102, 134	OFDM	BPSK	MCS0
A	802.11ac (80MHz)		106	106	OFDM	BPSK	V0
A	802.11a	5725-5825	149 to 165	149, 165	OFDM	BPSK	6.0
A	802.11n (20MHz)		149 to 165	149, 165	OFDM	BPSK	MCS0
A	802.11n (40MHz)		151 to 159	151, 159	OFDM	BPSK	MCS0
A	802.11ac (80MHz)		155	155	OFDM	BPSK	V0



ANTENNA PORT CONDUCTED MEASUREMENT:

- This item includes all test value of each mode, but only includes spectrum plot of worst value of each mode.
- Pre-Scan has been conducted to determine the worst-case mode from all possible combinations between available modulations, data rates and antenna ports (if EUT with antenna diversity architecture).
- Following channel(s) was (were) selected for the final test as listed below.

EUT CONFIGURE MODE	MODE	FREQ. BAND (MHz)	AVAILABLE CHANNEL	TESTED CHANNEL	MODULATION TECHNOLOGY	MODULATION TYPE	DATA RATE (Mbps)
B	802.11a	5180-5240	36 to 48	36, 40, 48	OFDM	BPSK	6.0
B	802.11n (20MHz)		36 to 48	36, 40, 48	OFDM	BPSK	MCS0
B	802.11n (40MHz)		38 to 46	38, 46	OFDM	BPSK	MCS0
B	802.11ac (80MHz)		42	42	OFDM	BPSK	V0
B	802.11a	5260-5320	52 to 64	52, 60, 64	OFDM	BPSK	6.0
B	802.11n (20MHz)		52 to 64	52, 60, 64	OFDM	BPSK	MCS0
B	802.11n (40MHz)		54 to 62	54, 62	OFDM	BPSK	MCS0
B	802.11ac (80MHz)		58	58	OFDM	BPSK	V0
B	802.11a	5500-5700	100 to 140	100, 116, 140	OFDM	BPSK	6.0
B	802.11n (20MHz)		100 to 140	100, 116, 140	OFDM	BPSK	MCS0
B	802.11n (40MHz)		102 to 134	102, 110, 134	OFDM	BPSK	MCS0
B	802.11ac (80MHz)		106	106	OFDM	BPSK	V0
B	802.11a	5725-5825	149 to 165	149, 165	OFDM	BPSK	6.0
B	802.11n (20MHz)		149 to 165	149, 165	OFDM	BPSK	MCS0
B	802.11n (40MHz)		151 to 159	151, 159	OFDM	BPSK	MCS0
B	802.11ac (80MHz)		155	155	OFDM	BPSK	V0

TEST CONDITION:

APPLICABLE TO	ENVIRONMENTAL CONDITIONS	INPUT POWER	TESTED BY
RE<1G	23deg. C, 62%RH	DC 5V By Adapter	Star Le
RE≥1G	23deg. C, 62%RH	DC 5V By Adapter	Star Le
PLC	24deg. C, 61%RH	DC 5V By Adapter	Alex Chen
APCM	23.5deg. C, 60%RH	DC 3.8V By battery	Wenliang Wu



2.3 DUTY CYCLE OF TEST SIGNAL

Duty cycle of test signal is < 98%, duty factor shall be considered.

802.11a: Duty cycle = 1.361/1.578 = 0.862, Duty factor = 10 * log(1/0.862) = 0.64

802.11n (20MHz): Duty cycle = 1.275/1.491 = 0.855, Duty factor = 10 * log(1/0.855) = 0.68

802.11n (40MHz): Duty cycle = 0.632/0.836 = 0.756, Duty factor = 10 * log(1/0.756) = 1.22

802.11ac (80MHz): Duty cycle = 0.246/0.455 = 0.541, Duty factor = 10 * log(1/0.541) = 2.67

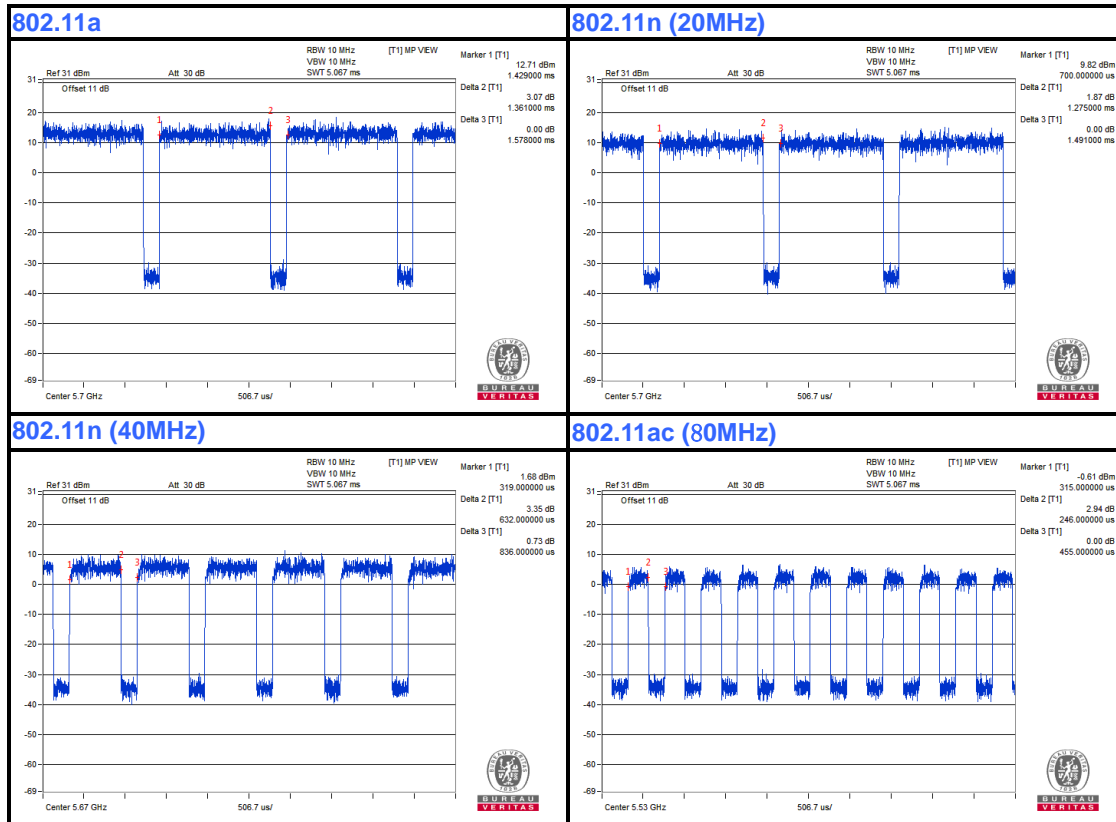



2.4 DESCRIPTION OF SUPPORT UNITS

The EUT has been tested as an independent unit together with other necessary accessories or support units. The following support units or accessories were used to form a representative test configuration during the tests.

NO.	PRODUCT	BRAND	MODEL NO.	SERIAL NO.	FCC ID
1	DC source	LONG WEI	PS-6403D	010934269	N/A
2	PC	HP	A6608CN	3CR83825X3	N/A

NO.	SIGNAL CABLE DESCRIPTION OF THE ABOVE SUPPORT UNITS
1	DC Line: Unshielded, Detachable 1.0m
2	AC Line: Unshielded, Detachable 1.5m

NOTE:

1. All power cords of the above support units are non shielded (1.8m).



2.4.1 CONFIGURATION OF SYSTEM UNDER TEST

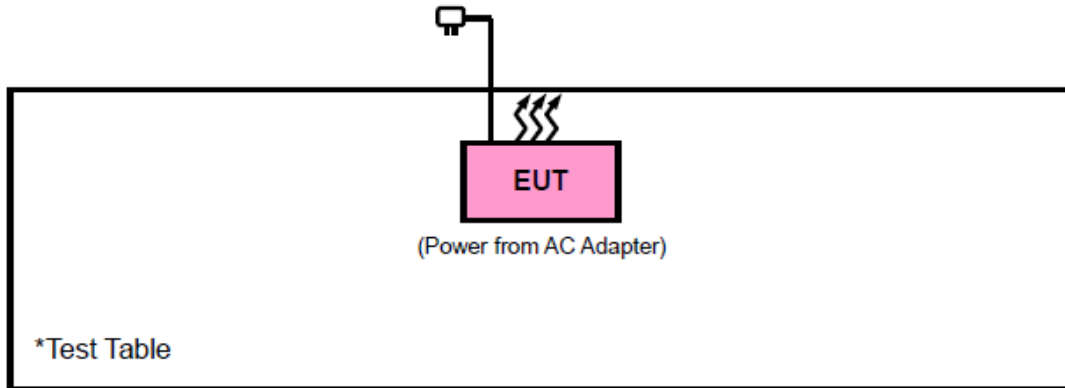

2.5 GENERAL DESCRIPTION OF APPLIED STANDARDS

The EUT is a RF Product. According to the specifications of the manufacturer, it must comply with the requirements of the following standards:

FCC Part 15, Subpart E (15.407)

KDB 789033 D02 General U-NII Test Procedures New Rules v02r01

ANSI C63.10-2013

All test items have been performed and recorded as per the above standards.

NOTE: The EUT is also considered as a kind of computer peripheral, because the connection to computer is necessary for typical use. It has been verified to comply with the requirements of FCC Part 15, Subpart B, Class B (Certification). The test report has been issued separately.



3 TEST TYPES AND RESULTS

3.1 RADIATED EMISSION AND BANDEDGE MEASUREMENT

3.1.1 LIMITS OF RADIATED EMISSION AND BANDEDGE MEASUREMENT

Radiated emissions which fall in the restricted bands must comply with the radiated emission limits specified as below table:

FREQUENCIES (MHz)	FIELD STRENGTH (microvolts/meter)	MEASUREMENT DISTANCE (meters)
0.009 ~ 0.490	2400/F(kHz)	300
0.490 ~ 1.705	24000/F(kHz)	30
1.705 ~ 30.0	30	30
30 ~ 88	100	3
88 ~ 216	150	3
216 ~ 960	200	3
Above 960	500	3

NOTE:

1. The lower limit shall apply at the transition frequencies.
2. Emission level (dBuV/m) = 20 log Emission level (uV/m).
3. For frequencies above 1000MHz, the field strength limits are based on average detector, however, the peak field strength of any emission shall not exceed the maximum permitted average limits, specified above by more than 20dB under any condition of modulation.

3.1.2 LIMITS OF UNWANTED EMISSION

RESTRICTED BANDS	APPLICABLE TO	LIMIT	
	789033 D02 General UNII Test Procedures New Rules v01r02	FIELD STRENGTH AT 3m (dBµV/m)	
	PK : 74	AV : 54	
OUT OF THE RESTRICTED BANDS	APPLICABLE TO	EIRP LIMIT (dBm/MHz)	EQUIVALENT FIELD STRENGTH AT 3m (dBµV/m)
	15.407(b)(1)	PK : -27	PK : 68.3
	15.407(b)(2)		
	15.407(b)(3)		
15.407(b)(4)	See note 2 (FCC 16-24)		



NOTE: The following formula is used to convert the equipment isotropic radiated power (eirp) to field strength:

$$E = \frac{1000000\sqrt{30P}}{3} \text{ } \mu\text{V/m, where P is the eirp (Watts).}$$

2. All emissions shall be limited to a level of -27 dBm/MHz at 75 MHz or more above or below the band edge increasing linearly to 10 dBm/MHz at 25 MHz above or below the band edge, and from 25 MHz above or below the band edge increasing linearly to a level of 15.6 dBm/MHz at 5 MHz above or below the band edge, and from 5 MHz above or below the band edge increasing linearly to a level of 27 dBm/MHz at the band edge.

3.1.3 TEST INSTRUMENTS

Equipment	Manufacturer	Model No.	Serial No.	Last Cal.	Next Cal.
3m Semi-anechoic Chamber	ETS-LINDGREN	9m*6m*6m	Euroshieldpn-CT0001143-1216	May 06,17	May 05,18
Bilog Antenna	ETS-LINDGREN	3143B	00161965	Nov. 26,16	Nov. 25,18
Horn Antenna	ETS-LINDGREN	3117	00168728	Nov. 26,16	Nov. 25,18
Loop antenna	Daze	ZN30900A	0708	Nov. 20,17	Nov. 19,18
Horn Antenna (18GHz-40GHz)	N/A	QWH-SL-18-40-K-SG/QMS-00361	15433	Dec. 16,16	Dec. 15,18
Test Software	E3	V 9.160323	N/A	N/A	N/A
Test Software	ADT	ADT_Radiated_V7.6.15.9.2	N/A	N/A	N/A
10dB Attenuator	JFW/USA	50HF-010-SMA	1505	Jul. 24,17	Jul. 23,18
MXE EMI Receiver	KEYSIGHT	N9038A-544	MY54450026	May 01,18	Feb. 28,19
Signal Pre-Amplifier	EMSI	EMC 9135	980249	Jul. 24,17	Jul. 23,18
Signal Pre-Amplifier	EMSI	EMC 012645B	980257	Jul. 24,17	Jul. 23,18
Signal Pre-Amplifier	EMSI	EMC 184045B	980259	Jul. 24,17	Jul. 23,18

NOTE:

1. The calibration interval of the above test instruments is 12 months and the calibrations are traceable to CEPREI/CHINA, GRGT/CHINA and NIM/CHINA.
2. The test was performed in 3m Chamber.
3. The FCC Site Registration No. is 525120.



3.1.4 TEST PROCEDURES

- a. The EUT was placed on the top of a rotating table 0.8 meters (for below 1GHz) / 1.5 meters (for above 1GHz) above the ground at 3 meter chamber room for test. The table was rotated 360 degrees to determine the position of the highest radiation.
- b. The EUT was set 3 meters away from the interference-receiving antenna, which was mounted on the top of a variable-height antenna tower.
- c. The antenna is a broadband antenna, and its height is varied from one meter to four meters above the ground to determine the maximum value of the field strength. Both horizontal and vertical polarizations of the antenna are set to make the measurement.
- d. For each suspected emission, the EUT was arranged to its worst case and then the antenna was tuned to heights from 1 meter to 4 meters and the rotatable table was turned from 0 degrees to 360 degrees to find the maximum reading.
- e. The test-receiver system was set to Peak Detect Function and Specified Bandwidth with Maximum Hold Mode.
- f. If the emission level of the EUT in peak mode was 10dB lower than the limit specified, then testing could be stopped and the peak values of the EUT would be reported. Otherwise the emissions that did not have 10dB margin would be re-tested one by one using peak, quasi-peak or average method as specified and then reported in a data sheet.

NOTE:

1. The resolution bandwidth and video bandwidth of test receiver/spectrum analyzer is 120kHz for Peak detection (PK) and Quasi-peak detection (QP) at frequency below 1GHz.
2. The resolution bandwidth of test receiver/spectrum analyzer is 1MHz and video bandwidth is 3MHz for Peak detection at frequency above 1GHz.
3. The resolution bandwidth of test receiver/spectrum analyzer is 1MHz and the video bandwidth is 10Hz for Average detection (AV) at frequency above 1GHz.
4. All modes of operation were investigated and the worst-case emissions are reported.

3.1.5 DEVIATION FROM TEST STANDARD

No deviation.



3.1.6 TEST SETUP

< Frequency Range below 30MHz >

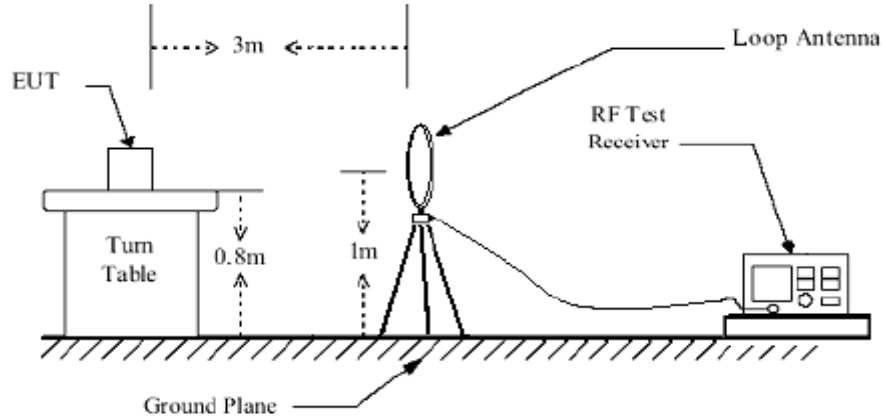

< Frequency Range 30MHz~1GHz >

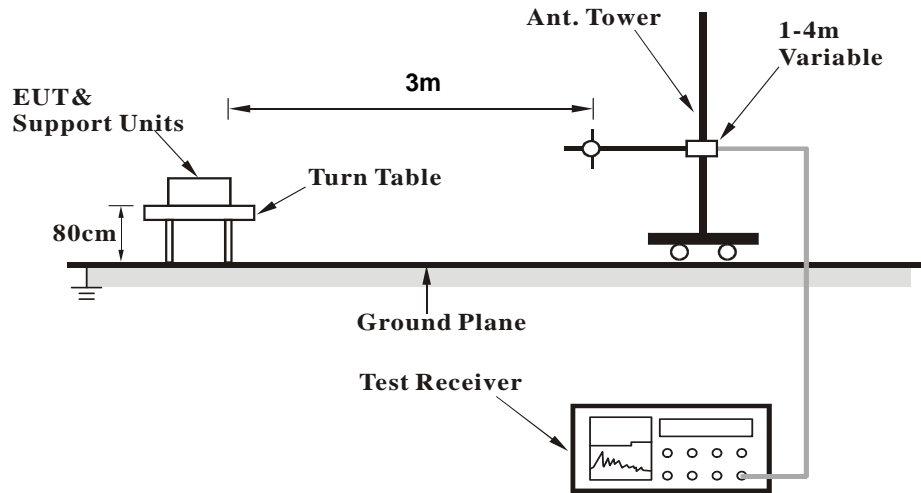



<Frequency Range above 1GHz>

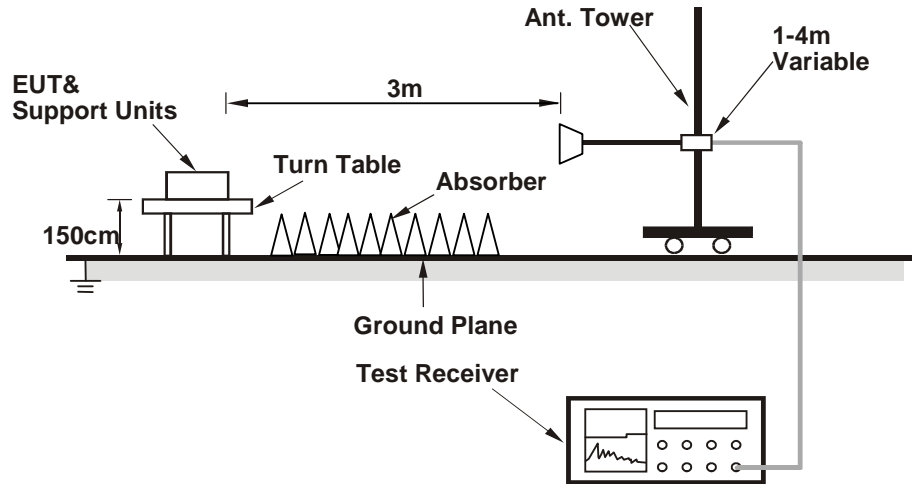

For the actual test configuration, please refer to the attached file (Test Setup Photo).

3.1.7 EUT OPERATING CONDITION

- a. Set the EUT under full load condition and placed them on a testing table.
- b. Set the transmitter part of EUT under transmission condition continuously at specific channel frequency.
- c. The necessary accessories enable the EUT in full functions.



3.1.8 TEST RESULTS

BELOW 1GHz WORST-CASE DATA:

9 KHz – 30 MHz data: the amplitude of spurious emissions attenuated more than 20 dB below the permissible value is not required in the report.

30 MHz – 1GHz data:

802.11a

CHANNEL	TX Channel 165	DETECTOR FUNCTION	Quasi-Peak (QP)
FREQUENCY RANGE	30MHz ~ 1GHz		

ANTENNA POLARITY & TEST DISTANCE: HORIZONTAL AT 3 M										
FREQ. (MHz)	EMISSION LEVEL (dBuV/m)	READ LEVEL (dBuV)	LIMIT (dBuV/m)	MARGIN (dB)	ANTENNA FACTOR (dB /m)	CABLE LOSS (dB)	PREAMP FACTOR (dB)	ANTENNA HEIGHT (cm)	TABLE ANGLE (Degree)	REMARK
41.64	17.11	44.03	40	-22.89	9.59	0.96	37.47	100	322	QP
95.96	22.81	50.75	43.5	-20.69	7.56	1.51	37.01	100	268	QP
150.28	26.43	52.11	43.5	-17.07	9.23	1.88	36.79	100	214	QP
194.9	26.82	51.21	43.5	-16.68	10.05	2.14	36.58	100	85	QP
422.85	16.58	32.66	46	-29.42	17.47	3.22	36.77	100	87	QP
587.75	17.51	30.71	46	-28.49	20.07	3.94	37.21	100	123	QP

REMARKS:

1. Emission level (dBuV/m) = Raw Value (dBuV) + Correction Factor (dB/m).
2. Correction Factor (dB/m) = Antenna Factor (dB/m) + Cable Factor (dB).
3. The other emission levels were very low against the limit.
4. Margin value = Emission level – Limit value.

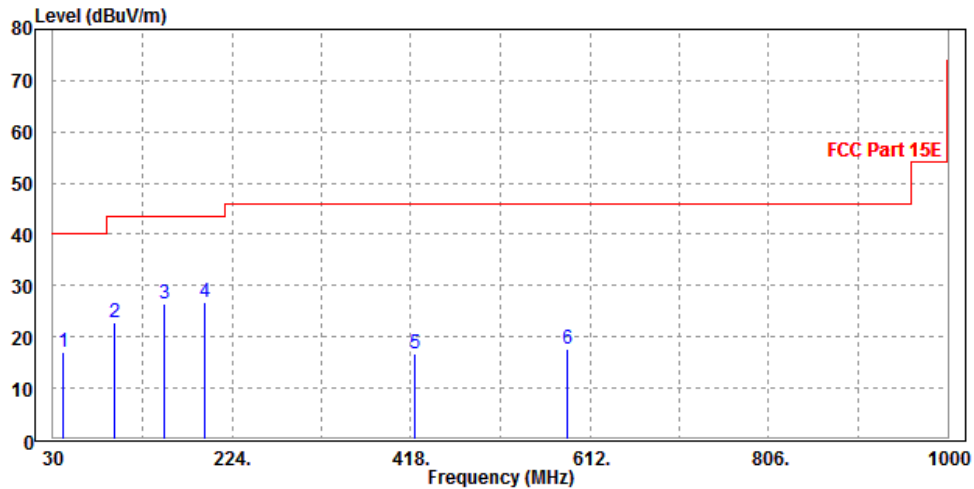



CHANNEL	Channel 165	DETECTOR FUNCTION	Quasi-Peak (QP)
FREQUENCY RANGE	30MHz ~ 1GHz		

ANTENNA POLARITY & TEST DISTANCE: VERTICAL AT 3 M										
FREQ. (MHz)	EMISSION LEVEL (dBuV/m)	READ LEVEL (dBuV)	LIMIT (dBuV/m)	MARGIN (dB)	ANTENNA FACTOR (dB /m)	CABLE LOSS (dB)	PREAMP FACTOR (dB)	ANTENNA HEIGHT (cm)	TABLE ANGLE (Degree)	REMARK
42.61	27.98	55.23	40	-12.02	9.23	0.98	37.46	100	162	QP
91.11	19.61	48.15	43.5	-23.89	7.02	1.47	37.03	100	5	QP
150.28	24.5	50.18	43.5	-19	9.23	1.88	36.79	100	114	QP
193.93	27.37	51.78	43.5	-16.13	10.04	2.14	36.59	100	48	QP
386.96	16.05	33	46	-29.95	16.65	3.09	36.69	100	235	QP
667.29	22.35	33.3	46	-23.65	22.18	4.19	37.32	100	308	QP

REMARKS:

1. Emission level (dBuV/m) = Raw Value (dBuV) + Correction Factor (dB/m).
2. Correction Factor (dB/m) = Antenna Factor (dB/m) + Cable Factor (dB).
3. The other emission levels were very low against the limit.
4. Margin value = Emission level – Limit value.

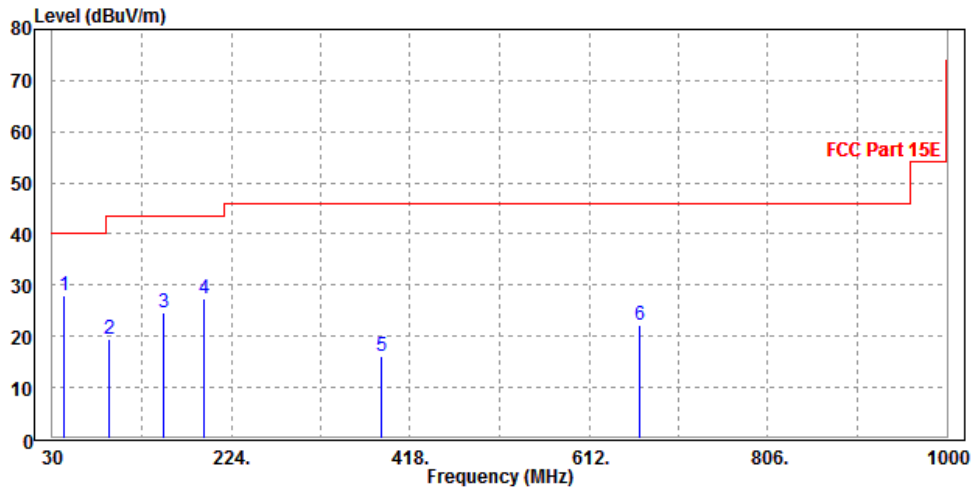



ABOVE 1GHz WORST-CASE DATA:

Note: For higher frequency, the emission is too low to be detected.

Band 1
802.11a

CHANNEL	TX Channel 36	DETECTOR FUNCTION	Peak (PK)
FREQUENCY RANGE	1GHz ~ 40GHz		Average (AV)

ANTENNA POLARITY & TEST DISTANCE: HORIZONTAL AT 3 M										
FREQ. (MHz)	EMISSION LEVEL (dBuV/m)	READ LEVEL (dBuV)	LIMIT (dBuV/m)	MARGIN (dB)	ANTENNA FACTOR (dB /m)	CABLE LOSS (dB)	PREAMP FACTOR (dB)	ANTENNA HEIGHT (cm)	TABLE ANGLE (Degree)	REMARK
5150	44.21	42.23	54	-9.79	34.48	13.71	46.21	130	20	Average
5150	55.57	53.59	74	-18.43	34.48	13.71	46.21	130	20	Peak
5180	93.11	91.02			34.52	13.79	46.22	130	20	Average
5180	102.3	100.21			34.52	13.79	46.22	130	20	Peak
5350	43.77	41.02	54	-10.23	34.72	14.28	46.25	130	20	Average
5350	55.41	52.66	74	-18.59	34.72	14.28	46.25	130	20	Peak

ANTENNA POLARITY & TEST DISTANCE: VERTICAL AT 3 M										
FREQ. (MHz)	EMISSION LEVEL (dBuV/m)	READ LEVEL (dBuV)	LIMIT (dBuV/m)	MARGIN (dB)	ANTENNA FACTOR (dB /m)	CABLE LOSS (dB)	PREAMP FACTOR (dB)	ANTENNA HEIGHT (cm)	TABLE ANGLE (Degree)	REMARK
5150	43.84	41.86	54	-10.16	34.48	13.71	46.21	100	295	Average
5150	55.53	53.55	74	-18.47	34.48	13.71	46.21	100	295	Peak
5180	95.83	93.74			34.52	13.79	46.22	100	295	Average
5180	106.58	104.49			34.52	13.79	46.22	100	295	Peak
5350	45.59	42.84	54	-8.41	34.72	14.28	46.25	100	295	Average
5350	56.74	53.99	74	-17.26	34.72	14.28	46.25	100	295	Peak

REMARKS:

- Emission Level = Read Level+ Antenna Factor + Cable Loss- Preamp Factor
Margin value = Emission level – Limit value.
- 5180MHz: Fundamental frequency.



CHANNEL	TX Channel 40	DETECTOR FUNCTION	Peak (PK)
FREQUENCY RANGE	1GHz ~ 40GHz		Average (AV)

ANTENNA POLARITY & TEST DISTANCE: HORIZONTAL AT 3 M										
FREQ. (MHz)	EMISSION LEVEL (dBuV/m)	READ LEVEL (dBuV)	LIMIT (dBuV/m)	MARGIN (dB)	ANTENNA FACTOR (dB /m)	CABLE LOSS (dB)	PREAMP FACTOR (dB)	ANTENNA HEIGHT (cm)	TABLE ANGLE (Degree)	REMARK
5150	43.42	41.44	54	-10.58	34.48	13.71	46.21	130	230	Average
5150	55.26	53.28	74	-18.74	34.48	13.71	46.21	130	230	Peak
5200	94.42	92.25			34.54	13.85	46.22	130	230	Average
5200	103.74	101.57			34.54	13.85	46.22	130	230	Peak
5350	46.33	43.58	54	-7.67	34.72	14.28	46.25	130	230	Average
5350	55.15	52.4	74	-18.85	34.72	14.28	46.25	130	230	Peak

ANTENNA POLARITY & TEST DISTANCE: VERTICAL AT 3 M										
FREQ. (MHz)	EMISSION LEVEL (dBuV/m)	READ LEVEL (dBuV)	LIMIT (dBuV/m)	MARGIN (dB)	ANTENNA FACTOR (dB /m)	CABLE LOSS (dB)	PREAMP FACTOR (dB)	ANTENNA HEIGHT (cm)	TABLE ANGLE (Degree)	REMARK
5150	44.75	42.77	54	-9.25	34.48	13.71	46.21	100	305	Average
5150	55.96	53.98	74	-18.04	34.48	13.71	46.21	100	305	Peak
5200	93.58	91.41			34.54	13.85	46.22	100	305	Average
5200	105.74	103.57			34.54	13.85	46.22	100	305	Peak
5350	44.47	41.72	54	-9.53	34.72	14.28	46.25	100	305	Average
5350	54.81	52.06	74	-19.19	34.72	14.28	46.25	100	305	Peak

REMARKS:

1. Emission Level = Read Level+ Antenna Factor + Cable Loss- Preamp Factor
Margin value = Emission level – Limit value.
2. 5200MHz: Fundamental frequency.



CHANNEL	TX Channel 48	DETECTOR FUNCTION	Peak (PK)
FREQUENCY RANGE	1GHz ~ 40GHz		Average (AV)

ANTENNA POLARITY & TEST DISTANCE: HORIZONTAL AT 3 M										
FREQ. (MHz)	EMISSION LEVEL (dBuV/m)	READ LEVEL (dBuV)	LIMIT (dBuV/m)	MARGIN (dB)	ANTENNA FACTOR (dB /m)	CABLE LOSS (dB)	PREAMP FACTOR (dB)	ANTENNA HEIGHT (cm)	TABLE ANGLE (Degree)	REMARK
5150	43.69	41.71	54	-10.31	34.48	13.71	46.21	125	235	Average
5150	54.94	52.96	74	-19.06	34.48	13.71	46.21	125	235	Peak
5240	93.5	91.17			34.59	13.97	46.23	125	235	Average
5240	103.17	100.84			34.59	13.97	46.23	125	235	Peak
5350	42.77	40.02	54	-11.23	34.72	14.28	46.25	125	235	Average
5350	53.88	51.13	74	-20.12	34.72	14.28	46.25	125	235	Peak

ANTENNA POLARITY & TEST DISTANCE: VERTICAL AT 3 M										
FREQ. (MHz)	EMISSION LEVEL (dBuV/m)	READ LEVEL (dBuV)	LIMIT (dBuV/m)	MARGIN (dB)	ANTENNA FACTOR (dB /m)	CABLE LOSS (dB)	PREAMP FACTOR (dB)	ANTENNA HEIGHT (cm)	TABLE ANGLE (Degree)	REMARK
5150	44.56	42.58	54	-9.44	34.48	13.71	46.21	100	130	Average
5150	55.84	53.86	74	-18.16	34.48	13.71	46.21	100	130	Peak
5240	95.67	93.34			34.59	13.97	46.23	100	130	Average
5240	105.25	102.92			34.59	13.97	46.23	100	130	Peak
5350	44.53	41.78	54	-9.47	34.72	14.28	46.25	100	130	Average
5350	55.18	52.43	74	-18.82	34.72	14.28	46.25	100	130	Peak

REMARKS:

1. Emission Level = Read Level+ Antenna Factor + Cable Loss- Preamp Factor
Margin value = Emission level – Limit value.
2. 5240MHz: Fundamental frequency.



802.11n (20MHz)

CHANNEL	TX Channel 36	DETECTOR FUNCTION	Peak (PK)
FREQUENCY RANGE	1GHz ~ 40GHz		Average (AV)

ANTENNA POLARITY & TEST DISTANCE: HORIZONTAL AT 3 M										
FREQ. (MHz)	EMISSION LEVEL (dBuV/m)	READ LEVEL (dBuV)	LIMIT (dBuV/m)	MARGIN (dB)	ANTENNA FACTOR (dB /m)	CABLE LOSS (dB)	PREAMP FACTOR (dB)	ANTENNA HEIGHT (cm)	TABLE ANGLE (Degree)	REMARK
5150	44.05	42.07	54	-9.95	34.48	13.71	46.21	100	230	Average
5150	55.14	53.16	74	-18.86	34.48	13.71	46.21	100	230	Peak
5180	94.68	92.59			34.52	13.79	46.22	100	230	Average
5180	103.06	100.97			34.52	13.79	46.22	100	230	Peak
5350	43.3	40.55	54	-10.7	34.72	14.28	46.25	100	230	Average
5350	53.17	50.42	74	-20.83	34.72	14.28	46.25	100	230	Peak

ANTENNA POLARITY & TEST DISTANCE: VERTICAL AT 3 M										
FREQ. (MHz)	EMISSION LEVEL (dBuV/m)	READ LEVEL (dBuV)	LIMIT (dBuV/m)	MARGIN (dB)	ANTENNA FACTOR (dB /m)	CABLE LOSS (dB)	PREAMP FACTOR (dB)	ANTENNA HEIGHT (cm)	TABLE ANGLE (Degree)	REMARK
5150	42.65	40.67	54	-11.35	34.48	13.71	46.21	100	270	Average
5150	54.6	52.62	74	-19.4	34.48	13.71	46.21	100	270	Peak
5180	94.65	92.56			34.52	13.79	46.22	100	270	Average
5180	105.47	103.38			34.52	13.79	46.22	100	270	Peak
5350	44.49	41.74	54	-9.51	34.72	14.28	46.25	100	270	Average
5350	54.49	51.74	74	-19.51	34.72	14.28	46.25	100	270	Peak

REMARKS:

1. Emission Level = Read Level+ Antenna Factor + Cable Loss- Preamp Factor
Margin value = Emission level – Limit value.
2. 5180MHz: Fundamental frequency.



CHANNEL	TX Channel 40	DETECTOR FUNCTION	Peak (PK)
FREQUENCY RANGE	1GHz ~ 40GHz		Average (AV)

ANTENNA POLARITY & TEST DISTANCE: HORIZONTAL AT 3 M										
FREQ. (MHz)	EMISSION LEVEL (dBuV/m)	READ LEVEL (dBuV)	LIMIT (dBuV/m)	MARGIN (dB)	ANTENNA FACTOR (dB /m)	CABLE LOSS (dB)	PREAMP FACTOR (dB)	ANTENNA HEIGHT (cm)	TABLE ANGLE (Degree)	REMARK
5150	44.25	42.27	54	-9.75	34.48	13.71	46.21	100	225	Average
5150	55.49	53.51	74	-18.51	34.48	13.71	46.21	100	225	Peak
5200	94.33	92.16			34.54	13.85	46.22	100	225	Average
5200	102.4	100.23			34.54	13.85	46.22	100	225	Peak
5350	44.42	41.67	54	-9.58	34.72	14.28	46.25	100	225	Average
5350	53.59	50.84	74	-20.41	34.72	14.28	46.25	100	225	Peak

ANTENNA POLARITY & TEST DISTANCE: VERTICAL AT 3 M										
FREQ. (MHz)	EMISSION LEVEL (dBuV/m)	READ LEVEL (dBuV)	LIMIT (dBuV/m)	MARGIN (dB)	ANTENNA FACTOR (dB /m)	CABLE LOSS (dB)	PREAMP FACTOR (dB)	ANTENNA HEIGHT (cm)	TABLE ANGLE (Degree)	REMARK
5150	43.8	41.82	54	-10.2	34.48	13.71	46.21	100	272	Average
5150	54.64	52.66	74	-19.36	34.48	13.71	46.21	100	272	Peak
5200	93.18	91.01			34.54	13.85	46.22	100	272	Average
5200	103.89	101.72			34.54	13.85	46.22	100	272	Peak
5350	43.67	40.92	54	-10.33	34.72	14.28	46.25	100	272	Average
5350	52.62	49.87	74	-21.38	34.72	14.28	46.25	100	272	Peak

REMARKS:

1. Emission Level = Read Level+ Antenna Factor + Cable Loss- Preamp Factor
Margin value = Emission level – Limit value.
2. 5200MHz: Fundamental frequency.



CHANNEL	TX Channel 48	DETECTOR FUNCTION	Peak (PK)
FREQUENCY RANGE	1GHz ~ 40GHz		Average (AV)

ANTENNA POLARITY & TEST DISTANCE: HORIZONTAL AT 3 M										
FREQ. (MHz)	EMISSION LEVEL (dBuV/m)	READ LEVEL (dBuV)	LIMIT (dBuV/m)	MARGIN (dB)	ANTENNA FACTOR (dB /m)	CABLE LOSS (dB)	PREAMP FACTOR (dB)	ANTENNA HEIGHT (cm)	TABLE ANGLE (Degree)	REMARK
5150	43.34	41.36	54	-10.66	34.48	13.71	46.21	100	230	Average
5150	54.06	52.08	74	-19.94	34.48	13.71	46.21	100	230	Peak
5240	94.4	92.07			34.59	13.97	46.23	100	230	Average
5240	102.69	100.36			34.59	13.97	46.23	100	230	Peak
5350	43.97	41.22	54	-10.03	34.72	14.28	46.25	100	230	Average
5350	53.11	50.36	74	-20.89	34.72	14.28	46.25	100	230	Peak

ANTENNA POLARITY & TEST DISTANCE: VERTICAL AT 3 M										
FREQ. (MHz)	EMISSION LEVEL (dBuV/m)	READ LEVEL (dBuV)	LIMIT (dBuV/m)	MARGIN (dB)	ANTENNA FACTOR (dB /m)	CABLE LOSS (dB)	PREAMP FACTOR (dB)	ANTENNA HEIGHT (cm)	TABLE ANGLE (Degree)	REMARK
5150	44.67	42.69	54	-9.33	34.48	13.71	46.21	100	265	Average
5150	55.89	53.91	74	-18.11	34.48	13.71	46.21	100	265	Peak
5240	94.16	91.83			34.59	13.97	46.23	100	265	Average
5240	101.95	99.62			34.59	13.97	46.23	100	265	Peak
5350	44.51	41.76	54	-9.49	34.72	14.28	46.25	100	265	Average
5350	52.91	50.16	74	-21.09	34.72	14.28	46.25	100	265	Peak

REMARKS:

1. Emission Level = Read Level+ Antenna Factor + Cable Loss- Preamp Factor
Margin value = Emission level – Limit value.
2. 5240MHz: Fundamental frequency.



802.11n (40MHz)

CHANNEL	TX Channel 38	DETECTOR FUNCTION	Peak (PK)
FREQUENCY RANGE	1GHz ~ 40GHz		Average (AV)

ANTENNA POLARITY & TEST DISTANCE: HORIZONTAL AT 3 M										
FREQ. (MHz)	EMISSION LEVEL (dBuV/m)	READ LEVEL (dBuV)	LIMIT (dBuV/m)	MARGIN (dB)	ANTENNA FACTOR (dB /m)	CABLE LOSS (dB)	PREAMP FACTOR (dB)	ANTENNA HEIGHT (cm)	TABLE ANGLE (Degree)	REMARK
5150	44.33	42.35	54	-9.67	34.48	13.71	46.21	105	232	Average
5150	53.36	51.38	74	-20.64	34.48	13.71	46.21	105	232	Peak
5190	93.61	91.48			34.53	13.82	46.22	105	232	Average
5190	102.22	100.09			34.53	13.82	46.22	105	232	Peak
5350	44.23	41.48	54	-9.77	34.72	14.28	46.25	105	232	Average
5350	53.46	50.71	74	-20.54	34.72	14.28	46.25	105	232	Peak

ANTENNA POLARITY & TEST DISTANCE: VERTICAL AT 3 M										
FREQ. (MHz)	EMISSION LEVEL (dBuV/m)	READ LEVEL (dBuV)	LIMIT (dBuV/m)	MARGIN (dB)	ANTENNA FACTOR (dB /m)	CABLE LOSS (dB)	PREAMP FACTOR (dB)	ANTENNA HEIGHT (cm)	TABLE ANGLE (Degree)	REMARK
5150	43.05	41.07	54	-10.95	34.48	13.71	46.21	100	272	Average
5150	54.31	52.33	74	-19.69	34.48	13.71	46.21	100	272	Peak
5190	93.67	91.54			34.53	13.82	46.22	100	272	Average
5190	101.2	99.07			34.53	13.82	46.22	100	272	Peak
5350	44.5	41.75	54	-9.5	34.72	14.28	46.25	100	272	Average
5350	53.18	50.43	74	-20.82	34.72	14.28	46.25	100	272	Peak

REMARKS:

- Emission Level = Read Level+ Antenna Factor + Cable Loss- Preamp Factor
Margin value = Emission level – Limit value.
- 5190MHz: Fundamental frequency.



CHANNEL	TX Channel 46	DETECTOR FUNCTION	Peak (PK)
FREQUENCY RANGE	1GHz ~ 40GHz		Average (AV)

ANTENNA POLARITY & TEST DISTANCE: HORIZONTAL AT 3 M

FREQ. (MHz)	EMISSION LEVEL (dBuV/m)	READ LEVEL (dBuV)	LIMIT (dBuV/m)	MARGIN (dB)	ANTENNA FACTOR (dB /m)	CABLE LOSS (dB)	PREAMP FACTOR (dB)	ANTENNA HEIGHT (cm)	TABLE ANGLE (Degree)	REMARK
5150	43.53	41.55	54	-10.47	34.48	13.71	46.21	100	233	Average
5150	52.39	50.41	74	-21.61	34.48	13.71	46.21	100	233	Peak
5230	91.93	89.64			34.58	13.94	46.23	100	233	Average
5230	101.25	98.96			34.58	13.94	46.23	100	233	Peak
5350	43.42	40.67	54	-10.58	34.72	14.28	46.25	100	233	Average
5350	52.88	50.13	74	-21.12	34.72	14.28	46.25	100	233	Peak

ANTENNA POLARITY & TEST DISTANCE: VERTICAL AT 3 M

FREQ. (MHz)	EMISSION LEVEL (dBuV/m)	READ LEVEL (dBuV)	LIMIT (dBuV/m)	MARGIN (dB)	ANTENNA FACTOR (dB /m)	CABLE LOSS (dB)	PREAMP FACTOR (dB)	ANTENNA HEIGHT (cm)	TABLE ANGLE (Degree)	REMARK
5150	44.02	42.04	54	-9.98	34.48	13.71	46.21	100	268	Average
5150	54.46	52.48	74	-19.54	34.48	13.71	46.21	100	268	Peak
5230	91.98	89.69			34.58	13.94	46.23	100	268	Average
5230	102.16	99.87			34.58	13.94	46.23	100	268	Peak
5350	44.45	41.7	54	-9.55	34.72	14.28	46.25	100	268	Average
5350	53.29	50.54	74	-20.71	34.72	14.28	46.25	100	268	Peak

REMARKS:

- Emission Level = Read Level+ Antenna Factor + Cable Loss- Preamp Factor
Margin value = Emission level – Limit value.
- 5230MHz: Fundamental frequency.



802.11ac (80MHz)

CHANNEL	TX Channel 42	DETECTOR FUNCTION	Peak (PK)
FREQUENCY RANGE	1GHz ~ 40GHz		Average (AV)

ANTENNA POLARITY & TEST DISTANCE: HORIZONTAL AT 3 M										
FREQ. (MHz)	EMISSION LEVEL (dBuV/m)	READ LEVEL (dBuV)	LIMIT (dBuV/m)	MARGIN (dB)	ANTENNA FACTOR (dB /m)	CABLE LOSS (dB)	PREAMP FACTOR (dB)	ANTENNA HEIGHT (cm)	TABLE ANGLE (Degree)	REMARK
5150	45	43.02	54	-9	34.48	13.71	46.21	100	235	Average
5150	56.93	54.95	74	-17.07	34.48	13.71	46.21	100	235	Peak
5210	92.12	89.91			34.55	13.88	46.22	100	235	Average
5210	101.72	99.51			34.55	13.88	46.22	100	235	Peak
5350	44.49	41.74	54	-9.51	34.72	14.28	46.25	100	235	Average
5350	53.67	50.92	74	-20.33	34.72	14.28	46.25	100	235	Peak

ANTENNA POLARITY & TEST DISTANCE: VERTICAL AT 3 M										
FREQ. (MHz)	EMISSION LEVEL (dBuV/m)	READ LEVEL (dBuV)	LIMIT (dBuV/m)	MARGIN (dB)	ANTENNA FACTOR (dB /m)	CABLE LOSS (dB)	PREAMP FACTOR (dB)	ANTENNA HEIGHT (cm)	TABLE ANGLE (Degree)	REMARK
5150	43.14	41.16	54	-10.86	34.48	13.71	46.21	105	276	Average
5150	52.16	50.18	74	-21.84	34.48	13.71	46.21	105	276	Peak
5210	91.89	89.68			34.55	13.88	46.22	105	276	Average
5210	103.15	100.94			34.55	13.88	46.22	105	276	Peak
5350	43.41	40.66	54	-10.59	34.72	14.28	46.25	105	276	Average
5350	53.12	50.37	74	-20.88	34.72	14.28	46.25	105	276	Peak

REMARKS:

- Emission Level = Read Level+ Antenna Factor + Cable Loss- Preamp Factor
Margin value = Emission level – Limit value.
- 5210MHz: Fundamental frequency.



Band 2
802.11a

CHANNEL	TX Channel 52	DETECTOR FUNCTION	Peak (PK)
FREQUENCY RANGE	1GHz ~ 40GHz		Average (AV)

ANTENNA POLARITY & TEST DISTANCE: HORIZONTAL AT 3 M										
FREQ. (MHz)	EMISSION LEVEL (dBuV/m)	READ LEVEL (dBuV)	LIMIT (dBuV/m)	MARGIN (dB)	ANTENNA FACTOR (dB /m)	CABLE LOSS (dB)	PREAMP FACTOR (dB)	ANTENNA HEIGHT (cm)	TABLE ANGLE (Degree)	REMARK
5150	43.14	41.16	54	-10.86	34.48	13.71	46.21	100	232	Average
5150	51.86	49.88	74	-22.14	34.48	13.71	46.21	100	232	Peak
5260	94.68	92.28			34.61	14.02	46.23	100	232	Average
5260	102.21	99.81			34.61	14.02	46.23	100	232	Peak
5350	43.87	41.12	54	-10.13	34.72	14.28	46.25	100	232	Average
5350	53.13	50.38	74	-20.87	34.72	14.28	46.25	100	232	Peak
ANTENNA POLARITY & TEST DISTANCE: VERTICAL AT 3 M										
FREQ. (MHz)	EMISSION LEVEL (dBuV/m)	READ LEVEL (dBuV)	LIMIT (dBuV/m)	MARGIN (dB)	ANTENNA FACTOR (dB /m)	CABLE LOSS (dB)	PREAMP FACTOR (dB)	ANTENNA HEIGHT (cm)	TABLE ANGLE (Degree)	REMARK
5150	42.67	40.69	54	-11.33	34.48	13.71	46.21	100	268	Average
5150	51.35	49.37	74	-22.65	34.48	13.71	46.21	100	268	Peak
5260	92.7	90.3			34.61	14.02	46.23	100	268	Average
5260	101.56	99.16			34.61	14.02	46.23	100	268	Peak
5350	43.52	40.77	54	-10.48	34.72	14.28	46.25	100	268	Average
5350	52.12	49.37	74	-21.88	34.72	14.28	46.25	100	268	Peak

REMARKS:

1. Emission Level = Read Level+ Antenna Factor + Cable Loss- Preamp Factor
Margin value = Emission level – Limit value.
2. 5260MHz: Fundamental frequency.



CHANNEL	TX Channel 60	DETECTOR FUNCTION	Peak (PK)
FREQUENCY RANGE	1GHz ~ 40GHz		Average (AV)

ANTENNA POLARITY & TEST DISTANCE: HORIZONTAL AT 3 M										
FREQ. (MHz)	EMISSION LEVEL (dBuV/m)	READ LEVEL (dBuV)	LIMIT (dBuV/m)	MARGIN (dB)	ANTENNA FACTOR (dB /m)	CABLE LOSS (dB)	PREAMP FACTOR (dB)	ANTENNA HEIGHT (cm)	TABLE ANGLE (Degree)	REMARK
5150	42.21	40.23	54	-11.79	34.48	13.71	46.21	100	230	Average
5150	51.99	50.01	74	-22.01	34.48	13.71	46.21	100	230	Peak
5300	92.5	89.94			34.66	14.14	46.24	100	230	Average
5300	102.12	99.56			34.66	14.14	46.24	100	230	Peak
5350	42.9	40.15	54	-11.1	34.72	14.28	46.25	100	230	Average
5350	52.59	49.84	74	-21.41	34.72	14.28	46.25	100	230	Peak

ANTENNA POLARITY & TEST DISTANCE: VERTICAL AT 3 M										
FREQ. (MHz)	EMISSION LEVEL (dBuV/m)	READ LEVEL (dBuV)	LIMIT (dBuV/m)	MARGIN (dB)	ANTENNA FACTOR (dB /m)	CABLE LOSS (dB)	PREAMP FACTOR (dB)	ANTENNA HEIGHT (cm)	TABLE ANGLE (Degree)	REMARK
5150	42.1	40.12	54	-11.9	34.48	13.71	46.21	105	270	Average
5150	51.53	49.55	74	-22.47	34.48	13.71	46.21	105	270	Peak
5300	90.84	88.28			34.66	14.14	46.24	105	270	Average
5300	99.81	97.25			34.66	14.14	46.24	105	270	Peak
5350	43.3	40.55	54	-10.7	34.72	14.28	46.25	105	270	Average
5350	53.04	50.29	74	-20.96	34.72	14.28	46.25	105	270	Peak

REMARKS:

- Emission Level = Read Level+ Antenna Factor + Cable Loss- Preamp Factor
Margin value = Emission level – Limit value.
- 5300MHz: Fundamental frequency.



CHANNEL	TX Channel 64	DETECTOR FUNCTION	Peak (PK)
FREQUENCY RANGE	1GHz ~ 40GHz		Average (AV)

ANTENNA POLARITY & TEST DISTANCE: HORIZONTAL AT 3 M

FREQ. (MHz)	EMISSION LEVEL (dBuV/m)	READ LEVEL (dBuV)	LIMIT (dBuV/m)	MARGIN (dB)	ANTENNA FACTOR (dB /m)	CABLE LOSS (dB)	PREAMP FACTOR (dB)	ANTENNA HEIGHT (cm)	TABLE ANGLE (Degree)	REMARK
5150	42.14	40.16	54	-11.86	34.48	13.71	46.21	100	234	Average
5150	54.34	52.36	74	-19.66	34.48	13.71	46.21	100	234	Peak
5320	94.1	91.46			34.68	14.2	46.24	100	234	Average
5320	100.63	97.99			34.68	14.2	46.24	100	234	Peak
5350	43.12	40.37	54	-10.88	34.72	14.28	46.25	100	234	Average
5350	53.48	50.73	74	-20.52	34.72	14.28	46.25	100	234	Peak

ANTENNA POLARITY & TEST DISTANCE: VERTICAL AT 3 M

FREQ. (MHz)	EMISSION LEVEL (dBuV/m)	READ LEVEL (dBuV)	LIMIT (dBuV/m)	MARGIN (dB)	ANTENNA FACTOR (dB /m)	CABLE LOSS (dB)	PREAMP FACTOR (dB)	ANTENNA HEIGHT (cm)	TABLE ANGLE (Degree)	REMARK
5150	42.29	40.31	54	-11.71	34.48	13.71	46.21	100	265	Average
5150	52.94	50.96	74	-21.06	34.48	13.71	46.21	100	265	Peak
5320	91.96	89.32			34.68	14.2	46.24	100	265	Average
5320	101.32	98.68			34.68	14.2	46.24	100	265	Peak
5350	43.37	40.62	54	-10.63	34.72	14.28	46.25	100	265	Average
5350	51.99	49.24	74	-22.01	34.72	14.28	46.25	100	265	Peak

REMARKS:

- Emission Level = Read Level+ Antenna Factor + Cable Loss- Preamp Factor
Margin value = Emission level – Limit value.
- 5320MHz: Fundamental frequency.



802.11n (20MHz)

CHANNEL	TX Channel 52	DETECTOR FUNCTION	Peak (PK)
FREQUENCY RANGE	1GHz ~ 40GHz		Average (AV)

ANTENNA POLARITY & TEST DISTANCE: HORIZONTAL AT 3 M										
FREQ. (MHz)	EMISSION LEVEL (dBuV/m)	READ LEVEL (dBuV)	LIMIT (dBuV/m)	MARGIN (dB)	ANTENNA FACTOR (dB /m)	CABLE LOSS (dB)	PREAMP FACTOR (dB)	ANTENNA HEIGHT (cm)	TABLE ANGLE (Degree)	REMARK
5150	43.51	41.53	54	-10.49	34.48	13.71	46.21	105	225	Average
5150	53.29	51.31	74	-20.71	34.48	13.71	46.21	105	225	Peak
5260	92.42	90.02			34.61	14.02	46.23	105	225	Average
5260	101.56	99.16			34.61	14.02	46.23	105	225	Peak
5350	43.08	40.33	54	-10.92	34.72	14.28	46.25	105	225	Average
5350	53.52	50.77	74	-20.48	34.72	14.28	46.25	105	225	Peak

ANTENNA POLARITY & TEST DISTANCE: VERTICAL AT 3 M										
FREQ. (MHz)	EMISSION LEVEL (dBuV/m)	READ LEVEL (dBuV)	LIMIT (dBuV/m)	MARGIN (dB)	ANTENNA FACTOR (dB /m)	CABLE LOSS (dB)	PREAMP FACTOR (dB)	ANTENNA HEIGHT (cm)	TABLE ANGLE (Degree)	REMARK
5150	42.19	40.21	54	-11.81	34.48	13.71	46.21	108	270	Average
5150	53.23	51.25	74	-20.77	34.48	13.71	46.21	108	270	Peak
5260	91.08	88.68			34.61	14.02	46.23	108	270	Average
5260	100.35	97.95			34.61	14.02	46.23	108	270	Peak
5350	42.97	40.22	54	-11.03	34.72	14.28	46.25	108	270	Average
5350	53.21	50.46	74	-20.79	34.72	14.28	46.25	108	270	Peak

REMARKS:

- Emission Level = Read Level+ Antenna Factor + Cable Loss- Preamp Factor
Margin value = Emission level – Limit value.
- 5260MHz: Fundamental frequency.



CHANNEL	TX Channel 60	DETECTOR FUNCTION	Peak (PK)
FREQUENCY RANGE	1GHz ~ 40GHz		Average (AV)

ANTENNA POLARITY & TEST DISTANCE: HORIZONTAL AT 3 M										
FREQ. (MHz)	EMISSION LEVEL (dBuV/m)	READ LEVEL (dBuV)	LIMIT (dBuV/m)	MARGIN (dB)	ANTENNA FACTOR (dB /m)	CABLE LOSS (dB)	PREAMP FACTOR (dB)	ANTENNA HEIGHT (cm)	TABLE ANGLE (Degree)	REMARK
5150	44.27	42.29	54	-9.73	34.48	13.71	46.21	108	232	Average
5150	54.18	52.2	74	-19.82	34.48	13.71	46.21	108	232	Peak
5300	91.76	89.2			34.66	14.14	46.24	108	232	Average
5300	100.6	98.04			34.66	14.14	46.24	108	232	Peak
5350	43	40.25	54	-11	34.72	14.28	46.25	108	232	Average
5350	52.78	50.03	74	-21.22	34.72	14.28	46.25	108	232	Peak

ANTENNA POLARITY & TEST DISTANCE: VERTICAL AT 3 M										
FREQ. (MHz)	EMISSION LEVEL (dBuV/m)	READ LEVEL (dBuV)	LIMIT (dBuV/m)	MARGIN (dB)	ANTENNA FACTOR (dB /m)	CABLE LOSS (dB)	PREAMP FACTOR (dB)	ANTENNA HEIGHT (cm)	TABLE ANGLE (Degree)	REMARK
5150	41.89	39.91	54	-12.11	34.48	13.71	46.21	100	278	Average
5150	52.94	50.96	74	-21.06	34.48	13.71	46.21	100	278	Peak
5300	91.05	88.49			34.66	14.14	46.24	100	278	Average
5300	102.02	99.46			34.66	14.14	46.24	100	278	Peak
5350	43.31	40.56	54	-10.69	34.72	14.28	46.25	100	278	Average
5350	52.89	50.14	74	-21.11	34.72	14.28	46.25	100	278	Peak

REMARKS:

- Emission Level = Read Level+ Antenna Factor + Cable Loss- Preamp Factor
Margin value = Emission level – Limit value.
- 5300MHz: Fundamental frequency.



CHANNEL	TX Channel 64	DETECTOR FUNCTION	Peak (PK)
FREQUENCY RANGE	1GHz ~ 40GHz		Average (AV)

ANTENNA POLARITY & TEST DISTANCE: HORIZONTAL AT 3 M										
FREQ. (MHz)	EMISSION LEVEL (dBuV/m)	READ LEVEL (dBuV)	LIMIT (dBuV/m)	MARGIN (dB)	ANTENNA FACTOR (dB /m)	CABLE LOSS (dB)	PREAMP FACTOR (dB)	ANTENNA HEIGHT (cm)	TABLE ANGLE (Degree)	REMARK
5150	42.17	40.19	54	-11.83	34.48	13.71	46.21	100	230	Average
5150	51.96	49.98	74	-22.04	34.48	13.71	46.21	100	230	Peak
5320	92.08	89.44			34.68	14.2	46.24	100	230	Average
5320	100.07	97.43			34.68	14.2	46.24	100	230	Peak
5350	43.11	40.36	54	-10.89	34.72	14.28	46.25	100	230	Average
5350	53.29	50.54	74	-20.71	34.72	14.28	46.25	100	230	Peak

ANTENNA POLARITY & TEST DISTANCE: VERTICAL AT 3 M										
FREQ. (MHz)	EMISSION LEVEL (dBuV/m)	READ LEVEL (dBuV)	LIMIT (dBuV/m)	MARGIN (dB)	ANTENNA FACTOR (dB /m)	CABLE LOSS (dB)	PREAMP FACTOR (dB)	ANTENNA HEIGHT (cm)	TABLE ANGLE (Degree)	REMARK
5150	42.05	40.07	54	-11.95	34.48	13.71	46.21	105	260	Average
5150	51.63	49.65	74	-22.37	34.48	13.71	46.21	105	260	Peak
5320	91.03	88.39			34.68	14.2	46.24	105	260	Average
5320	102.48	99.84			34.68	14.2	46.24	105	260	Peak
5350	43.37	40.62	54	-10.63	34.72	14.28	46.25	105	260	Average
5350	52.73	49.98	74	-21.27	34.72	14.28	46.25	105	260	Peak

REMARKS:

- Emission Level = Read Level+ Antenna Factor + Cable Loss- Preamp Factor
Margin value = Emission level – Limit value.
- 5320MHz: Fundamental frequency.



802.11n (40MHz)

CHANNEL	TX Channel 54	DETECTOR FUNCTION	Peak (PK)
FREQUENCY RANGE	1GHz ~ 40GHz		Average (AV)

ANTENNA POLARITY & TEST DISTANCE: HORIZONTAL AT 3 M										
FREQ. (MHz)	EMISSION LEVEL (dBuV/m)	READ LEVEL (dBuV)	LIMIT (dBuV/m)	MARGIN (dB)	ANTENNA FACTOR (dB /m)	CABLE LOSS (dB)	PREAMP FACTOR (dB)	ANTENNA HEIGHT (cm)	TABLE ANGLE (Degree)	REMARK
5150	45.94	43.96	54	-8.06	34.48	13.71	46.21	150	230	Average
5150	55.86	53.88	74	-18.14	34.48	13.71	46.21	150	230	Peak
5270	93.93	91.49			34.62	14.05	46.23	150	230	Average
5270	104.32	101.88			34.62	14.05	46.23	150	230	Peak
5350	43.46	40.71	54	-10.54	34.72	14.28	46.25	150	230	Average
5350	52.96	50.21	74	-21.04	34.72	14.28	46.25	150	230	Peak

ANTENNA POLARITY & TEST DISTANCE: VERTICAL AT 3 M										
FREQ. (MHz)	EMISSION LEVEL (dBuV/m)	READ LEVEL (dBuV)	LIMIT (dBuV/m)	MARGIN (dB)	ANTENNA FACTOR (dB /m)	CABLE LOSS (dB)	PREAMP FACTOR (dB)	ANTENNA HEIGHT (cm)	TABLE ANGLE (Degree)	REMARK
5150	45.96	43.98	54	-8.04	34.48	13.71	46.21	100	270	Average
5150	55.29	53.31	74	-18.71	34.48	13.71	46.21	100	270	Peak
5270	92.62	90.18			34.62	14.05	46.23	100	270	Average
5270	103.79	101.35			34.62	14.05	46.23	100	270	Peak
5350	43.29	40.54	54	-10.71	34.72	14.28	46.25	100	270	Average
5350	53.26	50.51	74	-20.74	34.72	14.28	46.25	100	270	Peak

REMARKS:

- Emission Level = Read Level+ Antenna Factor + Cable Loss- Preamp Factor
Margin value = Emission level – Limit value.
- 5270MHz: Fundamental frequency.



CHANNEL	TX Channel 62	DETECTOR FUNCTION	Peak (PK)
FREQUENCY RANGE	1GHz ~ 40GHz		Average (AV)

ANTENNA POLARITY & TEST DISTANCE: HORIZONTAL AT 3 M

FREQ. (MHz)	EMISSION LEVEL (dBuV/m)	READ LEVEL (dBuV)	LIMIT (dBuV/m)	MARGIN (dB)	ANTENNA FACTOR (dB /m)	CABLE LOSS (dB)	PREAMP FACTOR (dB)	ANTENNA HEIGHT (cm)	TABLE ANGLE (Degree)	REMARK
5150	43.29	41.31	54	-10.71	34.48	13.71	46.21	180	235	Average
5150	52.63	50.65	74	-21.37	34.48	13.71	46.21	180	235	Peak
5310	93.43	90.83			34.67	14.17	46.24	180	235	Average
5310	103.32	100.72			34.67	14.17	46.24	180	235	Peak
5350	43.46	40.71	54	-10.54	34.72	14.28	46.25	180	235	Average
5350	52.78	50.03	74	-21.22	34.72	14.28	46.25	180	235	Peak

ANTENNA POLARITY & TEST DISTANCE: VERTICAL AT 3 M

FREQ. (MHz)	EMISSION LEVEL (dBuV/m)	READ LEVEL (dBuV)	LIMIT (dBuV/m)	MARGIN (dB)	ANTENNA FACTOR (dB /m)	CABLE LOSS (dB)	PREAMP FACTOR (dB)	ANTENNA HEIGHT (cm)	TABLE ANGLE (Degree)	REMARK
5150	43.86	41.88	54	-10.14	34.48	13.71	46.21	150	273	Average
5150	53.87	51.89	74	-20.13	34.48	13.71	46.21	150	273	Peak
5310	93.79	91.19			34.67	14.17	46.24	150	273	Average
5310	103.89	101.29			34.67	14.17	46.24	150	273	Peak
5350	44.62	41.87	54	-9.38	34.72	14.28	46.25	150	273	Average
5350	53.64	50.89	74	-20.36	34.72	14.28	46.25	150	273	Peak

REMARKS:

- Emission Level = Read Level+ Antenna Factor + Cable Loss- Preamp Factor
Margin value = Emission level – Limit value.
- 5310MHz: Fundamental frequency.



802.11ac (80MHz)

CHANNEL	TX Channel 58	DETECTOR FUNCTION	Peak (PK)
FREQUENCY RANGE	1GHz ~ 40GHz		Average (AV)

ANTENNA POLARITY & TEST DISTANCE: HORIZONTAL AT 3 M										
FREQ. (MHz)	EMISSION LEVEL (dBuV/m)	READ LEVEL (dBuV)	LIMIT (dBuV/m)	MARGIN (dB)	ANTENNA FACTOR (dB /m)	CABLE LOSS (dB)	PREAMP FACTOR (dB)	ANTENNA HEIGHT (cm)	TABLE ANGLE (Degree)	REMARK
5150	44.87	42.89	54	-9.13	34.48	13.71	46.21	100	230	Average
5150	55.27	53.29	74	-18.73	34.48	13.71	46.21	100	230	Peak
5290	93.81	91.29			34.65	14.11	46.24	100	230	Average
5290	104.11	101.59			34.65	14.11	46.24	100	230	Peak
5350	43.62	40.87	54	-10.38	34.72	14.28	46.25	100	230	Average
5350	53.81	51.06	74	-20.19	34.72	14.28	46.25	100	230	Peak

ANTENNA POLARITY & TEST DISTANCE: VERTICAL AT 3 M										
FREQ. (MHz)	EMISSION LEVEL (dBuV/m)	READ LEVEL (dBuV)	LIMIT (dBuV/m)	MARGIN (dB)	ANTENNA FACTOR (dB /m)	CABLE LOSS (dB)	PREAMP FACTOR (dB)	ANTENNA HEIGHT (cm)	TABLE ANGLE (Degree)	REMARK
5150	45.84	43.86	54	-8.16	34.48	13.71	46.21	100	268	Average
5150	55.66	53.68	74	-18.34	34.48	13.71	46.21	100	268	Peak
5290	92.92	90.4			34.65	14.11	46.24	100	268	Average
5290	103.87	101.35			34.65	14.11	46.24	100	268	Peak
5350	43.43	40.68	54	-10.57	34.72	14.28	46.25	100	268	Average
5350	53.16	50.41	74	-20.84	34.72	14.28	46.25	100	268	Peak

REMARKS:

- Emission Level = Read Level+ Antenna Factor + Cable Loss- Preamp Factor
Margin value = Emission level – Limit value.
- 5290MHz: Fundamental frequency.



Band 3

802.11a

CHANNEL	TX Channel 100	DETECTOR FUNCTION	Peak (PK)
FREQUENCY RANGE	1GHz ~ 40GHz		Average (AV)

ANTENNA POLARITY & TEST DISTANCE: HORIZONTAL AT 3 M										
FREQ. (MHz)	EMISSION LEVEL (dBuV/m)	READ LEVEL (dBuV)	LIMIT (dBuV/m)	MARGIN (dB)	ANTENNA FACTOR (dB /m)	CABLE LOSS (dB)	PREAMP FACTOR (dB)	ANTENNA HEIGHT (cm)	TABLE ANGLE (Degree)	REMARK
5460	45.86	42.68	54	-8.14	34.85	14.6	46.27	100	250	Average
5460	54.29	51.11	74	-19.71	34.85	14.6	46.27	100	250	Peak
#5470	55	51.79	68.3	-13.3	34.86	14.62	46.27	100	250	Peak
5500	95.18	91.85			34.9	14.71	46.28	100	250	Average
5500	102.92	99.59			34.9	14.71	46.28	100	250	Peak

ANTENNA POLARITY & TEST DISTANCE: VERTICAL AT 3 M										
FREQ. (MHz)	EMISSION LEVEL (dBuV/m)	READ LEVEL (dBuV)	LIMIT (dBuV/m)	MARGIN (dB)	ANTENNA FACTOR (dB /m)	CABLE LOSS (dB)	PREAMP FACTOR (dB)	ANTENNA HEIGHT (cm)	TABLE ANGLE (Degree)	REMARK
5460	44.94	41.76	54	-9.06	34.85	14.6	46.27	100	300	Average
5460	54.37	51.19	74	-19.63	34.85	14.6	46.27	100	300	Peak
#5470	55.05	51.84	68.3	-13.25	34.86	14.62	46.27	100	300	Peak
5500	93.64	90.31			34.9	14.71	46.28	100	300	Average
5500	103.69	100.36			34.9	14.71	46.28	100	300	Peak

REMARKS:

1. Emission Level = Read Level+ Antenna Factor + Cable Loss- Preamp Factor
Margin value = Emission level – Limit value.
2. 5500MHz: Fundamental frequency.
3. #: Out of restricted band.



CHANNEL	TX Channel 116	DETECTOR FUNCTION	Peak (PK)
FREQUENCY RANGE	1GHz ~ 40GHz		Average (AV)

ANTENNA POLARITY & TEST DISTANCE: HORIZONTAL AT 3 M										
FREQ. (MHz)	EMISSION LEVEL (dBuV/m)	READ LEVEL (dBuV)	LIMIT (dBuV/m)	MARGIN (dB)	ANTENNA FACTOR (dB /m)	CABLE LOSS (dB)	PREAMP FACTOR (dB)	ANTENNA HEIGHT (cm)	TABLE ANGLE (Degree)	REMARK
5460	44.5	41.32	54	-9.5	34.85	14.6	46.27	100	256	Average
5460	53.86	50.68	74	-20.14	34.85	14.6	46.27	100	256	Peak
#5470	54.22	51.01	68.3	-14.08	34.86	14.62	46.27	100	256	Peak
5580	95.3	91.35			35	15.23	46.28	100	256	Average
5580	102.73	98.78			35	15.23	46.28	100	256	Peak

ANTENNA POLARITY & TEST DISTANCE: VERTICAL AT 3 M										
FREQ. (MHz)	EMISSION LEVEL (dBuV/m)	READ LEVEL (dBuV)	LIMIT (dBuV/m)	MARGIN (dB)	ANTENNA FACTOR (dB /m)	CABLE LOSS (dB)	PREAMP FACTOR (dB)	ANTENNA HEIGHT (cm)	TABLE ANGLE (Degree)	REMARK
5460	43.92	40.74	54	-10.08	34.85	14.6	46.27	120	310	Average
5460	52.23	49.05	74	-21.77	34.85	14.6	46.27	120	310	Peak
#5470	51.73	48.52	68.3	-16.57	34.86	14.62	46.27	120	310	Peak
5580	92.92	88.97			35	15.23	46.28	120	310	Average
5580	102.4	98.45			35	15.23	46.28	120	310	Peak

REMARKS:

- Emission Level = Read Level+ Antenna Factor + Cable Loss- Preamp Factor
Margin value = Emission level – Limit value.
- 5580MHz: Fundamental frequency.
- #: Out of restricted band.



CHANNEL	TX Channel 140	DETECTOR FUNCTION	Peak (PK)
FREQUENCY RANGE	1GHz ~ 40GHz		Average (AV)

ANTENNA POLARITY & TEST DISTANCE: HORIZONTAL AT 3 M										
FREQ. (MHz)	EMISSION LEVEL (dBuV/m)	READ LEVEL (dBuV)	LIMIT (dBuV/m)	MARGIN (dB)	ANTENNA FACTOR (dB /m)	CABLE LOSS (dB)	PREAMP FACTOR (dB)	ANTENNA HEIGHT (cm)	TABLE ANGLE (Degree)	REMARK
5700	95.43	90.56			35.14	16.01	46.28	190	215	Average
5700	102.91	98.04			35.14	16.01	46.28	190	215	Peak
#5725	55.62	50.55	68.3	-12.68	35.17	16.18	46.28	190	215	Peak
ANTENNA POLARITY & TEST DISTANCE: VERTICAL AT 3 M										
FREQ. (MHz)	EMISSION LEVEL (dBuV/m)	READ LEVEL (dBuV)	LIMIT (dBuV/m)	MARGIN (dB)	ANTENNA FACTOR (dB /m)	CABLE LOSS (dB)	PREAMP FACTOR (dB)	ANTENNA HEIGHT (cm)	TABLE ANGLE (Degree)	REMARK
5700	95.29	90.42			35.14	16.01	46.28	100	210	Average
5700	105.44	100.57			35.14	16.01	46.28	100	210	Peak
#5725	56.26	51.19	68.3	-12.04	35.17	16.18	46.28	100	210	Peak

REMARKS:

1. Emission Level = Read Level+ Antenna Factor + Cable Loss- Preamp Factor
Margin value = Emission level – Limit value.
2. 5700MHz: Fundamental frequency.
3. #: Out of restricted band.



802.11n (20MHz)

CHANNEL	TX Channel 100	DETECTOR FUNCTION	Peak (PK)
FREQUENCY RANGE	1GHz ~ 40GHz		Average (AV)

ANTENNA POLARITY & TEST DISTANCE: HORIZONTAL AT 3 M										
FREQ. (MHz)	EMISSION LEVEL (dBuV/m)	READ LEVEL (dBuV)	LIMIT (dBuV/m)	MARGIN (dB)	ANTENNA FACTOR (dB /m)	CABLE LOSS (dB)	PREAMP FACTOR (dB)	ANTENNA HEIGHT (cm)	TABLE ANGLE (Degree)	REMARK
5460	43.23	40.05	54	-10.77	34.85	14.6	46.27	120	260	Average
5460	52.71	49.53	74	-21.29	34.85	14.6	46.27	120	260	Peak
#5470	53.12	49.91	68.3	-15.18	34.86	14.62	46.27	120	260	Peak
5500	95.08	91.75			34.9	14.71	46.28	120	260	Average
5500	103.4	100.07			34.9	14.71	46.28	120	260	Peak
ANTENNA POLARITY & TEST DISTANCE: VERTICAL AT 3 M										
FREQ. (MHz)	EMISSION LEVEL (dBuV/m)	READ LEVEL (dBuV)	LIMIT (dBuV/m)	MARGIN (dB)	ANTENNA FACTOR (dB /m)	CABLE LOSS (dB)	PREAMP FACTOR (dB)	ANTENNA HEIGHT (cm)	TABLE ANGLE (Degree)	REMARK
5460	43.23	40.05	54	-10.77	34.85	14.6	46.27	120	220	Average
5460	53.65	50.47	74	-20.35	34.85	14.6	46.27	120	220	Peak
#5470	53.56	50.35	68.3	-14.74	34.86	14.62	46.27	120	220	Peak
5500	93.66	90.33			34.9	14.71	46.28	120	220	Average
5500	102.37	99.04			34.9	14.71	46.28	120	220	Peak

REMARKS:

1. Emission Level = Read Level+ Antenna Factor + Cable Loss- Preamp Factor
Margin value = Emission level – Limit value.
2. 5500MHz: Fundamental frequency.
3. #: Out of restricted band.



CHANNEL	TX Channel 116	DETECTOR FUNCTION	Peak (PK)
FREQUENCY RANGE	1GHz ~ 40GHz		Average (AV)

ANTENNA POLARITY & TEST DISTANCE: HORIZONTAL AT 3 M										
FREQ. (MHz)	EMISSION LEVEL (dBuV/m)	READ LEVEL (dBuV)	LIMIT (dBuV/m)	MARGIN (dB)	ANTENNA FACTOR (dB /m)	CABLE LOSS (dB)	PREAMP FACTOR (dB)	ANTENNA HEIGHT (cm)	TABLE ANGLE (Degree)	REMARK
5460	44.79	41.61	54	-9.21	34.85	14.6	46.27	1000	228	Average
5460	54.96	51.78	74	-19.04	34.85	14.6	46.27	1000	228	Peak
#5470	53.53	50.32	68.3	-14.77	34.86	14.62	46.27	1000	228	Peak
5580	95.64	91.69			35	15.23	46.28	1000	228	Average
5580	103.44	99.49			35	15.23	46.28	1000	228	Peak

ANTENNA POLARITY & TEST DISTANCE: VERTICAL AT 3 M										
FREQ. (MHz)	EMISSION LEVEL (dBuV/m)	READ LEVEL (dBuV)	LIMIT (dBuV/m)	MARGIN (dB)	ANTENNA FACTOR (dB /m)	CABLE LOSS (dB)	PREAMP FACTOR (dB)	ANTENNA HEIGHT (cm)	TABLE ANGLE (Degree)	REMARK
5460	43.81	40.63	54	-10.19	34.85	14.6	46.27	100	230	Average
5460	53.56	50.38	74	-20.44	34.85	14.6	46.27	100	230	Peak
#5470	53.39	50.18	68.3	-14.91	34.86	14.62	46.27	100	230	Peak
5580	93.86	89.91			35	15.23	46.28	100	230	Average
5580	103.62	99.67			35	15.23	46.28	100	230	Peak

REMARKS:

1. Emission Level = Read Level+ Antenna Factor + Cable Loss- Preamp Factor
Margin value = Emission level – Limit value.
2. 5580MHz: Fundamental frequency.
3. #: Out of restricted band.



CHANNEL	TX Channel 140	DETECTOR FUNCTION	Peak (PK)
FREQUENCY RANGE	1GHz ~ 40GHz		Average (AV)

ANTENNA POLARITY & TEST DISTANCE: HORIZONTAL AT 3 M										
FREQ. (MHz)	EMISSION LEVEL (dBuV/m)	READ LEVEL (dBuV)	LIMIT (dBuV/m)	MARGIN (dB)	ANTENNA FACTOR (dB /m)	CABLE LOSS (dB)	PREAMP FACTOR (dB)	ANTENNA HEIGHT (cm)	TABLE ANGLE (Degree)	REMARK
5700	95.38	90.51			35.14	16.01	46.28	100	260	Average
5700	103.96	99.09			35.14	16.01	46.28	100	260	Peak
#5725	57.59	52.52	68.3	-10.71	35.17	16.18	46.28	100	260	Peak
ANTENNA POLARITY & TEST DISTANCE: VERTICAL AT 3 M										
FREQ. (MHz)	EMISSION LEVEL (dBuV/m)	READ LEVEL (dBuV)	LIMIT (dBuV/m)	MARGIN (dB)	ANTENNA FACTOR (dB /m)	CABLE LOSS (dB)	PREAMP FACTOR (dB)	ANTENNA HEIGHT (cm)	TABLE ANGLE (Degree)	REMARK
5700	96.4	91.53			35.14	16.01	46.28	100	210	Average
5700	106.83	101.96			35.14	16.01	46.28	100	210	Peak
#5725	57.66	52.59	68.3	-10.64	35.17	16.18	46.28	100	210	Peak

REMARKS:

1. Emission Level = Read Level+ Antenna Factor + Cable Loss- Preamp Factor
Margin value = Emission level – Limit value.
2. 5700MHz: Fundamental frequency.
3. #: Out of restricted band.



802.11n (40MHz)

CHANNEL	TX Channel 102	DETECTOR FUNCTION	Peak (PK)
FREQUENCY RANGE	1GHz ~ 40GHz		Average (AV)

ANTENNA POLARITY & TEST DISTANCE: HORIZONTAL AT 3 M										
FREQ. (MHz)	EMISSION LEVEL (dBuV/m)	READ LEVEL (dBuV)	LIMIT (dBuV/m)	MARGIN (dB)	ANTENNA FACTOR (dB /m)	CABLE LOSS (dB)	PREAMP FACTOR (dB)	ANTENNA HEIGHT (cm)	TABLE ANGLE (Degree)	REMARK
5460	44.69	41.51	54	-9.31	34.85	14.6	46.27	130	255	Average
5460	54.24	51.06	74	-19.76	34.85	14.6	46.27	130	255	Peak
#5470	54.87	51.66	68.3	-13.43	34.86	14.62	46.27	130	255	Peak
5510	94.2	90.79			34.91	14.78	46.28	130	255	Average
5510	103.8	100.39			34.91	14.78	46.28	130	255	Peak

ANTENNA POLARITY & TEST DISTANCE: VERTICAL AT 3 M										
FREQ. (MHz)	EMISSION LEVEL (dBuV/m)	READ LEVEL (dBuV)	LIMIT (dBuV/m)	MARGIN (dB)	ANTENNA FACTOR (dB /m)	CABLE LOSS (dB)	PREAMP FACTOR (dB)	ANTENNA HEIGHT (cm)	TABLE ANGLE (Degree)	REMARK
5460	45.97	42.79	54	-8.03	34.85	14.6	46.27	100	290	Average
5460	55.73	52.55	74	-18.27	34.85	14.6	46.27	100	290	Peak
#5470	54.88	51.67	68.3	-13.42	34.86	14.62	46.27	100	290	Peak
5510	92.22	88.81			34.91	14.78	46.28	100	290	Average
5510	102.86	99.45			34.91	14.78	46.28	100	290	Peak

REMARKS:

1. Emission Level = Read Level+ Antenna Factor + Cable Loss- Preamp Factor
Margin value = Emission level – Limit value.
2. 5510MHz: Fundamental frequency.
3. #: Out of restricted band.



CHANNEL	TX Channel 110	DETECTOR FUNCTION	Peak (PK)
FREQUENCY RANGE	1GHz ~ 40GHz		Average (AV)

ANTENNA POLARITY & TEST DISTANCE: HORIZONTAL AT 3 M										
FREQ. (MHz)	EMISSION LEVEL (dBuV/m)	READ LEVEL (dBuV)	LIMIT (dBuV/m)	MARGIN (dB)	ANTENNA FACTOR (dB /m)	CABLE LOSS (dB)	PREAMP FACTOR (dB)	ANTENNA HEIGHT (cm)	TABLE ANGLE (Degree)	REMARK
5460	44.54	41.36	54	-9.46	34.85	14.6	46.27	100	258	Average
5460	55.05	51.87	74	-18.95	34.85	14.6	46.27	100	258	Peak
#5470	54.33	51.12	68.3	-13.97	34.86	14.62	46.27	100	258	Peak
5550	92.98	89.26			34.96	15.04	46.28	100	258	Average
5550	103.31	99.59			34.96	15.04	46.28	100	258	Peak

ANTENNA POLARITY & TEST DISTANCE: VERTICAL AT 3 M										
FREQ. (MHz)	EMISSION LEVEL (dBuV/m)	READ LEVEL (dBuV)	LIMIT (dBuV/m)	MARGIN (dB)	ANTENNA FACTOR (dB /m)	CABLE LOSS (dB)	PREAMP FACTOR (dB)	ANTENNA HEIGHT (cm)	TABLE ANGLE (Degree)	REMARK
5460	44.39	41.21	54	-9.61	34.85	14.6	46.27	100	300	Average
5460	54.42	51.24	74	-19.58	34.85	14.6	46.27	100	300	Peak
#5470	54.68	51.47	68.3	-13.62	34.86	14.62	46.27	100	300	Peak
5550	93.4	89.68			34.96	15.04	46.28	100	300	Average
5550	103.58	99.86			34.96	15.04	46.28	100	300	Peak

REMARKS:

1. Emission Level = Read Level+ Antenna Factor + Cable Loss- Preamp Factor
Margin value = Emission level – Limit value.
2. 5550MHz: Fundamental frequency.
3. #: Out of restricted band.



CHANNEL	TX Channel 134	DETECTOR FUNCTION	Peak (PK)
FREQUENCY RANGE	1GHz ~ 40GHz		Average (AV)

ANTENNA POLARITY & TEST DISTANCE: HORIZONTAL AT 3 M										
FREQ. (MHz)	EMISSION LEVEL (dBuV/m)	READ LEVEL (dBuV)	LIMIT (dBuV/m)	MARGIN (dB)	ANTENNA FACTOR (dB /m)	CABLE LOSS (dB)	PREAMP FACTOR (dB)	ANTENNA HEIGHT (cm)	TABLE ANGLE (Degree)	REMARK
5670	95.38	90.74			35.1	15.82	46.28	100	258	Average
5670	102.7	98.06			35.1	15.82	46.28	100	258	Peak
#5725	56.11	51.04	68.3	-12.19	35.17	16.18	46.28	100	258	Peak
ANTENNA POLARITY & TEST DISTANCE: VERTICAL AT 3 M										
FREQ. (MHz)	EMISSION LEVEL (dBuV/m)	READ LEVEL (dBuV)	LIMIT (dBuV/m)	MARGIN (dB)	ANTENNA FACTOR (dB /m)	CABLE LOSS (dB)	PREAMP FACTOR (dB)	ANTENNA HEIGHT (cm)	TABLE ANGLE (Degree)	REMARK
5670	94.24	89.6			35.1	15.82	46.28	100	215	Average
5670	104.88	100.24			35.1	15.82	46.28	100	215	Peak
#5725	55.13	50.06	68.3	-13.17	35.17	16.18	46.28	100	215	Peak

REMARKS:

1. Emission Level = Read Level+ Antenna Factor + Cable Loss- Preamp Factor
Margin value = Emission level – Limit value.
2. 5670MHz: Fundamental frequency.
3. #: Out of restricted band.



802.11ac (80MHz)

CHANNEL	TX Channel 106	DETECTOR FUNCTION	Peak (PK)
FREQUENCY RANGE	1GHz ~ 40GHz		Average (AV)

ANTENNA POLARITY & TEST DISTANCE: HORIZONTAL AT 3 M										
FREQ. (MHz)	EMISSION LEVEL (dBuV/m)	READ LEVEL (dBuV)	LIMIT (dBuV/m)	MARGIN (dB)	ANTENNA FACTOR (dB /m)	CABLE LOSS (dB)	PREAMP FACTOR (dB)	ANTENNA HEIGHT (cm)	TABLE ANGLE (Degree)	REMARK
5460	45.24	42.06	54	-8.76	34.85	14.6	46.27	230	230	Average
5460	55.31	52.13	74	-18.69	34.85	14.6	46.27	230	230	Peak
#5470	55.2	51.99	68.3	-13.1	34.86	14.62	46.27	230	230	Peak
5530	93.17	89.6			34.94	14.91	46.28	230	230	Average
5530	103.79	100.22			34.94	14.91	46.28	230	230	Peak

ANTENNA POLARITY & TEST DISTANCE: VERTICAL AT 3 M										
FREQ. (MHz)	EMISSION LEVEL (dBuV/m)	READ LEVEL (dBuV)	LIMIT (dBuV/m)	MARGIN (dB)	ANTENNA FACTOR (dB /m)	CABLE LOSS (dB)	PREAMP FACTOR (dB)	ANTENNA HEIGHT (cm)	TABLE ANGLE (Degree)	REMARK
5460	44.77	41.59	54	-9.23	34.85	14.6	46.27	100	300	Average
5460	54.85	51.67	74	-19.15	34.85	14.6	46.27	100	300	Peak
#5470	56.18	52.97	68.3	-12.12	34.86	14.62	46.27	100	300	Peak
5530	93.1	89.53			34.94	14.91	46.28	100	300	Average
5530	101.97	98.4			34.94	14.91	46.28	100	300	Peak

REMARKS:

1. Emission Level = Read Level+ Antenna Factor + Cable Loss- Preamp Factor
Margin value = Emission level – Limit value.
2. 5530MHz: Fundamental frequency.
3. #: Out of restricted band.



Band 4

802.11a

CHANNEL	TX Channel 149	DETECTOR FUNCTION	Peak (PK)
FREQUENCY RANGE	1GHz ~ 40GHz		Average (AV)

ANTENNA POLARITY & TEST DISTANCE: HORIZONTAL AT 3 M										
FREQ. (MHz)	EMISSION LEVEL (dBuV/m)	READ LEVEL (dBuV)	LIMIT (dBuV/m)	MARGIN (dB)	ANTENNA FACTOR (dB /m)	CABLE LOSS (dB)	PREAMP FACTOR (dB)	ANTENNA HEIGHT (cm)	TABLE ANGLE (Degree)	REMARK
5745	97.73	92.51			35.19	16.31	46.28	100	250	Average
5745	105.38	100.16			35.19	16.31	46.28	100	250	Peak
ANTENNA POLARITY & TEST DISTANCE: VERTICAL AT 3 M										
FREQ. (MHz)	EMISSION LEVEL (dBuV/m)	READ LEVEL (dBuV)	LIMIT (dBuV/m)	MARGIN (dB)	ANTENNA FACTOR (dB /m)	CABLE LOSS (dB)	PREAMP FACTOR (dB)	ANTENNA HEIGHT (cm)	TABLE ANGLE (Degree)	REMARK
5745	94.31	89.09			35.19	16.31	46.28	100	248	Average
5745	104.9	99.68			35.19	16.31	46.28	100	248	Peak

REMARKS:

1. Emission Level = Read Level+ Antenna Factor + Cable Loss- Preamp Factor
Margin value = Emission level – Limit value.
2. 5745MHz: Fundamental frequency.



OOBE DATA

802.11a

ANTENNA POLARITY & TEST DISTANCE: HORIZONTAL AT 3 M										
FREQ. (MHz)	EMISSION LEVEL (dBuV/m)	READ LEVEL (dBuV)	LIMIT (dBuV/m)	MARGIN (dB)	ANTENNA FACTOR (dB /m)	CABLE LOSS (dB)	PREAMP FACTOR (dB)	ANTENNA HEIGHT (cm)	TABLE ANGLE (Degree)	REMARK
5605.58	53.9	49.75	68.3	-14.4	35.03	15.4	46.28	100	250	Peak
6004.58	57.18	50.01	68.3	-11.12	35.5	17.95	46.28	100	250	Peak
ANTENNA POLARITY & TEST DISTANCE: VERTICAL AT 3 M										
FREQ. (MHz)	EMISSION LEVEL (dBuV/m)	READ LEVEL (dBuV)	LIMIT (dBuV/m)	MARGIN (dB)	ANTENNA FACTOR (dB /m)	CABLE LOSS (dB)	PREAMP FACTOR (dB)	ANTENNA HEIGHT (cm)	TABLE ANGLE (Degree)	REMARK
5612.23	55.6	51.41	68.3	-12.7	35.03	15.44	46.28	100	248	Peak
5999.35	57.75	50.56	68.3	-10.55	35.5	17.97	46.28	101	250	Peak

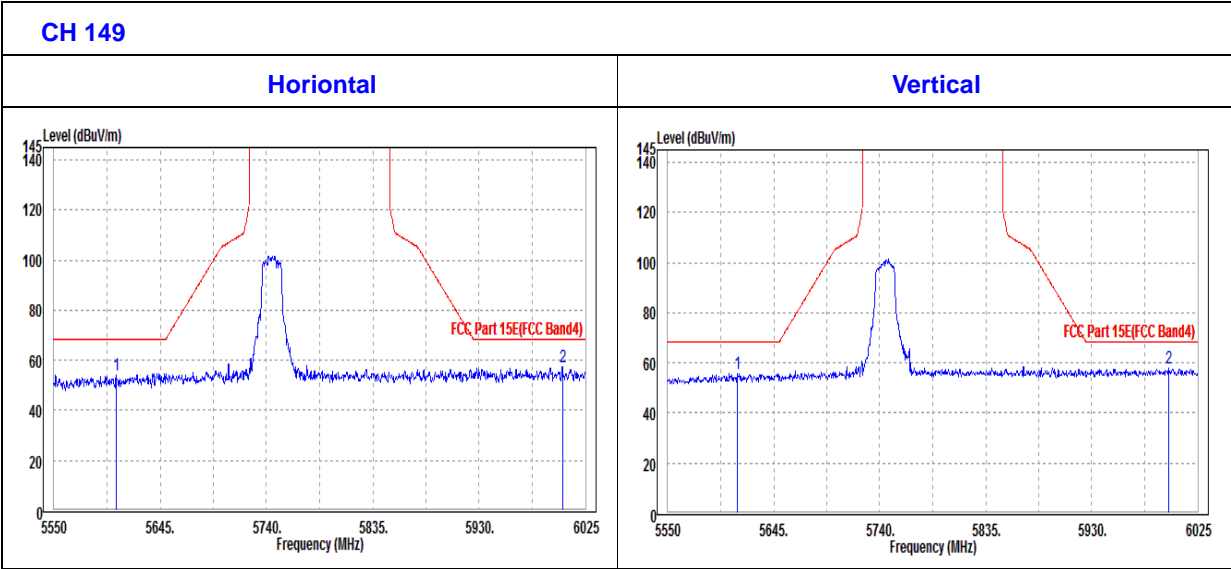



CHANNEL	TX Channel 157	DETECTOR FUNCTION	Peak (PK)
FREQUENCY RANGE	1GHz ~ 40GHz		Average (AV)

ANTENNA POLARITY & TEST DISTANCE: HORIZONTAL AT 3 M										
FREQ. (MHz)	EMISSION LEVEL (dBuV/m)	READ LEVEL (dBuV)	LIMIT (dBuV/m)	MARGIN (dB)	ANTENNA FACTOR (dB /m)	CABLE LOSS (dB)	PREAMP FACTOR (dB)	ANTENNA HEIGHT (cm)	TABLE ANGLE (Degree)	REMARK
5785	95.8	90.27			35.24	16.57	46.28	220	258	Average
5785	105.94	100.41			35.24	16.57	46.28	220	258	Peak
ANTENNA POLARITY & TEST DISTANCE: VERTICAL AT 3 M										
FREQ. (MHz)	EMISSION LEVEL (dBuV/m)	READ LEVEL (dBuV)	LIMIT (dBuV/m)	MARGIN (dB)	ANTENNA FACTOR (dB /m)	CABLE LOSS (dB)	PREAMP FACTOR (dB)	ANTENNA HEIGHT (cm)	TABLE ANGLE (Degree)	REMARK
5785	95.12	89.59			35.24	16.57	46.28	100	225	Average
5785	106.17	100.64			35.24	16.57	46.28	100	225	Peak

REMARKS:

1. Emission Level = Read Level+ Antenna Factor + Cable Loss- Preamp Factor
Margin value = Emission level – Limit value.
2. 5785MHz: Fundamental frequency.



OOBE DATA

802.11a

ANTENNA POLARITY & TEST DISTANCE: HORIZONTAL AT 3 M										
FREQ. (MHz)	EMISSION LEVEL (dBuV/m)	READ LEVEL (dBuV)	LIMIT (dBuV/m)	MARGIN (dB)	ANTENNA FACTOR (dB /m)	CABLE LOSS (dB)	PREAMP FACTOR (dB)	ANTENNA HEIGHT (cm)	TABLE ANGLE (Degree)	REMARK
5605.58	54.23	50.08	68.3	-14.07	35.03	15.4	46.28	220	258	Peak
5976.08	57.83	50.83	68.3	-10.47	35.47	17.81	46.28	220	258	Peak
ANTENNA POLARITY & TEST DISTANCE: VERTICAL AT 3 M										
FREQ. (MHz)	EMISSION LEVEL (dBuV/m)	READ LEVEL (dBuV)	LIMIT (dBuV/m)	MARGIN (dB)	ANTENNA FACTOR (dB /m)	CABLE LOSS (dB)	PREAMP FACTOR (dB)	ANTENNA HEIGHT (cm)	TABLE ANGLE (Degree)	REMARK
5594.18	53.46	49.41	68.3	-14.84	35.01	15.32	46.28	100	225	Peak
5987	57.02	49.93	68.3	-11.28	35.48	17.89	46.28	100	225	Peak

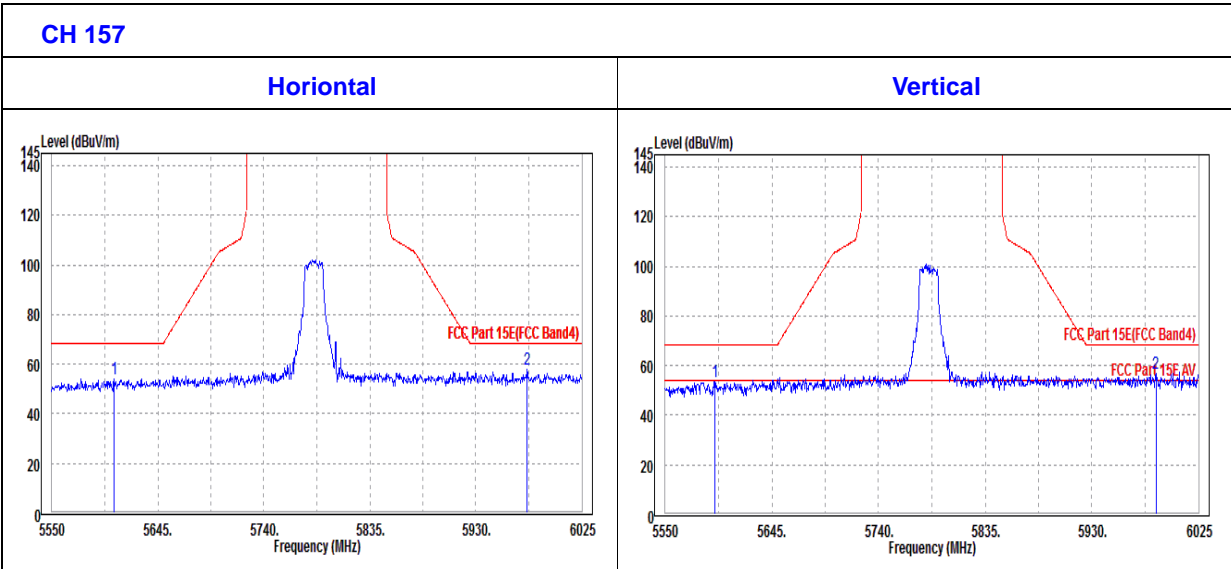



CHANNEL	TX Channel 165	DETECTOR FUNCTION	Peak (PK)
FREQUENCY RANGE	1GHz ~ 40GHz		Average (AV)

ANTENNA POLARITY & TEST DISTANCE: HORIZONTAL AT 3 M										
FREQ. (MHz)	EMISSION LEVEL (dBuV/m)	READ LEVEL (dBuV)	LIMIT (dBuV/m)	MARGIN (dB)	ANTENNA FACTOR (dB /m)	CABLE LOSS (dB)	PREAMP FACTOR (dB)	ANTENNA HEIGHT (cm)	TABLE ANGLE (Degree)	REMARK
5825	97.9	92.06			35.29	16.83	46.28	100	311	Average
5825	106.77	100.93			35.29	16.83	46.28	100	311	Peak

ANTENNA POLARITY & TEST DISTANCE: VERTICAL AT 3 M										
FREQ. (MHz)	EMISSION LEVEL (dBuV/m)	READ LEVEL (dBuV)	LIMIT (dBuV/m)	MARGIN (dB)	ANTENNA FACTOR (dB /m)	CABLE LOSS (dB)	PREAMP FACTOR (dB)	ANTENNA HEIGHT (cm)	TABLE ANGLE (Degree)	REMARK
5825	99.67	93.83			35.29	16.83	46.28	100	211	Average
5825	108.03	102.19			35.29	16.83	46.28	100	211	Peak

REMARKS:

1. Emission Level = Read Level+ Antenna Factor + Cable Loss- Preamp Factor
Margin value = Emission level – Limit value.
2. 5825MHz: Fundamental frequency.



OOBE DATA

802.11a

ANTENNA POLARITY & TEST DISTANCE: HORIZONTAL AT 3 M										
FREQ. (MHz)	EMISSION LEVEL (dBuV/m)	READ LEVEL (dBuV)	LIMIT (dBuV/m)	MARGIN (dB)	ANTENNA FACTOR (dB /m)	CABLE LOSS (dB)	PREAMP FACTOR (dB)	ANTENNA HEIGHT (cm)	TABLE ANGLE (Degree)	REMARK
5577.55	58.15	54.22	68.3	-10.15	34.99	15.22	46.28	100	311	Peak
5991.75	61.56	54.43	68.3	-6.74	35.49	17.92	46.28	100	311	Peak
ANTENNA POLARITY & TEST DISTANCE: VERTICAL AT 3 M										
FREQ. (MHz)	EMISSION LEVEL (dBuV/m)	READ LEVEL (dBuV)	LIMIT (dBuV/m)	MARGIN (dB)	ANTENNA FACTOR (dB /m)	CABLE LOSS (dB)	PREAMP FACTOR (dB)	ANTENNA HEIGHT (cm)	TABLE ANGLE (Degree)	REMARK
5589.9	57.66	53.63	68.3	-10.64	35.01	15.3	46.28	100	211	Peak
5977.5	60.68	53.67	68.3	-7.62	35.47	17.82	46.28	100	211	Peak

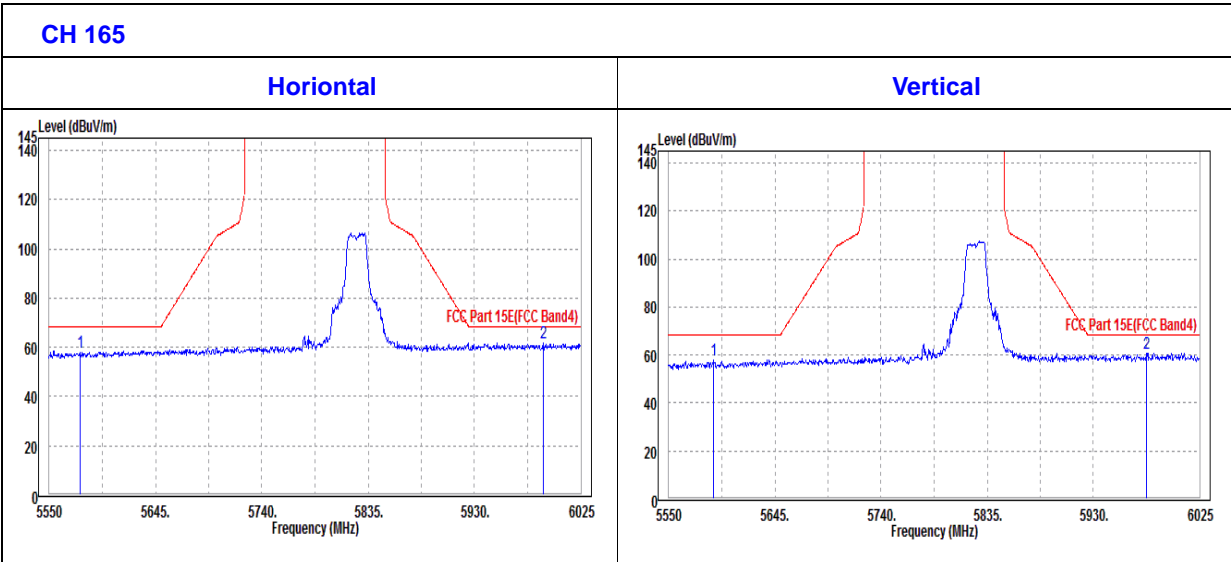



802.11n (20MHz)

CHANNEL	TX Channel 149	DETECTOR FUNCTION	Peak (PK)
FREQUENCY RANGE	1GHz ~ 40GHz		Average (AV)

ANTENNA POLARITY & TEST DISTANCE: HORIZONTAL AT 3 M										
FREQ. (MHz)	EMISSION LEVEL (dBuV/m)	READ LEVEL (dBuV)	LIMIT (dBuV/m)	MARGIN (dB)	ANTENNA FACTOR (dB /m)	CABLE LOSS (dB)	PREAMP FACTOR (dB)	ANTENNA HEIGHT (cm)	TABLE ANGLE (Degree)	REMARK
5745	94.29	89.07			35.19	16.31	46.28	100	255	Average
5745	104.23	99.01			35.19	16.31	46.28	100	255	Peak
ANTENNA POLARITY & TEST DISTANCE: VERTICAL AT 3 M										
FREQ. (MHz)	EMISSION LEVEL (dBuV/m)	READ LEVEL (dBuV)	LIMIT (dBuV/m)	MARGIN (dB)	ANTENNA FACTOR (dB /m)	CABLE LOSS (dB)	PREAMP FACTOR (dB)	ANTENNA HEIGHT (cm)	TABLE ANGLE (Degree)	REMARK
5745	94.61	89.39			35.19	16.31	46.28	100	210	Average
5745	105.71	100.49			35.19	16.31	46.28	100	210	Peak

REMARKS:

1. Emission Level = Read Level+ Antenna Factor + Cable Loss- Preamp Factor
Margin value = Emission level – Limit value.
2. 5745MHz: Fundamental frequency.



OOBE DATA

802.11n (20MHZ)

ANTENNA POLARITY & TEST DISTANCE: HORIZONTAL AT 3 M										
FREQ. (MHz)	EMISSION LEVEL (dBuV/m)	READ LEVEL (dBuV)	LIMIT (dBuV/m)	MARGIN (dB)	ANTENNA FACTOR (dB /m)	CABLE LOSS (dB)	PREAMP FACTOR (dB)	ANTENNA HEIGHT (cm)	TABLE ANGLE (Degree)	REMARK
5623.15	54.25	49.97	68.3	-14.05	35.05	15.51	46.28	100	255	Peak
5983.68	56.01	48.95	68.3	-12.29	35.48	17.86	46.28	100	255	Peak
ANTENNA POLARITY & TEST DISTANCE: VERTICAL AT 3 M										
FREQ. (MHz)	EMISSION LEVEL (dBuV/m)	READ LEVEL (dBuV)	LIMIT (dBuV/m)	MARGIN (dB)	ANTENNA FACTOR (dB /m)	CABLE LOSS (dB)	PREAMP FACTOR (dB)	ANTENNA HEIGHT (cm)	TABLE ANGLE (Degree)	REMARK
5596.08	54.13	50.05	68.3	-14.17	35.02	15.34	46.28	100	210	Peak
5941.88	56.96	50.22	68.3	-11.34	35.43	17.59	46.28	100	210	Peak

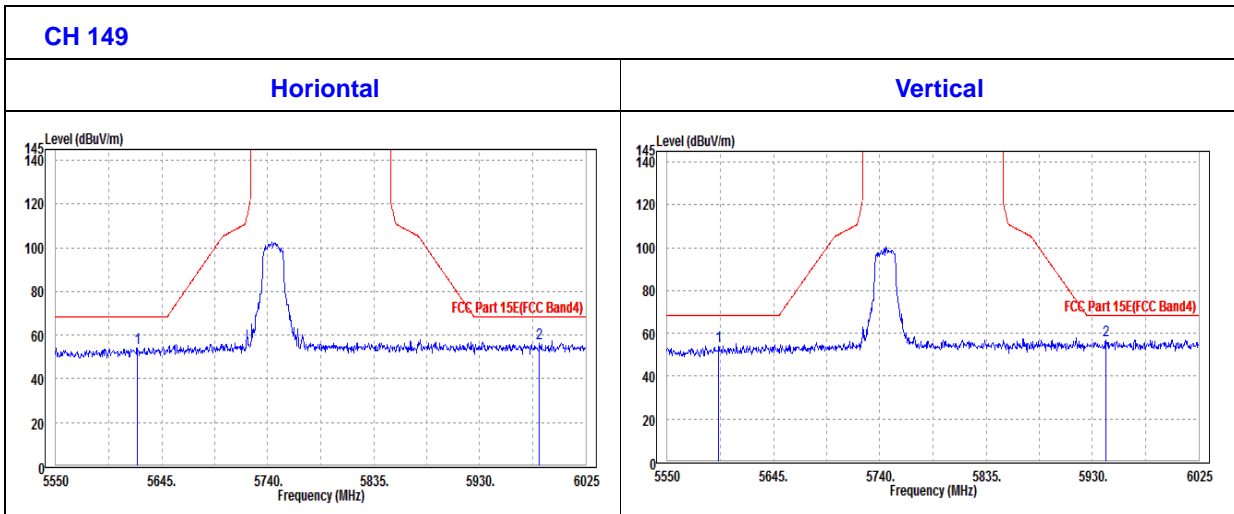



CHANNEL	TX Channel 157	DETECTOR FUNCTION	Peak (PK)
FREQUENCY RANGE	1GHz ~ 40GHz		Average (AV)

ANTENNA POLARITY & TEST DISTANCE: HORIZONTAL AT 3 M										
FREQ. (MHz)	EMISSION LEVEL (dBuV/m)	READ LEVEL (dBuV)	LIMIT (dBuV/m)	MARGIN (dB)	ANTENNA FACTOR (dB /m)	CABLE LOSS (dB)	PREAMP FACTOR (dB)	ANTENNA HEIGHT (cm)	TABLE ANGLE (Degree)	REMARK
5785	93.91	88.38			35.24	16.57	46.28	170	258	Average
5785	105.17	99.64			35.24	16.57	46.28	170	258	Peak

ANTENNA POLARITY & TEST DISTANCE: VERTICAL AT 3 M										
FREQ. (MHz)	EMISSION LEVEL (dBuV/m)	READ LEVEL (dBuV)	LIMIT (dBuV/m)	MARGIN (dB)	ANTENNA FACTOR (dB /m)	CABLE LOSS (dB)	PREAMP FACTOR (dB)	ANTENNA HEIGHT (cm)	TABLE ANGLE (Degree)	REMARK
5785	93.84	88.31			35.24	16.57	46.28	100	225	Average
5785	105.48	99.95			35.24	16.57	46.28	100	225	Peak

REMARKS:

1. Emission Level = Read Level+ Antenna Factor + Cable Loss- Preamp Factor
Margin value = Emission level – Limit value.
2. 5785MHz: Fundamental frequency.



OOBE DATA

802.11n (20MHZ)

ANTENNA POLARITY & TEST DISTANCE: HORIZONTAL AT 3 M										
FREQ. (MHz)	EMISSION LEVEL (dBuV/m)	READ LEVEL (dBuV)	LIMIT (dBuV/m)	MARGIN (dB)	ANTENNA FACTOR (dB /m)	CABLE LOSS (dB)	PREAMP FACTOR (dB)	ANTENNA HEIGHT (cm)	TABLE ANGLE (Degree)	REMARK
5604.63	54.7	50.56	68.3	-13.6	35.03	15.39	46.28	170	258	Peak
5970.38	56.65	49.69	68.3	-11.65	35.46	17.78	46.28	170	258	Peak
ANTENNA POLARITY & TEST DISTANCE: VERTICAL AT 3 M										
FREQ. (MHz)	EMISSION LEVEL (dBuV/m)	READ LEVEL (dBuV)	LIMIT (dBuV/m)	MARGIN (dB)	ANTENNA FACTOR (dB /m)	CABLE LOSS (dB)	PREAMP FACTOR (dB)	ANTENNA HEIGHT (cm)	TABLE ANGLE (Degree)	REMARK
5593.7	53.77	49.72	68.3	-14.53	35.01	15.32	46.28	100	225	Peak
5956.13	56.68	49.83	68.3	-11.62	35.45	17.68	46.28	100	225	Peak

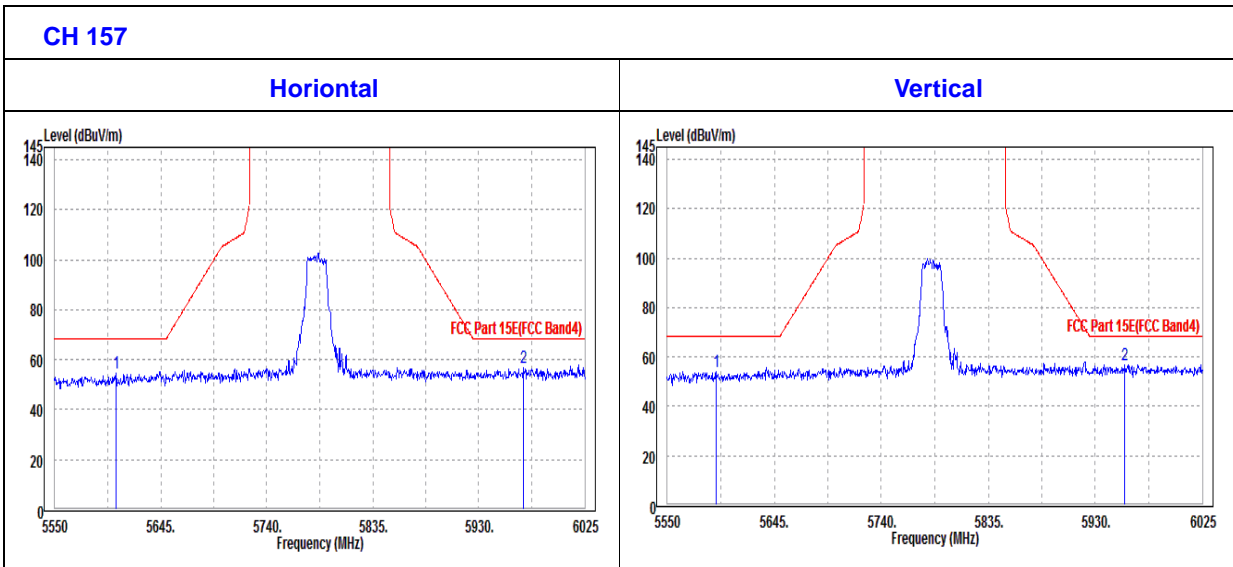



CHANNEL	TX Channel 165	DETECTOR FUNCTION	Peak (PK)
FREQUENCY RANGE	1GHz ~ 40GHz		Average (AV)

ANTENNA POLARITY & TEST DISTANCE: HORIZONTAL AT 3 M										
FREQ. (MHz)	EMISSION LEVEL (dBuV/m)	READ LEVEL (dBuV)	LIMIT (dBuV/m)	MARGIN (dB)	ANTENNA FACTOR (dB /m)	CABLE LOSS (dB)	PREAMP FACTOR (dB)	ANTENNA HEIGHT (cm)	TABLE ANGLE (Degree)	REMARK
5825	100.22	94.38			35.29	16.83	46.28	100	132	Average
5825	108.89	103.05			35.29	16.83	46.28	100	132	Peak
ANTENNA POLARITY & TEST DISTANCE: VERTICAL AT 3 M										
FREQ. (MHz)	EMISSION LEVEL (dBuV/m)	READ LEVEL (dBuV)	LIMIT (dBuV/m)	MARGIN (dB)	ANTENNA FACTOR (dB /m)	CABLE LOSS (dB)	PREAMP FACTOR (dB)	ANTENNA HEIGHT (cm)	TABLE ANGLE (Degree)	REMARK
5825	98.31	92.47			35.29	16.83	46.28	100	80	Average
5825	106.65	100.81			35.29	16.83	46.28	100	80	Peak

REMARKS:

1. Emission Level = Read Level+ Antenna Factor + Cable Loss- Preamp Factor
Margin value = Emission level – Limit value.
2. 5825MHz: Fundamental frequency.



OOBE DATA

802.11n (20MHZ)

ANTENNA POLARITY & TEST DISTANCE: HORIZONTAL AT 3 M										
FREQ. (MHz)	EMISSION LEVEL (dBuV/m)	READ LEVEL (dBuV)	LIMIT (dBuV/m)	MARGIN (dB)	ANTENNA FACTOR (dB /m)	CABLE LOSS (dB)	PREAMP FACTOR (dB)	ANTENNA HEIGHT (cm)	TABLE ANGLE (Degree)	REMARK
5620.3	54.96	50.71	68.3	-13.34	35.04	15.49	46.28	100	132	Peak
6011.7	58.21	51.07	68.3	-10.09	35.5	17.92	46.28	100	132	Peak
ANTENNA POLARITY & TEST DISTANCE: VERTICAL AT 3 M										
FREQ. (MHz)	EMISSION LEVEL (dBuV/m)	READ LEVEL (dBuV)	LIMIT (dBuV/m)	MARGIN (dB)	ANTENNA FACTOR (dB /m)	CABLE LOSS (dB)	PREAMP FACTOR (dB)	ANTENNA HEIGHT (cm)	TABLE ANGLE (Degree)	REMARK
5595.6	55.98	51.92	68.3	-12.32	35.01	15.33	46.28	100	80	Peak
5964.68	59.47	52.55	68.3	-8.83	35.46	17.74	46.28	100	80	Peak

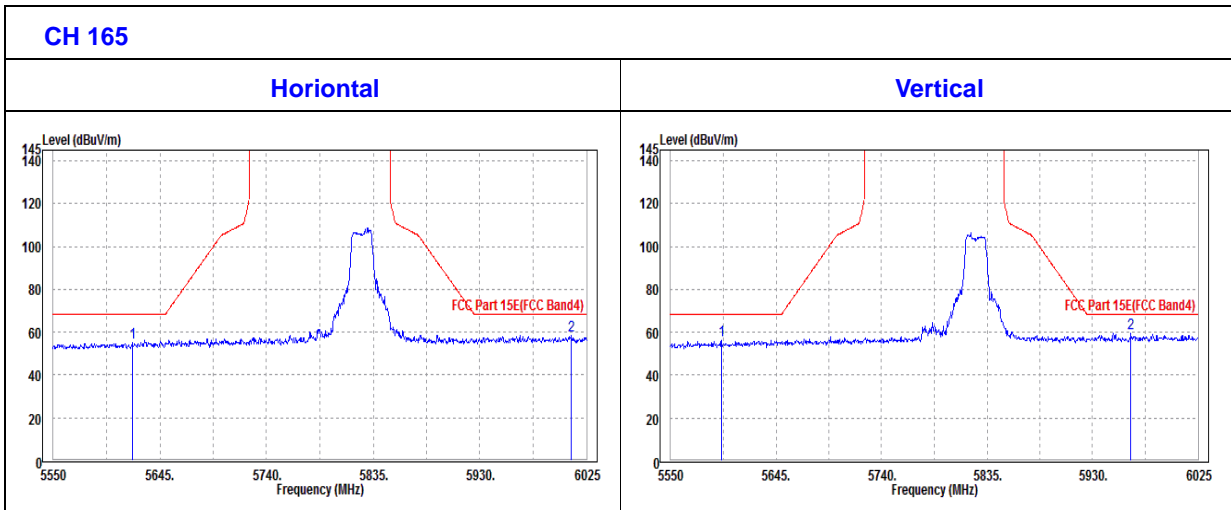



802.11n (40MHz)

CHANNEL	TX Channel 151	DETECTOR FUNCTION	Peak (PK)
FREQUENCY RANGE	1GHz ~ 40GHz		Average (AV)

ANTENNA POLARITY & TEST DISTANCE: HORIZONTAL AT 3 M										
FREQ. (MHz)	EMISSION LEVEL (dBuV/m)	READ LEVEL (dBuV)	LIMIT (dBuV/m)	MARGIN (dB)	ANTENNA FACTOR (dB /m)	CABLE LOSS (dB)	PREAMP FACTOR (dB)	ANTENNA HEIGHT (cm)	TABLE ANGLE (Degree)	REMARK
5755	93.48	88.18			35.21	16.37	46.28	110	252	Average
5755	103.27	97.97			35.21	16.37	46.28	110	252	Peak
ANTENNA POLARITY & TEST DISTANCE: VERTICAL AT 3 M										
FREQ. (MHz)	EMISSION LEVEL (dBuV/m)	READ LEVEL (dBuV)	LIMIT (dBuV/m)	MARGIN (dB)	ANTENNA FACTOR (dB /m)	CABLE LOSS (dB)	PREAMP FACTOR (dB)	ANTENNA HEIGHT (cm)	TABLE ANGLE (Degree)	REMARK
5755	94.74	89.44			35.21	16.37	46.28	100	225	Average
5755	105.33	100.03			35.21	16.37	46.28	100	225	Peak

REMARKS:

1. Emission Level = Read Level+ Antenna Factor + Cable Loss- Preamp Factor
Margin value = Emission level – Limit value.
2. 5755MHz: Fundamental frequency.



OOBE DATA

802.11n (40MHZ)

ANTENNA POLARITY & TEST DISTANCE: HORIZONTAL AT 3 M										
FREQ. (MHz)	EMISSION LEVEL (dBuV/m)	READ LEVEL (dBuV)	LIMIT (dBuV/m)	MARGIN (dB)	ANTENNA FACTOR (dB /m)	CABLE LOSS (dB)	PREAMP FACTOR (dB)	ANTENNA HEIGHT (cm)	TABLE ANGLE (Degree)	REMARK
5607.95	54.35	50.19	68.3	-13.95	35.03	15.41	46.28	110	252	Peak
5971.33	56.31	49.34	68.3	-11.99	35.47	17.78	46.28	110	252	Peak
ANTENNA POLARITY & TEST DISTANCE: VERTICAL AT 3 M										
FREQ. (MHz)	EMISSION LEVEL (dBuV/m)	READ LEVEL (dBuV)	LIMIT (dBuV/m)	MARGIN (dB)	ANTENNA FACTOR (dB /m)	CABLE LOSS (dB)	PREAMP FACTOR (dB)	ANTENNA HEIGHT (cm)	TABLE ANGLE (Degree)	REMARK
5610.33	54.89	50.71	68.3	-13.41	35.03	15.43	46.28	100	225	Peak
5988.43	56.58	49.48	68.3	-11.72	35.49	17.89	46.28	100	225	Peak

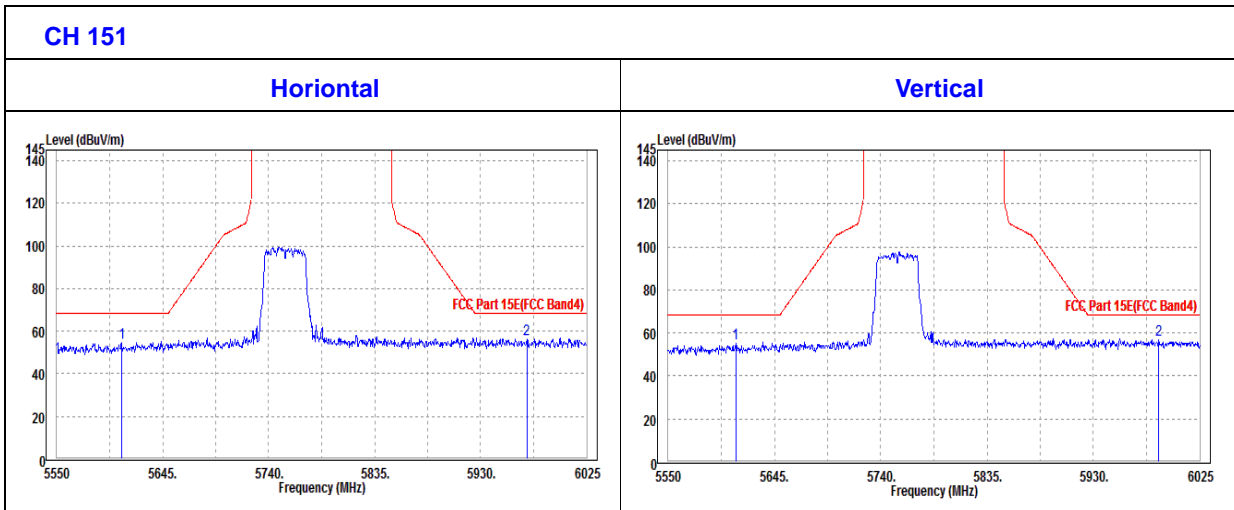



CHANNEL	TX Channel 159	DETECTOR FUNCTION	Peak (PK)
FREQUENCY RANGE	1GHz ~ 40GHz		Average (AV)

ANTENNA POLARITY & TEST DISTANCE: HORIZONTAL AT 3 M										
FREQ. (MHz)	EMISSION LEVEL (dBuV/m)	READ LEVEL (dBuV)	LIMIT (dBuV/m)	MARGIN (dB)	ANTENNA FACTOR (dB /m)	CABLE LOSS (dB)	PREAMP FACTOR (dB)	ANTENNA HEIGHT (cm)	TABLE ANGLE (Degree)	REMARK
5795	93.13	87.53			35.25	16.63	46.28	110	255	Average
5795	104.53	98.93			35.25	16.63	46.28	110	255	Peak
ANTENNA POLARITY & TEST DISTANCE: VERTICAL AT 3 M										
FREQ. (MHz)	EMISSION LEVEL (dBuV/m)	READ LEVEL (dBuV)	LIMIT (dBuV/m)	MARGIN (dB)	ANTENNA FACTOR (dB /m)	CABLE LOSS (dB)	PREAMP FACTOR (dB)	ANTENNA HEIGHT (cm)	TABLE ANGLE (Degree)	REMARK
5795	93.38	87.78			35.25	16.63	46.28	100	215	Average
5795	104.47	98.87			35.25	16.63	46.28	100	215	Peak

REMARKS:

1. Emission Level = Read Level+ Antenna Factor + Cable Loss- Preamp Factor
Margin value = Emission level – Limit value.
2. 5795MHz: Fundamental frequency.



OOBE DATA

802.11n (40MHZ)

ANTENNA POLARITY & TEST DISTANCE: HORIZONTAL AT 3 M										
FREQ. (MHz)	EMISSION LEVEL (dBuV/m)	READ LEVEL (dBuV)	LIMIT (dBuV/m)	MARGIN (dB)	ANTENNA FACTOR (dB /m)	CABLE LOSS (dB)	PREAMP FACTOR (dB)	ANTENNA HEIGHT (cm)	TABLE ANGLE (Degree)	REMARK
5578.5	54.32	50.39	68.3	-13.98	34.99	15.22	46.28	110	255	Peak
5982.25	56.41	49.36	68.3	-11.89	35.48	17.85	46.28	110	255	Peak
ANTENNA POLARITY & TEST DISTANCE: VERTICAL AT 3 M										
FREQ. (MHz)	EMISSION LEVEL (dBuV/m)	READ LEVEL (dBuV)	LIMIT (dBuV/m)	MARGIN (dB)	ANTENNA FACTOR (dB /m)	CABLE LOSS (dB)	PREAMP FACTOR (dB)	ANTENNA HEIGHT (cm)	TABLE ANGLE (Degree)	REMARK
5614.13	53.42	49.21	68.3	-14.88	35.04	15.45	46.28	100	215	Peak
5967.05	57.12	50.18	68.3	-11.18	35.46	17.76	46.28	100	215	Peak

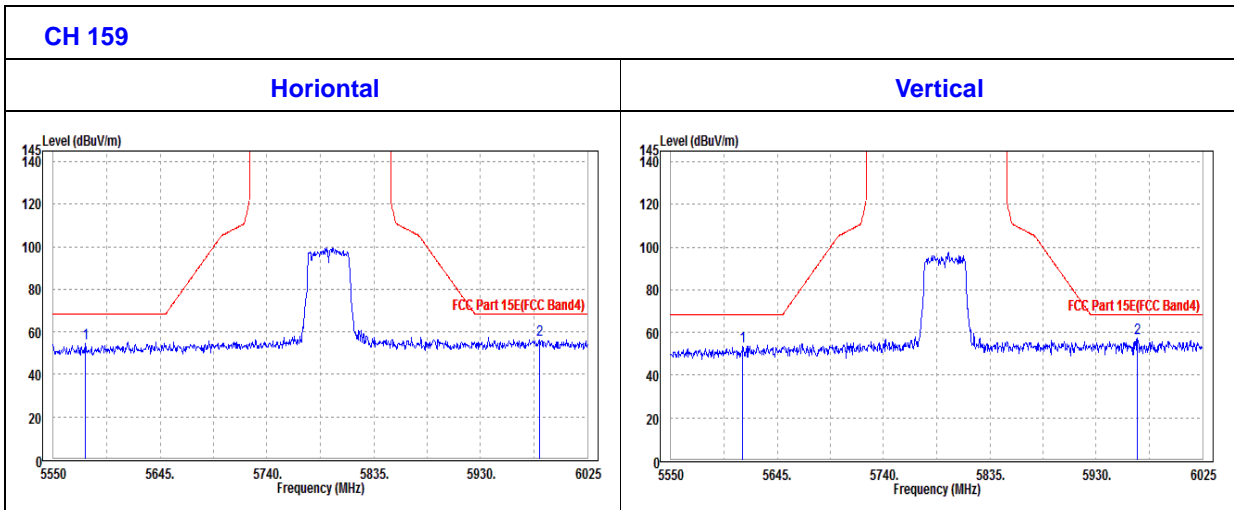



802.11ac (80MHz)

CHANNEL	TX Channel 155	DETECTOR FUNCTION	Peak (PK)
FREQUENCY RANGE	1GHz ~ 40GHz		Average (AV)

ANTENNA POLARITY & TEST DISTANCE: HORIZONTAL AT 3 M										
FREQ. (MHz)	EMISSION LEVEL (dBuV/m)	READ LEVEL (dBuV)	LIMIT (dBuV/m)	MARGIN (dB)	ANTENNA FACTOR (dB /m)	CABLE LOSS (dB)	PREAMP FACTOR (dB)	ANTENNA HEIGHT (cm)	TABLE ANGLE (Degree)	REMARK
5755	94.01	88.71			35.21	16.37	46.28	150	255	Average
5755	104.89	99.59			35.21	16.37	46.28	150	255	Peak
ANTENNA POLARITY & TEST DISTANCE: VERTICAL AT 3 M										
FREQ. (MHz)	EMISSION LEVEL (dBuV/m)	READ LEVEL (dBuV)	LIMIT (dBuV/m)	MARGIN (dB)	ANTENNA FACTOR (dB /m)	CABLE LOSS (dB)	PREAMP FACTOR (dB)	ANTENNA HEIGHT (cm)	TABLE ANGLE (Degree)	REMARK
5775	94.5	89.05			35.23	16.5	46.28	100	215	Average
5775	106.43	100.98			35.23	16.5	46.28	100	215	Peak

REMARKS:

1. Emission Level = Read Level+ Antenna Factor + Cable Loss- Preamp Factor
Margin value = Emission level – Limit value.
2. 5775MHz: Fundamental frequency.



OOBE DATA

802.11ac (80MHZ)

ANTENNA POLARITY & TEST DISTANCE: HORIZONTAL AT 3 M										
FREQ. (MHz)	EMISSION LEVEL (dBuV/m)	READ LEVEL (dBuV)	LIMIT (dBuV/m)	MARGIN (dB)	ANTENNA FACTOR (dB /m)	CABLE LOSS (dB)	PREAMP FACTOR (dB)	ANTENNA HEIGHT (cm)	TABLE ANGLE (Degree)	REMARK
5563.3	54.66	50.84	68.3	-13.64	34.98	15.12	46.28	150	255	Peak
6005.53	57.34	50.17	68.3	-10.96	35.5	17.95	46.28	150	255	Peak
ANTENNA POLARITY & TEST DISTANCE: VERTICAL AT 3 M										
FREQ. (MHz)	EMISSION LEVEL (dBuV/m)	READ LEVEL (dBuV)	LIMIT (dBuV/m)	MARGIN (dB)	ANTENNA FACTOR (dB /m)	CABLE LOSS (dB)	PREAMP FACTOR (dB)	ANTENNA HEIGHT (cm)	TABLE ANGLE (Degree)	REMARK
5614.13	55.26	51.05	68.3	-13.04	35.04	15.45	46.28	100	215	Peak
5966.1	57.42	50.49	68.3	-10.88	35.46	17.75	46.28	100	215	Peak

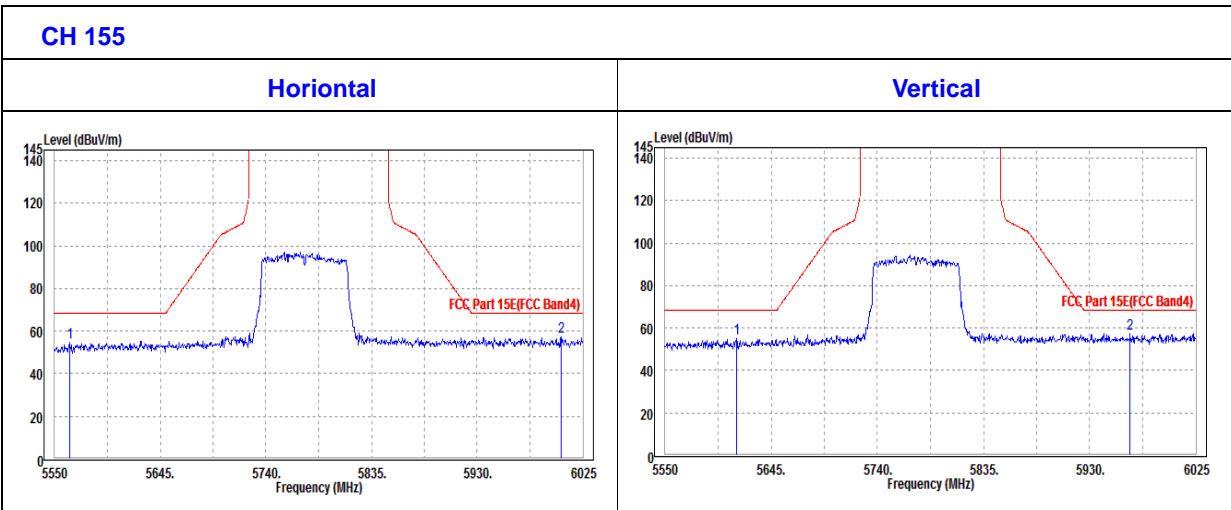



3.2 CONDUCTED EMISSION MEASUREMENT

3.2.1 LIMITS OF CONDUCTED EMISSION MEASUREMENT

FREQUENCY OF EMISSION (MHz)	CONDUCTED LIMIT (dBµV)	
	Quasi-peak	Average
0.15 ~ 0.5	66 to 56	56 to 46
0.5 ~ 5	56	46
5 ~ 30	60	50

- NOTE:**
1. The lower limit shall apply at the transition frequencies.
 2. The limit decreases in line with the logarithm of the frequency in the range of 0.15 to 0.50MHz.
 3. All emanations from a class A/B digital device or system, including any network of conductors and apparatus connected thereto, shall not exceed the level of field strengths specified above.

3.2.2 TEST INSTRUMENTS

Equipment	Manufacturer	Model No.	Serial No.	Last Cal.	Next Cal.
EMI Test Receiver	Rohde&Schwarz	ESR3	101900	Jun. 28,17	Jun. 27,18
EMC32 test software	Rohde&Schwarz	EMC32	NA	NA	NA
LISN network	Rohde&Schwarz	ENV216	101922	Sep. 18,17	Sep. 17,18

- NOTE:**
1. The test was performed in CE shielded room.
 2. The calibration interval of the above test instruments is 12 months. And the calibrations are traceable to CEPREI/CHINA, GRGT/CHINA and NIM/CHINA.

3.2.3 TEST PROCEDURES

- a. The EUT was placed 0.4 meters from the conducting wall of the shielded room with EUT being connected to the power mains through a line impedance stabilization network (LISN). Other support units were connected to the power mains through another LISN. The two LISNs provide 50 ohm/ 50uH of coupling impedance for the measuring instrument.
- b. Both lines of the power mains connected to the EUT were checked for maximum conducted interference.
- c. The frequency range from 150kHz to 30MHz was searched. Emission levels under (Limit - 20dB) was not recorded.

NOTE: All modes of operation were investigated and the worst-case emissions are reported.



3.2.4 DEVIATION FROM TEST STANDARD

No deviation.

3.2.5 TEST SETUP

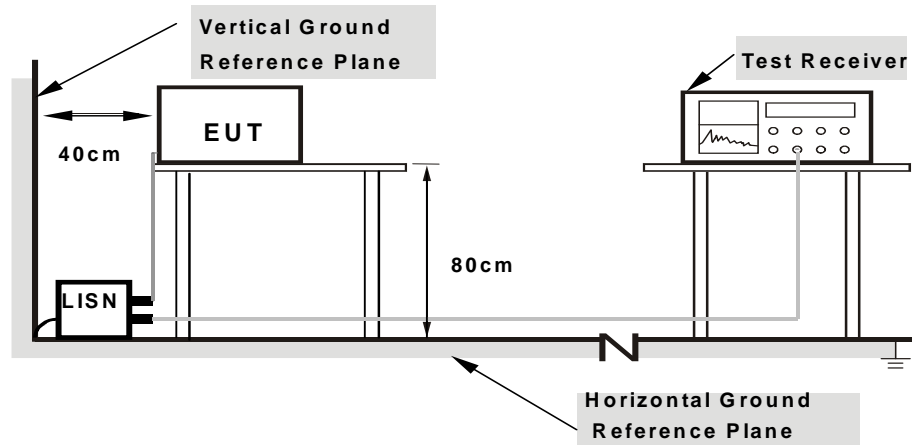

- Note: 1.Support units were connected to second LISN.
2.Both of LISNs (AMN) are 80 cm from EUT and at least 80
from other units and other metal planes**

For the actual test configuration, please refer to the attached file (Test Setup Photo).

3.2.6 EUT OPERATING CONDITIONS

Same as 3.1.6.



3.2.7 TEST RESULTS

CONDUCTED WORST-CASE DATA :

Frequency Range	150KHz ~ 30MHz	Detector Function & Resolution Bandwidth	Quasi-Peak (QP) / Average (AV), 9 kHz
Input Power	120Vac, 60Hz	Environmental Conditions	24deg. C, 55RH
Tested By	Alex Chen	TEST DATE	2018/03/08

Frequency (MHz)	QuasiPeak (dB μ V)	CAverage (dB μ V)	Limit (dB μ V)	Margin (dB)	Line	Filter	Corr. (dB)
0.150000	---	24.09	56.00	-31.91	L	ON	9.6
0.150000	40.77	---	66.00	-25.23	L	ON	9.6
0.740000	---	26.33	46.00	-19.67	L	ON	9.7
0.740000	35.71	---	56.00	-20.29	L	ON	9.7
1.748000	---	19.32	46.00	-26.68	L	ON	9.7
1.748000	27.59	---	56.00	-28.41	L	ON	9.7
3.556000	---	17.37	46.00	-28.63	L	ON	9.7
3.556000	26.65	---	56.00	-29.35	L	ON	9.7
4.060000	---	21.41	46.00	-24.59	L	ON	9.7
4.060000	30.10	---	56.00	-25.90	L	ON	9.7
13.316000	---	20.89	50.00	-29.11	L	ON	9.9
13.316000	33.46	---	60.00	-26.54	L	ON	9.9

- REMARKS:**
1. Q.P. and AV. are abbreviations of quasi-peak and average individually.
 2. "-": The Quasi-peak reading value also meets average limit and measurement with the average detector is unnecessary.
 3. The emission levels of other frequencies were very low against the limit.
 4. Margin value = Emission level - Limit value
 5. Correction factor = Insertion loss + Cable loss
 6. Emission Level = Correction Factor + Reading Value.

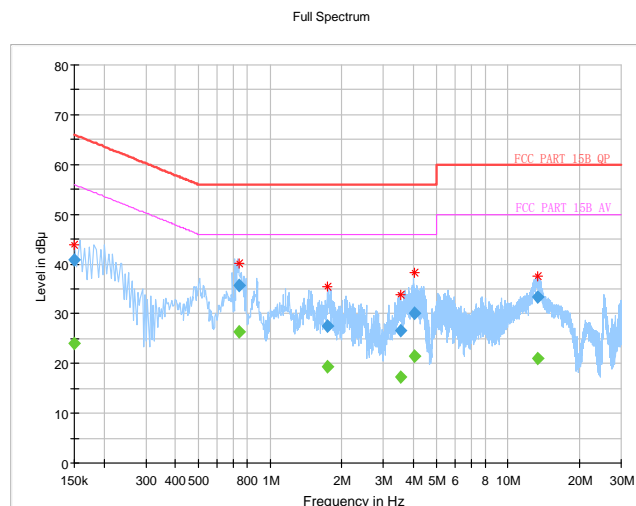



Frequency Range	150KHz ~ 30MHz	Detector Function & Resolution Bandwidth	Quasi-Peak (QP) / Average (AV), 9 kHz
Input Power	120Vac, 60Hz	Environmental Conditions	24deg. C, 55RH
Tested By	Alex Chen	TEST DATE	2018/03/08

Frequency (MHz)	QuasiPeak (dB μ V)	CAverage (dB μ V)	Limit (dB μ V)	Margin (dB)	Line	Filter	Corr. (dB)
0.150000	---	23.41	56.00	-32.59	N	ON	9.8
0.150000	40.20	---	66.00	-25.80	N	ON	9.8
0.736000	---	27.17	46.00	-18.83	N	ON	10.0
0.736000	36.50	---	56.00	-19.50	N	ON	10.0
1.464000	---	20.38	46.00	-25.62	N	ON	9.9
1.464000	28.78	---	56.00	-27.22	N	ON	9.9
3.632000	---	18.58	46.00	-27.42	N	ON	9.8
3.632000	27.50	---	56.00	-28.50	N	ON	9.8
4.232000	---	19.82	46.00	-26.18	N	ON	9.8
4.232000	29.53	---	56.00	-26.47	N	ON	9.8
13.242000	---	20.89	50.00	-29.11	N	ON	9.9
13.242000	33.40	---	60.00	-26.60	N	ON	9.9

- REMARKS:**
1. Q.P. and AV. are abbreviations of quasi-peak and average individually.
 2. "-": The Quasi-peak reading value also meets average limit and measurement with the average detector is unnecessary.
 3. The emission levels of other frequencies were very low against the limit.
 4. Margin value = Emission level - Limit value
 5. Correction factor = Insertion loss + Cable loss
 6. Emission Level = Correction Factor + Reading Value.

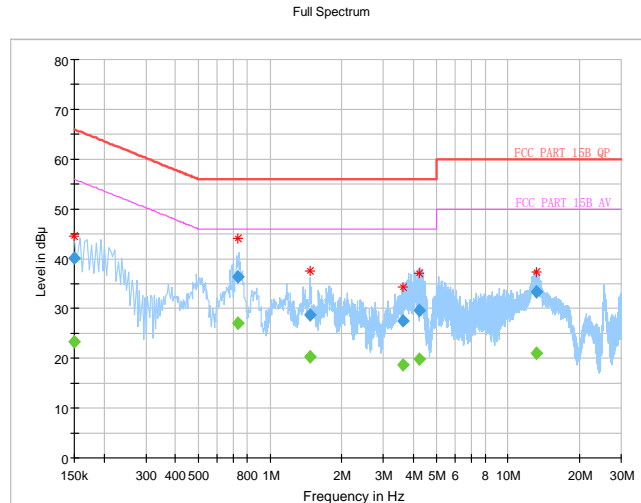



3.3 MAXIMUM CONDUCTED OUTPUT POWER MEASUREMENT

3.3.1 LIMITS OF MAXIMUM CONDUCTED OUTPUT POWER MEASUREMENT

Operation Band	EUT Category		LIMIT
U-NII-1		Outdoor Access Point	1 Watt (30 dBm) (Max. e.i.r.p \leq 125mW(21 dBm) at any elevation angle above 30 degrees as measured from the horizon)
		Fixed point-to-point Access Point	1 Watt (30 dBm)
		Indoor Access Point	1 Watt (30 dBm)
	√	Client devices	250mW (24 dBm)
U-NII-2A	√		250mW (24 dBm) or 11 dBm+10 log B*
U-NII-2C	√		250mW (24 dBm) or 11 dBm+10 log B*
U-NII-3	√		1 Watt (30 dBm)

NOTE: Where B is the 26dB emission bandwidth in MHz.



3.3.2 TEST SETUP

FOR POWER OUTPUT MEASUREMENT

802.11a, 802.11n (20MHz), 802.11n (40MHz) TEST CONFIGURATION

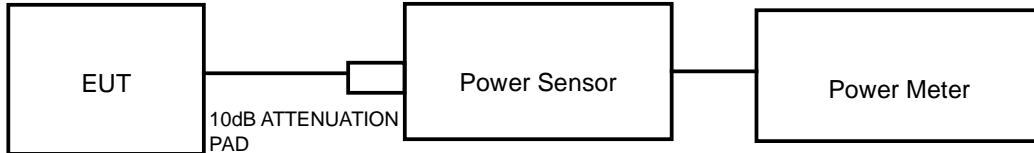

11ac TEST CONFIGURATION

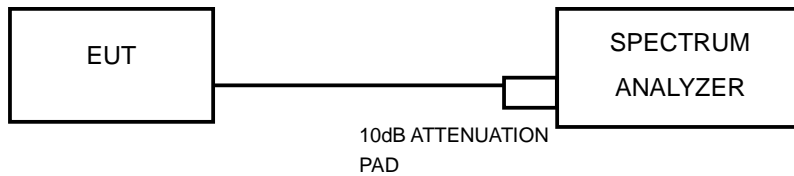

FOR 26dB BANDWIDTH

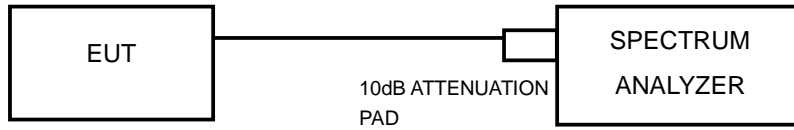

3.3.3 TEST INSTRUMENTS

Equipment	Manufacturer	Model No.	Serial No.	Last Cal.	Next Cal.
Power Meter	ANRITSU	ML2495A	1506002	Mar. 02,18	Mar. 01,19
EXA Signal Analyzer	KEYSIGHT	N9010A-526	MY54510322	May 01,18	Feb. 28,19
EXA Signal Analyzer	KEYSIGHT	N9010A-544	MY54510355	May 01,18	Feb. 28,19
Power Sensor	ANRITSU	MA2411B	1339352	May 01,18	Feb. 28,19

NOTE:

1. The calibration interval of the above test instruments is 12 months and the calibrations are traceable to CEPREI/CHINA, GRGT/CHINA and NIM/CHINA.
2. The test was performed in RF Oven room.



3.3.4 TEST PROCEDURE

FOR POWER MEASUREMENT

For 802.11a, 802.11n (20MHz), 802.11n (40MHz)

Method PM is used to perform output power measurement, trigger and gating function of wide band power meter is enabled to measure max output power of TX on burst. Duty factor is not added to measured value.

For 802.11ac (80MHz)

1. Measure the duty cycle, x , of the transmitter output signal as described in II.B.
2. Set span to encompass the EBW (or, alternatively, the entire 99% occupied bandwidth) of the signal.
3. Set RBW = 1 MHz.
4. Set VBW \geq 3 MHz.
5. Number of points in sweep $\geq 2 \times \text{span} / \text{RBW}$. (This ensures that bin-to-bin spacing is $\leq \text{RBW}/2$, so that narrowband signals are not lost between frequency bins.)
6. Sweep time = auto.
7. Detector = power averaging (rms), if available. Otherwise, use sample detector mode.
8. Do not use sweep triggering. Allow the sweep to “free run.”
9. Trace average at least 100 traces in power averaging (rms) mode; however, the number of traces to be averaged shall be increased above 100 as needed to ensure that the average accurately represents the true average over the on and off periods of the transmitter.
10. Add $10 \log (1/x)$, where x is the duty cycle, to the measured power to compute the average power during the actual transmission times (because the measurement represents an average over both the on and off times of the transmission). For example, add $10 \log (1/0.25) = 6 \text{ dB}$ if the duty cycle is 25%.



FOR 99 PERCENT OCCUPIED BANDWIDTH

The following procedure shall be used for measuring (99 %) power bandwidth:

1. Set center frequency to the nominal EUT channel center frequency.
2. Set span = 1.5 times to 5.0 times the OBW.
3. Set RBW = 1 % to 5 % of the OBW
4. Set VBW $\geq 3 \cdot$ RBW
5. Video averaging is not permitted. Where practical, a sample detection and single sweep mode shall be used. Otherwise, peak detection and max hold mode (until the trace stabilizes) shall be used.
6. Use the 99 % power bandwidth function of the instrument (if available).
7. If the instrument does not have a 99 % power bandwidth function, the trace data points are recovered and directly summed in power units. The recovered amplitude data points, beginning at the lowest frequency, are placed in a running sum until 0.5 % of the total is reached; that frequency is recorded as the lower frequency. The process is repeated until 99.5 % of the total is reached; that frequency is recorded as the upper frequency. The 99% occupied bandwidth is the difference between these two frequencies.

FOR 26dB BANDWIDTH

- 1) Set RBW = approximately 1% of the emission bandwidth.
- 2) Set the VBW > RBW.
- 3) Detector = Peak.
- 4) Trace mode = max hold.
- 5) Measure the maximum width of the emission that is 26 dB down from the peak of the emission. Compare this with the RBW setting of the analyzer. Readjust RBW and repeat measurement as needed until the RBW/EBW ratio is approximately 1%.

FOR 6dB BANDWIDTH

1. Set RBW = 100 kHz.
2. Set the video bandwidth (VBW) ≥ 3 RBW.
3. Detector = Peak.
4. Trace mode = max hold.
5. Sweep = auto couple.
6. Allow the trace to stabilize.
7. Measure the maximum width of the emission that is constrained by the frequencies associated with the two outermost amplitude points (upper and lower frequencies) that are attenuated by 6 dB relative to the maximum level measured in the fundamental emission.



3.3.5 DEVIATION FROM TEST STANDARD

No deviation.

3.3.6 EUT OPERATING CONDITIONS

The software provided by client to enable the EUT under transmission condition continuously at specific channel frequencies individually.



3.3.7 TEST RESULTS

OUTPUT POWER:

802.11a

CHANNEL	CHANNEL FREQUENCY (MHz)	AVERAGE POWER (dBm)	AVERAGE POWER (mW)	POWER LIMIT (dBm)	PASS/FAIL
36	5180	14.48	28.054	24	PASS
40	5200	14.36	27.290	24	PASS
48	5240	14.46	27.925	24	PASS
52	5260	14.80	30.200	24	PASS
60	5300	14.52	28.314	24	PASS
64	5320	14.73	29.717	24	PASS
100	5500	14.76	29.923	24	PASS
116	5580	14.34	27.164	24	PASS
140	5700	14.26	26.669	24	PASS
149	5745	13.42	21.979	30	PASS
157	5785	13.49	22.336	30	PASS
165	5825	13.44	22.080	30	PASS

802.11n (20MHz)

CHANNEL	CHANNEL FREQUENCY (MHz)	AVERAGE POWER (dBm)	AVERAGE POWER (mW)	POWER LIMIT (dBm)	PASS/FAIL
36	5180	11.29	13.459	24	PASS
40	5200	11.62	14.521	24	PASS
48	5240	11.35	13.646	24	PASS
52	5260	11.58	14.388	24	PASS
60	5300	11.54	14.256	24	PASS
64	5320	11.63	14.555	24	PASS
100	5500	11.57	14.355	24	PASS
116	5580	11.46	13.996	24	PASS
140	5700	11.39	13.772	24	PASS
149	5745	11.45	13.964	30	PASS
157	5785	11.39	13.772	30	PASS
165	5825	11.47	14.028	30	PASS



802.11n (40MHz)

CHANNEL	CHANNEL FREQUENCY (MHz)	AVERAGE POWER (dBm)	AVERAGE POWER (mW)	POWER LIMIT (dBm)	PASS/FAIL
38	5190	11.59	14.421	24	PASS
46	5230	11.52	14.191	24	PASS
54	5270	11.63	14.555	24	PASS
62	5310	11.57	14.355	24	PASS
102	5510	11.42	13.868	24	PASS
110	5550	11.39	13.772	24	PASS
134	5670	11.24	13.305	24	PASS
151	5755	11.70	14.791	30	PASS
165	5825	11.56	14.322	30	PASS

802.11ac (80MHz)

CHANNEL	CHANNEL FREQUENCY (MHz)	AVERAGE POWER w/o Duty Factor (dBm)	Duty Factor	AVERAGE POWER with Duty Factor (dBm)	AVERAGE POWER (mW)	POWER LIMIT (dBm)	PASS/FAIL
42	5210	8.55	2.67	11.22	13.243	24	PASS
58	5290	8.69	2.67	11.36	13.677	24	PASS
106	5530	8.61	2.67	11.28	13.428	24	PASS
155	5775	8.40	2.67	11.07	12.794	30	PASS



99% OCCUPIED BANDWIDTH & 26dB BANDWIDTH/6dB BANDWIDTH:

802.11a

CHANNEL	CHANNEL FREQUENCY (MHz)	99% OCCUPIED BANDWIDTH	26dB BANDWIDTH (MHz)	PASS/FAIL
36	5180	16.86	22.09	PASS
40	5200	16.98	21.61	PASS
48	5240	16.98	21.72	PASS
52	5260	16.86	21.65	PASS
60	5300	17.04	22.20	PASS
64	5320	16.98	22.01	PASS
100	5500	16.86	22.37	PASS
116	5580	16.80	22.23	PASS
140	5700	16.86	21.85	PASS
CHANNEL	CHANNEL FREQUENCY (MHz)	99% OCCUPIED BANDWIDTH	6dB BANDWIDTH (MHz)	PASS/FAIL
149	5745	16.98	16.33	PASS
157	5785	17.04	16.35	PASS
165	5825	16.92	16.35	PASS



802.11n (20MHz)

CHANNEL	CHANNEL FREQUENCY (MHz)	99% OCCUPIED BANDWIDTH	26dB BANDWIDTH (MHz)	PASS/FAIL
36	5180	18.00	22.33	PASS
40	5200	17.88	22.23	PASS
48	5240	17.94	22.45	PASS
52	5260	18.00	22.37	PASS
60	5300	18.00	22.30	PASS
64	5320	18.06	22.25	PASS
100	5500	17.94	21.85	PASS
116	5580	18.00	22.13	PASS
140	5700	18.00	22.00	PASS
CHANNEL	CHANNEL FREQUENCY (MHz)	99% OCCUPIED BANDWIDTH	6dB BANDWIDTH (MHz)	PASS/FAIL
149	5745	18.00	17.58	PASS
157	5785	18.00	17.58	PASS
165	5825	18.00	17.57	PASS



802.11n (40MHz)

CHANNEL	CHANNEL FREQUENCY (MHz)	99% OCCUPIED BANDWIDTH	26dB BANDWIDTH (MHz)	PASS/FAIL
38	5190	36.24	44.64	PASS
46	5230	36.36	45.52	PASS
54	5270	36.30	45.26	PASS
62	5310	36.30	44.12	PASS
102	5510	36.30	45.07	PASS
110	5550	36.60	44.88	PASS
134	5670	36.30	45.05	PASS
CHANNEL	CHANNEL FREQUENCY (MHz)	99% OCCUPIED BANDWIDTH	6dB BANDWIDTH (MHz)	PASS/FAIL
151	5755	36.36	35.12	PASS
159	5795	36.30	35.15	PASS

802.11ac (80MHz)

CHANNEL	CHANNEL FREQUENCY (MHz)	99% OCCUPIED BANDWIDTH	26dB BANDWIDTH (MHz)	PASS/FAIL
42	5210	74.64	83.55	PASS
58	5290	74.76	84.05	PASS
106	5530	74.76	83.87	PASS
CHANNEL	CHANNEL FREQUENCY (MHz)	99% OCCUPIED BANDWIDTH	6dB BANDWIDTH (MHz)	PASS/FAIL
155	5775	74.64	72.67	PASS



BUREAU VERITAS

Test Report No.: RF171211W008-3

For U-NII-1:

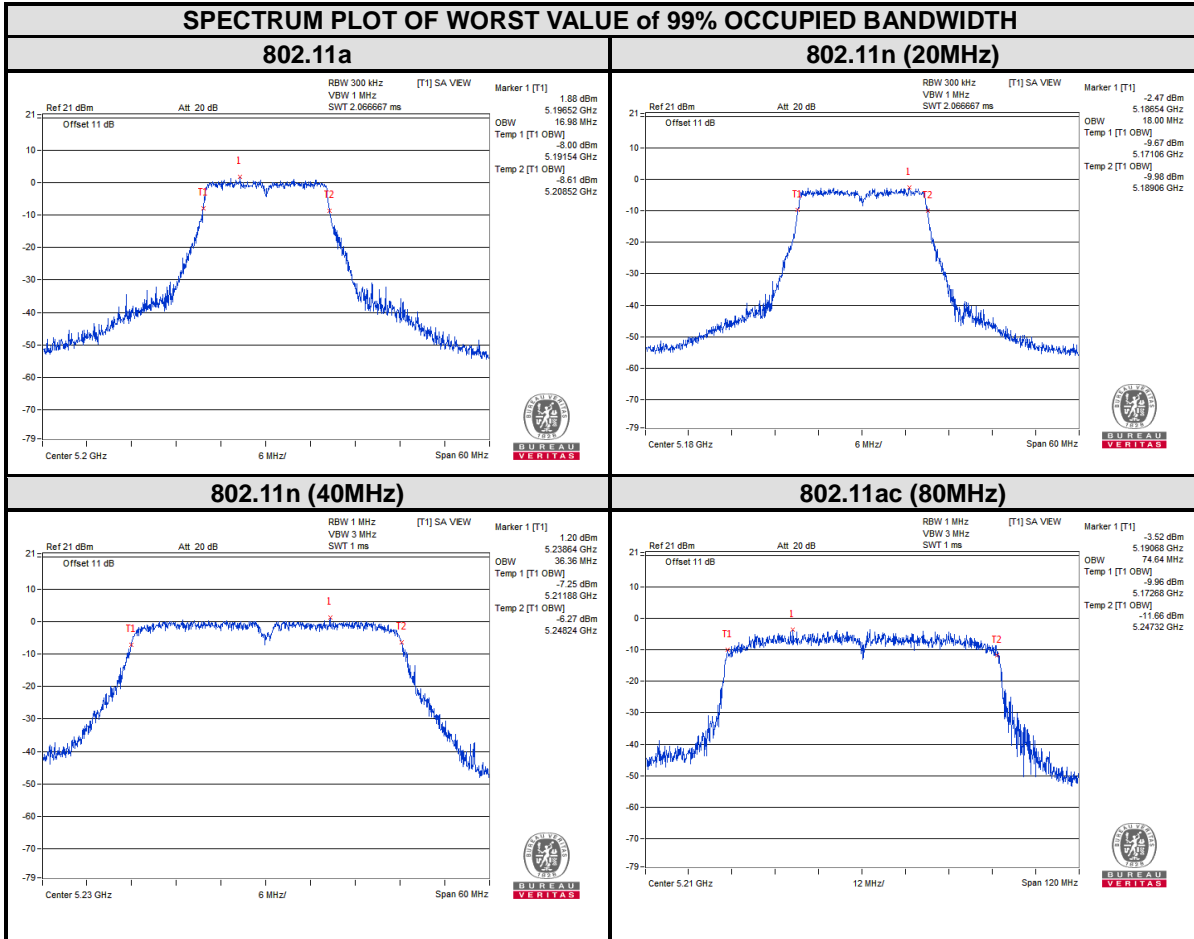



BUREAU
VERITAS

Test Report No.: RF171211W008-3

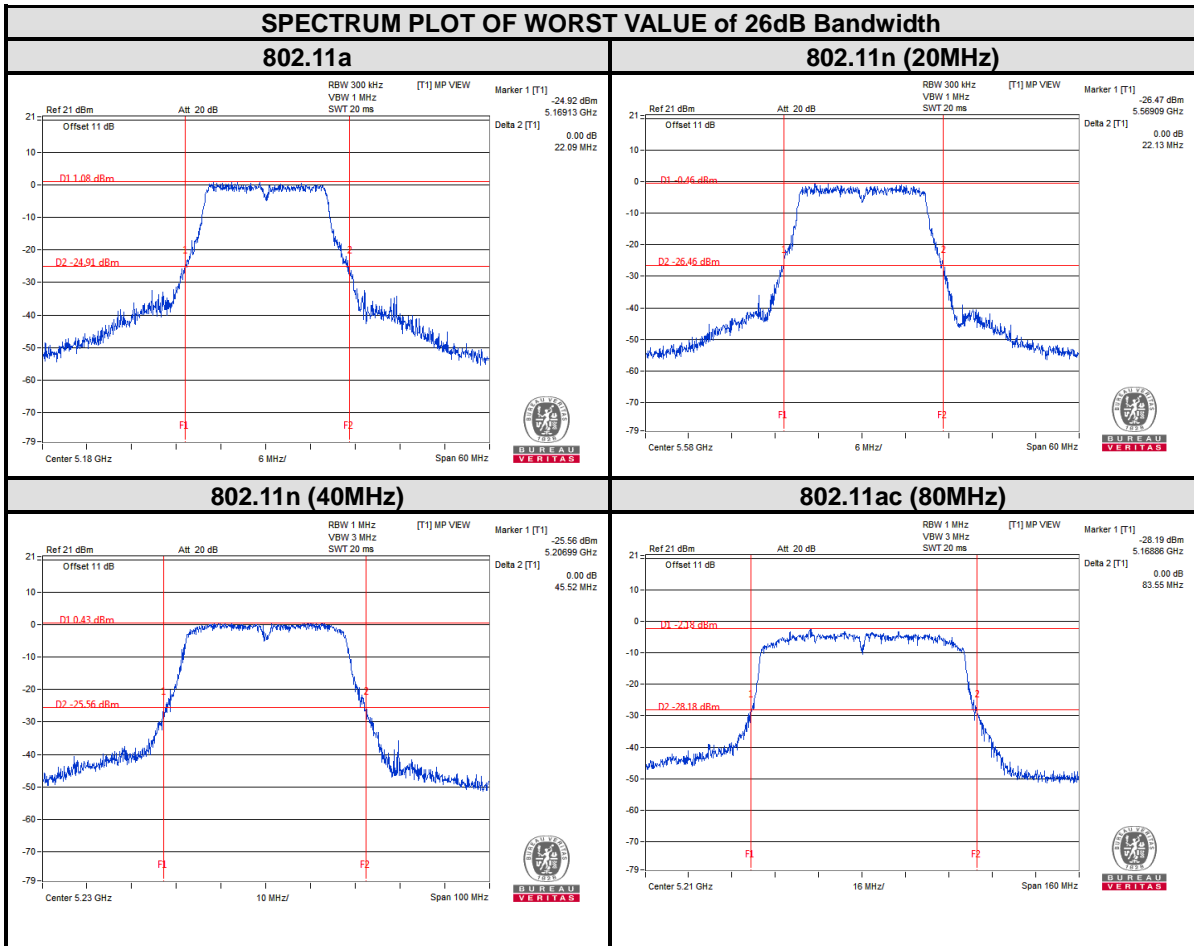



**BUREAU
VERITAS**

Test Report No.: RF171211W008-3

For U-NII-2A:

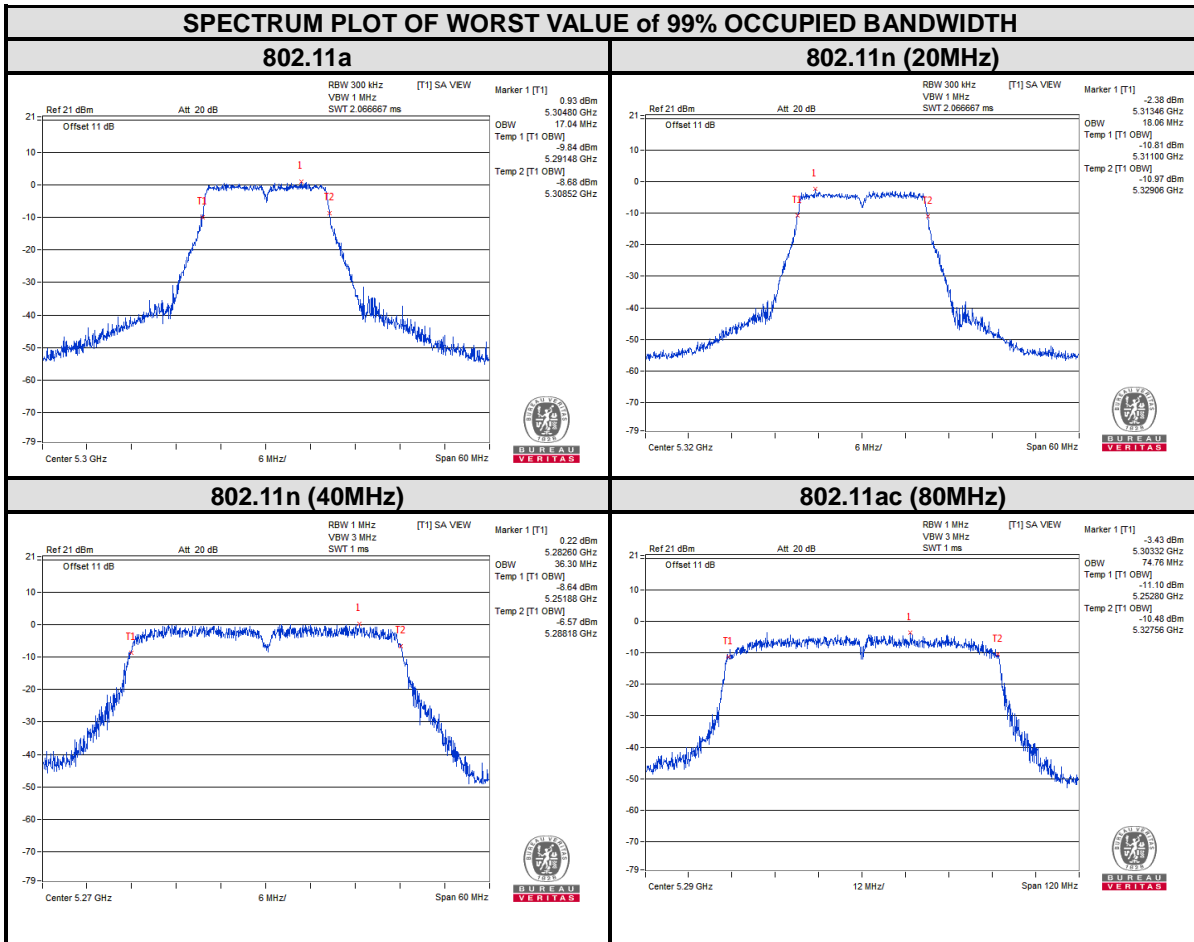



BUREAU VERITAS

Test Report No.: RF171211W008-3

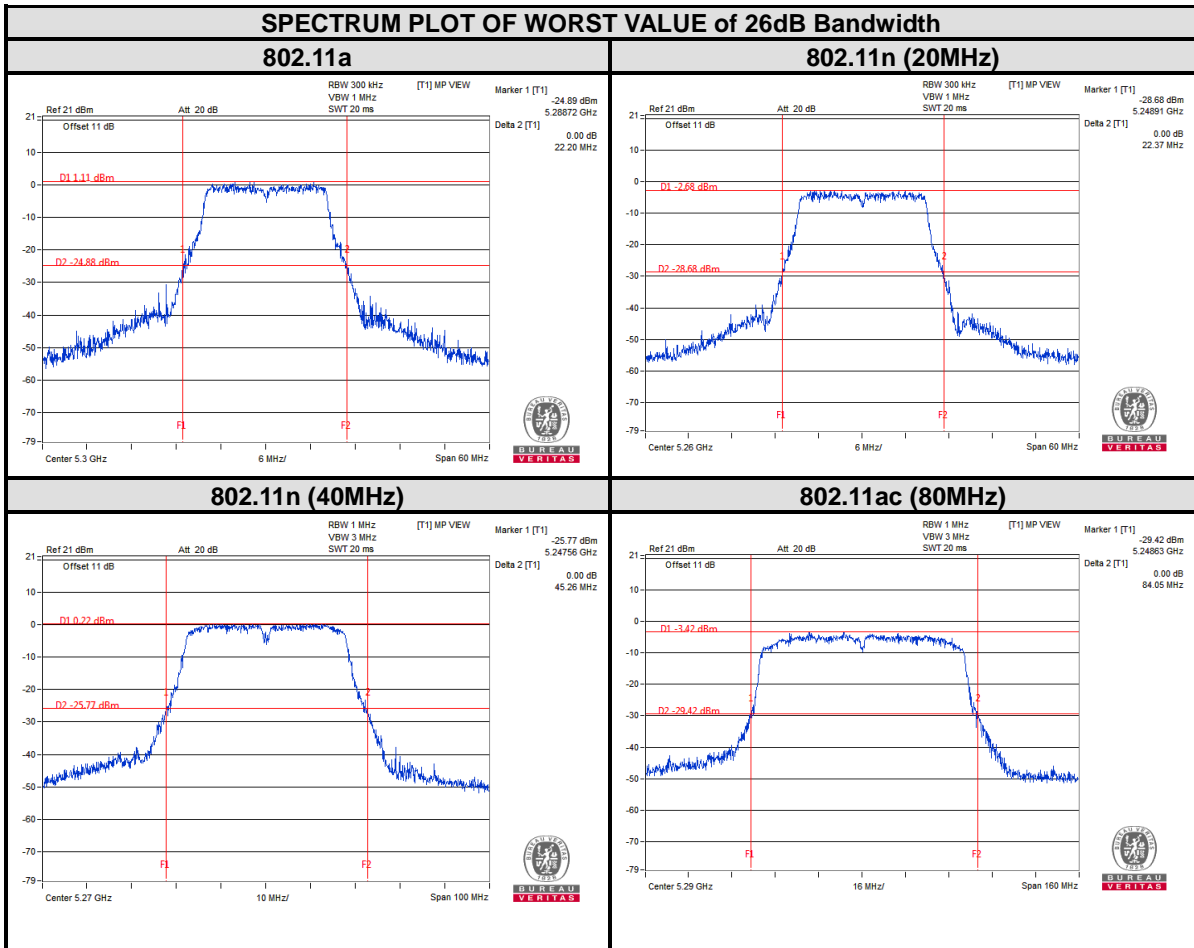



BUREAU VERITAS

Test Report No.: RF171211W008-3

For U-NII-2C:

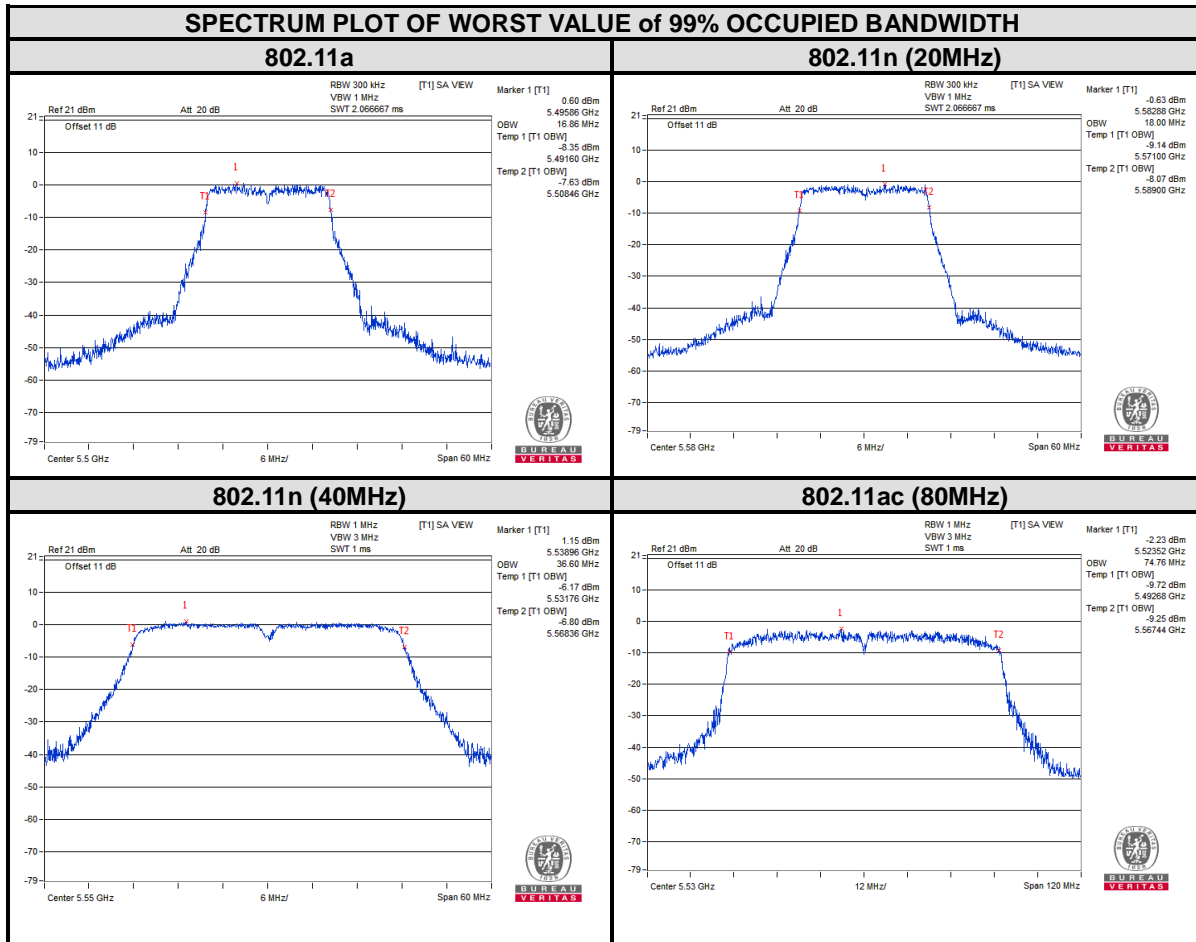



BUREAU VERITAS

Test Report No.: RF171211W008-3

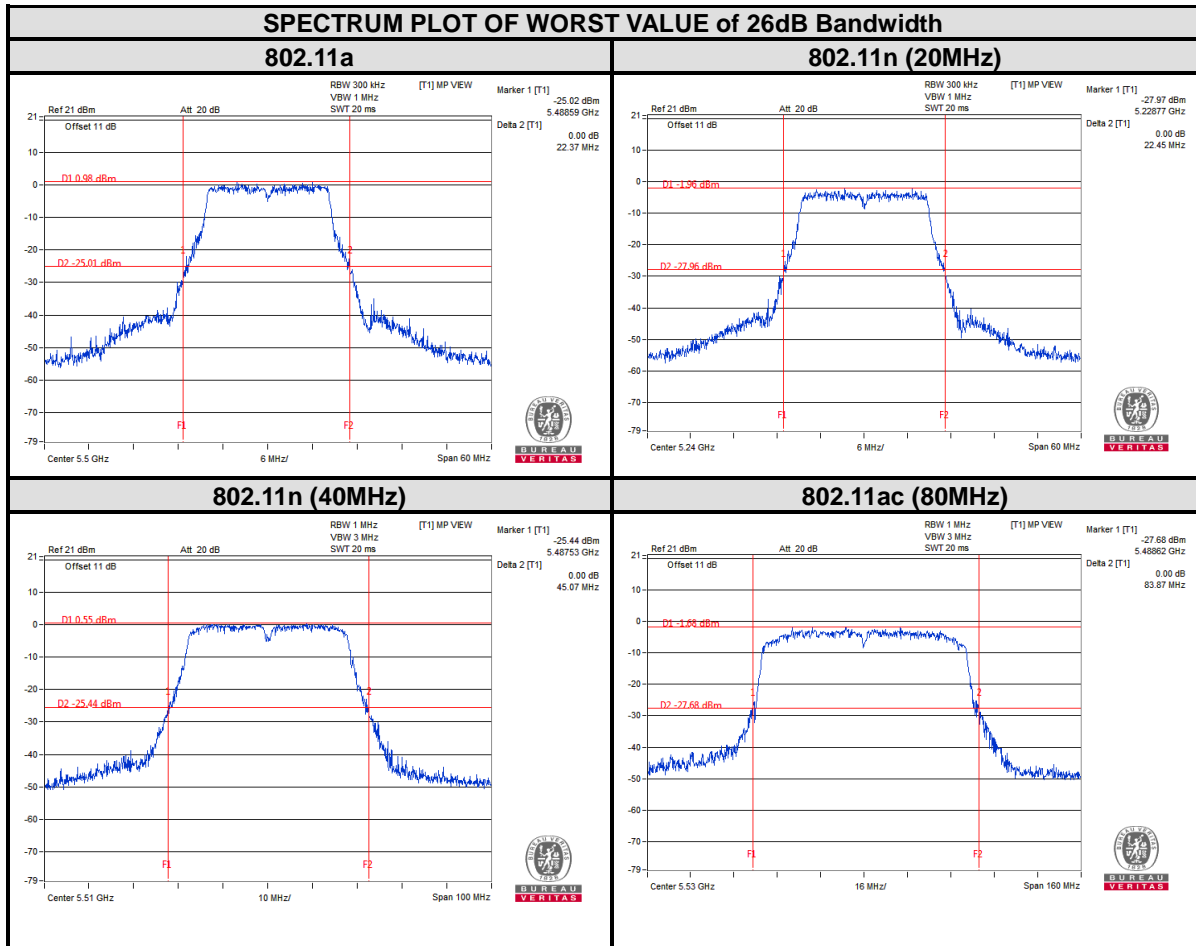



BUREAU VERITAS

Test Report No.: RF171211W008-3

For U-NII-3:

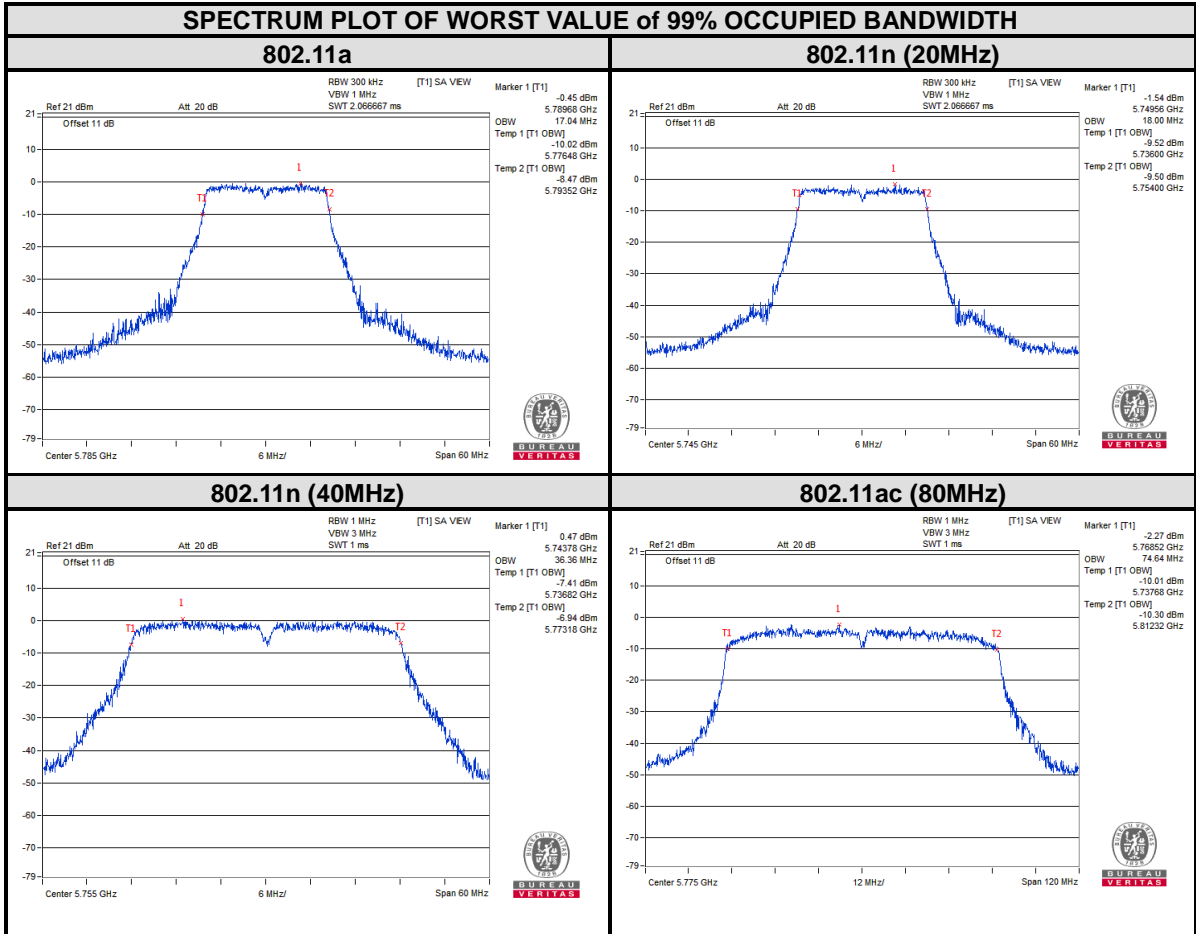



BUREAU VERITAS

Test Report No.: RF171211W008-3

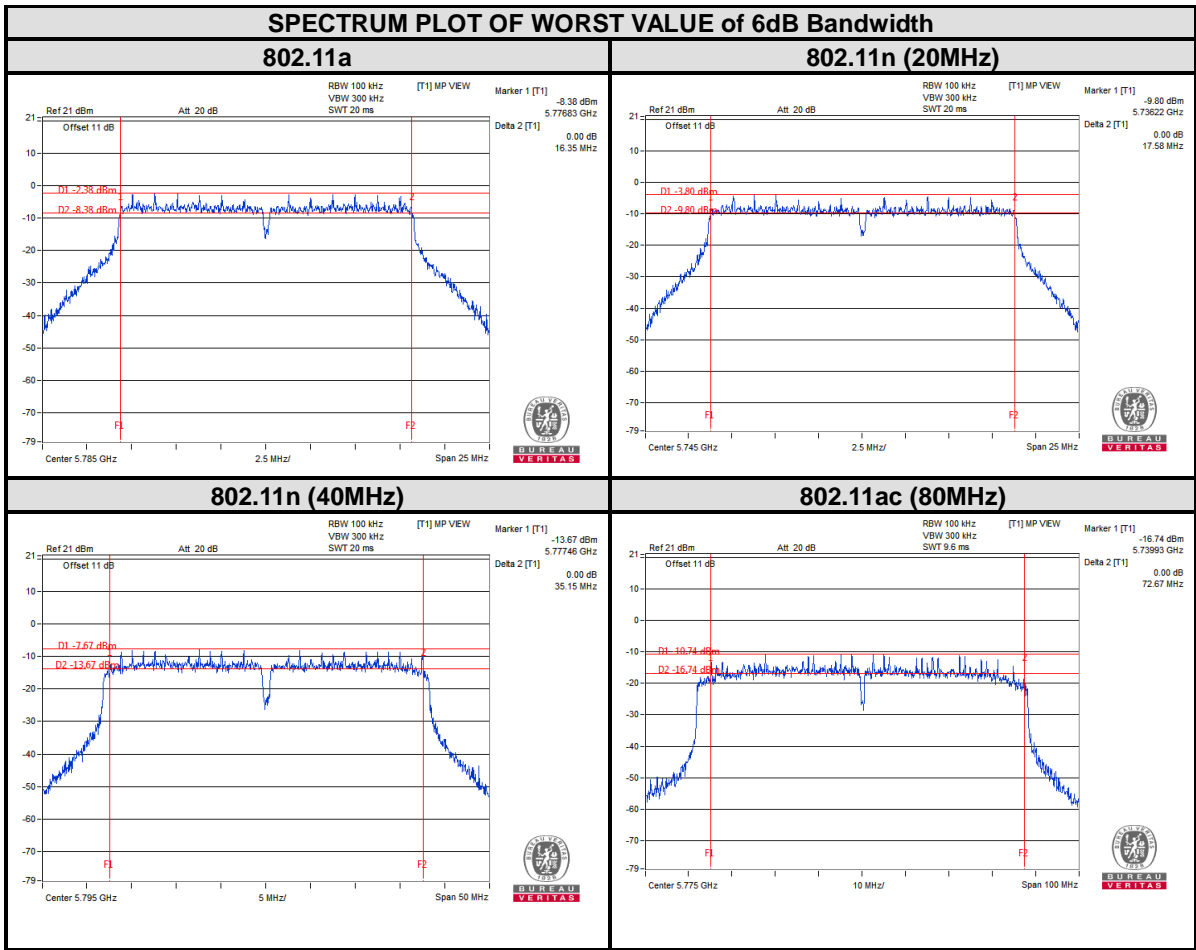



3.4 MAXIMUM POWER SPECTRAL DENSITY MEASUREMENT

3.4.1 LIMITS OF MAXIMUM POWER SPECTRAL DENSITY MEASUREMENT

Operation Band	EUT Category		LIMIT
U-NII-1		Outdoor Access Point	17dBm/ MHz
		Fixed point-to-point Access Point	
		Indoor Access Point	
	√	Client devices	11dBm/ MHz
U-NII-2A	√		11dBm/ MHz
U-NII-2C	√		11dBm/ MHz
U-NII-3	√		30dBm/ 500kHz

3.4.2 TEST SETUP

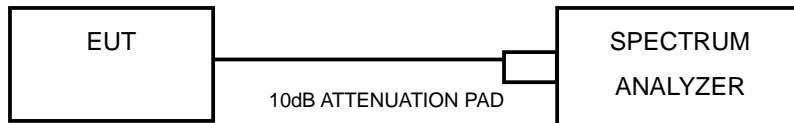

3.4.3 TEST INSTRUMENTS

Refer to section 3.3.3 to get information of above instrument.



3.4.4 TEST PROCEDURES

Using method SA-2

- 1) Set span to encompass the entire emission bandwidth (EBW) of the signal.
- 2) Set RBW = 1 MHz, Set VBW \geq 3 MHz, Detector = RMS
- 3) Set Channel power measure = 1MHz
- 4) Sweep time = auto, trigger set to "free run".
- 5) Trace average at least 100 traces in power averaging mode.
- 6) Add $10 \log (1/x)$, where x is the duty cycle, to the measured power in order to compute the average power during the actual transmission times (because the measurement represents an average over both the on and off times of the transmission).
- 7) Record the max value

3.4.5 DEVIATION FROM TEST STANDARD

No deviation.

3.4.6 EUT OPERATING CONDITIONS

Same as 3.1.6.



3.4.7 TEST RESULTS

For U-NII-1 & U-NII-2A:

802.11a

CHANNEL	FREQUENCY (MHz)	PSD w/o Duty Factor (dBm/MHz)	Duty Factor	PSD with Duty Factor (dBm/MHz)	MAXIMUM LIMIT (dBm/MHz)	PASS/FAIL
36	5180	4.11	0.64	4.75	11	PASS
40	5200	4.93	0.64	5.57	11	PASS
48	5240	3.69	0.64	4.33	11	PASS
52	5260	4.32	0.64	4.96	11	PASS
60	5300	4.26	0.64	4.9	11	PASS
64	5320	3.04	0.64	3.68	11	PASS
100	5500	4.33	0.64	4.97	11	PASS
116	5580	5.00	0.64	5.64	11	PASS
140	5700	5.97	0.64	6.61	11	PASS

802.11n (20MHz)

CHANNEL	FREQUENCY (MHz)	PSD w/o Duty Factor (dBm/MHz)	Duty Factor	PSD with Duty Factor (dBm/MHz)	MAXIMUM LIMIT (dBm/MHz)	PASS/FAIL
36	5180	-0.33	0.68	0.35	11	PASS
40	5200	0.16	0.68	0.84	11	PASS
48	5240	0.20	0.68	0.88	11	PASS
52	5260	1.38	0.68	2.06	11	PASS
60	5300	-0.30	0.68	0.38	11	PASS
64	5320	-1.32	0.68	-0.64	11	PASS
100	5500	0.96	0.68	1.64	11	PASS
116	5580	2.40	0.68	3.08	11	PASS
140	5700	2.21	0.68	2.89	11	PASS



802.11n (40MHz)

CHANNEL	FREQUENCY (MHz)	PSD w/o Duty Factor (dBm/MHz)	Duty Factor	PSD with Duty Factor (dBm/MHz)	MAXIMUM LIMIT (dBm/MHz)	PASS/FAIL
38	5190	-1.45	1.22	-0.23	11	PASS
46	5230	-1.49	1.22	-0.27	11	PASS
54	5270	-2.24	1.22	-1.02	11	PASS
62	5310	-3.01	1.22	-1.79	11	PASS
102	5510	-2.76	1.22	-1.54	11	PASS
110	5550	-2.40	1.22	-1.18	11	PASS
134	5670	-2.28	1.22	-1.06	11	PASS

802.11ac (80MHz)

CHANNEL	FREQUENCY (MHz)	PSD w/o Duty Factor (dBm/MHz)	Duty Factor	PSD with Duty Factor (dBm/MHz)	MAXIMUM LIMIT (dBm/MHz)	PASS/FAIL
42	5210	-6.66	2.67	-3.99	11	PASS
58	5290	-6.67	2.67	-4.00	11	PASS
106	5530	-5.07	2.67	-2.40	11	PASS



For U-NII-3:

802.11a

CHANNEL	FREQUENCY (MHz)	PSD w/o Duty Factor (dBm/MHz)	PSD w/o Duty Factor (dBm/500kHz)	Duty Factor	PSD with Duty Factor (dBm/500kHz)	LIMIT (dBm/500kHz)	PASS /FAIL
149	5745	7.58	4.57	0.64	5.21	30	PASS
157	5785	6.74	3.73	0.64	4.37	30	PASS
165	5825	7.11	4.10	0.64	4.74	30	PASS

802.11n (20MHz)

CHANNEL	FREQUENCY (MHz)	PSD w/o Duty Factor (dBm/MHz)	PSD w/o Duty Factor (dBm/500kHz)	Duty Factor	PSD with Duty Factor (dBm/500kHz)	LIMIT (dBm/500kHz)	PASS /FAIL
149	5745	5.66	2.65	0.68	3.33	30	PASS
157	5785	4.71	1.70	0.68	2.38	30	PASS
165	5825	4.93	1.92	0.68	2.60	30	PASS

802.11n (40MHz)

CHANNEL	FREQUENCY (MHz)	PSD w/o Duty Factor (dBm/MHz)	PSD w/o Duty Factor (dBm/500kHz)	Duty Factor	PSD with Duty Factor (dBm/500kHz)	LIMIT (dBm/500kHz)	PASS /FAIL
151	5755	2.08	-0.93	1.22	0.29	30	PASS
159	5795	1.02	-1.99	1.22	-0.77	30	PASS

802.11ac (80MHz)

CHANNEL	FREQUENCY (MHz)	PSD w/o Duty Factor (dBm/MHz)	PSD w/o Duty Factor (dBm/500kHz)	Duty Factor	PSD with Duty Factor (dBm/500kHz)	LIMIT (dBm/500kHz)	PASS /FAIL
155	5775	-2.14	-5.15	2.67	-2.48	30	PASS



BUREAU VERITAS

Test Report No.: RF171211W008-3

For 5180~5240MHz

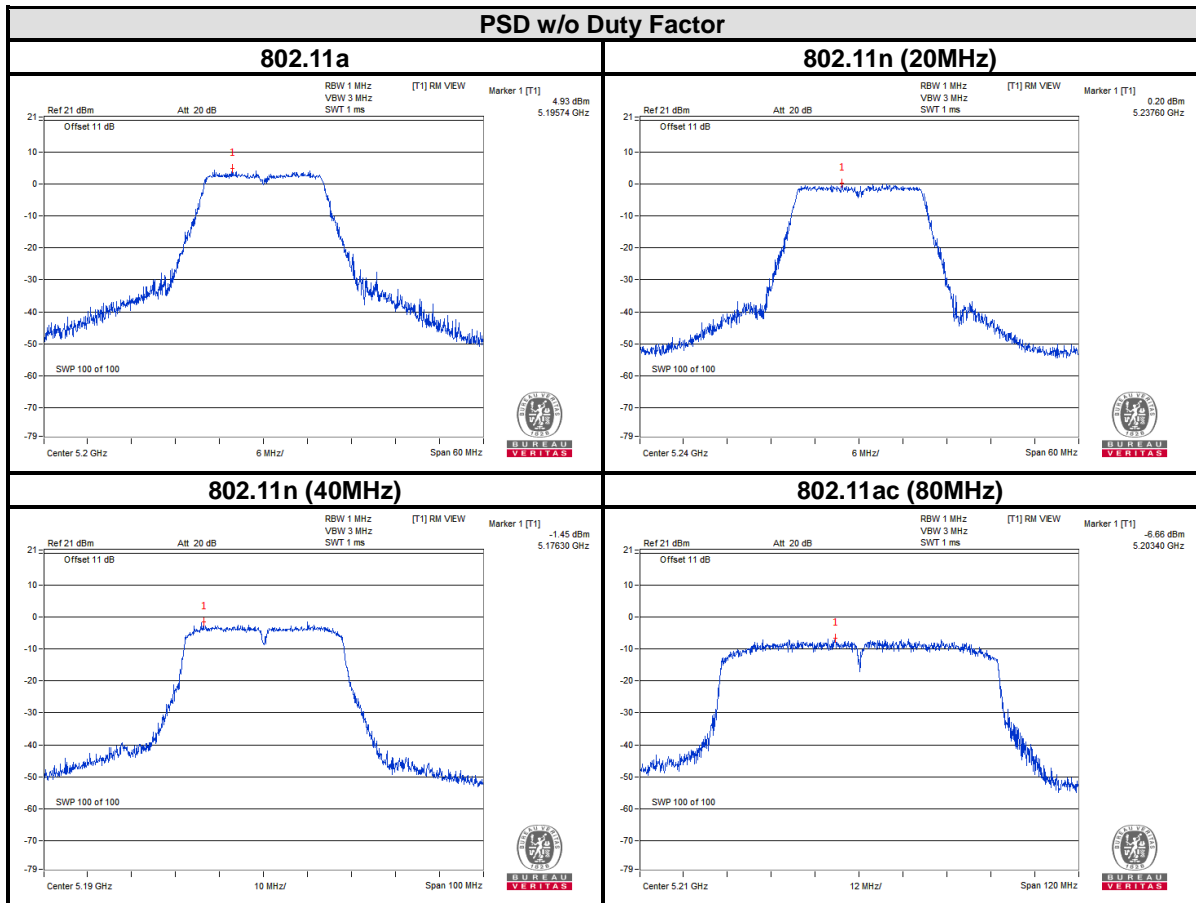



BUREAU
VERITAS

Test Report No.: RF171211W008-3

For 5260~5320MHz

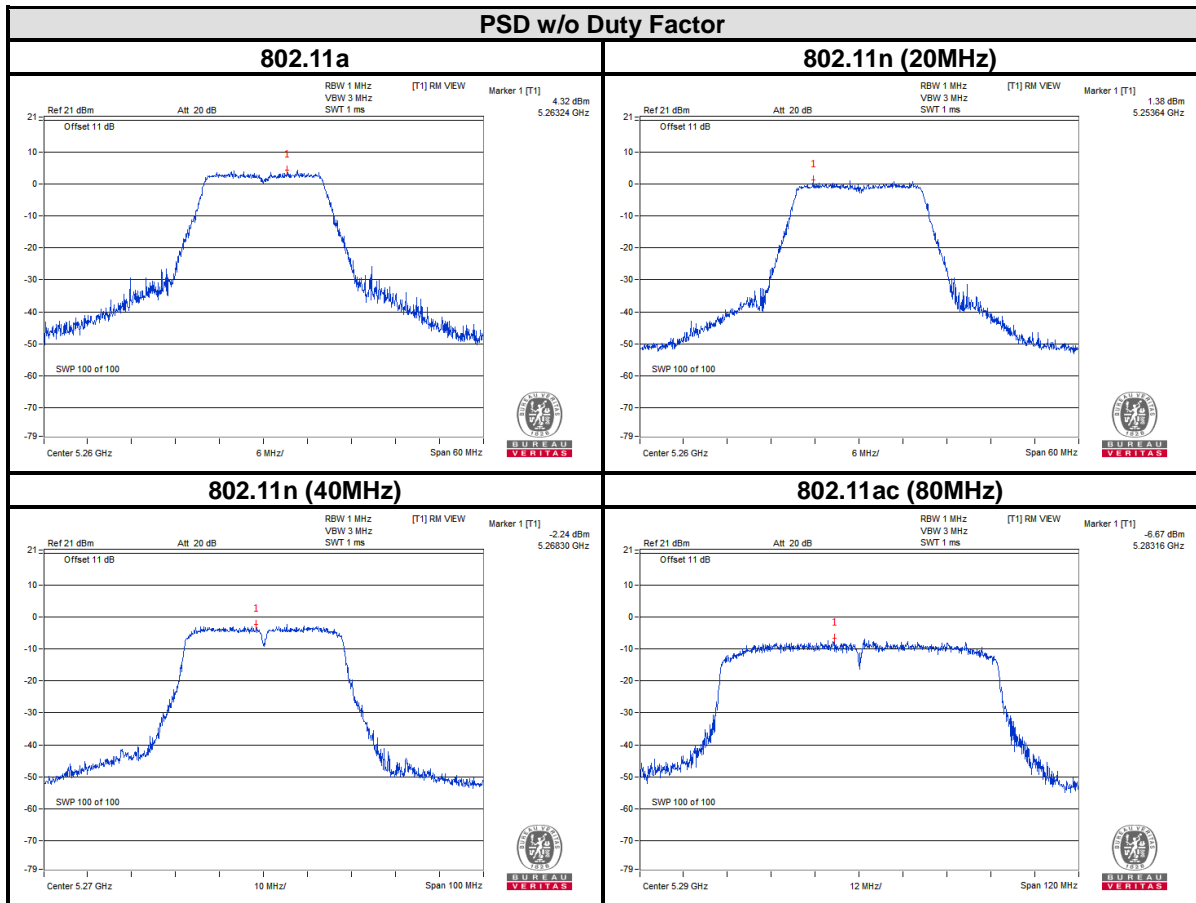



BUREAU
VERITAS

Test Report No.: RF171211W008-3

For 5500~5700MHz

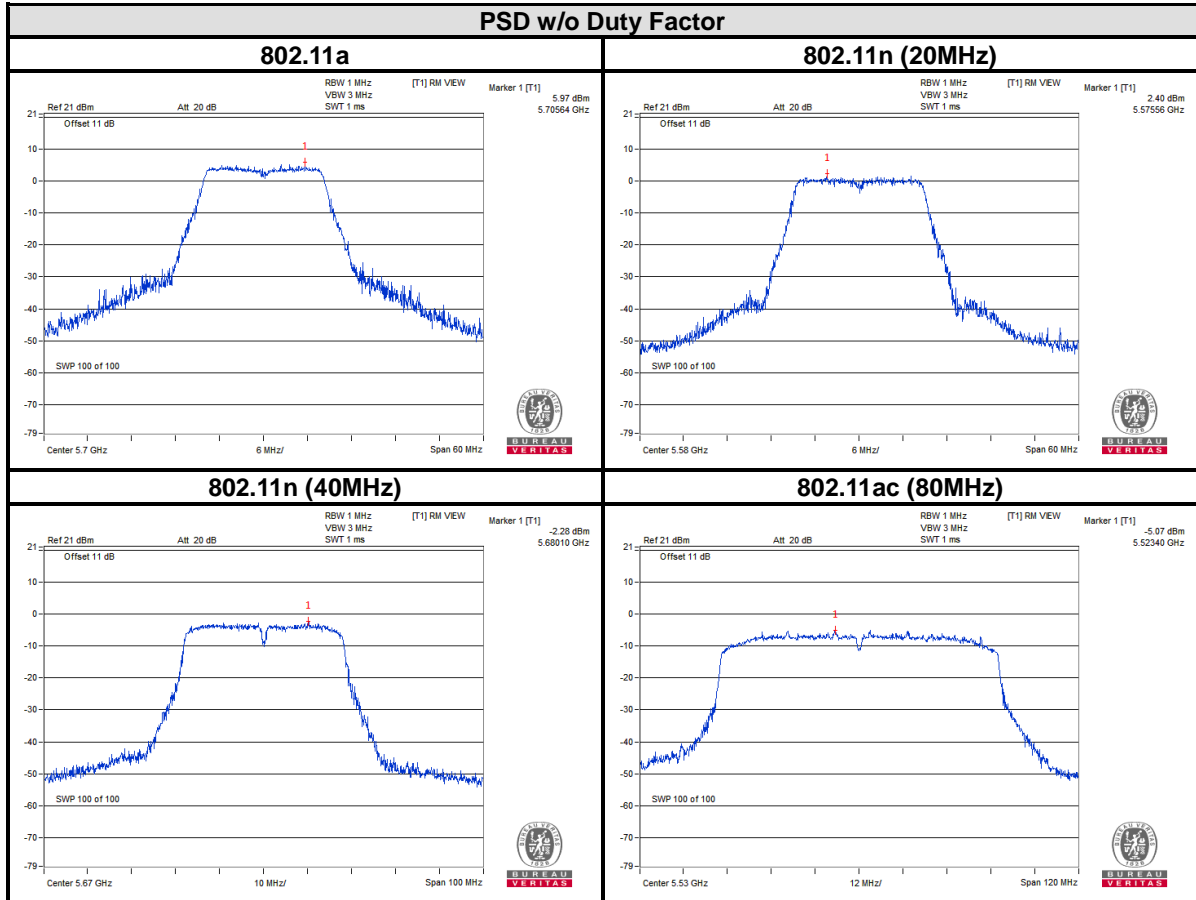



BUREAU VERITAS

Test Report No.: RF171211W008-3

For 5745~5825MHz

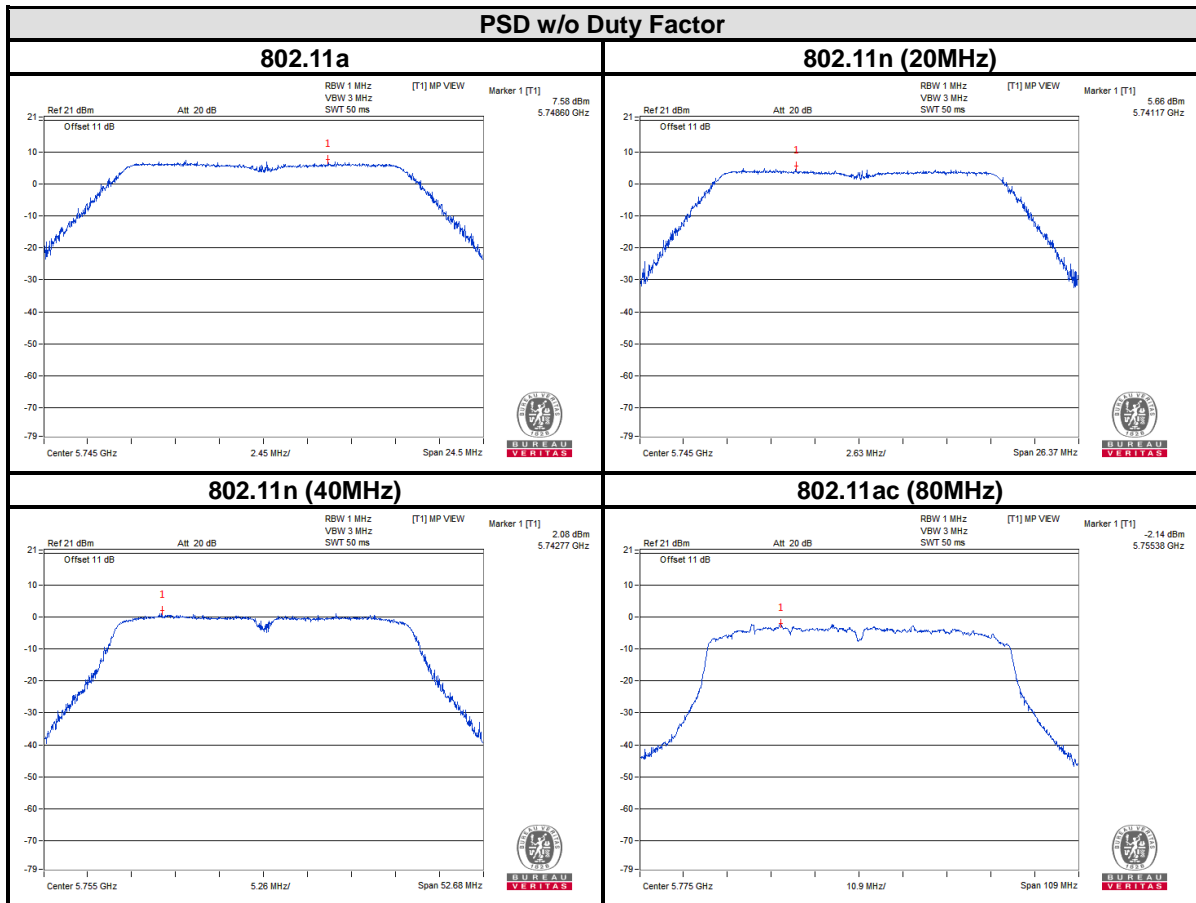



3.5 FREQUENCY STABILITY

3.5.1 LIMITS OF FREQUENCY STABILITY MEASUREMENT

The frequency of the carrier signal shall be maintained within band of operation

3.5.2 TEST SETUP

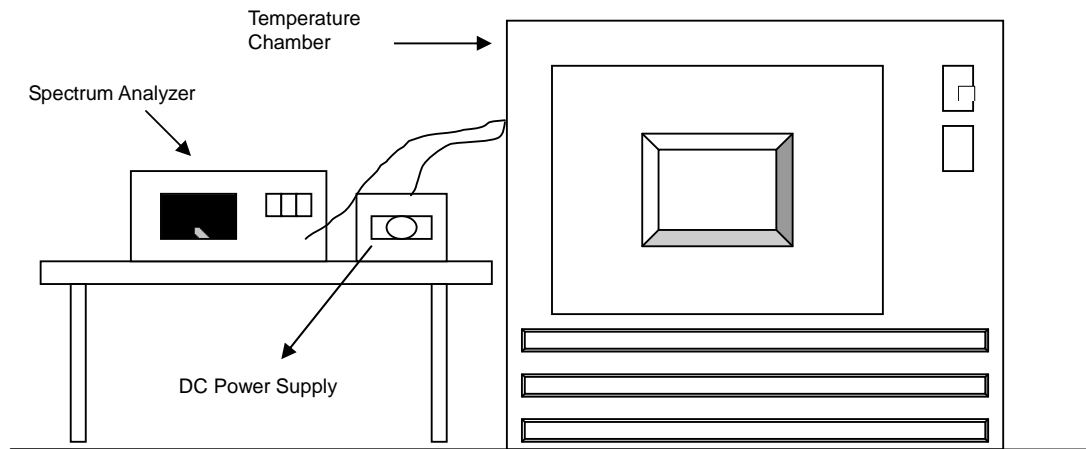

3.5.3 TEST INSTRUMENTS

Refer to section 3.3.3 to get information of above instrument.



3.5.4 TEST PROCEDURE

- a. The EUT was placed inside the environmental test chamber and powered by nominal DC voltage.
- b. Turn the EUT on and couple its output to a spectrum analyzer.
- c. Turn the EUT off and set the chamber to the highest temperature specified.
- d. Allow sufficient time (approximately 30 min) for the temperature of the chamber to stabilize, turn the EUT on and measure the operating frequency after 2, 5, and 10 minutes.
- e. Repeat step 2 and 3 with the temperature chamber set to the lowest temperature.
- f. The test chamber was allowed to stabilize at +20 degree C for a minimum of 30 minutes. The supply voltage was then adjusted on the EUT from 85% to 115% and the frequency record.

3.5.5 DEVIATION FROM TEST STANDARD

No deviation.

3.5.6 EUT OPERATING CONDITION

Set the EUT transmit at un-modulation mode to test frequency stability.



3.5.7 TEST RESULTS

FREQUENCY STABILITY VERSUS TEMP.										
OPERATING FREQUENCY: 5180MHz										
TEMP. (°C)	Power Supply (Vdc)	0 MINUTE		2 MINUTES		5 MINUTES		10 MINUTE		RESULT
		Measured Frequency (MHz)	Frequency Drift (ppm)	Measured Frequency (MHz)	Frequency Drift (ppm)	Measured Frequency (MHz)	Frequency Drift (ppm)	Measured Frequency (MHz)	Frequency Drift (ppm)	
50	120	5179.9903	-1.873	5179.9868	-2.548	5179.9927	-1.409	5179.9949	-0.985	PASS
40	120	5180.0216	4.170	5180.0246	4.749	5180.0264	5.097	5180.0242	4.672	PASS
30	120	5180.0072	1.390	5180.0064	1.236	5180.0019	0.367	5180.0001	0.019	PASS
20	120	5180.0096	1.853	5180.0062	1.197	5180.0017	0.328	5180.0049	0.946	PASS
10	120	5179.9999	-0.019	5180.0053	1.023	5179.9986	-0.270	5180.0006	0.116	PASS
0	120	5179.9798	-3.900	5179.9768	-4.479	5179.9721	-5.386	5179.971	-5.598	PASS
-10	120	5179.9969	-0.598	5180.0017	0.328	5179.9984	-0.309	5179.9898	-1.969	PASS
-20	120	5180.0284	5.483	5180.0234	4.517	5180.0295	5.695	5180.0266	5.135	PASS
-30	120	5179.9861	-2.683	5179.987	-2.510	5179.9831	-3.263	5179.9843	-3.031	PASS

FREQUENCY STABILITY VERSUS VOLTAGE										
OPERATING FREQUENCY: 5180MHz										
TEMP. (°C)	Power Supply (Vdc)	0 MINUTE		2 MINUTE		5 MINUTE		10 MINUTE		RESULT
		Measured Frequency (MHz)	Frequency Drift (ppm)	Measured Frequency (MHz)	Frequency Drift (ppm)	Measured Frequency (MHz)	Frequency Drift (ppm)	Measured Frequency (MHz)	Frequency Drift (ppm)	
20	138	5180.009	1.737	5180.0062	1.197	5180.0016	0.309	5180.0046	0.888	PASS
	120	5180.0096	1.853	5180.0062	1.197	5180.0017	0.328	5180.0049	0.946	PASS
	102	5180.0106	2.046	5180.0056	1.081	5180.0024	0.463	5180.0046	0.888	PASS



FREQUENCY STABILITY VERSUS TEMP.										
OPERATING FREQUENCY: 5825MHz										
TEMP. (°C)	Power Supply (Vdc)	0 MINUTE		2 MINUTES		5 MINUTES		10 MINUTE		RESULT
		Measured Frequency (MHz)	Frequency Drift (ppm)	Measured Frequency (MHz)	Frequency Drift (ppm)	Measured Frequency (MHz)	Frequency Drift (ppm)	Measured Frequency (MHz)	Frequency Drift (ppm)	
50	120	5824.9829	-2.936	5824.9861	-2.386	5824.9888	-1.923	5824.9906	-1.614	PASS
40	120	5824.9843	-2.695	5824.9879	-2.077	5824.989	-1.888	5824.9844	-2.678	PASS
30	120	5824.9684	-5.425	5824.9747	-4.343	5824.9729	-4.652	5824.9779	-3.794	PASS
20	120	5824.9834	-2.850	5824.9808	-3.296	5824.9792	-3.571	5824.9747	-4.343	PASS
10	120	5824.9789	-3.622	5824.9767	-4.000	5824.9727	-4.687	5824.9704	-5.082	PASS
0	120	5824.9873	-2.180	5824.9839	-2.764	5824.9916	-1.442	5824.9929	-1.219	PASS
-10	120	5824.9713	-4.927	5824.9739	-4.481	5824.98	-3.433	5824.9746	-4.361	PASS
-20	120	5824.9936	-1.099	5824.9961	-0.670	5824.9917	-1.425	5824.9984	-0.275	PASS
-30	120	5825.0308	5.288	5825.0308	5.288	5825.0286	4.910	5825.0264	4.532	PASS

FREQUENCY STABILITY VERSUS VOLTAGE										
OPERATING FREQUENCY: 5825MHz										
TEMP. (°C)	Power Supply (Vdc)	0 MINUTE		2 MINUTE		5 MINUTE		10 MINUTE		RESULT
		Measured Frequency (MHz)	Frequency Drift (ppm)	Measured Frequency (MHz)	Frequency Drift (ppm)	Measured Frequency (MHz)	Frequency Drift (ppm)	Measured Frequency (MHz)	Frequency Drift (ppm)	
20	138	5824.9832	-2.884	5824.9797	-3.485	5824.9785	-3.691	5824.9732	-4.601	PASS
	120	5824.9834	-2.850	5824.9808	-3.296	5824.9792	-3.571	5824.9747	-4.343	PASS
	102	5824.9828	-2.953	5824.9798	-3.468	5824.9794	-3.536	5824.9744	-4.395	PASS



**BUREAU
VERITAS**

Test Report No.: RF171211W008-3

4 PHOTOGRAPHS OF THE TEST CONFIGURATION

Please refer to the attached file (Test Setup Photo).



**BUREAU
VERITAS**

Test Report No.: RF171211W008-3

5 APPENDIX A – MODIFICATIONS RECORDERS FOR ENGINEERING CHANGES TO THE EUT BY THE LAB

No modifications were made to the EUT by the lab during the test.

---END---