



Test Report No.: W7L-P22110036RF04



FCC TEST REPORT

(PART 22)

Applicant:	i.safe MOBILE GmbH
Address:	i_Park Tauberfranken 10 97922 Lauda-Koenigshofen Germany

Manufacturer or Supplier:	i.safe MOBILE GmbH
Address:	i_Park Tauberfranken 10 97922 Lauda-Koenigshofen Germany
Product:	Smartphone
Brand Name:	i.safe MOBILE
Model Name:	M540A01
Marketing Name:	IS540.1,IS540.M1,IS540.2,IS540.RG
FCC ID:	2AACZ-M540A01
Date of tests:	Nov. 24, 2022 ~ Feb. 03, 2023

The tests have been carried out according to the requirements of the following standard:

- FCC PART 22, Subpart H
- FCC Part 2
- ANSI/TIA/EIA-603-D
- ANSI C63.26-2015
- ANSI/TIA/EIA-603-E

CONCLUSION: The submitted sample was found to COMPLY with the test requirement

Prepared by Simon Wang Engineer / Mobile Department	Approved by Luke Lu Manager / Mobile Department
Date: Feb. 03, 2023	Date: Feb. 03, 2023

This report is governed by, and incorporates by reference, the Conditions of Testing as posted at the date of issuance of this report at <http://www.bureauveritas.com/home/about-us/our-business/cps/about-us/terms-conditions/> and is intended for your exclusive use. Any copying or replication of this report to or for any other person or entity, or use of our name or trademark, is permitted only with our prior written permission. This report sets forth our findings solely with respect to the test samples identified herein. The results set forth in this report are not indicative or representative of the quality or characteristics of the lot from which a test sample was taken or any similar or identical product unless specifically and expressly noted. Our report includes all of the tests requested by you and the results thereof based upon the information that you provided to us. Measurement uncertainty is only provided upon request for accredited tests. Statements of conformity are based on simple acceptance criteria without taking measurement uncertainty into account, unless otherwise requested in writing. You have 60 days from date of issuance of this report to notify us of any material error or omission caused by our negligence or if you require measurement uncertainty; provided, however, that such notice shall be in writing and shall specifically address the issue you wish to raise. A failure to raise such issue within the prescribed time shall constitute your unqualified acceptance of the completeness of this report, the tests conducted and the correctness of the report contents.



TABLE OF CONTENTS

RELEASE CONTROL RECORD4

1 SUMMARY OF TEST RESULTS.....5

1.1 MEASUREMENT UNCERTAINTY6

1.2 TEST SITE AND INSTRUMENTS7

2 GENERAL INFORMATION8

2.1 GENERAL DESCRIPTION OF EUT8

2.2 CONFIGURATION OF SYSTEM UNDER TEST 11

2.3 DESCRIPTION OF SUPPORT UNITS 12

2.4 TEST ITEM AND TEST CONFIGURATION..... 12

2.5 EUT OPERATING CONDITIONS 16

2.6 GENERAL DESCRIPTION OF APPLIED STANDARDS 17

3 TEST TYPES AND RESULTS..... 18

3.1 OUTPUT POWER MEASUREMENT 18

3.1.1 LIMITS OF OUTPUT POWER MEASUREMENT 18

3.1.2 TEST PROCEDURES 18

3.1.3 TEST SETUP 19

3.1.4 TEST RESULTS 19

3.2 FREQUENCY STABILITY MEASUREMENT 38

3.2.1 LIMITS OF FREQUENCY STABILITY MEASUREMENT 38

3.2.2 TEST PROCEDURE 38

3.2.3 TEST SETUP 38

3.2.4 TEST RESULTS 39

3.3 OCCUPIED BANDWIDTH MEASUREMENT 40

3.3.1 LIMITS OF OCCUPIED BANDWIDTH MEASUREMENT 40

3.3.2 TEST SETUP 40

3.3.3 TEST PROCEDURES 40

3.3.4 TEST RESULTS 41

3.4 BAND EDGE MEASUREMENT 42

3.4.1 LIMITS OF BAND EDGE MEASUREMENT 42

3.4.2 TEST SETUP 42

3.4.3 TEST PROCEDURES 43

3.4.4 TEST RESULTS 44

3.5 CONDUCTED SPURIOUS EMISSIONS..... 45

3.5.1 LIMITS OF CONDUCTED SPURIOUS EMISSIONS MEASUREMENT 45

3.5.2 TEST PROCEDURE 45

3.5.3 TEST SETUP 45

3.5.4 TEST RESULTS 46

3.6 RADIATED EMISSION MEASUREMENT 47

3.6.1 LIMITS OF RADIATED EMISSION MEASUREMENT 47

3.6.2 TEST PROCEDURES 47

3.6.3 DEVIATION FROM TEST STANDARD 47

3.6.4 TEST SETUP 48



**BUREAU
VERITAS**

Test Report No.: W7L-P22110036RF04

3.6.5	TEST RESULTS	50
3.7	PEAK TO AVERAGE RATIO	84
3.7.1	LIMITS OF PEAK TO AVERAGE RATIO MEASUREMENT	84
3.7.2	TEST SETUP	84
3.7.3	TEST PROCEDURES	84
3.7.4	TEST RESULTS	85
4	PHOTOGRAPHS OF THE TEST CONFIGURATION	86
5	INFORMATION ON THE TESTING LABORATORIES	87
6	MODIFICATIONS RECORDERS FOR ENGINEERING CHANGES TO THE EUT BY THE LAB	88
7	APPENDIX.....	89
	GSM850	89
	WCMDA BAND5	105
	LTE BAND26 (INCLUDING LTE BAND5)	118



BUREAU
VERITAS

Test Report No.: W7L-P22110036RF04

RELEASE CONTROL RECORD

ISSUE NO.	REASON FOR CHANGE	DATE ISSUED
W7L-P22110036RF04	Original release	Feb. 03, 2023



1 SUMMARY OF TEST RESULTS

The EUT has been tested according to the following specifications:

APPLIED STANDARD: FCC Part 22 & Part 2		
STANDARD SECTION	TEST TYPE	RESULT
§2.1046	Conducted Output Power	Compliance
§22.913 (a)(5)	Effective Radiated Power	Compliance
§2.1055 §22.355	Frequency Stability	Compliance
§2.1049	Occupied Bandwidth	Compliance
§22.913 (d)	Peak to average ratio*	Compliance
§22.917(a)	Band Edge Measurements	Compliance
§2.1051 §22.917(a)	Conducted Spurious Emissions	Compliance
§2.1053 §22.917(a)	Radiated Spurious Emissions	Compliance

* Refer to KDB 971168 D01 Power Meas License Digital Systems v03r01.



1.1 MEASUREMENT UNCERTAINTY

Where relevant, the following measurement uncertainty levels have been estimated for tests performed on the EUT as specified in CISPR 16-4-2:

MEASUREMENT	UNCERTAINTY
Maximum Peak Output Power	±2.06dB
Frequency Stability	±76.97Hz
Radiated emissions (9KHz~30MHz)	±2.68dB
Radiated emissions (30MHz~1GHz)	±4.98dB
Radiated emissions (1GHz ~6GHz)	±4.70dB
Radiated emissions (6GHz ~18GHz)	±4.60dB
Radiated emissions (18GHz ~40GHz)	±4.12dB
Conducted emissions	±4.01dB
Occupied Channel Bandwidth	±43.58KHz
Band Edge Measurements	±4.70dB
Peak to average ratio	±0.76dB

This uncertainty represents an expanded uncertainty expressed at approximately the 95% confidence level using a coverage factor of k=2.



1.2 TEST SITE AND INSTRUMENTS

Equipment	Manufacturer	Model No.	Serial No.	Last Cal.	Next Cal.
MXE EMI Receiver	KEYSIGHT	N9038A-544	MY54450026	Feb. 21,22	Feb. 20,23
EXA Signal Analyzer	KEYSIGHT	N9010A-544	MY54510355	May.15,22	May.14,23
Loop Antenna	Schwarzbeck	FMZB 1519B	00173	Sep.04,22	Sep.03,23
Bilog Antenna	ETS-LINDGRE N	3143B	00161965	Mar. 06,22	Mar. 05,23
Horn Antenna	ETS-LINDGRE N	3117	00168692	Mar. 06,22	Mar. 05,23
Horn Antenna (18GHz-40GHz)	N/A	QWH-SL-18-40-K- SG/QMS-00361	15433	Aug. 24, 22	Aug. 23, 23
Radio Communication Analyzer	ANRITSU	MT8820C	6201465426	Feb. 15,22	Feb. 14,23
Signal Pre-Amplifier	EMSI	EMC 9135	980249	May.12,22	May.11,23
Signal Pre-Amplifier	EMSI	EMC 012645B	980257	May.12,22	May.11,23
Signal Pre-Amplifier	EMSI	EMC 184045B	980259	Feb. 21,22	Feb.20,23
3m Semi-anechoic Chamber	ETS-LINDGRE N	9m*6m*6m	Euroshieldpn- CT0001143-121 6	May. 19,20	May. 18,23
Test Software	E3	V 9.160323	N/A	N/A	N/A
Test Software	JS1120	3.1.36	N/A	N/A	N/A
10dB Attenuator	JFW/USA	50HF-010-SMA	1505	May. 07,22	May. 06,23
Power Meter	Anritsu	ML2495A	1506002	Feb. 22,22	Feb. 21,23
Power Sensor	Anritsu	MA2411B	1339352	May. 07,22	May. 06,23
Temperature Chamber	ESPEC	SH-242	93000855	May. 12,22	May. 11,23
MXG Analog Microwave Signal Generator	KEYSIGHT	N5183A	MY50143024	Feb. 18,22	Feb. 17,23
Base station R&S CMW500	Rohde&Schwa rz	CMW500	153085	May.12,22	May.11,23
DC Source	Kikusui/JP	PMX18-5A	0000001	Aug. 24,22	Aug. 23,23

- NOTE:**
1. The calibration interval of the above test instruments is 12 months or 36 months and the calibrations are traceable to CEPREI/CHINA, GRGT/CHINA and NIM/CHINA.
 2. The test was performed in 3m Semi-anechoic Chamber and RF Oven Room.
 3. The horn antenna is used only for the measurement of emission frequency above 1GHz if tested.
 4. The FCC Site Registration No. is 525120; The Designation No. is CN1171.



2 GENERAL INFORMATION

2.1 GENERAL DESCRIPTION OF EUT

PRODUCT	Smartphone	
BRAND NAME	i.safe MOBILE	
MODEL NAME	M540A01	
MARKETING NAME	IS540.1,IS540.M1,IS540.2,IS540.RG	
NOMINAL VOLTAGE	5.0Vdc(adapter or host equipment) 3.7Vdc (Li-ion, battery)	
MODULATION TYPE	GSM/EDGE	GMSK, 8PSK
	WCDMA	BPSK, QPSK
	LTE	QPSK, 16QAM, 64QAM
FREQUENCY RANGE	GSM/EDGE	824.2MHz ~ 848.8MHz
	WCDMA	826.4MHz ~ 846.6MHz
	LTE Band 5 (Channel Bandwidth: 1.4MHz)	824.7MHz ~ 848.3MHz
	LTE Band 5 (Channel Bandwidth: 3MHz)	825.5MHz ~ 847.5MHz
	LTE Band 5 (Channel Bandwidth: 5MHz)	826.5MHz ~ 846.5MHz
	LTE Band 5 (Channel Bandwidth: 10MHz)	829MHz ~ 844MHz
	LTE Band 26 (Channel Bandwidth: 1.4MHz)	824.7MHz ~ 848.3MHz
	LTE Band 26 (Channel Bandwidth: 3MHz)	825.5MHz ~ 847.5MHz
	LTE Band 26 (Channel Bandwidth: 5MHz)	826.5MHz ~ 846.5MHz
	LTE Band 26 (Channel Bandwidth: 10MHz)	829MHz ~ 844MHz
	LTE Band 26 (Channel Bandwidth: 15MHz)	831.5MHz ~ 841.5MHz
	MAX. ERP POWER	GSM
EDGE		123.59mW
WCDMA		57.94mW
LTE Band 5 (Channel Bandwidth: 1.4MHz)		56.49mW
LTE Band 5 (Channel Bandwidth: 3MHz)		56.36mW
LTE Band 5 (Channel Bandwidth: 5MHz)		56.62mW



	LTE Band 5 (Channel Bandwidth: 10MHz)	57.28mW	
MAX. ERP POWER	LTE Band 26 (Channel Bandwidth: 1.4MHz)	53.33mW	
	LTE Band 26 (Channel Bandwidth: 3MHz)	53.83mW	
	LTE Band 26 (Channel Bandwidth: 5MHz)	53.83mW	
	LTE Band 26 (Channel Bandwidth: 10MHz)	53.7mW	
	LTE Band 26 (Channel Bandwidth: 15MHz)	54.08mW	
	EMISSION DESIGNATOR GOGN	GSM	247KGXW
EDGE		243KG7W	
WCDMA		4M15F9W	
LTE Band 26 (Channel Bandwidth: 1.4MHz)		QPSK: 1M09G7D	
		16QAM: 1M09W7D	
		64QAM: 1M09W7D	
LTE Band 26 (Channel Bandwidth: 3MHz)		QPSK: 2M70G7D	
		16QAM: 2M69W7D	
		64QAM: 2M70W7D	
LTE Band 26 (Channel Bandwidth: 5MHz)		QPSK: 4M50G7D	
		16QAM: 4M51W7D	
		64QAM: 4M50W7D	
LTE Band 26 (Channel Bandwidth: 10MHz)		QPSK: 8M98G7D	
		16QAM: 8M96W7D	
		64QAM: 8M97W7D	
LTE Band 26 (Channel Bandwidth: 15MHz)		QPSK: 13M5G7D	
		16QAM: 13M5W7D	
		64QAM: 13M5W7D	
ANTENNA TYPE		PIFA Antenna with -3dBi gain for GSM850/WCDMA V/LTE B5/LTE B26	
HW VERSION		V02	
SW VERSION		IS540_ROW_00.00_1_20221017	
I/O PORTS	Refer to user's manual		
CABLE SUPPLIED	USB cable1: non-shielded cable, with w/o ferrite core, 1.0 meter USB cable2: non-shielded cable, with w/o ferrite core, 1.0 meter		
EXTREME TEMPERATURE	-10-50 °C		
EXTREME VOLTAGE	3.6V - 4.2V		



NOTE:

1. For a more detailed features description, please refer to the manufacturer’s specifications or the user’s manual.
2. The EUT incorporates a SISO function. Physically, the EUT provides one completed transmitter and one receiver.

MODULATION MODE	TX FUNCTION
GSM/GPRS/EDGE	1TX/1RX
WCDMA	1TX/1RX
LTE	1TX/1RX

3. For the test results, the EUT had been tested with all conditions. But only the worst case was shown in test report.

List of Accessory:

ACCESSORIES	BRAND	MANUFACTURER	MODEL	SPECIFICATION
Battery	N/A	FPR Connectivity Technology Inc.	MBP540A01	Capacity: 3.7Vdc, 4400mAh
AC Adapter	N/A	SHENZHEN SHI YINGYUAN POWER SUPPLY TECHNOLOGY CO., LTD.	ICP12-050-2000B	I/P: 100-240Vac, 0.3A, O/P: 5.0Vdc, 2A
USB Cable 1	N/A	Winpower Technology Co., LTD	USB2.0	Signal Line, 1.0meter
USB Cable 2	N/A	Winpower Technology Co., LTD	PROTECTOR 2.0	Signal Line, 1.0meter



2.2 CONFIGURATION OF SYSTEM UNDER TEST FOR RADIATION EMISSION

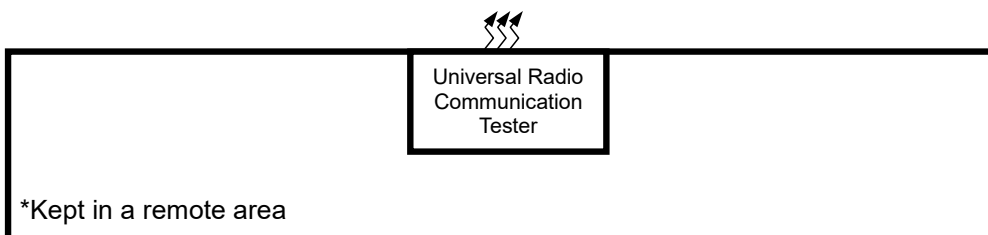
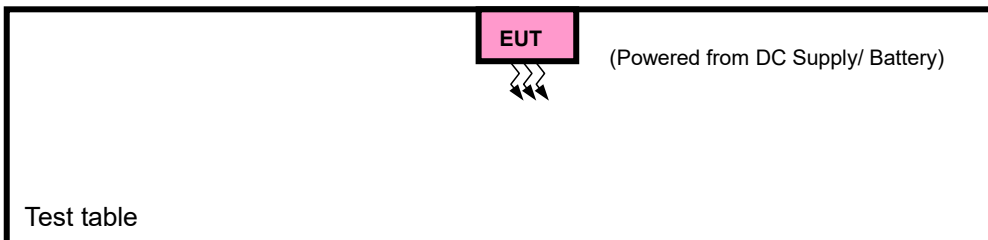
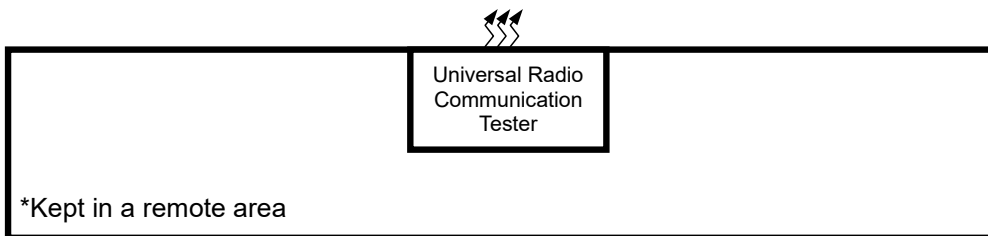
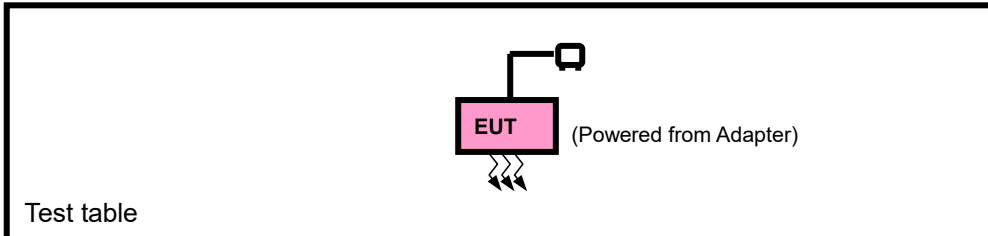



2.3 DESCRIPTION OF SUPPORT UNITS

The EUT has been tested as an independent unit together with other necessary accessories or support units. The following support units or accessories were used to form a representative test configuration during the tests.

NO.	PRODUCT	BRAND	MODEL NO.	SERIAL NO.	FCC ID
1	DC source	Kikusui/JP	PMX18-5A	0000001	N/A

NO.	SIGNAL CABLE DESCRIPTION OF THE ABOVE SUPPORT UNITS
1	DC Line: Unshielded, Detachable 1.0m

2.4 TEST ITEM AND TEST CONFIGURATION

Pre-Scan has been conducted to determine the worst-case mode from all possible combinations between available modulations, data rates, XYZ axis and antenna ports. The worst case in ERP and radiated emission was found when positioned on X-plane for GSM /EDGE /LTE. Following channel(s) was (were) selected for the final test as listed below:

EUT CONFIGURE MODE	DESCRIPTION
A	EUT + Adapter with GSM or WCDMA or LTE link
B	EUT + DC Supply with GSM or WCDMA or LTE link



GSM MODE

EUT CONFIGURE MODE	TEST ITEM	AVAILABLE CHANNEL	TESTED CHANNEL	MODE
A	ERP	128 to 251	128, 189, 251	GSM,EDGE
B	FREQUENCY STABILITY	128 to 251	128, 189, 251	GSM,EDGE
A	OCCUPIED BANDWIDTH	128 to 251	128, 189, 251	GSM,EDGE
A	BAND EDGE	128 to 251	128, 251	GSM,EDGE
A	CONDCUDETED EMISSION	128 to 251	128, 189, 251	GSM,EDGE
A	RADIATED EMISSION	128 to 251	128, 189, 251	GSM,EDGE
A	PEAK TO AVERAGE RATIO	128 to 251	128, 189, 251	GSM,EDGE

WCDMA MODE

EUT CONFIGURE MODE	TEST ITEM	AVAILABLE CHANNEL	TESTED CHANNEL	MODE
A	ERP	4132 to 4233	4132, 4182, 4233	WCDMA
B	FREQUENCY STABILITY	4132 to 4233	4132, 4182, 4233	WCDMA
A	OCCUPIED BANDWIDTH	4132 to 4233	4132, 4182, 4233	WCDMA
A	BAND EDGE	4132 to 4233	4132, 4233	WCDMA
A	CONDCUDETED EMISSION	4132 to 4233	4132, 4182, 4233	WCDMA
A	RADIATED EMISSION	4132 to 4233	4132, 4182, 4233	WCDMA
A	PEAK TO AVERAGE RATIO	4132 to 4233	4132, 4182, 4233	WCDMA



LTE BAND 5 MODE

EUT CONFIGURE MODE	TEST ITEM	Available Channel	Tested Channel	Channel bandwidth	modulation	mode
A	ERP	20407 to 20643	20407, 20525, 20643	1.4MHz	QPSK,16QAM,64QAM	1 RB / 0 RB Offset
		20415 to 20635	20415, 20525, 20635	3MHz	QPSK,16QAM,64QAM	1 RB / 0 RB Offset
		20425 to 20625	20425, 20525, 20625	5MHz	QPSK,16QAM,64QAM	1 RB / 0 RB Offset
		20450 to 20600	20450, 20525, 20600	10MHz	QPSK,16QAM,64QAM	1 RB / 0 RB Offset

Note: 1.This device was tested under all bandwidths, RB configurations and modulations. The worst case was found in QPSK modulation.

2. LTE Band 5 are covered by LTE Band 26, Because it is a subset of LTE Band 26 with the same output power and supported bandwidths, So the test data please refer to LTE Band 26

LTE BAND 26 MODE

EUT CONFIGURE MODE	TEST ITEM	Available Channel	Tested Channel	Channel bandwidth	modulation	mode
A	ERP	26797 to 27033	26797, 26915, 27033	1.4MHz	QPSK,16QAM,64QAM	1 RB / 0 RB Offset
		26805 to 27025	26805, 26915, 27025	3MHz	QPSK,16QAM,64QAM	1 RB / 0 RB Offset
		26815 to 27015	26815, 26915, 27015	5MHz	QPSK,16QAM,64QAM	1 RB / 0 RB Offset
		26840 to 26990	26840, 26915, 26990	10MHz	QPSK,16QAM,64QAM	1 RB / 0 RB Offset
		26865 to 26965	26865, 26915, 26965	15MHz	QPSK,16QAM,64QAM	1 RB / 0 RB Offset
B	FREQUENCY STABILITY	26797 to 27033	26797, 26915, 27033	1.4MHz	QPSK,16QAM,64QAM	6 RB / 0 RB Offset
		26805 to 27025	26805, 26915, 27025	3MHz	QPSK,16QAM,64QAM	15 RB / 0 RB Offset
		26815 to 27015	26815, 26915, 27015	5MHz	QPSK,16QAM,64QAM	25 RB / 0 RB Offset
		26840 to 26990	26840, 26915, 26990	10MHz	QPSK,16QAM,64QAM	50 RB / 0 RB Offset
		26865 to 26965	26865, 26915, 26965	15MHz	QPSK,16QAM,64QAM	75 RB / 0 RB Offset
A	OCCUPIED BANDWIDTH	26797 to 27033	26797, 26915, 27033	1.4MHz	QPSK,16QAM,64QAM	6 RB / 0 RB Offset
		26805 to 27025	26805, 26915, 27025	3MHz	QPSK,16QAM,64QAM	15 RB / 0 RB Offset
		26815 to 27015	26815, 26915, 27015	5MHz	QPSK,16QAM,64QAM	25 RB / 0 RB Offset
		26840 to 26990	26840, 26915, 26990	10MHz	QPSK,16QAM,64QAM	50 RB / 0 RB Offset
		26865 to 26965	26865, 26915, 26965	15MHz	QPSK,16QAM,64QAM	75 RB / 0 RB Offset
A	PEAK TO AVERAGE RATIO	26697 to 26783	26697, 26740, 26783	1.4MHz	QPSK,16QAM,64QAM	1 RB / 0 RB Offset 6 RB / 0 RB Offset
		26705 to 26775	26705, 26740, 26775	3MHz	QPSK,16QAM,64QAM	1 RB / 0 RB Offset 15 RB / 0 RB Offset



		26715 to 26765	26715, 26740, 26765	5MHz	QPSK, 16QAM, 64QAM	1 RB / 0 RB Offset 25 RB / 0 RB Offset		
		26740	26740	10MHz	QPSK, 16QAM, 64QAM	1 RB / 0 RB Offset 50 RB / 0 RB Offset		
A	BAND EDGE	26797 to 27033	26797	1.4 MHz	QPSK, 16QAM, 64QAM	1 RB / 0 RB Offset 6 RB / 0 RB Offset		
		26797 to 27033	27033	1.4 MHz	QPSK, 16QAM, 64QAM	1 RB / 5 RB Offset 6 RB / 0 RB Offset		
		26805 to 27025	26805	3 MHz	QPSK, 16QAM, 64QAM	1 RB / 0 RB Offset 15 RB / 0 RB Offset		
		26805 to 27025	27025	3 MHz	QPSK, 16QAM, 64QAM	1 RB / 14 RB Offset 15 RB / 0 RB Offset		
		26815 to 27015	26815	5MHz	QPSK, 16QAM, 64QAM	1 RB / 0 RB Offset 25 RB / 0 RB Offset		
		26815 to 27015	27015	5MHz	QPSK, 16QAM, 64QAM	1 RB / 24 RB Offset 25 RB / 0 RB Offset		
		26840 to 26990	26840	10MHz	QPSK, 16QAM, 64QAM	1 RB / 0 RB Offset 50 RB / 0 RB Offset		
		26840 to 26990	26990	10MHz	QPSK, 16QAM, 64QAM	1 RB / 49 RB Offset 50 RB / 0 RB Offset		
		26865 to 26965	26865	15MHz	QPSK, 16QAM, 64QAM	1 RB / 0 RB Offset 75 RB / 0 RB Offset		
		26865 to 26965	26965	15MHz	QPSK, 16QAM, 64QAM	1 RB / 74 RB Offset 75 RB / 0 RB Offset		
		A	CONDCUETED EMISSION	26797 to 27033	26797, 26915, 27033	1.4MHz	QPSK, 16QAM, 64QAM	1 RB / 0 RB Offset
				26805 to 27025	26805, 26915, 27025	3MHz	QPSK, 16QAM, 64QAM	1 RB / 0 RB Offset
26815 to 27015	26815, 26915, 27015			5MHz	QPSK, 16QAM, 64QAM	1 RB / 0 RB Offset		
26840 to 26990	26840, 26915, 26990			10MHz	QPSK, 16QAM, 64QAM	1 RB / 0 RB Offset		
26865 to 26965	26865, 26915, 26965			15MHz	QPSK, 16QAM, 64QAM	1 RB / 0 RB Offset		
A	RADIATED EMISSION	26797 to 27033	26915	1.4MHz	QPSK	1 RB / 0 RB Offset		
		26805 to 27025	26915	3MHz	QPSK	1 RB / 0 RB Offset		
		26815 to 27015	26915	5MHz	QPSK	1 RB / 0 RB Offset		
		26840 to 26990	26915	10MHz	QPSK	1 RB / 0 RB Offset		
		26865 to 26965	26865, 26915, 26965	15MHz	QPSK	1 RB / 0 RB Offset		

Note: This device was tested under all bandwidths, RB configurations and modulations. The worst case was found in QPSK modulation.



TEST CONDITION:

TEST ITEM	ENVIRONMENTAL CONDITIONS	INPUT POWER	TESTED BY
ERP	23deg. C, 70%RH	DC 5V By Adapter	Jace Hu
FREQUENCY STABILITY	23deg. C, 70%RH	DC 3.6V/3.7V/4.2V By DC Supply	James Fu
OCCUPIED BANDWIDTH	23deg. C, 70%RH	DC5V By Adapter	James Fu
BAND EDGE	23deg. C, 70%RH	DC 5V By Adapter	James Fu
CONDCUDED EMISSION	23deg. C, 70%RH	DC5V By Adapter	James Fu
RADIATED EMISSION	23deg. C, 70%RH	DC5V By Adapter	Jace Hu
PEAK TO AVERAGE RATIO	23deg. C, 70%RH	DC5V By Adapter	James Fu

2.5 EUT OPERATING CONDITIONS

The EUT makes a call to the communication simulator. The communication simulator station system controlled a EUT to export maximum output power under transmission mode and specific channel frequency



**BUREAU
VERITAS**

Test Report No.: W7L-P22110036RF04

2.6 GENERAL DESCRIPTION OF APPLIED STANDARDS

The EUT is a RF product. According to the specifications of the manufacturer, it must comply with the requirements of the following standards:

FCC 47 CFR Part 2

FCC 47 CFR Part 22

KDB 971168 D01 Power Meas License Digital Systems v03r01

ANSI/TIA/EIA-603-D

ANSI/TIA/EIA-603-E

ANSI C63.26-2015

NOTE: All test items have been performed and recorded as per the above standards.

3 TEST TYPES AND RESULTS

3.1 OUTPUT POWER MEASUREMENT

3.1.1 LIMITS OF OUTPUT POWER MEASUREMENT

Mobile / Portable station are limited to 7 watts e.r.p.

3.1.2 TEST PROCEDURES

EIRP / ERP MEASUREMENT:

Per KDB 971168 D01 Power Meas License Digital Systems v03r01 or subclause 5.2.5.5 of ANSI C63.26-2015, the relevant equation for determining the ERP or EIRP from the conducted RF output power measured using the guidance provided above is:

$$\text{ERP or EIRP} = P_{\text{Meas}} + G_{\text{T}} - L_{\text{C}}$$

Where:

ERP or EIRP = effective radiated power or equivalent isotropically radiated power, respectively

(expressed in the same units as P_{Meas} , typically dBW or dBm);

P_{Meas} = measured transmitter output power or PSD, in dBm or dBW;

G_{T} = gain of the transmitting antenna, in dBd (ERP) or dBi (EIRP);

L_{C} = signal attenuation in the connecting cable between the transmitter and antenna, in dB.

CONDUCTED POWER MEASUREMENT:

The EUT was set up for the maximum power with WCDMA link data modulation and link up with simulator. Set the EUT to transmit under low, middle and high channel and record the power level shown on simulator.



3.1.3 TEST SETUP

EIRP / ERP Measurement:

CONDUCTED POWER MEASUREMENT:

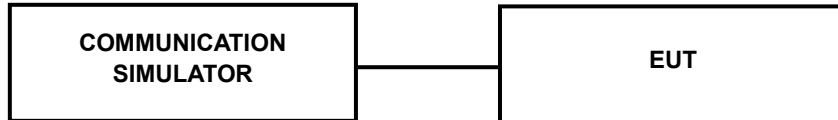

3.1.4 TEST RESULTS

CONDUCTED OUTPUT POWER (dBm)

Band	GSM850		
Channel	128	189	251
Frequency	824.2	836.4	848.8
GSM	32.05	32.12	32.02
GPRS (GMSK, 1Tx-slot)	32.04	32.10	31.99
GPRS (GMSK, 2Tx-slot)	30.25	30.09	30.23
GPRS (GMSK, 3Tx-slot)	28.73	28.64	28.65
GPRS (GMSK, 4Tx-slot)	27.20	27.07	27.16
EDGE (8PSK, 1Tx-slot)	25.71	26.07	25.95
EDGE (8PSK, 2Tx-slot)	25.42	25.77	25.69
EDGE (8PSK, 3Tx-slot)	21.71	21.69	21.70
EDGE (8PSK, 4Tx-slot)	20.68	20.65	20.63

Band	WCDMA V		
Channel	4132	4182	4233
Frequency	826.4	836.4	846.6
RMC 12.2K	22.78	22.76	22.75
HSDPA Subtest-1	21.76	21.68	21.73
HSDPA Subtest-2	21.73	21.68	21.74
HSDPA Subtest-3	21.24	21.21	21.20
HSDPA Subtest-4	21.20	21.25	21.20
DC-HSDPA Subtest-1	21.74	21.71	21.74
DC-HSDPA Subtest-2	21.72	21.74	21.70
DC-HSDPA Subtest-3	21.21	21.21	21.23
DC-HSDPA Subtest-4	21.20	21.24	21.20
HSUPA Subtest-1	19.26	19.18	19.23
HSUPA Subtest-2	19.20	19.20	19.17
HSUPA Subtest-3	19.22	19.24	19.19
HSUPA Subtest-4	19.21	19.21	19.23
HSUPA Subtest-5	21.42	21.39	21.40



LTE Band 5

Band/BW	Modulation	RB Size	RB Offset	Low CH 20407	Mid CH 20525	High CH 20643
				Frequency 824.7 MHz	Frequency 836.5 MHz	Frequency 848.3 MHz
5/ 1.4	QPSK	1	0	22.50	22.67	22.50
		1	2	22.13	22.41	22.18
		1	5	22.25	22.41	22.30
		3	0	22.24	22.48	22.31
		3	1	22.22	22.46	22.28
		3	3	22.25	22.61	22.33
		6	0	21.25	21.41	21.30
	16QAM	1	0	21.40	21.69	21.43
		1	2	21.39	21.68	21.46
		1	5	21.42	21.73	21.52
		3	0	21.25	21.41	21.28
		3	1	21.26	21.53	21.33
		3	3	21.34	21.67	21.38
		6	0	20.26	20.53	20.38
	64QAM	1	0	20.28	20.49	20.25
		1	2	20.28	20.64	20.39
		1	5	20.41	20.57	20.39
		3	0	20.19	20.48	20.24
		3	1	20.23	20.57	20.31
		3	3	20.36	20.55	20.38
		6	0	19.28	19.54	19.32



Band/BW	Modulation	RB Size	RB Offset	Low CH 20415	Mid CH 20525	High CH 20635
				Frequency 825.5 MHz	Frequency 836.5 MHz	Frequency 847.5 MHz
5/3	QPSK	1	0	22.45	22.66	22.47
		1	7	22.11	22.43	22.21
		1	14	22.19	22.47	22.26
		8	0	21.21	21.55	21.30
		8	3	21.22	21.46	21.25
		8	7	21.25	21.61	21.36
		15	0	21.24	21.41	21.27
	16QAM	1	0	21.44	21.63	21.47
		1	7	21.38	21.69	21.43
		1	14	21.47	21.69	21.55
		8	0	20.25	20.42	20.25
		8	3	20.28	20.51	20.39
		8	7	20.39	20.67	20.36
		15	0	20.26	20.53	20.33
	64QAM	1	0	20.31	20.48	20.28
		1	7	20.31	20.64	20.37
		1	14	20.41	20.57	20.40
		8	0	19.19	19.50	19.27
		8	3	19.27	19.51	19.36
		8	7	19.33	19.59	19.34
		15	0	19.30	19.51	19.36



Band/BW	Modulation	RB Size	RB Offset	Low CH 20425	Mid CH 20525	High CH 20625
				Frequency 826.5 MHz	Frequency 836.5 MHz	Frequency 846.5 MHz
5/5	QPSK	1	0	22.47	22.68	22.47
		1	12	22.10	22.47	22.18
		1	24	22.23	22.44	22.31
		12	0	21.23	21.54	21.27
		12	6	21.19	21.46	21.31
		12	13	21.25	21.60	21.33
		25	0	21.27	21.38	21.29
	16QAM	1	0	21.38	21.65	21.40
		1	12	21.40	21.71	21.42
		1	24	21.43	21.70	21.55
		12	0	20.21	20.42	20.25
		12	6	20.27	20.54	20.39
		12	13	20.32	20.67	20.38
		25	0	20.23	20.60	20.37
	64QAM	1	0	20.28	20.49	20.22
		1	12	20.28	20.65	20.42
		1	24	20.39	20.60	20.33
		12	0	19.21	19.52	19.29
		12	6	19.21	19.58	19.35
		12	13	19.37	19.58	19.31
		25	0	19.26	19.57	19.34



Band/BW	Modulation	RB Size	RB Offset	Low CH 20450	Mid CH 20525	High CH 20600
				Frequency 829 MHz	Frequency 836.5 MHz	Frequency 844 MHz
5/ 10	QPSK	1	0	22.51	22.73	22.52
		1	24	22.18	22.48	22.23
		1	49	22.27	22.49	22.32
		25	0	21.29	21.56	21.32
		25	12	21.26	21.51	21.33
		25	25	21.33	21.62	21.38
		50	0	21.29	21.46	21.31
	16QAM	1	0	21.46	21.71	21.48
		1	24	21.46	21.73	21.48
		1	49	21.50	21.75	21.57
		25	0	20.27	20.49	20.30
		25	12	20.34	20.59	20.41
		25	25	20.40	20.69	20.44
		50	0	20.31	20.61	20.39
	64QAM	1	0	20.32	20.54	20.30
		1	24	20.36	20.66	20.44
		1	49	20.43	20.65	20.41
		25	0	19.27	19.54	19.32
		25	12	19.29	19.59	19.37
		25	25	19.41	19.63	19.39
		50	0	19.32	19.59	19.37



LTE BAND 26

Band/BW	Modulation	RB Size	RB Offset	Low CH 26797	Mid CH 26915	High CH 27033
				Frequency 824.7 MHz	Frequency 836.5 MHz	Frequency 848.3 MHz
26/ 1.4	QPSK	1	0	22.32	22.26	22.42
		1	2	22.35	22.25	22.40
		1	5	22.13	22.16	22.30
		3	0	22.21	22.05	22.25
		3	1	22.13	22.06	22.21
		3	3	22.15	22.17	22.32
		6	0	21.37	21.34	21.48
	16QAM	1	0	21.48	21.52	21.65
		1	2	21.79	21.79	21.93
		1	5	21.78	21.71	21.87
		3	0	21.30	21.28	21.47
		3	1	21.35	21.23	21.43
		3	3	21.30	21.37	21.46
		6	0	20.31	20.20	20.42
	64QAM	1	0	20.39	20.45	20.54
		1	2	20.26	20.16	20.26
		1	5	20.02	19.92	20.14
		3	0	20.42	20.39	20.56
		3	1	20.49	20.41	20.47
		3	3	20.37	20.34	20.57
		6	0	19.41	19.36	19.50



Band/BW	Modulation	RB Size	RB Offset	Low CH 26805	Mid CH 26915	High CH 27025
				Frequency 825.5 MHz	Frequency 836.5 MHz	Frequency 847.5 MHz
26/ 3	QPSK	1	0	22.29	22.26	22.41
		1	7	22.35	22.25	22.46
		1	14	22.16	22.12	22.31
		8	0	21.40	21.26	21.45
		8	3	21.27	21.32	21.40
		8	7	21.37	21.40	21.52
		15	0	21.32	21.34	21.41
	16QAM	1	0	21.48	21.55	21.68
		1	7	21.74	21.83	21.94
		1	14	21.78	21.70	21.87
		8	0	20.28	20.30	20.47
		8	3	20.31	20.29	20.43
		8	7	20.31	20.36	20.46
		15	0	20.27	20.21	20.42
	64QAM	1	0	20.40	20.44	20.54
		1	7	20.21	20.20	20.26
		1	14	19.96	19.98	20.13
		8	0	19.44	19.42	19.54
		8	3	19.42	19.42	19.52
		8	7	19.38	19.37	19.53
		15	0	19.36	19.40	19.54



Band/BW	Modulation	RB Size	RB Offset	Low CH 26815	Mid CH 26915	High CH 27015
				Frequency 826.5 MHz	Frequency 836.5 MHz	Frequency 846.5 MHz
26/ 5	QPSK	1	0	22.28	22.26	22.46
		1	12	22.30	22.28	22.43
		1	24	22.13	22.18	22.31
		12	0	21.36	21.30	21.46
		12	6	21.31	21.28	21.41
		12	13	21.33	21.44	21.52
		25	0	21.33	21.31	21.44
	16QAM	1	0	21.53	21.52	21.68
		1	12	21.74	21.81	21.90
		1	24	21.77	21.72	21.82
		12	0	20.34	20.29	20.50
		12	6	20.31	20.23	20.40
		12	13	20.37	20.39	20.49
		25	0	20.28	20.20	20.38
	64QAM	1	0	20.46	20.43	20.60
		1	12	20.24	20.20	20.24
		1	24	20.02	19.91	20.13
		12	0	19.40	19.43	19.53
		12	6	19.48	19.35	19.50
		12	13	19.34	19.38	19.56
		25	0	19.40	19.34	19.49



Band/BW	Modulation	RB Size	RB Offset	Low CH 26840	Mid CH 26915	High CH 26990
				Frequency 829 MHz	Frequency 836.5 MHz	Frequency 844 MHz
26/10	QPSK	1	0	22.33	22.27	22.45
		1	24	22.32	22.26	22.43
		1	49	22.19	22.12	22.34
		25	0	21.39	21.23	21.39
		25	12	21.31	21.28	21.40
		25	25	21.33	21.44	21.52
		50	0	21.34	21.31	21.44
	16QAM	1	0	21.49	21.58	21.68
		1	24	21.75	21.80	21.97
		1	49	21.72	21.76	21.83
		25	0	20.34	20.28	20.51
		25	12	20.29	20.25	20.40
		25	25	20.32	20.39	20.49
		50	0	20.28	20.20	20.39
	64QAM	1	0	20.43	20.44	20.60
		1	24	20.21	20.20	20.24
		1	49	20.02	19.91	20.09
		25	0	19.40	19.41	19.59
		25	12	19.44	19.41	19.45
		25	25	19.37	19.34	19.57
		50	0	19.38	19.37	19.53



Band/BW	Modulation	RB Size	RB Offset	Low CH 26865	Mid CH 26915	High CH 26965
				Frequency 831.5 MHz	Frequency 836.5 MHz	Frequency 841.5 MHz
26/ 15	QPSK	1	0	22.34	22.33	22.47
		1	37	22.37	22.33	22.48
		1	74	22.21	22.20	22.36
		36	0	21.44	21.31	21.47
		36	19	21.35	21.33	21.46
		36	39	21.41	21.45	21.54
		75	0	21.38	21.36	21.49
	16QAM	1	0	21.55	21.60	21.70
		1	37	21.82	21.85	21.98
		1	74	21.80	21.78	21.88
		36	0	20.36	20.36	20.52
		36	19	20.37	20.31	20.45
		36	39	20.38	20.41	20.51
		75	0	20.33	20.28	20.44
	64QAM	1	0	20.47	20.49	20.62
		1	37	20.29	20.22	20.32
		1	74	20.04	19.99	20.15
		36	0	19.48	19.47	19.61
		36	19	19.50	19.43	19.53
		36	39	19.42	19.42	19.58
		75	0	19.42	19.42	19.55



ERP POWER (dBm)

GSM

Channel	Frequency (MHz)	Conducted Power (dBm)	G _T -L _c (dB)	ERP (dBm)	ERP (mW)	Limit (W)
128	824.2	32.05	-3	26.9	489.78	7
189	836.4	32.12	-3	26.97	497.74	7
251	848.8	32.02	-3	26.87	486.41	7

REMARKS: ERP Output Power (dBm) = EIRP (dBm) -2.15(dB).

EDGE

Channel	Frequency (MHz)	Conducted Power (dBm)	G _T -L _c (dB)	ERP (dBm)	ERP (mW)	Limit (W)
128	824.2	25.71	-3	20.56	113.76	7
189	836.4	26.07	-3	20.92	123.59	7
251	848.8	25.95	-3	20.8	120.23	7

REMARKS: ERP Output Power (dBm) = EIRP (dBm) -2.15(dB).

WCDMA

Channel	Frequency (MHz)	Conducted Power (dBm)	G _T -L _c (dB)	ERP (dBm)	ERP (mW)	Limit (W)
4132	826.4	22.78	-3	17.63	57.94	7
4182	836.4	22.76	-3	17.61	57.68	7
4233	846.6	22.75	-3	17.6	57.54	7

REMARKS: ERP Output Power (dBm) = EIRP (dBm) -2.15(dB).



LTE BAND 5

CHANNEL BANDWIDTH: 1.4MHz QPSK

Channel	Frequency (MHz)	Conducted Power (dBm)	G _T -L _c (dB)	ERP (dBm)	ERP (mW)	Limit (W)
20407	824.7	22.5	-3	17.35	54.33	7
20525	836.5	22.67	-3	17.52	56.49	7
20643	848.3	22.5	-3	17.35	54.33	7

CHANNEL BANDWIDTH: 1.4MHz 16QAM

Channel	Frequency (MHz)	Conducted Power (dBm)	G _T -L _c (dB)	ERP (dBm)	ERP (mW)	Limit (W)
20407	824.7	21.42	-3	16.27	42.36	7
20525	836.5	21.73	-3	16.58	45.5	7
20643	848.3	21.52	-3	16.37	43.35	7

CHANNEL BANDWIDTH: 1.4MHz 64QAM

Channel	Frequency (MHz)	Conducted Power (dBm)	G _T -L _c (dB)	ERP (dBm)	ERP (mW)	Limit (W)
20407	824.7	20.41	-3	15.26	33.57	7
20525	836.5	20.64	-3	15.49	35.4	7
20643	848.3	20.39	-3	15.24	33.42	7

CHANNEL BANDWIDTH: 3MHz QPSK

Channel	Frequency (MHz)	Conducted Power (dBm)	G _T -L _c (dB)	ERP (dBm)	ERP (mW)	Limit (W)
20415	825.5	22.45	-3	17.3	53.7	7
20525	836.5	22.66	-3	17.51	56.36	7
20635	847.5	22.47	-3	17.32	53.95	7

CHANNEL BANDWIDTH: 3MHz 16QAM

Channel	Frequency (MHz)	Conducted Power (dBm)	G _T -L _c (dB)	ERP (dBm)	ERP (mW)	Limit (W)
20415	825.5	21.47	-3	16.32	42.85	7
20525	836.5	21.69	-3	16.54	45.08	7
20635	847.5	21.55	-3	16.4	43.65	7



CHANNEL BANDWIDTH: 3MHz 64QAM

Channel	Frequency (MHz)	Conducted Power (dBm)	G _T -L _C (dB)	ERP (dBm)	ERP (mW)	Limit (W)
20415	825.5	20.41	-3	15.26	33.57	7
20525	836.5	20.64	-3	15.49	35.4	7
20635	847.5	20.4	-3	15.25	33.5	7

CHANNEL BANDWIDTH: 5MHz QPSK

Channel	Frequency (MHz)	Conducted Power (dBm)	G _T -L _C (dB)	ERP (dBm)	ERP (mW)	Limit (W)
20425	826.5	22.47	-3	17.32	53.95	7
20525	836.5	22.68	-3	17.53	56.62	7
20625	846.5	22.47	-3	17.32	53.95	7

CHANNEL BANDWIDTH: 5MHz 16QAM

Channel	Frequency (MHz)	Conducted Power (dBm)	G _T -L _C (dB)	ERP (dBm)	ERP (mW)	Limit (W)
20425	826.5	21.43	-3	16.28	42.46	7
20525	836.5	21.71	-3	16.56	45.29	7
20625	846.5	21.55	-3	16.4	43.65	7

CHANNEL BANDWIDTH: 5MHz 64QAM

Channel	Frequency (MHz)	Conducted Power (dBm)	G _T -L _C (dB)	ERP (dBm)	ERP (mW)	Limit (W)
20425	826.5	20.39	-3	15.24	33.42	7
20525	836.5	20.65	-3	15.5	35.48	7
20625	846.5	20.42	-3	15.27	33.65	7



CHANNEL BANDWIDTH: 10MHz QPSK

Channel	Frequency (MHz)	Conducted Power (dBm)	G _{T-Lc} (dB)	ERP (dBm)	ERP (mW)	Limit (W)
20450	829.0	22.51	-3	17.36	54.45	7
20525	836.5	22.73	-3	17.58	57.28	7
20600	844.0	22.52	-3	17.37	54.58	7

CHANNEL BANDWIDTH: 10MHz 16QAM

Channel	Frequency (MHz)	Conducted Power (dBm)	G _{T-Lc} (dB)	ERP (dBm)	ERP (mW)	Limit (W)
20450	829.0	21.5	-3	16.35	43.15	7
20525	836.5	21.75	-3	16.6	45.71	7
20600	844.0	21.57	-3	16.42	43.85	7

CHANNEL BANDWIDTH: 10MHz 64QAM

Channel	Frequency (MHz)	Conducted Power (dBm)	G _{T-Lc} (dB)	ERP (dBm)	ERP (mW)	Limit (W)
20450	829.0	20.43	-3	15.28	33.73	7
20525	836.5	20.66	-3	15.51	35.56	7
20600	844.0	20.44	-3	15.29	33.81	7

REMARKS: ERP Output Power (dBm) = EIRP (dBm) -2.15(dB).



LTE BAND 26

CHANNEL BANDWIDTH: 1.4MHz QPSK

Channel	Frequency (MHz)	Conducted Power (dBm)	G _T -L _c (dB)	ERP (dBm)	ERP (mW)	Limit (W)
26797	824.7	22.35	-3	17.2	52.48	7
26915	836.5	22.26	-3	17.11	51.4	7
27033	848.3	22.42	-3	17.27	53.33	7

CHANNEL BANDWIDTH: 1.4MHz 16QAM

Channel	Frequency (MHz)	Conducted Power (dBm)	G _T -L _c (dB)	ERP (dBm)	ERP (mW)	Limit (W)
26797	824.7	21.79	-3	16.64	46.13	7
26915	836.5	21.79	-3	16.64	46.13	7
27033	848.3	21.93	-3	16.78	47.64	7

CHANNEL BANDWIDTH: 1.4MHz 64QAM

Channel	Frequency (MHz)	Conducted Power (dBm)	G _T -L _c (dB)	ERP (dBm)	ERP (mW)	Limit (W)
26797	824.7	20.49	-3	15.34	34.2	7
26915	836.5	20.45	-3	15.3	33.88	7
27033	848.3	20.57	-3	15.42	34.83	7



CHANNEL BANDWIDTH: 3MHz QPSK

Channel	Frequency (MHz)	Conducted Power (dBm)	G _{T-L_C} (dB)	ERP (dBm)	ERP (mW)	Limit (W)
26805	825.5	22.35	-3	17.2	52.48	7
26915	836.5	22.26	-3	17.11	51.4	7
27025	847.5	22.46	-3	17.31	53.83	7

CHANNEL BANDWIDTH: 3MHz 16QAM

Channel	Frequency (MHz)	Conducted Power (dBm)	G _{T-L_C} (dB)	ERP (dBm)	ERP (mW)	Limit (W)
26805	825.5	21.78	-3	16.63	46.03	7
26915	836.5	21.83	-3	16.68	46.56	7
27025	847.5	21.94	-3	16.79	47.75	7

CHANNEL BANDWIDTH: 3MHz 64QAM

Channel	Frequency (MHz)	Conducted Power (dBm)	G _{T-L_C} (dB)	ERP (dBm)	ERP (mW)	Limit (W)
26805	825.5	20.4	-3	15.25	33.5	7
26915	836.5	20.44	-3	15.29	33.81	7
27025	847.5	20.54	-3	15.39	34.59	7



CHANNEL BANDWIDTH: 5MHz QPSK

Channel	Frequency (MHz)	Conducted Power (dBm)	G _{T-L_C} (dB)	ERP (dBm)	ERP (mW)	Limit (W)
26815	826.5	22.3	-3	17.15	51.88	7
26915	836.5	22.28	-3	17.13	51.64	7
27015	846.5	22.46	-3	17.31	53.83	7

CHANNEL BANDWIDTH: 5MHz 16QAM

Channel	Frequency (MHz)	Conducted Power (dBm)	G _{T-L_C} (dB)	ERP (dBm)	ERP (mW)	Limit (W)
26815	826.5	21.77	-3	16.62	45.92	7
26915	836.5	21.81	-3	16.66	46.34	7
27015	846.5	21.9	-3	16.75	47.32	7

CHANNEL BANDWIDTH: 5MHz 64QAM

Channel	Frequency (MHz)	Conducted Power (dBm)	G _{T-L_C} (dB)	ERP (dBm)	ERP (mW)	Limit (W)
26815	826.5	20.46	-3	15.31	33.96	7
26915	836.5	20.43	-3	15.28	33.73	7
27015	846.5	20.6	-3	15.45	35.08	7



CHANNEL BANDWIDTH: 10MHz QPSK

Channel	Frequency (MHz)	Conducted Power (dBm)	G _{T-L_C} (dB)	ERP (dBm)	ERP (mW)	Limit (W)
26840	829	22.33	-3	17.18	52.24	7
26915	836.5	22.27	-3	17.12	51.52	7
26990	844	22.45	-3	17.3	53.7	7

CHANNEL BANDWIDTH: 10MHz 16QAM

Channel	Frequency (MHz)	Conducted Power (dBm)	G _{T-L_C} (dB)	ERP (dBm)	ERP (mW)	Limit (W)
26840	829	21.75	-3	16.6	45.71	7
26915	836.5	21.8	-3	16.65	46.24	7
26990	844	21.97	-3	16.82	48.08	7

CHANNEL BANDWIDTH: 10MHz 64QAM

Channel	Frequency (MHz)	Conducted Power (dBm)	G _{T-L_C} (dB)	ERP (dBm)	ERP (mW)	Limit (W)
26840	829	20.43	-3	15.28	33.73	7
26915	836.5	20.44	-3	15.29	33.81	7
26990	844	20.6	-3	15.45	35.08	7



CHANNEL BANDWIDTH: 15MHz QPSK

Channel	Frequency (MHz)	Conducted Power (dBm)	G _{T-Lc} (dB)	ERP (dBm)	ERP (mW)	Limit (W)
26865	831.5	22.37	-3	17.22	52.72	7
26915	836.5	22.33	-3	17.18	52.24	7
26965	841.5	22.48	-3	17.33	54.08	7

CHANNEL BANDWIDTH: 15MHz 16QAM

Channel	Frequency (MHz)	Conducted Power (dBm)	G _{T-Lc} (dB)	ERP (dBm)	ERP (mW)	Limit (W)
26865	831.5	21.82	-3	16.67	46.45	7
26915	836.5	21.85	-3	16.7	46.77	7
26965	841.5	21.98	-3	16.83	48.19	7

CHANNEL BANDWIDTH: 15MHz 64QAM

Channel	Frequency (MHz)	Conducted Power (dBm)	G _{T-Lc} (dB)	ERP (dBm)	ERP (mW)	Limit (W)
26865	831.5	20.47	-3	15.32	34.04	7
26915	836.5	20.49	-3	15.34	34.2	7
26965	841.5	20.62	-3	15.47	35.24	7

REMARKS: ERP Output Power (dBm) = EIRP (dBm) -2.15(dB).



3.2 FREQUENCY STABILITY MEASUREMENT

3.2.1 LIMITS OF FREQUENCY STABILITY MEASUREMENT

1.5 ppm is for base and fixed station. 2.5 ppm is for mobile station.

3.2.2 TEST PROCEDURE

- Device is placed at the oven room. The oven room could control the temperatures and humidity. Power warm up is at least 15 min and power applied should perform before recording frequency error.
- EUT is connected the external power supply to control the DC input power. The test voltage range is from minimum to maximum working voltage. Each step shall be record the frequency error rate.
- The temperature range step is 10 degrees in this test items. All temperature levels shall be hold the $\pm 0.5^{\circ}\text{C}$ during the measurement testing. The each temperature step shall be at least 0.5 hours, consider the EUT could be test under the stability condition.

NOTE: The frequency error was recorded frequency error from the communication simulator.

3.2.3 TEST SETUP

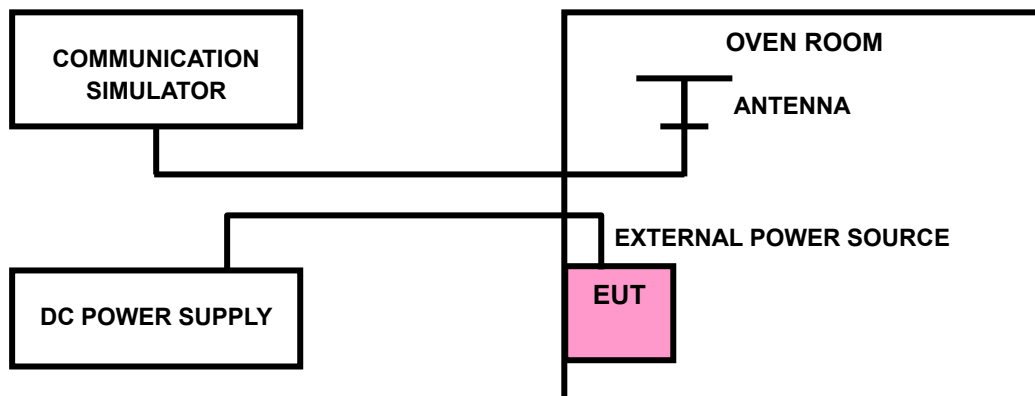



**BUREAU
VERITAS**

Test Report No.: W7L-P22110036RF04

3.2.4 TEST RESULTS

Please Refer to Appendix Of this test report.

Note: VL = Low voltage(3.6V); VN/NV = Normal voltage(3.7V); VH = High voltage(4.2V);
NT = Normal temperature (25°C)



3.3 OCCUPIED BANDWIDTH MEASUREMENT

3.3.1 LIMITS OF OCCUPIED BANDWIDTH MEASUREMENT

The width of a frequency band such that, below the lower and above the upper frequency limits, the mean powers emitted are each equal to a specified percentage 0.5 % of the total mean power of a given emission.

3.3.2 TEST SETUP

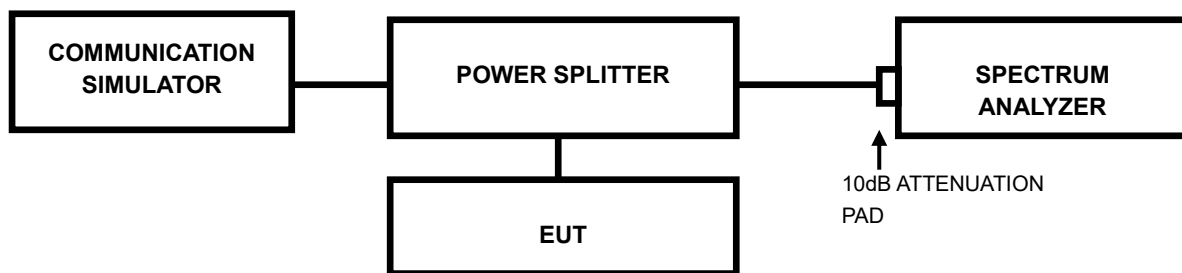

3.3.3 TEST PROCEDURES

- The conducted occupied bandwidth used the power splitter via EUT RF power connector between simulation base station and spectrum analyzer.
- Use OBW measurement function of Spectrum analyzer to measure 99 % occupied bandwidth.



BUREAU
VERITAS

Test Report No.: W7L-P22110036RF04

3.3.4 TEST RESULTS

Please Refer to Appendix Of this test report.

3.4 BAND EDGE MEASUREMENT

3.4.1 LIMITS OF BAND EDGE MEASUREMENT

Power of any emission outside of the authorized operating frequency ranges must be attenuated below the transmitting power (P) by a factor of at least $43 + 10 \log(P)$ dB. In the 1 MHz bands immediately outside and adjacent to the frequency block a resolution bandwidth of at least one percent of the emission bandwidth of the fundamental emission of the transmitter may be employed.

3.4.2 TEST SETUP

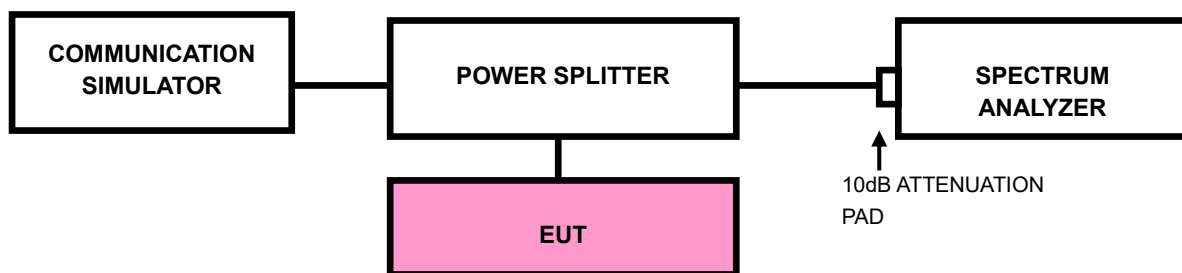



3.4.3 TEST PROCEDURES

- a) All measurements were done at low and high operational frequency range
- b) Connect the transmitter to the spectrum analyzer via coaxial cable while ensuring proper impedance matching.
- c) Tune the analyzer to the nominal center frequency of the emission bandwidth (EBW)
- d) .Set the resolution bandwidth (RBW) $\geq 1\%$ EBW in the 1MHz band immediately outside and adjacent to the band edge.
- e) Beyond the 1MHz band from the band edge, RBW=1MHz was used.
- f) Set the video bandwidth (VBW) to $\geq 3 \times$ RBW.
- g) Select the average power (RMS) display detector.
- h) Set the number of measurement points to ≥ 1001 .
- i) Use auto-coupled sweep time.
- j) Perform the measurement over an interval of time when the transmission is continuous and at its maximum power level.
- k) The RF fundamental frequency should be excluded against the limit line in the operating frequency band and use RBW is 10KHz or 100KHz.
- l) Record the max trace plot into the test report.



**BUREAU
VERITAS**

Test Report No.: W7L-P22110036RF04

3.4.4 TEST RESULTS

Please Refer to Appendix Of this test report.

3.5 CONDUCTED SPURIOUS EMISSIONS

3.5.1 LIMITS OF CONDUCTED SPURIOUS EMISSIONS MEASUREMENT

The power of any emission outside of the authorized operating frequency ranges must be attenuated below the transmitting power (P) by a factor of at least $43 + 10 \log(P)$ dB. The emission limit equal to -13dBm .

3.5.2 TEST PROCEDURE

- a. The EUT makes a phone call to the communication simulator. All measurements were done at low, middle and high operational frequency range.
- b. Measuring frequency range is from 9kHz up to a frequency including its 10th harmonic. 10dB attenuation pad is connected with spectrum. RBW=1MHz and VBW=3MHz is used for conducted emission measurement.

3.5.3 TEST SETUP

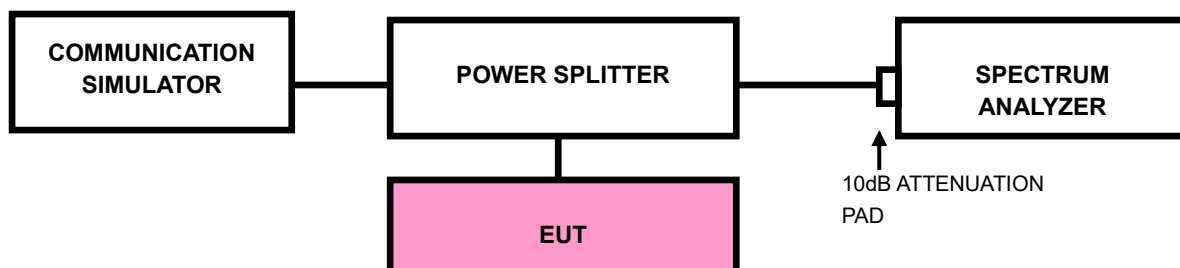



Test Report No.: W7L-P22110036RF04

3.5.4 TEST RESULTS

NOTE : The 9K~30MHz amplitude of spurious emissions attenuated more than 20 dB below the permissible value is not required in the report.

Please Refer to Appendix Of this test report.



3.6 RADIATED EMISSION MEASUREMENT

3.6.1 LIMITS OF RADIATED EMISSION MEASUREMENT

The power of any emission outside of the authorized operating frequency ranges must be attenuated below the transmitting power (P) by a factor of at least $43 + 10 \log(P)$ dB. The emission limit equal to -13dBm .

3.6.2 TEST PROCEDURES

- a. Substitution method is used for E.I.R.P measurement. In the semi-anechoic chamber, EUT placed on the 0.8m height of Turn Table, rotated the table around 360 degrees to search the maximum radiation power and receiver antenna shall be rotated vertical and horizontal polarization and moved height from 1m to 4m to find the maximum polar radiated power. The "Read Value" is the spectrum reading the maximum power value.
- b. The substitution horn antenna is substituted for EUT at the same position and signals generator export the CW signal to the substitution antenna via a TX cable. Rotated the Turn Table and moved receiving antenna to find the maximum radiation power. Adjust output power level of S.G to get a Value of spectrum reading equal to "Read Value " of step a. Record the power level of S.G
- c. $\text{EIRP} = \text{Output power level of S.G} - \text{TX cable loss} + \text{Antenna gain of substitution horn.}$
- d. E.R.P power can be calculated form E.I.R.P power by subtracting the gain of dipole,
 $\text{E.R.P power} = \text{E.I.P.R power} - 2.15\text{dBi.}$

NOTE: The resolution bandwidth and video bandwidth of test receiver/spectrum analyzer is 1MHz/3MHz.

3.6.3 DEVIATION FROM TEST STANDARD

No deviation



3.6.4 TEST SETUP

< Frequency Range below 30MHz >

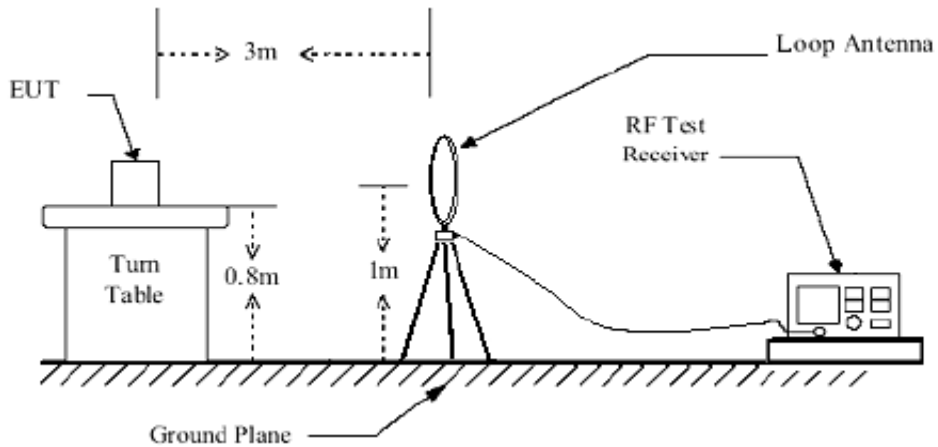

< Frequency Range 30MHz~1GHz >

