



TEST REPORT

No.B20N00421-SAR

For

i.safe MOBILE GmbH

LTE SMARTPHONE

Model Name: M53A01

With

Hardware Version: V1.00

Software Version: IS530_EEA_1.0.0.0.0_1_20200331

FCC ID: 2AACZ-M53A01

Issued Date: 2020-06-13

Note:

The test results in this test report relate only to the devices specified in this report. This report shall not be reproduced except in full without the written approval of SAICT.

Test Laboratory:

SAICT, Shenzhen Academy of Information and Communications Technology

Building G, Shenzhen International Innovation Center, No.1006 Shennan Road, Futian District, Shenzhen, Guangdong, P. R. China 518026.

Tel: +86(0)755-33322000, Fax: +86(0)755-33322001

Email: yewu@caict.ac.cn, www.saict.ac.cn



No. B20N00421-SAR

REPORT HISTORY

Report Number	Revision	Description	Issue Date
B20N00421-SAR	Rev.0	1st edition	2020-06-13



TABLE OF CONTENT

1. SUMMARY OF TEST REPORT	5
1.1. TEST ITEMS	5
1.2. TEST STANDARDS	5
1.3. TEST RESULT	5
1.4. TESTING LOCATION	5
1.5. PROJECT DATA	5
1.6. SIGNATURE	5
2. STATEMENT OF COMPLIANCE	6
3. CLIENT INFORMATION	10
3.1. APPLICANT INFORMATION.....	10
3.2. MANUFACTURER INFORMATION	10
4. EQUIPMENT UNDER TEST (EUT) AND ANCILLARY EQUIPMENT (AE)	11
4.1. ABOUT EUT	11
4.2. INTERNAL IDENTIFICATION OF EUT USED DURING THE TEST	12
4.3. INTERNAL IDENTIFICATION OF AE USED DURING THE TEST.....	12
5. TEST METHODOLOGY	13
5.1. APPLICABLE LIMIT REGULATIONS.....	13
5.2. APPLICABLE MEASUREMENT STANDARDS	13
6. SPECIFIC ABSORPTION RATE (SAR).....	14
6.1. INTRODUCTION.....	14
6.2. SAR DEFINITION.....	14
7. TISSUE SIMULATING LIQUIDS	15
7.1. TARGETS FOR TISSUE SIMULATING LIQUID	15
7.2. DIELECTRIC PERFORMANCE	15
8. SYSTEM VERIFICATION	20
8.1. SYSTEM SETUP.....	20
8.2. SYSTEM VERIFICATION	21
9. MEASUREMENT PROCEDURES	22
9.1. TESTS TO BE PERFORMED.....	22
9.2. GENERAL MEASUREMENT PROCEDURE	24
9.3. WCDMA MEASUREMENT PROCEDURES FOR SAR	25
9.4. BLUETOOTH & WLAN MEASUREMENT PROCEDURES FOR SAR.....	26
9.5. LTE MEASUREMENT PROCEDURES FOR SAR.....	26
9.6. LTE (TDD) CONSIDERATIONS.....	27
9.7. POWER DRIFT.....	28
10. CONDUCTED OUTPUT POWER	29
10.1. GSM MEASUREMENT RESULT	29
10.2. WCDMA MEASUREMENT RESULT	31
10.3. LTE MEASUREMENT RESULT.....	33
10.4. WLAN AND BT MEASUREMENT RESULT	86
11. SIMULTANEOUS TX SAR CONSIDERATIONS.....	88



11.1. INTRODUCTION.....	88
11.2. TRANSMIT ANTENNA SEPARATION DISTANCES.....	88
11.3. SAR MEASUREMENT POSITIONS.....	89
11.4. STANDALONE SAR TEST EXCLUSION CONSIDERATIONS.....	89
12. EVALUATION OF SIMULTANEOUS.....	90
13. SUMMARY OF TEST RESULTS.....	91
13.1. SAR RESULTS.....	92
13.2. WLAN EVALUATION FOR 2.4G.....	107
13.3. WLAN EVALUATION FOR 5G.....	109
14. SAR MEASUREMENT VARIABILITY.....	111
15. MEASUREMENT UNCERTAINTY.....	112
15.1. MEASUREMENT UNCERTAINTY FOR NORMAL SAR TESTS (300MHZ~3GHZ).....	112
15.2. MEASUREMENT UNCERTAINTY FOR NORMAL SAR TESTS (3GHZ~6GHZ).....	113
16. MAIN TEST INSTRUMENTS.....	114
ANNEX A: GRAPH RESULTS.....	115
ANNEX B: SYSTEMVERIFICATION RESULTS.....	149
ANNEX C: SAR MEASUREMENT SETUP.....	159
C.1. MEASUREMENT SET-UP.....	159
C.2. DASY5 E-FIELD PROBE SYSTEM.....	160
C.3. E-FIELD PROBE CALIBRATION.....	161
C.4. OTHER TEST EQUIPMENT.....	162
ANNEX D: POSITION OF THE WIRELESS DEVICE IN RELATION TO THE PHANTOM.....	166
D.1. GENERAL CONSIDERATIONS.....	166
D.2. BODY-WORN DEVICE.....	167
D.3. DESKTOP DEVICE.....	167
D.4. DUT SETUP PHOTOS.....	168
ANNEX E: EQUIVALENT MEDIA RECIPES.....	169
ANNEX F: SYSTEM VALIDATION.....	170
ANNEX G: DAE CALIBRATION CERTIFICATE.....	171
ANNEX H: PROBE CALIBRATION CERTIFICATE.....	174
ANNEX I: DIPOLE CALIBRATION CERTIFICATE.....	184
ANNEX J: EXTENDED CALIBRATION SAR DIPOLE.....	254
ANNEX K: ACCREDITATION CERTIFICATE.....	256



No. B20N00421-SAR

1. Summary of Test Report

1.1. Test Items

Description: LTE SMARTPHONE
Model Name: M53A01
Applicant's name: i.safe MOBILE GmbH
Manufacturer's Name: i.safe MOBILE GmbH

1.2. Test Standards

ANSI C95.1-1992, IEEE 1528-2013

1.3. Test Result

Pass. Please refer to "13. Summary of Test Results"

1.4. Testing Location

Address: Building G, Shenzhen International Innovation Center, No.1006 Shennan Road, Futian District, Shenzhen, Guangdong, P. R. China

1.5. Project Data

Testing Start Date: 2020-04-23

Testing End Date: 2020-06-01

1.6. Signature

Li yongfu

(Prepared this test report)

Zhang Yunzhan

(Reviewed this test report)

Cao Junfei

(Approved this test report)

2. Statement of Compliance

The maximum results of Specific Absorption Rate (SAR) found during testing for i.safe MOBILE GmbH LTE SMARTPHONE M53A01 are as follows:

Table 2.1: Highest Reported SAR for Head (1g)

Exposure Configuration	Technology Band	Highest Reported SAR 1g(W/Kg)	Equipment Class
Head	GSM850	0.79	PCE
	PCS1900	0.57	
	WCDMA Band 2	0.77	
	WCDMA Band 4	0.60	
	WCDMA Band 5	0.48	
	LTE Band 5	0.60	
	LTE Band 7	0.49	
	LTE Band 12	0.30	
	LTE Band 13	0.47	
	LTE Band 14	0.50	
	LTE Band 25	0.79	
	LTE Band 26	0.55	
	LTE Band 30	0.49	
	LTE Band 41	0.60	
	LTE Band 66	0.76	
	WLAN 2.4GHz	1.08	
	WLAN 5GHz	0.61	NII



Table 2.2: Highest Reported SAR for Hotspot (1g)

Exposure Configuration	Technology Band	Highest Reported SAR 1g(W/Kg)	Equipment Class
Hotspot	GSM850	0.60	PCE
	PCS1900	0.38	
	WCDMA Band 2	0.67	
	WCDMA Band 4	0.75	
	WCDMA Band 5	0.40	
	LTE Band 5	0.36	
	LTE Band 7	0.51	
	LTE Band 12	0.30	
	LTE Band 13	0.42	
	LTE Band 14	0.50	
	LTE Band 25	0.34	
	LTE Band 26	0.46	
	LTE Band 30	0.74	
	LTE Band 41	0.57	
	LTE Band 66	0.63	
	WLAN 2.4GHz	0.29	DTS
	WLAN 5GHz	0.34	NII

Table 2.3: Highest Reported SAR for Body-worn (1g)

Exposure Configuration	Technology Band	Highest Reported SAR 1g(W/Kg)	Equipment Class
Body-worn	GSM850	0.60	PCE
	PCS1900	0.38	
	WCDMA Band 2	0.67	
	WCDMA Band 4	0.75	
	WCDMA Band 5	0.40	
	LTE Band 5	0.36	
	LTE Band 7	0.57	
	LTE Band 12	0.30	
	LTE Band 13	0.42	
	LTE Band 14	0.50	
	LTE Band 25	0.34	
	LTE Band 26	0.46	
	LTE Band 30	0.74	
	LTE Band 41	0.49	
	LTE Band 66	0.63	
	WLAN 2.4GHz	0.29	DTS
	WLAN 5GHz	0.34	NII

The SAR values found for the Mobile Phone are below the maximum recommended levels of 1.6 W/Kg as averaged over any 1g tissue according to the ANSI C95.1-1992.

The EUT battery must be fully charged and checked periodically during the test to ascertain uniform power output.

The measurement together with the test system set-up is described in annex C of this test report. A detailed description of the equipment under test can be found in chapter 4 of this test report.

The highest reported SAR value is obtained at the case of **(Table 2.1 & 2.2 & 2.3)**, and the value is: **1.08 W/kg (1g)**.

Table2.4: The sum of reported SAR values for main antenna and WLAN

/	Position	Main Antenna (W/kg)	WLAN (W/kg)	Sum (W/kg)
Highest reported SAR value for Head	Left Touch	0.51	1.08	1.59
Highest reported SAR value for Hotspot	Front Side	0.75	0.29	1.04
Highest reported SAR value for Body-worn	Front Side	0.75	0.29	1.04

Note: the test positions of above tables are for the worse case that has been evaluated.

Table2.5: The sum of reported SAR values for main antenna and Bluetooth

/	Position	Main Antenna (W/kg)	Bluetooth (W/kg)	Sum (W/kg)
Highest reported SAR value for Head	Right Touch	0.79	0.29	1.08
Highest reported SAR value for Hotspot	Front Side	0.75	0.15	0.90
Highest reported SAR value for Body-worn	Front Side	0.75	0.15	0.90

Note: the test positions of above tables are for the worse case that has been evaluated.

According to the above tables, the highest sum of reported SAR values is **1.59 W/kg (1g)**.

The detail for simultaneous transmission consideration is described in chapter 12.



3. Client Information

3.1. Applicant Information

Company Name:	i.safe MOBILE GmbH
Address:	i_Park Tauberfranken 10 97922 Lauda-Koenigshofen Germany
City:	/
Country:	/
Telephone:	+491703719004

3.2. Manufacturer Information

Company Name:	i.safe MOBILE GmbH
Address /Post:	i_Park Tauberfranken 10 97922 Lauda-Koenigshofen Germany
City:	/
Country:	/
Telephone:	+491703719004

4. Equipment under Test (EUT) and Ancillary Equipment (AE)

4.1. About EUT

Description:	LTE SMARTPHONE
Model Name:	M53A01
Marketing Name:	IS530
Condition of EUT as received	No obvious damage in appearance
Operating mode(s):	GSM 850/1900, WCDMA Band 2/4/5, LTE Band 2/4/5/7/12/13/14/17/25/26/30/38/41/66, Bluetooth, WLAN 2.4G/5G
Tx Frequency:	825 – 848.8MHz (GSM 850)
	1850.2 – 1910MHz (GSM 1900)
	1852.4 – 1907.6MHz (WCDMA Band 2)
	1712.4 – 1752.6MHz (WCDMA Band 4)
	826.4 – 846.6MHz (WCDMA Band 5)
	1850.7 – 1909.3MHz (LTE Band 2)
	1710.7 – 1754.3MHz (LTE Band 4)
	824.7 – 848.3MHz (LTE Band 5)
	2502.5 – 2567.5MHz (LTE Band 7)
	699.7 – 715.3MHz (LTE Band 12)
	779.5 – 784.5MHz (LTE Band 13)
	788 – 798MHz (LTE Band 14)
	704 – 716MHz (LTE Band 17)
	1850.7 – 1914.3MHz (LTE Band 25)
	814.7 – 848.3MHz (LTE Band 26)
	2307.5 – 2312.5MHz (LTE Band 30)
	2572.5 – 2617.5MHz (LTE Band 38)
	2498.5 – 2687.5MHz (LTE Band 41)
	1710.7 – 1779.3MHz (LTE Band 66)
2412 – 2462MHz (WLAN 2.4G)	
5180 – 5825MHz (WLAN 5G)	
2402 – 2480MHz (Bluetooth)	
GPRS / EGPRS Multislot Class:	33
GPRS capability Class:	B
Test device Production information:	Production unit
Device type:	Portable device
Antenna type:	Integrated antenna
Hotspot mode:	Support
Product Dimensions:	Long 154mm ;Wide 79mm ; Overall Diagonal 159mm
Remark:	
1. This device does not support DTM operation.	



4.2. Internal Identification of EUT used during the test

EUT ID*	IMEI	HW Version	SW Version
UT13aa	358121101505925	V1.00	IS530_EEA_1.0.0.0.0_1_20200331
UT15aa	358121101505446	V1.00	IS530_EEA_1.0.0.0.0_1_20200331

*EUT ID: is used to identify the test sample in the lab internally.

Note: It is performed to test SAR with the UT15aa, and conducted power with the UT13aa.

4.3. Internal Identification of AE used during the test

AE ID*	Description	Type	Manufacturer
AE1	Battery	MBP53A01	FPR Connectivity Technology Inc.
AE2	Headset	AC-4035-M6	SHENZHEN CXD SCIENCE & TECHNOLOGY CO., LTD.

*AE ID: is used to identify the test sample in the lab internally.

5. Test Methodology

5.1. Applicable Limit Regulations

ANSI C95.1–1992: IEEE Standard for Safety Levels with Respect to Human Exposure to Radio Frequency Electromagnetic Fields, 3 kHz to 300 GHz.

It specifies the maximum exposure limit of **1.6 W/kg** as averaged over any 1 gram of tissue for portable devices being used within 20 cm of the user in the uncontrolled environment.

5.2. Applicable Measurement Standards

IEEE 1528–2013: Recommended Practice for Determining the Peak Spatial-Average Specific Absorption Rate (SAR) in the Human Head from Wireless Communications Devices: Experimental Techniques.

KDB 447498 D01 General RF Exposure Guidance v06: Mobile and Portable Devices RF Exposure Procedures and Equipment Authorization Policies.

KDB 648474 D04 Handset SAR v01r03: SAR Evaluation Considerations for Wireless Handsets.

KDB 941225 D01 SAR test for 3G devices v03r01: SAR Measurement Procedures for 3G Devices

KDB 941225 D05 SAR for LTE Devices v02r05: SAR Evaluation Considerations for LTE Devices

KDB 941225 D06 Hot Spot SAR v02r01: SAR Evaluation Procedures for Portable Devices with Wireless Router Capabilities

KDB 248227 D01 802.11 Wi-Fi SAR v02r02: SAR Guidance for IEEE 802.11 (Wi-Fi) Transmitters.

KDB 865664 D01 SAR measurement 100 MHz to 6 GHz v01r04: SAR Measurement Requirements for 100 MHz to 6 GHz.

KDB 865664 D02 RF Exposure Reporting v01r02: RF Exposure Compliance Reporting and Documentation Considerations

KDB 941225 D05A LTE Rel.10 KDB Inquiry Sheet v01r02: REL. 10 LTE SAR TEST GUIDANCE AND KDB INQUIRIES

TCB workshop November 2017; RF Exposure Procedures (LTE UL/DL Carrier Aggregation SAR)

TCB workshop April 2019; RF Exposure Procedures (Tissue Simulating Liquids)

6. Specific Absorption Rate (SAR)

6.1. Introduction

SAR is related to the rate at which energy is absorbed per unit mass in an object exposed to a radio field. The SAR distribution in a biological body is complicated and is usually carried out by experimental techniques or numerical modeling. The standard recommends limits for two tiers of groups, occupational/controlled and general population/uncontrolled, based on a person's awareness and ability to exercise control over his or her exposure. In general, occupational/controlled exposure limits are higher than the limits for general population/uncontrolled.

6.2. SAR Definition

The SAR definition is the time derivative (rate) of the incremental energy (dW) absorbed by (dissipated in) an incremental mass (dm) contained in a volume element (dv) of a given density (ρ). The equation description is as below:

$$SAR = \frac{d}{dt} \left(\frac{dW}{dm} \right) = \frac{d}{dt} \left(\frac{dW}{\rho dv} \right)$$

SAR is expressed in units of Watts per kilogram (W/kg)

SAR measurement can be either related to the temperature elevation in tissue by

$$SAR = c \left(\frac{\delta T}{\delta t} \right)$$

Where: C is the specific heat capacity, δT is the temperature rise and δt is the exposure duration, or related to the electrical field in the tissue by

$$SAR = \frac{\sigma |E|^2}{\rho}$$

Where: σ is the conductivity of the tissue, ρ is the mass density of tissue and E is the RMS electrical field strength.

However for evaluating SAR of low power transmitter, electrical field measurement is typically applied.

7. Tissue Simulating Liquids

7.1. Targets for tissue simulating liquid

Table 7.1: Targets for tissue simulating liquid

Frequency (MHz)	Liquid Type	Conductivity (σ)	$\pm 5\%$ Range	Permittivity (ϵ)	$\pm 5\%$ Range
750	Head	0.89	0.85~0.93	41.9	39.8~44.0
835	Head	0.90	0.86~0.95	41.5	39.4~43.6
1750	Head	1.37	1.30~1.44	40.1	38.1~42.1
1900	Head	1.40	1.33~1.47	40.0	38.0~42.0
2300	Head	1.67	1.57~1.75	39.5	37.5~41.4
2450	Head	1.80	1.71~1.89	39.2	37.2~41.2
2550	Head	1.91	1.81~2.01	39.1	37.1~41.0
5250	Head	4.71	4.47~4.95	35.9	34.1~37.7
5600	Head	5.07	4.82~5.32	35.5	33.8~37.3
5750	Head	5.22	4.96~5.48	35.4	33.6~37.1

7.2. Dielectric Performance

Table 7.2: Dielectric Performance of Tissue Simulating Liquid

Measurement Date (yyyy-mm-dd)	Type	Frequency	Conductivity σ (S/m)	Drift (%)	Permittivity ϵ	Drift (%)
2020-04-25	Head	750	0.884	-0.67	42.46	1.34
2020-04-23	Head	835	0.891	-1.00	41.97	1.13
2020-04-29	Head	1750	1.386	1.17	39.33	-1.92
2020-05-01	Head	1900	1.422	1.57	39.02	-2.45
2020-05-02	Head	2300	1.648	-1.32	39.94	1.11
2020-05-05	Head	2450	1.845	2.50	38.75	-1.15
2020-06-01	Head	2550	1.939	1.52	38.08	-2.61
2020-05-06	Head	5250	4.661	-1.04	36.49	1.64
2020-05-06	Head	5600	5.134	1.26	34.55	-2.68
2020-05-06	Head	5750	5.157	-1.21	36.42	2.88

Note: The liquid temperature is 22.0°C.

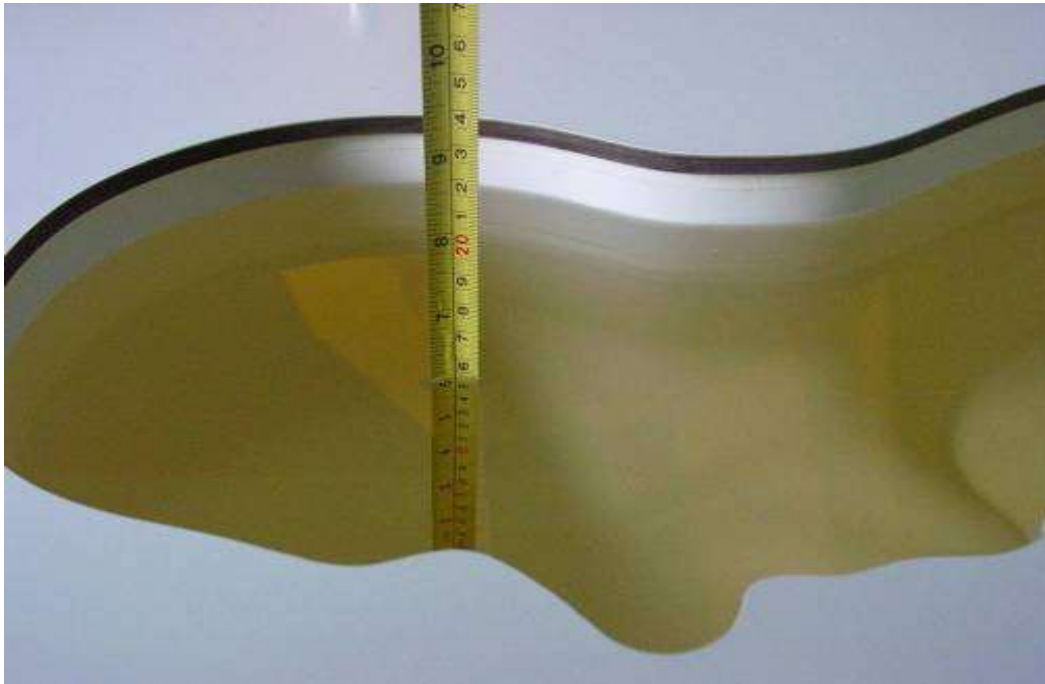

Picture 7-1: Liquid depth in the Head Phantom (750MHz)

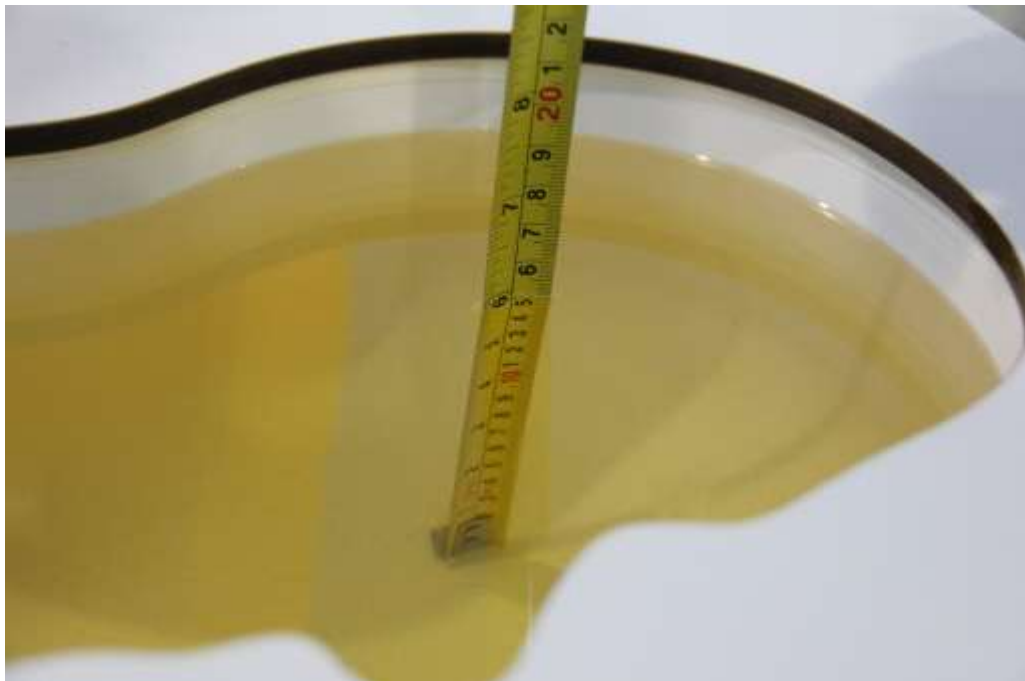

Picture 7-2: Liquid depth in the Head Phantom (835MHz)



Picture 7-3: Liquid depth in the Head Phantom (1750MHz)



Picture 7-4: Liquid depth in the Head Phantom (1900MHz)



Picture 7-5: Liquid depth in the Head Phantom (2300MHz)



Picture 7-6: Liquid depth in the Head Phantom(2450MHz)



Picture 7-7: Liquid depth in the Head Phantom(2550MHz)



Picture 7-8: Liquid depth in the Head Phantom(5GHz)

8. System verification

8.1. System Setup

In the simplified setup for system evaluation, the DUT is replaced by a calibrated dipole and the power source is replaced by a continuous wave that comes from a signal generator. The calibrated dipole must be placed beneath the flat phantom section of the SAM twin phantom with the correct distance holder. The distance holder should touch the phantom surface with a light pressure at the reference marking and be oriented parallel to the long side of the phantom. The equipment setup is shown below:

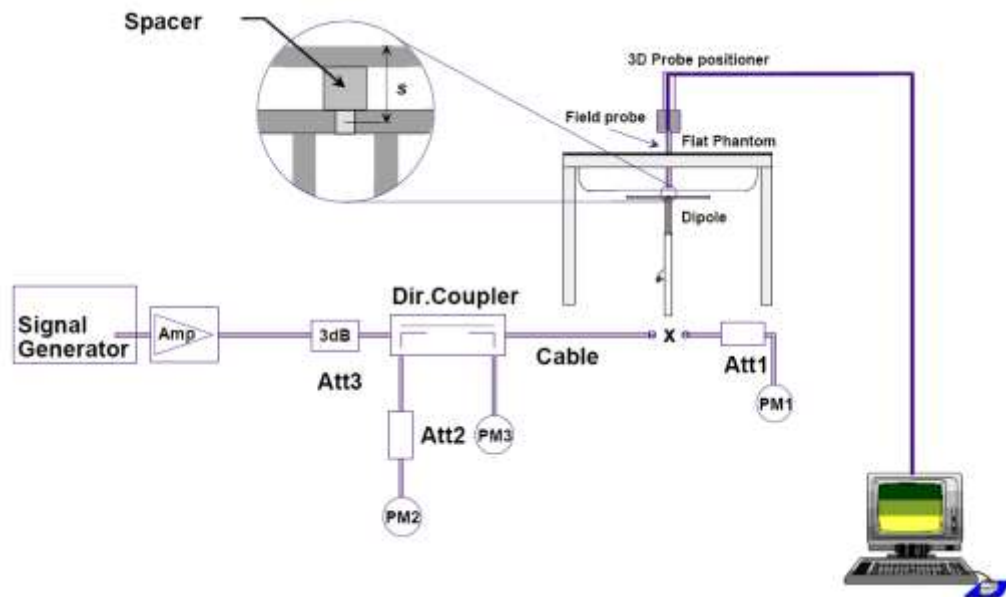

Picture 8.1 System Setup for System Evaluation

For the dipole below 3GHz, the output power on dipole port must be calibrated to 24 dBm (250mW) before dipole is connected.

For the dipole above 3GHz, the output power on dipole port must be calibrated to 20 dBm (100mW) before dipole is connected.



Picture 8.2 Photo of Dipole Setup

8.2. System Verification

SAR system verification is required to confirm measurement accuracy, according to the tissue dielectric media, probe calibration points and other system operating parameters required for measuring the SAR of a test device. The system verification must be performed for each frequency band and within the valid range of each probe calibration point required for testing the device.

Table 8.1: System Verification of Head

Measurement Date (yyyy-mm-dd)	Frequency	Target value (W/kg)		Measured value (W/kg)		Deviation (%)	
		10 g Average	1 g Average	10 g Average	1 g Average	10 g Average	1 g Average
2020-04-25	750 MHz	5.70	8.53	5.64	8.28	-1.05	-2.93
2020-04-23	835 MHz	6.29	9.62	6.20	9.32	-1.43	-3.12
2020-04-29	1750 MHz	19.30	36.40	19.72	37.80	2.18	3.85
2020-05-01	1900 MHz	21.00	40.50	21.52	42.40	2.48	4.69
2020-05-02	2300 MHz	23.70	49.10	23.08	46.80	-2.62	-4.68
2020-05-05	2450 MHz	24.10	52.00	24.72	54.00	2.57	3.85
2020-06-01	2550 MHz	26.50	57.80	26.96	59.20	1.74	2.42
2020-05-06	5250 MHz	22.30	78.00	22.00	76.20	-1.35	-2.31
2020-05-06	5600 MHz	22.70	79.50	23.20	82.60	2.20	3.90
2020-05-06	5750 MHz	22.20	78.40	21.60	74.60	-2.70	-4.85

9. Measurement Procedures

9.1. Tests to be performed

In order to determine the highest value of the peak spatial-average SAR of a handset, all device positions, configurations and operational modes shall be tested for each frequency band according to steps 1 to 3 below. A flowchart of the test process is shown in picture 9.1.

Step 1: The tests described in 9.2 shall be performed at the channel that is closest to the center of the transmit frequency band (f_c) for:

- a) all device positions (cheek and tilt, for both left and right sides of the SAM phantom, as described in annex D),
- b) all configurations for each device position in a), e.g., antenna extended and retracted, and
- c) all operational modes, e.g., analogue and digital, for each device position in a) and configuration in b) in each frequency band.

If more than three frequencies need to be tested according to 11.1 (i.e., $N_c > 3$), then all frequencies, configurations and modes shall be tested for all of the above test conditions.

Step 2: For the condition providing highest peak spatial-average SAR determined in Step 1, perform all tests described in 9.2 at all other test frequencies, i.e., lowest and highest frequencies. In addition, for all other conditions (device position, configuration and operational mode) where the peak spatial-average SAR value determined in Step 1 is within 3 dB of the applicable SAR limit, it is recommended that all other test frequencies shall be tested as well.

Step 3: Examine all data to determine the highest value of the peak spatial-average SAR found in Steps 1 to 2.

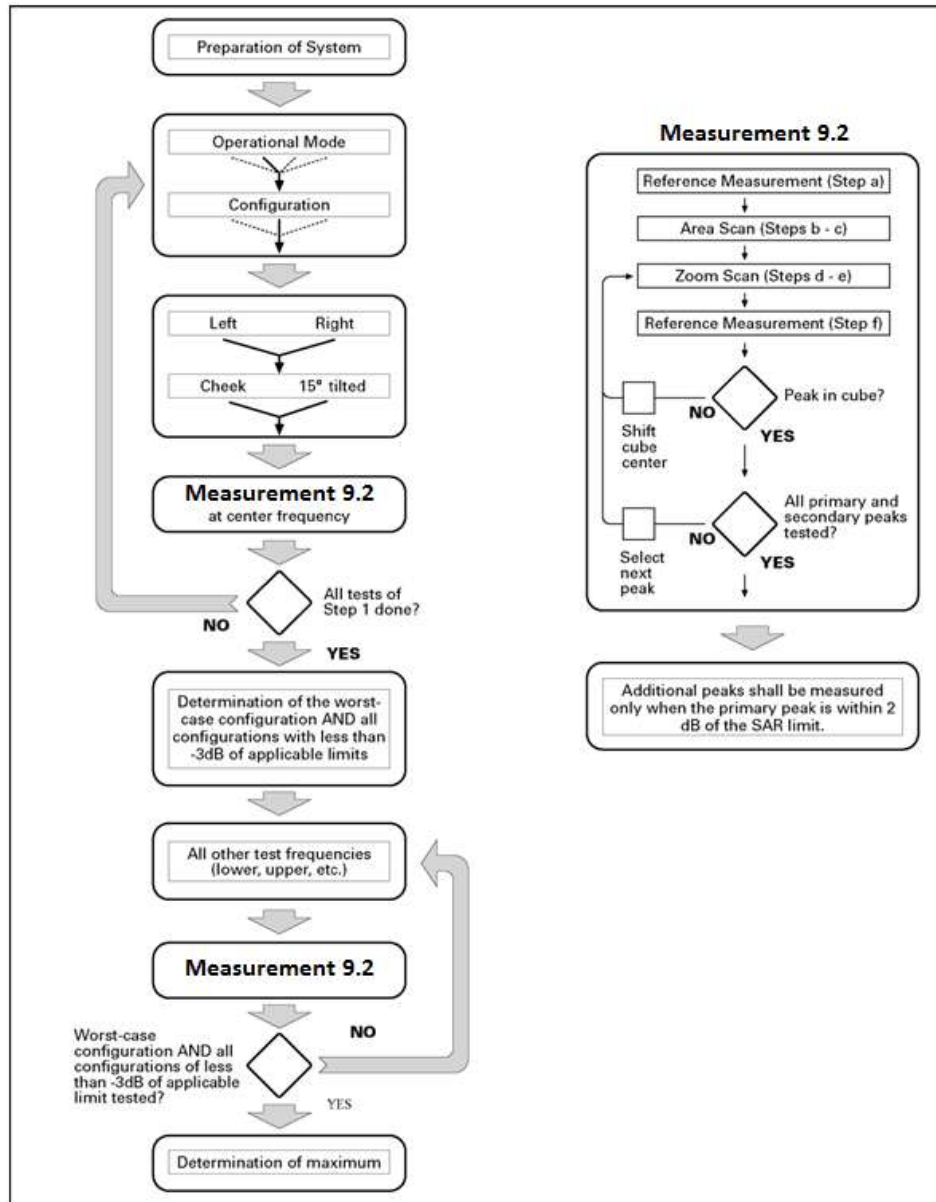

Picture 9.1 Block diagram of the tests to be performed

9.2. General Measurement Procedure

The area and zoom scan resolutions specified in the table below must be applied to the SAR measurements and fully documented in SAR reports to qualify for TCB approval. Probe boundary effect error compensation is required for measurements with the probe tip closer than half a probe tip diameter to the phantom surface. Both the probe tip diameter and sensor offset distance must satisfy measurement protocols; to ensure probe boundary effect errors are minimized and the higher fields closest to the phantom surface can be correctly measured and extrapolated to the phantom surface for computing 1-g SAR. Tolerances of the post-processing algorithms must be verified by the test laboratory for the scan resolutions used in the SAR measurements, according to the reference distribution functions specified in IEEE Std 1528-2013. The results should be documented as part of the system validation records and may be requested to support test results when all the measurement parameters in the following table are not satisfied.

		≤ 3 GHz	> 3 GHz
Maximum distance from closest measurement point (geometric center of probe sensors) to phantom surface		5 ± 1 mm	$\frac{1}{2} \cdot \delta \cdot \ln(2) \pm 0.5$ mm
Maximum probe angle from probe axis to phantom surface normal at the measurement location		$30^\circ \pm 1^\circ$	$20^\circ \pm 1^\circ$
Maximum area scan spatial resolution: $\Delta x_{Area}, \Delta y_{Area}$		≤ 2 GHz: ≤ 15 mm 2 – 3 GHz: ≤ 12 mm	3 – 4 GHz: ≤ 12 mm 4 – 6 GHz: ≤ 10 mm
		When the x or y dimension of the test device, in the measurement plane orientation, is smaller than the above, the measurement resolution must be \leq the corresponding x or y dimension of the test device with at least one measurement point on the test device.	
Maximum zoom scan spatial resolution: $\Delta x_{Zoom}, \Delta y_{Zoom}$		≤ 2 GHz: ≤ 8 mm 2 – 3 GHz: ≤ 5 mm*	3 – 4 GHz: ≤ 5 mm* 4 – 6 GHz: ≤ 4 mm*
Maximum zoom scan spatial resolution, normal to phantom surface	uniform grid: $\Delta z_{Zoom}(n)$	≤ 5 mm	3 – 4 GHz: ≤ 4 mm 4 – 5 GHz: ≤ 3 mm 5 – 6 GHz: ≤ 2 mm
	graded grid $\Delta z_{Zoom}(1)$: between 1 st two points closest to phantom surface	≤ 4 mm	3 – 4 GHz: ≤ 3 mm 4 – 5 GHz: ≤ 2.5 mm 5 – 6 GHz: ≤ 2 mm
	$\Delta z_{Zoom}(n>1)$: between subsequent points	$\leq 1.5 \cdot \Delta z_{Zoom}(n-1)$	
Minimum zoom scan volume	x, y, z	≥ 30 mm	3 – 4 GHz: ≥ 28 mm 4 – 5 GHz: ≥ 25 mm 5 – 6 GHz: ≥ 22 mm
Note: δ is the penetration depth of a plane-wave at normal incidence to the tissue medium; see draft standard IEEE P1528-2011 for details. * When zoom scan is required and the <i>reported</i> SAR from the area scan based <i>1-g SAR estimation</i> procedures of KDB 447498 is ≤ 1.4 W/kg, ≤ 8 mm, ≤ 7 mm and ≤ 5 mm zoom scan resolution may be applied, respectively, for 2 GHz to 3 GHz, 3 GHz to 4 GHz and 4 GHz to 6 GHz.			

9.3. WCDMA Measurement Procedures for SAR

The following procedures are applicable to WCDMA handsets operating under 3GPP Release99, Release 5 and Release 6. The default test configuration is to measure SAR with an established radio link between the DUT and a communication test set using a 12.2kbps RMC (reference measurement channel) configured in Test Loop Mode 1. SAR is selectively confirmed for other physical channel configurations (DPCCH & DPDCH_n), HSDPA and HSPA (HSUPA/HSDPA) modes according to output power, exposure conditions and device operating capabilities. Both uplink and downlink should be configured with the same RMC or AMR, when required. SAR for Release 5 HSDPA and Release 6 HSPA are measured using the applicable FRC (fixed reference channel) and E-DCH reference channel configurations. Maximum output power is verified according to applicable versions of 3GPP TS 34.121 and SAR must be measured according to these maximum output conditions. When Maximum Power Reduction (MPR) is not implemented according to Cubic Metric (CM) requirements for Release 6 HSPA, the following procedures do not apply.

For Release 5 HSDPA Data Devices:

Sub-test	β_c	β_d	β_d (SF)	β_c / β_d	β_{hs}	CM/dB
1	2/15	15/15	64	2/15	4/15	0.0
2	12/15	15/15	64	12/15	24/25	1.0
3	15/15	8/15	64	15/8	30/15	1.5
4	15/15	4/15	64	15/4	30/15	1.5

For Release 6 HSPA Data Devices

Sub-test	β_c	β_d	β_d (SF)	β_c / β_d	β_{hs}	β_{ec}	β_{ed}	β_{ed} (SF)	β_{ed} (codes)	CM (dB)	MPR (dB)	AG Index	E-TFCI
1	11/15	15/15	64	11/15	22/15	209/225	1039/225	4	1	1.0	0.0	20	75
2	6/15	15/15	64	6/15	12/15	12/15	12/15	4	1	3.0	2.0	12	67
3	15/15	9/15	64	15/9	30/15	30/15	$\beta_{ed1}:47/15$ $\beta_{ed2}:47/15$	4	2	2.0	1.0	15	92
4	2/15	15/15	64	2/15	4/15	4/15	56/75	4	1	3.0	2.0	17	71
5	15/15	15/15	64	15/15	24/15	30/15	134/15	4	1	1.0	0.0	21	81

9.4. Bluetooth & WLAN Measurement Procedures for SAR

Normal network operating configurations are not suitable for measuring the SAR of 802.11 transmitters in general. Unpredictable fluctuations in network traffic and antenna diversity conditions can introduce undesirable variations in SAR results. The SAR for these devices should be measured using chipset based test mode software to ensure that the results are consistent and reliable.

Chipset based test mode software is hardware dependent and generally varies among manufacturers. The device operating parameters established in a test mode for SAR measurements must be identical to those programmed in production units, including output power levels, amplifier gain settings and other RF performance tuning parameters. The test frequencies should correspond to actual channel frequencies defined for domestic use. SAR for devices with switched diversity should be measured with only one antenna transmitting at a time during each SAR measurement, according to a fixed modulation and data rate. The same data pattern should be used for all measurements.

9.5. LTE Measurement Procedures for SAR

SAR tests for LTE are performed with a base station simulator, Anristu MT8820C. Closed loop power control was used so the UE transmits with maximum output power during SAR testing. All powers were measured with the Anristu MT8820C. It is performed for conducted power and SAR based on the KDB941225 D05.

SAR is evaluated separately according to the following procedures for the different test positions in each exposure condition – head, body, body-worn accessories and other use conditions. The procedures in the following subsections are applied separately to test each LTE frequency band.

1) QPSK with 1 RB allocation

Start with the largest channel bandwidth and measure SAR for QPSK with 1 RB allocation, using the RB offset and required test channel combination with the highest maximum output power among RB offsets at the upper edge, middle and lower edge of each required test channel. When the reported SAR is ≤ 0.8 W/kg, testing of the remaining RB offset configurations and required test channels is not required for 1 RB allocation; otherwise, SAR is required for the remaining required test channels and only for the RB offset configuration with the highest output power for that channel. When the reported SAR of a required test channel is > 1.45 W/kg, SAR is required for all three RB offset configurations for that required test channel.

2) QPSK with 50% RB allocation

The procedures required for 1 RB allocation in 1) are applied to measure the SAR for QPSK with 50% RB allocation.

3) QPSK with 100% RB allocation

For QPSK with 100% RB allocation, SAR is not required when the highest maximum output power for 100% RB allocation is less than the highest maximum output power in 50% and 1 RB allocations and the highest reported SAR for 1 RB and 50% RB allocation in 1) and 2) are ≤ 0.8 W/kg. Otherwise, SAR is measured for the highest output power channel; and if the reported SAR is > 1.45 W/kg, the remaining required test channels must also be tested.

9.6. LTE (TDD) Considerations

According to KDB 941225 D05 SAR for LTE Devices, for Time-Division Duplex (TDD) systems, SAR must be tested using a fixed periodic duty factor according to the highest transmission duty factor implemented for the device and supported by the defined 3GPP LTE TDD configurations.

SAR was tested with the highest transmission duty factor (63.33%) using Uplink-downlink configuration 0 and Special subframe configuration 7.

LTE TDD Band 41 support 3GPP TS 36.211 section 4.2 for Type 2 Frame Structure and Table 4.2-2 for uplink-downlink configurations and Table 4.2-1 for Special subframe configurations.

Special subframe configuration	Normal cyclic prefix in downlink			Extended cyclic prefix in downlink		
	DwPTS	UpPTS		DwPTS	UpPTS	
		Normal cyclic prefix in uplink	Extended cyclic prefix in uplink		Normal cyclic prefix in uplink	Extended cyclic prefix in uplink
0	$6592 \cdot T_s$	$2192 \cdot T_s$	$2560 \cdot T_s$	$7680 \cdot T_s$	$2192 \cdot T_s$	$2560 \cdot T_s$
1	$19760 \cdot T_s$			$20480 \cdot T_s$		
2	$21952 \cdot T_s$			$23040 \cdot T_s$		
3	$24144 \cdot T_s$			$25600 \cdot T_s$		
4	$26336 \cdot T_s$			$7680 \cdot T_s$		
5	$6592 \cdot T_s$	$4384 \cdot T_s$	$5120 \cdot T_s$	$20480 \cdot T_s$	$4384 \cdot T_s$	$5120 \cdot T_s$
6	$19760 \cdot T_s$			$23040 \cdot T_s$		
7	$21952 \cdot T_s$			$12800 \cdot T_s$		
8	$24144 \cdot T_s$			-		
9	$13168 \cdot T_s$			-		

Configuration of special subframe (lengths of DwPTS/GP/UpPTS)

Uplink-Downlink Configuration	Downlink-to-Uplink Switch-point Periodicity	Subframe Number										Calculated Duty Cycle (%)
		0	1	2	3	4	5	6	7	8	9	
0	5 ms	D	S	U	U	U	D	S	U	U	U	63.33
1	5 ms	D	S	U	U	D	D	S	U	U	D	43.33
2	5 ms	D	S	U	D	D	D	S	U	D	D	23.33
3	10 ms	D	S	U	U	U	D	D	D	D	D	31.67
4	10 ms	D	S	U	U	D	D	D	D	D	D	21.67
5	10 ms	D	S	U	D	D	D	D	D	D	D	11.67
6	5 ms	D	S	U	U	U	D	S	U	U	D	53.33

Calculated Duty Cycle

Calculated Duty Cycle = Extended cyclic prefix in uplink x (Ts) x # of S + # of U

Example for Calculated Duty Cycle for Uplink-Downlink Configuration 0:

Calculated Duty Cycle = $5120 \times [1/(15000 \times 2048)] \times 2 + 6 \text{ ms} = 63.33\%$

Where

$T_s = 1/(15000 \times 2048)$ seconds



No. B20N00421-SAR

9.7. Power Drift

To control the output power stability during the SAR test, DASY5 system calculates the power drift by measuring the E-field at the same location at the beginning and at the end of the measurement for each test position. These drift values can be found in Section 14 labeled as: (Power Drift [dB]). This ensures that the power drift during one measurement is within 5%.



10. Conducted Output Power

10.1. GSM Measurement result

During the process of testing, the EUT was controlled via Agilent Digital Radio Communication tester (E5515C) to ensure the maximum power transmission and proper modulation. This result contains conducted output power for the EUT. In all cases, the measured peak output power should be greater and within 5% than EMI measurement.

Table 10.1: The conducted power measurement results for GSM

GSM 850MHz	Tune up 33.0	Conducted Power (dBm)		
		Channel 128(824.2MHz)	Channel 190(836.6MHz)	Channel 251(848.8MHz)
		32.41	32.43	32.44
GSM 1900MHz	Tune up 30.0	Conducted Power(dBm)		
		Channel512(1850.2MHz)	Channel 661(1880MHz)	Channel 810(1909.8MHz)
		28.42	28.94	29.15

Table 10.2: The conducted power measurement results for GPRS and EGPRS

GPRS/ EGPRS850	Tune up	Measured Power (dBm)			calculation	Average Power (dBm)		
		128	190	251		128	190	251
1Tx-slots	33.0	32.33	32.36	32.39	-9.03dB	23.30	23.33	23.36
2Tx-slots	31.5	30.60	31.01	31.17	-6.02dB	24.58	24.99	25.15
3Tx-slots	30.0	29.25	29.38	29.40	-4.26dB	24.99	25.12	25.14
4Tx-slots	28.5	27.25	27.82	27.86	-3.01dB	24.24	24.81	24.85
EGPRS 850 (8PSK)	Tune up	Measured Power (dBm)			calculation	Measured Power (dBm)		
		128	190	251		128	190	251
1Tx-slots	27.5	26.86	26.25	27.02	-9.03dB	17.83	17.22	17.99
2Tx-slots	26.0	25.05	25.36	25.53	-6.02dB	19.03	19.34	19.51
3Tx-slots	24.0	23.22	23.40	23.52	-4.26dB	18.96	19.14	19.26
4Tx-slots	21.0	19.93	20.53	20.68	-3.01dB	16.92	17.52	17.67
GPRS1900/ EGPRS1900	Tune up	Measured Power (dBm)			calculation	Average Power (dBm)		
		512	661	810		512	661	810
1Tx-slots	30.0	28.48	28.95	29.16	-9.03dB	19.45	19.92	20.13
2Tx-slots	28.5	27.04	27.39	27.82	-6.02dB	21.02	21.37	21.80
3Tx-slots	27.0	25.39	26.03	26.44	-4.26dB	21.13	21.77	22.18
4Tx-slots	25.5	23.98	24.39	24.70	-3.01dB	20.97	21.38	21.69
EGPRS 1900 (8PSK)	Tune up	Measured Power (dBm)			calculation	Measured Power (dBm)		
		512	661	810		512	661	810
1Tx-slots	26.0	24.57	25.19	25.44	-9.03dB	15.54	16.16	16.41
2Tx-slots	24.5	23.15	23.51	23.97	-6.02dB	17.13	17.49	17.95
3Tx-slots	22.5	21.33	21.76	22.12	-4.26dB	17.07	17.50	17.86
4Tx-slots	19.5	18.94	19.08	18.95	-3.01dB	15.93	16.07	15.94

Notes:

1) Division Factors

To average the power, the division factor is as follows:

1TX-slot = 1 transmit time slot out of 8 time slots=> conducted power divided by (8/1) => -9.03dB

2TX-slots = 2 transmit time slots out of 8 time slots=> conducted power divided by (8/2) => -6.02dB

3TX-slots = 3 transmit time slots out of 8 time slots=> conducted power divided by (8/3) => -4.26dB

4TX-slots = 4 transmit time slots out of 8 time slots=> conducted power divided by (8/4) => -3.01dB

According to the conducted power as above, the body mode measurements are performed with 2Txslots for GSM850 and 3Txslots for GSM1900.

10.2. WCDMA Measurement result

Table 10.3: The conducted power measurement results WCDMA

Item	band	WCDMA Band 2 result			
	ARFCN	Tune up	9262 (1852.4MHz)	9400 (1880MHz)	9538 (1907.6MHz)
WCDMA	\	23.5	22.31	22.78	22.91
HSUPA	1	21.0	20.15	20.26	20.34
	2	21.0	19.93	20.43	20.61
	3	21.0	20.03	19.96	20.05
	4	21.0	19.98	20.02	20.11
	5	22.0	20.85	21.34	21.49
HSDPA	1	22.5	21.31	21.65	21.80
	2	22.5	21.34	22.01	21.97
	3	22.0	20.82	21.34	21.48
	4	22.0	20.86	21.31	21.47
DC-HSDPA	1	22.5	21.36	21.59	21.77
	2	22.5	21.30	21.86	21.93
	3	22.0	20.76	21.39	21.44
	4	22.0	20.88	21.36	21.49
Item	band	WCDMA Band 4 result			
	ARFCN	Tune up	1312 (1712.4MHz)	1413 (1732.6MHz)	1513 (1752.6MHz)
WCDMA	\	23.0	22.37	22.04	21.78
HSUPA	1	21.0	20.71	20.66	20.68
	2	21.0	20.01	19.66	19.37
	3	21.0	20.26	20.31	20.16
	4	21.0	20.13	20.26	20.18
	5	21.5	20.87	20.61	20.31
HSDPA	1	22.0	21.37	21.08	20.67
	2	22.0	21.45	21.10	20.83
	3	21.5	20.93	20.60	20.32
	4	21.5	20.92	20.60	20.31
DC-HSDPA	1	22.0	21.25	21.09	20.59
	2	22.0	21.49	21.16	20.89
	3	21.5	20.95	20.66	20.36
	4	21.5	20.98	20.62	20.35



Item	band	WCDMA Band 5 result			
	ARFCN	Tune up	4132 (826.4MHz)	4182 (836.4MHz)	4233 (846.6MHz)
WCDMA	\	23.5	22.97	22.85	22.98
HSUPA	1	21.5	21.04	21.13	20.96
	2	21.5	20.56	20.46	20.55
	3	21.5	20.72	20.64	20.75
	4	21.5	20.81	20.69	20.66
	5	22.0	21.53	21.36	21.48
HSDPA	1	22.5	21.98	21.72	21.81
	2	22.5	21.99	21.83	21.98
	3	22.0	21.49	21.34	21.45
	4	22.0	21.46	21.32	21.45
DC-HSDPA	1	22.5	21.94	21.77	21.86
	2	22.5	21.92	21.80	21.85
	3	22.0	21.41	21.32	21.48
	4	22.0	21.44	21.30	21.42

10.3. LTE Measurement result

According to April 2015 TCB workshop, SAR Test exclusion can be applied for testing overlapping LTE Bands as follows:

- a) The maximum out power, including tolerance, for the smaller band must be \leq the larger band to qualify for SAR test exclusion.
- b) The channel bandwidth and other operating parameters for the smaller band must be fully supported by the larger band.

LTE Band 2 (1850-1910 MHz) is covered by LTE Band 25 (1850-1915 MHz)

LTE Band 4 (1710-1755 MHz) is covered by LTE Band 66 (1710-1780 MHz)

LTE Band 17 (704-716 MHz) is covered by LTE Band 12 (699-716 MHz)

LTE Band 38 (2570-2620 MHz) is covered by LTE Band 41 (2496- 2690 MHz)

Table 10.4: The conducted Power for LTE

LTE-FDD Band 5				Actual output Power (dBm)			Tune up	
Band-width	Modulation	RB Size	RB offset	Low 824.7MHz	Middle 836.5MHz	High 848.3MHz		
1.4 MHz	QPSK	1RB	5	23.02	23.26	22.99	24.0	
			3	23.25	23.05	23.12	24.0	
			0	23.06	23.26	23.00	24.0	
		3RB	3	23.09	23.32	23.14	24.0	
			1	23.27	23.30	22.97	24.0	
			0	23.32	23.12	23.21	24.0	
		6RB	0	22.27	22.14	22.07	23.0	
		16QAM	1RB	5	22.19	22.28	22.48	23.0
				3	22.03	22.18	22.36	23.0
	0			22.11	22.23	22.38	23.0	
	3RB		3	22.32	22.48	22.17	23.0	
			1	22.33	22.40	22.13	23.0	
			0	22.35	22.49	22.17	23.0	
	6RB		0	21.26	21.29	21.05	22.0	
	64QAM		1RB	5	21.35	21.40	21.20	22.0
				3	21.25	21.30	21.14	22.0
		0		21.21	21.11	21.25	22.0	
		3RB	3	21.37	21.40	21.08	22.0	
			1	21.22	21.24	21.23	22.0	
			0	21.23	21.34	21.09	22.0	
		6RB	0	20.51	20.19	20.04	21.0	



LTE-FDD Band 5				Actual output Power (dBm)			Tune up	
Band-width				Low	Middle	High		
3 MHz	Modulation	RB Size	RB offset	825.5MHz	836.5MHz	847.5MHz		
	QPSK	1RB	14	23.09	23.28	23.08	24.0	
			7	23.12	23.07	23.02	24.0	
			0	23.15	23.20	22.98	24.0	
		8RB	7	22.17	22.18	22.12	23.0	
			4	22.24	22.19	22.07	23.0	
			0	22.24	22.13	22.05	23.0	
		15RB	0	22.22	22.15	22.01	23.0	
		16QAM	1RB	14	22.03	22.16	22.44	23.0
				7	22.13	22.35	22.54	23.0
	0			22.14	22.24	22.41	23.0	
	8RB		7	21.20	21.45	21.26	22.0	
			4	21.26	21.39	21.08	22.0	
			0	21.32	21.54	21.19	22.0	
	15RB		0	21.33	21.32	21.17	22.0	
	64QAM		1RB	14	21.37	21.37	21.24	22.0
				7	21.27	21.26	21.20	22.0
		0		21.29	21.20	21.24	22.0	
		8RB	7	20.37	20.21	20.23	21.0	
			4	20.29	20.22	20.14	21.0	
			0	20.17	20.28	20.09	21.0	
15RB		0	20.49	20.16	20.22	21.0		



LTE-FDD Band 5				Actual output Power (dBm)			Tune up	
Band-width				Low	Middle	High		
5 MHz	Modulation	RB Size	RB offset	826.5MHz	836.5MHz	846.5MHz		
	QPSK	1RB	24	22.99	23.16	23.16	24.0	
			12	23.19	23.13	23.12	24.0	
			0	23.13	23.25	23.06	24.0	
		12RB	13	22.23	22.27	22.05	23.0	
			6	22.17	22.33	22.01	23.0	
			0	22.30	22.21	22.07	23.0	
		25RB	0	22.12	22.16	22.12	23.0	
		16QAM	1RB	24	22.13	22.22	22.41	23.0
				12	22.14	22.21	22.53	23.0
	0			22.12	22.27	22.49	23.0	
	12RB		13	21.28	21.46	21.23	22.0	
			6	21.36	21.33	21.19	22.0	
			0	21.38	21.44	21.24	22.0	
	25RB		0	21.16	21.33	21.18	22.0	
	64QAM		1RB	24	21.30	21.48	21.19	22.0
				12	21.18	21.28	21.22	22.0
		0		21.30	21.13	21.12	22.0	
		12RB	13	20.45	20.31	20.22	21.0	
			6	20.24	20.22	20.04	21.0	
			0	20.25	20.41	19.98	21.0	
		25RB	0	20.54	20.24	20.07	21.0	



LTE-FDD Band 5				Actual output Power (dBm)			Tune up	
Band-width				Low	Middle	High		
10 MHz	Modulation	RB Size	RB offset	829MHz	836.5MHz	844MHz		
	QPSK	1RB	49	23.17	23.31	23.16	24.0	
			24	23.27	23.22	23.22	24.0	
			0	23.17	23.30	23.11	24.0	
		25RB	25	22.26	22.32	22.22	23.0	
			12	22.33	22.37	22.17	23.0	
			0	22.36	22.29	22.21	23.0	
		50RB	0	22.32	22.28	22.14	23.0	
		16QAM	1RB	49	22.20	22.36	22.60	23.0
				24	22.19	22.38	22.55	23.0
	0			22.15	22.33	22.56	23.0	
	25RB		25	21.38	21.54	21.32	22.0	
			12	21.41	21.52	21.28	22.0	
			0	21.42	21.55	21.32	22.0	
	50RB		0	21.35	21.40	21.21	22.0	
	64QAM		1RB	49	21.44	21.49	21.32	22.0
				24	21.32	21.35	21.28	22.0
		0		21.35	21.29	21.32	22.0	
		25RB	25	20.48	20.41	20.24	21.0	
			12	20.30	20.34	20.23	21.0	
			0	20.31	20.46	20.14	21.0	
		50RB	0	20.56	20.31	20.24	21.0	

Full Power								
LTE-FDD Band 7				Actual output Power (dBm)			Tune up	
Band-width				Low	Middle	High		
5 MHz	QPSK	1RB	RB offset	24	22.37	22.61	22.31	23.5
			12	22.43	22.64	22.27	23.5	
			0	22.58	22.30	22.29	23.5	
		12RB	13	21.49	21.85	21.47	23.5	
			6	21.70	21.85	21.56	23.5	
			0	21.58	21.63	21.59	23.5	
		25RB	0	21.68	21.78	21.40	22.5	
		16QAM	1RB	24	21.86	22.08	21.95	22.5
				12	22.07	22.00	22.10	22.5
	0			22.02	21.73	22.03	22.5	
	12RB		13	20.62	20.86	20.55	21.5	
			6	20.79	20.91	20.72	21.5	
			0	20.80	20.68	20.76	21.5	
	25RB		0	20.83	20.77	20.74	21.5	
	64QAM		1RB	24	20.66	20.66	20.72	21.5
				12	20.54	20.80	20.64	21.5
		0		20.69	20.58	20.49	21.5	
		12RB	13	19.86	19.65	19.50	20.5	
			6	19.70	19.74	19.78	20.5	
			0	19.53	19.84	19.49	20.5	
		25RB	0	19.70	19.70	19.62	20.5	



Full Power								
LTE-FDD Band 7				Actual output Power (dBm)			Tune up	
Band-width				Low	Middle	High		
10 MHz	QPSK	1RB	49	22.39	22.51	22.37	20.5	
			24	22.54	22.63	22.31	20.5	
			0	22.57	22.37	22.42	20.5	
		25RB	25	21.57	21.87	21.41	20.5	
			12	21.71	21.76	21.49	20.5	
			0	21.57	21.62	21.63	20.5	
		50RB	0	21.72	21.64	21.53	20.5	
		16QAM	1RB	49	21.90	21.98	22.00	20.5
				24	21.96	22.00	21.98	20.5
	0			21.99	21.74	21.87	20.5	
	25RB		25	20.60	20.77	20.65	20.5	
			12	20.89	20.87	20.56	20.5	
			0	20.79	20.76	20.76	20.5	
	50RB		0	20.77	20.90	20.68	20.5	
	64QAM		1RB	49	20.62	20.66	20.61	20.5
				24	20.64	20.78	20.57	20.5
		0		20.67	20.71	20.55	20.5	
		25RB	25	19.85	19.73	19.61	20.5	
			12	19.76	19.77	19.80	20.5	
			0	19.56	19.75	19.44	20.5	
		50RB	0	19.68	19.73	19.55	20.5	



Full Power								
LTE-FDD Band 7				Actual output Power (dBm)			Tune up	
Band-width				Low	Middle	High		
15 MHz	QPSK	1RB	74	22.33	22.55	22.35	20.5	
			37	22.43	22.74	22.38	20.5	
			0	22.62	22.24	22.39	20.5	
		36RB	38	21.56	21.79	21.53	20.5	
			19	21.83	21.79	21.49	20.5	
			0	21.72	21.64	21.66	20.5	
		75RB	0	21.62	21.66	21.37	20.5	
		16QAM	1RB	74	22.01	22.02	21.99	20.5
				37	22.06	22.16	22.15	20.5
	0			21.95	21.78	21.92	20.5	
	36RB		38	20.59	20.86	20.70	20.5	
			19	20.93	20.87	20.67	20.5	
			0	20.82	20.70	20.58	20.5	
	75RB		0	20.76	20.77	20.71	20.5	
	64QAM		1RB	74	20.76	20.69	20.70	20.5
				37	20.53	20.83	20.55	20.5
		0		20.71	20.61	20.49	20.5	
		36RB	38	19.83	19.58	19.68	20.5	
			19	19.71	19.82	19.80	20.5	
			0	19.55	19.69	19.43	20.5	
		75RB	0	19.76	19.68	19.48	20.5	



Full Power								
LTE-FDD Band 7				Actual output Power (dBm)			Tune up	
Band-width				Low	Middle	High		
20 MHz	QPSK	1RB	99	22.52	22.67	22.38	20.5	
			50	22.61	22.75	22.47	20.5	
			0	22.62	22.38	22.48	20.5	
		50RB	50	21.67	21.87	21.55	20.5	
			25	21.84	21.85	21.61	20.5	
			0	21.75	21.81	21.66	20.5	
		100RB	0	21.73	21.84	21.55	20.5	
		16QAM	1RB	99	22.02	22.12	22.10	20.5
				50	22.10	22.17	22.16	20.5
	0			22.06	21.84	22.05	20.5	
	36RB		50	20.75	20.90	20.74	20.5	
			25	20.93	20.93	20.75	20.5	
			0	20.85	20.86	20.77	20.5	
	75RB		0	20.84	20.92	20.79	20.5	
	64QAM		1RB	99	20.82	20.78	20.74	20.5
				50	20.67	20.87	20.73	20.5
		0		20.74	20.78	20.69	20.5	
		36RB	50	19.89	19.75	19.69	20.5	
			25	19.87	19.84	19.83	20.5	
			0	19.67	19.86	19.58	20.5	
		75RB	0	19.78	19.77	19.66	20.5	



LTE-FDD Band 12				Actual output Power (dBm)			Tune up	
Band-width				Low	Middle	High		
1.4 MHz	Modulation	RB Size	RB offset	699.7MHz	707.5MHz	715.3MHz		
	QPSK	1RB	5	23.13	23.22	23.05	24.0	
			3	23.09	23.25	23.15	24.0	
			0	23.05	23.22	23.26	24.0	
		3RB	3	23.15	23.20	23.20	24.0	
			1	23.31	23.32	23.20	24.0	
			0	23.27	23.23	23.17	24.0	
		6RB	0	22.20	22.25	22.12	23.0	
		16QAM	1RB	5	22.10	22.18	22.63	23.0
				3	22.12	22.38	22.67	23.0
	0			22.23	22.24	22.55	23.0	
	3RB		3	22.30	22.33	22.32	23.0	
			1	22.48	22.39	22.31	23.0	
			0	22.36	22.41	22.27	23.0	
	6RB		0	21.41	21.47	21.39	22.0	
	64QAM		1RB	5	21.44	21.33	21.30	22.0
				3	21.31	21.35	21.37	22.0
		0		21.47	21.33	21.30	22.0	
		3RB	3	21.40	21.33	21.29	22.0	
			1	21.37	21.38	21.33	22.0	
			0	21.54	21.35	21.39	22.0	
		6RB	0	20.22	20.28	20.47	21.0	



LTE-FDD Band 12				Actual output Power (dBm)			Tune up	
Band-width				Low	Middle	High		
3 MHz	Modulation	RB Size	RB offset	700.5MHz	707.5MHz	714.5MHz		
	QPSK	1RB	14	23.05	23.27	23.19	24.0	
			7	23.01	23.24	23.10	24.0	
			0	23.21	23.16	23.12	24.0	
		8RB	7	22.27	22.22	22.11	23.0	
			4	22.30	22.16	22.28	23.0	
			0	22.20	22.23	22.16	23.0	
		15RB	0	22.27	22.30	22.22	23.0	
		16QAM	1RB	14	22.17	22.31	22.65	23.0
				7	22.12	22.42	22.66	23.0
	0			22.20	22.18	22.65	23.0	
	8RB		7	21.33	21.40	21.24	22.0	
			4	21.39	21.53	21.24	22.0	
			0	21.36	21.43	21.41	22.0	
	15RB		0	21.42	21.34	21.40	22.0	
	64QAM		1RB	14	21.35	21.41	21.26	22.0
				7	21.36	21.48	21.30	22.0
		0		21.49	21.47	21.21	22.0	
		8RB	7	20.35	20.34	20.24	21.0	
			4	20.35	20.38	20.34	21.0	
			0	20.43	20.42	20.27	21.0	
		15RB	0	20.38	20.39	20.33	21.0	



LTE-FDD Band 12				Actual output Power (dBm)			Tune up		
Band-width	Modulation	RB Size	RB offset	Low 701.5MHz	Middle 707.5MHz	High 713.5MHz			
5 MHz	QPSK	1RB	24	23.06	23.09	23.03	24.0		
			12	23.00	23.31	23.24	24.0		
			0	23.24	23.09	23.10	24.0		
		12RB	13	22.33	22.29	22.07	23.0		
			6	22.29	22.25	22.20	23.0		
			0	22.17	22.25	22.29	23.0		
			25RB	0	22.28	22.24	22.18	23.0	
				1RB	24	22.07	22.28	22.51	23.0
					12	22.13	22.45	22.55	23.0
	0	22.14	22.23		22.47	23.0			
	16QAM	12RB	13	21.39	21.42	21.39	22.0		
			6	21.37	21.50	21.41	22.0		
			0	21.43	21.36	21.26	22.0		
		25RB	0	21.39	21.39	21.35	22.0		
		64QAM	1RB	24	21.43	21.47	21.34	22.0	
				12	21.41	21.51	21.21	22.0	
	0			21.43	21.31	21.32	22.0		
	12RB		13	20.34	20.39	20.35	21.0		
			6	20.39	20.37	20.35	21.0		
			0	20.54	20.38	20.41	21.0		
			25RB	0	20.31	20.36	20.39	21.0	



LTE-FDD Band 12				Actual output Power (dBm)			Tune up	
Band-width	Modulation	RB Size	RB offset	Low 704MHz	Middle 707.5MHz	High 711MHz		
10 MHz	QPSK	1RB	49	23.14	23.28	23.23	24.0	
			24	23.19	23.34	23.28	24.0	
			0	23.25	23.24	23.27	24.0	
		25RB	25	22.34	22.30	22.24	23.0	
			12	22.37	22.33	22.29	23.0	
			0	22.33	22.25	22.33	23.0	
		50RB	0	22.37	22.35	22.26	23.0	
		16QAM	1RB	49	22.20	22.36	22.66	23.0
				24	22.25	22.47	22.71	23.0
	0			22.28	22.33	22.67	23.0	
	25RB		25	21.46	21.49	21.41	22.0	
			12	21.50	21.55	21.42	22.0	
			0	21.54	21.44	21.43	22.0	
	50RB		0	21.44	21.48	21.51	22.0	
	64QAM		1RB	49	21.47	21.48	21.38	22.0
				24	21.49	21.52	21.39	22.0
		0		21.58	21.48	21.40	22.0	
		25RB	25	20.44	20.47	20.36	21.0	
			12	20.47	20.52	20.40	21.0	
			0	20.56	20.44	20.42	21.0	
		50RB	0	20.42	20.46	20.48	21.0	



LTE-FDD Band 13				Actual output Power (dBm)			Tune up		
Band-width				Low	Middle	High			
5 MHz	Modulation	RB Size	RB offset	779.5MHz	782MHz	784.5MHz			
	QPSK	1RB	24	23.04	23.05	23.06	24.0		
			12	22.92	22.91	22.93	24.0		
			0	22.98	22.97	22.99	24.0		
		12RB	13	22.02	22.03	22.04	23.0		
			6	22.11	22.10	22.12	23.0		
			0	22.05	22.06	22.08	23.0		
			25RB	0	22.07	22.08	22.09	23.0	
				1RB	24	22.35	22.34	22.36	23.0
					12	22.31	22.31	22.33	23.0
	0	22.48	22.45		22.46	23.0			
	16QAM	12RB	13	21.22	21.18	21.20	22.0		
			6	21.15	21.11	21.13	22.0		
			0	21.23	21.21	21.22	22.0		
		25RB	0	21.13	21.09	21.11	22.0		
			1RB	24	21.15	21.16	21.18	22.0	
				12	21.13	21.10	21.11	22.0	
	0	21.14		21.08	21.10	22.0			
	64QAM	12RB	13	20.22	20.21	20.23	21.0		
			6	20.10	20.12	20.13	21.0		
			0	20.21	20.21	20.23	21.0		
		25RB	0	20.02	20.01	20.03	21.0		



LTE-FDD Band 13				Actual output Power (dBm)			Tune up	
Band-width				Low	Middle	High		
10 MHz	Modulation	RB Size	RB offset	/	782MHz	/		
	QPSK	1RB	49	/	23.16	/	24.0	
			24	/	23.11	/	24.0	
			0	/	23.08	/	24.0	
		25RB	25	/	22.18	/	23.0	
			12	/	22.13	/	23.0	
			0	/	22.10	/	23.0	
		50RB	0	/	22.14	/	23.0	
		16QAM	1RB	49	/	22.40	/	23.0
				24	/	22.37	/	23.0
	0			/	22.55	/	23.0	
	25RB		25	/	21.27	/	22.0	
			12	/	21.22	/	22.0	
			0	/	21.28	/	22.0	
	50RB		0	/	21.23	/	22.0	
	64QAM		1RB	49	/	21.26	/	22.0
				24	/	21.20	/	22.0
		0		/	21.28	/	22.0	
		25RB	25	/	20.25	/	21.0	
			12	/	20.17	/	21.0	
			0	/	20.24	/	21.0	
		50RB	0	/	20.19	/	21.0	



LTE-FDD Band 14				Actual output Power (dBm)			Tune up			
Band-width				Low	Middle	High				
5 MHz	Modulation	RB Size	RB offset	790.5MHz	793MHz	795.5MHz				
	QPSK	1RB	24	22.83	22.82	22.80	24.0			
			12	23.12	23.11	23.09	24.0			
			0	23.03	23.02	23.00	24.0			
		12RB	13	22.13	22.12	22.10	23.0			
			6	22.07	22.06	22.04	23.0			
			0	21.99	21.98	21.96	23.0			
			25RB	0	22.10	22.09	22.07	23.0		
				16QAM	1RB	24	21.91	21.90	21.88	23.0
						12	21.94	21.93	21.91	23.0
	0	21.92	21.91			21.89	23.0			
	12RB	13	21.22	21.21	21.19	22.0				
		6	21.19	21.18	21.16	22.0				
		0	21.05	21.04	21.02	22.0				
		25RB	0	21.04	21.03	21.01	22.0			
			64QAM	1RB	24	21.17	21.16	21.14	22.0	
					12	21.12	21.11	21.09	22.0	
	0	21.07			21.06	21.04	22.0			
	12RB	13	20.08	20.07	20.05	21.0				
		6	20.02	20.01	19.99	21.0				
		0	20.14	20.13	20.11	21.0				
		25RB	0	20.15	20.14	20.12	21.0			



LTE-FDD Band 14				Actual output Power (dBm)			Tune up	
Band-width				Low	Middle	High		
10 MHz	Modulation	RB Size	RB offset	/	793MHz	/		
	QPSK	1RB	49	/	23.02	/	24.0	
			24	/	23.13	/	24.0	
			0	/	23.07	/	24.0	
		25RB	25	/	22.25	/	23.0	
			12	/	22.20	/	23.0	
			0	/	22.11	/	23.0	
		50RB	0	/	22.17	/	23.0	
		16QAM	1RB	49	/	22.09	/	23.0
				24	/	22.05	/	23.0
	0			/	22.08	/	23.0	
	25RB		25	/	21.34	/	22.0	
			12	/	21.27	/	22.0	
			0	/	21.20	/	22.0	
	50RB		0	/	21.22	/	22.0	
	64QAM		1RB	49	/	21.32	/	22.0
				24	/	21.27	/	22.0
		0		/	21.18	/	22.0	
		25RB	25	/	20.25	/	21.0	
			12	/	20.19	/	21.0	
			0	/	20.16	/	21.0	
		50RB	0	/	20.21	/	21.0	



LTE-FDD Band 25				Actual output Power (dBm)			Tune up	
Band-width				Low	Middle	High		
1.4 MHz	Modulation	RB Size	RB offset	1850.7MHz	1882.5MHz	1914.3MHz		
	QPSK	1RB	5	22.02	22.42	22.44	23.5	
			3	22.11	22.48	22.20	23.5	
			0	22.35	22.49	22.49	23.5	
		3RB	3	22.15	22.51	22.71	23.5	
			1	22.29	22.62	22.67	23.5	
			0	22.19	22.70	22.83	23.5	
		6RB	0	21.08	21.57	21.24	22.5	
		16QAM	1RB	5	21.65	21.69	21.69	22.5
				3	21.94	21.82	21.85	22.5
	0			21.80	21.76	20.97	22.5	
	3RB		3	21.30	21.62	21.92	22.5	
			1	21.36	21.75	21.95	22.5	
			0	21.30	21.80	21.86	22.5	
	6RB		0	20.33	20.76	20.90	21.5	
	64QAM		1RB	5	20.15	20.73	20.76	21.5
				3	20.28	20.75	20.78	21.5
		0		20.45	20.83	20.97	21.5	
		3RB	3	20.16	20.76	20.93	21.5	
			1	20.32	20.72	20.92	21.5	
			0	20.31	20.99	20.99	21.5	
		6RB	0	19.28	19.70	19.85	20.5	



LTE-FDD Band 25				Actual output Power (dBm)			Tune up		
Band-width				Low	Middle	High			
3 MHz	Modulation	RB Size	RB offset	1851.5MHz	1882.5MHz	1913.5MHz			
	QPSK	1RB	14	21.97	22.34	22.44	23.5		
			7	22.16	22.44	22.24	23.5		
			0	22.23	22.46	22.49	23.5		
		8RB	7	21.19	21.56	21.62	22.5		
			4	21.14	21.55	21.81	22.5		
			0	21.30	21.69	21.77	22.5		
			15RB	0	21.03	21.62	21.28	22.5	
			16QAM	1RB	14	21.67	21.76	21.83	22.5
					7	21.78	21.80	21.83	22.5
	0	21.67			21.77	20.98	22.5		
	8RB	7		20.36	20.70	20.77	21.5		
		4		20.31	20.85	20.98	21.5		
		0		20.46	20.92	20.88	21.5		
		15RB		0	20.21	20.70	20.90	21.5	
		64QAM		1RB	14	20.28	20.71	20.81	21.5
					7	20.30	20.87	20.85	21.5
	0		20.27		20.84	20.87	21.5		
	8RB		7	19.18	19.70	19.87	20.5		
			4	19.38	19.80	19.94	20.5		
			0	19.43	19.96	19.83	20.5		
			15RB	0	19.33	19.69	19.74	20.5	



LTE-FDD Band 25				Actual output Power (dBm)			Tune up			
Band-width				Low	Middle	High				
5 MHz	Modulation	RB Size	RB offset	1852.5MHz	1882.5MHz	1912.5MHz				
	QPSK	1RB	24	22.03	22.32	22.45	23.5			
			12	22.13	22.56	22.35	23.5			
			0	22.16	22.60	22.34	23.5			
		12RB	13	21.07	21.62	21.71	22.5			
				6	21.22	21.61	21.76	22.5		
				0	21.22	21.81	21.74	22.5		
			25RB	0	21.11	21.63	21.28	22.5		
				16QAM	1RB	24	21.60	21.68	21.76	22.5
						12	21.92	21.86	21.79	22.5
	0	21.72	21.81			20.97	22.5			
	12RB	13	20.28	20.69	20.84	21.5				
			6	20.21	20.72	20.84	21.5			
			0	20.44	20.87	20.92	21.5			
		25RB	0	20.20	20.64	20.76	21.5			
			64QAM	1RB	24	20.24	20.69	20.91	21.5	
					12	20.28	20.69	20.90	21.5	
	0	20.43			20.94	20.83	21.5			
	12RB	13	19.22	19.71	19.81	20.5				
			6	19.40	19.74	19.87	20.5			
			0	19.36	19.98	19.83	20.5			
		25RB	0	19.32	19.78	19.83	20.5			



LTE-FDD Band 25				Actual output Power (dBm)			Tune up	
Band-width				Low	Middle	High		
10 MHz	Modulation	RB Size	RB offset	1855MHz	1882.5MHz	1910MHz		
	QPSK	1RB	49	21.87	22.42	22.46	23.5	
			24	22.23	22.53	22.26	23.5	
			0	22.28	22.52	22.43	23.5	
		25RB	25	21.16	21.61	21.77	22.5	
			12	21.18	21.58	21.70	22.5	
			0	21.22	21.61	21.88	22.5	
		50RB	0	21.19	21.67	21.20	22.5	
		16QAM	1RB	49	21.78	21.68	21.77	22.5
				24	21.90	21.91	21.80	22.5
	0			21.66	21.72	20.94	22.5	
	25RB		25	20.17	20.60	20.82	21.5	
			12	20.32	20.79	20.81	21.5	
			0	20.46	20.80	20.96	21.5	
	50RB		0	20.34	20.66	20.90	21.5	
	64QAM		1RB	49	20.27	20.68	20.74	21.5
				24	20.20	20.71	20.82	21.5
		0		20.43	20.94	20.87	21.5	
		25RB	25	19.23	19.74	19.79	20.5	
			12	19.36	19.81	19.91	20.5	
			0	19.33	19.81	19.81	20.5	
		50RB	0	19.19	19.67	19.77	20.5	



LTE-FDD Band 25				Actual output Power (dBm)			Tune up			
Band-width				Low	Middle	High				
15 MHz	Modulation	RB Size	RB offset	1857.5MHz	1882.5MHz	1907.5MHz				
	QPSK	1RB	74	21.86	22.26	22.55	23.5			
			37	22.25	22.49	22.23	23.5			
			0	22.31	22.51	22.43	23.5			
		36RB	38	21.10	21.61	21.76	22.5			
			19	21.21	21.66	21.74	22.5			
			0	21.34	21.68	21.80	22.5			
			75RB	0	21.08	21.72	21.33	22.5		
				16QAM	1RB	74	21.70	21.76	21.70	22.5
						37	21.91	21.83	21.82	22.5
	0	21.71	21.76			20.91	22.5			
	36RB	38	20.22	20.70	20.77	21.5				
		19	20.28	20.78	20.88	21.5				
		0	20.48	20.82	20.87	21.5				
		75RB	0	20.30	20.72	20.81	21.5			
			64QAM	1RB	74	20.18	20.76	20.76	21.5	
					37	20.21	20.83	20.89	21.5	
	0	20.45			20.92	20.87	21.5			
	36RB	38	19.21	19.76	19.92	20.5				
		19	19.25	19.78	19.90	20.5				
		0	19.47	19.92	19.87	20.5				
		75RB	0	19.28	19.77	19.85	20.5			



LTE-FDD Band 25				Actual output Power (dBm)			Tune up	
Band-width				Low	Middle	High		
20 MHz	Modulation	RB Size	RB offset	1860MHz	1882.5MHz	1905MHz		
	QPSK	1RB	99	22.04	22.43	22.61	23.5	
			50	22.30	22.57	22.39	23.5	
			0	22.35	22.66	22.50	23.5	
		50RB	50	21.22	21.68	21.82	22.5	
			25	21.31	21.74	21.86	22.5	
			0	21.36	21.81	21.91	22.5	
		100RB	0	21.19	21.72	21.38	22.5	
		16QAM	1RB	99	21.80	21.85	21.86	22.5
				50	21.95	21.94	21.97	22.5
	0			21.86	21.84	21.10	22.5	
	36RB		50	20.37	20.79	20.96	21.5	
			25	20.40	20.92	20.99	21.5	
			0	20.49	20.98	21.00	21.5	
	75RB		0	20.35	20.84	20.92	21.5	
	64QAM		1RB	99	20.35	20.77	20.93	21.5
				50	20.37	20.89	20.98	21.5
		0		20.46	20.97	21.01	21.5	
		36RB	50	19.36	19.79	19.95	20.5	
			25	19.42	19.86	19.97	20.5	
0			19.48	19.99	19.99	20.5		
75RB		0	19.35	19.84	19.87	20.5		



LTE-FDD Band 26				Actual output Power (dBm)			Tune up		
Band-width				Low	Middle	High			
3 MHz	Modulation	RB Size	RB offset	814.7MHz	831.5MHz	848.3MHz			
	QPSK	1RB	14	23.02	22.93	23.20	24.0		
			7	23.00	23.19	23.18	24.0		
			0	23.15	23.00	23.07	24.0		
		8RB	7	22.96	22.97	23.10	23.0		
			4	23.04	23.17	23.12	23.0		
			0	22.99	23.18	23.19	23.0		
			15RB	0	21.95	22.08	22.10	23.0	
			16QAM	1RB	14	21.85	22.50	22.65	23.0
					7	21.97	22.48	22.48	23.0
	0	22.07			22.45	22.41	23.0		
	8RB	7		22.11	22.26	22.05	22.0		
		4		22.27	22.24	22.19	22.0		
		0		22.21	22.21	22.27	22.0		
		15RB		0	21.14	21.27	21.11	22.0	
		64QAM		1RB	14	21.06	21.26	21.10	22.0
					7	21.11	21.19	21.09	22.0
	0		21.24		21.36	21.18	22.0		
	8RB		7	21.08	21.12	21.04	21.0		
			4	21.14	21.27	21.22	21.0		
			0	21.17	21.20	21.16	21.0		
			15RB	0	20.09	20.19	20.19	21.0	



LTE-FDD Band 26				Actual output Power (dBm)			Tune up		
Band-width				Low	Middle	High			
3 MHz	Modulation	RB Size	RB offset	815.5MHz	831.5MHz	847.5MHz			
	QPSK	1RB	14	22.96	23.10	23.14	24.0		
			7	22.99	23.11	23.10	24.0		
			0	22.98	22.95	22.92	24.0		
		8RB	7	21.99	22.06	22.12	23.0		
			4	21.98	22.14	22.17	23.0		
			0	22.03	22.14	22.15	23.0		
			15RB	0	21.95	22.02	22.19	23.0	
			16QAM	1RB	14	21.93	22.36	22.53	23.0
					7	21.99	22.53	22.57	23.0
	0	21.94			22.47	22.48	23.0		
	8RB	7		21.04	21.21	21.10	22.0		
		4		21.16	21.30	21.11	22.0		
		0		21.31	21.24	21.20	22.0		
		15RB		0	21.27	21.12	21.26	22.0	
		64QAM		1RB	14	21.00	21.14	21.21	22.0
					7	21.20	21.32	21.15	22.0
	0		21.26		21.26	21.12	22.0		
	8RB		7	20.08	20.14	20.18	21.0		
			4	20.19	20.15	20.09	21.0		
			0	20.20	20.27	20.14	21.0		
			15RB	0	20.19	20.16	20.24	21.0	



LTE-FDD Band 26				Actual output Power (dBm)			Tune up	
Band-width				Low	Middle	High		
5 MHz	Modulation	RB Size	RB offset	816.5MHz	831.5MHz	846.5MHz		
	QPSK	1RB	24	22.94	22.98	23.18	24.0	
			12	22.92	23.12	23.09	24.0	
			0	23.01	23.09	22.94	24.0	
		12RB	13	22.10	22.01	22.11	23.0	
			6	22.09	22.04	22.13	23.0	
			0	22.10	22.14	22.13	23.0	
		25RB	0	21.95	22.00	22.06	23.0	
		16QAM	1RB	24	21.95	22.37	22.58	23.0
				12	22.07	22.44	22.54	23.0
	0			21.96	22.41	22.31	23.0	
	12RB		13	21.04	21.19	21.13	22.0	
			6	21.09	21.23	21.08	22.0	
			0	21.18	21.21	21.29	22.0	
	25RB		0	21.13	21.08	21.18	22.0	
	64QAM		1RB	24	21.02	21.21	21.05	22.0
				12	21.11	21.31	21.24	22.0
		0		21.27	21.28	21.14	22.0	
		12RB	13	20.02	20.28	20.13	21.0	
			6	20.22	20.27	20.08	21.0	
			0	20.08	20.16	20.15	21.0	
		25RB	0	20.16	20.13	20.17	21.0	



LTE-FDD Band 26				Actual output Power (dBm)			Tune up	
Band-width	Modulation	RB Size	RB offset	Low 820MHz	Middle 831.5MHz	High 844MHz		
10 MHz	QPSK	1RB	49	23.05	23.02	23.09	24.0	
			24	22.93	23.18	23.10	24.0	
			0	23.09	23.03	22.91	24.0	
		25RB	25	21.99	21.98	22.03	23.0	
			12	22.02	22.07	22.21	23.0	
			0	21.98	22.11	22.06	23.0	
		50RB	0	22.08	22.02	22.20	23.0	
		16QAM	1RB	49	21.92	22.48	22.56	23.0
				24	21.93	22.43	22.40	23.0
	0			21.94	22.45	22.33	23.0	
	25RB		25	21.03	21.18	21.21	22.0	
			12	21.24	21.22	21.25	22.0	
			0	21.24	21.22	21.29	22.0	
	50RB		0	21.19	21.21	21.09	22.0	
	64QAM		1RB	49	20.97	21.22	21.02	22.0
				24	21.16	21.26	21.14	22.0
		0		21.14	21.27	21.28	22.0	
		25RB	25	20.02	20.30	20.06	21.0	
			12	20.22	20.15	20.08	21.0	
			0	20.12	20.27	20.16	21.0	
		50RB	0	20.09	20.08	20.21	21.0	



LTE-FDD Band 26				Actual output Power (dBm)			Tune up			
Band-width				Low	Middle	High				
15 MHz	Modulation	RB Size	RB offset	822.5MHz	831.5MHz	841.5MHz				
	QPSK	1RB	74	23.12	23.11	23.24	24.0			
			37	23.01	23.21	23.23	24.0			
			0	23.18	23.15	23.09	24.0			
		36RB	38	22.11	22.16	22.14	23.0			
				19	22.16	22.23	22.24	23.0		
				0	22.17	22.21	22.25	23.0		
			75RB	0	22.14	22.15	22.22	23.0		
				16QAM	1RB	74	22.01	22.51	22.71	23.0
						37	22.12	22.59	22.58	23.0
	0	22.14	22.60			22.51	23.0			
	36RB	38	21.17	21.32	21.23	22.0				
			19	21.29	21.33	21.28	22.0			
			0	21.31	21.36	21.31	22.0			
		75RB	0	21.27	21.28	21.28	22.0			
			64QAM	1RB	74	21.15	21.31	21.21	22.0	
					37	21.27	21.34	21.26	22.0	
	0	21.29			21.39	21.29	22.0			
	36RB	38	20.17	20.32	20.19	21.0				
			19	20.25	20.31	20.24	21.0			
			0	20.28	20.32	20.26	21.0			
		75RB	0	20.25	20.26	20.30	21.0			



LTE-FDD Band 30				Actual output Power (dBm)			Tune up	
Band-width				Low	Middle	High		
5 MHz	Modulation	RB Size	RB offset	2307.5MHz	2310MHz	2312.5MHz		
	QPSK	1RB	24	22.55	22.54	22.52	23.5	
			12	22.68	22.67	22.65	23.5	
			0	22.44	22.43	22.41	23.5	
		12RB	13	21.85	21.84	21.82	22.5	
			6	21.78	21.77	21.75	22.5	
			0	21.84	21.83	21.81	22.5	
		25RB	0	21.85	21.84	21.82	22.5	
		16QAM	1RB	24	22.15	22.14	22.12	22.5
				12	22.18	22.17	22.15	22.5
	0			21.97	21.96	21.94	22.5	
	12RB		13	21.01	21.00	20.98	21.5	
			6	20.96	20.95	20.93	21.5	
			0	20.96	20.95	20.93	21.5	
	25RB		0	20.97	20.96	20.94	21.5	
	64QAM		1RB	24	21.01	21.00	20.98	21.5
				12	21.09	21.08	21.06	21.5
		0		20.94	20.93	20.91	21.5	
		12RB	13	20.08	20.07	20.05	20.5	
			6	20.06	20.05	20.03	20.5	
			0	20.03	20.02	20.00	20.5	
		25RB	0	20.01	20.00	19.98	20.5	



LTE-FDD Band 30				Actual output Power (dBm)			Tune up	
Band-width				Low	Middle	High		
10 MHz	Modulation	RB Size	RB offset	/	2310MHz	/		
	QPSK	1RB	49	/	22.69	/	23.5	
			24	/	22.76	/	23.5	
			0	/	22.61	/	23.5	
		25RB	25	/	21.86	/	22.5	
			12	/	21.92	/	22.5	
			0	/	21.90	/	22.5	
		50RB	0	/	21.94	/	22.5	
		16QAM	1RB	49	/	22.23	/	22.5
				24	/	22.34	/	22.5
	0			/	22.07	/	22.5	
	25RB		25	/	21.07	/	21.5	
			12	/	21.12	/	21.5	
			0	/	21.10	/	21.5	
	50RB		0	/	21.07	/	21.5	
	64QAM		1RB	49	/	21.05	/	21.5
				24	/	21.14	/	21.5
		0		/	21.08	/	21.5	
		25RB	25	/	20.07	/	20.5	
			12	/	20.12	/	20.5	
			0	/	20.04	/	20.5	
		50RB	0	/	20.08	/	20.5	



Full Power								
LTE-TDD Band 41				Actual output Power (dBm)			Tune up	
Band-width				Low	Middle	High		
5 MHz	QPSK	1RB	RB offset	24	21.68	22.43	22.78	23.5
			12	22.47	22.38	22.46	23.5	
			0	22.46	22.46	22.51	23.5	
		12RB	13	21.74	21.35	21.72	22.5	
			6	21.59	21.52	21.57	22.5	
			0	21.54	21.54	21.83	22.5	
		25RB	0	21.71	21.47	21.70	22.5	
		16QAM	1RB	24	20.60	21.34	21.86	22.5
				12	21.57	21.35	21.69	22.5
	0			21.57	21.29	21.72	22.5	
	12RB		13	20.83	20.58	20.85	21.5	
			6	20.73	20.49	20.62	21.5	
			0	20.82	20.66	20.83	21.5	
	25RB		0	20.73	20.46	20.83	21.5	
	64QAM		1RB	24	20.74	20.54	20.75	21.5
				12	20.74	20.49	20.56	21.5
		0		20.82	20.53	20.79	21.5	
		12RB	13	19.77	19.41	19.75	20.5	
			6	19.70	19.49	19.72	20.5	
			0	19.79	19.62	19.78	20.5	
		25RB	0	19.78	19.50	19.72	20.5	



Full Power								
LTE-TDD Band 41				Actual output Power (dBm)			Tune up	
Band-width				Low	Middle	High		
10 MHz	QPSK	1RB	49	21.79	22.43	22.81	23.5	
			24	22.52	22.33	22.50	23.5	
			0	22.48	22.39	22.59	23.5	
		25RB	25	21.68	21.42	21.76	22.5	
			12	21.58	21.46	21.60	22.5	
			0	21.74	21.57	21.76	22.5	
		50RB	0	21.71	21.39	21.60	22.5	
		16QAM	1RB	49	20.63	21.26	21.95	22.5
				24	21.62	21.37	21.59	22.5
	0			21.57	21.43	21.79	22.5	
	25RB		25	20.73	20.44	20.85	21.5	
			12	20.76	20.59	20.74	21.5	
			0	20.65	20.50	20.86	21.5	
	50RB		0	20.68	20.57	20.69	21.5	
	64QAM		1RB	49	20.69	20.38	20.69	21.5
				24	20.71	20.43	20.59	21.5
		0		20.63	20.63	20.83	21.5	
		25RB	25	19.79	19.58	19.69	20.5	
			12	19.55	19.48	19.73	20.5	
			0	19.67	19.48	19.81	20.5	
		50RB	0	19.77	19.53	19.82	20.5	



Full Power								
LTE-TDD Band 41				Actual output Power (dBm)			Tune up	
Band-width				Low	Middle	High		
15 MHz	Modulation	RB Size	RB offset	2503.5MHz	2593MHz	2682.5MHz		
	QPSK	1RB	74	21.78	22.41	22.81	23.5	
			37	22.46	22.43	22.50	23.5	
			0	22.60	22.36	22.49	23.5	
		36RB	38	21.68	21.40	21.71	22.5	
			19	21.65	21.44	21.55	22.5	
			0	21.59	21.52	21.71	22.5	
		75RB	0	21.71	21.47	21.76	22.5	
		16QAM	1RB	74	20.72	21.27	22.00	22.5
				37	21.59	21.25	21.54	22.5
	0			21.71	21.43	21.69	22.5	
	36RB		38	20.74	20.49	20.68	21.5	
			19	20.61	20.56	20.60	21.5	
			0	20.71	20.66	20.93	21.5	
	75RB		0	20.78	20.62	20.74	21.5	
	64QAM		1RB	74	20.69	20.56	20.80	21.5
				37	20.77	20.45	20.57	21.5
		0		20.72	20.48	20.98	21.5	
		36RB	38	19.76	19.48	19.84	20.5	
			19	19.62	19.55	19.66	20.5	
			0	19.69	19.55	19.93	20.5	
		75RB	0	19.78	19.50	19.67	20.5	



Full Power								
LTE-TDD Band 41				Actual output Power (dBm)			Tune up	
Band-width				Low	Middle	High		
20 MHz	QPSK	1RB	99	21.80	22.54	22.89	23.5	
			50	22.60	22.51	22.64	23.5	
			0	22.62	22.52	22.65	23.5	
		50RB	50	21.78	21.53	21.76	22.5	
			25	21.76	21.58	21.71	22.5	
			0	21.74	21.59	21.86	22.5	
		100RB	0	21.74	21.57	21.77	22.5	
		16QAM	1RB	99	20.73	21.46	22.05	22.5
				50	21.71	21.42	21.73	22.5
	0			21.76	21.47	21.87	22.5	
	36RB		50	20.88	20.62	20.86	21.5	
			25	20.81	20.66	20.79	21.5	
			0	20.84	20.66	20.97	21.5	
	75RB		0	20.86	20.65	20.85	21.5	
	64QAM		1RB	99	20.86	20.58	20.84	21.5
				50	20.78	20.62	20.73	21.5
		0		20.83	20.66	20.98	21.5	
		36RB	50	19.88	19.61	19.88	20.5	
			25	19.75	19.67	19.74	20.5	
			0	19.82	19.63	19.94	20.5	
		75RB	0	19.88	19.62	19.85	20.5	



Full Power								
LTE-TDD Band 41				Actual output Power (dBm)			Tune up	
Band-width				Low-2	Middle	High-2		
5 MHz	Modulation	RB Size	RB offset	2545.8MHz	/	2640.3MHz		
	QPSK	1RB	24	21.70	/	22.35	23.5	
			12	22.48	/	22.32	23.5	
			0	22.38	/	22.33	23.5	
		12RB	13	21.59	/	21.27	22.5	
			6	21.61	/	21.40	22.5	
			0	21.59	/	21.59	22.5	
		25RB	0	21.69	/	21.34	22.5	
		16QAM	1RB	24	20.59	/	21.19	22.5
				12	21.47	/	21.37	22.5
	0			21.58	/	21.16	22.5	
	12RB		13	20.86	/	20.45	21.5	
			6	20.65	/	20.42	21.5	
			0	20.75	/	20.66	21.5	
	25RB		0	20.59	/	20.31	21.5	
	64QAM		1RB	24	20.71	/	20.52	21.5
				12	20.69	/	20.44	21.5
		0		20.80	/	20.51	21.5	
		12RB	13	19.76	/	19.41	20.5	
			6	19.67	/	19.47	20.5	
			0	19.78	/	19.58	20.5	
		25RB	0	19.75	/	19.50	20.5	



Full Power									
LTE-TDD Band 41				Actual output Power (dBm)			Tune up		
Band-width				Low-2	Middle	High-2			
10 MHz	Modulation	RB Size	RB offset	2547MHz	/	2639MHz			
	QPSK	1RB	49	21.82	/	22.44	23.5		
			24	22.55	/	22.19	23.5		
			0	22.48	/	22.36	23.5		
		25RB	1RB	25	21.64	/	21.30	22.5	
				12	21.57	/	21.47	22.5	
				0	21.61	/	21.42	22.5	
			50RB	0	21.65	/	21.42	22.5	
				1RB	49	20.63	/	21.19	22.5
					24	21.58	/	21.23	22.5
	0	21.43	/		21.46	22.5			
	16QAM	25RB	25	20.59	/	20.47	21.5		
			12	20.72	/	20.49	21.5		
			0	20.59	/	20.55	21.5		
		50RB	0	20.56	/	20.43	21.5		
			1RB	49	20.64	/	20.34	21.5	
				24	20.71	/	20.42	21.5	
	0	20.62		/	20.62	21.5			
	64QAM	25RB	25	19.78	/	19.53	20.5		
			12	19.50	/	19.46	20.5		
			0	19.63	/	19.45	20.5		
		50RB	0	19.72	/	19.52	20.5		



Full Power								
LTE-TDD Band 41				Actual output Power (dBm)			Tune up	
Band-width				Low-2	Middle	High-2		
15 MHz	Modulation	RB Size	RB offset	2548.3MHz	/	2637.8MHz		
	QPSK	1RB	74	21.81	/	22.30	23.5	
			37	22.37	/	22.43	23.5	
			0	22.53	/	22.22	23.5	
		36RB	38	21.57	/	21.31	22.5	
			19	21.61	/	21.45	22.5	
			0	21.55	/	21.57	22.5	
		75RB	0	21.59	/	21.37	22.5	
		16QAM	1RB	74	20.71	/	21.30	22.5
				37	21.58	/	21.26	22.5
	0			21.75	/	21.40	22.5	
	36RB		38	20.66	/	20.43	21.5	
			19	20.62	/	20.60	21.5	
			0	20.66	/	20.55	21.5	
	75RB		0	20.78	/	20.66	21.5	
	64QAM		1RB	74	20.69	/	20.55	21.5
				37	20.74	/	20.43	21.5
		0		20.70	/	20.47	21.5	
		36RB	38	19.74	/	19.44	20.5	
			19	19.57	/	19.50	20.5	
			0	19.64	/	19.53	20.5	
		75RB	0	19.75	/	19.45	20.5	



Full Power								
LTE-TDD Band 41				Actual output Power (dBm)			Tune up	
Band-width				Low-2	Middle	High-2		
20 MHz	Modulation	RB Size	RB offset	2549.5MHz	/	2636.5MHz		
	QPSK	1RB	99	21.83	/	22.77	23.5	
			50	22.63	/	22.67	23.5	
			0	22.57	/	22.69	23.5	
		50RB	50	21.69	/	21.75	22.5	
			25	21.73	/	21.60	22.5	
			0	21.63	/	21.73	22.5	
		100RB	0	21.70	/	21.64	22.5	
		16QAM	1RB	99	20.66	/	22.00	22.5
				50	21.70	/	21.66	22.5
	0			21.76	/	21.88	22.5	
	36RB		50	20.82	/	20.74	21.5	
			25	20.77	/	20.81	21.5	
			0	20.75	/	20.91	21.5	
	75RB		0	20.81	/	20.75	21.5	
	64QAM		1RB	99	20.83	/	20.81	21.5
				50	20.74	/	20.72	21.5
		0		20.79	/	20.93	21.5	
		36RB	50	19.85	/	19.86	20.5	
			25	19.72	/	19.70	20.5	
			0	19.79	/	19.90	20.5	
		75RB	0	19.85	/	19.81	20.5	



LTE-FDD Band 66				Actual output Power (dBm)			Tune up	
Band-width				Low	Middle	High		
1.4 MHz	Modulation	RB Size	RB offset	1710.7MHz	1745MHz	1779.3MHz		
	QPSK	1RB	5	22.30	21.33	21.89	23.0	
			3	22.03	22.30	22.09	23.0	
			0	21.44	21.71	21.63	23.0	
		3RB	3	22.41	22.20	21.92	23.0	
			1	22.31	22.10	21.99	23.0	
			0	22.18	22.09	21.88	23.0	
		6RB	0	21.26	21.24	21.03	22.0	
		16QAM	1RB	5	21.81	20.89	21.70	22.0
				3	21.57	21.66	21.59	22.0
	0			19.97	21.48	20.18	22.0	
	3RB		3	21.53	21.16	21.14	22.0	
			1	21.53	21.25	21.11	22.0	
			0	21.25	21.23	21.18	22.0	
	6RB		0	20.37	20.36	20.06	21.0	
	64QAM		1RB	5	20.48	20.28	20.05	21.0
				3	20.34	20.33	20.11	21.0
		0		20.19	20.31	20.14	21.0	
		3RB	3	20.52	20.33	20.04	21.0	
			1	20.41	20.31	20.09	21.0	
			0	20.30	20.19	20.13	21.0	
		6RB	0	19.34	19.24	19.06	20.0	



LTE-FDD Band 66				Actual output Power (dBm)			Tune up	
Band-width				Low	Middle	High		
3 MHz	Modulation	RB Size	RB offset	1711.5MHz	1745MHz	1778.5MHz		
	QPSK	1RB	14	22.16	21.23	21.81	23.0	
			7	21.97	22.23	22.04	23.0	
			0	21.28	21.72	21.50	23.0	
		8RB	7	21.31	21.19	21.02	22.0	
			4	21.27	21.25	20.93	22.0	
			0	21.06	21.19	21.02	22.0	
		15RB	0	21.25	21.10	20.98	22.0	
		16QAM	1RB	14	21.82	20.89	21.54	22.0
				7	21.49	21.72	21.57	22.0
	0			19.88	21.50	20.29	22.0	
	8RB		7	20.42	20.27	20.13	21.0	
			4	20.49	20.32	20.08	21.0	
			0	20.31	20.25	20.18	21.0	
	15RB		0	20.50	20.19	20.16	21.0	
	64QAM		1RB	14	20.39	20.18	20.16	21.0
				7	20.35	20.16	20.12	21.0
		0		20.16	20.24	20.07	21.0	
		8RB	7	19.53	19.32	19.02	20.0	
			4	19.36	19.25	19.02	20.0	
			0	19.15	19.23	19.16	20.0	
15RB		0	19.49	19.20	19.11	20.0		



LTE-FDD Band 66				Actual output Power (dBm)			Tune up		
Band-width				Low	Middle	High			
5 MHz	Modulation	RB Size	RB offset	1712.5MHz	1745MHz	1777.5MHz			
	QPSK	1RB	24	22.31	21.25	21.88	23.0		
			12	22.08	22.13	22.09	23.0		
			0	21.39	21.71	21.59	23.0		
		12RB	13	21.24	21.15	21.03	22.0		
			6	21.34	21.18	20.89	22.0		
			0	21.23	21.13	20.91	22.0		
			25RB	0	21.35	21.14	20.97	22.0	
				1RB	24	21.75	20.82	21.55	22.0
					12	21.39	21.76	21.65	22.0
	0	19.90	21.34		20.32	22.0			
	16QAM	12RB	13	20.52	20.31	20.04	21.0		
			6	20.41	20.30	20.20	21.0		
			0	20.34	20.14	20.18	21.0		
		25RB	0	20.47	20.24	20.18	21.0		
			1RB	24	20.47	20.30	20.04	21.0	
				12	20.30	20.27	20.08	21.0	
		0		20.25	20.21	20.09	21.0		
		64QAM	12RB	13	19.40	19.33	19.12	20.0	
				6	19.42	19.26	19.16	20.0	
	0			19.25	19.32	19.05	20.0		
	25RB		0	19.47	19.21	19.11	20.0		



LTE-FDD Band 66				Actual output Power (dBm)			Tune up	
Band-width	Modulation	RB Size	RB offset	Low 1715MHz	Middle 1745MHz	High 1775MHz		
10 MHz	QPSK	1RB	49	22.25	21.27	21.93	23.0	
			24	22.13	22.16	22.05	23.0	
			0	21.35	21.87	21.57	23.0	
		25RB	25	21.39	21.12	20.95	22.0	
			12	21.28	21.18	20.92	22.0	
			0	21.12	21.10	20.96	22.0	
		50RB	0	21.30	21.23	21.03	22.0	
		16QAM	1RB	49	21.70	20.91	21.72	22.0
				24	21.40	21.61	21.68	22.0
	0			19.88	21.33	20.29	22.0	
	25RB		25	20.40	20.32	20.20	21.0	
			12	20.50	20.34	20.04	21.0	
			0	20.27	20.27	20.07	21.0	
	50RB		0	20.33	20.26	20.18	21.0	
	64QAM		1RB	49	20.40	20.26	20.03	21.0
				24	20.37	20.29	20.13	21.0
		0		20.17	20.27	19.98	21.0	
		25RB	25	19.48	19.35	19.14	20.0	
			12	19.37	19.36	19.04	20.0	
			0	19.11	19.26	19.09	20.0	
		50RB	0	19.36	19.25	19.14	20.0	



LTE-FDD Band 66				Actual output Power (dBm)			Tune up	
Band-width				Low	Middle	High		
15 MHz	Modulation	RB Size	RB offset	1717.5MHz	1745MHz	1772.5MHz		
	QPSK	1RB	74	22.24	21.32	21.88	23.0	
			37	21.95	22.27	22.04	23.0	
			0	21.46	21.87	21.56	23.0	
		36RB	38	21.36	21.27	20.92	22.0	
			19	21.26	21.20	20.99	22.0	
			0	21.11	21.18	20.93	22.0	
		75RB	0	21.22	21.22	20.92	22.0	
		16QAM	1RB	74	21.68	20.90	21.67	22.0
				37	21.56	21.68	21.68	22.0
	0			20.02	21.38	20.24	22.0	
	36RB		38	20.48	20.29	20.18	21.0	
			19	20.37	20.32	20.08	21.0	
			0	20.33	20.31	20.16	21.0	
	75RB		0	20.32	20.18	20.16	21.0	
	64QAM		1RB	74	20.49	20.31	20.18	21.0
				37	20.40	20.33	20.15	21.0
		0		20.18	20.28	20.13	21.0	
		36RB	38	19.40	19.36	19.19	20.0	
			19	19.41	19.27	19.07	20.0	
			0	19.21	19.31	19.13	20.0	
75RB		0	19.45	19.23	19.20	20.0		



LTE-FDD Band 66				Actual output Power (dBm)			Tune up	
Band-width				Low	Middle	High		
20 MHz	Modulation	RB Size	RB offset	1720MHz	1745MHz	1770MHz		
	QPSK	1RB	99	22.32	21.38	22.00	23.0	
			50	22.15	22.31	22.15	23.0	
			0	21.47	21.89	21.69	23.0	
		50RB	50	21.44	21.31	21.08	22.0	
			25	21.37	21.27	21.04	22.0	
			0	21.26	21.25	21.05	22.0	
		100RB	0	21.41	21.26	21.04	22.0	
		16QAM	1RB	99	21.83	21.01	21.72	22.0
				50	21.58	21.79	21.72	22.0
	0			20.07	21.51	20.36	22.0	
	36RB		50	20.58	20.36	20.24	21.0	
			25	20.56	20.38	20.21	21.0	
			0	20.36	20.34	20.22	21.0	
	75RB		0	20.52	20.37	20.23	21.0	
	64QAM		1RB	99	20.57	20.31	20.23	21.0
				50	20.49	20.36	20.19	21.0
		0		20.33	20.34	20.17	21.0	
		36RB	50	19.54	19.37	19.21	20.0	
			25	19.45	19.36	19.17	20.0	
0			19.31	19.35	19.18	20.0		
75RB		0	19.49	19.32	19.24	20.0		

Hotspot								
LTE Band 7			Actual output Power (dBm)			Tune up		
Band -width	RB No. / RB offset	Frequency	Modulation			Modulation		
			QPSK	16QAM	64QAM	QPSK	16QAM	64QAM
5 MHz	1RB_24	2567.4MHz	19.88	20.22	20.08	21.0	21.0	21.0
		2535MHz	20.11	20.48	20.29	21.0	21.0	21.0
		2502.5MHz	19.90	20.24	20.19	21.0	21.0	21.0
	1RB_12	2567.4MHz	19.87	20.27	20.06	21.0	21.0	21.0
		2535MHz	20.05	20.49	20.33	21.0	21.0	21.0
		2502.5MHz	19.78	20.10	20.10	21.0	21.0	21.0
	1RB_0	2567.4MHz	19.91	20.15	20.06	21.0	21.0	21.0
		2535MHz	20.08	20.35	20.29	21.0	21.0	21.0
		2502.5MHz	19.79	20.10	19.96	21.0	21.0	21.0
	12RB_13	2567.4MHz	19.93	20.08	20.08	21.0	21.0	21.0
		2535MHz	20.14	20.24	20.27	21.0	21.0	21.0
		2502.5MHz	19.93	20.03	20.08	21.0	21.0	21.0
	12RB_6	2567.4MHz	19.94	20.01	20.08	21.0	21.0	21.0
		2535MHz	20.11	20.30	20.34	21.0	21.0	21.0
		2502.5MHz	19.87	19.94	20.04	21.0	21.0	21.0
	12RB_0	2567.4MHz	19.91	19.98	19.99	21.0	21.0	21.0
		2535MHz	20.08	20.22	20.27	21.0	21.0	21.0
		2502.5MHz	19.78	19.86	19.96	21.0	21.0	21.0
	25RB_0	2567.4MHz	19.90	20.02	20.07	21.0	21.0	21.0
		2535MHz	20.16	20.22	20.23	21.0	21.0	21.0
		2502.5MHz	19.91	20.00	20.04	21.0	21.0	21.0



Hotspot								
LTE Band 7			Actual output Power (dBm)			Tune up		
Band -width	RB No. / RB offset	Frequency	Modulation			Modulation		
			QPSK	16QAM	64QAM	QPSK	16QAM	64QAM
10 MHz	1RB_49	2565MHz	20.06	20.34	20.29	21.0	21.0	21.0
		2535MHz	20.19	20.65	20.58	21.0	21.0	21.0
		2505MHz	20.00	20.40	20.42	21.0	21.0	21.0
	1RB_24	2565MHz	19.94	20.32	20.29	21.0	21.0	21.0
		2535MHz	20.12	20.64	20.54	21.0	21.0	21.0
		2505MHz	19.96	20.30	20.30	21.0	21.0	21.0
	1RB_0	2565MHz	19.99	20.37	20.37	21.0	21.0	21.0
		2535MHz	19.99	20.49	20.40	21.0	21.0	21.0
		2505MHz	19.80	20.28	20.18	21.0	21.0	21.0
	25RB_25	2565MHz	20.05	20.07	20.15	21.0	21.0	21.0
		2535MHz	20.26	20.33	20.29	21.0	21.0	21.0
		2505MHz	20.00	20.13	20.17	21.0	21.0	21.0
	25RB_12	2565MHz	19.99	20.11	20.12	21.0	21.0	21.0
		2535MHz	20.19	20.29	20.31	21.0	21.0	21.0
		2505MHz	19.99	20.10	20.14	21.0	21.0	21.0
	25RB_0	2565MHz	20.07	20.13	20.12	21.0	21.0	21.0
		2535MHz	20.21	20.29	20.25	21.0	21.0	21.0
		2505MHz	19.99	20.06	20.06	21.0	21.0	21.0
	50RB_0	2565MHz	20.06	20.18	20.25	21.0	21.0	21.0
		2535MHz	20.18	20.29	20.34	21.0	21.0	21.0
		2505MHz	20.00	20.14	20.09	21.0	21.0	21.0



Hotspot								
LTE Band 7			Actual output Power (dBm)			Tune up		
Band -width	RB No. / RB offset	Frequency	Modulation			Modulation		
			QPSK	16QAM	64QAM	QPSK	16QAM	64QAM
15 MHz	1RB_74	2562.5MHz	20.09	20.41	20.29	21.0	21.0	21.0
		2535MHz	20.15	20.60	20.59	21.0	21.0	21.0
		2507.5MHz	20.18	20.58	20.55	21.0	21.0	21.0
	1RB_37	2562.5MHz	19.88	20.27	20.39	21.0	21.0	21.0
		2535MHz	20.14	20.59	20.56	21.0	21.0	21.0
		2507.5MHz	19.96	20.39	20.30	21.0	21.0	21.0
	1RB_0	2562.5MHz	19.98	20.43	20.19	21.0	21.0	21.0
		2535MHz	20.04	20.38	20.45	21.0	21.0	21.0
		2507.5MHz	19.80	20.22	20.15	21.0	21.0	21.0
	36RB_38	2562.5MHz	20.04	20.11	20.26	21.0	21.0	21.0
		2535MHz	20.20	20.35	20.38	21.0	21.0	21.0
		2507.5MHz	20.15	20.22	20.30	21.0	21.0	21.0
	36RB_19	2562.5MHz	20.07	20.18	20.24	21.0	21.0	21.0
		2535MHz	20.25	20.33	20.38	21.0	21.0	21.0
		2507.5MHz	19.99	20.10	20.27	21.0	21.0	21.0
	36RB_0	2562.5MHz	20.07	20.13	20.15	21.0	21.0	21.0
		2535MHz	20.14	20.30	20.30	21.0	21.0	21.0
		2507.5MHz	20.00	20.05	20.10	21.0	21.0	21.0
75RB_0	2562.5MHz	20.11	20.19	20.24	21.0	21.0	21.0	
	2535MHz	20.22	20.29	20.32	21.0	21.0	21.0	
	2507.5MHz	20.03	20.08	20.25	21.0	21.0	21.0	



Hotspot								
LTE Band 7			Actual output Power (dBm)			Tune up		
Band -width	RB No. / RB offset	Frequency	Modulation			Modulation		
			QPSK	16QAM	64QAM	QPSK	16QAM	64QAM
20 MHz	1RB_99	2560MHz	20.06	20.52	20.29	21.0	21.0	21.0
		2535MHz	20.09	20.60	20.59	21.0	21.0	21.0
		2510MHz	20.07	20.56	20.55	21.0	21.0	21.0
	1RB_50	2560MHz	19.95	20.49	20.39	21.0	21.0	21.0
		2535MHz	20.10	20.54	20.56	21.0	21.0	21.0
		2510MHz	19.89	20.33	20.30	21.0	21.0	21.0
	1RB_0	2560MHz	19.92	20.43	20.19	21.0	21.0	21.0
		2535MHz	20.03	20.41	20.45	21.0	21.0	21.0
		2510MHz	19.81	20.21	20.15	21.0	21.0	21.0
	50RB_50	2560MHz	20.11	20.23	20.26	21.0	21.0	21.0
		2535MHz	20.24	20.39	20.38	21.0	21.0	21.0
		2510MHz	20.11	20.24	20.30	21.0	21.0	21.0
	50RB_25	2560MHz	20.09	20.15	20.24	21.0	21.0	21.0
		2535MHz	20.22	20.30	20.38	21.0	21.0	21.0
		2510MHz	20.14	20.22	20.27	21.0	21.0	21.0
	50RB_0	2560MHz	20.02	20.14	20.15	21.0	21.0	21.0
		2535MHz	20.15	20.31	20.30	21.0	21.0	21.0
		2510MHz	19.93	20.07	20.10	21.0	21.0	21.0
	100RB_0	2560MHz	20.07	20.18	20.24	21.0	21.0	21.0
		2535MHz	20.16	20.31	20.32	21.0	21.0	21.0
		2510MHz	20.07	20.18	20.25	21.0	21.0	21.0



Hotspot								
LTE Band 41			Actual output Power (dBm)			Tune up		
Band -width	RB No. / RB offset	Frequency	Modulation			Modulation		
			QPSK	16QAM	64QAM	QPSK	16QAM	64QAM
5 MHz	1RB_24	2687.5MHz	20.01	20.16	19.91	21.0	21.0	21.0
		2640.3MHz	19.97	20.11	19.86	21.0	21.0	21.0
		2593MHz	19.87	20.08	19.84	21.0	21.0	21.0
		2545.8MHz	19.86	20.02	19.78	21.0	21.0	21.0
		2498.5MHz	19.86	20.07	19.82	21.0	21.0	21.0
	1RB_12	2687.5MHz	20.00	20.13	19.93	21.0	21.0	21.0
		2640.3MHz	19.87	20.02	19.73	21.0	21.0	21.0
		2593MHz	19.93	20.08	19.74	21.0	21.0	21.0
		2545.8MHz	19.85	19.98	19.76	21.0	21.0	21.0
		2498.5MHz	19.82	20.08	19.85	21.0	21.0	21.0
	1RB_0	2687.5MHz	19.97	20.11	19.89	21.0	21.0	21.0
		2640.3MHz	19.82	20.01	19.75	21.0	21.0	21.0
		2593MHz	19.93	20.02	19.77	21.0	21.0	21.0
		2545.8MHz	19.85	19.98	19.72	21.0	21.0	21.0
		2498.5MHz	19.90	20.06	19.89	21.0	21.0	21.0
	12RB_13	2687.5MHz	20.03	20.10	20.16	21.0	21.0	21.0
		2640.3MHz	19.86	19.98	19.98	21.0	21.0	21.0
		2593MHz	19.95	20.07	20.09	21.0	21.0	21.0
		2545.8MHz	19.85	19.94	20.01	21.0	21.0	21.0
		2498.5MHz	19.95	19.99	20.08	21.0	21.0	21.0
	12RB_6	2687.5MHz	20.07	20.13	20.22	21.0	21.0	21.0
		2640.3MHz	19.87	19.99	19.99	21.0	21.0	21.0
		2593MHz	19.97	20.05	20.06	21.0	21.0	21.0
		2545.8MHz	19.89	19.96	20.00	21.0	21.0	21.0
		2498.5MHz	19.96	20.06	20.20	21.0	21.0	21.0
	12RB_0	2687.5MHz	20.04	20.09	20.17	21.0	21.0	21.0
		2640.3MHz	19.87	19.92	19.95	21.0	21.0	21.0
		2593MHz	19.91	20.00	20.08	21.0	21.0	21.0
		2545.8MHz	19.84	19.96	19.98	21.0	21.0	21.0
		2498.5MHz	19.89	20.02	20.05	21.0	21.0	21.0
25RB_0	2687.5MHz	20.05	20.17	20.20	21.0	21.0	21.0	
	2640.3MHz	19.89	20.01	20.02	21.0	21.0	21.0	
	2593MHz	19.91	20.05	20.08	21.0	21.0	21.0	
	2545.8MHz	19.87	19.98	20.01	21.0	21.0	21.0	
	2498.5MHz	19.92	20.06	20.14	21.0	21.0	21.0	



Hotspot								
LTE Band 41			Actual output Power (dBm)			Tune up		
Band -width	RB No. / RB offset	Frequency	Modulation			Modulation		
			QPSK	16QAM	64QAM	QPSK	16QAM	64QAM
10 MHz	1RB_49	2685MHz	20.67	20.76	20.47	21.0	21.0	21.0
		2639MHz	20.01	20.10	19.87	21.0	21.0	21.0
		2593MHz	19.97	20.09	19.87	21.0	21.0	21.0
		2547MHz	19.97	20.12	19.85	21.0	21.0	21.0
		2501MHz	19.85	20.04	19.81	21.0	21.0	21.0
	1RB_24	2685MHz	19.97	20.14	19.90	21.0	21.0	21.0
		2639MHz	19.84	20.00	19.72	21.0	21.0	21.0
		2593MHz	19.90	20.10	19.83	21.0	21.0	21.0
		2547MHz	19.91	19.96	19.72	21.0	21.0	21.0
		2501MHz	19.84	20.07	19.72	21.0	21.0	21.0
	1RB_0	2685MHz	20.60	20.77	20.50	21.0	21.0	21.0
		2639MHz	19.83	20.02	19.71	21.0	21.0	21.0
		2593MHz	19.90	20.11	19.82	21.0	21.0	21.0
		2547MHz	19.84	19.99	19.73	21.0	21.0	21.0
		2501MHz	19.88	20.11	19.80	21.0	21.0	21.0
	25RB_25	2685MHz	20.21	20.34	20.41	21.0	21.0	21.0
		2639MHz	19.90	20.02	20.06	21.0	21.0	21.0
		2593MHz	19.95	20.09	20.10	21.0	21.0	21.0
		2547MHz	19.96	20.09	20.12	21.0	21.0	21.0
		2501MHz	19.90	20.07	20.12	21.0	21.0	21.0
	25RB_12	2685MHz	20.09	20.20	20.26	21.0	21.0	21.0
		2639MHz	19.90	20.03	20.06	21.0	21.0	21.0
		2593MHz	19.92	20.10	20.14	21.0	21.0	21.0
		2547MHz	19.87	20.05	20.06	21.0	21.0	21.0
		2501MHz	19.96	20.08	20.12	21.0	21.0	21.0
	25RB_0	2685MHz	20.22	20.34	20.38	21.0	21.0	21.0
		2639MHz	19.86	20.01	20.03	21.0	21.0	21.0
		2593MHz	19.93	20.07	20.08	21.0	21.0	21.0
		2547MHz	19.86	19.99	20.02	21.0	21.0	21.0
		2501MHz	19.89	20.07	20.08	21.0	21.0	21.0
50RB_0	2685MHz	20.24	20.36	20.39	21.0	21.0	21.0	
	2639MHz	19.87	20.04	20.02	21.0	21.0	21.0	
	2593MHz	19.94	20.10	20.07	21.0	21.0	21.0	
	2547MHz	20.00	20.12	20.14	21.0	21.0	21.0	
	2501MHz	19.91	20.06	20.09	21.0	21.0	21.0	



Hotspot								
LTE Band 41			Actual output Power (dBm)			Tune up		
Band -width	RB No. / RB offset	Frequency	Modulation			Modulation		
			QPSK	16QAM	64QAM	QPSK	16QAM	64QAM
15 MHz	1RB_74	2682.5MHz	20.05	20.23	19.90	21.0	21.0	21.0
		2637.8MHz	20.12	20.21	19.95	21.0	21.0	21.0
		2593MHz	20.00	20.23	19.85	21.0	21.0	21.0
		2548.3MHz	20.06	20.21	19.95	21.0	21.0	21.0
		2503.5MHz	20.05	20.17	20.00	21.0	21.0	21.0
	1RB_37	2682.5MHz	20.05	20.21	19.92	21.0	21.0	21.0
		2637.8MHz	19.88	20.08	19.79	21.0	21.0	21.0
		2593MHz	19.96	20.11	19.86	21.0	21.0	21.0
		2548.3MHz	19.91	20.05	19.79	21.0	21.0	21.0
		2503.5MHz	19.97	20.23	19.86	21.0	21.0	21.0
	1RB_0	2682.5MHz	19.99	20.12	19.88	21.0	21.0	21.0
		2637.8MHz	19.92	20.10	19.79	21.0	21.0	21.0
		2593MHz	19.95	20.14	19.85	21.0	21.0	21.0
		2548.3MHz	19.94	20.10	19.81	21.0	21.0	21.0
		2503.5MHz	19.92	20.19	19.81	21.0	21.0	21.0
	36RB_38	2682.5MHz	20.07	20.17	20.22	21.0	21.0	21.0
		2637.8MHz	19.90	19.96	20.00	21.0	21.0	21.0
		2593MHz	19.95	20.07	20.10	21.0	21.0	21.0
		2548.3MHz	20.01	20.13	20.14	21.0	21.0	21.0
		2503.5MHz	19.97	20.02	20.08	21.0	21.0	21.0
	36RB_19	2682.5MHz	20.09	20.13	20.16	21.0	21.0	21.0
		2637.8MHz	19.91	20.01	20.03	21.0	21.0	21.0
		2593MHz	19.97	20.08	20.09	21.0	21.0	21.0
		2548.3MHz	20.06	20.11	20.12	21.0	21.0	21.0
		2503.5MHz	19.91	20.02	20.13	21.0	21.0	21.0
	36RB_0	2682.5MHz	20.06	20.11	20.18	21.0	21.0	21.0
		2637.8MHz	19.91	19.96	20.00	21.0	21.0	21.0
		2593MHz	19.99	20.05	20.11	21.0	21.0	21.0
		2548.3MHz	19.92	19.96	20.04	21.0	21.0	21.0
		2503.5MHz	19.91	20.03	20.10	21.0	21.0	21.0
75RB_0	2682.5MHz	20.07	20.18	20.21	21.0	21.0	21.0	
	2637.8MHz	19.92	20.04	20.06	21.0	21.0	21.0	
	2593MHz	19.94	20.08	20.05	21.0	21.0	21.0	
	2548.3MHz	19.98	20.15	20.10	21.0	21.0	21.0	
	2503.5MHz	19.91	20.11	20.07	21.0	21.0	21.0	



Hotspot								
LTE Band 41			Actual output Power (dBm)			Tune up		
Band -width	RB No. / RB offset	Frequency	Modulation			Modulation		
			QPSK	16QAM	64QAM	QPSK	16QAM	64QAM
20 MHz	1RB_99	2680MHz	20.36	20.55	20.20	21.0	21.0	21.0
		2636.5MHz	20.03	20.23	19.92	21.0	21.0	21.0
		2593MHz	20.01	20.16	19.84	21.0	21.0	21.0
		2549.5MHz	20.12	20.23	19.95	21.0	21.0	21.0
		2506MHz	19.97	20.13	19.79	21.0	21.0	21.0
	1RB_50	2680MHz	20.01	20.09	19.83	21.0	21.0	21.0
		2636.5MHz	19.82	20.04	19.70	21.0	21.0	21.0
		2593MHz	19.94	20.06	19.88	21.0	21.0	21.0
		2549.5MHz	19.90	20.03	19.78	21.0	21.0	21.0
		2506MHz	19.86	20.05	19.77	21.0	21.0	21.0
	1RB_0	2680MHz	20.34	20.47	20.23	21.0	21.0	21.0
		2636.5MHz	19.88	20.11	19.80	21.0	21.0	21.0
		2593MHz	19.94	20.10	19.97	21.0	21.0	21.0
		2549.5MHz	19.95	20.12	19.79	21.0	21.0	21.0
		2506MHz	19.92	20.29	19.65	21.0	21.0	21.0
	50RB_50	2680MHz	20.16	20.27	20.30	21.0	21.0	21.0
		2636.5MHz	19.91	20.06	20.03	21.0	21.0	21.0
		2593MHz	19.98	20.10	20.03	21.0	21.0	21.0
		2549.5MHz	20.02	20.17	20.16	21.0	21.0	21.0
		2506MHz	19.92	20.06	20.08	21.0	21.0	21.0
	50RB_25	2680MHz	20.13	20.21	20.20	21.0	21.0	21.0
		2636.5MHz	19.91	19.99	20.02	21.0	21.0	21.0
		2593MHz	19.94	20.10	20.08	21.0	21.0	21.0
		2549.5MHz	20.03	20.16	20.13	21.0	21.0	21.0
		2506MHz	19.91	20.06	20.06	21.0	21.0	21.0
50RB_0	2680MHz	20.11	20.24	20.28	21.0	21.0	21.0	
	2636.5MHz	19.87	20.05	20.00	21.0	21.0	21.0	
	2593MHz	19.98	20.09	20.08	21.0	21.0	21.0	
	2549.5MHz	19.93	20.03	20.05	21.0	21.0	21.0	
	2506MHz	19.90	20.06	20.07	21.0	21.0	21.0	
100RB_0	2680MHz	20.17	20.25	20.30	21.0	21.0	21.0	
	2636.5MHz	19.93	20.04	20.04	21.0	21.0	21.0	
	2593MHz	19.94	20.11	20.10	21.0	21.0	21.0	
	2549.5MHz	20.02	20.13	20.12	21.0	21.0	21.0	
	2506MHz	19.96	20.06	20.02	21.0	21.0	21.0	



According to November 2017 TCB workshop, Uplink CA SAR Test Guidance as follows:

- a) When the maximum output for UL CA is \leq standalone LTE mode (without CA)
 - PCC is configured according to the highest standalone SAR configuration tested
 - SCC and subsequent CCs are configured according to procedures used for power measurement and parameters (BW, RB etc.) similar to that used for the PCC
- b) When the Reported SAR for UL CA configuration, described above, is $>1.2W/kg$, UL CA SAR is also required for all required test channels (PCC based)
- c) UL CA SAR is also required for standalone SAR configurations $>1.2W/kg$ when they are scaled to the UL CA power level.

The measurement results of downlink LTE 2CA Conducted Power are as below:

CA Config.	PCC						SCC 1			DL CA Power	Tune-up
	Band	Mode	Ch.	Freq.	RB Size	RB Offset	Band	BW	Freq.		
5B	5	QPSK10M	20476	831.6	1	0	5	10	886.5	22.98	24.0
41C	41	QPSK20M	20521	2583.1	1	0	41	20	2602.9	22.48	23.5
41C	41	QPSK20M	20521	2583.1	1	49	41	20	2602.9	22.37	23.5
41C	41	QPSK20M	20521	2583.1	1	99	41	20	2602.9	22.41	23.5
2A+2A	2	QPSK20M	18700	1860.0	1	99	2	20	1980.0	22.19	23.5
2A+4A	2	QPSK20M	18900	1880.0	1	99	4	20	2132.5	22.16	23.5
2A+5A	2	QPSK20M	18900	1880.0	1	99	5	10	881.5	22.21	23.5
2A+12A	2	QPSK20M	18900	1880.0	1	99	12	10	737.5	22.20	23.5
2A+29A	2	QPSK20M	18900	1880.0	1	99	29	10	722.5	22.19	23.5
2A+30A	2	QPSK20M	18900	1880.0	1	99	30	10	2355.0	22.24	23.5
4A+5A	4	QPSK20M	132072	1720.0	1	0	5	10	874.0	22.03	23.0
4A+12A	4	QPSK20M	132072	1720.0	1	0	12	10	1480.9	22.02	23.0
4A+29A	4	QPSK20M	132072	1720.0	1	0	29	10	722.0	22.03	23.0
4A+30A	4	QPSK20M	132072	1720.0	1	0	30	10	2355.0	22.11	23.0
5A+5A	5	QPSK10M	20450	829.0	1	0	5	10	889.0	22.89	24.0
5A+30A	5	QPSK10M	20476	831.6	1	0	30	10	2355.0	22.92	24.0
5A+66A	5	QPSK10M	20476	831.6	1	0	66	20	2145.0	22.86	24.0
7A+7A	7	QPSK20M	20850	2510.0	1	50	7	20	2680.0	22.37	23.5
12A+30A	12	QPSK10M	23095	707.5	1	24	30	10	2355.0	23.01	24.0
12A+66A	12	QPSK10M	23095	707.5	1	24	66	20	2145.0	23.05	24.0
66A+66A	66	QPSK20M	20050	1720.0	1	0	66	20	2145.0	21.97	23.0
25A+25A	25	QPSK20M	26140	1860.0	1	99	25	20	1985.0	22.18	23.5
25A+26A	25	QPSK20M	26365	1882.5	1	99	26	15	831.5	22.21	23.5

Note: Testing is not required in bands or modes not intended/allowed for US operation.



The measurement results of downlink LTE 3CA Conducted Power are as below:

CA Config.	PCC						SCC 1			SCC 2			DL CA Power	Tune Up
	Band	Mode	Ch.	Freq.	RB Size	RB Offset	Band	BW	Freq.	Band	BW	Freq.		
2A-2A-4A	2	QPSK20M	18700	1860	1	99	2	20	1980.0	4	20	2132.5	22.26	23.5
2A-2A-5A	2	QPSK20M	18700	1860	1	99	2	20	1980.0	5	10	881.5	22.21	23.5
2A-4A-4A	2	QPSK20M	18900	1880	1	99	4	20	2132.5	4	20	2132.5	22.31	23.5
2A-4A-5A	2	QPSK20M	18900	1880	1	99	4	20	2132.5	5	10	881.5	22.18	23.5
2A-5A-66A	2	QPSK20M	18900	1880	1	99	5	10	881.5	66	20	2145.0	22.25	23.5
2A-5B	2	QPSK20M	18900	1880	1	99	5	10	876.6	5	10	886.5	22.27	23.5
2A-5A-30A	2	QPSK20M	18900	1880	1	99	5	10	881.5	30	10	2355.0	22.16	23.5
2A-5A-66A	2	QPSK20M	18900	1880	1	99	5	10	881.5	66	20	2145.0	22.23	23.5
2A-12A-30A	2	QPSK20M	18900	1880	1	99	12	10	737.5	30	10	2355.0	22.18	23.5
2A-12A-66A	2	QPSK20M	18900	1880	1	99	12	10	737.5	66	20	2145.0	22.19	23.5
2A-29A-30A	2	QPSK20M	18900	1880	1	99	29	10	722.5	30	10	2355.0	22.22	23.5
4A-4A-5A	4	QPSK20M	20050	1720	1	0	4	20	2145.0	5	10	881.5	22.03	23.0
4A-5A-30A	4	QPSK20M	132072	1720	1	0	5	10	874.0	30	10	2355.0	21.98	23.0
4A-12A-30A	4	QPSK20M	132072	1720	1	0	12	10	1480.9	30	10	2355.0	22.12	23.0
4A-29A-30A	4	QPSK20M	132072	1720	1	0	29	10	722.0	30	10	2355.0	22.04	23.0
5B-66A	5	QPSK10M	20476	831.6	1	0	5	10	886.5	66	20	2145.0	22.95	24.0
5A-66B	5	QPSK10M	20476	831.6	1	0	66	20	2150.1	66	20	2160.0	22.84	24.0
5A-66C	5	QPSK10M	20476	831.6	1	0	66	20	2145.1	66	20	2164.9	22.79	24.0
41D	41	QPSK20M	41094	2640.4	1	0	41	20	2660.2	41	20	2680.0	22.37	23.5

Note: Testing is not required in bands or modes not intended/allowed for US operation.

The measurement results of uplink LTE CA Conducted Power are as below:

CA List	PCC						SCC						Power		Tune up
	LTE	BW	UL	Mod.	UL#	UL	LTE	BW	UL	Mod.	UL#	UL	With CA	Without CA	
	Band	(MHz)	Freq.		RB	RB	Band	(MHz)	Freq.		RB	RB	Power	Tx. Power	
			(MHz)						(MHz)						
Full Power															
CA_5C	Band 5	10M	836.5	QPSK	1	49	Band 5	10M	816.7	QPSK	1	0	23.25	23.31	24.0
CA_41C	Band 41	20M	2680	QPSK	1	99	Band 41	20M	2660.2	QPSK	1	99	22.76	22.89	23.5
Hotspot															
CA_41C	Band 41	20M	2680	QPSK	1	99	Band 41	20M	2660.2	QPSK	1	0	20.28	20.36	21.0

Note: Testing is not required in bands or modes not intended/allowed for US operation.

10.4. WLAN and BT Measurement result

Table 10.6: The conducted Power measurement results for BT

BT	Tune up	Averaged Power (dBm)		
Mode		Ch.0 (2402 MHz)	Ch39 (2441 MHz)	Ch78 (2480 MHz)
GFSK	8.0	7.66	6.95	7.64
EDR2M-4_DQPSK	8.0	6.86	6.17	6.77
EDR3M-8DPSK	8.0	7.29	6.53	7.21
/	/	Ch0 (2402MHz)	Ch19 (2440MHz)	Ch39 (2480MHz)
BLE	-2.5	-3.99	-4.34	-2.94

Table 10.7: The conducted Power measurement results for WLAN 2.4G

WLAN 2.4GHz	Tune up	Averaged Power (dBm) Duty Cycle: 100%		
Mode		Ch.1(2412 MHz)	Ch.6(2437Mhz)	Ch.11(2462MHz)
802.11b	16.5	16.14	16.10	16.11
802.11g	14.5	13.75	13.77	13.66
802.11n(20MHz)	14.5	13.77	13.75	13.58
/	/	Ch.3(2422 MHz)	Ch.6(2437Mhz)	Ch.9(2452MHz)
802.11n(40MHz)	15.0	14.18	14.08	14.14

Table 10.8: The conducted Power measurement results for WLAN 5G

Averaged Power (dBm) Duty Cycle: 100%								
Mode	802.11a	802.11n -20MHz	802.11ac -20MHz	Mode	802.11n -40MHz	802.11ac -40MHz	Mode	802.11ac -80MHz
Channel	6Mbps	MCS0	MCS0	Channel	MCS0	MCS0	Channel	MCS0
<U-NII-1>								
Tune up	16.0	16.0	14.0	/	16.0	14.0	/	14.0
36(5180MHz)	15.60	15.48	13.57	38(5190MHz)	15.39	13.36	42(5210MHz)	13.38
40(5200MHz)	15.40	15.32	13.45	46(5230MHz)	14.79	12.82	/	/
44(5220MHz)	15.35	15.34	13.35	/	/	/	/	/
48(5240MHz)	14.88	14.80	12.89	/	/	/	/	/
<U-NII-2A>								
Tune up	15.0	15.0	13.0	/	15.0	13.0	/	13.0
52(5260MHz)	14.47	14.44	12.77	54(5270MHz)	14.31	12.37	58(5290MHz)	12.28
56(5280MHz)	14.33	14.27	12.48	62(5310MHz)	13.93	11.85	/	/
60(5300MHz)	14.29	14.22	12.22	/	/	/	/	/
64(5320MHz)	14.33	14.21	12.50	/	/	/	/	/
<U-NII-2C>								
Tune up	16.0	16.0	14.0	/	16.0	14.0	/	14.0
100(5500MHz)	15.39	15.37	13.42	102(5510MHz)	15.22	13.12	106(5530MHz)	13.37
116(5580MHz)	15.17	15.08	13.13	110(5550MHz)	15.16	13.16	122(5610MHz)	12.71
124(5620MHz)	14.84	14.82	12.81	126(5630MHz)	14.53	12.40	138(5690MHz)	12.46
132(5660MHz)	14.67	14.66	12.75	134(5670MHz)	14.52	12.51	/	/
140(5700MHz)	14.56	14.52	12.49	142(5710MHz)	14.28	12.19	/	/
144(5720MHz)	14.56	14.53	12.46	/	/	/	/	/
< U-NII-3 >								
Tune up	15.0	15.0	13.0	/	15.0	13.0	/	13.0
149(5745MHz)	14.76	14.73	12.73	151(5755MHz)	14.50	12.46	155(5775MHz)	12.25
157(5785MHz)	14.36	14.23	12.38	159(5795MHz)	14.02	12.03	/	/
165(5825MHz)	14.08	14.01	12.09	/	/	/	/	/

11. Simultaneous TX SAR Considerations

11.1. Introduction

The following procedures adopted from “FCC SAR Considerations for Cell Phones with Multiple Transmitters” are applicable to handsets with built-in unlicensed transmitters such as 802.11 a/b/g and Bluetooth devices which may simultaneously transmit with the licensed transmitter. For this device, the BT and WLAN can transmit simultaneous with other transmitters.

11.2. Transmit Antenna Separation Distances

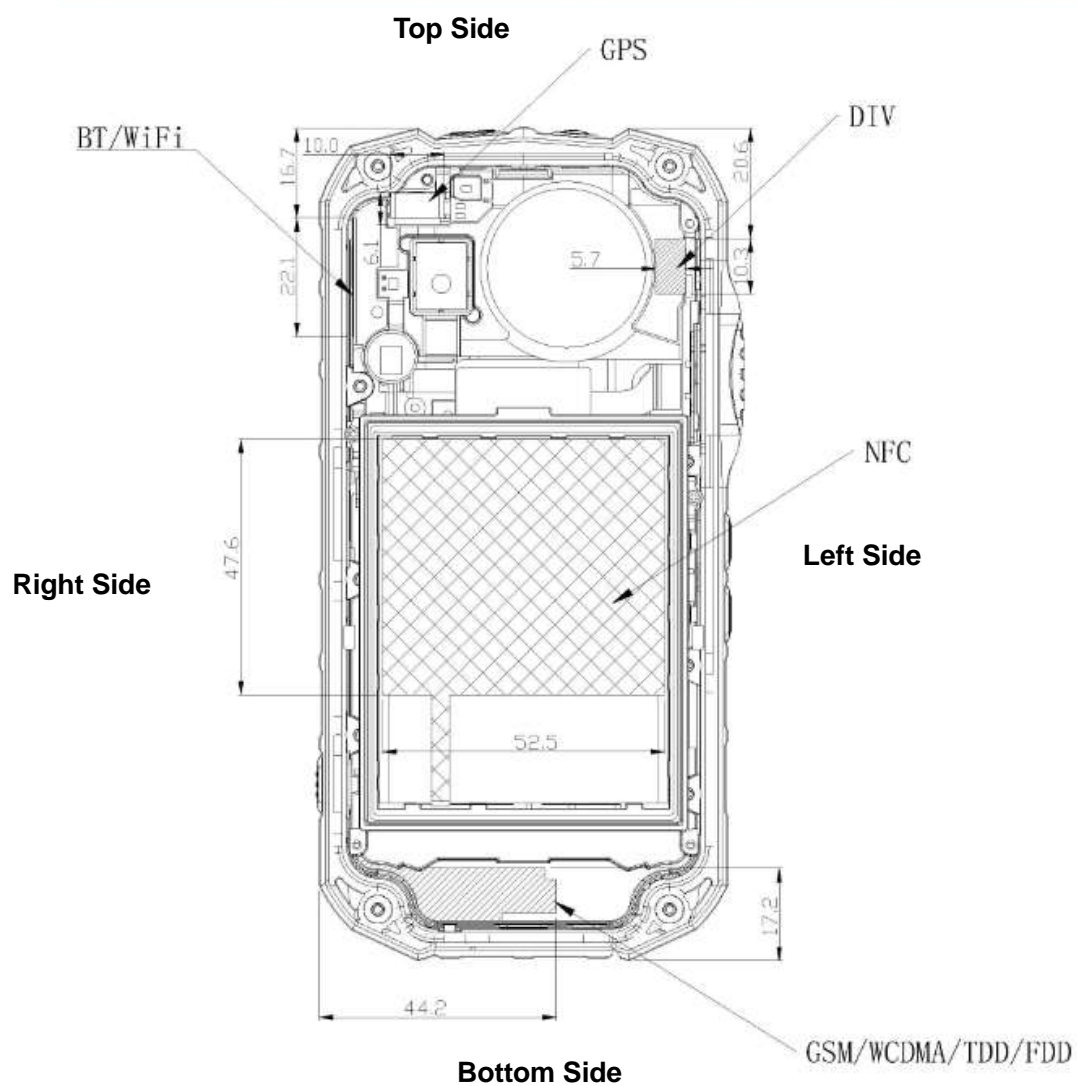

Picture 11.1 Antenna Locations (Back View)

11.3. SAR Measurement Positions

According to the KDB941225 D06 Hot Spot SAR, the edges with less than 25mm distance to the antennas need to be tested for SAR.

SAR measurement positions						
Mode	Front	Rear	Left edge	Right edge	Top edge	Bottom edge
Main antenna	Yes	Yes	No	Yes	No	Yes
WLAN antenna	Yes	Yes	No	Yes	Yes	No

11.4. Standalone SAR Test Exclusion Considerations

Standalone 1-g head or body SAR evaluation by measurement or numerical simulation is not required when the corresponding SAR Exclusion Threshold condition, listed below, is satisfied. The 1-g SAR test exclusion threshold for 100 MHz to 6 GHz at test separation distances ≤ 50 mm are determined by:

$[(\text{max. power of channel, including tune-up tolerance, mW}) / (\text{min. test separation distance, mm})] \cdot [\sqrt{f(\text{GHz})}] \leq 3.0$ for 1-g SAR, where

- $f(\text{GHz})$ is the RF channel transmit frequency in GHz
- Power and distance are rounded to the nearest mW and mm before calculation
- The result is rounded to one decimal place for comparison

Table 11.1: Standalone SAR test exclusion considerations

Band/Mode	f(GHz)	Position	SAR test exclusion threshold (mW)	RF output power		SAR test exclusion
				dBm	mW	
Bluetooth	2.441	Head	9.60	8	6.31	Yes
		Body	19.20	8	6.31	Yes
WLAN 2.4GHz	2.45	Head	9.58	16.5	44.67	No
		Body	19.17	16.5	44.67	No
WLAN 5GHz	5.2	Head	6.58	16	39.81	No
		Body	13.16	16	39.81	No
	5.3	Head	6.52	15	31.62	No
		Body	13.03	15	31.62	No
	5.6	Head	6.34	16	39.81	No
		Body	12.68	16	39.81	No
	5.8	Head	6.23	15	31.62	No
		Body	12.46	15	31.62	No

12. Evaluation of Simultaneous

Table 12.1: The sum of reported SAR values for main antenna and WLAN

/	Position	Main Antenna (W/kg)	WLAN (W/kg)	Sum (W/kg)
Highest reported SAR value for Head	Left Touch	0.51	1.08	1.59
Highest reported SAR value for Hotspot	Front Side	0.75	0.29	1.04
Highest reported SAR value for Body-worn	Front Side	0.75	0.29	1.04

Note: the test positions of above tables are for the worse case that has been evaluated.

Table 12.2: The sum of reported SAR values for main antenna and Bluetooth

/	Position	Main Antenna (W/kg)	Bluetooth (W/kg)	Sum (W/kg)
Highest reported SAR value for Head	Right Touch	0.79	0.29	1.08
Highest reported SAR value for Hotspot	Front Side	0.75	0.15	0.90
Highest reported SAR value for Body-worn	Front Side	0.75	0.15	0.90

Note: the test positions of above tables are for the worse case that has been evaluated.

Estimated SAR for Bluetooth (see the table 12.3)

Table 12.3: Estimated SAR for Bluetooth

Position	f (GHz)	Distance (mm)	Upper limit of power *		Estimated _{1g} (W/kg)
			dBm	mW	
Head	2.441	5	8.5	7.08	0.29
Body	2.441	10	8.5	7.08	0.15

* - Maximum possible output power declared by manufacturer

When standalone SAR test exclusion applies to an antenna that transmits simultaneously with other antennas, the standalone SAR must be estimated according to following to determine simultaneous transmission SAR test exclusion:

(max. power of channel, including tune-up tolerance, mW) / (min. test separation distance, mm) · [$\sqrt{f(\text{GHz})/x}$] W/kg for test separation distances ≤ 50 mm;

Where $x = 7.5$ for 1-g SAR.

When the minimum test separation distance is < 5 mm, a distance of 5 mm is applied to determine SAR test exclusion

Conclusion:

According to the above tables, the sum of reported SAR values is 1.59W/kg. So the simultaneous transmission SAR with volume scans is not required.

13. Summary of Test Results

According to the client's decision rule in the test registration form, which is "based on the measurement results as the basis of the conformity statement", the test conclusion of this report meets the limit requirements.

The calculated SAR is obtained by the following formula:

$$\text{Reported SAR} = \text{Measured SAR} \times 10^{(P_{\text{Target}} - P_{\text{Measured}})/10}$$

Where P_{Target} is the power of manufacturing upper limit;

P_{Measured} is the measured power in chapter 10.

Duty Cycle

Mode	Duty Cycle
Speech for GSM850/1900	1:8.3
GPRS for GSM850	1:4
GPRS for GSM1900	1:2.67
WCDMA Band 2/4/5	1:1
FDD_LTE 5/7/12/13/25/26/30/66	1:1
TDD_LTE Band 41	1:1.58

Testing Environment

Temperature:	18°C~25°C
Relative humidity:	30%~70%
Ground system resistance:	<4Ω
Ambient noise & Reflection:	< 0.012 W/kg

13.1. SAR results

Table 13.1: SAR Values (GSM 850 - Head)

Frequency		Test Mode	Test Position	Figure No.	Conducted Power (dBm)	Max. tune-up Power (dBm)	Measured SAR(1g) (W/kg)	Reported SAR(1g) (W/kg)	Power Drift(dB)
MHz	Ch.								
		Ambient Temperature: 22.4°C		Liquid Temperature: 22.0°C					
848.8	251	GPRS	Left Touch	/	31.17	31.5	0.469	0.51	-0.12
848.8	251	GPRS	Left Tilt	/	31.17	31.5	0.388	0.42	-0.03
848.8	251	GPRS	Right Touch	Fig.1	31.17	31.5	0.728	0.79	-0.05
848.8	251	GPRS	Right Tilt	/	31.17	31.5	0.419	0.45	0.02

Table 13.2: SAR Values (GSM 850 -Body)

Frequency		Test Mode	Test Position	Figure No.	Conducted Power (dBm)	Max. tune-up Power (dBm)	Measured SAR(1g) (W/kg)	Reported SAR(1g) (W/kg)	Power Drift(dB)
MHz	Ch.								
		Ambient Temperature: 22.4°C		Liquid Temperature: 22.0°C					
Hotspot / Body-Worn Test Data (10mm)									
848.8	251	GPRS	Front	Fig.2	31.17	31.5	0.554	0.60	-0.13
848.8	251	GPRS	Rear	/	31.17	31.5	0.480	0.52	-0.13
848.8	251	GPRS	Right	/	31.17	31.5	0.269	0.29	-0.09
848.8	251	GPRS	Bottom	/	31.17	31.5	0.299	0.32	-0.03

Table 13.3: SAR Values (GSM 1900 - Head)

Frequency		Test Mode	Test Position	Figure No.	Conducted Power (dBm)	Max. tune-up Power (dBm)	Measured SAR(1g) (W/kg)	Reported SAR(1g) (W/kg)	Power Drift(dB)
MHz	Ch.								
Ambient Temperature: 22.9°C Liquid Temperature: 22.4°C									
1909.8	810	GPRS	Left Touch	/	26.44	27.0	0.299	0.34	-0.12
1909.8	810	GPRS	Left Tilt	/	26.44	27.0	0.080	0.09	0.11
1909.8	810	GPRS	Right Touch	Fig.3	26.44	27.0	0.498	0.57	-0.02
1909.8	810	GPRS	Right Tilt	/	26.44	27.0	0.105	0.12	0.02

Table 13.4: SAR Values (GSM 1900 - Body)

Frequency		Test Mode	Test Position	Figure No.	Conducted Power (dBm)	Max. tune-up Power (dBm)	Measured SAR(1g) (W/kg)	Reported SAR(1g) (W/kg)	Power Drift(dB)
MHz	Ch.								
Ambient Temperature: 22.9°C Liquid Temperature: 22.4°C									
Hotspot / Body-Worn Test Data (10mm)									
1909.8	810	GPRS	Front	Fig.4	26.44	27.0	0.332	0.38	-0.12
1909.8	810	GPRS	Rear	/	26.44	27.0	0.278	0.32	-0.03
1909.8	810	GPRS	Right	/	26.44	27.0	0.232	0.26	-0.08
1909.8	810	GPRS	Bottom	/	26.44	27.0	0.152	0.17	-0.05

Table 13.5: SAR Values (WCDMA Band 2 - Head)

Frequency		Test Mode	Test Position	Figure No.	Conducted Power (dBm)	Max. tune-up Power (dBm)	Measured SAR(1g) (W/kg)	Reported SAR(1g) (W/kg)	Power Drift(dB)
MHz	Ch.								
		Ambient Temperature: 22.9°C		Liquid Temperature: 22.4°C					
1907.6	9538	RMC	Left Touch	/	22.91	23.5	0.286	0.33	0.06
1907.6	9538	RMC	Left Tilt	/	22.91	23.5	0.089	0.10	-0.03
1907.6	9538	RMC	Right Touch	Fig.5	22.91	23.5	0.671	0.77	-0.09
1907.6	9538	RMC	Right Tilt	/	22.91	23.5	0.127	0.15	0.04

Table 13.6: SAR Values (WCDMA Band 2 - Body)

Frequency		Test Mode	Test Position	Figure No.	Conducted Power (dBm)	Max. tune-up Power (dBm)	Measured SAR(1g) (W/kg)	Reported SAR(1g) (W/kg)	Power Drift(dB)
MHz	Ch.								
		Ambient Temperature: 22.9°C		Liquid Temperature: 22.4°C					
Hotspot / Body-Worn Test Data (10mm)									
1907.6	9538	RMC	Front	Fig.6	22.91	23.5	0.588	0.67	-0.06
1907.6	9538	RMC	Rear	/	22.91	23.5	0.516	0.59	-0.05
1907.6	9538	RMC	Right	/	22.91	23.5	0.494	0.57	-0.08
1907.6	9538	RMC	Bottom	/	22.91	23.5	0.280	0.32	-0.13

Table 13.7: SAR Values (WCDMA Band 4 - Head)

Frequency		Test Mode	Test Position	Figure No.	Conducted Power (dBm)	Max. tune-up Power (dBm)	Measured SAR(1g) (W/kg)	Reported SAR(1g) (W/kg)	Power Drift(dB)
MHz	Ch.								
		Ambient Temperature: 22.8°C		Liquid Temperature: 22.2°C					
1712.4	1312	RMC	Left Touch	/	22.37	23.0	0.319	0.37	0.05
1712.4	1312	RMC	Left Tilt	/	22.37	23.0	0.242	0.28	-0.02
1712.4	1312	RMC	Right Touch	Fig.7	22.37	23.0	0.515	0.60	-0.06
1712.4	1312	RMC	Right Tilt	/	22.37	23.0	0.355	0.41	-0.05

Table 13.8: SAR Values (WCDMA Band 4 - Body)

Frequency		Test Mode	Test Position	Figure No.	Conducted Power (dBm)	Max. tune-up Power (dBm)	Measured SAR(1g) (W/kg)	Reported SAR(1g) (W/kg)	Power Drift(dB)
MHz	Ch.								
		Ambient Temperature: 22.8°C		Liquid Temperature: 22.2°C					
Hotspot / Body-Worn Test Data (10mm)									
1712.4	1312	RMC	Front	Fig.8	22.37	23.0	0.648	0.75	-0.08
1712.4	1312	RMC	Rear	/	22.37	23.0	0.365	0.42	-0.07
1712.4	1312	RMC	Right	/	22.37	23.0	0.469	0.54	0.01
1712.4	1312	RMC	Bottom	/	22.37	23.0	0.269	0.31	-0.13

Table 13.9: SAR Values (WCDMA Band 5 - Head)

Frequency		Test Mode	Test Position	Figure No.	Conducted Power (dBm)	Max. tune-up Power (dBm)	Measured SAR(1g) (W/kg)	Reported SAR(1g) (W/kg)	Power Drift(dB)
MHz	Ch.								
		Ambient Temperature: 22.4°C				Liquid Temperature: 22.0°C			
846.6	4233	RMC	Left Touch	/	22.98	23.5	0.407	0.46	0.03
846.6	4233	RMC	Left Tilt	/	22.98	23.5	0.227	0.26	-0.05
846.6	4233	RMC	Right Touch	Fig.9	22.98	23.5	0.423	0.48	0.05
846.6	4233	RMC	Right Tilt	/	22.98	23.5	0.254	0.29	-0.14

Table 13.10: SAR Values (WCDMA Band 5 -Body)

Frequency		Test Mode	Test Position	Figure No.	Conducted Power (dBm)	Max. tune-up Power (dBm)	Measured SAR(1g) (W/kg)	Reported SAR(1g) (W/kg)	Power Drift(dB)
MHz	Ch.								
		Ambient Temperature: 22.4°C				Liquid Temperature: 22.0°C			
Hotspot / Body-Worn Test Data (10mm)									
846.6	4233	846.6	Front	Fig.10	22.98	23.5	0.356	0.40	0.01
846.6	4233	846.6	Rear	/	22.98	23.5	0.303	0.34	-0.15
846.6	4233	846.6	Right	/	22.98	23.5	0.197	0.22	-0.04
846.6	4233	846.6	Bottom	/	22.98	23.5	0.226	0.25	-0.03

Table 13.11: SAR Values (LTE Band 5 - Head)

Frequency		Test Mode	Test Position	Figure No.	Ambient Temperature: 22.4°C		Liquid Temperature: 22.0°C		
MHz	Ch.				Conducted Power (dBm)	Max. tune-up Power (dBm)	Measured SAR(1g) (W/kg)	Reported SAR(1g) (W/kg)	Power Drift(dB)
836.5	20525	1RB_49	Left Touch	/	23.31	24.0	0.428	0.50	0.05
836.5	20525	1RB_49	Left Tilt	/	23.31	24.0	0.278	0.33	-0.09
836.5	20525	1RB_49	Right Touch	Fig.11	23.31	24.0	0.513	0.60	-0.05
836.5	20525	1RB_49	Right Tilt	/	23.31	24.0	0.278	0.33	-0.12
836.5	20525	25RB_12	Left Touch	/	22.37	23.0	0.410	0.47	-0.06
836.5	20525	25RB_12	Left Tilt	/	22.37	23.0	0.222	0.26	-0.07
836.5	20525	25RB_12	Right Touch	/	22.37	23.0	0.416	0.48	-0.03
836.5	20525	25RB_12	Right Tilt	/	22.37	23.0	0.218	0.25	-0.03
The worst case with CA									
836.5	20525	1RB_0	Right Touch	/	23.25	24.0	0.496	0.59	0.08

Table 13.12: SAR Values (LTE Band 5 - Body)

Frequency		Test Mode	Test Position	Figure No.	Ambient Temperature: 22.4°C		Liquid Temperature: 22.0°C		
MHz	Ch.				Conducted Power (dBm)	Max. tune-up Power (dBm)	Measured SAR(1g) (W/kg)	Reported SAR(1g) (W/kg)	Power Drift(dB)
Hotspot / Body-Worn Test Data (10mm)									
836.5	20525	1RB_49	Front	/	23.31	24.0	0.288	0.34	-0.03
836.5	20525	1RB_49	Rear	Fig.12	23.31	24.0	0.308	0.36	-0.11
836.5	20525	1RB_49	Right	/	23.31	24.0	0.190	0.22	0.04
836.5	20525	1RB_49	Bottom	/	23.31	24.0	0.187	0.22	-0.09
836.5	20525	25RB_12	Front	/	22.37	23.0	0.289	0.33	0.02
836.5	20525	25RB_12	Rear	/	22.37	23.0	0.259	0.30	0.03
836.5	20525	25RB_12	Right	/	22.37	23.0	0.149	0.17	0.09
836.5	20525	25RB_12	Bottom	/	22.37	23.0	0.152	0.18	-0.09
The worst case with CA									
836.5	20525	1RB_0	Rear	/	23.25	24.0	0.294	0.35	0.04

Table 13.13: SAR Values (LTE Band 7 - Head)

Frequency		Test Mode	Test Position	Figure No.	Ambient Temperature: 22.5°C		Liquid Temperature: 22.0°C		
MHz	Ch.				Conducted Power (dBm)	Max. tune-up Power (dBm)	Measured SAR(1g) (W/kg)	Reported SAR(1g) (W/kg)	Power Drift(dB)
2535	21100	1RB_50	Left Touch	Fig.13	22.75	23.5	0.409	0.49	0.06
2535	21100	1RB_50	Left Tilt	/	22.75	23.5	0.190	0.23	0.02
2535	21100	1RB_50	Right Touch	/	22.75	23.5	0.378	0.45	-0.16
2535	21100	1RB_50	Right Tilt	/	22.75	23.5	0.305	0.36	-0.04
2535	21100	50RB_50	Left Touch	/	21.87	22.5	0.376	0.43	0.03
2535	21100	50RB_50	Left Tilt	/	21.87	22.5	0.143	0.17	0.08
2535	21100	50RB_50	Right Touch	/	21.87	22.5	0.305	0.35	0.05
2535	21100	50RB_50	Right Tilt	/	21.87	22.5	0.234	0.27	0.10

Table 13.14: SAR Values (LTE Band 7 - Body)

Frequency		Test Mode	Test Position	Figure No.	Ambient Temperature: 22.5°C		Liquid Temperature: 22.0°C		
MHz	Ch.				Conducted Power (dBm)	Max. tune-up Power (dBm)	Measured SAR(1g) (W/kg)	Reported SAR(1g) (W/kg)	Power Drift(dB)
Hotspot Test Data (10mm)									
2535	21100	1RB_50	Front	/	20.10	21.0	0.412	0.51	-0.02
2535	21100	1RB_50	Rear	/	20.10	21.0	0.383	0.47	0.04
2535	21100	1RB_50	Right	/	20.10	21.0	0.345	0.42	0.05
2535	21100	1RB_50	Bottom	/	20.10	21.0	0.201	0.25	0.03
2535	21100	50RB_50	Front	/	20.24	21.0	0.431	0.51	0.08
2535	21100	50RB_50	Rear	/	20.24	21.0	0.403	0.48	0.03
2535	21100	50RB_50	Right	/	20.24	21.0	0.096	0.11	0.02
2535	21100	50RB_50	Bottom	/	20.24	21.0	0.222	0.26	0.10
Body-Worn Test Data (15mm)									
2535	21100	1RB_50	Front	/	22.75	23.5	0.346	0.41	0.01
2535	21100	1RB_50	Rear	Fig.14	22.75	23.5	0.481	0.57	0.07
2535	21100	50RB_50	Front	/	21.87	22.5	0.286	0.33	0.06
2535	21100	50RB_50	Rear	/	21.87	22.5	0.398	0.46	0.13

Table 13.15: SAR Values (LTE Band 12 - Head)

Frequency		Test Mode	Test Position	Figure No.	Ambient Temperature: 22.7°C		Liquid Temperature: 22.2°C		
MHz	Ch.				Conducted Power (dBm)	Max. tune-up Power (dBm)	Measured SAR(1g) (W/kg)	Reported SAR(1g) (W/kg)	Power Drift(dB)
707.5	23095	1RB_24	Left Touch	/	23.34	24.0	0.252	0.29	-0.16
707.5	23095	1RB_24	Left Tilt	/	23.34	24.0	0.159	0.19	-0.04
707.5	23095	1RB_24	Right Touch	Fig.15	23.34	24.0	0.261	0.30	0.01
707.5	23095	1RB_24	Right Tilt	/	23.34	24.0	0.183	0.21	-0.17
704	23060	25RB_12	Left Touch	/	22.37	23.0	0.239	0.28	0.03
704	23060	25RB_12	Left Tilt	/	22.37	23.0	0.155	0.18	-0.18
704	23060	25RB_12	Right Touch	/	22.37	23.0	0.250	0.29	-0.11
704	23060	25RB_12	Right Tilt	/	22.37	23.0	0.176	0.20	-0.11

Table 13.16: SAR Values (LTE Band 12 - Body)

Frequency		Test Mode	Test Position	Figure No.	Ambient Temperature: 22.7°C		Liquid Temperature: 22.2°C		
MHz	Ch.				Conducted Power (dBm)	Max. tune-up Power (dBm)	Measured SAR(1g) (W/kg)	Reported SAR(1g) (W/kg)	Power Drift(dB)
Hotspot / Body-Worn Test Data (10mm)									
707.5	23095	1RB_24	Front	Fig.16	23.34	24.0	0.259	0.30	-0.15
707.5	23095	1RB_24	Rear	/	23.34	24.0	0.169	0.20	-0.03
707.5	23095	1RB_24	Right	/	23.34	24.0	0.223	0.26	-0.16
707.5	23095	1RB_24	Bottom	/	23.34	24.0	0.079	0.09	-0.14
704	23060	25RB_12	Front	/	22.37	23.0	0.253	0.29	0.00
704	23060	25RB_12	Rear	/	22.37	23.0	0.177	0.20	-0.02
704	23060	25RB_12	Right	/	22.37	23.0	0.219	0.25	0.00
704	23060	25RB_12	Bottom	/	22.37	23.0	0.071	0.08	-0.07

Note: SAR for LTE Band 17 is covered by LTE Band 12 due to similar frequency range, same maximum tune-up limit and same channel bandwidth.

Table 13.17: SAR Values (LTE Band 13 - Head)

Frequency		Test Mode	Test Position	Figure No.	Ambient Temperature: 22.7°C		Liquid Temperature: 22.2°C		
MHz	Ch.				Conducted Power (dBm)	Max. tune-up Power (dBm)	Measured SAR(1g) (W/kg)	Reported SAR(1g) (W/kg)	Power Drift(dB)
782	23230	1RB_49	Left Touch	Fig.17	23.16	24.0	0.385	0.47	-0.05
782	23230	1RB_49	Left Tilt	/	23.16	24.0	0.239	0.29	-0.03
782	23230	1RB_49	Right Touch	/	23.16	24.0	0.338	0.41	-0.15
782	23230	1RB_49	Right Tilt	/	23.16	24.0	0.234	0.28	-0.07
782	23230	25RB_25	Left Touch	/	22.18	23.0	0.287	0.35	0.02
782	23230	25RB_25	Left Tilt	/	22.18	23.0	0.216	0.26	-0.04
782	23230	25RB_25	Right Touch	/	22.18	23.0	0.289	0.35	-0.13
782	23230	25RB_25	Right Tilt	/	22.18	23.0	0.205	0.25	-0.19

Table 13.18: SAR Values (LTE Band 13 - Body)

Frequency		Test Mode	Test Position	Figure No.	Ambient Temperature: 22.7°C		Liquid Temperature: 22.2°C		
MHz	Ch.				Conducted Power (dBm)	Max. tune-up Power (dBm)	Measured SAR(1g) (W/kg)	Reported SAR(1g) (W/kg)	Power Drift(dB)
Hotspot / Body-Worn Test Data (10mm)									
782	23230	1RB_49	Front	Fig.18	23.16	24.0	0.349	0.42	0.02
782	23230	1RB_49	Rear	/	23.16	24.0	0.297	0.36	-0.02
782	23230	1RB_49	Right	/	23.16	24.0	0.269	0.33	-0.04
782	23230	1RB_49	Bottom	/	23.16	24.0	0.100	0.12	-0.08
782	23230	25RB_25	Front	/	22.18	23.0	0.301	0.36	-0.18
782	23230	25RB_25	Rear	/	22.18	23.0	0.270	0.33	-0.16
782	23230	25RB_25	Right	/	22.18	23.0	0.251	0.30	-0.06
782	23230	25RB_25	Bottom	/	22.18	23.0	0.087	0.11	-0.09

Table 13.19: SAR Values (LTE Band 14 - Head)

Frequency		Test Mode	Test Position	Figure No.	Conducted Power (dBm)	Max. tune-up Power (dBm)	Measured SAR(1g) (W/kg)	Reported SAR(1g) (W/kg)	Power Drift(dB)
MHz	Ch.								
Ambient Temperature: 22.7°C Liquid Temperature: 22.2°C									
793	23330	1RB_24	Left Touch	Fig.19	23.13	24.0	0.411	0.50	-0.03
793	23330	1RB_24	Left Tilt	/	23.13	24.0	0.268	0.33	-0.04
793	23330	1RB_24	Right Touch	/	23.13	24.0	0.383	0.47	-0.04
793	23330	1RB_24	Right Tilt	/	23.13	24.0	0.265	0.32	-0.05
793	23330	25RB_25	Left Touch	/	22.25	23.0	0.375	0.45	-0.12
793	23330	25RB_25	Left Tilt	/	22.25	23.0	0.235	0.28	-0.11
793	23330	25RB_25	Right Touch	/	22.25	23.0	0.369	0.44	-0.12
793	23330	25RB_25	Right Tilt	/	22.25	23.0	0.242	0.29	-0.17

Table 13.20: SAR Values (LTE Band 14 - Body)

Frequency		Test Mode	Test Position	Figure No.	Conducted Power (dBm)	Max. tune-up Power (dBm)	Measured SAR(1g) (W/kg)	Reported SAR(1g) (W/kg)	Power Drift(dB)
MHz	Ch.								
Ambient Temperature: 22.7°C Liquid Temperature: 22.2°C									
Hotspot / Body-Worn Test Data (10mm)									
793	23330	1RB_24	Front	Fig.20	23.13	24.0	0.411	0.50	-0.01
793	23330	1RB_24	Rear	/	23.13	24.0	0.336	0.41	-0.14
793	23330	1RB_24	Right	/	23.13	24.0	0.304	0.37	-0.09
793	23330	1RB_24	Bottom	/	23.13	24.0	0.072	0.09	-0.10
793	23330	25RB_25	Front	/	22.25	23.0	0.363	0.43	-0.03
793	23330	25RB_25	Rear	/	22.25	23.0	0.300	0.36	-0.15
793	23330	25RB_25	Right	/	22.25	23.0	0.263	0.31	-0.08
793	23330	25RB_25	Bottom	/	22.25	23.0	0.063	0.07	-0.13

Table 13.21: SAR Values (LTE Band 25 - Head)

Frequency		Test Mode	Test Position	Figure No.	Conducted Power (dBm)	Max. tune-up Power (dBm)	Measured SAR(1g) (W/kg)	Reported SAR(1g) (W/kg)	Power Drift(dB)
Ambient Temperature: 22.9°C	Liquid Temperature: 22.4°C								
1882.5	26365	1RB_0	Left Touch	/	22.66	23.5	0.324	0.39	0.06
1882.5	26365	1RB_0	Left Tilt	/	22.66	23.5	0.099	0.12	0.01
1882.5	26365	1RB_0	Right Touch	Fig.21	22.66	23.5	0.648	0.79	0.17
1882.5	26365	1RB_0	Right Tilt	/	22.66	23.5	0.144	0.17	0.18
1905	26590	50RB_0	Left Touch	/	21.91	22.5	0.230	0.26	0.09
1905	26590	50RB_0	Left Tilt	/	21.91	22.5	0.073	0.08	-0.02
1905	26590	50RB_0	Right Touch	/	21.91	22.5	0.444	0.51	0.04
1905	26590	50RB_0	Right Tilt	/	21.91	22.5	0.104	0.12	0.07

Table 13.22: SAR Values (LTE Band 25 - Body)

Frequency		Test Mode	Test Position	Figure No.	Conducted Power (dBm)	Max. tune-up Power (dBm)	Measured SAR(1g) (W/kg)	Reported SAR(1g) (W/kg)	Power Drift(dB)
Ambient Temperature: 22.9°C	Liquid Temperature: 22.4°C								
Hotspot / Body-Worn Test Data (10mm)									
1882.5	26365	1RB_0	Front	/	22.66	23.5	0.270	0.33	-0.09
1882.5	26365	1RB_0	Rear	Fig.22	22.66	23.5	0.279	0.34	0.03
1882.5	26365	1RB_0	Right	/	22.66	23.5	0.221	0.27	-0.07
1882.5	26365	1RB_0	Bottom	/	22.66	23.5	0.128	0.16	-0.06
1905	26590	50RB_0	Front	/	21.91	22.5	0.180	0.21	-0.03
1905	26590	50RB_0	Rear	/	21.91	22.5	0.211	0.24	-0.06
1905	26590	50RB_0	Right	/	21.91	22.5	0.166	0.19	-0.12
1905	26590	50RB_0	Bottom	/	21.91	22.5	0.092	0.11	-0.09

Note: SAR for LTE Band 2 is covered by LTE Band 25 due to similar frequency range, same maximum tune-up limit and same channel bandwidth.

Table 13.23: SAR Values (LTE Band 26 - Head)

Frequency		Test Mode	Test Position	Figure No.	Ambient Temperature: 22.8°C		Liquid Temperature: 22.3°C		
MHz	Ch.				Conducted Power (dBm)	Max. tune-up Power (dBm)	Measured SAR(1g) (W/kg)	Reported SAR(1g) (W/kg)	Power Drift(dB)
841.5	26965	1RB_74	Left Touch	/	23.24	24.0	0.415	0.49	-0.05
841.5	26965	1RB_74	Left Tilt	/	23.24	24.0	0.233	0.28	-0.04
841.5	26965	1RB_74	Right Touch	Fig.23	23.24	24.0	0.462	0.55	-0.03
841.5	26965	1RB_74	Right Tilt	/	23.24	24.0	0.270	0.32	-0.10
841.5	26965	36RB_0	Left Touch	/	22.25	23.0	0.357	0.42	-0.02
841.5	26965	36RB_0	Left Tilt	/	22.25	23.0	0.173	0.21	-0.05
841.5	26965	36RB_0	Right Touch	/	22.25	23.0	0.351	0.42	-0.09
841.5	26965	36RB_0	Right Tilt	/	22.25	23.0	0.201	0.24	-0.15

Table 13.24: SAR Values (LTE Band 26 - Body)

Frequency		Test Mode	Test Position	Figure No.	Ambient Temperature: 22.8°C		Liquid Temperature: 22.3°C		
MHz	Ch.				Conducted Power (dBm)	Max. tune-up Power (dBm)	Measured SAR(1g) (W/kg)	Reported SAR(1g) (W/kg)	Power Drift(dB)
Hotspot / Body-Worn Test Data (10mm)									
841.5	26965	1RB_74	Front	Fig.24	23.24	24.0	0.384	0.46	-0.10
841.5	26965	1RB_74	Rear	/	23.24	24.0	0.294	0.35	-0.18
841.5	26965	1RB_74	Right	/	23.24	24.0	0.187	0.22	-0.11
841.5	26965	1RB_74	Bottom	/	23.24	24.0	0.108	0.13	-0.18
841.5	26965	36RB_0	Front	/	22.25	23.0	0.283	0.34	0.12
841.5	26965	36RB_0	Rear	/	22.25	23.0	0.246	0.29	-0.02
841.5	26965	36RB_0	Right	/	22.25	23.0	0.134	0.16	-0.16
841.5	26965	36RB_0	Bottom	/	22.25	23.0	0.087	0.10	-0.11

Table 13.25: SAR Values (LTE Band 30 - Head)

Frequency		Test Mode	Test Position	Figure No.	Conducted Power (dBm)	Max. tune-up Power (dBm)	Measured SAR(1g) (W/kg)	Reported SAR(1g) (W/kg)	Power Drift(dB)
MHz	Ch.								
Ambient Temperature: 22.4°C Liquid Temperature: 21.8°C									
2310	27710	1RB_24	Left Touch	Fig.25	22.76	23.5	0.414	0.49	0.01
2310	27710	1RB_24	Left Tilt	/	22.76	23.5	0.324	0.38	-0.12
2310	27710	1RB_24	Right Touch	/	22.76	23.5	0.393	0.47	-0.09
2310	27710	1RB_24	Right Tilt	/	22.76	23.5	0.332	0.39	-0.18
2310	27710	25RB_12	Left Touch	/	21.92	22.5	0.385	0.44	0.13
2310	27710	25RB_12	Left Tilt	/	21.92	22.5	0.291	0.33	-0.11
2310	27710	25RB_12	Right Touch	/	21.92	22.5	0.351	0.40	0.12
2310	27710	25RB_12	Right Tilt	/	21.92	22.5	0.319	0.36	-0.07

Table 13.26: SAR Values (LTE Band 30 - Body)

Frequency		Test Mode	Test Position	Figure No.	Conducted Power (dBm)	Max. tune-up Power (dBm)	Measured SAR(1g) (W/kg)	Reported SAR(1g) (W/kg)	Power Drift(dB)
MHz	Ch.								
Ambient Temperature: 22.4°C Liquid Temperature: 21.8°C									
Hotspot / Body-Worn Test Data (10mm)									
2310	27710	1RB_24	Front	/	22.76	23.5	0.616	0.73	0.02
2310	27710	1RB_24	Rear	/	22.76	23.5	0.468	0.55	-0.04
2310	27710	1RB_24	Right	/	22.76	23.5	0.209	0.25	0.05
2310	27710	1RB_24	Bottom	Fig.26	22.76	23.5	0.627	0.74	-0.01
2310	27710	25RB_12	Front	/	21.92	22.5	0.604	0.69	-0.07
2310	27710	25RB_12	Rear	/	21.92	22.5	0.434	0.50	-0.14
2310	27710	25RB_12	Right	/	21.92	22.5	0.192	0.22	0.00
2310	27710	25RB_12	Bottom	/	21.92	22.5	0.602	0.69	-0.13

Table 13.27: SAR Values (LTE Band 41 - Head)

Frequency		Test Mode	Test Position	Figure No.	Conducted Power (dBm)	Max. tune-up Power (dBm)	Measured SAR(1g) (W/kg)	Reported SAR(1g) (W/kg)	Power Drift(dB)
MHz	Ch.								
		Ambient Temperature: 22.5°C			Liquid Temperature: 22.0°C				
2680	41490	1RB_99	Left Touch	/	22.89	23.5	0.276	0.32	0.11
2680	41490	1RB_99	Left Tilt	/	22.89	23.5	0.111	0.13	0.05
2680	41490	1RB_99	Right Touch	Fig.27	22.89	23.5	0.520	0.60	0.04
2680	41490	1RB_99	Right Tilt	/	22.89	23.5	0.139	0.16	0.02
2680	41490	50RB_0	Left Touch	/	21.86	22.5	0.261	0.30	0.08
2680	41490	50RB_0	Left Tilt	/	21.86	22.5	0.095	0.11	0.02
2680	41490	50RB_0	Right Touch	/	21.86	22.5	0.458	0.53	0.03
2680	41490	50RB_0	Right Tilt	/	21.86	22.5	0.128	0.15	0.03
The worst case with CA									
2680	41490	1RB_99	Right Touch	/	22.76	23.5	0.501	0.59	0.04

Table 13.28: SAR Values (LTE Band 41 - Body)

Frequency		Test Mode	Test Position	Figure No.	Conducted Power (dBm)	Max. tune-up Power (dBm)	Measured SAR(1g) (W/kg)	Reported SAR(1g) (W/kg)	Power Drift(dB)
MHz	Ch.								
		Ambient Temperature: 22.5°C			Liquid Temperature: 22.0°C				
Hotspot Test Data (10mm)									
2680	41490	1RB_99	Front	/	20.36	21.0	0.383	0.39	0.02
2680	41490	1RB_99	Rear	Fig.28	20.36	21.0	0.565	0.57	0.03
2680	41490	1RB_99	Right	/	20.36	21.0	0.331	0.33	0.03
2680	41490	1RB_99	Bottom	/	20.36	21.0	0.199	0.20	-0.10
2680	41490	50RB_50	Front	/	20.16	21.0	0.257	0.26	0.10
2680	41490	50RB_50	Rear	/	20.16	21.0	0.446	0.45	0.06
2680	41490	50RB_50	Right	/	20.16	21.0	0.225	0.23	0.08
2680	41490	50RB_50	Bottom	/	20.16	21.0	0.138	0.14	-0.05
Body-Worn Test Data (15mm)									
2680	41490	1RB_99	Front	/	22.89	23.5	0.346	0.35	0.01
2680	41490	1RB_99	Rear	/	22.89	23.5	0.481	0.49	0.07
2680	41490	50RB_0	Front	/	21.86	22.5	0.295	0.30	0.06
2680	41490	50RB_0	Rear	/	21.86	22.5	0.369	0.37	0.12
The worst case with CA									
2680	41490	1RB_99	Rear	/	20.28	21.0	0.544	0.55	0.08

Note: SAR for LTE Band 38 is covered by LTE Band 41 due to similar frequency range, same maximum tune-up limit and same channel bandwidth.

Table 13.29: SAR Values (LTE Band 66 - Head)

Frequency		Ambient Temperature: 22.8°C			Liquid Temperature: 22.2°C				
MHz	Ch.	Test Mode	Test Position	Figure No.	Conducted Power (dBm)	Max. tune-up Power (dBm)	Measured SAR(1g) (W/kg)	Reported SAR(1g) (W/kg)	Power Drift(dB)
1720	132072	1RB_99	Left Touch	/	22.32	23.0	0.423	0.49	-0.03
1720	132072	1RB_99	Left Tilt	/	22.32	23.0	0.432	0.51	-0.06
1720	132072	1RB_99	Right Touch	Fig.29	22.32	23.0	0.650	0.76	-0.06
1720	132072	1RB_99	Right Tilt	/	22.32	23.0	0.452	0.53	-0.16
1720	132072	50RB_50	Left Touch	/	21.44	22.0	0.348	0.40	-0.04
1720	132072	50RB_50	Left Tilt	/	21.44	22.0	0.334	0.38	-0.13
1720	132072	50RB_50	Right Touch	/	21.44	22.0	0.537	0.61	-0.10
1720	132072	50RB_50	Right Tilt	/	21.44	22.0	0.360	0.41	-0.15

Table 13.30: SAR Values (LTE Band 66 - Body)

Frequency		Ambient Temperature: 22.8°C			Liquid Temperature: 22.2°C				
MHz	Ch.	Test Mode	Test Position	Figure No. / Note	Conducted Power (dBm)	Max. tune-up Power (dBm)	Measured SAR(1g) (W/kg)	Reported SAR(1g) (W/kg)	Power Drift(dB)
Hotspot / Body-Worn Test Data (10mm)									
1720	132072	1RB_99	Front	Fig.30	22.32	23.0	0.538	0.63	-0.05
1720	132072	1RB_99	Rear	/	22.32	23.0	0.291	0.34	-0.04
1720	132072	1RB_99	Right	/	22.32	23.0	0.440	0.51	-0.07
1720	132072	1RB_99	Bottom	/	22.32	23.0	0.225	0.26	-0.07
1720	132072	50RB_50	Front	/	21.44	22.0	0.444	0.51	-0.09
1720	132072	50RB_50	Rear	/	21.44	22.0	0.237	0.27	-0.09
1720	132072	50RB_50	Right	/	21.44	22.0	0.363	0.41	-0.01
1720	132072	50RB_50	Bottom	/	21.44	22.0	0.180	0.20	-0.05

Note: SAR for LTE Band 4 is covered by LTE Band 66 due to similar frequency range, same maximum tune-up limit and same channel bandwidth.

13.2. WLAN Evaluation for 2.4G

According to the KDB248227 D01, SAR is measured for 2.4GHz 802.11b DSSS using the initial test position procedure.

Table 13.31: SAR Values (WLAN 2.4G - Head)

Frequency		Test Mode	Test Position	Figure No.	Ambient Temperature: 22.4°C		Liquid Temperature: 21.9°C		
MHz	Ch.				Conducted Power (dBm)	Max. tune-up Power (dBm)	Measured SAR(1g) (W/kg)	Reported SAR(1g) (W/kg)	Power Drift(dB)
2412	1	802.11 b	Left Touch	/	16.14	16.5	0.974	1.06	-0.08
2412	1	802.11 b	Left Tilt	/	16.14	16.5	0.681	0.74	0.02
2412	1	802.11 b	Right Touch	/	16.14	16.5	0.537	0.58	-0.18
2412	1	802.11 b	Right Tilt	/	16.14	16.5	0.497	0.54	-0.03
2462	11	802.11 b	Left Touch	Fig.31	16.11	16.5	0.985	1.08	-0.07

Note1: For all positions/configurations tested using the initial test position and subsequent test positions, when the reported SAR is > 0.8 W/kg, SAR is measured for these test positions/configurations on the subsequent next highest measured output power channel until the reported SAR is ≤ 1.2 W/kg or all required channels are tested.

According to the KDB248227 D01, The reported SAR must be scaled to 100% transmission duty factor to determine compliance at the maximum tune-up tolerance limit.

Table 13.32: SAR Values (WLAN - Head) – 802.11b (Scaled Reported SAR)

Frequency		Test Position	Actual duty factor	maximum duty factor	Reported SAR (1g)(W/kg)	Scaled reported SAR (1g)(W/kg)
MHz	Ch					
2462	11	Left Touch	100%	100%	1.08	1.08

SAR is not required for OFDM because the 802.11b adjusted SAR ≤ 1.2 W/kg.

Table 13.33: SAR Values (WLAN 2.4G - Body)

Frequency		Test Mode	Test Position	Figure No.	Conducted Power (dBm)	Max. tune-up Power (dBm)	Measured SAR(1g) (W/kg)	Reported SAR(1g) (W/kg)	Power Drift(dB)
MHz	Ch.								
Ambient Temperature: 22.4°C Liquid Temperature: 21.9°C									
Test Data (10mm)									
2412	1	802.11 b	Front	Fig.32	16.14	16.5	0.267	0.29	0.03
2412	1	802.11 b	Rear	/	16.14	16.5	0.154	0.17	0.06
2412	1	802.11 b	Right	/	16.14	16.5	0.125	0.14	-0.01
2412	1	802.11 b	Top	/	16.14	16.5	0.220	0.24	0.12

Note1: For all positions/configurations tested using the initial test position and subsequent test positions, when the reported SAR is > 0.8 W/kg, SAR is measured for these test positions/configurations on the subsequent next highest measured output power channel until the reported SAR is ≤ 1.2 W/kg or all required channels are tested.

According to the KDB248227 D01, The reported SAR must be scaled to 100% transmission duty factor to determine compliance at the maximum tune-up tolerance limit.

Table 13.34: SAR Values (WLAN - Body) – 802.11b (Scaled Reported SAR)

Frequency		Test Position	Actual duty factor	maximum duty factor	Reported SAR (1g)(W/kg)	Scaled reported SAR (1g)(W/kg)
MHz	Ch.					
2412	1	Front	100%	100%	0.29	0.29

SAR is not required for OFDM because the 802.11b adjusted SAR ≤ 1.2 W/kg.

13.3. WLAN Evaluation for 5G

Table 13.35: SAR Values (WLAN 5G - Head)

Frequency		Test Mode	Test Position	Figure No.	Conducte d Power (dBm)	Max. tune-up Power (dBm)	Measured SAR(1g) (W/kg)	Reported SAR(1g) (W/kg)	Power Drift(dB)
MHz	Ch.								
Ambient Temperature: 22.6°C Liquid Temperature: 22.2°C									
U-NII-1									
5190	38	802.11 n	Left Touch	/	15.39	16.0	0.194	0.22	0.01
5190	38	802.11 n	Left Tilt	/	15.39	16.0	0.217	0.25	0.08
5190	38	802.11 n	Right Touch	/	15.39	16.0	0.178	0.20	-0.08
5190	38	802.11 n	Right Tilt	/	15.39	16.0	0.181	0.21	0.01
U-NII-2C									
5510	102	802.11 n	Left Touch	/	15.22	16.0	0.386	0.46	0.02
5510	102	802.11 n	Left Tilt	/	15.22	16.0	0.426	0.51	-0.07
5510	102	802.11 n	Right Touch	/	15.22	16.0	0.285	0.34	0.06
5510	102	802.11 n	Right Tilt	/	15.22	16.0	0.276	0.33	0.08
U-NII-3									
5755	151	802.11 n	Left Touch	/	14.50	15.0	0.496	0.56	0.01
5755	151	802.11 n	Left Tilt	Fig.33	14.50	15.0	0.548	0.61	-0.06
5755	151	802.11 n	Right Touch	/	14.50	15.0	0.366	0.41	0.03
5755	151	802.11 n	Right Tilt	/	14.50	15.0	0.355	0.40	0.05

Note1: U-NII-1 and U-NII-2A bands, When different maximum output power is specified for the bands, begin SAR measurement in the band with higher specified maximum output power. SAR is measured for U-NII-1 band first. Adjusted SAR of U-NII-1 band is ≤ 1.2 W/kg, SAR is not required for U-NII-2A band.

Note2: For all positions/configurations tested using the initial test position and subsequent test positions, when the reported SAR is > 0.8 W/kg, SAR is measured for these test positions/configurations on the subsequent next highest measured output power channel until the reported SAR is ≤ 1.2 W/kg or all required channels are tested.

According to the KDB248227 D01, The reported SAR must be scaled to 100% transmission duty factor to determine compliance at the maximum tune-up tolerance limit.

Table 13.36: SAR Values (WLAN 5G - Head) – Scaled Reported SAR

Frequency		Test Position	Actual duty factor	maximum duty factor	Reported SAR (1g)(W/kg)	Scaled reported SAR (1g)(W/kg)
MHz	Ch.					
5755	151	Right Touch	100%	100%	0.61	0.61

Table 13.37: SAR Values (WLAN 5G - Body)

Frequency		Test Mode	Test Position	Figure No.	Conducted Power (dBm)	Max. tune-up Power (dBm)	Measured SAR(1g) (W/kg)	Reported SAR(1g) (W/kg)	Power Drift(dB)
MHz	Ch.								
Ambient Temperature: 22.6°C					Liquid Temperature: 22.2°C				
U-NII-1 - Test Data (10mm)									
5190	38	802.11 n	Front	/	15.39	16.0	0.049	0.06	0.06
5190	38	802.11 n	Rear	/	15.39	16.0	0.091	0.10	-0.04
5190	38	802.11 n	Right	/	15.39	16.0	0.149	0.17	0.04
5190	38	802.11 n	Top	/	15.39	16.0	0.053	0.06	-0.03
U-NII-2C - Test Data (10mm)									
5510	102	802.11 n	Front	/	15.22	16.0	0.124	0.15	0.06
5510	102	802.11 n	Rear	/	15.22	16.0	0.168	0.20	0.02
5510	102	802.11 n	Right	/	15.22	16.0	0.287	0.34	0.05
5510	102	802.11 n	Top	/	15.22	16.0	0.110	0.13	0.09
U-NII-3 - Test Data (10mm)									
5755	151	802.11 n	Front	/	14.50	15.0	0.125	0.14	0.03
5755	151	802.11 n	Rear	/	14.50	15.0	0.210	0.24	0.03
5755	151	802.11 n	Right	Fig.34	14.50	15.0	0.289	0.32	0.04
5755	151	802.11 n	Top	/	14.50	15.0	0.095	0.11	-0.03

Note1: U-NII-1 and U-NII-2A bands, When different maximum output power is specified for the bands, begin SAR measurement in the band with higher specified maximum output power. SAR is measured for U-NII-1 band first. Adjusted SAR of U-NII-1 band is ≤ 1.2 W/kg, SAR is not required for U-NII-2A band.

Note2: For all positions/configurations tested using the initial test position and subsequent test positions, when the reported SAR is > 0.8 W/kg, SAR is measured for these test positions/configurations on the subsequent next highest measured output power channel until the reported SAR is ≤ 1.2 W/kg or all required channels are tested.

According to the KDB248227 D01, The reported SAR must be scaled to 100% transmission duty factor to determine compliance at the maximum tune-up tolerance limit.

Table 13.38: SAR Values (WLAN 5G - Body) –Scaled Reported SAR

Frequency		Test Position	Actual duty factor	maximum duty factor	Reported SAR (1g)(W/kg)	Scaled reported SAR (1g)(W/kg)
MHz	Ch.					
5510	102	Right	100%	100%	0.34	0.34

14. SAR Measurement Variability

SAR measurement variability must be assessed for each frequency band, which is determined by the SAR probe calibration point and tissue-equivalent medium used for the device measurements. When both head and body tissue-equivalent media are required for SAR measurements in a frequency band, the variability measurement procedures should be applied to the tissue medium with the highest measured SAR, using the highest measured SAR configuration for that tissue-equivalent medium.

The following procedures are applied to determine if repeated measurements are required.

- 1) Repeated measurement is not required when the original highest measured SAR is < 0.80 W/kg; steps 2) through 4) do not apply.
- 2) When the original highest measured SAR is ≥ 0.80 W/kg, repeat that measurement once.
- 3) Perform a second repeated measurement only if the ratio of largest to smallest SAR for the original and first repeated measurements is > 1.20 or when the original or repeated measurement is ≥ 1.45 W/kg (~ 10% from the 1-g SAR limit).
- 4) Perform a third repeated measurement only if the original, first or second repeated measurement is ≥ 1.5 W/kg and the ratio of largest to smallest SAR for the original, first and second repeated measurements is > 1.20 .

Table 14.1: SAR Measurement Variability for Head – WLAN 2.4G

Frequency		Test Position	Original	1 st Repeated	Ratio	2 nd Repeated
MHz	Ch.		SAR (W/kg)	SAR (W/kg)		SAR (W/kg)
2462	11	Left Cheek	0.985	0.966	1.02	/

15. Measurement Uncertainty

15.1. Measurement Uncertainty for Normal SAR Tests (300MHz~3GHz)

No.	Error Description	Type	Uncertainty value	Probably Distribution	Div.	(Ci) 1g	(Ci) 10g	Std. Unc. (1g)	Std. Unc. (10g)	Degree of freedom
Measurement system										
1	Probe calibration	B	12	N	2	1	1	6.0	6.0	∞
2	Axial isotropy	B	4.7	R	$\sqrt{3}$	$\sqrt{0.5}$	$\sqrt{0.5}$	4.3	4.3	∞
3	Hemispherical isotropy	B	9.6	R	$\sqrt{3}$	1	1	4.8	4.8	∞
4	Boundary effect	B	1.1	R	$\sqrt{3}$	1	1	0.6	0.6	∞
5	Linearity	B	4.7	R	$\sqrt{3}$	1	1	2.7	2.7	∞
6	Detection limit	B	1.0	R	$\sqrt{3}$	1	1	0.6	0.6	∞
7	Modulation response	B	4.0	R	$\sqrt{3}$	1	1	2.3	2.3	∞
8	Readout electronics	B	1.0	N	1	1	1	1.0	1.0	∞
9	Response time	B	0.8	R	$\sqrt{3}$	1	1	0.5	0.5	∞
10	Integration time	B	1.7	R	$\sqrt{3}$	1	1	1.0	1.0	∞
11	RF ambient conditions-noise	B	3.0	R	$\sqrt{3}$	1	1	1.7	1.7	∞
12	RF ambient conditions-reflection	B	3.0	R	$\sqrt{3}$	1	1	1.7	1.7	∞
13	Probe positioned mech. restrictions	B	0.35	R	$\sqrt{3}$	1	1	0.2	0.2	∞
14	Probe positioning with respect to phantom shell	B	2.9	R	$\sqrt{3}$	1	1	1.7	1.7	∞
15	Post-processing	B	1.0	R	$\sqrt{3}$	1	1	0.6	0.6	∞
Test sample related										
16	Test sample positioning	A	3.3	N	1	1	1	3.3	3.3	5
17	Device holder uncertainty	A	3.4	N	1	1	1	3.4	3.4	5
18	Drift of output power	B	5.0	R	$\sqrt{3}$	1	1	2.9	2.9	∞
Phantom and set-up										
19	Phantom uncertainty	B	1.0	R	$\sqrt{3}$	1	1	0.6	0.6	∞
20	Liquid conductivity (target)	B	5.0	R	$\sqrt{3}$	0.64	0.43	1.8	1.2	∞
21	Liquid conductivity (meas.)	A	1.3	N	1	0.64	0.43	0.83	0.56	9
22	Liquid permittivity (target)	B	5.0	R	$\sqrt{3}$	0.6	0.49	1.7	1.4	∞
23	Liquid permittivity (meas.)	A	1.6	N	1	0.6	0.49	0.96	0.78	9
Combined standard uncertainty		$u_c = \sqrt{\sum_{i=1}^{23} c_i^2 u_i^2}$						11.3	11.2	95.5
Expanded uncertainty (Confidence interval of 95 %)		$u_e = 2u_c$						22.6	22.4	

15.2. Measurement Uncertainty for Normal SAR Tests (3GHz~6GHz)

No.	Error Description	Type	Uncertainty value	Probably Distribution	Div.	(Ci) 1g	(Ci) 10g	Std. Unc. (1g)	Std. Unc. (10g)	Degree of freedom
Measurement system										
1	Probe calibration	B	13	N	2	1	1	6.5	6.5	∞
2	Axial isotropy	B	4.7	R	$\sqrt{3}$	$\sqrt{0.5}$	$\sqrt{0.5}$	4.3	4.3	∞
3	Hemispherical isotropy	B	9.6	R	$\sqrt{3}$	1	1	4.8	4.8	∞
4	Boundary effect	B	2.3	R	$\sqrt{3}$	1	1	1.3	1.3	∞
5	Linearity	B	4.7	R	$\sqrt{3}$	1	1	2.7	2.7	∞
6	Detection limit	B	1.0	R	$\sqrt{3}$	1	1	0.6	0.6	∞
7	Modulation response	B	4.0	R	$\sqrt{3}$	1	1	2.3	2.3	∞
8	Readout electronics	B	1.0	N	1	1	1	1.0	1.0	∞
9	Response time	B	0.8	R	$\sqrt{3}$	1	1	0.5	0.5	∞
10	Integration time	B	1.7	R	$\sqrt{3}$	1	1	1.0	1.0	∞
11	RF ambient conditions-noise	B	3.0	R	$\sqrt{3}$	1	1	1.7	1.7	∞
12	RF ambient conditions-reflection	B	3.0	R	$\sqrt{3}$	1	1	1.7	1.7	∞
13	Probe positioned mech. restrictions	B	0.71	R	$\sqrt{3}$	1	1	0.4	0.4	∞
14	Probe positioning with respect to phantom shell	B	5.7	R	$\sqrt{3}$	1	1	3.3	3.3	∞
15	Post-processing	B	4.0	R	$\sqrt{3}$	1	1	2.3	2.3	∞
Test sample related										
16	Test sample positioning	A	3.3	N	1	1	1	3.3	3.3	5
17	Device holder uncertainty	A	3.4	N	1	1	1	3.4	3.4	5
18	Drift of output power	B	5.0	R	$\sqrt{3}$	1	1	2.9	2.9	∞
Phantom and set-up										
19	Phantom uncertainty	B	1.0	R	$\sqrt{3}$	1	1	0.6	0.6	∞
20	Liquid conductivity (target)	B	5.0	R	$\sqrt{3}$	0.64	0.43	1.8	1.2	∞
21	Liquid conductivity (meas.)	A	1.3	N	1	0.64	0.43	0.83	0.56	9
22	Liquid permittivity (target)	B	5.0	R	$\sqrt{3}$	0.6	0.49	1.7	1.4	∞
23	Liquid permittivity (meas.)	A	1.6	N	1	0.6	0.49	0.96	0.78	9
Combined standard uncertainty		$u_c = \sqrt{\sum_{i=1}^{23} c_i^2 u_i^2}$						12.2	12.1	95.5
Expanded uncertainty (Confidence interval of 95 %)		$u_e = 2u_c$						24.4	24.2	

16. Main Test Instruments

Table 16.1: List of Main Instruments

No.	Name	Type	Serial Number	Calibration Date	Valid Period
01	Network analyzer	Agilent E5071C	MY46103759	2019-11-15	One year
02	Dielectric probe	85070E	MY44300317	/	/
03	Power meter	E4418B	MY50000366	2019-12-14	One year
04	Power sensor	E9304A	MY50000188		
05	Power meter	NRP	101460	2020-01-15	One year
06	Power sensor	NRP-Z91	100553		
07	Signal Generator	E8257D	MY47461211	2019-06-03	One year
08	Amplifier	VTL5400	0404	/	/
09	E-field Probe	EX3DV4	3633	2020-04-01	One year
10	DAE	DAE4	1527	2019-11-11	One year
11	Dipole Validation Kit	D750V3	1163	2019-09-03	One year
12	Dipole Validation Kit	D835V2	4d057	2018-10-09	Three year
13	Dipole Validation Kit	D1750V2	1152	2019-08-30	One year
14	Dipole Validation Kit	D1900V2	5d088	2018-10-24	Three year
15	Dipole Validation Kit	D2300V2	1059	2018-09-03	Three year
16	Dipole Validation Kit	D2450V2	873	2018-10-26	Three year
17	Dipole Validation Kit	D2550V2	1058	2018-08-24	Three year
18	Dipole Validation Kit	D5GHzV2	1238	2019-08-29	One year
19	Radio Communication Analyzer	Anristu MT8820C	6201341853	2020-01-15	One year
20	BTS	E5515C	GB46110722	2020-01-05	One year
21	Software	DASY5	52.8.8.1222	/	/

ANNEX A: Graph Results

GSM850 Head - Right Touch High

Date: 2020-4-23

Electronics: DAE4 Sn1527

Medium: Head 835MHz

Medium parameters used (interpolated): $f = 848.8$ MHz; $\sigma = 0.904$ S/m; $\epsilon_r = 41.802$; $\rho = 1000$ kg/m³

Ambient Temperature: 22.0°C Liquid Temperature: 21.5°C

Communication System: UID 0, GPRS 2Txslot (0) Frequency: 848.8 MHz Duty Cycle: 1:4

Probe: EX3DV4 – SN3633 ConvF (9.59, 9.59, 9.59);

Area Scan (81x101x1): Interpolated grid: dx=1.500 mm, dy=1.500 mm

Maximum value of SAR (interpolated) = 0.762 W/kg

Zoom Scan (5x5x7)/Cube 0: Measurement grid: dx=8mm, dy=8mm, dz=5mm

Reference Value = 11.20 V/m; Power Drift = -0.05 dB

Peak SAR (extrapolated) = 0.839 W/kg

SAR(1 g) = 0.728 W/kg; SAR(10 g) = 0.520 W/kg

Maximum value of SAR (measured) = 0.750 W/kg

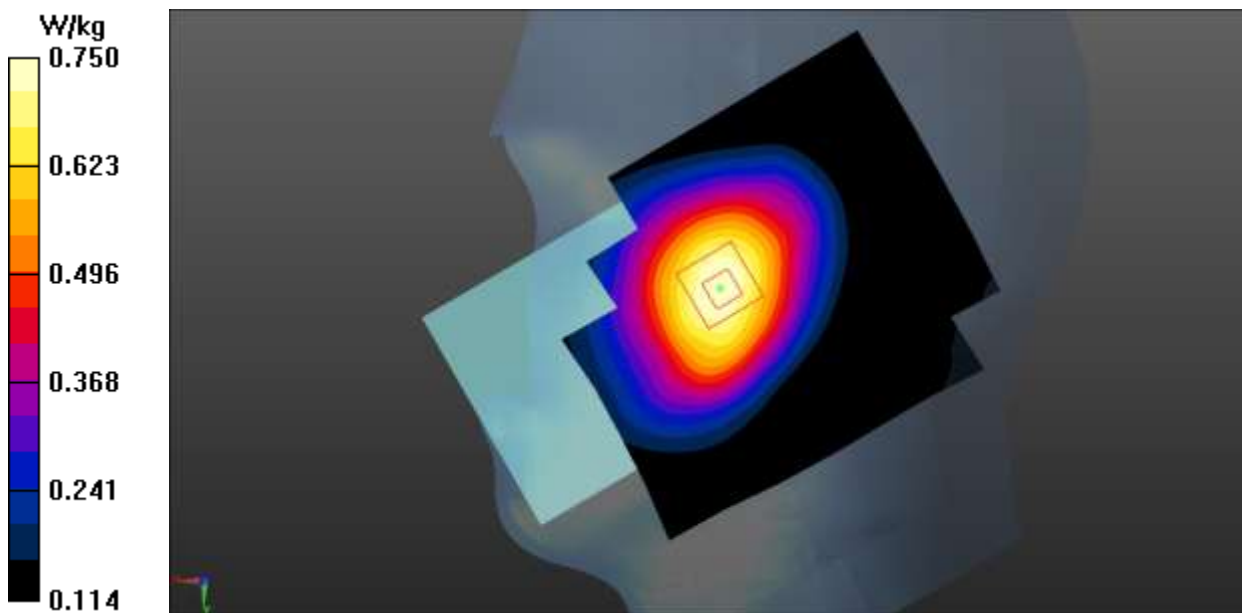

Fig.1 GSM 850 Head

GSM850 Body - Front Side High

Date: 2020-4-23

Electronics: DAE4 Sn1527

Medium: Head 835MHz

Medium parameters used (interpolated): $f = 848.8$ MHz; $\sigma = 0.904$ S/m; $\epsilon_r = 41.802$; $\rho = 1000$ kg/m³

Ambient Temperature: 22.0°C Liquid Temperature: 21.5°C

Communication System: UID 0, GPRS 2Txslot (0) Frequency: 848.8 MHz Duty Cycle: 1:4

Probe: EX3DV4 – SN3633 ConvF (9.59, 9.59, 9.59);

Area Scan (81x101x1): Interpolated grid: dx=1.500 mm, dy=1.500 mm

Maximum value of SAR (interpolated) = 0.632 W/kg

Zoom Scan (5x5x7)/Cube 0: Measurement grid: dx=8mm, dy=8mm, dz=5mm

Reference Value = 23.82 V/m; Power Drift = -0.13 dB

Peak SAR (extrapolated) = 0.659 W/kg

SAR(1 g) = 0.554 W/kg; SAR(10 g) = 0.425 W/kg

Maximum value of SAR (measured) = 0.597 W/kg

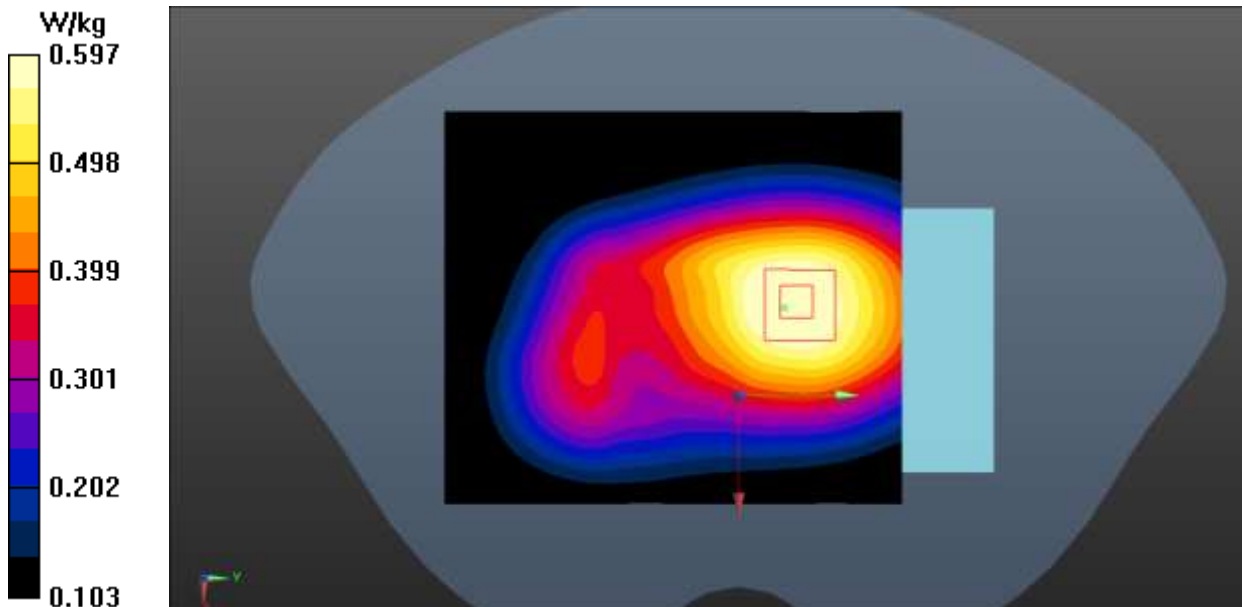
**Fig.2 GSM 850 Body**

GSM1900 Head - Right Touch High

Date: 2020-5-1

Electronics: DAE4 Sn1527

Medium: Head 1900MHz

Medium parameters used: $f = 1910$ MHz; $\sigma = 1.431$ S/m; $\epsilon_r = 38.979$; $\rho = 1000$ kg/m³

Ambient Temperature: 22.0°C Liquid Temperature: 21.5°C

Communication System: UID 0, GPRS 3Txslot (0) Frequency: 1909.8 MHz Duty Cycle: 1:2.67

Probe: EX3DV4 – SN3633 ConvF (7.76, 7.76, 7.76);

Area Scan (81x101x1): Interpolated grid: dx=1.500 mm, dy=1.500 mm

Maximum value of SAR (interpolated) = 0.587 W/kg

Zoom Scan (5x5x7)/Cube 0: Measurement grid: dx=8mm, dy=8mm, dz=5mm

Reference Value = 5.977 V/m; Power Drift = -0.02 dB

Peak SAR (extrapolated) = 0.940 W/kg

SAR(1 g) = 0.498 W/kg; SAR(10 g) = 0.256 W/kg

Maximum value of SAR (measured) = 0.560 W/kg

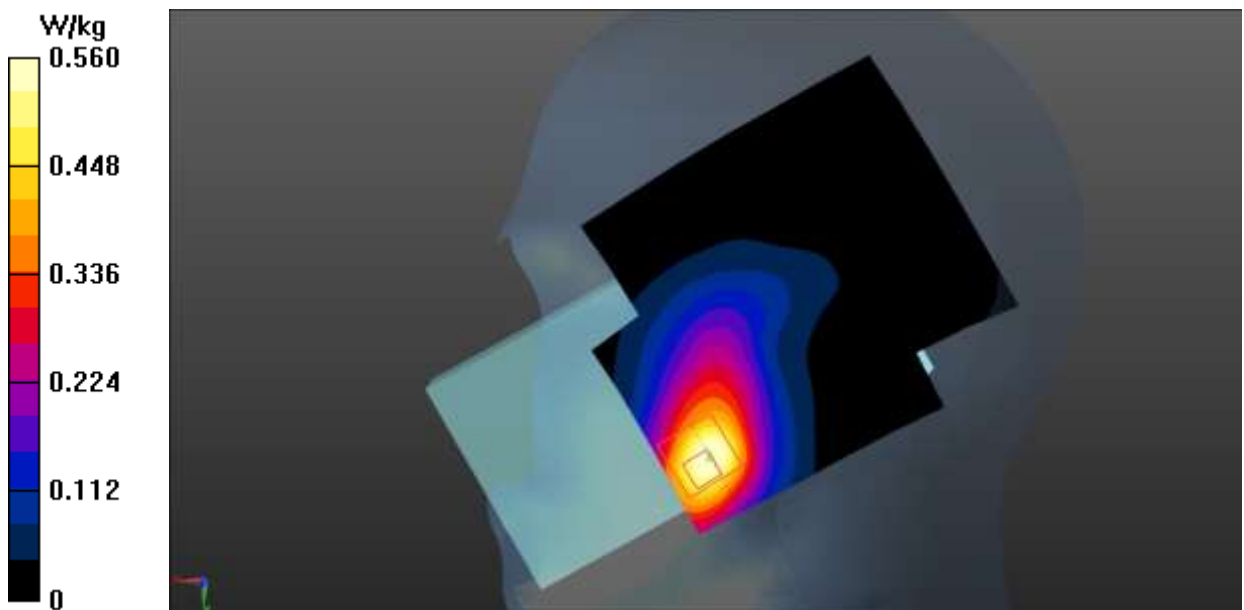
**Fig.3 GSM 1900 Head**

GSM1900 Body - Front Side High

Date: 2020-5-1

Electronics: DAE4 Sn1527

Medium: Head 1900MHz

Medium parameters used: $f = 1910$ MHz; $\sigma = 1.431$ S/m; $\epsilon_r = 38.979$; $\rho = 1000$ kg/m³

Ambient Temperature: 22.0°C Liquid Temperature: 21.5°C

Communication System: UID 0, GPRS 3Txslot (0) Frequency: 1909.8 MHz Duty Cycle: 1:2.67

Probe: EX3DV4 – SN3633 ConvF (7.76, 7.76, 7.76);

Area Scan (81x101x1): Interpolated grid: dx=1.500 mm, dy=1.500 mm

Maximum value of SAR (interpolated) = 0.386 W/kg

Zoom Scan (5x5x7)/Cube 0: Measurement grid: dx=8mm, dy=8mm, dz=5mm

Reference Value = 12.15 V/m; Power Drift = -0.12 dB

Peak SAR (extrapolated) = 0.669 W/kg

SAR(1 g) = 0.332 W/kg; SAR(10 g) = 0.194 W/kg

Maximum value of SAR (measured) = 0.356 W/kg

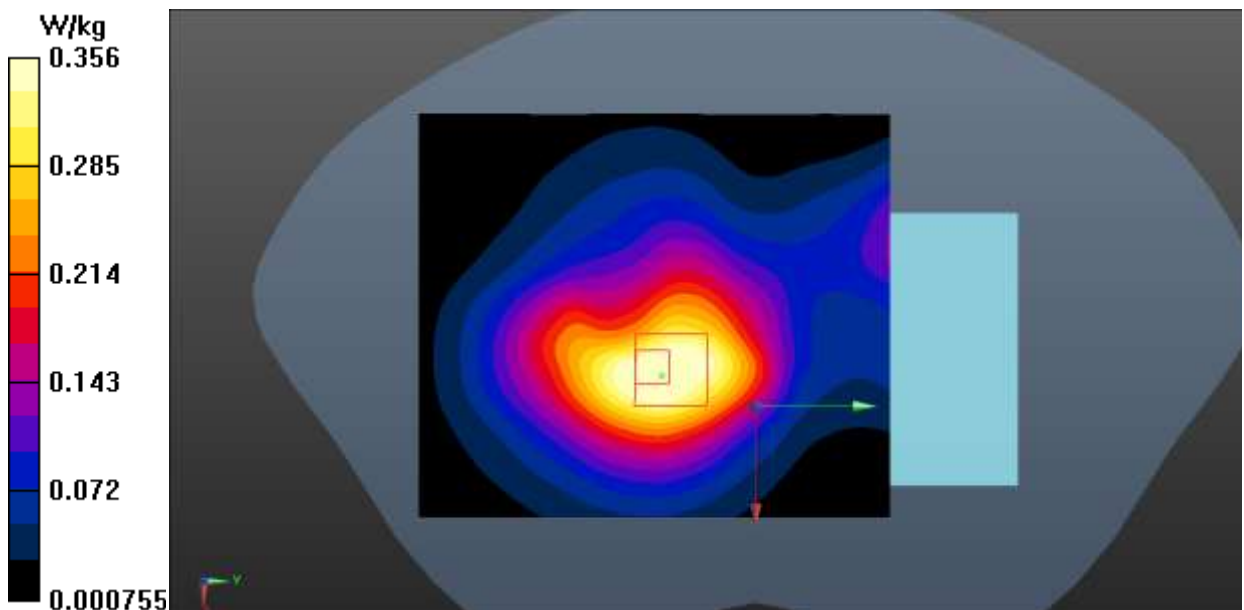
**Fig.4 GSM 1900 Body**

WCDMA Band 2 Head- Right Touch High

Date: 2020-5-1

Electronics: DAE4 Sn1527

Medium: Head 1900MHz

Medium parameters used: $f = 1908$ MHz; $\sigma = 1.429$ S/m; $\epsilon_r = 38.987$; $\rho = 1000$ kg/m³

Ambient Temperature: 22.0°C Liquid Temperature: 21.5°C

Communication System: UID 0, WCDMA (0) Frequency: 1907.6 MHz Duty Cycle: 1:1

Probe: EX3DV4 – SN3633 ConvF (7.76, 7.76, 7.76);

Area Scan (81x71x1): Interpolated grid: dx=1.500 mm, dy=1.500 mm

Maximum value of SAR (interpolated) = 0.822 W/kg

Zoom Scan (5x5x7)/Cube 0: Measurement grid: dx=8mm, dy=8mm, dz=5mm

Reference Value = 6.563 V/m; Power Drift = -0.09 dB

Peak SAR (extrapolated) = 1.13 W/kg

SAR(1 g) = 0.671 W/kg; SAR(10 g) = 0.383 W/kg

Maximum value of SAR (measured) = 0.777 W/kg

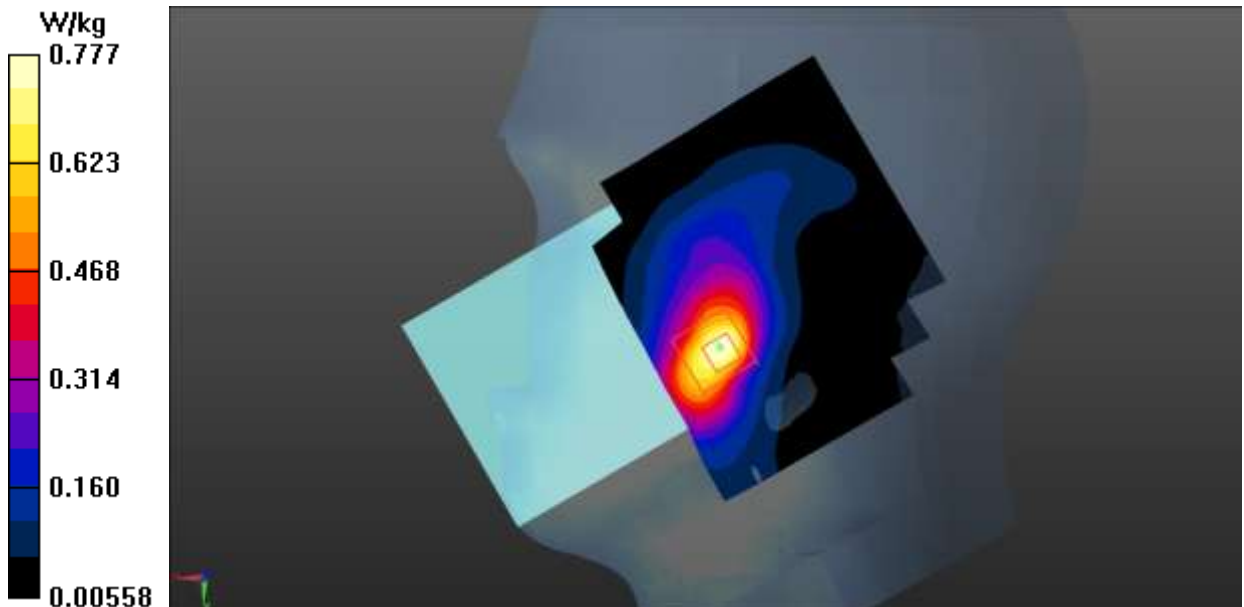

Fig.5 WCDMA Band 2 Head

WCDMA Band 2 Body - Front Side High

Date: 2020-5-1

Electronics: DAE4 Sn1527

Medium: Head 1900MHz

Medium parameters used: $f = 1908$ MHz; $\sigma = 1.429$ S/m; $\epsilon_r = 38.987$; $\rho = 1000$ kg/m³

Ambient Temperature: 22.0°C Liquid Temperature: 21.5°C

Communication System: UID 0, WCDMA (0) Frequency: 1907.6 MHz Duty Cycle: 1:1

Probe: EX3DV4 – SN3633 ConvF (7.76, 7.76, 7.76);

Area Scan (81x71x1): Interpolated grid: dx=1.500 mm, dy=1.500 mm

Maximum value of SAR (interpolated) = 0.649 W/kg

Zoom Scan (5x5x7)/Cube 0: Measurement grid: dx=8mm, dy=8mm, dz=5mm

Reference Value = 15.82 V/m; Power Drift = -0.06 dB

Peak SAR (extrapolated) = 0.893 W/kg

SAR(1 g) = 0.588 W/kg; SAR(10 g) = 0.362 W/kg

Maximum value of SAR (measured) = 0.627 W/kg

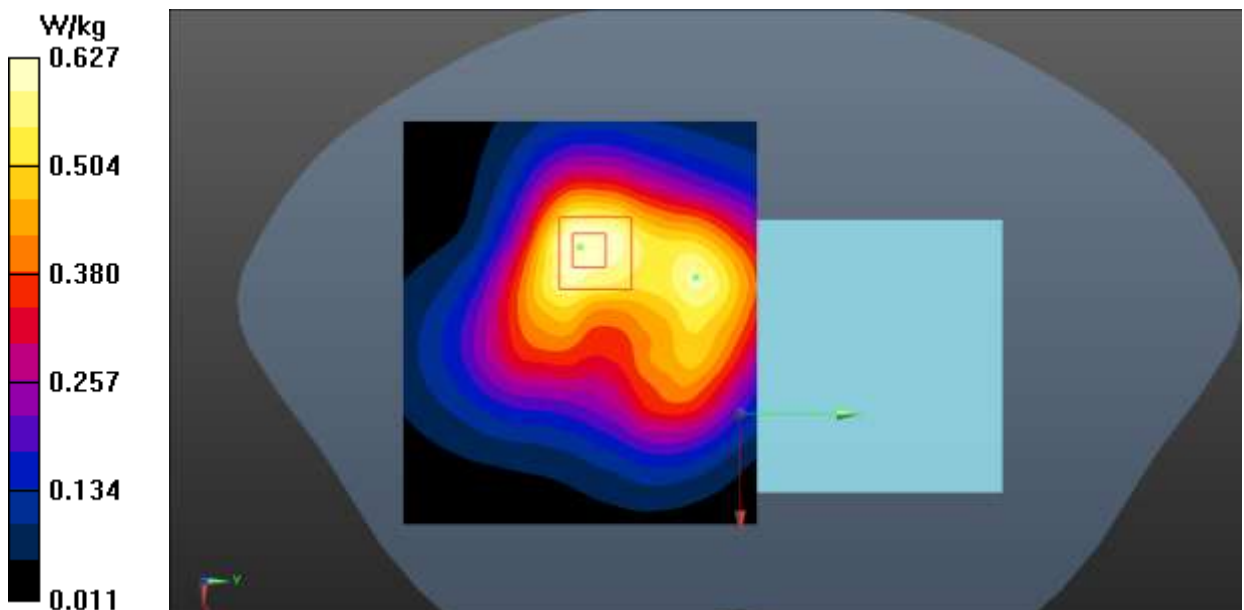

Fig.6 WCDMA Band 2 Body

WCDMA Band 4 Head - Right Touch Low

Date: 2020-4-29

Electronics: DAE4 Sn1527

Medium: Head 1750MHz

Medium parameters used (interpolated): $f = 1712.4$ MHz; $\sigma = 1.353$ S/m; $\epsilon_r = 39.479$; $\rho = 1000$ kg/m³

Ambient Temperature: 22.0°C Liquid Temperature: 21.5°C

Communication System: UID 0, WCDMA (0) Frequency: 1712.4 MHz Duty Cycle: 1:1

Probe: EX3DV4 – SN3633 ConvF (8.09, 8.09, 8.09);

Area Scan (81x101x1): Interpolated grid: dx=1.500 mm, dy=1.500 mm

Maximum value of SAR (interpolated) = 0.746 W/kg

Zoom Scan (5x5x7)/Cube 0: Measurement grid: dx=8mm, dy=8mm, dz=5mm

Reference Value = 15.74 V/m; Power Drift = -0.06 dB

Peak SAR (extrapolated) = 0.983 W/kg

SAR(1 g) = 0.515 W/kg; SAR(10 g) = 0.378 W/kg

Maximum value of SAR (measured) = 0.741 W/kg

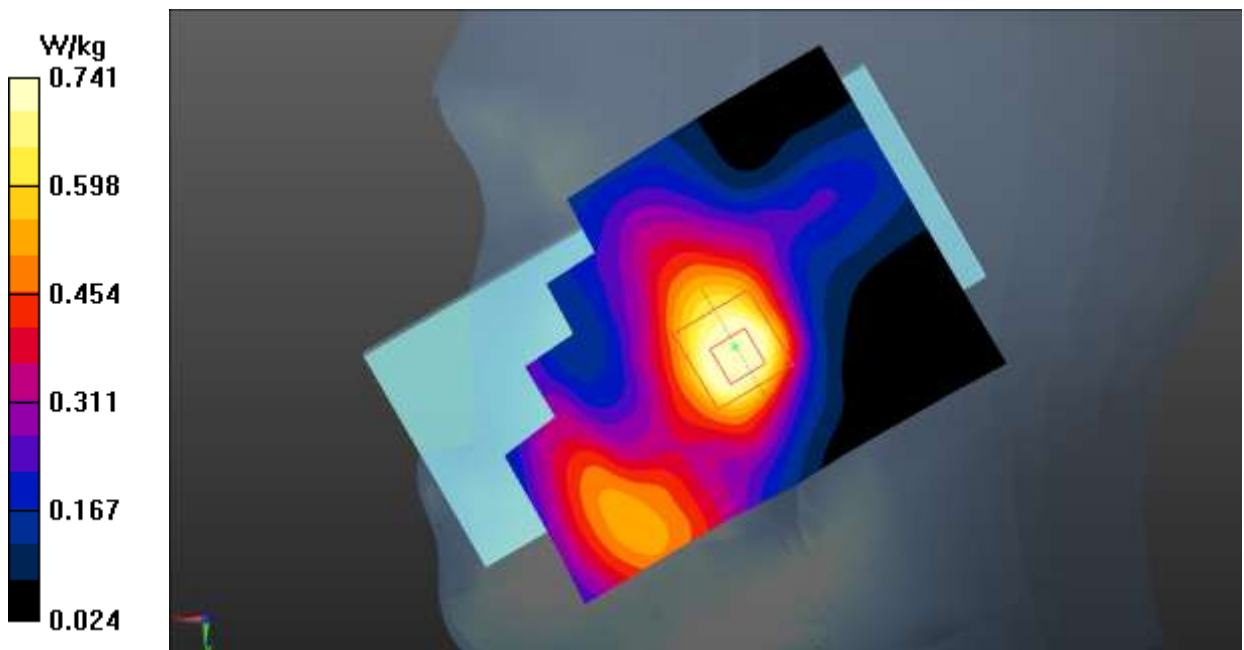

Fig.7 WCDMA Band 4 Head

WCDMA Band 4 Body - Front Side Low

Date: 2020-4-29

Electronics: DAE4 Sn1527

Medium: Head 1750MHz

Medium parameters used (interpolated): $f = 1712.4$ MHz; $\sigma = 1.353$ S/m; $\epsilon_r = 39.479$; $\rho = 1000$ kg/m³

Ambient Temperature: 22.0°C Liquid Temperature: 21.5°C

Communication System: UID 0, WCDMA (0) Frequency: 1712.4 MHz Duty Cycle: 1:1

Probe: EX3DV4 – SN3633 ConvF (8.09, 8.09, 8.09);

Area Scan (81x71x1): Interpolated grid: dx=1.500 mm, dy=1.500 mm

Maximum value of SAR (interpolated) = 0.731 W/kg

Zoom Scan (5x5x7)/Cube 0: Measurement grid: dx=8mm, dy=8mm, dz=5mm

Reference Value = 18.33 V/m; Power Drift = -0.08 dB

Peak SAR (extrapolated) = 0.894 W/kg

SAR(1 g) = 0.648 W/kg; SAR(10 g) = 0.412 W/kg

Maximum value of SAR (measured) = 0.718 W/kg

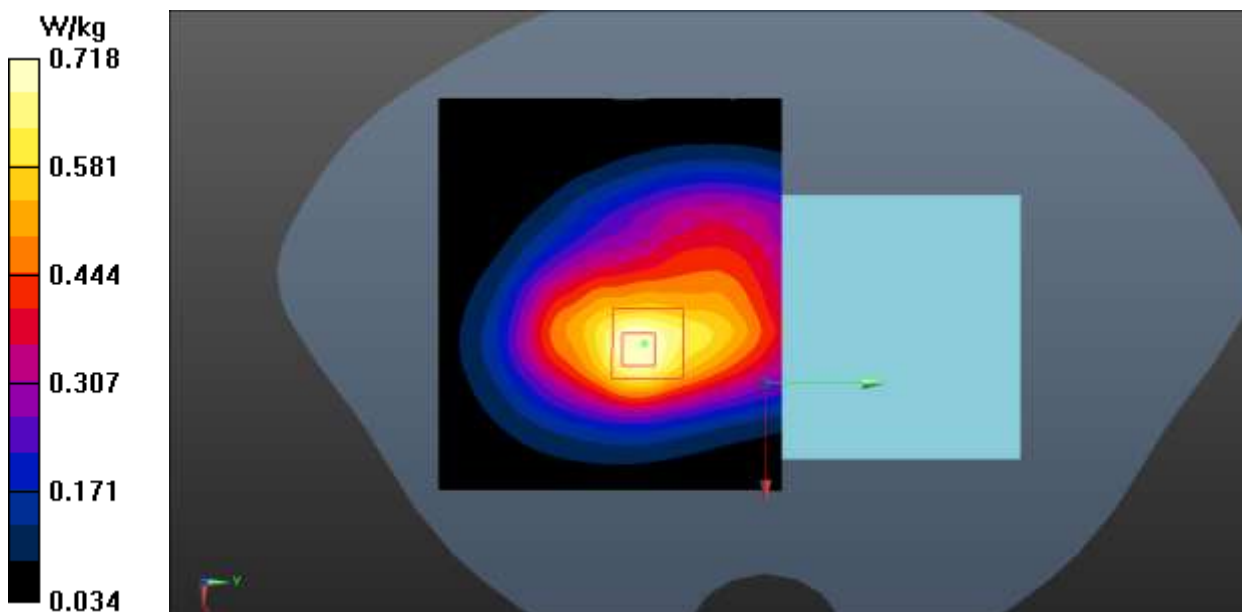

Fig.8 WCDMA Band 4 Body

WCDMA Band 5 Head - Right Touch High

Date: 2020-4-23

Electronics: DAE4 Sn1527

Medium: Head 835MHz

Medium parameters used (interpolated): $f = 846.6$ MHz; $\sigma = 0.902$ S/m; $\epsilon_r = 41.829$; $\rho = 1000$ kg/m³

Ambient Temperature: 22.0°C Liquid Temperature: 21.5°C

Communication System: UID 0, WCDMA (0) Frequency: 846.6 MHz Duty Cycle: 1:1

Probe: EX3DV4 – SN3633 ConvF (9.59, 9.59, 9.59);

Area Scan (81x71x1): Interpolated grid: dx=1.500 mm, dy=1.500 mm

Maximum value of SAR (interpolated) = 0.466 W/kg

Zoom Scan (5x5x7)/Cube 0: Measurement grid: dx=8mm, dy=8mm, dz=5mm

Reference Value = 10.22 V/m; Power Drift = 0.05 dB

Peak SAR (extrapolated) = 0.504 W/kg

SAR(1 g) = 0.423 W/kg; SAR(10 g) = 0.324 W/kg

Maximum value of SAR (measured) = 0.458 W/kg

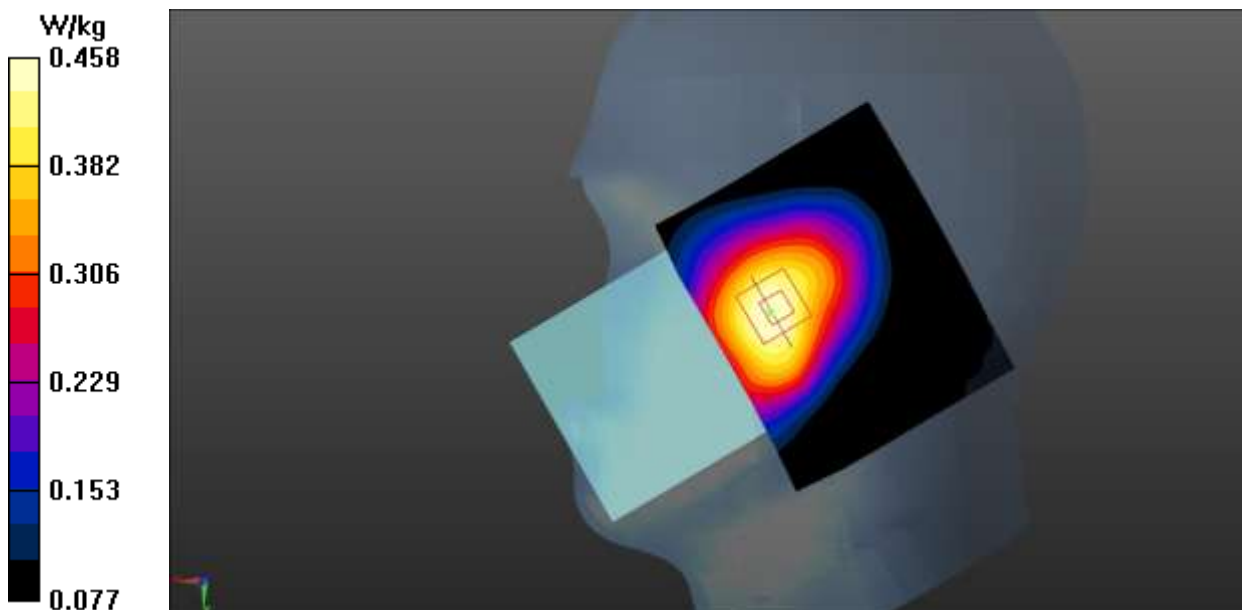
**Fig.9 WCDMA Band 5 Head**

WCDMA Band 5 Body - Front Side High

Date: 2020-4-23

Electronics: DAE4 Sn1527

Medium: Head 835MHz

Medium parameters used (interpolated): $f = 846.6$ MHz; $\sigma = 0.902$ S/m; $\epsilon_r = 41.829$; $\rho = 1000$ kg/m³

Ambient Temperature: 22.0°C Liquid Temperature: 21.5°C

Communication System: UID 0, WCDMA (0) Frequency: 846.6 MHz Duty Cycle: 1:1

Probe: EX3DV4 – SN3633 ConvF (9.59, 9.59, 9.59);

Area Scan (81x101x1): Interpolated grid: dx=1.500 mm, dy=1.500 mm

Maximum value of SAR (interpolated) = 0.394 W/kg

Zoom Scan (5x5x7)/Cube 0: Measurement grid: dx=8mm, dy=8mm, dz=5mm

Reference Value = 19.70 V/m; Power Drift = 0.01 dB

Peak SAR (extrapolated) = 0.436 W/kg

SAR(1 g) = 0.356 W/kg; SAR(10 g) = 0.273 W/kg

Maximum value of SAR (measured) = 0.394 W/kg

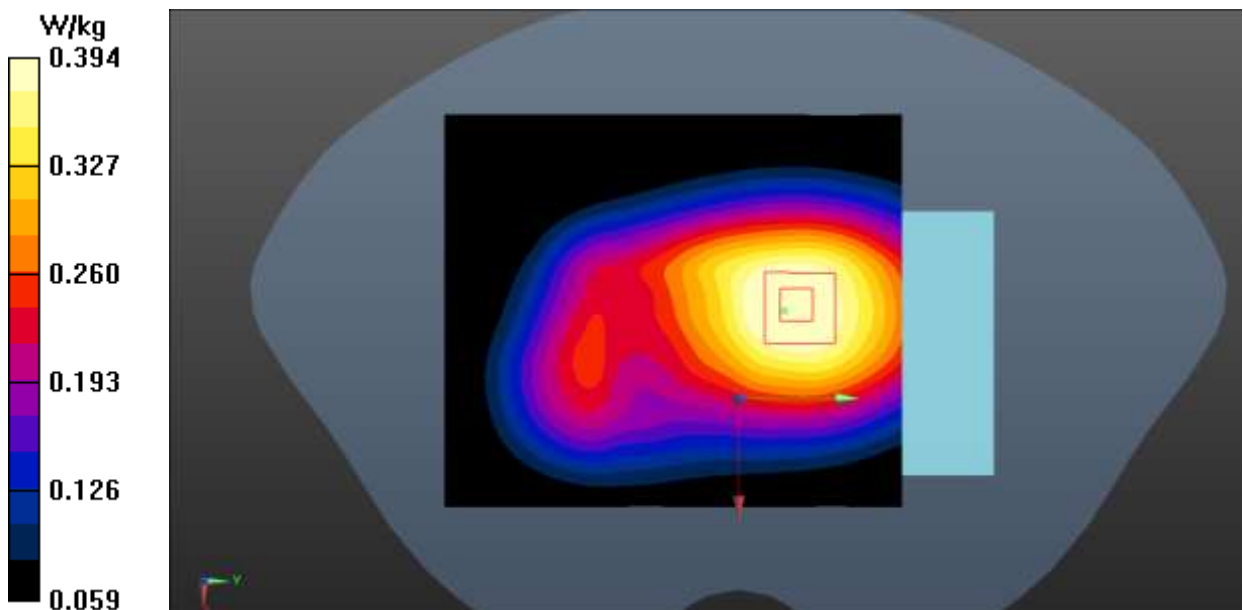

Fig.10 WCDMA Band 5 Body

LTE Band 5 Head - Right Touch Middle 1RB_49

Date: 2020-4-23

Electronics: DAE4 Sn1527

Medium: Head 835MHz

Medium parameters used (interpolated): $f = 836.5$ MHz; $\sigma = 0.892$ S/m; $\epsilon_r = 41.95$; $\rho = 1000$ kg/m³

Ambient Temperature: 22.0°C Liquid Temperature: 21.5°C

Communication System: UID 0, LTE_FDD (0) Frequency: 836.5 MHz Duty Cycle: 1:1

Probe: EX3DV4 – SN3633 ConvF (9.59, 9.59, 9.59);

Area Scan (81x101x1): Interpolated grid: dx=1.500 mm, dy=1.500 mm

Maximum value of SAR (interpolated) = 0.555 W/kg

Zoom Scan (5x5x7)/Cube 0: Measurement grid: dx=8mm, dy=8mm, dz=5mm

Reference Value = 10.71 V/m; Power Drift = -0.05 dB

Peak SAR (extrapolated) = 0.641 W/kg

SAR(1 g) = 0.513 W/kg; SAR(10 g) = 0.384 W/kg

Maximum value of SAR (measured) = 0.562 W/kg

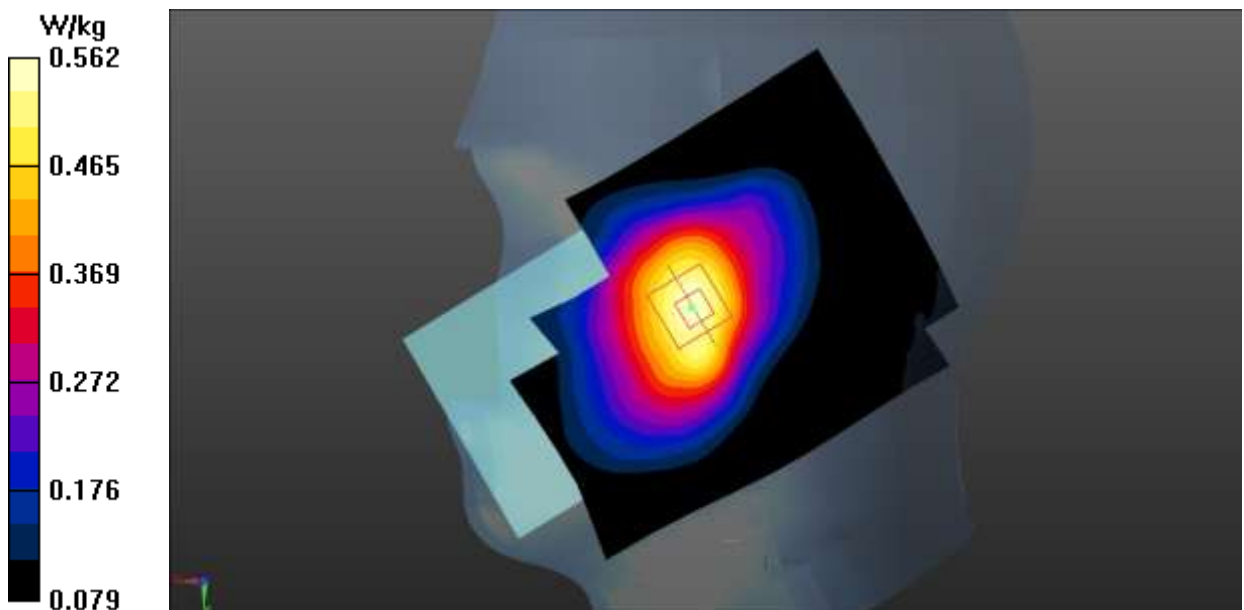
**Fig.11 LTE Band 5 Head**

LTE Band 5 Body - Rear Side Middle 1RB_49

Date: 2020-4-23

Electronics: DAE4 Sn1527

Medium: Head 835MHz

Medium parameters used (interpolated): $f = 836.5$ MHz; $\sigma = 0.892$ S/m; $\epsilon_r = 41.95$; $\rho = 1000$ kg/m³

Ambient Temperature: 22.0°C Liquid Temperature: 21.5°C

Communication System: UID 0, LTE_FDD (0) Frequency: 836.5 MHz Duty Cycle: 1:1

Probe: EX3DV4 – SN3633 ConvF (9.59, 9.59, 9.59);

Area Scan (81x101x1): Interpolated grid: dx=1.500 mm, dy=1.500 mm

Maximum value of SAR (interpolated) = 0.387 W/kg

Zoom Scan (5x5x7)/Cube 0: Measurement grid: dx=8mm, dy=8mm, dz=5mm

Reference Value = 15.02 V/m; Power Drift = -0.11 dB

Peak SAR (extrapolated) = 0.538 W/kg

SAR(1 g) = 0.308 W/kg; SAR(10 g) = 0.180 W/kg

Maximum value of SAR (measured) = 0.379 W/kg

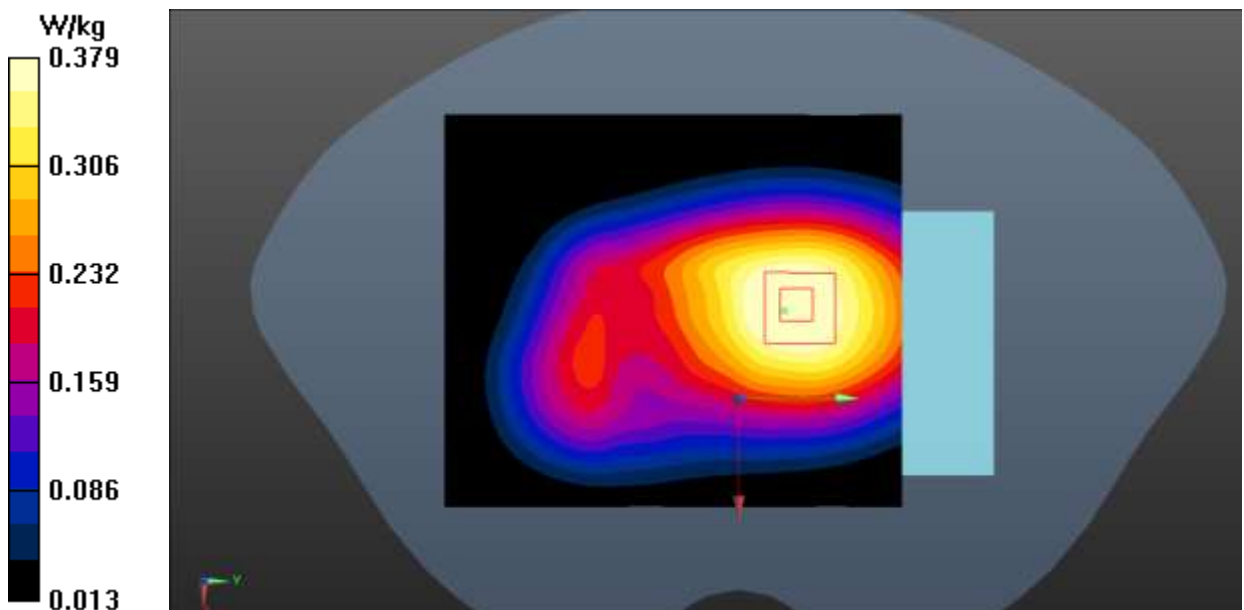
**Fig.12 LTE Band 5 Body**

LTE Band 7 Head - Left Touch Middle 1RB_50

Date: 2020-6-1

Electronics: DAE4 Sn1527

Medium: Head 2550MHz

Medium parameters used (interpolated): $f = 2535$ MHz; $\sigma = 1.921$ S/m; $\epsilon_r = 38.134$; $\rho = 1000$ kg/m³

Ambient Temperature: 22.0°C Liquid Temperature: 21.5°C

Communication System: UID 0, LTE_FDD (0) Frequency: 2535 MHz Duty Cycle: 1:1

Probe: EX3DV4 - SN3633 ConvF (7.43, 7.43, 7.43)

Area Scan (91x141x1): Interpolated grid: dx=1.000 mm, dy=1.000 mm

Maximum value of SAR (interpolated) = 1.10 W/kg

Zoom Scan (7x7x7)/Cube 0: Measurement grid: dx=5mm, dy=5mm, dz=5mm

Reference Value = 3.245 V/m; Power Drift = 0.06 dB

Peak SAR (extrapolated) = 1.28 W/kg

SAR(1 g) = 0.409 W/kg; SAR(10 g) = 0.343 W/kg

Maximum value of SAR (measured) = 0.971 W/kg

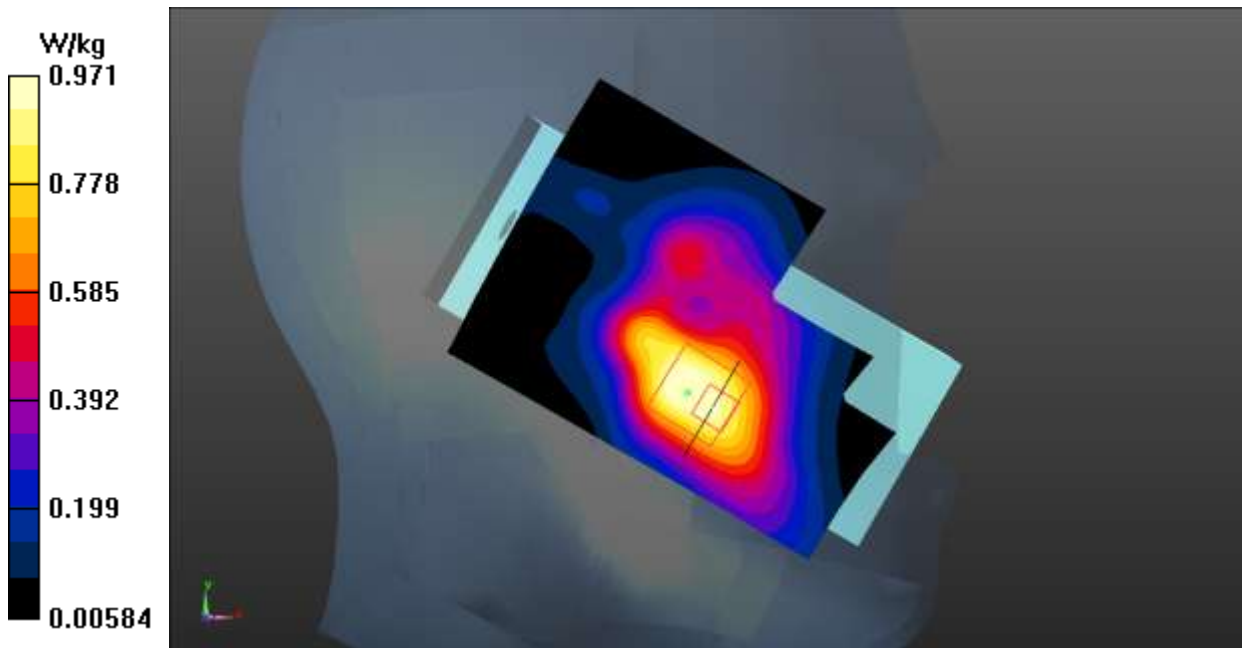

Fig.13 LTE Band 7 Head

LTE Band 7 Body - Rear Side Middle 1RB_50

Date: 2020-6-1

Electronics: DAE4 Sn1527

Medium: Head 2550MHz

Medium parameters used (interpolated): $f = 2535$ MHz; $\sigma = 1.921$ S/m; $\epsilon_r = 38.134$; $\rho = 1000$ kg/m³

Ambient Temperature: 22.0°C Liquid Temperature: 21.5°C

Communication System: UID 0, LTE_FDD (0) Frequency: 2535 MHz Duty Cycle: 1:1

Probe: EX3DV4 - SN3633 ConvF (7.43, 7.43, 7.43)

Area Scan (81x81x1): Interpolated grid: dx=1.000 mm, dy=1.000 mm

Maximum value of SAR (interpolated) = 0.651 W/kg

Zoom Scan (7x7x7)/Cube 0: Measurement grid: dx=5mm, dy=5mm, dz=5mm

Reference Value = 5.773 V/m; Power Drift = 0.07 dB

Peak SAR (extrapolated) = 0.890 W/kg

SAR(1 g) = 0.481 W/kg; SAR(10 g) = 0.250 W/kg

Maximum value of SAR (measured) = 0.674 W/kg

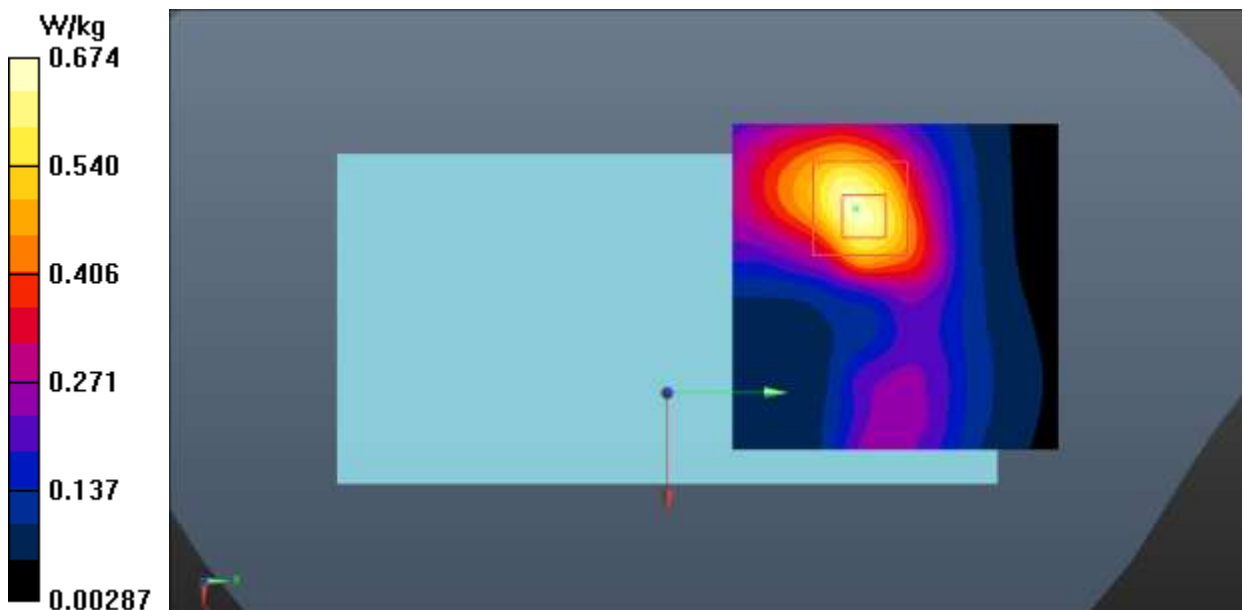
**Fig.14 LTE Band 7 Body**

LTE Band 12 Head - Right Touch Middle 1RB_24

Date: 2020-4-25

Electronics: DAE4 Sn1527

Medium: Head 750MHz

Medium parameters used (interpolated): $f = 707.5$ MHz; $\sigma = 0.857$ S/m; $\epsilon_r = 43.134$; $\rho = 1000$ kg/m³

Ambient Temperature: 22.0°C Liquid Temperature: 21.5°C

Communication System: UID 0, LTE_FDD (0) Frequency: 707.5 MHz Duty Cycle: 1:1

Probe: EX3DV4 – SN3633 ConvF (9.59, 9.59, 9.59);

Area Scan (81x101x1): Interpolated grid: dx=1.500 mm, dy=1.500 mm

Maximum value of SAR (interpolated) = 0.280 W/kg

Zoom Scan (5x5x7)/Cube 0: Measurement grid: dx=8mm, dy=8mm, dz=5mm

Reference Value = 8.491 V/m; Power Drift = 0.01 dB

Peak SAR (extrapolated) = 0.334 W/kg

SAR(1 g) = 0.261 W/kg; SAR(10 g) = 0.192 W/kg

Maximum value of SAR (measured) = 0.284 W/kg

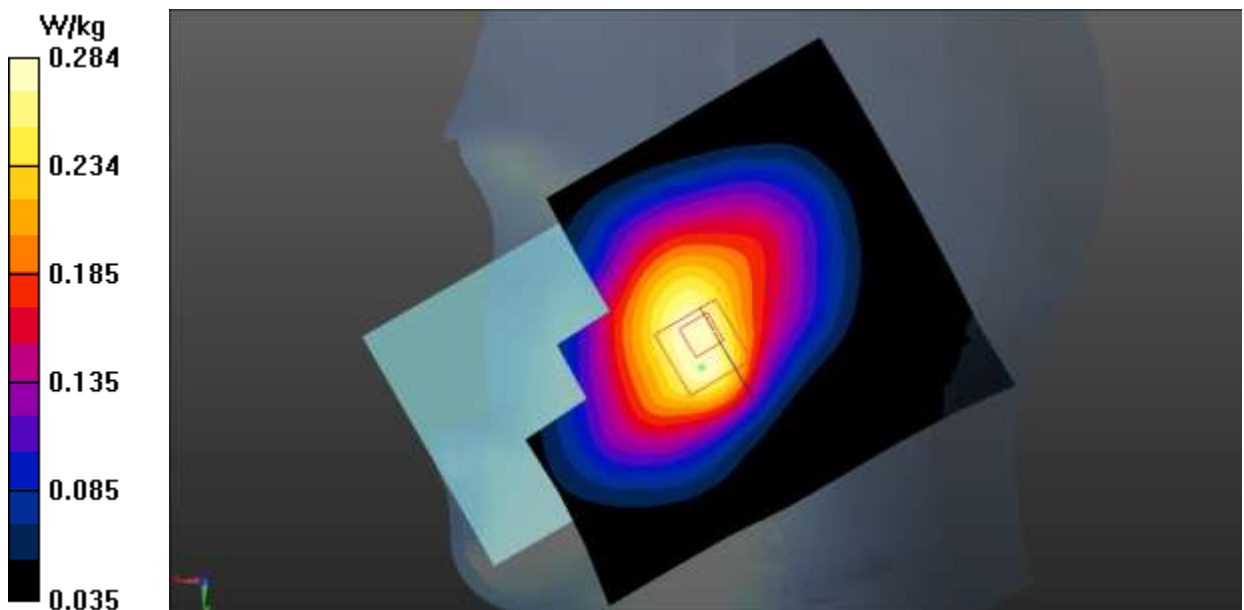
**Fig.15 LTE Band 12 Head**

LTE Band 12 Body - Front Side Middle 1RB_24

Date: 2020-4-25

Electronics: DAE4 Sn1527

Medium: Head 750MHz

Medium parameters used (interpolated): $f = 707.5$ MHz; $\sigma = 0.857$ S/m; $\epsilon_r = 43.134$; $\rho = 1000$ kg/m³

Ambient Temperature: 22.0°C Liquid Temperature: 21.5°C

Communication System: UID 0, LTE_FDD (0) Frequency: 707.5 MHz Duty Cycle: 1:1

Probe: EX3DV4 – SN3633 ConvF (9.59, 9.59, 9.59);

Area Scan (81x101x1): Interpolated grid: dx=1.500 mm, dy=1.500 mm

Maximum value of SAR (interpolated) = 0.294 W/kg

Zoom Scan (5x5x7)/Cube 0: Measurement grid: dx=8mm, dy=8mm, dz=5mm

Reference Value = 15.53 V/m; Power Drift = -0.15 dB

Peak SAR (extrapolated) = 0.357 W/kg

SAR(1 g) = 0.259 W/kg; SAR(10 g) = 0.205 W/kg

Maximum value of SAR (measured) = 0.320 W/kg

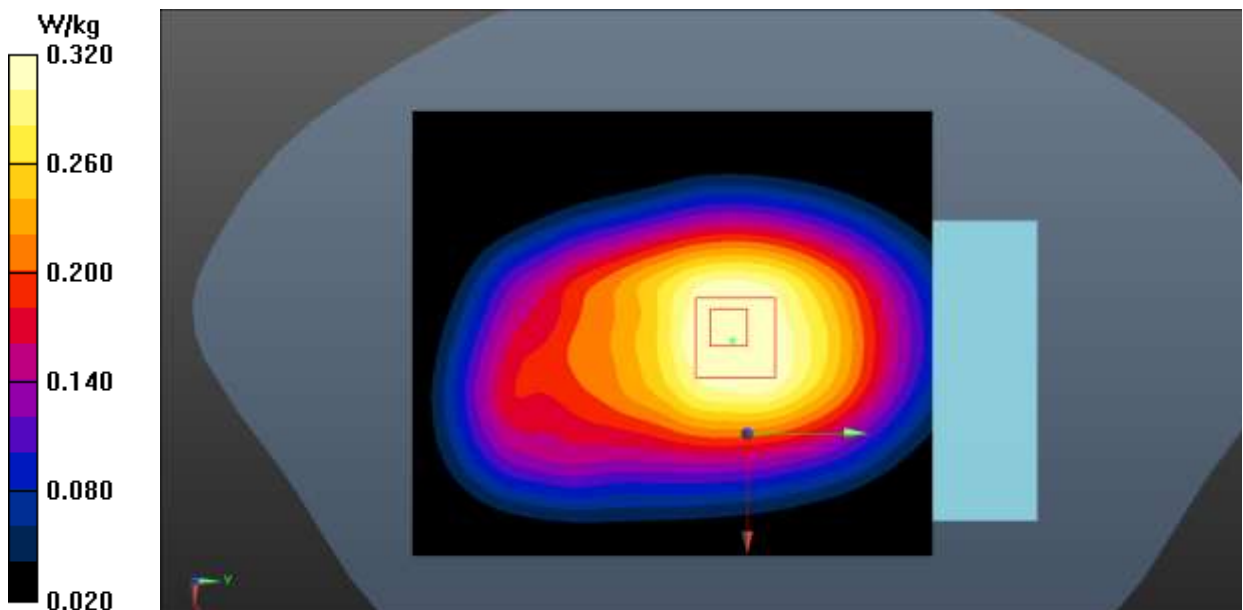

Fig.16 LTE Band 12 Body

LTE Band 13 Head - Left Touch Middle 1RB_49

Date: 2020-4-25

Electronics: DAE4 Sn1527

Medium: Head 750MHz

Medium parameters used: $f = 782 \text{ MHz}$; $\sigma = 0.904 \text{ S/m}$; $\epsilon_r = 42.24$; $\rho = 1000 \text{ kg/m}^3$ Ambient Temperature: 22.0°C Liquid Temperature: 21.5°C

Communication System: UID 0, LTE_FDD (0) Frequency: 782 MHz Duty Cycle: 1:1

Probe: EX3DV4 – SN3633 ConvF (9.59, 9.59, 9.59);

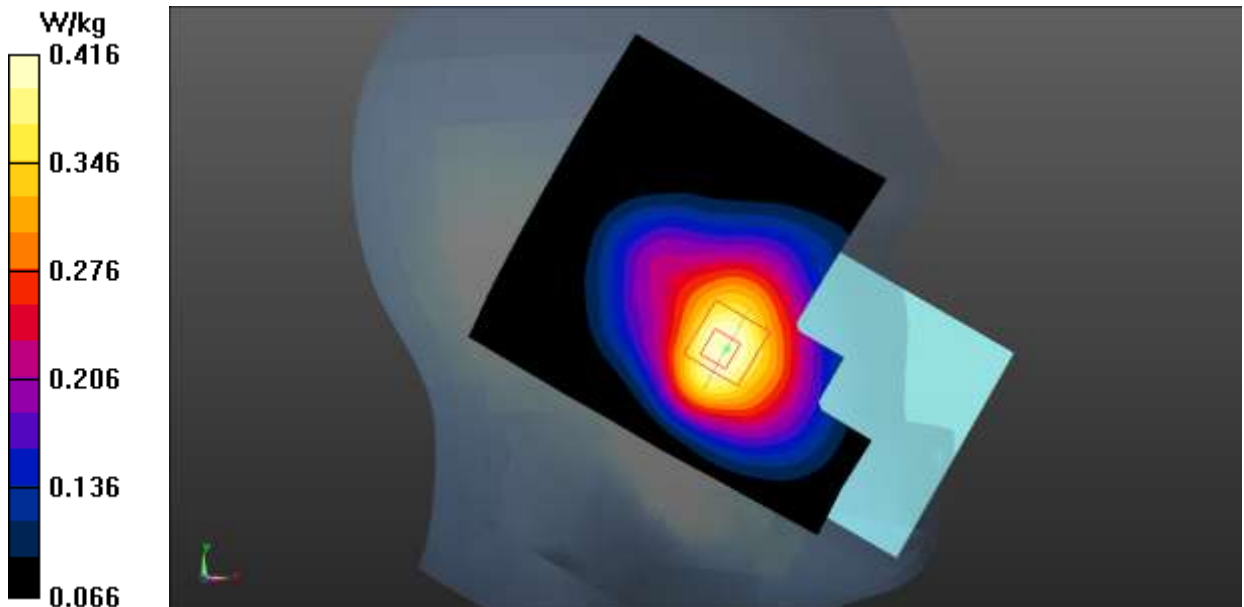
Area Scan (81x101x1): Interpolated grid: $dx=1.500 \text{ mm}$, $dy=1.500 \text{ mm}$ Maximum value of SAR (interpolated) = 0.431 W/kg **Zoom Scan (5x5x7)/Cube 0:** Measurement grid: $dx=8\text{mm}$, $dy=8\text{mm}$, $dz=5\text{mm}$ Reference Value = 9.236 V/m ; Power Drift = -0.05 dB Peak SAR (extrapolated) = 0.488 W/kg **SAR(1 g) = 0.385 W/kg ; SAR(10 g) = 0.288 W/kg** Maximum value of SAR (measured) = 0.416 W/kg **Fig.17 LTE Band 13 Head**

LTE Band 13 Body - Front Side Middle 1RB_49

Date: 2020-4-25

Electronics: DAE4 Sn1527

Medium: Head 750MHz

Medium parameters used: $f = 782 \text{ MHz}$; $\sigma = 0.904 \text{ S/m}$; $\epsilon_r = 42.24$; $\rho = 1000 \text{ kg/m}^3$ Ambient Temperature: 22.0°C Liquid Temperature: 21.5°C

Communication System: UID 0, LTE_FDD (0) Frequency: 782 MHz Duty Cycle: 1:1

Probe: EX3DV4 – SN3633 ConvF (9.59, 9.59, 9.59);

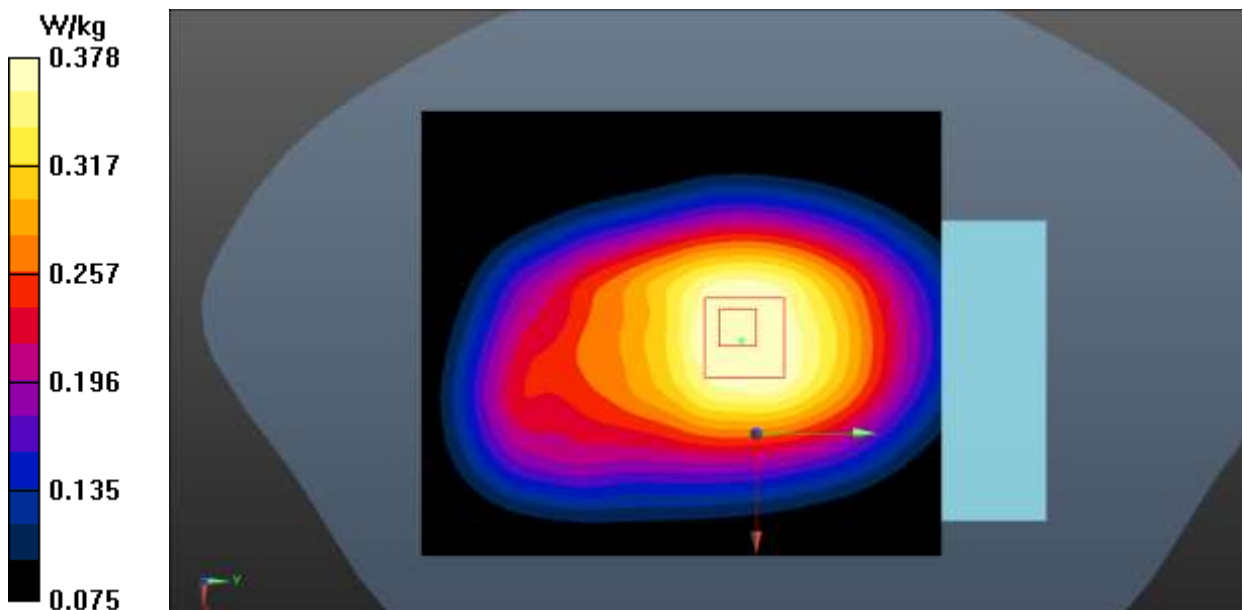
Area Scan (81x101x1): Interpolated grid: $dx=1.500 \text{ mm}$, $dy=1.500 \text{ mm}$ Maximum value of SAR (interpolated) = 0.391 W/kg **Zoom Scan (5x5x7)/Cube 0:** Measurement grid: $dx=8\text{mm}$, $dy=8\text{mm}$, $dz=5\text{mm}$ Reference Value = 20.69 V/m ; Power Drift = 0.02 dB Peak SAR (extrapolated) = 0.429 W/kg **SAR(1 g) = 0.349 W/kg ; SAR(10 g) = 0.270 W/kg** Maximum value of SAR (measured) = 0.378 W/kg **Fig.18 LTE Band 13 Body**

LTE Band 14 Head - Left Touch Middle 1RB_24

Date: 2020-4-25

Electronics: DAE4 Sn1527

Medium: Head 750MHz

Medium parameters used: $f = 793 \text{ MHz}$; $\sigma = 0.911 \text{ S/m}$; $\epsilon_r = 42.108$; $\rho = 1000 \text{ kg/m}^3$ Ambient Temperature: 22.0°C Liquid Temperature: 21.5°C

Communication System: UID 0, LTE_FDD (0) Frequency: 793 MHz Duty Cycle: 1:1

Probe: EX3DV4 – SN3633 ConvF (9.59, 9.59, 9.59);

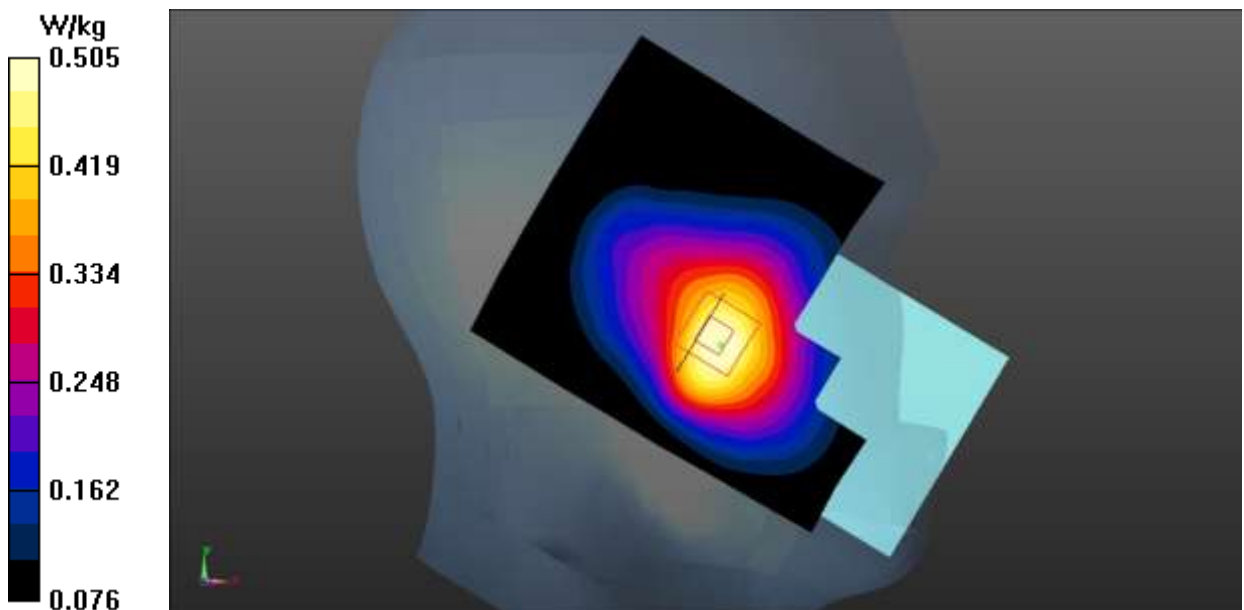
Area Scan (81x101x1): Interpolated grid: $dx=1.500 \text{ mm}$, $dy=1.500 \text{ mm}$ Maximum value of SAR (interpolated) = 0.517 W/kg **Zoom Scan (5x5x7)/Cube 0:** Measurement grid: $dx=8\text{mm}$, $dy=8\text{mm}$, $dz=5\text{mm}$ Reference Value = 11.56 V/m ; Power Drift = -0.03 dB Peak SAR (extrapolated) = 0.575 W/kg **SAR(1 g) = 0.411 W/kg ; SAR(10 g) = 0.346 W/kg** Maximum value of SAR (measured) = 0.505 W/kg **Fig.19 LTE Band 14 Head**

LTE Band 14 Body - Front Side Middle 1RB_24

Date: 2020-4-25

Electronics: DAE4 Sn1527

Medium: Head 750MHz

Medium parameters used: $f = 793 \text{ MHz}$; $\sigma = 0.911 \text{ S/m}$; $\epsilon_r = 42.108$; $\rho = 1000 \text{ kg/m}^3$ Ambient Temperature: 22.0°C Liquid Temperature: 21.5°C

Communication System: UID 0, LTE_FDD (0) Frequency: 793 MHz Duty Cycle: 1:1

Probe: EX3DV4 – SN3633 ConvF (9.59, 9.59, 9.59);

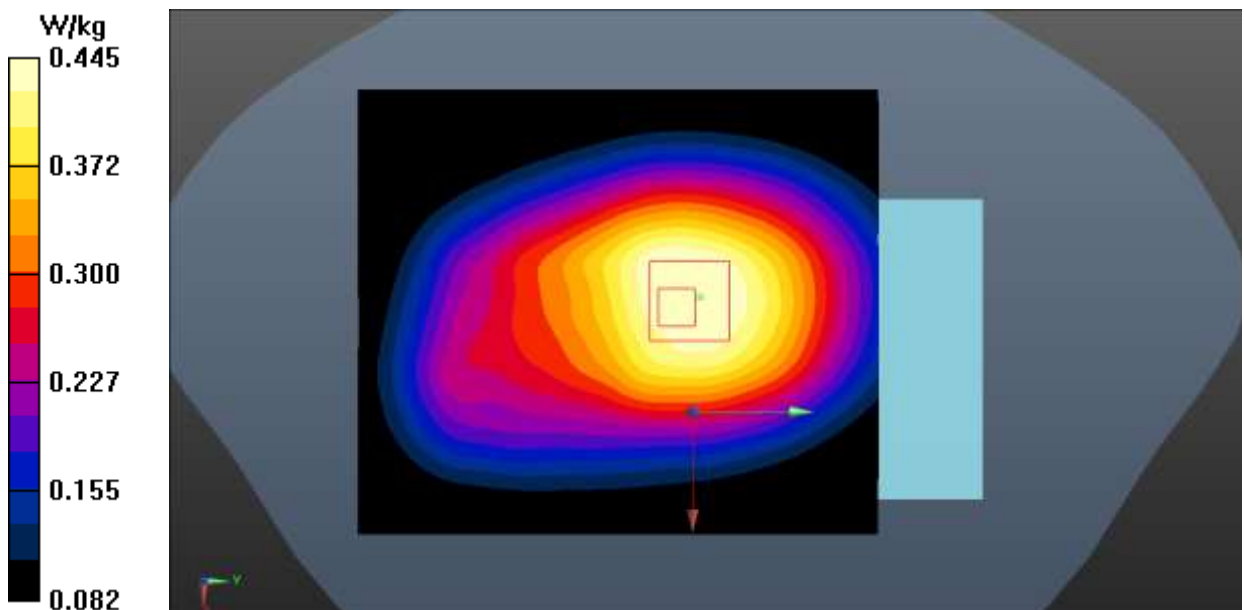
Area Scan (81x101x1): Interpolated grid: $dx=1.500 \text{ mm}$, $dy=1.500 \text{ mm}$ Maximum value of SAR (interpolated) = 0.454 W/kg **Zoom Scan (5x5x7)/Cube 0:** Measurement grid: $dx=8\text{mm}$, $dy=8\text{mm}$, $dz=5\text{mm}$ Reference Value = 22.35 V/m ; Power Drift = -0.01 dB Peak SAR (extrapolated) = 0.498 W/kg **SAR(1 g) = 0.411 W/kg ; SAR(10 g) = 0.319 W/kg** Maximum value of SAR (measured) = 0.445 W/kg **Fig.20 LTE Band 14 Body**

LTE Band 25 Head - Right Touch Middle 1RB_0

Date: 2020-5-1

Electronics: DAE4 Sn1527

Medium: Head 1900MHz

Medium parameters used (interpolated): $f = 1882.5$ MHz; $\sigma = 1.407$ S/m; $\epsilon_r = 39.085$; $\rho = 1000$ kg/m³

Ambient Temperature: 22.0°C Liquid Temperature: 21.5°C

Communication System: UID 0, LTE_FDD (0) Frequency: 1882.5 MHz Duty Cycle: 1:1

Probe: EX3DV4 – SN3633 ConvF (7.76, 7.76, 7.76);

Area Scan (81x101x1): Interpolated grid: dx=1.500 mm, dy=1.500 mm

Maximum value of SAR (interpolated) = 0.844 W/kg

Zoom Scan (5x5x7)/Cube 0: Measurement grid: dx=8mm, dy=8mm, dz=5mm

Reference Value = 6.996 V/m; Power Drift = 0.17 dB

Peak SAR (extrapolated) = 1.05 W/kg

SAR(1 g) = 0.648 W/kg; SAR(10 g) = 0.379 W/kg

Maximum value of SAR (measured) = 0.770 W/kg

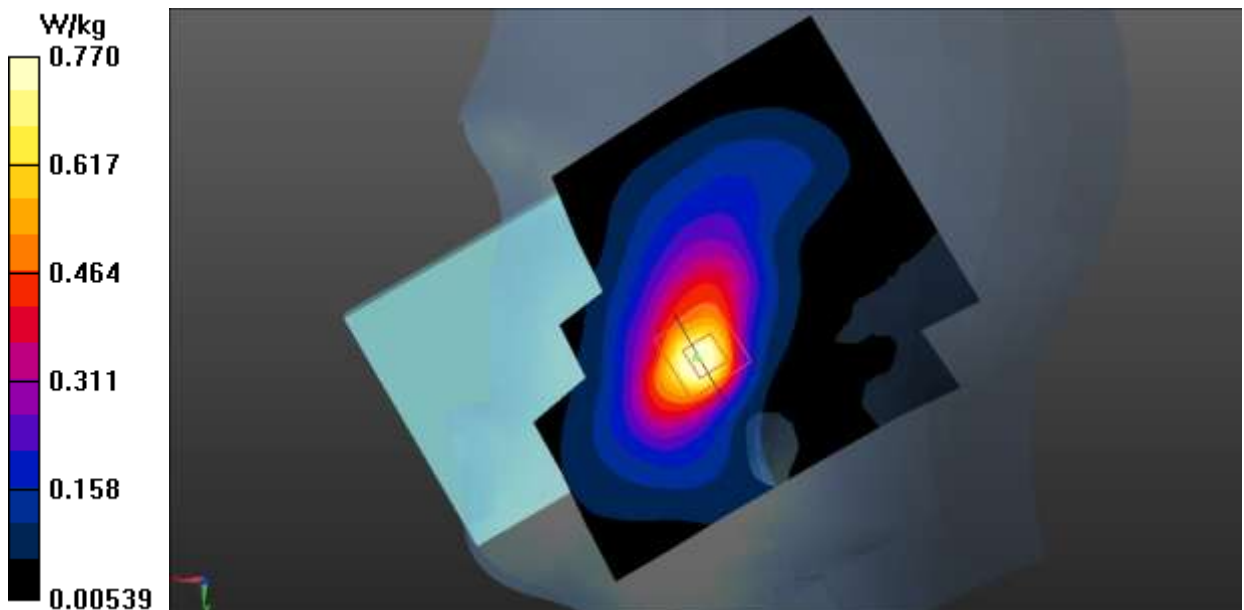

Fig.21 LTE Band 25 Head

LTE Band 25 Body - Rear Side Middle 1RB_0

Date: 2020-5-1

Electronics: DAE4 Sn1527

Medium: Head 1900MHz

Medium parameters used (interpolated): $f = 1882.5$ MHz; $\sigma = 1.407$ S/m; $\epsilon_r = 39.085$; $\rho = 1000$ kg/m³

Ambient Temperature: 22.0°C Liquid Temperature: 21.5°C

Communication System: UID 0, LTE_FDD (0) Frequency: 1882.5 MHz Duty Cycle: 1:1

Probe: EX3DV4 – SN3633 ConvF (7.76, 7.76, 7.76);

Area Scan (81x71x1): Interpolated grid: dx=1.500 mm, dy=1.500 mm

Maximum value of SAR (interpolated) = 0.333 W/kg

Zoom Scan (5x5x7)/Cube 0: Measurement grid: dx=8mm, dy=8mm, dz=5mm

Reference Value = 13.27 V/m; Power Drift = 0.03 dB

Peak SAR (extrapolated) = 0.414 W/kg

SAR(1 g) = 0.279 W/kg; SAR(10 g) = 0.181 W/kg

Maximum value of SAR (measured) = 0.324 W/kg

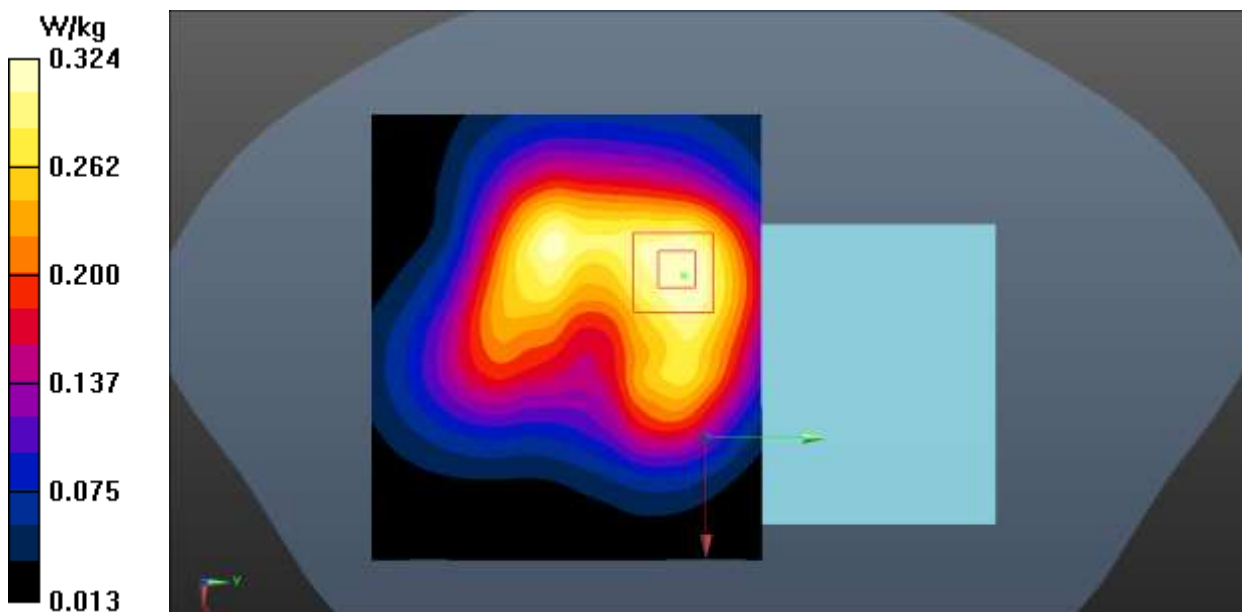

Fig.22 LTE Band 25 Body

LTE Band 26 Head - Right Touch High 1RB_74

Date: 2020-4-23

Electronics: DAE4 Sn1527

Medium: Head 835MHz

Medium parameters used (interpolated): $f = 841.5$ MHz; $\sigma = 0.897$ S/m; $\epsilon_r = 41.889$; $\rho = 1000$ kg/m³

Ambient Temperature: 22.0°C Liquid Temperature: 21.5°C

Communication System: UID 0, LTE_FDD (0) Frequency: 841.5 MHz Duty Cycle: 1:1

Probe: EX3DV4 – SN3633 ConvF (9.59, 9.59, 9.59);

Area Scan (81x61x1): Interpolated grid: dx=1.500 mm, dy=1.500 mm

Maximum value of SAR (interpolated) = 0.497 W/kg

Zoom Scan (5x5x7)/Cube 0: Measurement grid: dx=8mm, dy=8mm, dz=5mm

Reference Value = 11.40 V/m; Power Drift = -0.03 dB

Peak SAR (extrapolated) = 0.576 W/kg

SAR(1 g) = 0.462 W/kg; SAR(10 g) = 0.352 W/kg

Maximum value of SAR (measured) = 0.513 W/kg

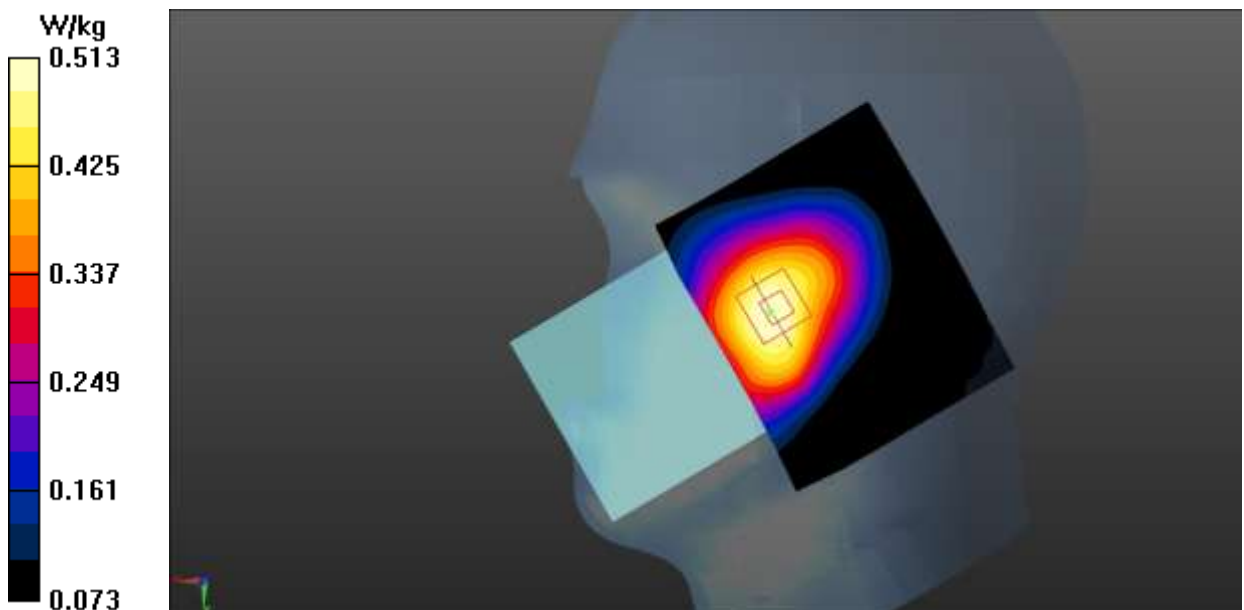
**Fig.23 LTE Band 26 Head**

LTE Band 26 Body - Front Side High 1RB_74

Date: 2020-4-23

Electronics: DAE4 Sn1527

Medium: Head 835MHz

Medium parameters used (interpolated): $f = 841.5$ MHz; $\sigma = 0.897$ S/m; $\epsilon_r = 41.889$; $\rho = 1000$ kg/m³

Ambient Temperature: 22.0°C Liquid Temperature: 21.5°C

Communication System: UID 0, LTE_FDD (0) Frequency: 841.5 MHz Duty Cycle: 1:1

Probe: EX3DV4 – SN3633 ConvF (9.59, 9.59, 9.59);

Area Scan (81x101x1): Interpolated grid: dx=1.500 mm, dy=1.500 mm

Maximum value of SAR (interpolated) = 0.437 W/kg

Zoom Scan (5x5x7)/Cube 0: Measurement grid: dx=8mm, dy=8mm, dz=5mm

Reference Value = 20.43 V/m; Power Drift = -0.10 dB

Peak SAR (extrapolated) = 0.462 W/kg

SAR(1 g) = 0.384 W/kg; SAR(10 g) = 0.296 W/kg

Maximum value of SAR (measured) = 0.423 W/kg

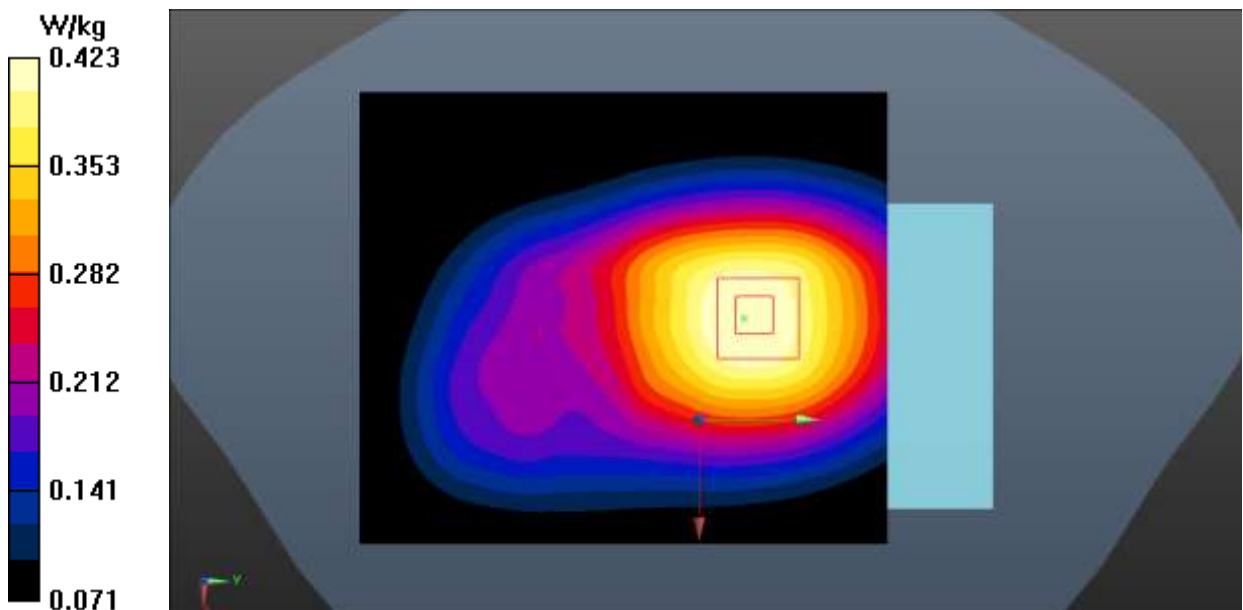
**Fig.24 LTE Band 26 Body**

LTE Band 30 Head - Left Touch Middle 1RB_24

Date: 2020-5-2

Electronics: DAE4 Sn1527

Medium: Head 1900MHz

Medium parameters used: $f = 2310$ MHz; $\sigma = 1.66$ S/m; $\epsilon_r = 39.906$; $\rho = 1000$ kg/m³

Ambient Temperature: 22.0°C Liquid Temperature: 21.5°C

Communication System: UID 0, LTE_FDD (0) Frequency: 2310 MHz Duty Cycle: 1:1

Probe: EX3DV4 – SN3633 ConvF (7.69, 7.69, 7.69);

Area Scan (91x141x1): Interpolated grid: dx=1.000 mm, dy=1.000 mm

Maximum value of SAR (interpolated) = 0.677 W/kg

Zoom Scan (7x7x7)/Cube 0: Measurement grid: dx=5mm, dy=5mm, dz=5mm

Reference Value = 7.555 V/m; Power Drift = 0.01 dB

Peak SAR (extrapolated) = 0.969 W/kg

SAR(1 g) = 0.414 W/kg; SAR(10 g) = 0.350 W/kg

Maximum value of SAR (measured) = 0.615 W/kg

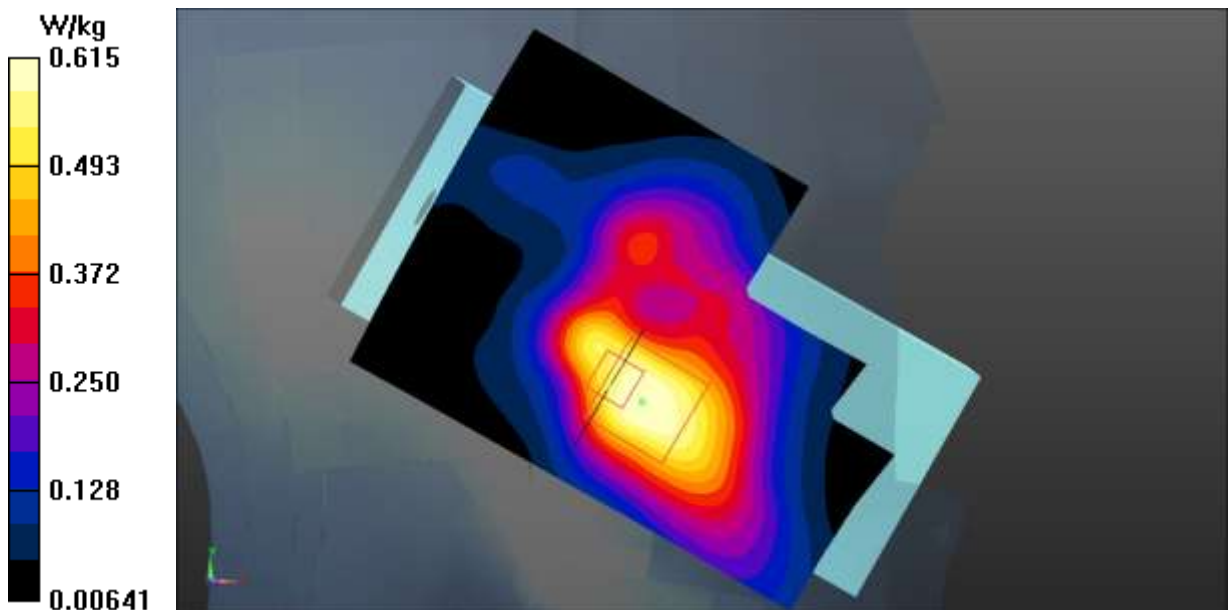

Fig.25 LTE Band 30 Head

LTE Band 30 Body – Bottom Side Middle 1RB_24

Date: 2020-5-2

Electronics: DAE4 Sn1527

Medium: Head 1900MHz

Medium parameters used: $f = 2310$ MHz; $\sigma = 1.66$ S/m; $\epsilon_r = 39.906$; $\rho = 1000$ kg/m³

Ambient Temperature: 22.0°C Liquid Temperature: 21.5°C

Communication System: UID 0, LTE_FDD (0) Frequency: 2310 MHz Duty Cycle: 1:1

Probe: EX3DV4 – SN3633 ConvF (7.69, 7.69, 7.69);

Area Scan (111x91x1): Interpolated grid: dx=1.000 mm, dy=1.000 mm

Maximum value of SAR (interpolated) = 0.821 W/kg

Zoom Scan (7x7x7)/Cube 0: Measurement grid: dx=5mm, dy=5mm, dz=5mm

Reference Value = 19.13 V/m; Power Drift = -0.01 dB

Peak SAR (extrapolated) = 1.18 W/kg

SAR(1 g) = 0.627 W/kg; SAR(10 g) = 0.336 W/kg

Maximum value of SAR (measured) = 0.790 W/kg

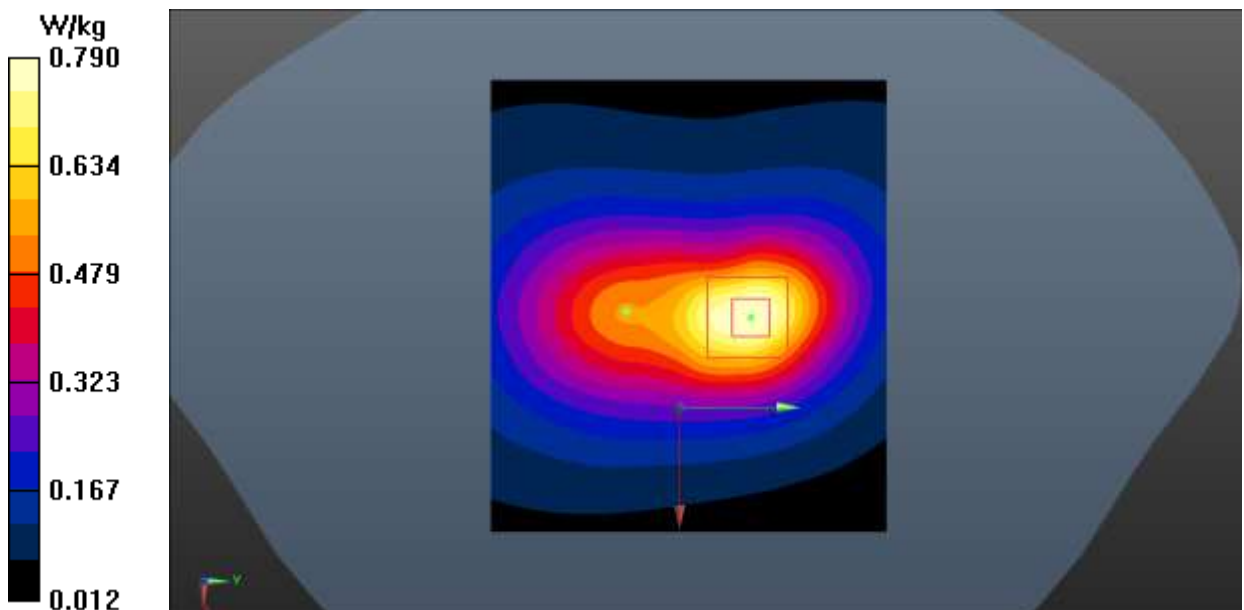

Fig.26 LTE Band 30 Body

LTE Band 41 Head - Right Touch High 1RB_99

Date: 2020-6-1

Electronics: DAE4 Sn1527

Medium: Head 2550MHz

Medium parameters used: $f = 2680$ MHz; $\sigma = 2.092$ S/m; $\epsilon_r = 37.655$; $\rho = 1000$ kg/m³

Ambient Temperature: 22.0°C Liquid Temperature: 21.5°C

Communication System: UID 0, LTE_TDD (0) Frequency: 2680 MHz Duty Cycle: 1:1.58

Probe: EX3DV4 – SN3633 ConvF (7.20, 7.20, 7.20);

Area Scan (121x101x1): Interpolated grid: dx=1.000 mm, dy=1.000 mm

Maximum value of SAR (interpolated) = 0.623 W/kg

Zoom Scan (7x7x7)/Cube 0: Measurement grid: dx=5mm, dy=5mm, dz=5mm

Reference Value = 3.785 V/m; Power Drift = 0.04 dB

Peak SAR (extrapolated) = 1.08 W/kg

SAR(1 g) = 0.520 W/kg; SAR(10 g) = 0.262 W/kg

Maximum value of SAR (measured) = 0.695 W/kg

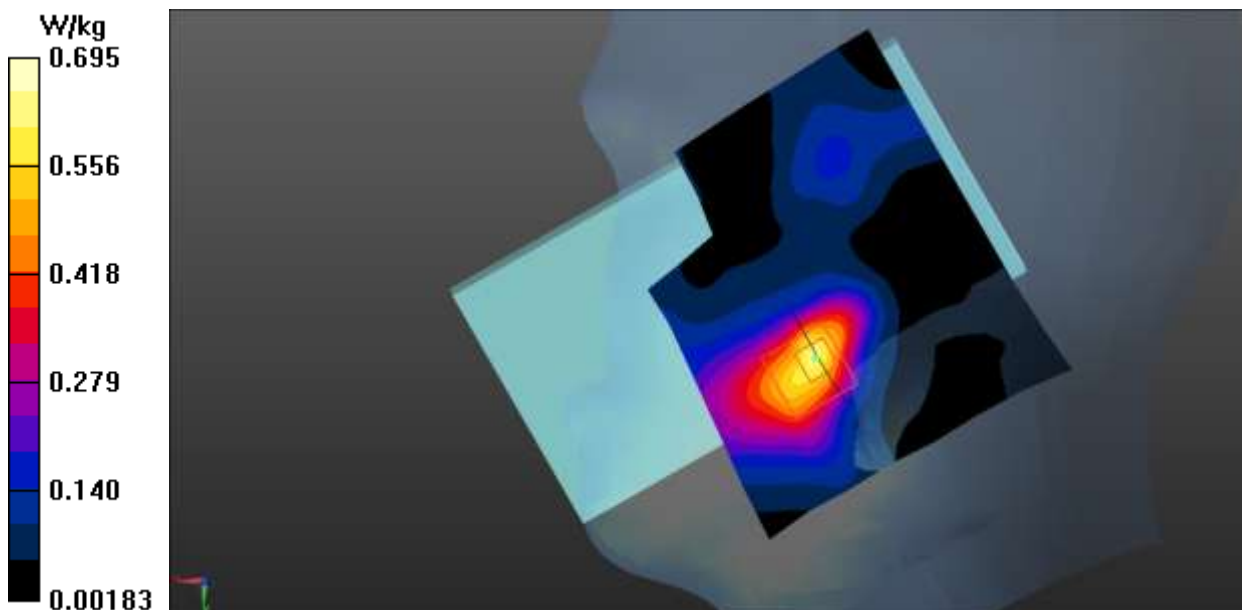

Fig.27 LTE Band 41 Head

LTE Band 41 Body – Rear Side High 1RB_99

Date: 2020-6-1

Electronics: DAE4 Sn1527

Medium: Head 2550MHz

Medium parameters used: $f = 2680$ MHz; $\sigma = 2.092$ S/m; $\epsilon_r = 37.655$; $\rho = 1000$ kg/m³

Ambient Temperature: 22.0°C Liquid Temperature: 21.5°C

Communication System: UID 0, LTE_TDD (0) Frequency: 2680 MHz Duty Cycle: 1:1.58

Probe: EX3DV4 – SN3633 ConvF (7.20, 7.20, 7.20);

Area Scan (81x81x1): Interpolated grid: dx=1.000 mm, dy=1.000 mm

Maximum value of SAR (interpolated) = 0.877 W/kg

Zoom Scan (7x7x7)/Cube 0: Measurement grid: dx=5mm, dy=5mm, dz=5mm

Reference Value = 5.811 V/m; Power Drift = 0.03 dB

Peak SAR (extrapolated) = 1.17 W/kg

SAR(1 g) = 0.565 W/kg; SAR(10 g) = 0.263 W/kg

Maximum value of SAR (measured) = 0.839 W/kg

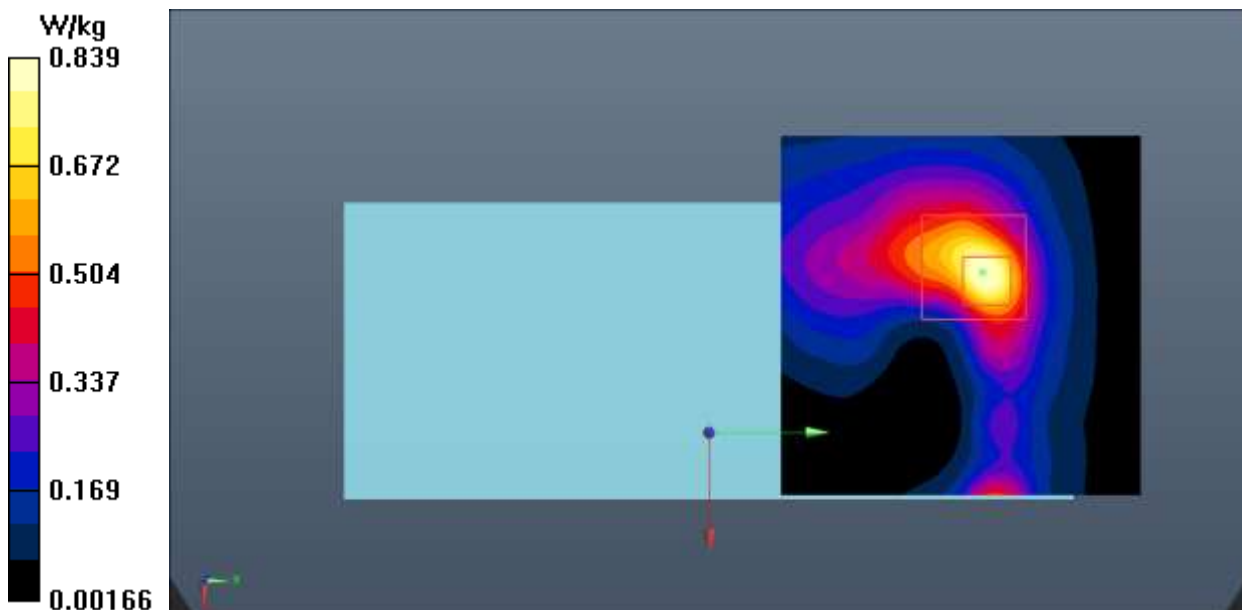

Fig.28 LTE Band 41 Body

LTE Band 66 Head - Right Touch Low 1RB_99

Date: 2020-4-29

Electronics: DAE4 Sn1527

Medium: Head 1750MHz

Medium parameters used: $f = 1720$ MHz; $\sigma = 1.36$ S/m; $\epsilon_r = 39.448$; $\rho = 1000$ kg/m³

Ambient Temperature: 22.0°C Liquid Temperature: 21.5°C

Communication System: UID 0, LTE_FDD (0) Frequency: 1720 MHz Duty Cycle: 1:1

Probe: EX3DV4 – SN3633 ConvF (8.09, 8.09, 8.09);

Area Scan (81x71x1): Interpolated grid: dx=1.500 mm, dy=1.500 mm

Maximum value of SAR (interpolated) = 0.746 W/kg

Zoom Scan (5x5x7)/Cube 0: Measurement grid: dx=8mm, dy=8mm, dz=5mm

Reference Value = 15.74 V/m; Power Drift = -0.06 dB

Peak SAR (extrapolated) = 0.983 W/kg

SAR(1 g) = 0.650 W/kg; SAR(10 g) = 0.405 W/kg

Maximum value of SAR (measured) = 0.741 W/kg

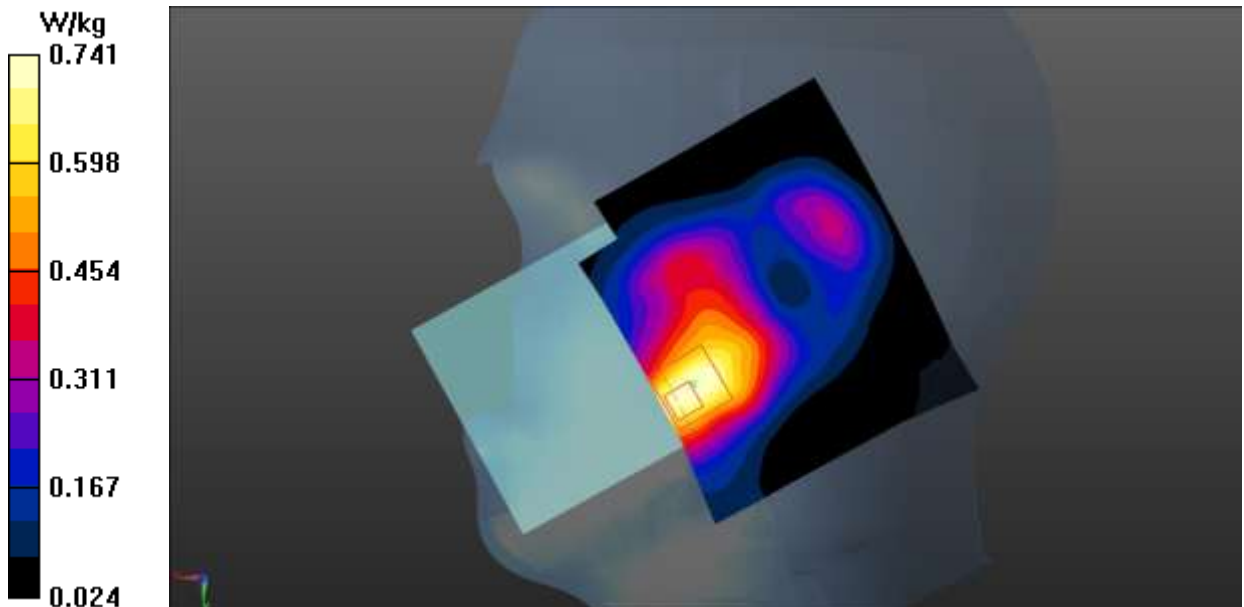
**Fig.29 LTE Band 66 Head**

LTE Band 66 Body – Front Side Low 1RB_99

Date: 2020-4-29

Electronics: DAE4 Sn1527

Medium: Head 1750MHz

Medium parameters used: $f = 1720$ MHz; $\sigma = 1.36$ S/m; $\epsilon_r = 39.448$; $\rho = 1000$ kg/m³

Ambient Temperature: 22.0°C Liquid Temperature: 21.5°C

Communication System: UID 0, LTE_FDD (0) Frequency: 1720 MHz Duty Cycle: 1:1

Probe: EX3DV4 – SN3633 ConvF (8.09, 8.09, 8.09);

Area Scan (81x101x1): Interpolated grid: dx=1.500 mm, dy=1.500 mm

Maximum value of SAR (interpolated) = 0.821 W/kg

Zoom Scan (5x5x7)/Cube 0: Measurement grid: dx=8mm, dy=8mm, dz=5mm

Reference Value = 16.07 V/m; Power Drift = -0.05 dB

Peak SAR (extrapolated) = 1.07 W/kg

SAR(1 g) = 0.538 W/kg; SAR(10 g) = 0.345 W/kg

Maximum value of SAR (measured) = 0.833 W/kg

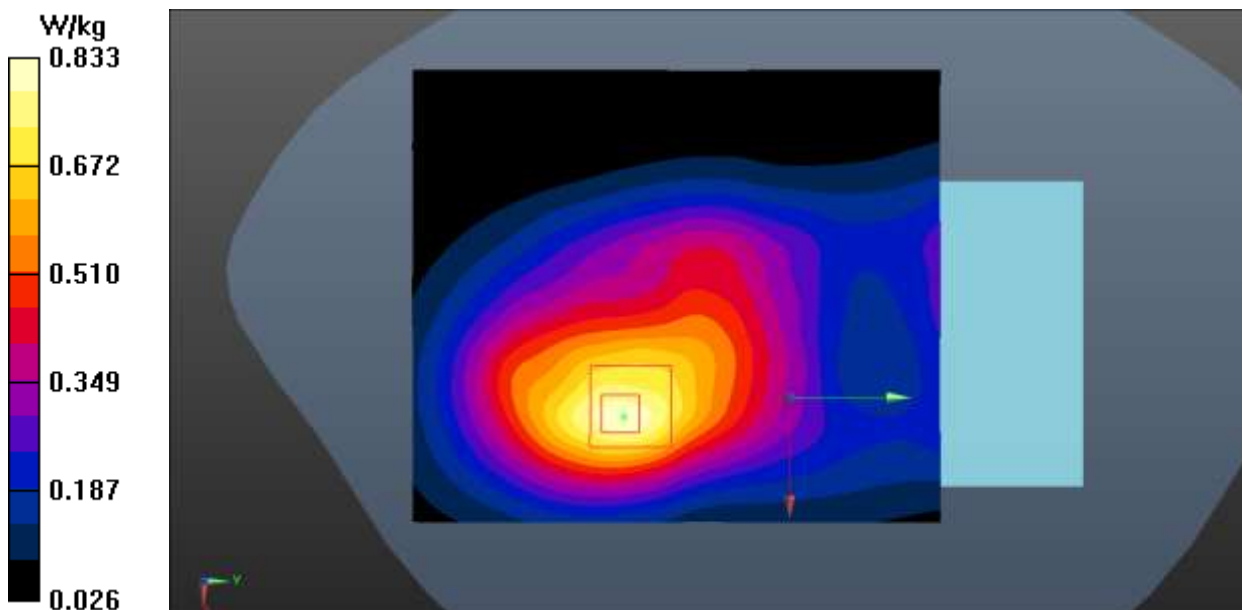

Fig.30 LTE Band 66 Body

WLAN 2.4G Head - Left Touch High

Date: 2020-5-5

Electronics: DAE4 Sn1527

Medium: Head 2450MHz

Medium parameters used: $f = 2462 \text{ MHz}$; $\sigma = 1.859 \text{ S/m}$; $\epsilon_r = 38.713$; $\rho = 1000 \text{ kg/m}^3$

Ambient Temperature: 22.0°C Liquid Temperature: 21.5°C

Communication System: UID 0, WiFi (0) Frequency: 2462 MHz Duty Cycle: 1:1

Probe: EX3DV4 – SN3633 ConvF (7.43, 7.43, 7.43);

Area Scan (111x131x1): Interpolated grid: $dx=1.000 \text{ mm}$, $dy=1.000 \text{ mm}$

Maximum value of SAR (interpolated) = 1.24 W/kg

Zoom Scan (7x7x7)/Cube 0: Measurement grid: $dx=5\text{mm}$, $dy=5\text{mm}$, $dz=5\text{mm}$

Reference Value = 11.75 V/m ; Power Drift = -0.07 dB

Peak SAR (extrapolated) = 2.53 W/kg

SAR(1 g) = 0.985 W/kg ; SAR(10 g) = 0.485 W/kg

Maximum value of SAR (measured) = 1.46 W/kg

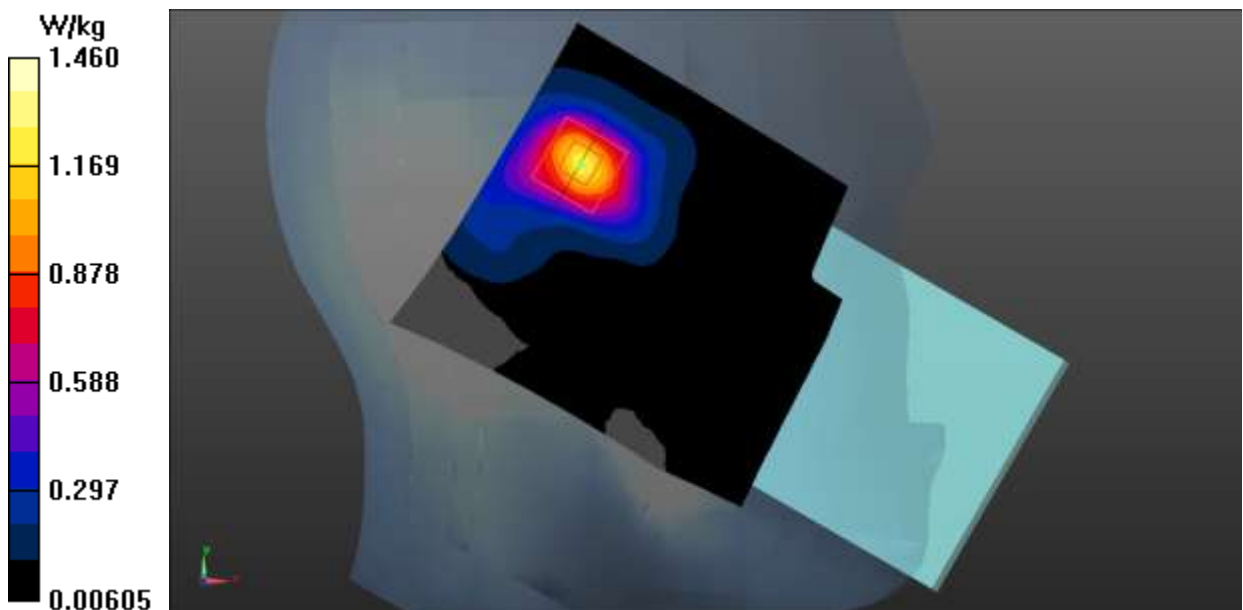

Fig.31 WLAN 2.4G Head

WLAN 2.4G Body – Front Side Low

Date: 2020-5-5

Electronics: DAE4 Sn1527

Medium: Head 2450MHz

Medium parameters used: $f = 2412$ MHz; $\sigma = 1.801$ S/m; $\epsilon_r = 38.878$; $\rho = 1000$ kg/m³

Ambient Temperature: 22.0°C Liquid Temperature: 21.5°C

Communication System: UID 0, WiFi (0) Frequency: 2412 MHz Duty Cycle: 1:1

Probe: EX3DV4 – SN3633 ConvF (7.43, 7.43, 7.43);

Area Scan (91x151x1): Interpolated grid: dx=1.000 mm, dy=1.000 mm

Maximum value of SAR (interpolated) = 0.324 W/kg

Zoom Scan (7x7x7)/Cube 0: Measurement grid: dx=5mm, dy=5mm, dz=5mm

Reference Value = 4.417 V/m; Power Drift = 0.03 dB

Peak SAR (extrapolated) = 0.533 W/kg

SAR(1 g) = 0.267 W/kg; SAR(10 g) = 0.131 W/kg

Maximum value of SAR (measured) = 0.344 W/kg

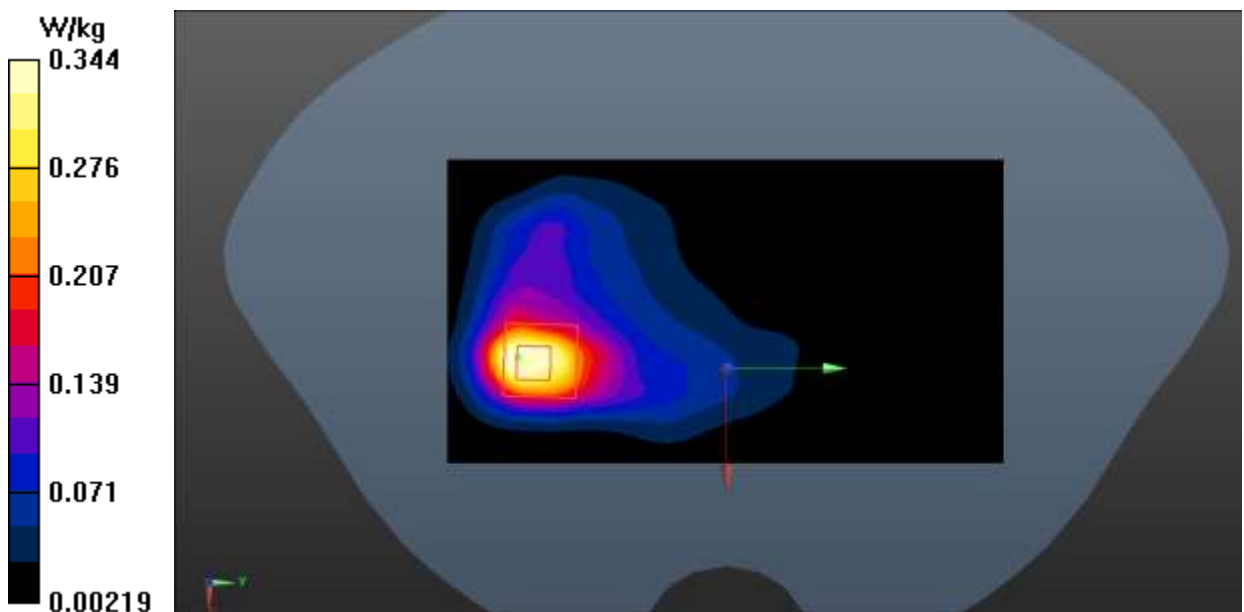

Fig.32 WLAN 2.4G Body

WLAN 5G Head - Left Tilt CH151

Date: 2020-5-6

Electronics: DAE4 Sn1527

Medium: Head 5750MHz

Medium parameters used (interpolated): $f = 5755$ MHz; $\sigma = 5.164$ S/m; $\epsilon_r = 36.404$; $\rho = 1000$ kg/m³

Ambient Temperature: 22.0°C Liquid Temperature: 21.5°C

Communication System: UID 0, WiFi 5G (0) Frequency: 5755 MHz Duty Cycle: 1:1

Probe: EX3DV4 – SN3633 ConvF (4.73, 4.73, 4.73);

Area Scan (91x171x1): Interpolated grid: dx=1.000 mm, dy=1.000 mm

Maximum value of SAR (interpolated) = 1.02 W/kg

Zoom Scan (7x7x11)/Cube 0: Measurement grid: dx=4mm, dy=4mm, dz=2mm

Reference Value = 3.671 V/m; Power Drift = -0.06 dB

Peak SAR (extrapolated) = 1.25 W/kg

SAR(1 g) = 0.548 W/kg; SAR(10 g) = 0.169 W/kg

Maximum value of SAR (measured) = 0.966 W/kg

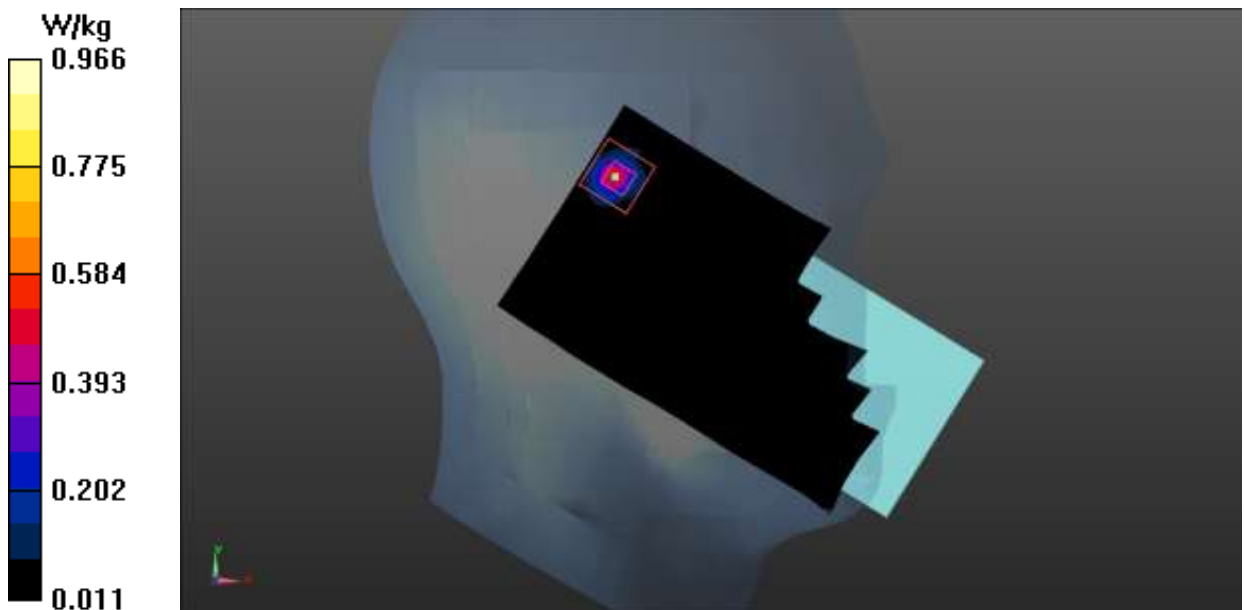

Fig.33 WLAN 5G Head

WLAN 5G Body – Right Side CH151

Date: 2020-5-6

Electronics: DAE4 Sn1527

Medium: Head 5750MHz

Medium parameters used (interpolated): $f = 5755$ MHz; $\sigma = 5.164$ S/m; $\epsilon_r = 36.404$; $\rho = 1000$ kg/m³

Ambient Temperature: 22.0°C Liquid Temperature: 21.5°C

Communication System: UID 0, WiFi 5G (0) Frequency: 5755 MHz Duty Cycle: 1:1

Probe: EX3DV4 – SN3633 ConvF (4.73, 4.73, 4.73);

Area Scan (81x81x1): Interpolated grid: dx=1.000 mm, dy=1.000 mm

Maximum value of SAR (interpolated) = 0.953 W/kg

Zoom Scan (7x7x11)/Cube 0: Measurement grid: dx=4mm, dy=4mm, dz=2mm

Reference Value = 8.676 V/m; Power Drift = 0.04 dB

Peak SAR (extrapolated) = 1.14 W/kg

SAR(1 g) = 0.289 W/kg; SAR(10 g) = 0.114 W/kg.

Maximum value of SAR (measured) = 0.936 W/kg

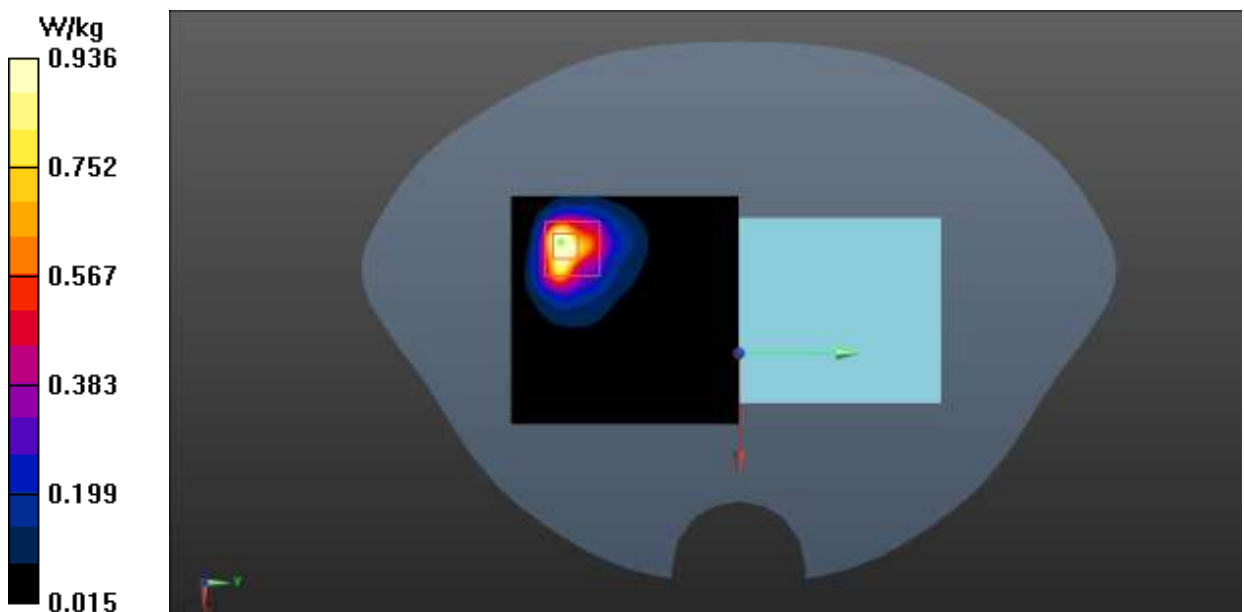

Fig.34 WLANB 5G Body

ANNEX B: System Verification Results

750MHz

Date: 2020-4-25

Electronics: DAE4 Sn1527

Medium: Head 750MHz

Medium parameters used: $f = 750 \text{ MHz}$; $\sigma = 0.884 \text{ S/m}$; $\epsilon_r = 42.464.$; $\rho = 1000 \text{ kg/m}^3$

Ambient Temperature: 22.5°C Liquid Temperature: 22.0°C

Communication System: CW Frequency: 750 MHz Duty Cycle: 1:1

Probe: EX3DV4 – SN3633 ConvF (9.59, 9.59, 9.59);

System Validation /Area Scan (81x191x1): Interpolated grid: $dx=1.000 \text{ mm}$, $dy=1.000 \text{ mm}$

Reference Value = 58.772 V/m ; Power Drift = -0.03 dB

SAR(1 g) = 2.15 W/kg; SAR(10 g) = 1.43 W/kg

Maximum value of SAR (interpolated) = 2.35 W/kg

System Validation /Zoom Scan (7x7x7)/Cube 0: Measurement grid: $dx=5\text{mm}$, $dy=5\text{mm}$, $dz=5\text{mm}$

Reference Value = 58.772 V/m ; Power Drift = -0.03 dB

Peak SAR (extrapolated) = 2.65 W/kg

SAR(1 g) = 2.07 W/kg; SAR(10 g) = 1.41 W/kg

Maximum value of SAR (measured) = 2.32 W/kg

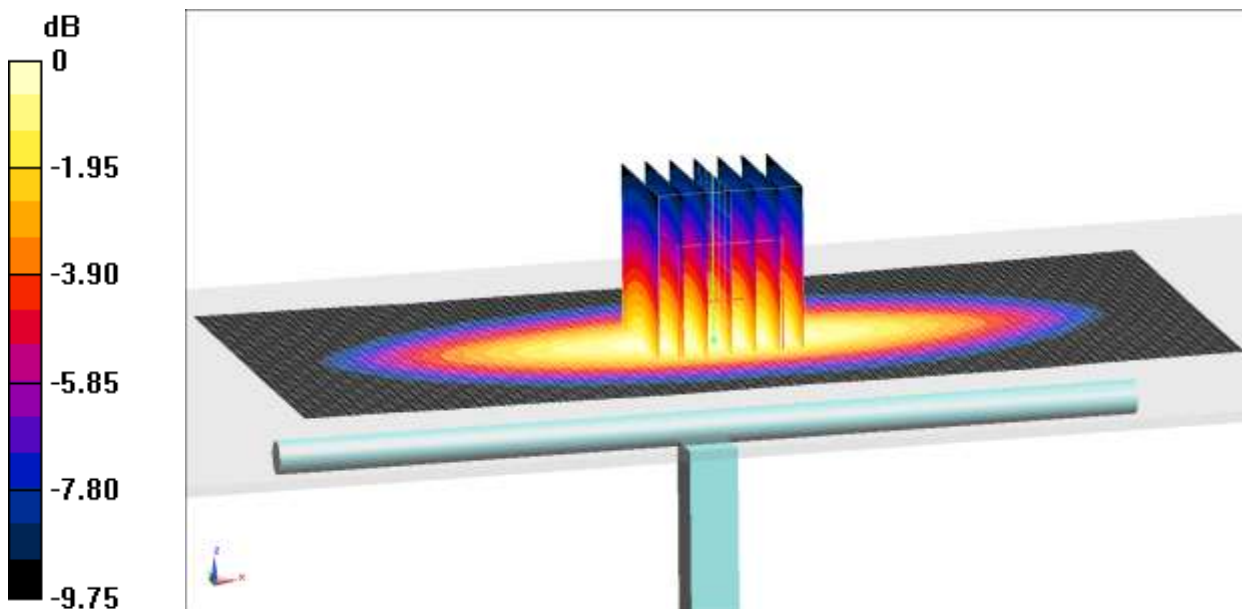

0 dB = 2.32 W/kg = 3.65 dB W/kg

Fig.B.1. Validation 750MHz 250mW

835MHz

Date: 2020-4-23

Electronics: DAE4 Sn1527

Medium: Head 835MHz

Medium parameters used: $f = 835 \text{ MHz}$; $\sigma = 0.891 \text{ S/m}$; $\epsilon_r = 41.968$; $\rho = 1000 \text{ kg/m}^3$ Ambient Temperature: 22.5°C Liquid Temperature: 22.0°C

Communication System: CW Frequency: 835 MHz Duty Cycle: 1:1

Probe: EX3DV4 – SN3633 ConvF (9.59, 9.59, 9.59);

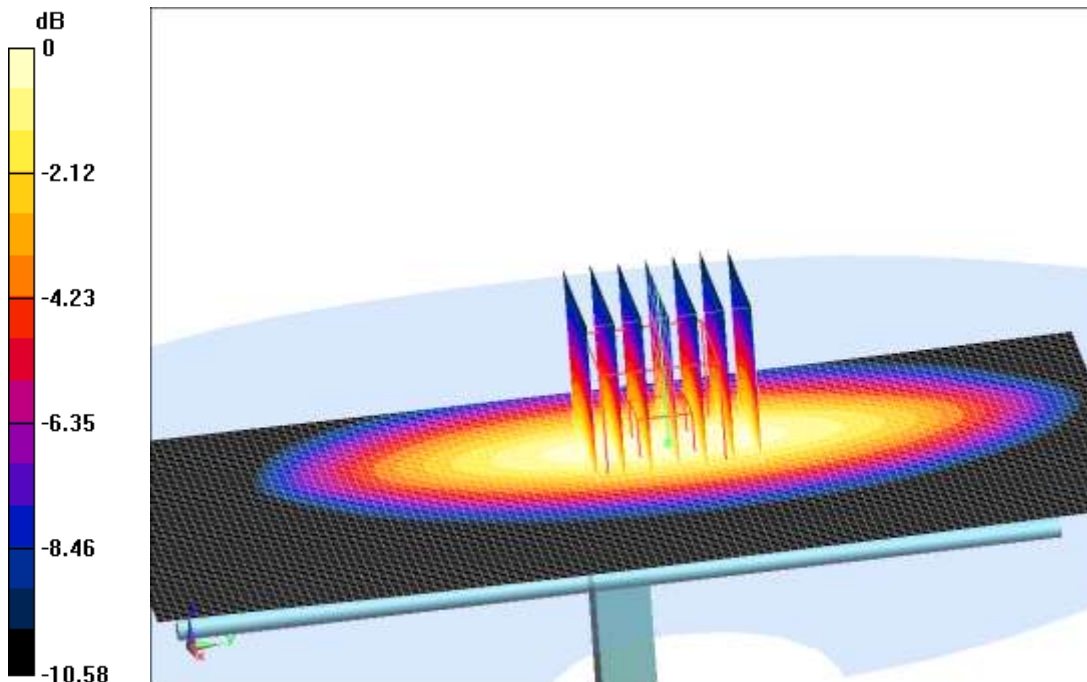
System Validation /Area Scan (81x161x1): Interpolated grid: $dx=1.000 \text{ mm}$, $dy=1.000 \text{ mm}$ Reference Value = 61.428 V/m ; Power Drift = -0.11 dB **SAR(1 g) = 2.40 W/kg; SAR(10 g) = 1.58 W/kg**Maximum value of SAR (interpolated) = 2.79 W/kg **System Validation /Zoom Scan (7x7x7)/Cube 0:** Measurement grid: $dx=5\text{mm}$, $dy=5\text{mm}$, $dz=5\text{mm}$ Reference Value = 61.428 V/m ; Power Drift = -0.11 dB Peak SAR (extrapolated) = 3.46 W/kg **SAR(1 g) = 2.33 W/kg; SAR(10 g) = 1.55 W/kg**Maximum value of SAR (measured) = 2.75 W/kg 0 dB = 2.75 W/kg = 4.39 dB W/kg **Fig.B.2. Validation 835MHz 250mW**

1750MHz

Date: 2020-4-29

Electronics: DAE4 Sn1527

Medium: Head 1750MHz

Medium parameters used: $f = 1750 \text{ MHz}$; $\sigma = 1.386 \text{ S/m}$; $\epsilon_r = 39.332$; $\rho = 1000 \text{ kg/m}^3$

Ambient Temperature: 22.5°C Liquid Temperature: 22.0°C

Communication System: CW Frequency: 1750 MHz Duty Cycle: 1:1

Probe: EX3DV4 – SN3633 ConvF (8.09, 8.09, 8.09);

System Validation/Area Scan (61x121x1): Interpolated grid: $dx=1.000 \text{ mm}$, $dy=1.000 \text{ mm}$

Reference Value = 78.515 V/m ; Power Drift = 0.08 dB

SAR(1 g) = 9.26 W/kg; SAR(10 g) = 4.84 W/kg

Maximum value of SAR (interpolated) = 11.0 W/kg

System Validation/Zoom Scan (7x7x7)/Cube 0: Measurement grid: $dx=5\text{mm}$, $dy=5\text{mm}$, $dz=5\text{mm}$

Reference Value = 78.515 V/m ; Power Drift = 0.08 dB

Peak SAR (extrapolated) = 18.6 W/kg

SAR(1 g) = 9.45 W/kg; SAR(10 g) = 4.93 W/kg

Maximum value of SAR (measured) = 11.3 W/kg

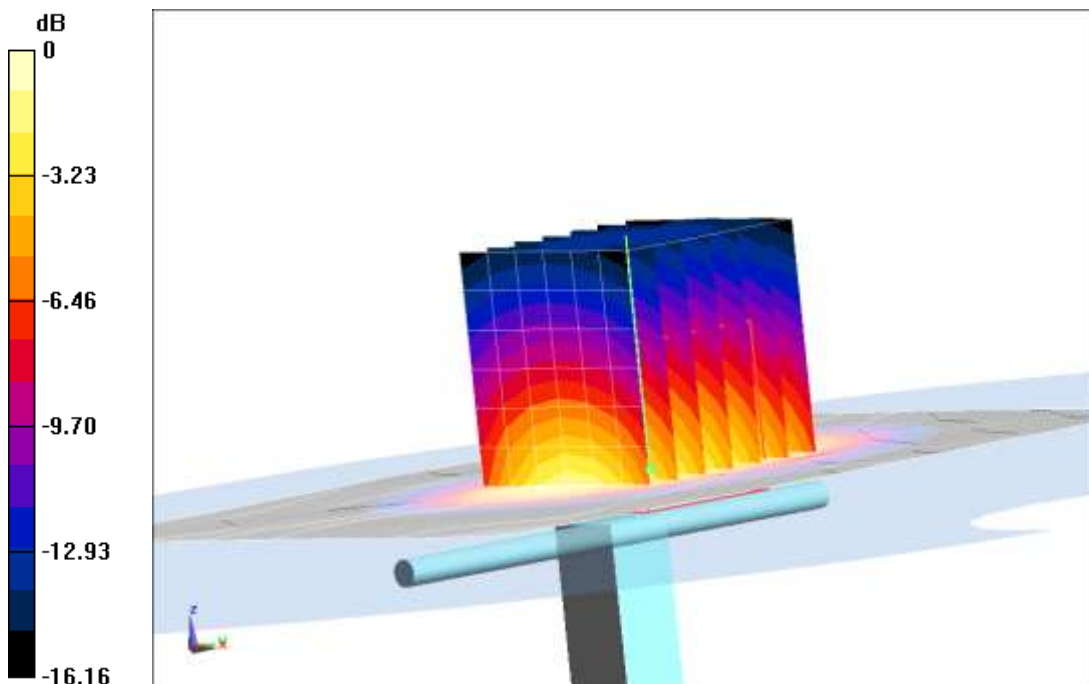

0 dB = 11.3 W/kg = 10.53 dB W/kg

Fig.B.3. Validation 1750MHz 250mW

1900MHz

Date: 2020-5-1

Electronics: DAE4 Sn1527

Medium: Head 1900MHz

Medium parameters used: $f = 1900 \text{ MHz}$; $\sigma = 1.422 \text{ S/m}$; $\epsilon_r = 39.018$; $\rho = 1000 \text{ kg/m}^3$

Ambient Temperature: 22.5°C Liquid Temperature: 22.0°C

Communication System: CW Frequency: 1900 MHz Duty Cycle: 1:1

Probe: EX3DV4 – SN3633 ConvF (7.76, 7.76, 7.76);

System Validation /Area Scan (81x121x1): Interpolated grid: $dx=1.000 \text{ mm}$, $dy=1.000 \text{ mm}$

Reference Value = 88.483 V/m; Power Drift = 0.05 dB

SAR(1 g) = 10.4 W/kg; SAR(10 g) = 5.29 W/kg

Maximum value of SAR (interpolated) = 13.4 W/kg

System Validation /Zoom Scan (7x7x7)/Cube 0: Measurement grid: $dx=5\text{mm}$, $dy=5\text{mm}$, $dz=5\text{mm}$

Reference Value = 88.483 V/m; Power Drift = 0.05 dB

Peak SAR (extrapolated) = 23.1 W/kg

SAR(1 g) = 10.6 W/kg; SAR(10 g) = 5.38 W/kg

Maximum value of SAR (measured) = 13.8 W/kg

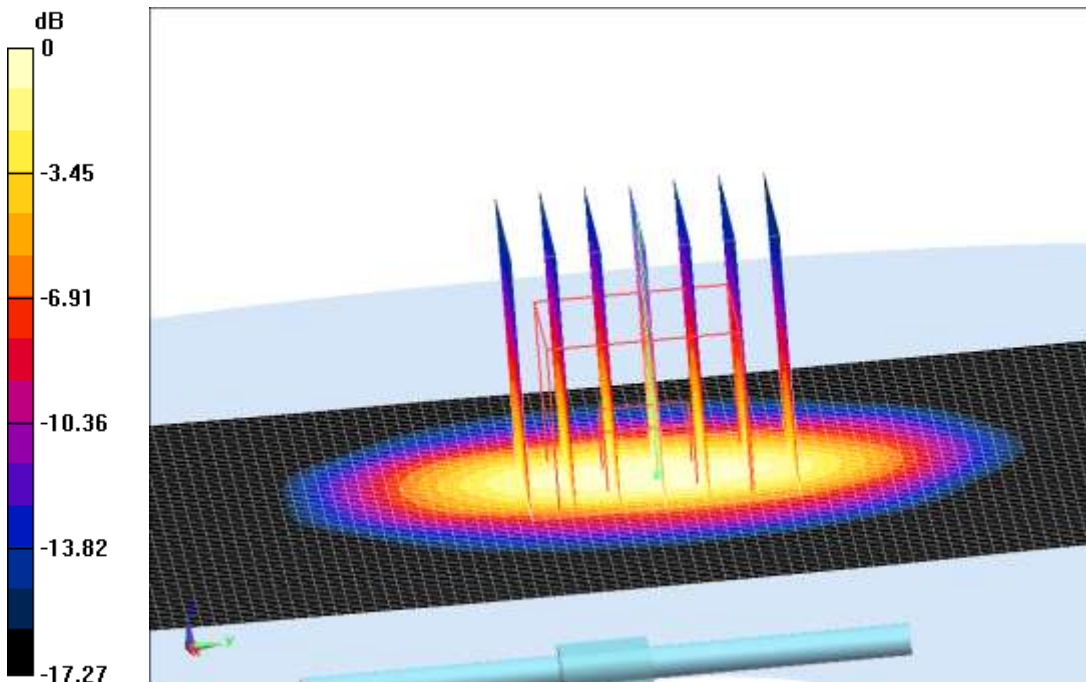

0 dB = 13.8 W/kg = 11.40 dB W/kg

Fig.B.4. Validation 1900MHz 250mW

2300MHz

Date: 2020-5-2

Electronics: DAE4 Sn1527

Medium: Head 2300MHz

Medium parameters used: $f = 2300 \text{ MHz}$; $\sigma = 1.648 \text{ S/m}$; $\epsilon_r = 39.94$; $\rho = 1000 \text{ kg/m}^3$

Ambient Temperature: 22.4°C Liquid Temperature: 21.5°C

Communication System: CW_TMC Frequency: 2300 MHz Duty Cycle: 1:1

Probe: EX3DV4 – SN3633 ConvF (7.69, 7.69, 7.69);

System Validation /Area Scan (31x91x1): Interpolated grid: $dx=1.000 \text{ mm}$, $dy=1.000 \text{ mm}$

Reference Value = 90.042 V/m ; Power Drift = -0.06 dB

SAR(1 g) = 12.0 W/kg; SAR(10 g) = 5.92 W/kg

Maximum value of SAR (interpolated) = 13.4 W/kg

System Validation/Zoom Scan (7x7x7)/Cube0: Measurement grid: $dx=5\text{mm}$, $dy=5\text{mm}$, $dz=5\text{mm}$

Reference Value = 90.042 V/m ; Power Drift = -0.06 dB

Peak SAR (extrapolated) = 26.9 W/kg

SAR(1 g) = 11.7 W/kg; SAR(10 g) = 5.77 W/kg

Maximum value of SAR (measured) = 13.6 W/kg

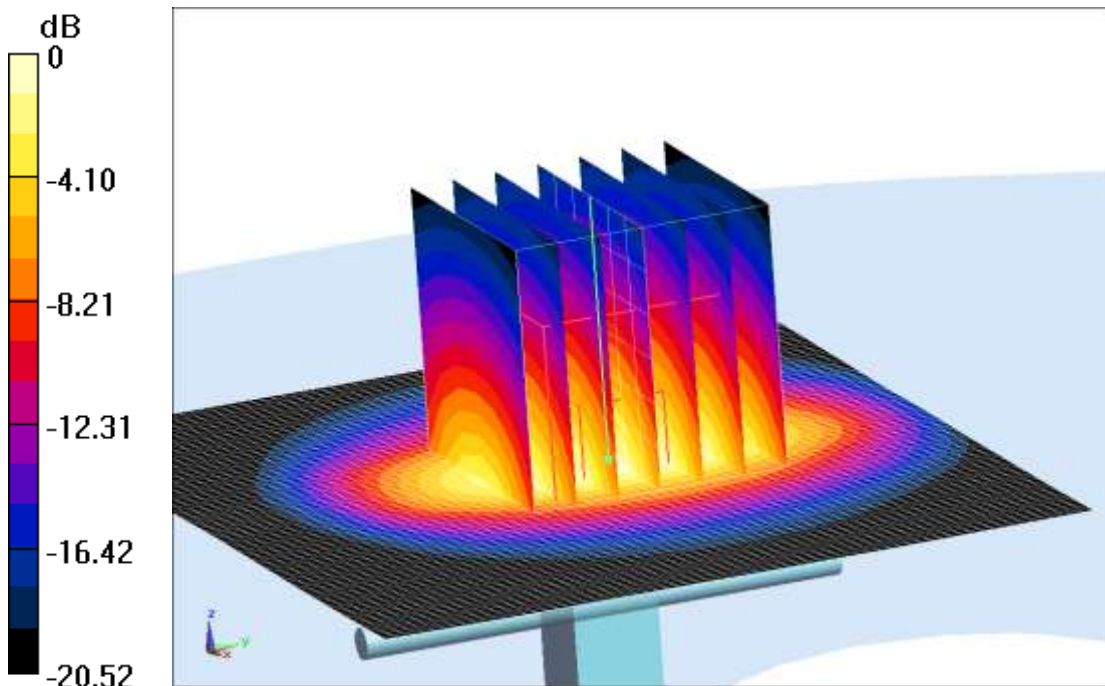

0 dB = 13.6 W/kg = 11.34 dB W/kg

Fig.B.5. Validation 2300MHz 250Mw

2450MHz

Date: 2020-5-5

Electronics: DAE4 Sn1527

Medium: Head 2450MHz

Medium parameters used: $f = 2450 \text{ MHz}$; $\sigma = 1.845 \text{ S/m}$; $\epsilon_r = 38.753$; $\rho = 1000 \text{ kg/m}^3$

Ambient Temperature: 22.5°C Liquid Temperature: 22.0°C

Communication System: CW Frequency: 2450 MHz Duty Cycle: 1:1

Probe: EX3DV4 – SN3633 ConvF (7.43, 7.43, 7.43);

System Validation /Area Scan (61x81x1): Interpolated grid: $dx=1.000 \text{ mm}$, $dy=1.000 \text{ mm}$

Reference Value = 92.682 V/m; Power Drift = 0.12 dB

SAR(1 g) = 13.2 W/kg; SAR(10 g) = 6.04 W/kg

Maximum value of SAR (interpolated) = 15.2 W/kg

System Validation /Zoom Scan (7x7x7)/Cube 0: Measurement grid: $dx=5\text{mm}$, $dy=5\text{mm}$, $dz=5\text{mm}$

Reference Value = 92.682 V/m; Power Drift = 0.12 dB

Peak SAR (extrapolated) = 30.4 W/kg

SAR(1 g) = 13.5 W/kg; SAR(10 g) = 6.18 W/kg

Maximum value of SAR (measured) = 15.6 W/kg

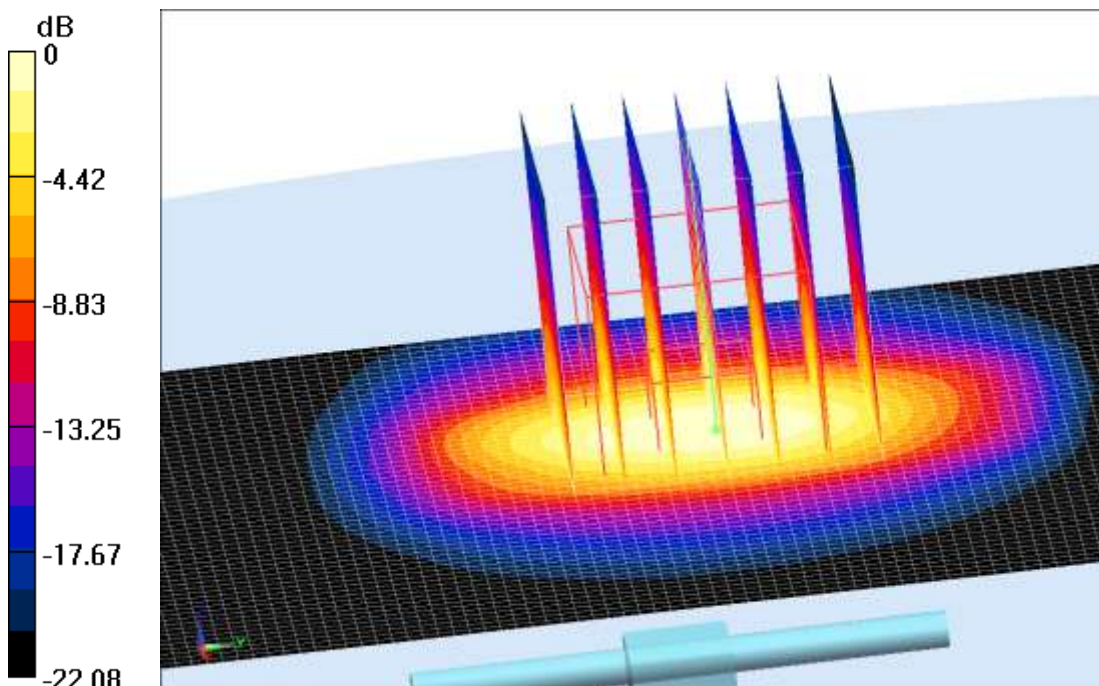

0 dB = 15.6 W/kg = 11.93 dB W/kg

Fig.B.6. Validation 2450MHz 250mW

2550 MHz

Date: 2020-6-1

Electronics: DAE4 Sn1527

Medium: Head 2550MHz

Medium parameters used: $f = 2550 \text{ MHz}$; $\sigma = 1.939 \text{ S/m}$; $\epsilon_r = 38.084$; $\rho = 1000 \text{ kg/m}^3$

Ambient Temperature: 22.5°C Liquid Temperature: 22.0°C

Communication System: CW_TMC Frequency: 2550 MHz Duty Cycle: 1:1

Probe: EX3DV4 – SN3633 ConvF (7.20, 7.20, 7.20);

System Validation/Area Scan (61x121x1): Interpolated grid: $dx=1.000 \text{ mm}$, $dy=1.000 \text{ mm}$

Reference Value = 93.556 V/m ; Power Drift = 0.09 dB

SAR(1 g) = 14.5 W/kg; SAR(10 g) = 6.63 W/kg

Maximum value of SAR (interpolated) = 16.3 W/kg

System Validation/Zoom Scan (7x7x7)/Cube0: Measurement grid: $dx=5\text{mm}$, $dy=5\text{mm}$, $dz=5\text{mm}$

Reference Value = 93.556 V/m ; Power Drift = 0.09 dB

Peak SAR (extrapolated) = 34.2 W/kg

SAR(1 g) = 14.8 W/kg; SAR(10 g) = 6.74 W/kg

Maximum value of SAR (measured) = 16.6 W/kg

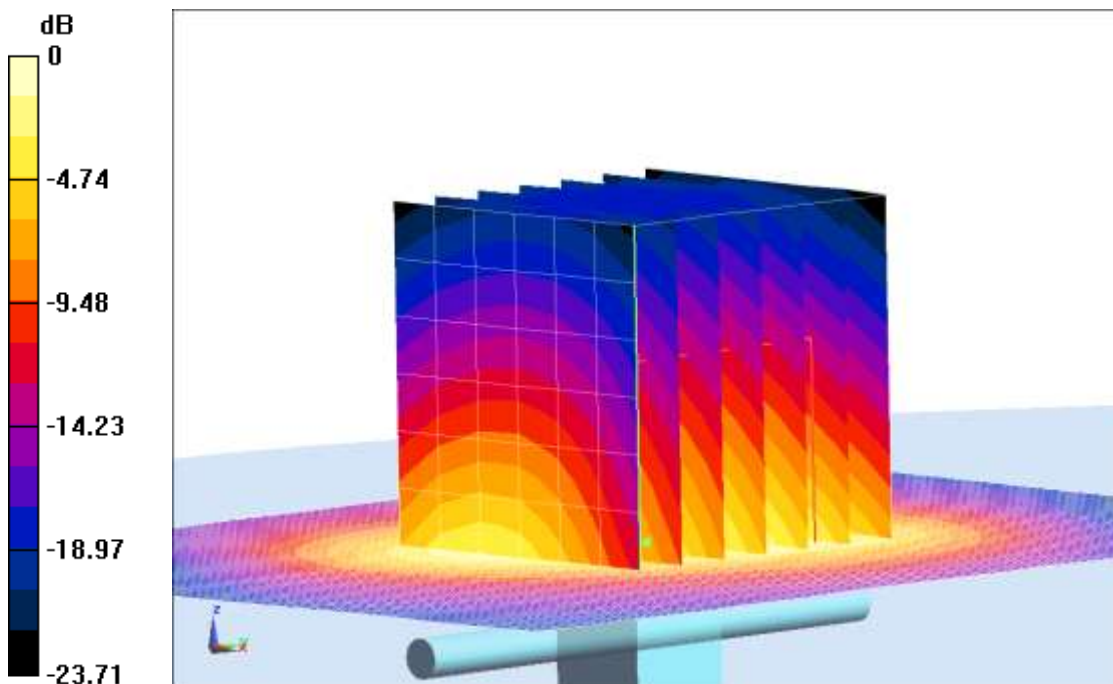

0 dB = 16.6 W/kg = 12.20 dB W/kg

Fig.B.7. Validation 2550MHz 250mW

5250MHz

Date: 2020-5-6

Electronics: DAE4 Sn1527

Medium: Head 5300MHz

Medium parameters used: $f = 5250 \text{ MHz}$; $\sigma = 4.661 \text{ S/m}$; $\epsilon_r = 36.485$; $\rho = 1000 \text{ kg/m}^3$

Ambient Temperature: 23.0°C Liquid Temperature: 22.5°C

Communication System: CW Frequency: 5250 MHz Duty Cycle: 1:1

Probe: EX3DV4 – SN3633 ConvF (5.47, 5.47, 5.47);

System Validation /Area Scan (91x91x1): Interpolated grid: $dx=1.000 \text{ mm}$, $dy=1.000 \text{ mm}$

Reference Value = 60.454 V/m ; Power Drift = -0.13 dB

SAR(1 g) = 7.81 W/kg; SAR(10 g) = 2.23 W/kg

Maximum value of SAR (interpolated) = 9.37 W/kg

System Validation/Zoom Scan (8x8x8)/Cube0: Measurement grid: $dx=4\text{mm}$, $dy=4\text{mm}$, $dz=4\text{mm}$

Reference Value = 60.454 V/m ; Power Drift = -0.13 dB

Peak SAR (extrapolated) = 22.1 W/kg

SAR(1 g) = 7.62 W/kg; SAR(10 g) = 2.20 W/kg

Maximum value of SAR (measured) = 9.28 W/kg

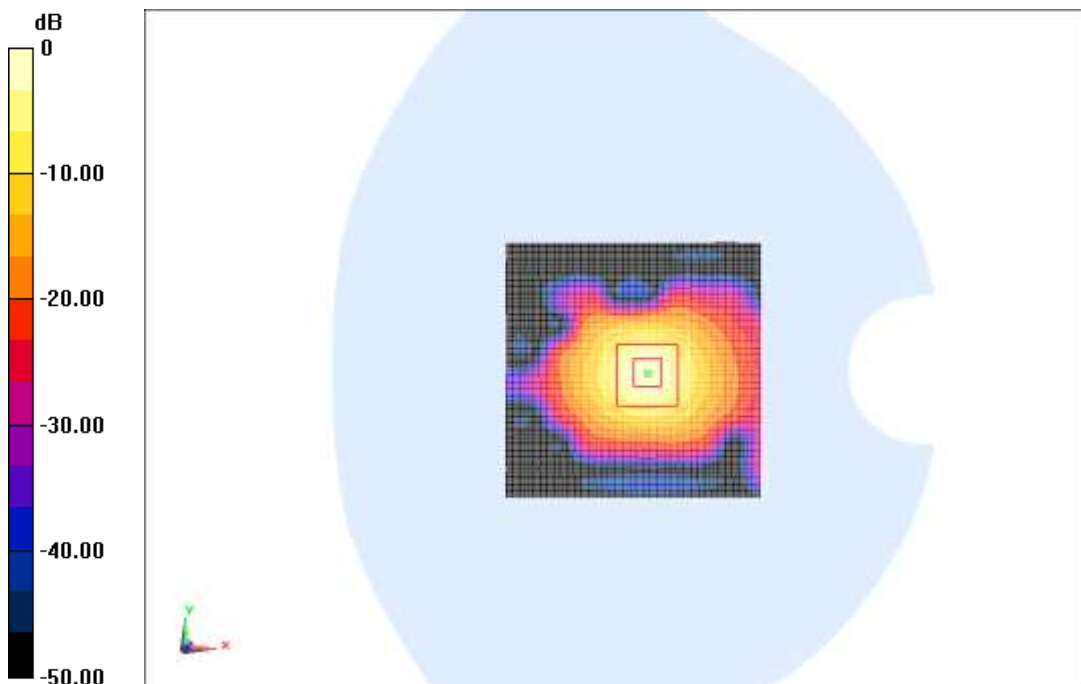

0 dB = $9.28 \text{ W/kg} = 9.68 \text{ dB W/kg}$

Fig.B.8. Validation 5250MHz 100mW

5600MHz

Date: 2020-5-6

Electronics: DAE4 Sn1527

Medium: Head 5600MHz

Medium parameters used: $f = 5600$ MHz; $\sigma = 5.134$ S/m; $\epsilon_r = 34.55$; $\rho = 1000$ kg/m³

Ambient Temperature: 23.0°C Liquid Temperature: 22.5°C

Communication System: CW Frequency: 5600 MHz Duty Cycle: 1:1

Probe: EX3DV4 – SN3633 ConvF (4.72, 4.72, 4.72);

System Validation/Area Scan (91x91x1): Interpolated grid: dx=1.000 mm, dy=1.000 mm

Reference Value = 64.893 V/m; Power Drift = 0.10 dB

SAR(1 g) = 8.15 W/kg; SAR(10 g) = 2.29 W/kg

Maximum value of SAR (interpolated) = 10.3 W/kg

System Validation/Zoom Scan (8x8x8)/Cube0: Measurement grid: dx=4mm, dy=4mm, dz=4mm

Reference Value = 64.893 V/m; Power Drift = 0.10 dB

Peak SAR (extrapolated) = 26.8 W/kg

SAR(1 g) = 8.26 W/kg; SAR(10 g) = 2.32 W/kg

Maximum value of SAR (measured) = 10.6 W/kg

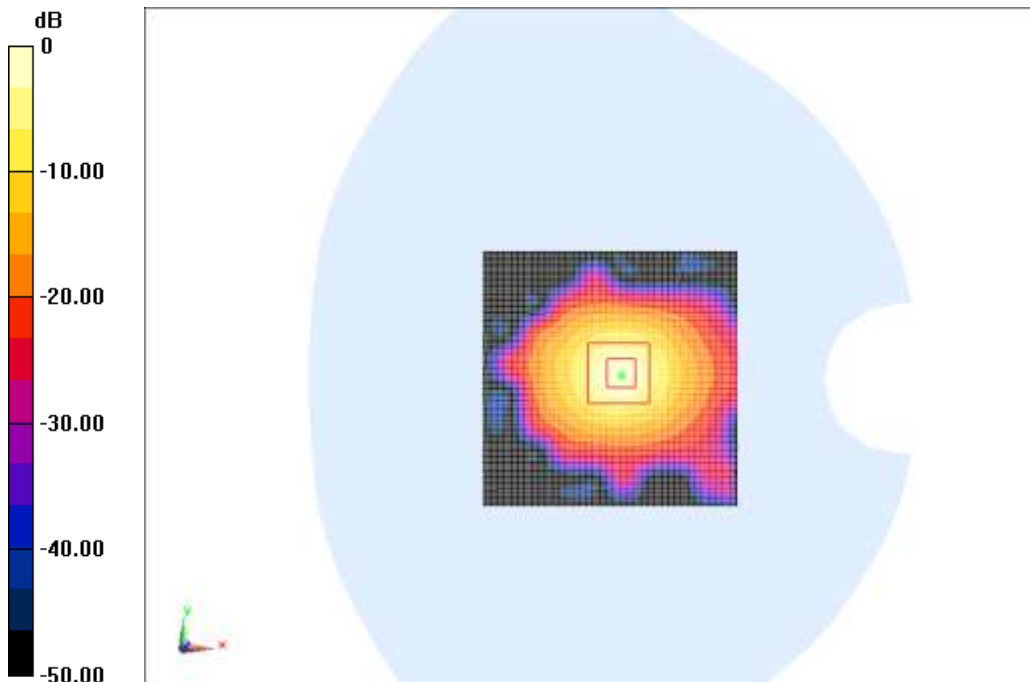

0 dB = 10.4 W/kg = 10.17 dB W/kg

Fig.B.9. Validation 5600MHz 100mW

5750MHz

Date: 2020-5-6

Electronics: DAE4 Sn1527

Medium: Head 5800 MHz

Medium parameters used: $f = 5750 \text{ MHz}$; $\sigma = 5.157 \text{ S/m}$; $\epsilon_r = 36.417$; $\rho = 1000 \text{ kg/m}^3$

Ambient Temperature: 23.0°C Liquid Temperature: 22.5°C

Communication System: CW Frequency: 5750 MHz Duty Cycle: 1:1

Probe: EX3DV4 – SN3633 ConvF (4.73, 4.73, 4.73);

System Validation/Area Scan (91x91x1): Interpolated grid: $dx=1.000 \text{ mm}$, $dy=1.000 \text{ mm}$

Reference Value = 59.758 V/m ; Power Drift = -0.05 dB

SAR(1 g) = 7.62 W/kg; SAR(10 g) = 2.20 W/kg

Maximum value of SAR (interpolated) = 9.24 W/kg

System Validation/Zoom Scan (8x8x8)/Cube0: Measurement grid: $dx=4\text{mm}$, $dy=4\text{mm}$, $dz=4\text{mm}$

Reference Value = 59.758 V/m ; Power Drift = -0.05 dB

Peak SAR (extrapolated) = 20.7 W/kg

SAR(1 g) = 7.46 W/kg; SAR(10 g) = 2.16 W/kg

Maximum value of SAR (measured) = 9.19 W/kg

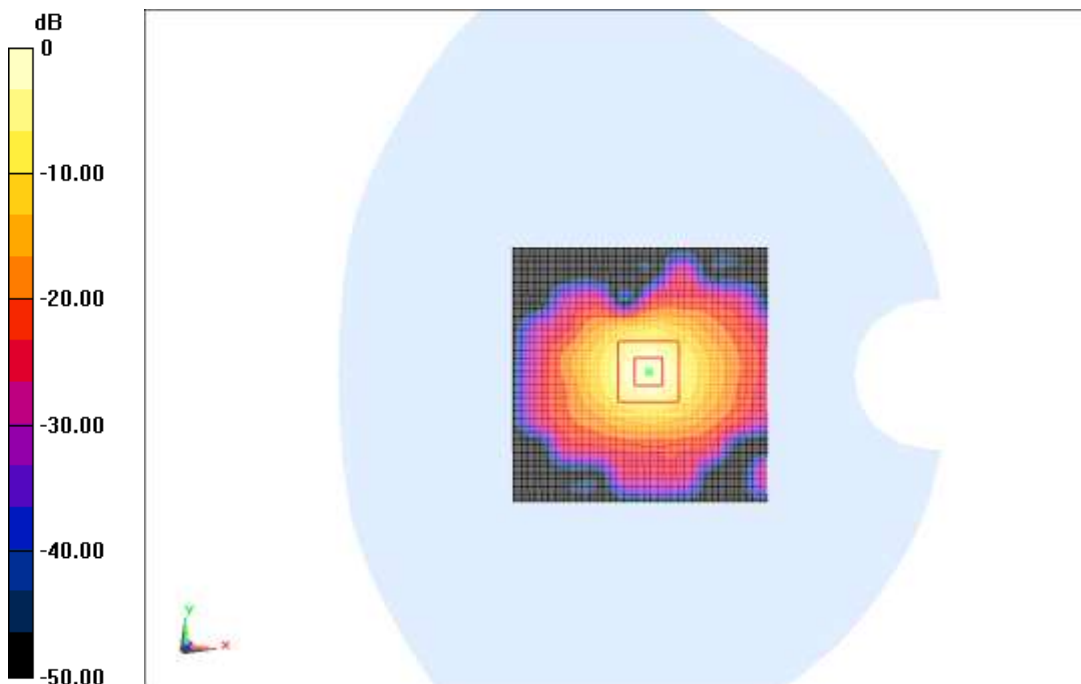

0 dB = 9.19 W/kg = 9.63 dB W/kg

Fig.B.10. Validation 5750MHz 100mW

ANNEX C: SAR Measurement Setup

C.1. Measurement Set-up

DASY5 system for performing compliance tests is illustrated above graphically. This system consists of the following items:

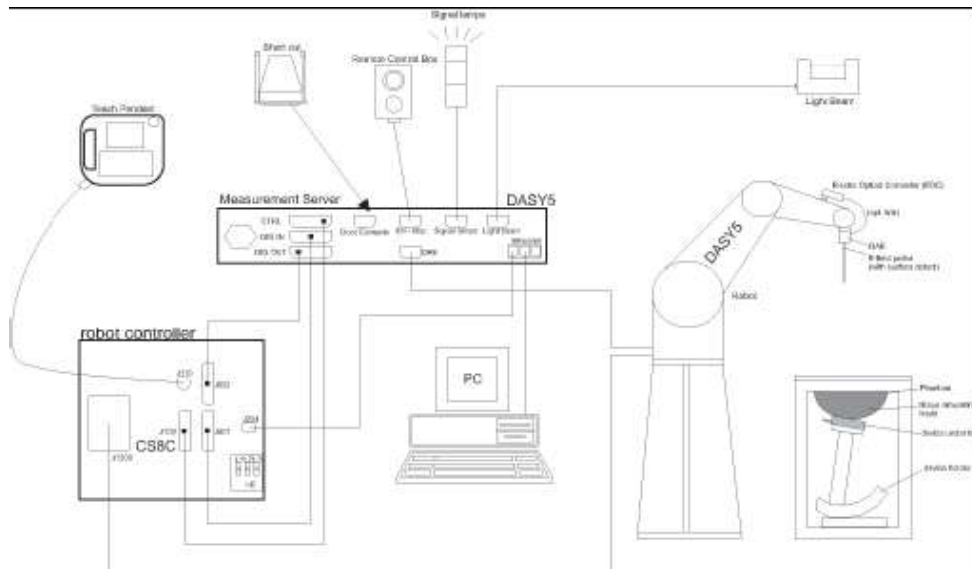

Picture C.1 SAR Lab Test Measurement Set-up

- A standard high precision 6-axis robot (Stäubli TX=RX family) with controller, teach pendant and software. An arm extension for accommodating the data acquisition electronics (DAE).
- An isotropic field probe optimized and calibrated for the targeted measurement.
- A data acquisition electronics (DAE) which performs the signal amplification, signal multiplexing, AD-conversion, offset measurements, mechanical surface detection, collision detection, etc. The unit is battery powered with standard or rechargeable batteries. The signal is optically transmitted to the EOC.
- The Electro-optical converter (EOC) performs the conversion from optical to electrical signals for the digital communication to the DAE. To use optical surface detection, a special version of the EOC is required. The EOC signal is transmitted to the measurement server.
- The function of the measurement server is to perform the time critical tasks such as signal filtering, control of the robot operation and fast movement interrupts.
- The Light Beam used is for probe alignment. This improves the (absolute) accuracy of the probe positioning.
- A computer running WinXP and the DASY5 software.
- Remote control and teach pendant as well as additional circuitry for robot safety such as
- warning lamps, etc.
- The phantom, the device holder and other accessories according to the targeted measurement.

C.2. DASY5 E-field Probe System

The SAR measurements were conducted with the dosimetric probe designed in the classical triangular configuration and optimized for dosimetric evaluation. The probe is constructed using the thick film technique; with printed resistive lines on ceramic substrates. The probe is equipped with an optical multifiber line ending at the front of the probe tip. It is connected to the EOC box on the robot arm and provides an automatic detection of the phantom surface. Half of the fibers are connected to a pulsed infrared transmitter, the other half to a synchronized receiver. As the probe approaches the surface, the reflection from the surface produces a coupling from the transmitting to the receiving fibers. This reflection increases first during the approach, reaches maximum and then decreases. If the probe is flatly touching the surface, the coupling is zero. The distance of the coupling maximum to the surface is independent of the surface reflectivity and largely independent of the surface to probe angle. The DASY5 software reads the reflection during a software approach and looks for the maximum using 2nd order curve fitting. The approach is stopped at reaching the maximum.

Probe Specifications:

Model:	ES3DV3, EX3DV4
Frequency	10MHz — 6.0GHz(EX3DV4)
Range:	10MHz — 4GHz(ES3DV3)
Calibration:	In head and body simulating tissue at Frequencies from 835 up to 5800MHz
Linearity:	± 0.2 dB(30 MHz to 6 GHz) for EX3DV4 ± 0.2 dB(30 MHz to 4 GHz) for ES3DV3
Dynamic Range:	10 mW/kg — 100W/kg
Probe Length:	330 mm
Probe Tip	
Length:	20 mm
Body Diameter:	12 mm
Tip Diameter:	2.5 mm (3.9 mm for ES3DV3)
Tip-Center:	1 mm (2.0mm for ES3DV3)
Application:	SAR Dosimetry Testing Compliance tests of mobile phones Dosimetry in strong gradient fields



Picture C.2 Near-field Probe



Picture C.3 E-field Probe

C.3. E-field Probe Calibration

Each E-Probe/Probe Amplifier combination has unique calibration parameters. A TEM cell calibration procedure is conducted to determine the proper amplifier settings to enter in the probe parameters. The amplifier settings are determined for a given frequency by subjecting the probe to a known E-field density (1 mW/cm²) using an RF Signal generator, TEM cell, and RF Power Meter.

The free space E-field from amplified probe outputs is determined in a test chamber. This calibration can be performed in a TEM cell if the frequency is below 1 GHz and in a waveguide or other methodologies above 1 GHz for free space. For the free space calibration, the probe is placed in the volumetric center of the cavity and at the proper orientation with the field. The probe is then rotated 360 degrees until the three channels show the maximum reading. The power density readings equates to 1 mW/ cm².

E-field temperature correlation calibration is performed in a flat phantom filled with the appropriate simulated brain tissue. The E-field in the medium correlates with the temperature rise in the dielectric medium. For temperature correlation calibration a RF transparent thermistor-based temperature probe is used in conjunction with the E-field probe.

$$SAR = C \frac{\Delta T}{\Delta t}$$

Where:

Δt = Exposure time (30 seconds),

C = Heat capacity of tissue (brain or muscle),

ΔT = Temperature increase due to RF exposure.

$$SAR = \frac{|E|^2 \cdot \sigma}{\rho}$$

Where:

σ = Simulated tissue conductivity,

ρ = Tissue density (kg/m³).

C.4. Other Test Equipment

C.4.1. Data Acquisition Electronics (DAE)

The data acquisition electronics consist of a highly sensitive electrometer-grade preamplifier with auto-zeroing, a channel and gain-switching multiplexer, a fast 16 bit AD-converter and a command decoder with a control logic unit. Transmission to the measurement server is accomplished through an optical downlink for data and status information, as well as an optical uplink for commands and the clock.

The mechanical probe mounting device includes two different sensor systems for frontal and sideways probe contacts. They are used for mechanical surface detection and probe collision detection.

The input impedance of the DAE is 200 MOhm; the inputs are symmetrical and floating. Common mode rejection is above 80 dB.



PictureC.4: DAE

C.4.2. Robot

The SPEAG DASY system uses the high precision robots (DASY5: RX160L) type from Stäubli SA (France). For the 6-axis controller system, the robot controller version from Stäubli is used. The Stäubli robot series have many features that are important for our application:

- High precision (repeatability 0.02mm)
- High reliability (industrial design)
- Low maintenance costs (virtually maintenance free due to direct drive gears; no belt drives)
- Jerk-free straight movements (brushless synchron motors; no stepper motors)
- Low ELF interference (motor control fields shielded via the closed metallic construction shields)



Picture C.5 DASY 5

C.4.3. Measurement Server

The Measurement server is based on a PC/104 CPU board with CPU (DASY5: 400 MHz, Intel Celeron), chipdisk (DASY5:128MB), RAM (DASY5:128MB). The necessary circuits for communication with the DAE electronic box, as well as the 16 bit AD converter system for optical detection and digital I/O interface are contained on the DASY I/O board, which is directly connected to the PC/104 bus of the CPU board.

The measurement server performs all real-time data evaluation of field measurements and surface detection, controls robot movements and handles safety operation. The PC operating system cannot interfere with these time critical processes. All connections are supervised by a watchdog, and disconnection of any of the cables to the measurement server will automatically disarm the robot and disable all program-controlled robot movements. Furthermore, the measurement server is equipped with an expansion port which is reserved for future applications. Please note that this expansion port does not have a standardized pinout, and therefore only devices provided by SPEAG can be connected. Devices from any other supplier could seriously damage the measurement server.



Picture C.6 Server for DASY 5

C.4.4. Device Holder for Phantom

The SAR in the phantom is approximately inversely proportional to the square of the distance between the source and the liquid surface. For a source at 5mm distance, a positioning uncertainty of $\pm 0.5\text{mm}$ would produce a SAR uncertainty of $\pm 20\%$. Accurate device positioning is therefore crucial for accurate and repeatable measurements. The positions in which the devices must be measured are defined by the standards.

The DASY device holder is designed to cope with the different positions given in the standard. It has two scales for device rotation (with respect to the body axis) and device inclination (with respect to the line between the ear reference points). The rotation centers for both scales is the ear reference point (ERP). Thus the device needs no repositioning when changing the angles.

The DASY device holder is constructed of low-loss POM material having the following dielectric

parameters: relative permittivity $\epsilon = 3$ and loss tangent $\delta = 0.02$. The amount of dielectric material has been reduced in the closest vicinity of the device, since measurements have suggested that the influence of the clamp on the test results could thus be lowered.

<Laptop Extension Kit>

The extension is lightweight and made of POM, acrylic glass and foam. It fits easily on the upper part of the Mounting Device in place of the phone positioner. The extension is fully compatible with the Twin-SAM and ELI phantoms.



Picture C.7-1: Device Holder



Picture C.7-2: Laptop Extension Kit

C.4.5. Phantom

The SAM Twin Phantom V4.0 is constructed of a fiberglass shell integrated in a table. The shape of the shell is based on data from an anatomical study designed to represent the 90th percentile of the population. The phantom enables the dissymmetric evaluation of SAR for both left and right handed handset usage, as well as body-worn usage using the flat phantom region. Reference markings on the Phantom allow the complete setup of all predefined phantom positions and measurement grids by manually teaching three points in the robot. The shell phantom has a 2mm shell thickness (except the ear region where shell thickness increases to 6 mm).

Shell Thickness: 2 ± 0.2 mm

Filling Volume: Approx. 25 liters

Dimensions: 810 x 1000 x 500 mm (H x L x W)

Available: Special



Picture C.8: SAM Twin Phantom

ANNEX D: Position of the wireless device in relation to the phantom

D.1. General considerations

This standard specifies two handset test positions against the head phantom – the “cheek” position and the “tilt” position.

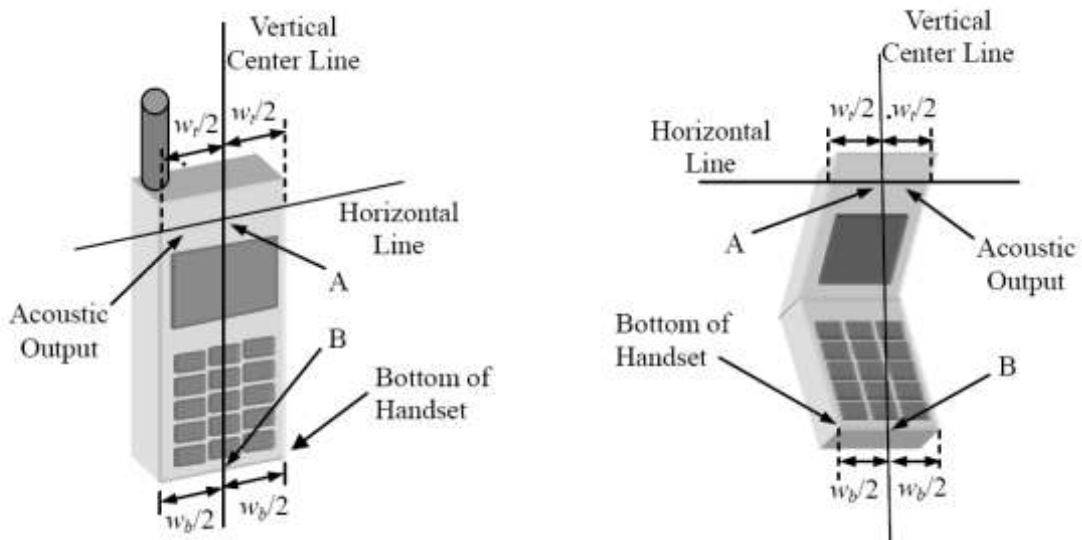

- w_t Width of the handset at the level of the acoustic
- w_b Width of the bottom of the handset
- A Midpoint of the width w_t of the handset at the level of the acoustic output
- B Midpoint of the width w_b of the bottom of the handset

Picture D.1-a Typical “fixed” case handset Picture D.1-b Typical “clam-shell” case handset

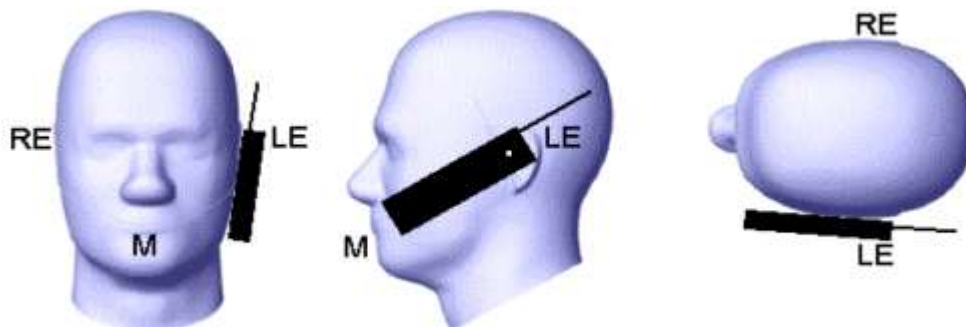

Picture D.2 Cheek position of the wireless device on the left side of SAM

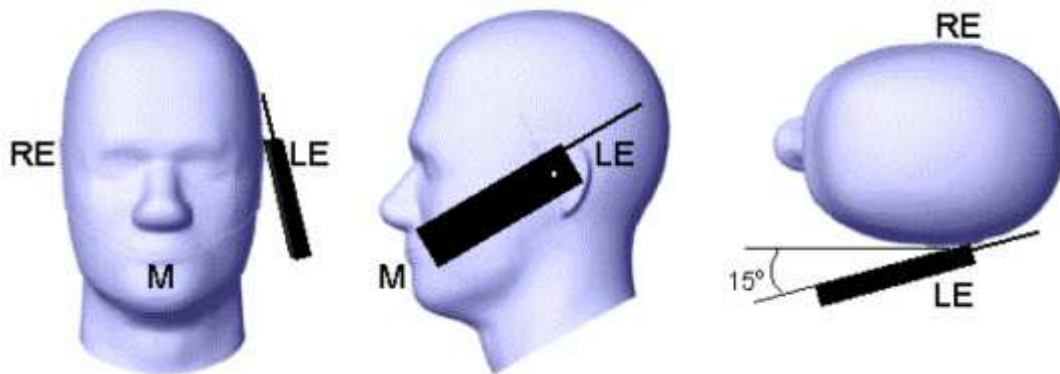

Picture D.3 Tilt position of the wireless device on the left side of SAM

D.2. Body-worn device

A typical example of a body-worn device is a mobile phone, wireless enabled PDA or other battery operated wireless device with the ability to transmit while mounted on a person's body using a carry accessory approved by the wireless device manufacturer.

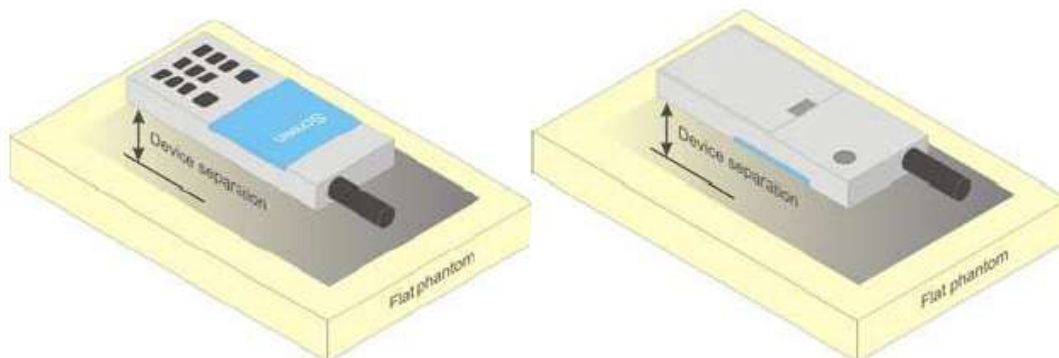

Picture D.4 Test positions for body-worn devices

D.3. Desktop device

A typical example of a desktop device is a wireless enabled desktop computer placed on a table or desk when used.

The DUT shall be positioned at the distance and in the orientation to the phantom that corresponds to the intended use as specified by the manufacturer in the user instructions. For devices that employ an external antenna with variable positions, tests shall be performed for all antenna positions specified. Picture 8.5 show positions for desktop device SAR tests. If the intended use is not specified, the device shall be tested directly against the flat phantom.

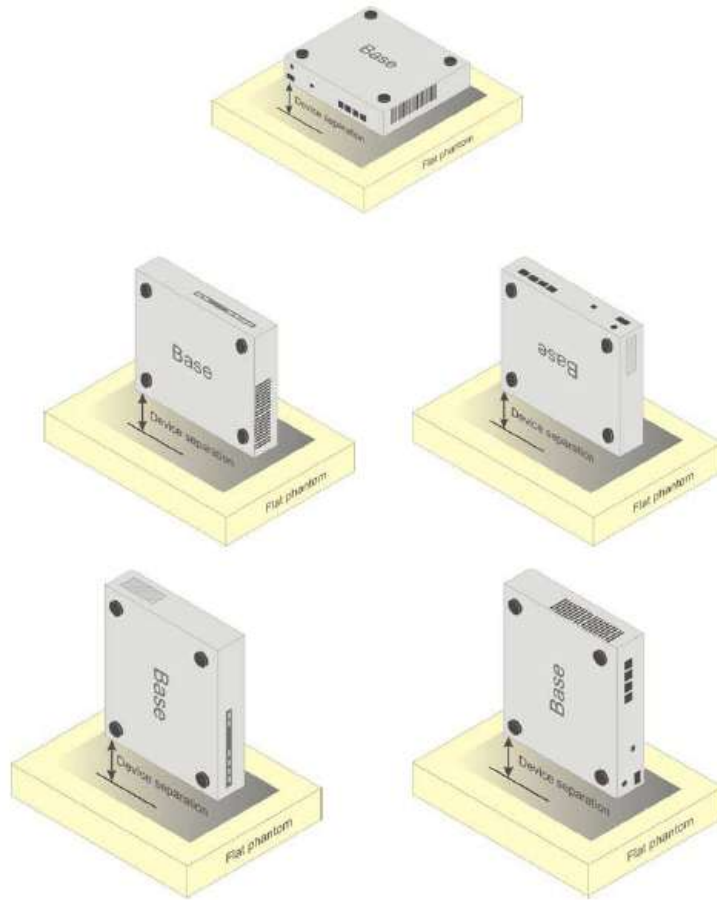

Picture D.5 Test positions for desktop devices

D.4. DUT Setup Photos



Picture D.6

ANNEX E: Equivalent Media Recipes

The liquid used for the frequency range of 700-6000 MHz consisted of water, sugar, salt, preventol, glycol monobutyl and Cellulose. The liquid has been previously proven to be suited for worst-case. The Table E.1 shows the detail solution. It's satisfying the latest tissue dielectric parameters requirements proposed by the IEEE 1528 and IEC 62209.

Table E.1: Composition of the Tissue Equivalent Matter

Frequency (MHz)	835 Head	835 Body	1900 Head	1900 Body	2450 Head	2450 Body	5800 Head	5800 Body
Ingredients (% by weight)								
Water	41.45	52.5	55.242	69.91	58.79	72.60	65.53	65.53
Sugar	56.0	45.0	\	\	\	\	\	\
Salt	1.45	1.4	0.306	0.13	0.06	0.18	\	\
Preventol	0.1	0.1	\	\	\	\	\	\
Cellulose	1.0	1.0	\	\	\	\	\	\
Glycol Monobutyl	\	\	44.452	29.96	41.15	27.22	\	\
Diethylenglycol monohexylether	\	\	\	\	\	\	17.24	17.24
Triton X-100	\	\	\	\	\	\	17.24	17.24
Dielectric Parameters Target Value	$\epsilon=41.5$ $\sigma=0.90$	$\epsilon=55.2$ $\sigma=0.97$	$\epsilon=40.0$ $\sigma=1.40$	$\epsilon=53.3$ $\sigma=1.52$	$\epsilon=39.2$ $\sigma=1.80$	$\epsilon=52.7$ $\sigma=1.95$	$\epsilon=35.3$ $\sigma=5.27$	$\epsilon=48.2$ $\sigma=6.00$

Note: There is a little adjustment respectively for 750, 1800, 2600, 5200, 5300, and 5600, based on the recipe of closest frequency in table E.1



ANNEX F: System Validation

The SAR system must be validated against its performance specifications before it is deployed. When SAR probes, system components or software are changed, upgraded or recalibrated, these must be validated with the SAR system(s) that operates with such components.

Table F.1: System Validation

Probe SN.	Liquid name	Validation date	Frequency point	Status (OK or Not)
3633	Head 750MHz	2020-04-03	750 MHz	OK
3633	Head 900MHz	2020-04-03	900 MHz	OK
3633	Head 1750MHz	2020-04-03	1750 MHz	OK
3633	Head 1900MHz	2020-04-03	1900 MHz	OK
3633	Head 2300MHz	2020-04-04	2300 MHz	OK
3633	Head 2450MHz	2020-04-04	2450 MHz	OK
3633	Head 2550MHz	2020-04-04	2550 MHz	OK
3633	Head 5200MHz	2020-04-05	5250 MHz	OK
3633	Head 5600MHz	2020-04-05	5600 MHz	OK
3633	Head 5750MHz	2020-04-05	5750 MHz	OK



No. B20N00421-SAR

ANNEX G: DAE Calibration Certificate

DAE4 SN: 1527 Calibration Certificate



In Collaboration with
s p e a g
CALIBRATION LABORATORY

Addr: No 51 Xueyuan Road, Haidian District, Beijing, 100191, China
Tel: +86-10-62304633-2512 Fax: +86-10-62304633-2504
E-mail: cttl@chinattl.com <http://www.chinattl.cn>



中国认可
国际互认
校准
CALIBRATION
CNAS L0570

Client : **CTTL(South Branch)**

Certificate No: **Z19-60419**

CALIBRATION CERTIFICATE			
Object	DAE4 - SN: 1527		
Calibration Procedure(s)	FF-Z11-002-01 Calibration Procedure for the Data Acquisition Electronics (DAEx)		
Calibration date:	November 11, 2019		
This calibration Certificate documents the traceability to national standards, which realize the physical units of measurements(SI). The measurements and the uncertainties with confidence probability are given on the following pages and are part of the certificate.			
All calibrations have been conducted in the closed laboratory facility: environment temperature(22±3)°C and humidity<70%.			
Calibration Equipment used (M&TE critical for calibration)			
Primary Standards	ID #	Cal Date(Calibrated by, Certificate No.)	Scheduled Calibration
Process Calibrator 753	1971018	24-Jun-19 (CTTL, No.J19X05126)	Jun-20
Calibrated by:	Name	Function	Signature
	Yu Zongying	SAR Test Engineer	
Reviewed by:	Lin Hao	SAR Test Engineer	
Approved by:	Qi Dianyuan	SAR Project Leader	
			Issued: November 13, 2019
This calibration certificate shall not be reproduced except in full without written approval of the laboratory.			

Certificate No: Z19-60419

Page 1 of 3



Add: No.51 Xueyuan Road, Haidian District, Beijing, 100191, China
Tel: +86-10-62304633-2512 Fax: +86-10-62304633-2504
E-mail: entl@chinattl.com [Http://www.chinattl.cn](http://www.chinattl.cn)

Glossary:

DAE data acquisition electronics
Connector angle information used in DASY system to align probe sensor X to the robot coordinate system.

Methods Applied and Interpretation of Parameters:

- *DC Voltage Measurement:* Calibration Factor assessed for use in DASY system by comparison with a calibrated instrument traceable to national standards. The figure given corresponds to the full scale range of the voltmeter in the respective range.
- *Connector angle:* The angle of the connector is assessed measuring the angle mechanically by a tool inserted. Uncertainty is not required.
- The report provide only calibration results for DAE, it does not contain other performance test results.



Add: No.51 Xueyun Road, Haidian District, Beijing, 100191, China
Tel: +86-10-62304633-2512 Fax: +86-10-62304633-2504
E-mail: ttl@chinattl.com Http://www.chinattl.cn

DC Voltage Measurement

A/D - Converter Resolution nominal
High Range: 1LSB = 6.1μV, full range = -100...+300 mV
Low Range: 1LSB = 61nV, full range = -1.....+3mV
DASY measurement parameters: Auto Zero Time: 3 sec; Measuring time: 3 sec

Calibration Factors	X	Y	Z
High Range	403.867 ± 0.15% (k=2)	403.590 ± 0.15% (k=2)	403.811 ± 0.15% (k=2)
Low Range	3.96119 ± 0.7% (k=2)	3.99117 ± 0.7% (k=2)	3.97030 ± 0.7% (k=2)

Connector Angle

Connector Angle to be used in DASY system	223° ± 1°
---	-----------





ANNEX H: Probe Calibration Certificate

Probe EX3DV4-SN: 3633 Calibration Certificate



In Collaboration with
SPEAG
CALIBRATION LABORATORY

Add: No.51 Xueyuan Road, Haidian District, Beijing, 100191, China
Tel: +86-10-62304633-2512 Fax: +86-10-62304633-2504
E-mail: cntl@chinattl.com <http://www.chinattl.cn>

中国认可
国际互认
校准
CALIBRATION
CNAS L0570

Client: **CTTL(South Branch)** Certificate No: **Z20-60108**

CALIBRATION CERTIFICATE

Object: **EX3DV4 - SN : 3633**

Calibration Procedure(s): **FF-Z11-004-01
Calibration Procedures for Dosimetric E-field Probes**

Calibration date: **April 01, 2020**



This calibration Certificate documents the traceability to national standards, which realize the physical units of measurements(SI). The measurements and the uncertainties with confidence probability are given on the following pages and are part of the certificate.

All calibrations have been conducted in the closed laboratory facility: environment temperature(22±3)℃ and humidity<70%.

Calibration Equipment used (M&TE critical for calibration)

Primary Standards	ID #	Cal Date(Calibrated by, Certificate No.)	Scheduled Calibration
Power Meter NRP2	101919	18-Jun-19(CTTL, No.J19X05125)	Jun-20
Power sensor NRP-Z91	101547	18-Jun-19(CTTL, No.J19X05125)	Jun-20
Power sensor NRP-Z91	101548	18-Jun-19(CTTL, No.J19X05125)	Jun-20
Reference 10dBAttenuator	18N50W-10dB	10-Feb-20(CTTL, No.J20X00525)	Feb-22
Reference 20dBAttenuator	18N50W-20dB	10-Feb-20(CTTL, No.J20X00526)	Feb-22
Reference Probe EX3DV4	SN 7307	24-May-19(SPEAG, No.EX3-7307_May19/2)	May-20
DAE4	SN 1525	26-Aug-19(SPEAG, No.DAE4-1525_Aug19)	Aug-20

Secondary Standards	ID #	Cal Date(Calibrated by, Certificate No.)	Scheduled Calibration
SignalGenerator MG3700A	6201052605	18-Jun-19(CTTL, No.J19X05127)	Jun-20
Network Analyzer E5071C	MY46110673	10-Feb-20(CTTL, No.J20X00515)	Feb-21

	Name	Function	Signature
Calibrated by:	Yu Zongying	SAR Test Engineer	
Reviewed by:	Lin Hao	SAR Test Engineer	
Approved by:	Qi Dianyuan	SAR Project Leader	

Issued: April 03, 2020

This calibration certificate shall not be reproduced except in full without written approval of the laboratory.

Certificate No: Z20-60108
Page 1 of 10



Add: No.51 Xueyuan Road, Haidian District, Beijing, 100191, China
 Tel: +86-10-62304633-2512 Fax: +86-10-62304633-2504
 E-mail: cti@chinantl.com <http://www.chinantl.cn>

Glossary:

TSL	tissue simulating liquid
NORM _{x,y,z}	sensitivity in free space
ConvF	sensitivity in TSL / NORM _{x,y,z}
DCP	diode compression point
CF	crest factor (1/duty_cycle) of the RF signal
A,B,C,D	modulation dependent linearization parameters
Polarization Φ	Φ rotation around probe axis
Polarization θ	θ rotation around an axis that is in the plane normal to probe axis (at measurement center), $\theta=0$ is normal to probe axis

Connector Angle information used in DASY system to align probe sensor X to the robot coordinate system

Calibration is Performed According to the Following Standards:

- IEEE Std 1528-2013, "IEEE Recommended Practice for Determining the Peak Spatial-Averaged Specific Absorption Rate (SAR) in the Human Head from Wireless Communications Devices: Measurement Techniques", June 2013
- IEC 62209-1, "Measurement procedure for the assessment of Specific Absorption Rate (SAR) from hand-held and body-mounted devices used next to the ear (frequency range of 300 MHz to 6 GHz)", July 2016
- IEC 62209-2, "Procedure to determine the Specific Absorption Rate (SAR) for wireless communication devices used in close proximity to the human body (frequency range of 30 MHz to 6 GHz)", March 2010
- KDB 865664, "SAR Measurement Requirements for 100 MHz to 6 GHz"

Methods Applied and Interpretation of Parameters:

- NORM_{x,y,z}:** Assessed for E-field polarization $\theta=0$ ($f \leq 900\text{MHz}$ in TEM-cell; $f > 1800\text{MHz}$; waveguide). NORM_{x,y,z} are only intermediate values, i.e., the uncertainties of NORM_{x,y,z} does not effect the E^2 -field uncertainty inside TSL (see below ConvF).
- NORM(f)_{x,y,z} = NORM_{x,y,z} * frequency_response** (see Frequency Response Chart). This linearization is implemented in DASY4 software versions later than 4.2. The uncertainty of the frequency response is included in the stated uncertainty of ConvF.
- DCP_{x,y,z}:** DCP are numerical linearization parameters assessed based on the data of power sweep (no uncertainty required). DCP does not depend on frequency nor media.
- PAR:** PAR is the Peak to Average Ratio that is not calibrated but determined based on the signal characteristics.
- A_{x,y,z}; B_{x,y,z}; C_{x,y,z}; VR_{x,y,z}; A,B,C** are numerical linearization parameters assessed based on the data of power sweep for specific modulation signal. The parameters do not depend on frequency nor media. VR is the maximum calibration range expressed in RMS voltage across the diode.
- ConvF and Boundary Effect Parameters:** Assessed in flat phantom using E-field (or Temperature Transfer Standard for $f \leq 800\text{MHz}$) and inside waveguide using analytical field distributions based on power measurements for $f > 800\text{MHz}$. The same setups are used for assessment of the parameters applied for boundary compensation (alpha, depth) of which typical uncertainty valued are given. These parameters are used in DASY4 software to improve probe accuracy close to the boundary. The sensitivity in TSL corresponds to NORM_{x,y,z} * ConvF whereby the uncertainty corresponds to that given for ConvF. A frequency dependent ConvF is used in DASY version 4.4 and higher which allows extending the validity from $\pm 50\text{MHz}$ to $\pm 100\text{MHz}$.
- Spherical isotropy (3D deviation from isotropy):** in a field of low gradients realized using a flat phantom exposed by a patch antenna.
- Sensor Offset:** The sensor offset corresponds to the offset of virtual measurement center from the probe tip (on probe axis). No tolerance required.
- Connector Angle:** The angle is assessed using the information gained by determining the NORM_x (no uncertainty required).



Add: No.51 Xueyuan Road, Haidian District, Beijing, 100191, China.
 Tel: +86-10-62304633-2512 Fax: +86-10-62304633-2504
 E-mail: cti@chinattl.com <http://www.chinattl.cn>

DASY/EASY – Parameters of Probe: EX3DV4 – SN:3633

Basic Calibration Parameters

	Sensor X	Sensor Y	Sensor Z	Unc (k=2)
Norm($\mu\text{V}/(\text{V}/\text{m})^2$) [^]	0.37	0.37	0.39	±10.0%
DCP(mV) [^]	98.2	98.8	98.0	

Modulation Calibration Parameters

UID	Communication System Name		A dB	B dB· μV	C	D dB	VR mV	Unc ^E (k=2)
0	CW	X	0.0	0.0	1.0	0.00	141.5	±2.3%
		Y	0.0	0.0	1.0		141.5	
		Z	0.0	0.0	1.0		141.9	

The reported uncertainty of measurement is stated as the standard uncertainty of Measurement multiplied by the coverage factor k=2, which for a normal distribution Corresponds to a coverage probability of approximately 95%.

[^] The uncertainties of Norm X, Y, Z do not affect the E²-field uncertainty inside TSL (see Page 4 and Page 5).
[^] Numerical linearization parameter: uncertainty not required.
^E Uncertainty is determined using the max. deviation from linear response applying rectangular distribution and is expressed for the square of the field value.



Add: No.51 Xueyuan Road, Haidian District, Beijing, 100191, China
 Tel: +86-10-62304633-2512 Fax: +86-10-62304633-2504
 E-mail: cttl@chinattl.com <http://www.chinattl.cn>

DASY/EASY – Parameters of Probe: EX3DV4 – SN: 3633

Calibration Parameter Determined in Head Tissue Simulating Media

f [MHz] ^C	Relative Permittivity ^F	Conductivity (S/m) ^F	ConvF X	ConvF Y	ConvF Z	Alpha ^G	Depth ^G (mm)	Unct. (k=2)
750	41.9	0.89	9.59	9.59	9.59	0.40	0.75	±12.1%
900	41.5	0.97	9.33	9.33	9.33	0.21	1.14	±12.1%
1640	40.3	1.29	8.17	8.17	8.17	0.16	1.22	±12.1%
1750	40.1	1.37	8.09	8.09	8.09	0.15	1.42	±12.1%
1900	40.0	1.40	7.76	7.76	7.76	0.19	1.14	±12.1%
2100	39.8	1.49	7.73	7.73	7.73	0.18	1.26	±12.1%
2300	39.5	1.67	7.69	7.69	7.69	0.48	0.78	±12.1%
2450	39.2	1.80	7.43	7.43	7.43	0.50	0.77	±12.1%
2600	39.0	1.96	7.20	7.20	7.20	0.58	0.72	±12.1%
3500	37.9	2.91	6.88	6.88	6.88	0.35	1.23	±13.3%
3700	37.7	3.12	6.57	6.57	6.57	0.44	0.98	±13.3%
3900	37.5	3.32	6.51	6.51	6.51	0.35	1.40	±13.3%
4100	37.2	3.53	6.44	6.44	6.44	0.40	1.20	±13.3%
4400	36.9	3.84	6.30	6.30	6.30	0.35	1.35	±13.3%
4600	36.7	4.04	6.10	6.10	6.10	0.45	1.40	±13.3%
4800	36.4	4.25	5.98	5.98	5.98	0.45	1.60	±13.3%
4950	36.3	4.40	5.80	5.80	5.80	0.45	1.45	±13.3%
5250	35.9	4.71	5.47	5.47	5.47	0.45	1.25	±13.3%
5600	35.5	5.07	4.72	4.72	4.72	0.45	1.50	±13.3%
5750	35.4	5.22	4.73	4.73	4.73	0.45	1.50	±13.3%

^C Frequency validity above 300 MHz of ±100MHz only applies for DASY v4.4 and higher (Page 2), else it is restricted to ±50MHz. The uncertainty is the RSS of ConvF uncertainty at calibration frequency and the uncertainty for the indicated frequency band. Frequency validity below 300 MHz is ± 10, 25, 40, 50 and 70 MHz for ConvF assessments at 30, 64, 128, 150 and 220 MHz respectively. Above 5 GHz frequency validity can be extended to ± 110 MHz.

^F At frequency below 3 GHz, the validity of tissue parameters (ϵ and σ) can be relaxed to ±10% if liquid compensation formula is applied to measured SAR values. At frequencies above 3 GHz, the validity of tissue parameters (ϵ and σ) is restricted to ±5%. The uncertainty is the RSS of the ConvF uncertainty for indicated target tissue parameters.

^G Alpha/Depth are determined during calibration. SPEAG warrants that the remaining deviation due to the boundary effect after compensation is always less than ± 1% for frequencies below 3 GHz and below ± 2% for the frequencies between 3-6 GHz at any distance larger than half the probe tip diameter from the boundary.



Add: No.51 Xueyuan Road, Haidian District, Beijing, 100191, China
 Tel: +86-10-62304633-2512 Fax: +86-10-62304633-2504
 E-mail: ttl@chinattl.com [Http://www.chinattl.cn](http://www.chinattl.cn)

DASY/EASY – Parameters of Probe: EX3DV4 – SN: 3633

Calibration Parameter Determined in Body Tissue Simulating Media

f [MHz] ^C	Relative Permittivity ^F	Conductivity (S/m) ^F	ConvF X	ConvF Y	ConvF Z	Alpha ^G	Depth ^G (mm)	Unct. (k=2)
750	55.5	0.96	9.57	9.57	9.57	0.40	0.80	±12.1%
900	55.0	1.05	9.34	9.34	9.34	0.25	1.11	±12.1%
1640	53.8	1.40	8.05	8.05	8.05	0.22	1.19	±12.1%
1750	53.4	1.49	7.85	7.85	7.85	0.16	1.35	±12.1%
1900	53.3	1.52	7.66	7.66	7.66	0.17	1.32	±12.1%
2100	53.2	1.62	7.69	7.69	7.69	0.21	1.30	±12.1%
2300	52.9	1.81	7.61	7.61	7.61	0.50	0.86	±12.1%
2450	52.7	1.95	7.56	7.56	7.56	0.50	0.83	±12.1%
2600	52.5	2.16	7.33	7.33	7.33	0.59	0.74	±12.1%
3500	52.3	3.31	6.28	6.28	6.28	0.40	1.30	±13.3%
3700	52.1	3.55	6.14	6.14	6.14	0.40	1.35	±13.3%
3900	50.8	3.78	6.13	6.13	6.13	0.40	1.45	±13.3%
4100	50.5	4.01	6.12	6.12	6.12	0.35	1.40	±13.3%
4400	50.1	4.37	5.93	5.93	5.93	0.35	1.70	±13.3%
4600	49.8	4.60	5.60	5.60	5.60	0.45	1.50	±13.3%
4800	49.6	4.83	5.42	5.42	5.42	0.45	1.60	±13.3%
4950	49.4	5.01	5.22	5.22	5.22	0.45	1.70	±13.3%
5250	48.9	5.36	5.04	5.04	5.04	0.50	1.45	±13.3%
5600	48.5	5.77	4.16	4.16	4.16	0.55	1.50	±13.3%
5750	48.3	5.94	4.26	4.26	4.26	0.55	1.60	±13.3%

^C Frequency validity above 300 MHz of ±100MHz only applies for DASY v4.4 and higher (Page 2), else it is restricted to ±50MHz. The uncertainty is the RSS of ConvF uncertainty at calibration frequency and the uncertainty for the indicated frequency band. Frequency validity below 300 MHz is ± 10, 25, 40, 50 and 70 MHz for ConvF assessments at 30, 64, 128, 150 and 220 MHz respectively. Above 5 GHz frequency validity can be extended to ± 110 MHz.

^F At frequency below 3 GHz, the validity of tissue parameters (ϵ and σ) can be relaxed to ±10% if liquid compensation formula is applied to measured SAR values. At frequencies above 3 GHz, the validity of tissue parameters (ϵ and σ) is restricted to ±5%. The uncertainty is the RSS of the ConvF uncertainty for indicated target tissue parameters.

^G Alpha/Depth are determined during calibration. SPEAG warrants that the remaining deviation due to the boundary effect after compensation is always less than ± 1% for frequencies below 3 GHz and below ± 2% for the frequencies between 3-6 GHz at any distance larger than half the probe tip diameter from the boundary.



Add: No.51 Xueyuan Road, Haidian District, Beijing, 100191, China
Tel: +86-10-62304633-2512 Fax: +86-10-62304633-2504
E-mail: ttl@chinattl.com <http://www.chinattl.cn>

Frequency Response of E-Field (TEM-Cell: if110 EXX, Waveguide: R22)

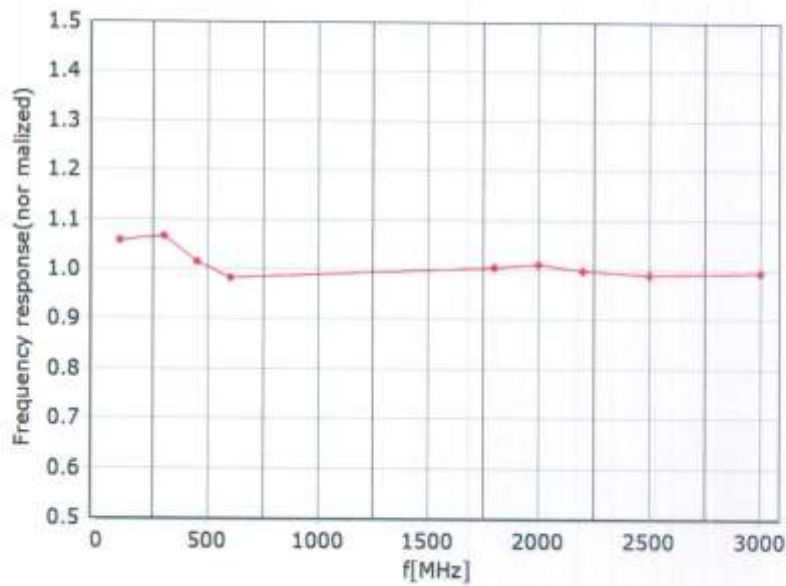

* TEM * R22

Uncertainty of Frequency Response of E-field: $\pm 7.4\%$ (k=2)



Add: No.51 Xueyuan Road, Haidian District, Beijing, 100191, China
 Tel: +86-10-62304633-2512 Fax: +86-10-62304633-2504
 E-mail: ttl@chinatti.com <http://www.chinatti.cn>

Receiving Pattern (Φ), $\theta=0^\circ$

f=600 MHz, TEM

f=1800 MHz, R22

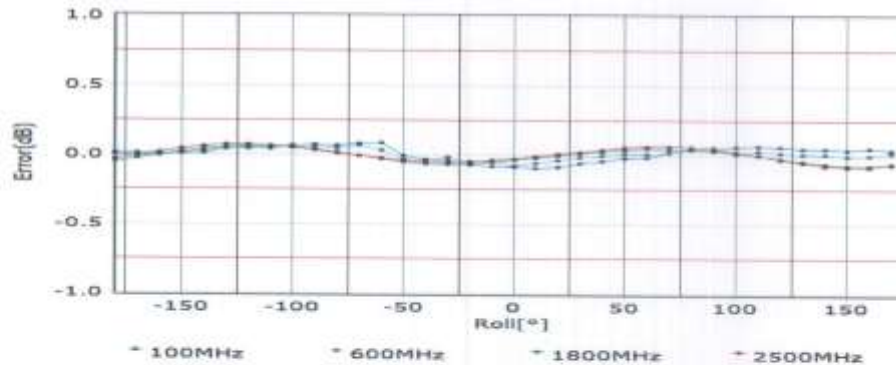
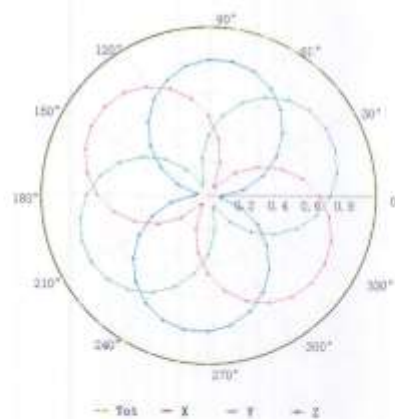
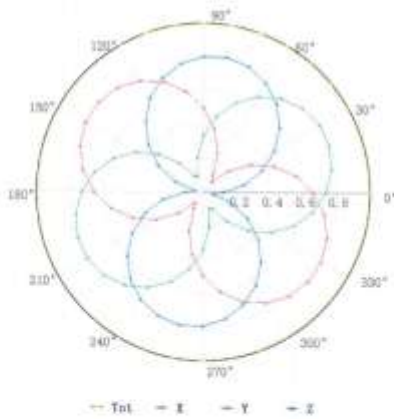

Uncertainty of Axial Isotropy Assessment: $\pm 1.2\%$ ($k=2$)



Add: No.51 Xueyun Road, Haidian District, Beijing, 100191, China
 Tel: +86-10-62304633-2512 Fax: +86-10-62304633-2504
 E-mail: cttl@chinattl.com <http://www.chinattl.cn>

Dynamic Range $f(SAR_{head})$ (TEM cell, $f = 900$ MHz)

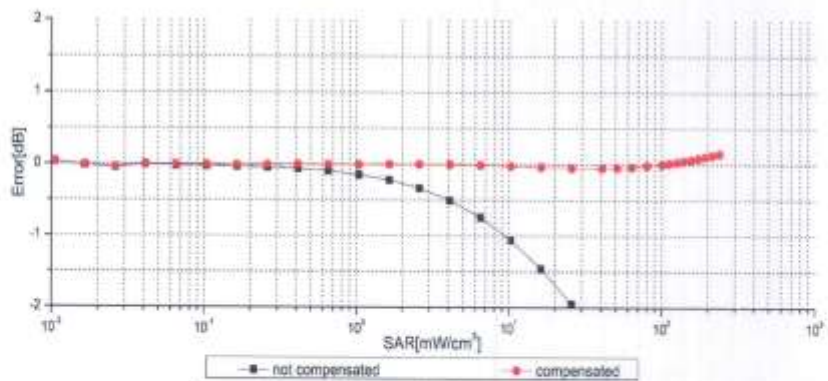
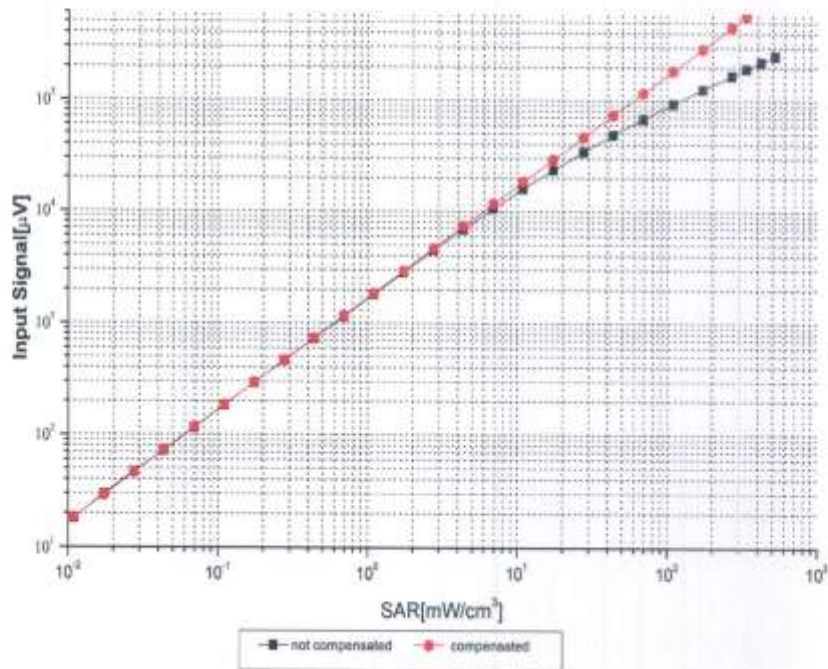

Uncertainty of Linearity Assessment: $\pm 0.9\%$ ($k=2$)



In Collaboration with
 Add: No.51 Xueyuan Road, Haidian District, Beijing, 100191, China
 Tel: +86-10-62304633-2512 Fax: +86-10-62304633-2504
 E-mail: ctd@chinattl.com [Http://www.chinattl.cn](http://www.chinattl.cn)

Conversion Factor Assessment

f=750 MHz,WGLS R9(H_convF)

f=1750 MHz,WGLS R22(H_convF)

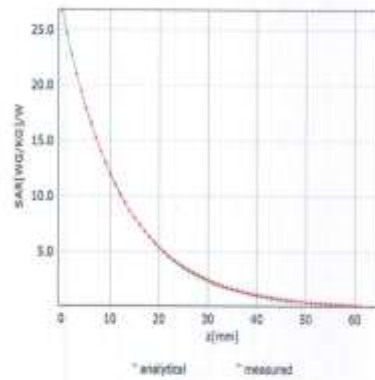
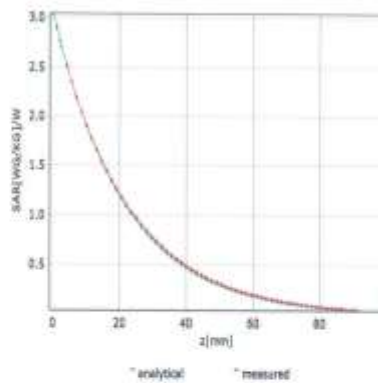

Deviation from Isotropy in Liquid

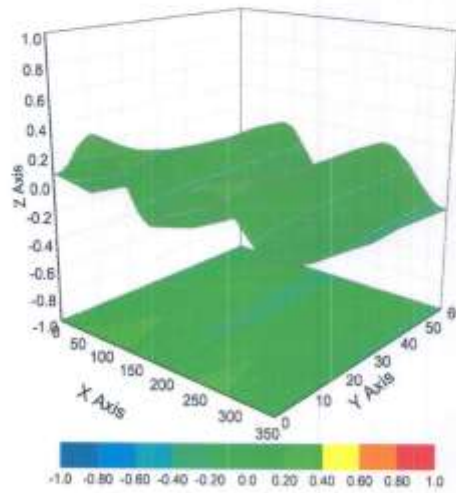

Uncertainty of Spherical Isotropy Assessment: $\pm 3.2\%$ (K=2)



Add: No.51 Xueyuan Road, Haidian District, Beijing, 100191, China
Tel: +86-10-62304633-2512 Fax: +86-10-62304633-2504
E-mail: ctdl@chinatll.com [Http://www.chinatll.cn](http://www.chinatll.cn)

DASY/EASY – Parameters of Probe: EX3DV4 – SN:3633

Other Probe Parameters

Sensor Arrangement	Triangular
Connector Angle (°)	71.2
Mechanical Surface Detection Mode	enabled
Optical Surface Detection Mode	disable
Probe Overall Length	337mm
Probe Body Diameter	10mm
Tip Length	10mm
Tip Diameter	2.5mm
Probe Tip to Sensor X Calibration Point	1mm
Probe Tip to Sensor Y Calibration Point	1mm
Probe Tip to Sensor Z Calibration Point	1mm
Recommended Measurement Distance from Surface	1.4mm



No. B20N00421-SAR

ANNEX I: Dipole Calibration Certificate

750 MHz Dipole Calibration Certificate

In Collaboration with





中国认可
国际互认
校准
CALIBRATION
CNAS L0570

Add: No.51 Xueyuan Road, Haidian District, Beijing, 100191, China
Tel: +86-10-62304633-2079 Fax: +86-10-62304633-2504
E-mail: cntl@chinattl.com http://www.chinattl.cn

Client **CTTL(South Branch)** Certificate No: **Z19-60291**

CALIBRATION CERTIFICATE			
Object	D750V3 - SN: 1163		
Calibration Procedure(s)	FF-Z11-003-01 Calibration Procedures for dipole validation kits		
Calibration date:	September 3, 2019		
<p>This calibration Certificate documents the traceability to national standards, which realize the physical units of measurements(SI). The measurements and the uncertainties with confidence probability are given on the following pages and are part of the certificate.</p> <p>All calibrations have been conducted in the closed laboratory facility: environment temperature(22±3)°C and humidity<70%.</p> <p>Calibration Equipment used (M&TE critical for calibration)</p>			
Primary Standards	ID #	Cal Date(Calibrated by, Certificate No.)	Scheduled Calibration
Power Meter NRP2	106276	11-Apr-19 (CTTL, No.J19X02605)	Apr-20
Power sensor NRP6A	101359	11-Apr-19 (CTTL, No.J19X02605)	Apr-20
Reference Probe EX3DV4	SN 3617	31-Jan-19(SPEAG No.EX3-3617_Jan19)	Jan-20
DAE4	SN 1555	22-Aug-19(CTTL-SPEAG No.Z19-60295)	Aug-20
Secondary Standards	ID #	Cal Date(Calibrated by, Certificate No.)	Scheduled Calibration
Signal Generator E4438C	MY49071430	23-Jan-19 (CTTL, No.J19X00336)	Jan-20
NetworkAnalyzer E5071C	MY46110673	24-Jan-19 (CTTL, No.J19X00547)	Jan-20
Calibrated by:	Name Zhao Jing	Function SAR Test Engineer	Signature 
Reviewed by:	Name Lin Hao	Function SAR Test Engineer	Signature 
Approved by:	Name Qi Dianyuan	Function SAR Project Leader	Signature 
Issued: September 6, 2019			
This calibration certificate shall not be reproduced except in full without written approval of the laboratory.			

Certificate No: Z19-60291

Page 1 of 8



Add: No.51 Xueyuan Road, Haidian District, Beijing, 100191, China
Tel: +86-10-62304633-2079 Fax: +86-10-62304633-2504
E-mail: ctf@chinattl.com http://www.chinattl.cn

Glossary:

TSL	tissue simulating liquid
ConvF	sensitivity in TSL / NORM _{x,y,z}
N/A	not applicable or not measured

Calibration is Performed According to the Following Standards:

- IEEE Std 1528-2013, "IEEE Recommended Practice for Determining the Peak Spatial-Averaged Specific Absorption Rate (SAR) in the Human Head from Wireless Communications Devices: Measurement Techniques", June 2013
- IEC 62209-1, "Measurement procedure for assessment of specific absorption rate of human exposure to radio frequency fields from hand-held and body-mounted wireless communication devices- Part 1: Device used next to the ear (Frequency range of 300MHz to 6GHz)", July 2016
- IEC 62209-2, "Procedure to measure the Specific Absorption Rate (SAR) For wireless communication devices used in close proximity to the human body (frequency range of 30MHz to 6GHz)", March 2010
- KDB865664, SAR Measurement Requirements for 100 MHz to 6 GHz

Additional Documentation:

- DASY4/5 System Handbook

Methods Applied and Interpretation of Parameters:

- Measurement Conditions:** Further details are available from the Validation Report at the end of the certificate. All figures stated in the certificate are valid at the frequency indicated.
- Antenna Parameters with TSL:** The dipole is mounted with the spacer to position its feed point exactly below the center marking of the flat phantom section, with the arms oriented parallel to the body axis.
- Feed Point Impedance and Return Loss:** These parameters are measured with the dipole positioned under the liquid filled phantom. The impedance stated is transformed from the measurement at the SMA connector to the feed point. The Return Loss ensures low reflected power. No uncertainty required.
- Electrical Delay:** One-way delay between the SMA connector and the antenna feed point. No uncertainty required.
- SAR measured:** SAR measured at the stated antenna input power.
- SAR normalized:** SAR as measured, normalized to an input power of 1 W at the antenna connector.
- SAR for nominal TSL parameters:** The measured TSL parameters are used to calculate the nominal SAR result.

The reported uncertainty of measurement is stated as the standard uncertainty of Measurement multiplied by the coverage factor $k=2$, which for a normal distribution Corresponds to a coverage probability of approximately 95%.



Add: No.51 Xueyuan Road, Haidian District, Beijing, 100191, China
 Tel: +86-10-62304633-2079 Fax: +86-10-62304633-2504
 E-mail: ttl@chinattl.com http://www.chinattl.cn

Measurement Conditions

DASY system configuration, as far as not given on page 1.

DASY Version	DASY52	V52.10.2
Extrapolation	Advanced Extrapolation	
Phantom	Triple Flat Phantom 5.1C	
Distance Dipole Center - TSL	15 mm	with Spacer
Zoom Scan Resolution	dx, dy, dz = 5 mm	
Frequency	750 MHz \pm 1 MHz	

Head TSL parameters

The following parameters and calculations were applied.

	Temperature	Permittivity	Conductivity
Nominal Head TSL parameters	22.0 °C	41.9	0.89 mho/m
Measured Head TSL parameters	(22.0 \pm 0.2) °C	41.6 \pm 6 %	0.90 mho/m \pm 6 %
Head TSL temperature change during test	<1.0 °C	---	---

SAR result with Head TSL

SAR averaged over 1 cm^3 (1 g) of Head TSL	Condition	
SAR measured	250 mW input power	2.18 W/kg
SAR for nominal Head TSL parameters	normalized to 1W	8.53 W/kg \pm 18.8 % (k=2)
SAR averaged over 10 cm^3 (10 g) of Head TSL	Condition	
SAR measured	250 mW input power	1.44 W/kg
SAR for nominal Head TSL parameters	normalized to 1W	5.70 W/kg \pm 18.7 % (k=2)

Body TSL parameters

The following parameters and calculations were applied.

	Temperature	Permittivity	Conductivity
Nominal Body TSL parameters	22.0 °C	55.5	0.96 mho/m
Measured Body TSL parameters	(22.0 \pm 0.2) °C	55.9 \pm 6 %	0.94 mho/m \pm 6 %
Body TSL temperature change during test	<1.0 °C	---	---

SAR result with Body TSL

SAR averaged over 1 cm^3 (1 g) of Body TSL	Condition	
SAR measured	250 mW input power	2.18 W/kg
SAR for nominal Body TSL parameters	normalized to 1W	8.78 W/kg \pm 18.8 % (k=2)
SAR averaged over 10 cm^3 (10 g) of Body TSL	Condition	
SAR measured	250 mW input power	1.45 W/kg
SAR for nominal Body TSL parameters	normalized to 1W	5.87 W/kg \pm 18.7 % (k=2)



Add: No.51 Xueyuan Road, Haidian District, Beijing, 100191, China
Tel: +86-10-62304633-2079 Fax: +86-10-62304633-2504
E-mail: cttl@chinattl.com http://www.chinattl.cn

Appendix (Additional assessments outside the scope of CNAS L0570)

Antenna Parameters with Head TSL

Impedance, transformed to feed point	50.5Ω- 4.53jΩ
Return Loss	- 26.9dB

Antenna Parameters with Body TSL

Impedance, transformed to feed point	48.5Ω- 3.38jΩ
Return Loss	- 28.5dB

General Antenna Parameters and Design

Electrical Delay (one direction)	0.900 ns
----------------------------------	----------

After long term use with 100W radiated power, only a slight warming of the dipole near the feedpoint can be measured.

The dipole is made of standard semirigid coaxial cable. The center conductor of the feeding line is directly connected to the second arm of the dipole. The antenna is therefore short-circuited for DC-signals. On some of the dipoles, small end caps are added to the dipole arms in order to improve matching when loaded according to the position as explained in the "Measurement Conditions" paragraph. The SAR data are not affected by this change. The overall dipole length is still according to the Standard. No excessive force must be applied to the dipole arms, because they might bend or the soldered connections near the feedpoint may be damaged.

Additional EUT Data

Manufactured by	SPEAG
-----------------	-------



Add: No.51 Xueyuan Road, Haidian District, Beijing, 100191, China
 Tel: +86-10-62304633-2079 Fax: +86-10-62304633-2504
 E-mail: cttl@chinattl.com http://www.chinattl.cn

DASY5 Validation Report for Head TSL

Date: 09.03.2019

Test Laboratory: CTTL, Beijing, China

DUT: Dipole 750 MHz; Type: D750V3; Serial: D750V3 - SN: 1163

Communication System: UID 0, CW; Frequency: 750 MHz; Duty Cycle: 1:1

Medium parameters used: $f = 750$ MHz; $\sigma = 0.904$ S/m; $\epsilon_r = 41.62$; $\rho = 1000$ kg/m³

Phantom section: Right Section

DASY5 Configuration:

- Probe: EX3DV4 - SN3617; ConvF(10.03, 10.03, 10.03) @ 750 MHz; Calibrated: 1/31/2019
- Sensor-Surface: 1.4mm (Mechanical Surface Detection)
- Electronics: DAE4 Sn1555; Calibrated: 8/22/2019
- Phantom: MFP_V5.1C ; Type: QD 000 P51CA; Serial: 1062
- Measurement SW: DASY52, Version 52.10 (2); SEMCAD X Version 14.6.12 (7470)

Dipole Calibration/Zoom Scan (7x7x7) (7x7x7)/Cube 0: Measurement grid: dx=5mm, dy=5mm, dz=5mm

Reference Value = 55.16 V/m; Power Drift = -0.02 dB

Peak SAR (extrapolated) = 3.11 W/kg

SAR(1 g) = 2.16 W/kg; SAR(10 g) = 1.44 W/kg

Maximum value of SAR (measured) = 2.81 W/kg

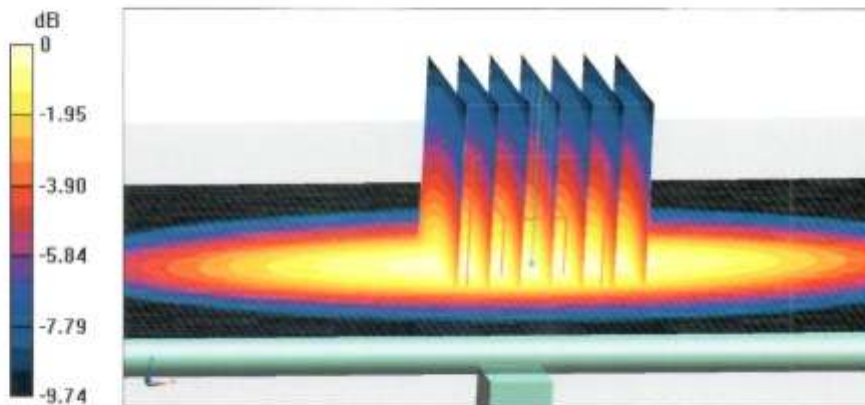



Add: No.51 Xueyuan Road, Haidian District, Beijing, 100191, China
Tel: +86-10-62304633-2079 Fax: +86-10-62304633-2504
E-mail: entl@chinattl.com <http://www.chinattl.cn>

Impedance Measurement Plot for Head TSL

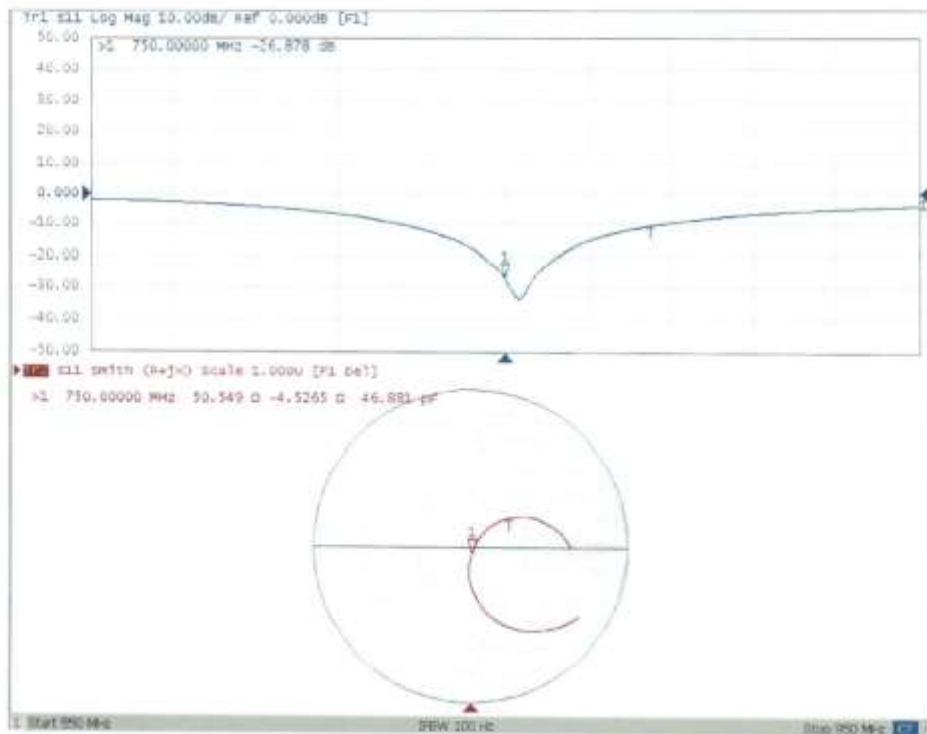



Add: No.51 Xueyuan Road, Haidian District, Beijing, 100191, China
Tel: +86-10-62304633-2079 Fax: +86-10-62304633-2504
E-mail: ctli@chinattl.com http://www.chinattl.cn

DASY5 Validation Report for Body TSL

Date: 09.03.2019

Test Laboratory: CTTL, Beijing, China

DUT: Dipole 750 MHz; Type: D750V3; Serial: D750V3 - SN: 1163

Communication System: UID 0, CW; Frequency: 750 MHz; Duty Cycle: 1:1

Medium parameters used: $f = 750$ MHz; $\sigma = 0.942$ S/m; $\epsilon_r = 55.87$; $\rho = 1000$ kg/m³

Phantom section: Center Section

DASY5 Configuration:

- Probe: EX3DV4 - SN3617; ConvF(9.85, 9.85, 9.85) @ 750 MHz; Calibrated: 1/31/2019
- Sensor-Surface: 1.4mm (Mechanical Surface Detection)
- Electronics: DAE4 Sn1555; Calibrated: 8/22/2019
- Phantom: MFP_V5.1C ; Type: QD 000 P51CA; Serial: 1062
- Measurement SW: DASY52, Version 52.10 (2); SEMCAD X Version 14.6.12 (7470)

Dipole Calibration/Zoom Scan (7x7x7) (7x7x7)/Cube 0: Measurement grid: dx=5mm, dy=5mm, dz=5mm

Reference Value = 52.88 V/m; Power Drift = 0.03 dB

Peak SAR (extrapolated) = 3.20 W/kg

SAR(1 g) = 2.16 W/kg; SAR(10 g) = 1.45 W/kg

Maximum value of SAR (measured) = 2.85 W/kg

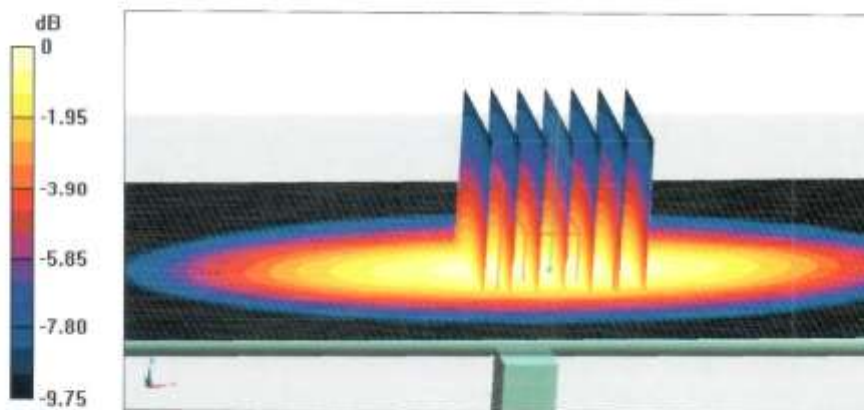

0 dB = 2.85 W/kg = 4.55 dBW/kg



Add: No.51 Xueyuan Road, Haidian District, Beijing, 100191, China
Tel: +86-10-62304633-2079 Fax: +86-10-62304633-2504
E-mail: cntl@chinatl.com http://www.chinatl.cn

Impedance Measurement Plot for Body TSL

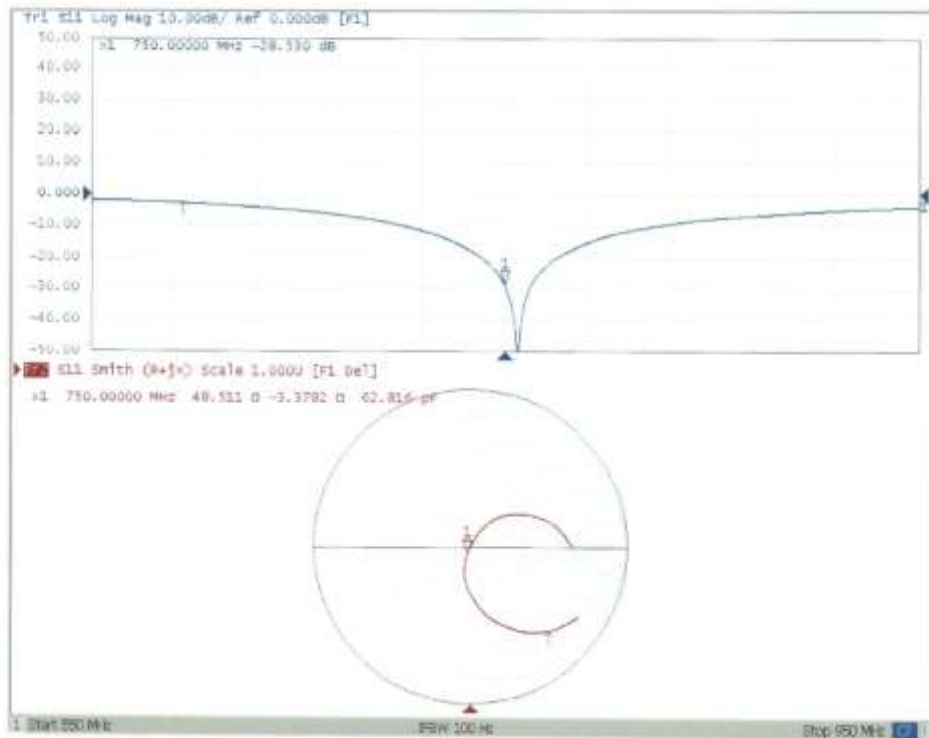



No. B20N00421-SAR

835 MHz Dipole Calibration Certificate



In Collaboration with
s p e a g
CALIBRATION LABORATORY



中国认可
国际互认
校准
CALIBRATION
CNAS LD570

Add: No.51 Xueyuan Road, Haidian District, Beijing, 100191, China
Tel: +86-10-62304633-2079 Fax: +86-10-62304633-2504
E-mail: cntl@chinattl.com http://www.chinattl.cn

Client **CTTL(South Branch)**

Certificate No: **Z18-60385**

CALIBRATION CERTIFICATE

Object: D835V2 - SN: 4d057

Calibration Procedure(s): FF-Z11-003-01
Calibration Procedures for dipole validation kits.

Calibration date: October 9, 2018

This calibration Certificate documents the traceability to national standards, which realize the physical units of measurements(SI). The measurements and the uncertainties with confidence probability are given on the following pages and are part of the certificate.

All calibrations have been conducted in the closed laboratory facility: environment temperature(22±3)°C and humidity<70%.

Calibration Equipment used (M&TE critical for calibration)

Primary Standards	ID #	Cal Date(Calibrated by, Certificate No.)	Scheduled Calibration
Power Meter NRVD	102083	01-Nov-17 (CTTL, No.J17X08756)	Oct-18
Power sensor NRV-Z5	100542	01-Nov-17 (CTTL, No.J17X08756)	Oct-18
Reference Probe EX3DV4 DAE4	SN 7514	27-Aug-18(SPEAG,No.EX3-7514_Aug18)	Aug-19
	SN 1555	20-Aug-18(SPEAG,No.DAE4-1555_Aug18)	Aug-19
Secondary Standards	ID #	Cal Date(Calibrated by, Certificate No.)	Scheduled Calibration
Signal Generator E4438C	MY49071430	23-Jan-18 (CTTL, No.J18X00560)	Jan-19
NetworkAnalyzer E5071C	MY46110673	24-Jan-18 (CTTL, No.J18X00561)	Jan-19

Calibrated by:	Name	Function	Signature
	Zhao Jing	SAR Test Engineer	
Reviewed by:	Lin Hao	SAR Test Engineer	
Approved by:	Qi Dianyuan	SAR Project Leader	

Issued: October 11, 2018

This calibration certificate shall not be reproduced except in full without written approval of the laboratory.

Certificate No: Z18-60385

Page 1 of 8



Add: No.51 Xueyuan Road, Haidian District, Beijing, 100191, China
Tel: +86-10-62304633-2079 Fax: +86-10-62304633-2504
E-mail: ctf@chinattl.com http://www.chinattl.cn

Glossary:

TSL	tissue simulating liquid
ConvF	sensitivity in TSL / NORM _{x,y,z}
N/A	not applicable or not measured

Calibration is Performed According to the Following Standards:

- IEEE Std 1528-2013, "IEEE Recommended Practice for Determining the Peak Spatial-Averaged Specific Absorption Rate (SAR) in the Human Head from Wireless Communications Devices: Measurement Techniques", June 2013
- IEC 62209-1, "Measurement procedure for assessment of specific absorption rate of human exposure to radio frequency fields from hand-held and body-mounted wireless communication devices- Part 1: Device used next to the ear (Frequency range of 300MHz to 6GHz)", July 2016
- IEC 62209-2, "Procedure to measure the Specific Absorption Rate (SAR) For wireless communication devices used in close proximity to the human body (frequency range of 30MHz to 6GHz)", March 2010
- KDB865664, SAR Measurement Requirements for 100 MHz to 6 GHz

Additional Documentation:

- DASY4/5 System Handbook

Methods Applied and Interpretation of Parameters:

- Measurement Conditions:** Further details are available from the Validation Report at the end of the certificate. All figures stated in the certificate are valid at the frequency indicated.
- Antenna Parameters with TSL:** The dipole is mounted with the spacer to position its feed point exactly below the center marking of the flat phantom section, with the arms oriented parallel to the body axis.
- Feed Point Impedance and Return Loss:** These parameters are measured with the dipole positioned under the liquid filled phantom. The impedance stated is transformed from the measurement at the SMA connector to the feed point. The Return Loss ensures low reflected power. No uncertainty required.
- Electrical Delay:** One-way delay between the SMA connector and the antenna feed point. No uncertainty required.
- SAR measured:** SAR measured at the stated antenna input power.
- SAR normalized:** SAR as measured, normalized to an input power of 1 W at the antenna connector.
- SAR for nominal TSL parameters:** The measured TSL parameters are used to calculate the nominal SAR result.

The reported uncertainty of measurement is stated as the standard uncertainty of Measurement multiplied by the coverage factor $k=2$, which for a normal distribution Corresponds to a coverage probability of approximately 95%.



Add: No.51 Xueyuan Road, Haidian District, Beijing, 100191, China
 Tel: +86-10-62304633-2079 Fax: +86-10-62304633-2504
 E-mail: cntf@chinattl.com http://www.chinattl.cn

Measurement Conditions

DASY system configuration, as far as not given on page 1.

DASY Version	DASY52	52.10.1.1476
Extrapolation	Advanced Extrapolation	
Phantom	Triple Flat Phantom 5.1C	
Distance Dipole Center - TSL	15 mm	with Spacer
Zoom Scan Resolution	dx, dy, dz = 5 mm	
Frequency	835 MHz \pm 1 MHz	

Head TSL parameters

The following parameters and calculations were applied.

	Temperature	Permittivity	Conductivity
Nominal Head TSL parameters	22.0 °C	41.5	0.90 mho/m
Measured Head TSL parameters	(22.0 \pm 0.2) °C	42.2 \pm 6 %	0.91 mho/m \pm 6 %
Head TSL temperature change during test	<1.0 °C	---	---

SAR result with Head TSL

SAR averaged over 1 cm^3 (1 g) of Head TSL	Condition	
SAR measured	250 mW input power	2.42 mW / g
SAR for nominal Head TSL parameters	normalized to 1W	9.62 mW / g \pm 18.8 % (k=2)
SAR averaged over 10 cm^3 (10 g) of Head TSL	Condition	
SAR measured	250 mW input power	1.58 mW / g
SAR for nominal Head TSL parameters	normalized to 1W	6.29 mW / g \pm 18.7 % (k=2)

Body TSL parameters

The following parameters and calculations were applied.

	Temperature	Permittivity	Conductivity
Nominal Body TSL parameters	22.0 °C	55.2	0.97 mho/m
Measured Body TSL parameters	(22.0 \pm 0.2) °C	55.9 \pm 6 %	0.99 mho/m \pm 6 %
Body TSL temperature change during test	<1.0 °C	---	---

SAR result with Body TSL

SAR averaged over 1 cm^3 (1 g) of Body TSL	Condition	
SAR measured	250 mW input power	2.51 mW / g
SAR for nominal Body TSL parameters	normalized to 1W	9.90 mW / g \pm 18.8 % (k=2)
SAR averaged over 10 cm^3 (10 g) of Body TSL	Condition	
SAR measured	250 mW input power	1.66 mW / g
SAR for nominal Body TSL parameters	normalized to 1W	6.56 mW / g \pm 18.7 % (k=2)



Add: No.51 Xueyuan Road, Haidian District, Beijing, 100191, China
Tel: +86-10-62304633-2079 Fax: +86-10-62304633-2504
E-mail: cttl@chinatl.com http://www.chinatl.cn

Appendix (Additional assessments outside the scope of CNAS L0570)

Antenna Parameters with Head TSL

Table with 2 columns: Parameter (Impedance, transformed to feed point; Return Loss) and Value (49.6Ω- 4.08jΩ; - 27.7dB)

Antenna Parameters with Body TSL

Table with 2 columns: Parameter (Impedance, transformed to feed point; Return Loss) and Value (46.8Ω- 4.96jΩ; - 24.3dB)

General Antenna Parameters and Design

Table with 2 columns: Parameter (Electrical Delay (one direction)) and Value (1.260 ns)

After long term use with 100W radiated power, only a slight warming of the dipole near the feedpoint can be measured.

The dipole is made of standard semirigid coaxial cable. The center conductor of the feeding line is directly connected to the second arm of the dipole. The antenna is therefore short-circuited for DC-signals. On some of the dipoles, small end caps are added to the dipole arms in order to improve matching when loaded according to the position as explained in the "Measurement Conditions" paragraph. The SAR data are not affected by this change. The overall dipole length is still according to the Standard. No excessive force must be applied to the dipole arms, because they might bend or the soldered connections near the feedpoint may be damaged.

Additional EUT Data

Table with 2 columns: Parameter (Manufactured by) and Value (SPEAG)



Add: No.51 Xueyun Road, Haidian District, Beijing, 100191, China
Tel: +86-10-62304633-2079 Fax: +86-10-62304633-2504
E-mail: cttl@chinattl.com http://www.chinattl.cn

DASY5 Validation Report for Head TSL

Date: 10.08.2018

Test Laboratory: CTTL, Beijing, China

DUT: Dipole 835 MHz; Type: D835V2; Serial: D835V2 - SN: 4d057

Communication System: UID 0, CW; Frequency: 835 MHz; Duty Cycle: 1:1

Medium parameters used: $f = 835$ MHz; $\sigma = 0.912$ S/m; $\epsilon_r = 42.22$; $\rho = 1000$ kg/m³

Phantom section: Center Section

DASY5 Configuration:

- Probe: EX3DV4 - SN7514; ConvF(9.09, 9.09, 9.09) @ 835 MHz; Calibrated: 8/27/2018
- Sensor-Surface: 1.4mm (Mechanical Surface Detection)
- Electronics: DAE4 Sn1555; Calibrated: 8/20/2018
- Phantom: MFP_V5.1C ; Type: QD 000 P51CA; Serial: 1062
- Measurement SW: DASY52, Version 52.10 (1); SEMCAD X Version 14.6.11 (7439)

Dipole Calibration/Zoom Scan (7x7x7) (7x7x7)/Cube 0: Measurement grid: dx=5mm, dy=5mm, dz=5mm

Reference Value = 55.57 V/m; Power Drift = -0.04 dB

Peak SAR (extrapolated) = 3.61 W/kg

SAR(1 g) = 2.42 W/kg; SAR(10 g) = 1.58 W/kg

Maximum value of SAR (measured) = 3.22 W/kg

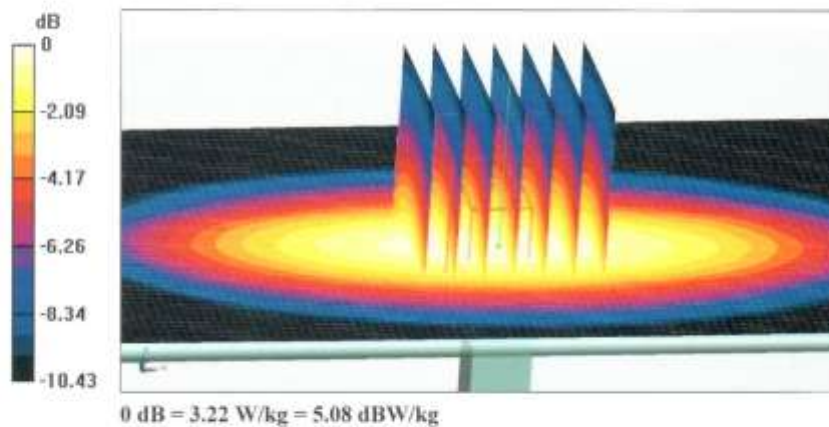



Add: No.51 Xueyuan Road, Haidian District, Beijing, 100191, China
Tel: +86-10-62304633-2079 Fax: +86-10-62304633-2504
E-mail: ttl@chinatl.com http://www.chinatl.cn

Impedance Measurement Plot for Head TSL

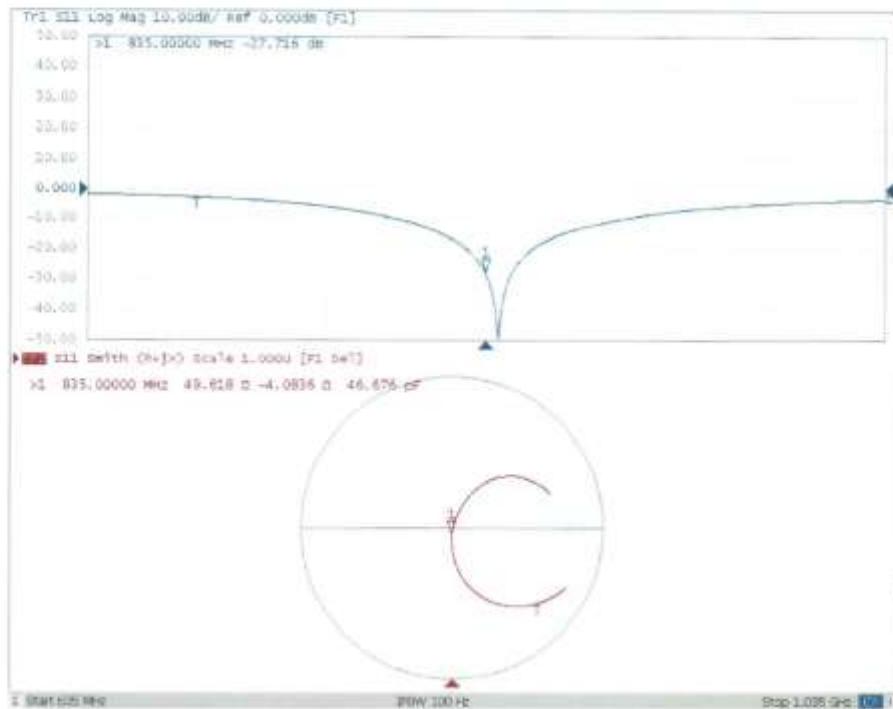

DASY5 Validation Report for Body TSL

Date: 10.08.2018

Test Laboratory: CTTL, Beijing, China

DUT: Dipole 835 MHz; Type: D835V2; Serial: D835V2 - SN: 4d057

Communication System: UID 0, CW; Frequency: 835 MHz; Duty Cycle: 1:1

Medium parameters used: $f = 835$ MHz; $\sigma = 0.992$ S/m; $\epsilon_r = 55.93$; $\rho = 1000$ kg/m³

Phantom section: Right Section

DASY5 Configuration:

- Probe: EX3DV4 - SN7514; ConvF(9.47, 9.47, 9.47) @ 835 MHz; Calibrated: 8/27/2018
- Sensor-Surface: 1.4mm (Mechanical Surface Detection)
- Electronics: DAE4 Sn1555; Calibrated: 8/20/2018
- Phantom: MFP_V5.1C ; Type: QD 000 P51CA; Serial: 1062
- Measurement SW: DASY52, Version 52.10 (1); SEMCAD X Version 14.6.11 (7439)

Dipole Calibration/Zoom Scan (7x7x7) (7x7x7)/Cube 0: Measurement grid: dx=5mm, dy=5mm, dz=5mm

Reference Value = 56.64 V/m; Power Drift = -0.01 dB

Peak SAR (extrapolated) = 3.83 W/kg

SAR(1 g) = 2.51 W/kg; SAR(10 g) = 1.66 W/kg

Maximum value of SAR (measured) = 3.36 W/kg

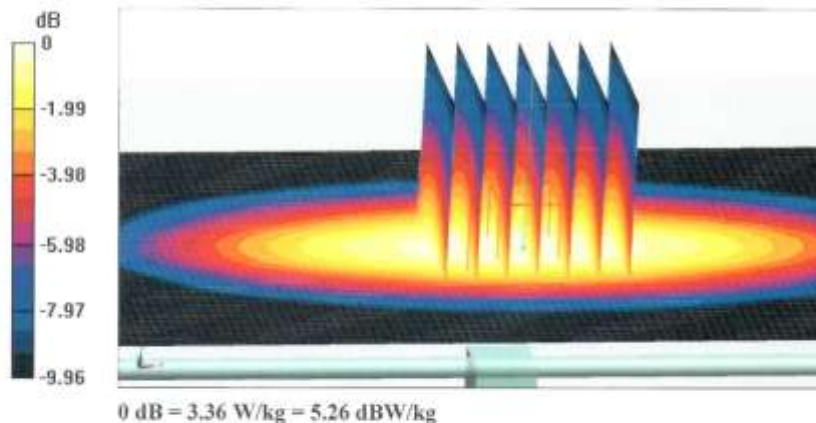



Addr: No.51 Xueyuan Road, Haidian District, Beijing, 100191, China
Tel: +86-10-62304633-2079 Fax: +86-10-62304633-2504
E-mail: cntl@chinattl.com http://www.chinattl.cn

Impedance Measurement Plot for Body TSL

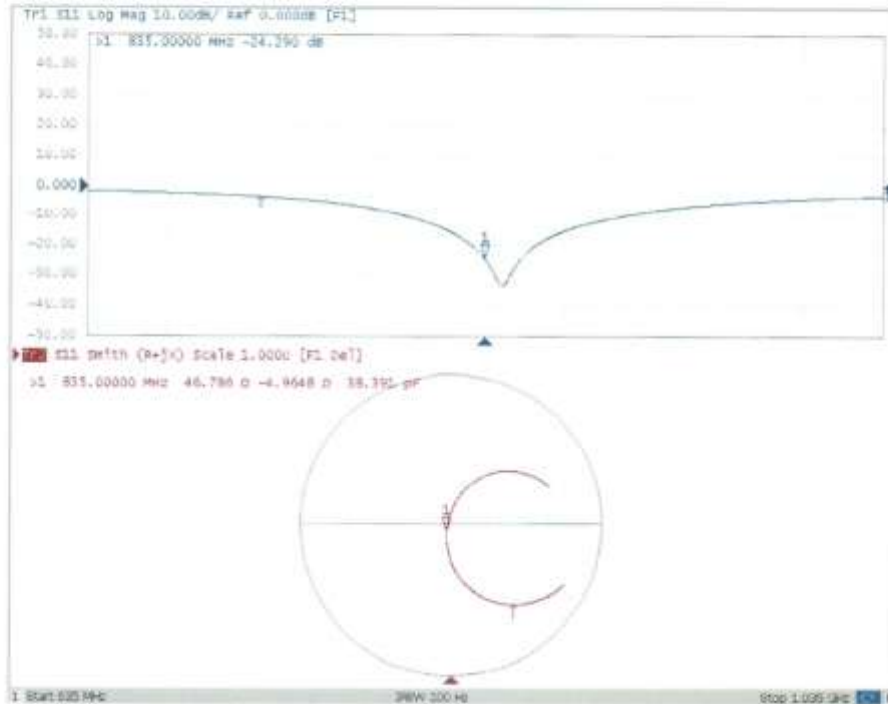



No. B20N00421-SAR

1750 MHz Dipole Calibration Certificate



In Collaboration with
Add: No.51 Xueyuan Road, Haidian District, Beijing, 100191, China
Tel: +86-10-62304633-2079 Fax: +86-10-62304633-2504
E-mail: ctll@chinattl.com http://www.chinattl.cn



中国认可
国际互认
校准
CALIBRATION
CNAS L0570

Client **CTTL(South Branch)**

Certificate No: **Z19-60292**

CALIBRATION CERTIFICATE

Object: **D1750V2 - SN: 1152**

Calibration Procedure(s): **FF-Z11-003-01
Calibration Procedures for dipole validation kits**

Calibration date: **August 30, 2019**

This calibration Certificate documents the traceability to national standards, which realize the physical units of measurements(SI). The measurements and the uncertainties with confidence probability are given on the following pages and are part of the certificate.

All calibrations have been conducted in the closed laboratory facility: environment temperature(22±3)℃ and humidity<70%.

Calibration Equipment used (M&TE critical for calibration)

Primary Standards	ID #	Cal Date(Calibrated by, Certificate No.)	Scheduled Calibration
Power Meter NRP2	106276	11-Apr-19 (CTTL, No.J19X02605)	Apr-20
Power sensor NRP6A	101369	11-Apr-19 (CTTL, No.J19X02605)	Apr-20
Reference Probe EX3DV4	SN 3617	31-Jan-19(SPEAG No.EX3-3617_Jan19)	Jan-20
DAE4	SN 1555	22-Aug-19(CTTL-SPEAG, No.Z19-60295)	Aug-20
Secondary Standards	ID #	Cal Date(Calibrated by, Certificate No.)	Scheduled Calibration
Signal Generator E4438C	MY49071430	23-Jan-19 (CTTL, No.J19X00336)	Jan-20
NetworkAnalyzer E5071C	MY46110673	24-Jan-19 (CTTL, No.J19X00547)	Jan-20

	Name	Function	Signature
Calibrated by:	Zhao Jing	SAR Test Engineer	
Reviewed by:	Lin Hao	SAR Test Engineer	
Approved by:	Qi Dianyuan	SAR Project Leader	

Issued: September 2, 2019

This calibration certificate shall not be reproduced except in full without written approval of the laboratory.



Add: No.51 Xueyuan Road, Haidian District, Beijing, 100191, China
Tel: +86-10-62304633-2079 Fax: +86-10-62304633-2504
E-mail: cni@chinattl.com http://www.chinattl.cn

Glossary:

TSL	tissue simulating liquid
ConvF	sensitivity in TSL / NORM _{x,y,z}
N/A	not applicable or not measured

Calibration is Performed According to the Following Standards:

- IEEE Std 1528-2013, "IEEE Recommended Practice for Determining the Peak Spatial-Averaged Specific Absorption Rate (SAR) in the Human Head from Wireless Communications Devices: Measurement Techniques", June 2013
- IEC 62209-1, "Measurement procedure for assessment of specific absorption rate of human exposure to radio frequency fields from hand-held and body-mounted wireless communication devices- Part 1: Device used next to the ear (Frequency range of 300MHz to 6GHz)", July 2016
- IEC 62209-2, "Procedure to measure the Specific Absorption Rate (SAR) For wireless communication devices used in close proximity to the human body (frequency range of 30MHz to 6GHz)", March 2010
- KDB865664, SAR Measurement Requirements for 100 MHz to 6 GHz

Additional Documentation:

- DASY4/5 System Handbook

Methods Applied and Interpretation of Parameters:

- Measurement Conditions:* Further details are available from the Validation Report at the end of the certificate. All figures stated in the certificate are valid at the frequency indicated.
- Antenna Parameters with TSL:* The dipole is mounted with the spacer to position its feed point exactly below the center marking of the flat phantom section, with the arms oriented parallel to the body axis.
- Feed Point Impedance and Return Loss:* These parameters are measured with the dipole positioned under the liquid filled phantom. The impedance stated is transformed from the measurement at the SMA connector to the feed point. The Return Loss ensures low reflected power. No uncertainty required.
- Electrical Delay:* One-way delay between the SMA connector and the antenna feed point. No uncertainty required.
- SAR measured:* SAR measured at the stated antenna input power.
- SAR normalized:* SAR as measured, normalized to an input power of 1 W at the antenna connector.
- SAR for nominal TSL parameters:* The measured TSL parameters are used to calculate the nominal SAR result.

The reported uncertainty of measurement is stated as the standard uncertainty of Measurement multiplied by the coverage factor $k=2$, which for a normal distribution Corresponds to a coverage probability of approximately 95%.



Add: No.51 Xueyuan Road, Haidian District, Beijing, 100191, China
 Tel: +86-10-62304633-2079 Fax: +86-10-62304633-2504
 E-mail: cttf@chinattf.com http://www.chinattf.cn

Measurement Conditions

DASY system configuration, as far as not given on page 1.

DASY Version	DASY52	V52.10.2
Extrapolation	Advanced Extrapolation	
Phantom	Triple Flat Phantom 5.1C	
Distance Dipole Center - TSL	10 mm	with Spacer
Zoom Scan Resolution	dx, dy, dz = 5 mm	
Frequency	1750 MHz ± 1 MHz	

Head TSL parameters

The following parameters and calculations were applied.

	Temperature	Permittivity	Conductivity
Nominal Head TSL parameters	22.0 °C	40.1	1.37 mho/m
Measured Head TSL parameters	(22.0 ± 0.2) °C	39.9 ± 6 %	1.36 mho/m ± 6 %
Head TSL temperature change during test	<1.0 °C	---	---

SAR result with Head TSL

SAR averaged over 1 cm ³ (1 g) of Head TSL	Condition	
SAR measured	250 mW input power	9.05 W/kg
SAR for nominal Head TSL parameters	normalized to 1W	36.4 W/kg ± 18.8 % (k=2)
SAR averaged over 10 cm ³ (10 g) of Head TSL	Condition	
SAR measured	250 mW input power	4.80 W/kg
SAR for nominal Head TSL parameters	normalized to 1W	19.3 W/kg ± 18.7 % (k=2)

Body TSL parameters

The following parameters and calculations were applied.

	Temperature	Permittivity	Conductivity
Nominal Body TSL parameters	22.0 °C	53.4	1.49 mho/m
Measured Body TSL parameters	(22.0 ± 0.2) °C	53.1 ± 6 %	1.52 mho/m ± 6 %
Body TSL temperature change during test	<1.0 °C	---	---

SAR result with Body TSL

SAR averaged over 1 cm ³ (1 g) of Body TSL	Condition	
SAR measured	250 mW input power	9.45 W/kg
SAR for nominal Body TSL parameters	normalized to 1W	37.3 W/kg ± 18.8 % (k=2)
SAR averaged over 10 cm ³ (10 g) of Body TSL	Condition	
SAR measured	250 mW input power	5.05 W/kg
SAR for nominal Body TSL parameters	normalized to 1W	20.0 W/kg ± 18.7 % (k=2)



Add: No.51 Xueyuan Road, Haidian District, Beijing, 100191, China
Tel: +86-10-62304633-2079 Fax: +86-10-62304633-2504
E-mail: ttl@chinantl.com http://www.chinantl.cn

Appendix (Additional assessments outside the scope of CNAS L0570)

Antenna Parameters with Head TSL

Impedance, transformed to feed point	49.1Ω- 0.84 jΩ
Return Loss	- 38.1 dB

Antenna Parameters with Body TSL

Impedance, transformed to feed point	45.2Ω- 1.37 jΩ
Return Loss	- 25.5 dB

General Antenna Parameters and Design

Electrical Delay (one direction)	1.084 ns
----------------------------------	----------

After long term use with 100W radiated power, only a slight warming of the dipole near the feedpoint can be measured.

The dipole is made of standard semirigid coaxial cable. The center conductor of the feeding line is directly connected to the second arm of the dipole. The antenna is therefore short-circuited for DC-signals. On some of the dipoles, small end caps are added to the dipole arms in order to improve matching when loaded according to the position as explained in the "Measurement Conditions" paragraph. The SAR data are not affected by this change. The overall dipole length is still according to the Standard. No excessive force must be applied to the dipole arms, because they might bend or the soldered connections near the feedpoint may be damaged.

Additional EUT Data

Manufactured by	SPEAG
-----------------	-------



Add: No.51 Xueyuan Road, Haidian District, Beijing, 100191, China
 Tel: +86-10-62304633-2079 Fax: +86-10-62304633-2504
 E-mail: cttl@chinattl.com http://www.chinattl.cn

DASY5 Validation Report for Head TSL

Date: 08.30.2019

Test Laboratory: CTTL, Beijing, China

DUT: Dipole 1750 MHz; Type: D1750V2; Serial: D1750V2 - SN: 1152

Communication System: UID 0, CW; Frequency: 1750 MHz; Duty Cycle: 1:1

Medium parameters used: $f = 1750$ MHz; $\sigma = 1.358$ S/m; $\epsilon_r = 39.91$; $\rho = 1000$ kg/m³

Phantom section: Right Section

DASY5 Configuration:

- Probe: EX3DV4 - SN3617; ConvF(8.38, 8.38, 8.38) @ 1750 MHz; Calibrated: 1/31/2019
- Sensor-Surface: 1.4mm (Mechanical Surface Detection)
- Electronics: DAE4 Sn1555; Calibrated: 8/22/2019
- Phantom: MFP_V5.1C ; Type: QD 000 P51CA; Serial: 1062
- Measurement SW: DASY52, Version 52.10 (2); SEMCAD X Version 14.6.12 (7470)

System Performance Check/Zoom Scan (7x7x7) (7x7x7)/Cube 0: Measurement grid:

$dx=5$ mm, $dy=5$ mm, $dz=5$ mm

Reference Value = 97.38 V/m; Power Drift = -0.03 dB

Peak SAR (extrapolated) = 16.8 W/kg

SAR(1 g) = 9.05 W/kg; SAR(10 g) = 4.8 W/kg

Maximum value of SAR (measured) = 13.9 W/kg

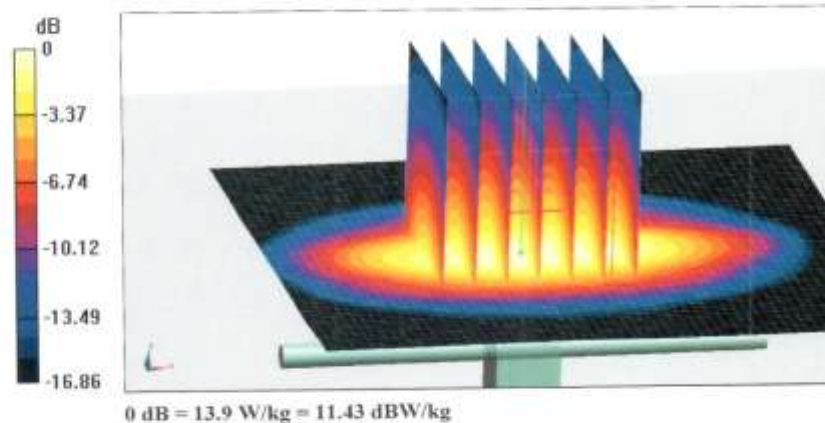



Add: No.51 Xueyuan Road, Haidian District, Beijing, 100191, China
Tel: +86-10-62304633-2079 Fax: +86-10-62304633-2504
E-mail: cml@chinantl.com http://www.chinantl.cn

Impedance Measurement Plot for Head TSL

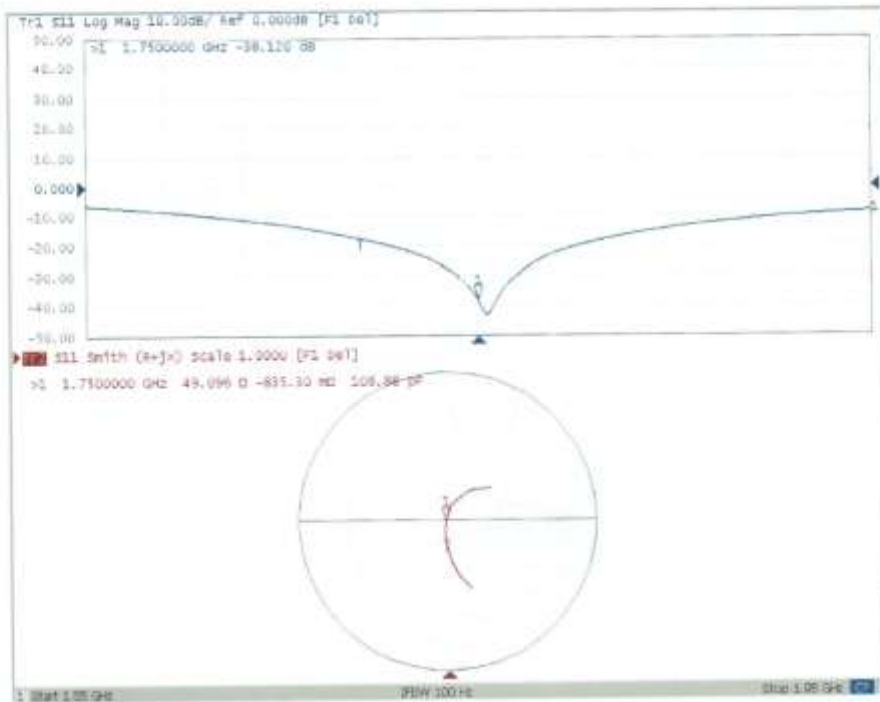

DASY5 Validation Report for Body TSL

Date: 08.30.2019

Test Laboratory: CTTL, Beijing, China

DUT: Dipole 1750 MHz; Type: D1750V2; Serial: D1750V2 - SN: 1152

Communication System: UID 0, CW; Frequency: 1750 MHz; Duty Cycle: 1:1

Medium parameters used: $f = 1750$ MHz; $\sigma = 1.516$ S/m; $\epsilon_r = 53.05$; $\rho = 1000$ kg/m³

Phantom section: Center Section

DASY5 Configuration:

- Probe: EX3DV4 - SN3617; ConvF(8.03, 8.03, 8.03) @ 1750 MHz; Calibrated: 1/31/2019
- Sensor-Surface: 1.4mm (Mechanical Surface Detection)
- Electronics: DAE4 Sn1555; Calibrated: 8/22/2019
- Phantom: MFP_V5.1C ; Type: QD 000 P51CA; Serial: 1062
- Measurement SW: DASY52, Version 52.10 (2); SEMCAD X Version 14.6.12 (7470)

System Performance Check/Zoom Scan (7x7x7) (7x7x7)/Cube 0: Measurement grid:

dx=5mm, dy=5mm, dz=5mm

Reference Value = 87.16 V/m; Power Drift = 0.06 dB

Peak SAR (extrapolated) = 17.0 W/kg

SAR(1 g) = 9.45 W/kg; SAR(10 g) = 5.05 W/kg

Maximum value of SAR (measured) = 14.4 W/kg

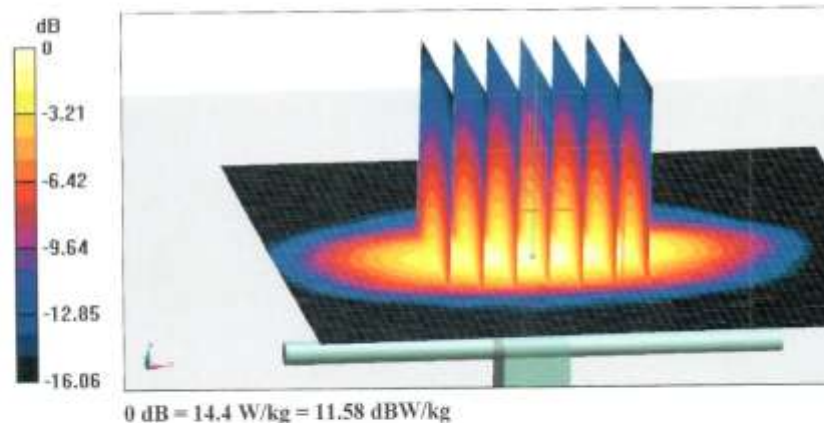



Add: No.51 Xueyuan Road, Haidian District, Beijing, 100191, China.
Tel: +86-10-62304633-2079 Fax: +86-10-62304633-2504
E-mail: ctt@chinattl.com http://www.chinattl.cn

Impedance Measurement Plot for Body TSL

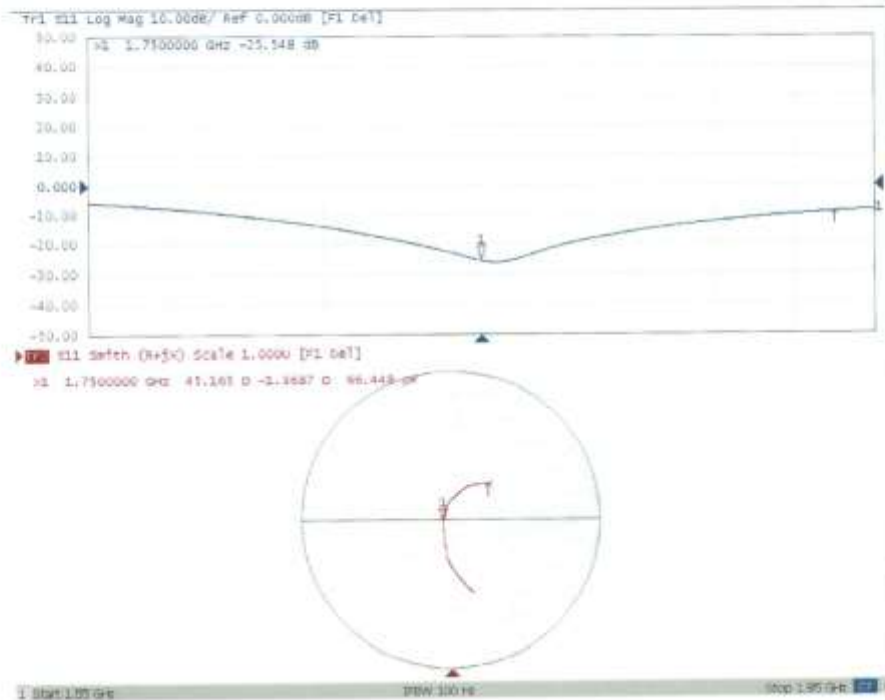



No. B20N00421-SAR

1900 MHz Dipole Calibration Certificate



In Collaboration with
s p e a g
CALIBRATION LABORATORY

Add: No.51 Xueyuan Road, Haidian District, Beijing, 100191, China
Tel: +86-10-62304633-2079 Fax: +86-10-62304633-2504
E-mail: cttl@chinattl.com http://www.chinattl.cn



中国认可
国际互认
校准
CALIBRATION
CNAS L0570

Client **CTTL(South Branch)**

Certificate No: **Z18-60387**

CALIBRATION CERTIFICATE

Object: D1900V2 - SN: 5d088

Calibration Procedure(s): FF-Z11-003-01
Calibration Procedures for dipole validation kits

Calibration date: October 24, 2018

This calibration Certificate documents the traceability to national standards, which realize the physical units of measurements(SI). The measurements and the uncertainties with confidence probability are given on the following pages and are part of the certificate.

All calibrations have been conducted in the closed laboratory facility: environment temperature(22±3)°C and humidity<70%.

Calibration Equipment used (M&TE critical for calibration)

Primary Standards	ID #	Cal Date(Calibrated by, Certificate No.)	Scheduled Calibration
Power Meter NRVD	102083	01-Nov-17 (CTTL, No.J17X08756)	Oct-18
Power sensor NRV-Z5	100542	01-Nov-17 (CTTL, No.J17X08756)	Oct-18
Reference Probe EX3DV4 DAE4	SN 7514	27-Aug-18(SPEAG No.EX3-7514_Aug18)	Aug-19
	SN 1555	20-Aug-18(SPEAG No.DAE4-1555_Aug18)	Aug-19
Secondary Standards	ID #	Cal Date(Calibrated by, Certificate No.)	Scheduled Calibration
Signal Generator E4438C	MY49071430	23-Jan-18 (CTTL, No.J18X00560)	Jan-19
NetworkAnalyzer E5071C	MY46110673	24-Jan-18 (CTTL, No.J18X00561)	Jan-19

	Name	Function	Signature
Calibrated by:	Zhao Jing	SAR Test Engineer	
Reviewed by:	Lin Hao	SAR Test Engineer	
Approved by:	Qi Dianyuan	SAR Project Leader	

Issued: October 28, 2018

This calibration certificate shall not be reproduced except in full without written approval of the laboratory.



Add: No.51 Xueyuan Road, Haidian District, Beijing, 100191, China
Tel: +86-10-62304633-2079 Fax: +86-10-62304633-2504
E-mail: ctf@chinattl.com http://www.chinattl.cn

lossary:

TSL	tissue simulating liquid
ConvF	sensitivity in TSL / NORM _{x,y,z}
N/A	not applicable or not measured

Calibration is Performed According to the Following Standards:

- IEEE Std 1528-2013, "IEEE Recommended Practice for Determining the Peak Spatial-Averaged Specific Absorption Rate (SAR) in the Human Head from Wireless Communications Devices: Measurement Techniques", June 2013
- IEC 62209-1, "Measurement procedure for assessment of specific absorption rate of human exposure to radio frequency fields from hand-held and body-mounted wireless communication devices- Part 1: Device used next to the ear (Frequency range of 300MHz to 6GHz)", July 2016
- IEC 62209-2, "Procedure to measure the Specific Absorption Rate (SAR) For wireless communication devices used in close proximity to the human body (frequency range of 30MHz to 6GHz)", March 2010
- KDB865664, SAR Measurement Requirements for 100 MHz to 6 GHz

Additional Documentation:

- DASY4/5 System Handbook

Methods Applied and Interpretation of Parameters:

- Measurement Conditions:** Further details are available from the Validation Report at the end of the certificate. All figures stated in the certificate are valid at the frequency indicated.
- Antenna Parameters with TSL:** The dipole is mounted with the spacer to position its feed point exactly below the center marking of the flat phantom section, with the arms oriented parallel to the body axis.
- Feed Point Impedance and Return Loss:** These parameters are measured with the dipole positioned under the liquid filled phantom. The impedance stated is transformed from the measurement at the SMA connector to the feed point. The Return Loss ensures low reflected power. No uncertainty required.
- Electrical Delay:** One-way delay between the SMA connector and the antenna feed point. No uncertainty required.
- SAR measured:** SAR measured at the stated antenna input power.
- SAR normalized:** SAR as measured, normalized to an input power of 1 W at the antenna connector.
- SAR for nominal TSL parameters:** The measured TSL parameters are used to calculate the nominal SAR result.

The reported uncertainty of measurement is stated as the standard uncertainty of Measurement multiplied by the coverage factor $k=2$, which for a normal distribution Corresponds to a coverage probability of approximately 95%.



Add: No.51 Xueyuan Road, Haidian District, Beijing, 100191, China
 Tel: +86-10-62304633-2079 Fax: +86-10-62304633-2504
 E-mail: ttl@chinattl.com http://www.chinattl.cn

Measurement Conditions

DASY system configuration, as far as not given on page 1.

DASY Version	DASY52	52.10.2.1495
Extrapolation	Advanced Extrapolation	
Phantom	Triple Flat Phantom 5.1C	
Distance Dipole Center - TSL	10 mm	with Spacer
Zoom Scan Resolution	dx, dy, dz = 5 mm	
Frequency	1900 MHz \pm 1 MHz	

Head TSL parameters

The following parameters and calculations were applied.

	Temperature	Permittivity	Conductivity
Nominal Head TSL parameters	22.0 °C	40.0	1.40 mho/m
Measured Head TSL parameters	(22.0 \pm 0.2) °C	41.1 \pm 6 %	1.37 mho/m \pm 6 %
Head TSL temperature change during test	<1.0 °C	---	---

SAR result with Head TSL

SAR averaged over 1 cm^3 (1 g) of Head TSL	Condition	
SAR measured	250 mW input power	9.92 mW / g
SAR for nominal Head TSL parameters	normalized to 1W	40.5 mW / g \pm 18.8 % (k=2)
SAR averaged over 10 cm^3 (10 g) of Head TSL	Condition	
SAR measured	250 mW input power	5.17 mW / g
SAR for nominal Head TSL parameters	normalized to 1W	21.0 mW / g \pm 18.7 % (k=2)

Body TSL parameters

The following parameters and calculations were applied.

	Temperature	Permittivity	Conductivity
Nominal Body TSL parameters	22.0 °C	53.3	1.52 mho/m
Measured Body TSL parameters	(22.0 \pm 0.2) °C	52.6 \pm 6 %	1.55 mho/m \pm 6 %
Body TSL temperature change during test	<1.0 °C	---	---

SAR result with Body TSL

SAR averaged over 1 cm^3 (1 g) of Body TSL	Condition	
SAR measured	250 mW input power	10.3 mW / g
SAR for nominal Body TSL parameters	normalized to 1W	40.6 mW / g \pm 18.8 % (k=2)
SAR averaged over 10 cm^3 (10 g) of Body TSL	Condition	
SAR measured	250 mW input power	5.41 mW / g
SAR for nominal Body TSL parameters	normalized to 1W	21.4 mW / g \pm 18.7 % (k=2)



Add: No.51 Xueyuan Road, Haidian District, Beijing, 100191, China
Tel: +86-10-62304633-2079 Fax: +86-10-62304633-2504
E-mail: ctdl@chinattl.com http://www.chinattl.cn

Appendix (Additional assessments outside the scope of CNAS L0570)

Antenna Parameters with Head TSL

Impedance, transformed to feed point	52.7Ω+ 8.63jΩ
Return Loss	- 23.2dB

Antenna Parameters with Body TSL

Impedance, transformed to feed point	48.5Ω+ 7.40jΩ
Return Loss	- 22.3dB

General Antenna Parameters and Design

Electrical Delay (one direction)	1.058 ns
----------------------------------	----------

After long term use with 100W radiated power, only a slight warming of the dipole near the feedpoint can be measured.

The dipole is made of standard semirigid coaxial cable. The center conductor of the feeding line is directly connected to the second arm of the dipole. The antenna is therefore short-circuited for DC-signals. On some of the dipoles, small end caps are added to the dipole arms in order to improve matching when loaded according to the position as explained in the "Measurement Conditions" paragraph. The SAR data are not affected by this change. The overall dipole length is still according to the Standard. No excessive force must be applied to the dipole arms, because they might bend or the soldered connections near the feedpoint may be damaged.

Additional EUT Data

Manufactured by	SPEAG
-----------------	-------

DASY5 Validation Report for Head TSL

Date: 10.24.2018

Test Laboratory: CTTL, Beijing, China

DUT: Dipole 1900 MHz; Type: D1900V2; Serial: D1900V2 - SN: 5d088

Communication System: UID 0, CW; Frequency: 1900 MHz; Duty Cycle: 1:1

Medium parameters used: $f = 1900$ MHz; $\sigma = 1.367$ S/m; $\epsilon_r = 41.1$; $\rho = 1000$ kg/m³

Phantom section: Center Section

DASY5 Configuration:

- Probe: EX3DV4 - SN7514; ConvF(7.73, 7.73, 7.73) @ 1900 MHz; Calibrated: 8/27/2018
- Sensor-Surface: 1.4mm (Mechanical Surface Detection)
- Electronics: DAE4 Sn1555; Calibrated: 8/20/2018
- Phantom: MFP_V5.1C ; Type: QD 000 P51CA; Serial: 1062
- Measurement SW: DASY52, Version 52.10 (2); SEMCAD X Version 14.6.12 (7450)

System Performance Check/Zoom Scan (7x7x7) (7x7x7)/Cube 0; Measurement grid:

dx=5mm, dy=5mm, dz=5mm

Reference Value = 102.2 V/m; Power Drift = 0.05 dB

Peak SAR (extrapolated) = 19.0 W/kg

SAR(1 g) = 9.92 W/kg; SAR(10 g) = 5.17 W/kg

Maximum value of SAR (measured) = 15.7 W/kg

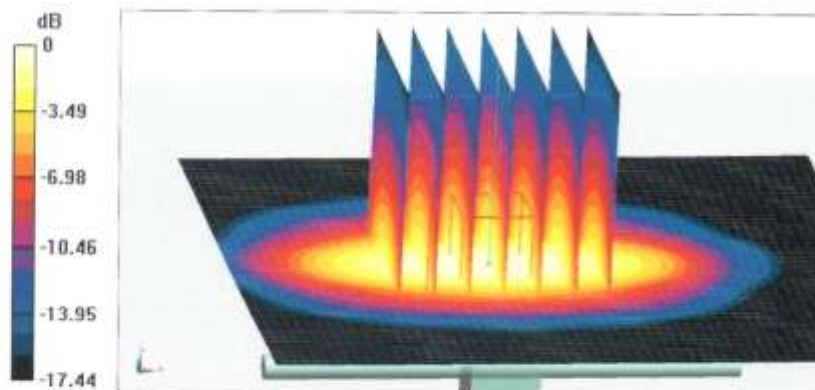
**0 dB = 15.7 W/kg = 11.96 dBW/kg**



Add: No.51 Xueyuan Road, Haidian District, Beijing, 100191, China
Tel: +86-10-62304633-2079 Fax: +86-10-62304633-2504
E-mail: ctf@chinattl.com http://www.chinattl.cn

Impedance Measurement Plot for Head TSL

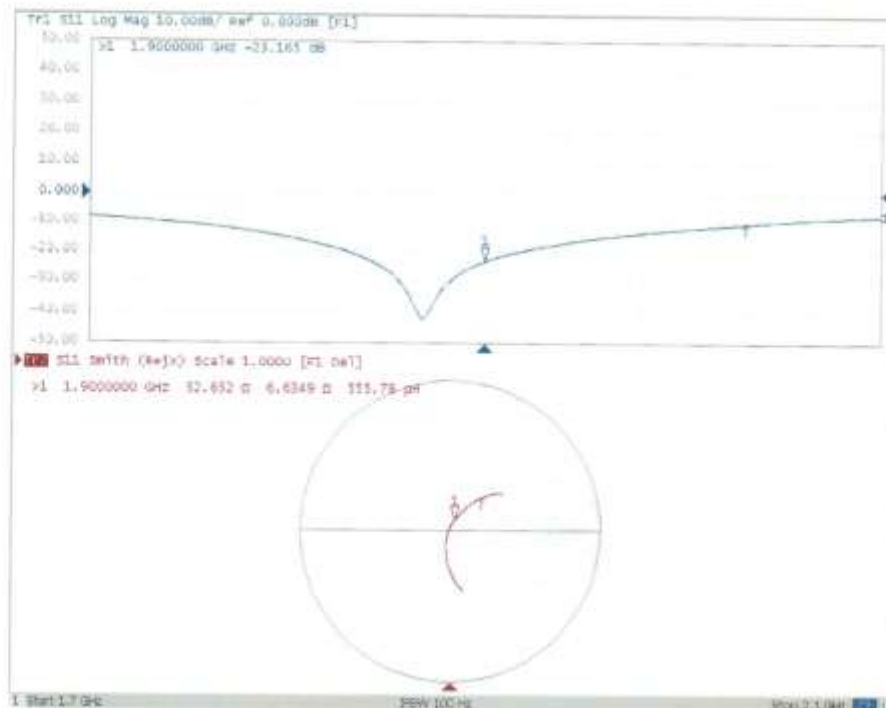



Add: No.51 Xueyuan Road, Haidian District, Beijing, 100191, China
 Tel: +86-10-62304633-2079 Fax: +86-10-62304633-2504
 E-mail: cttl@chinattl.com http://www.chinattl.cn

DASY5 Validation Report for Body TSL

Date: 10.24.2018

Test Laboratory: CTTL, Beijing, China

DUT: Dipole 1900 MHz; Type: D1900V2; Serial: D1900V2 - SN: 5d088

Communication System: UID 0, CW; Frequency: 1900 MHz; Duty Cycle: 1:1

Medium parameters used: $f = 1900$ MHz; $\sigma = 1.551$ S/m; $\epsilon_r = 52.63$; $\rho = 1000$ kg/m³

Phantom section: Right Section

DASY5 Configuration:

- Probe: EX3DV4 - SN7514; ConvF(7.53, 7.53, 7.53) @ 1900 MHz; Calibrated: 8/27/2018
- Sensor-Surface: 1.4mm (Mechanical Surface Detection)
- Electronics: DAE4 Sn1555; Calibrated: 8/20/2018
- Phantom: MFP_V5.1C ; Type: QD 000 P51CA; Serial: 1062
- Measurement SW: DASY52, Version 52.10 (2); SEMCAD X Version 14.6.12 (7450)

System Performance Check/Zoom Scan (7x7x7) (7x7x7)/Cube 0: Measurement grid:

$dx=5$ mm, $dy=5$ mm, $dz=5$ mm

Reference Value = 97.60 V/m; Power Drift = -0.02 dB

Peak SAR (extrapolated) = 19.0 W/kg

SAR(1 g) = 10.3 W/kg; SAR(10 g) = 5.41 W/kg

Maximum value of SAR (measured) = 15.9 W/kg

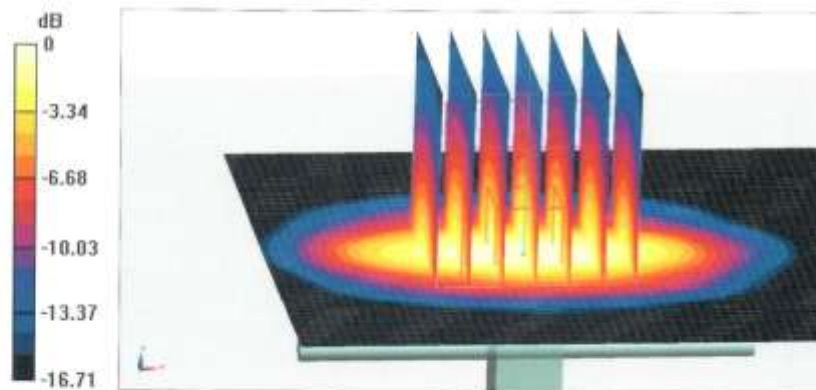

0 dB = 15.9 W/kg = 12.01 dBW/kg



Add: No.51 Xueyuan Road, Haidian District, Beijing, 100191, China
Tel: +86-10-62304633-2079 Fax: +86-10-62304633-2504
E-mail: ttl@chinattl.com http://www.chinattl.cn

Impedance Measurement Plot for Body TSL

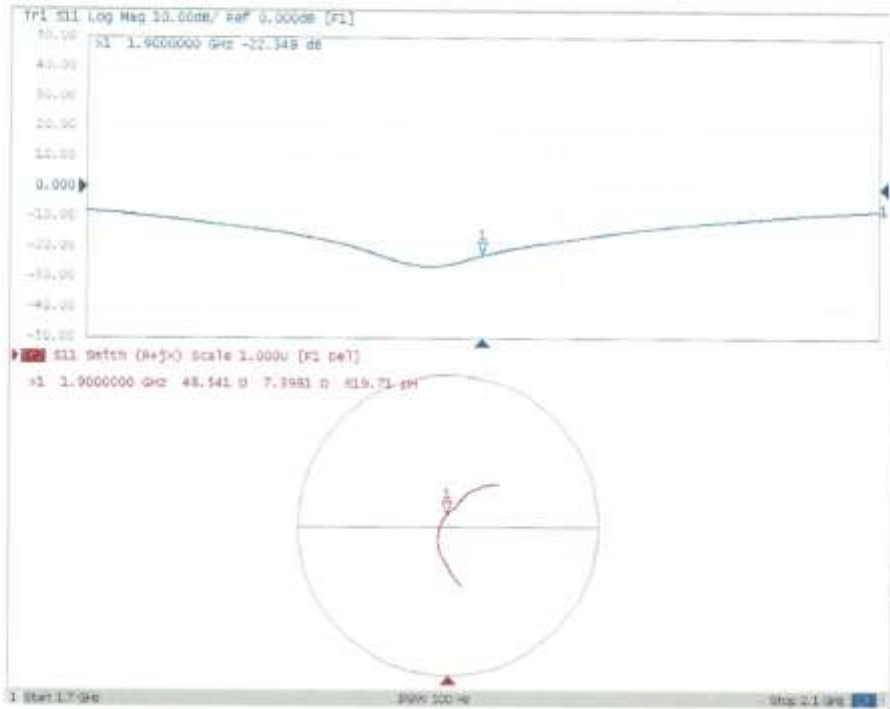



No. B20N00421-SAR

2300MHz Dipole Calibration Certificate



In Collaboration with
s p e a g
CALIBRATION LABORATORY

Add: No.51 Xueyuan Road, Haidian District, Beijing, 100191, China
Tel: +86-10-62304633-2079 Fax: +86-10-62304633-2504
E-mail: ctfl@chinattl.com http://www.chinattl.cn



中国认可
国际互认
校准
CALIBRATION
CNAS L0570

Client **CTTL(South Branch)**

Certificate No: **Z18-60339**

CALIBRATION CERTIFICATE

Object **D2300V2 - SN: 1059**

Calibration Procedure(s) **FF-Z11-003-01**
Calibration Procedures for dipole validation kits

Calibration date: **September 3, 2018**

This calibration Certificate documents the traceability to national standards, which realize the physical units of measurements(SI). The measurements and the uncertainties with confidence probability are given on the following pages and are part of the certificate.

All calibrations have been conducted in the closed laboratory facility: environment temperature(22±3)℃ and humidity<70%.

Calibration Equipment used (M&TE critical for calibration)

Primary Standards	ID #	Cal Date(Calibrated by, Certificate No.)	Scheduled Calibration
Power Meter NRVD	102083	01-Nov-17 (CTTL, No.J17X08756)	Oct-18
Power sensor NRV-Z5	100542	01-Nov-17 (CTTL, No.J17X08756)	Oct-18
Reference Probe EX3DV4	SN 7464	12-Sep-17(SPEAG,No.EX3-7464_Sep17)	Sep-18
DAE4	SN 1524	13-Sep-17(SPEAG,No.DAE4-1524_Sep17)	Sep-18
Secondary Standards	ID #	Cal Date(Calibrated by, Certificate No.)	Scheduled Calibration
Signal Generator E4438C	MY49071430	23-Jan-18 (CTTL, No.J18X00560)	Jan-19
NetworkAnalyzer E5071C	MY46110673	24-Jan-18 (CTTL, No.J18X00561)	Jan-19

	Name	Function	Signature
Calibrated by:	Zhao Jing	SAR Test Engineer	
Reviewed by:	Lin Hao	SAR Test Engineer	
Approved by:	Qi Dianyuan	SAR Project Leader	

Issued: September 6, 2018

This calibration certificate shall not be reproduced except in full without written approval of the laboratory.

Certificate No: Z18-60339

Page 1 of 3



In Collaboration with
s p e a g
CALIBRATION LABORATORY

Add: No.51 Xueyuan Road, Haidian District, Beijing, 100191, China
Tel: +86-10-62304633-2079 Fax: +86-10-62304633-2504
E-mail: cttl@chinattl.com http://www.chinattl.cn

Glossary:

TSL	tissue simulating liquid
ConvF	sensitivity in TSL / NORM _{x,y,z}
N/A	not applicable or not measured

Calibration is Performed According to the Following Standards:

- IEEE Std 1528-2013, "IEEE Recommended Practice for Determining the Peak Spatial-Averaged Specific Absorption Rate (SAR) in the Human Head from Wireless Communications Devices: Measurement Techniques", June 2013
- IEC 62209-1, "Measurement procedure for assessment of specific absorption rate of human exposure to radio frequency fields from hand-held and body-mounted wireless communication devices- Part 1: Device used next to the ear (Frequency range of 300MHz to 6GHz)", July 2016
- IEC 62209-2, "Procedure to measure the Specific Absorption Rate (SAR) For wireless communication devices used in close proximity to the human body (frequency range of 30MHz to 6GHz)", March 2010
- KDB865664, SAR Measurement Requirements for 100 MHz to 6 GHz

Additional Documentation:

- DASY4/5 System Handbook

Methods Applied and Interpretation of Parameters:

- Measurement Conditions:** Further details are available from the Validation Report at the end of the certificate. All figures stated in the certificate are valid at the frequency indicated.
- Antenna Parameters with TSL:** The dipole is mounted with the spacer to position its feed point exactly below the center marking of the flat phantom section, with the arms oriented parallel to the body axis.
- Feed Point Impedance and Return Loss:** These parameters are measured with the dipole positioned under the liquid filled phantom. The impedance stated is transformed from the measurement at the SMA connector to the feed point. The Return Loss ensures low reflected power. No uncertainty required.
- Electrical Delay:** One-way delay between the SMA connector and the antenna feed point. No uncertainty required.
- SAR measured:** SAR measured at the stated antenna input power.
- SAR normalized:** SAR as measured, normalized to an input power of 1 W at the antenna connector.
- SAR for nominal TSL parameters:** The measured TSL parameters are used to calculate the nominal SAR result.

The reported uncertainty of measurement is stated as the standard uncertainty of Measurement multiplied by the coverage factor $k=2$, which for a normal distribution corresponds to a coverage probability of approximately 95%.



In Collaboration with
s p e a g
CALIBRATION LABORATORY

Add: No.51 Xueyuan Road, Haidian District, Beijing, 100191, China
Tel: +86-10-62304633-2079 Fax: +86-10-62304633-2504
E-mail: cttl@chinattl.com http://www.chinattl.cn

Measurement Conditions

DASY system configuration, as far as not given on page 1.

DASY Version	DASY52	52.10.1.1476
Extrapolation	Advanced Extrapolation	
Phantom	Triple Flat Phantom 5.1C	
Distance Dipole Center - TSL	10 mm	with Spacer
Zoom Scan Resolution	dx, dy, dz = 5 mm	
Frequency	2300 MHz \pm 1 MHz	

Head TSL parameters

The following parameters and calculations were applied.

	Temperature	Permittivity	Conductivity
Nominal Head TSL parameters	22.0 °C	39.5	1.67 mho/m
Measured Head TSL parameters	(22.0 \pm 0.2) °C	39.3 \pm 6 %	1.66 mho/m \pm 6 %
Head TSL temperature change during test	<1.0 °C	---	---

SAR result with Head TSL

SAR averaged over 1 cm^3 (1 g) of Head TSL	Condition	
SAR measured	250 mW input power	12.2 mW / g
SAR for nominal Head TSL parameters	normalized to 1W	49.1 mW / g \pm 18.8 % (k=2)
SAR averaged over 10 cm^3 (10 g) of Head TSL	Condition	
SAR measured	250 mW input power	5.90 mW / g
SAR for nominal Head TSL parameters	normalized to 1W	23.7 mW / g \pm 18.7 % (k=2)

Body TSL parameters

The following parameters and calculations were applied.

	Temperature	Permittivity	Conductivity
Nominal Body TSL parameters	22.0 °C	52.9	1.81 mho/m
Measured Body TSL parameters	(22.0 \pm 0.2) °C	52.3 \pm 6 %	1.82 mho/m \pm 6 %
Body TSL temperature change during test	<1.0 °C	---	---

SAR result with Body TSL

SAR averaged over 1 cm^3 (1 g) of Body TSL	Condition	
SAR measured	250 mW input power	12.3 mW / g
SAR for nominal Body TSL parameters	normalized to 1W	48.9 mW / g \pm 18.8 % (k=2)
SAR averaged over 10 cm^3 (10 g) of Body TSL	Condition	
SAR measured	250 mW input power	6.01 mW / g
SAR for nominal Body TSL parameters	normalized to 1W	24.0 mW / g \pm 18.7 % (k=2)



In Collaboration with
s p e a g
CALIBRATION LABORATORY

Add: No.51 Xueyuan Road, Haidian District, Beijing, 100191, China
Tel: +86-10-62304633-2079 Fax: +86-10-62304633-2504
E-mail: cti@chinattl.com http://www.chinattl.cn

Appendix (Additional assessments outside the scope of CNAS L0570)

Antenna Parameters with Head TSL

Impedance, transformed to feed point	48.8Ω- 3.32jΩ
Return Loss	- 29.0dB

Antenna Parameters with Body TSL

Impedance, transformed to feed point	44.9Ω- 2.75jΩ
Return Loss	- 24.3dB

General Antenna Parameters and Design

Electrical Delay (one direction)	1.036 ns
----------------------------------	----------

After long term use with 100W radiated power, only a slight warming of the dipole near the feedpoint can be measured.

The dipole is made of standard semirigid coaxial cable. The center conductor of the feeding line is directly connected to the second arm of the dipole. The antenna is therefore short-circuited for DC-signals. On some of the dipoles, small end caps are added to the dipole arms in order to improve matching when loaded according to the position as explained in the "Measurement Conditions" paragraph. The SAR data are not affected by this change. The overall dipole length is still according to the Standard. No excessive force must be applied to the dipole arms, because they might bend or the soldered connections near the feedpoint may be damaged.

Additional EUT Data

Manufactured by	SPEAG
-----------------	-------



In Collaboration with
s p e a g
CALIBRATION LABORATORY

Add: No.51 Xiaoyuan Road, Haidian District, Beijing, 100191, China
Tel: +86-10-62304633-2079 Fax: +86-10-62304633-2504
E-mail: cttl@chinattl.com http://www.chinattl.cn

DASY5 Validation Report for Head TSL

Date: 08.31.2018

Test Laboratory: CTTL, Beijing, China

DUT: Dipole 2300 MHz; Type: D2300V2; Serial: D2300V2 - SN: 1059

Communication System: UID 0, CW; Frequency: 2300 MHz; Duty Cycle: 1:1

Medium parameters used: $f = 2300$ MHz; $\sigma = 1.649$ S/m; $\epsilon_r = 39.34$; $\rho = 1000$ kg/m³

Phantom section: Center Section

DASY5 Configuration:

- Probe: EX3DV4 - SN7464; ConvF(8.4, 8.4, 8.4) @ 2300 MHz; Calibrated: 9/12/2017
- Sensor-Surface: 1.4mm (Mechanical Surface Detection)
- Electronics: DAE4 Sn1524; Calibrated: 9/13/2017
- Phantom: MFP_V5.1C ; Type: QD 000 P51CA; Serial: 1062
- Measurement SW: DASY52, Version 52.10 (1); SEMCAD X Version 14.6.11 (7439)

Dipole Calibration/Zoom Scan (7x7x7) (7x7x7)/Cube 0: Measurement grid: dx=5mm, dy=5mm, dz=5mm

Reference Value = 102.3 V/m; Power Drift = 0.05 dB

Peak SAR (extrapolated) = 24.2 W/kg

SAR(1 g) = 12.2 W/kg; SAR(10 g) = 5.9 W/kg

Maximum value of SAR (measured) = 19.9 W/kg

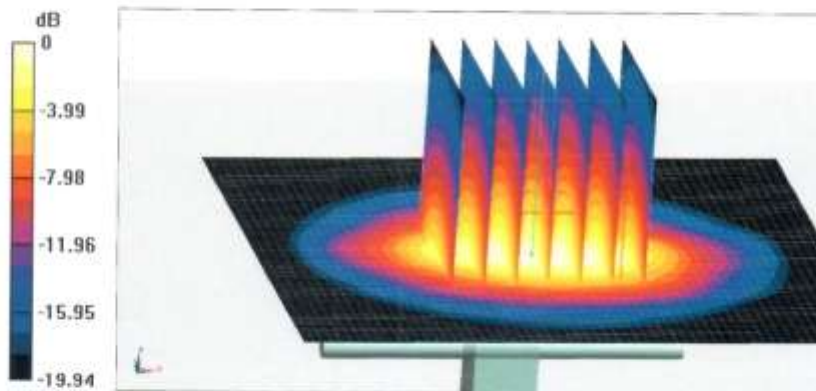

0 dB = 19.9 W/kg = 12.99 dBW/kg



In Collaboration with
s p e a g
CALIBRATION LABORATORY

Add: No.51 Xueyuan Road, Haidian District, Beijing, 100191, China
Tel: +86-10-62304633-2079 Fax: +86-10-62304633-2504
E-mail: cttl@chinattl.com http://www.chinattl.cn

Impedance Measurement Plot for Head TSL

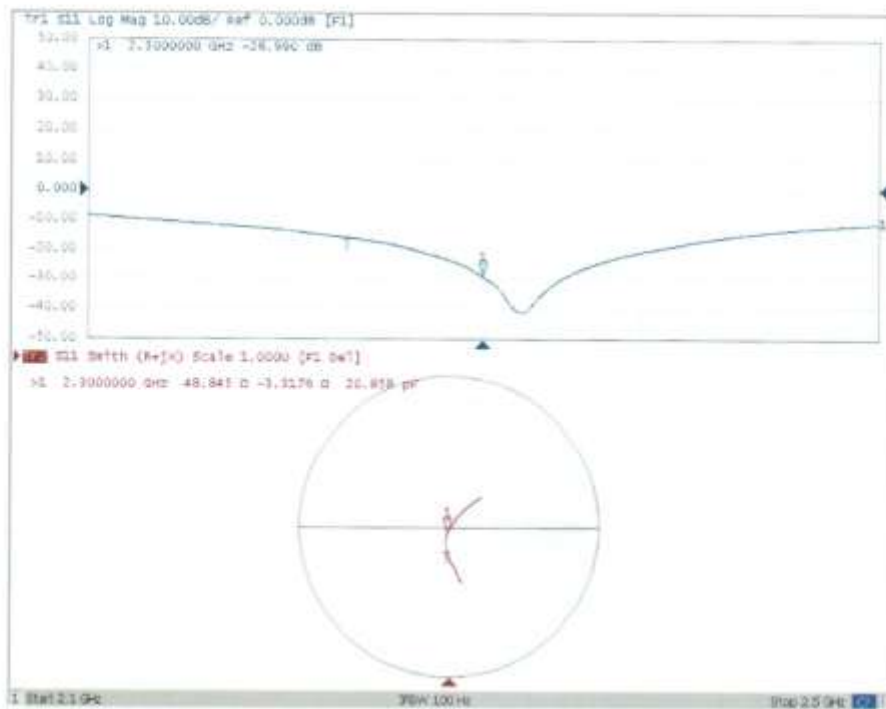



In Collaboration with
s p e a g
CALIBRATION LABORATORY

Add: No.51 Xueyuan Road, Haidian District, Beijing, 100191, China
Tel: +86-10-62304633-2079 Fax: +86-10-62304633-2504
E-mail: ttl@chinattl.com http://www.chinattl.cn

DASY5 Validation Report for Body TSL

Date: 09.03.2018

Test Laboratory: CTTL, Beijing, China

DUT: Dipole 2300 MHz; Type: D2300V2; Serial: D2300V2 - SN: 1059

Communication System: UID 0, CW; Frequency: 2300 MHz; Duty Cycle: 1:1

Medium parameters used: $f = 2300$ MHz; $\sigma = 1.822$ S/m; $\epsilon_r = 52.31$; $\rho = 1000$ kg/m³

Phantom section: Right Section

DASY5 Configuration:

- Probe: EX3DV4 - SN7464; ConvF(8.3, 8.3, 8.3) @ 2300 MHz; Calibrated: 9/12/2017
- Sensor-Surface: 1.4mm (Mechanical Surface Detection)
- Electronics: DAE4 Sn1524; Calibrated: 9/13/2017
- Phantom: MFP_V5.1C ; Type: QD 000 P51CA; Serial: 1062
- Measurement SW: DASY52, Version 52.10 (1); SEMCAD X Version 14.6.11 (7439)

Dipole Calibration/Zoom Scan (7x7x7) (7x7x7)/Cube 0; Measurement grid: dx=5mm, dy=5mm, dz=5mm

Reference Value = 97.25 V/m; Power Drift = 0.08 dB

Peak SAR (extrapolated) = 23.2 W/kg

SAR(1 g) = 12.3 W/kg; SAR(10 g) = 6.01 W/kg

Maximum value of SAR (measured) = 19.5 W/kg

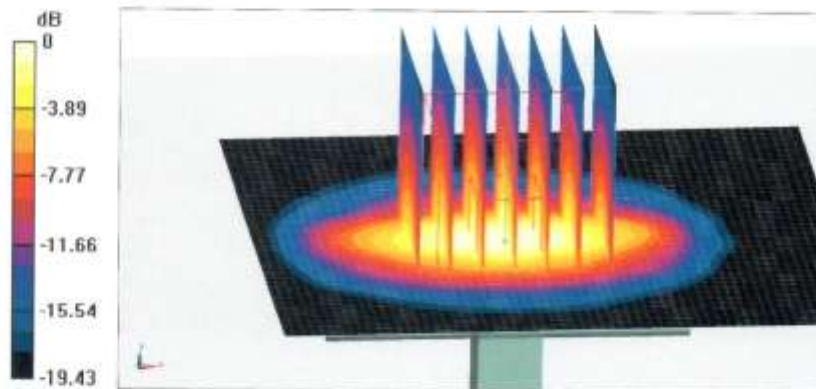

0 dB = 19.5 W/kg = 12.90 dBW/kg



In Collaboration with
s p e a g
CALIBRATION LABORATORY

Add: No.51 Xueyuan Road, Haidian District, Beijing, 100191, China
Tel: +86-10-62304633-2079 Fax: +86-10-62304633-2504
E-mail: ettl@chinattl.com http://www.chinattl.cn

Impedance Measurement Plot for Body TSL

