

MEASUREMENT REPORT

FCC PART 15.407 WLAN 802.11a/n/ac

FCC ID: 2AAC2-WL01

APPLICANT: Icomera AB

Application Type: Certification

Product: Icomera TraXside solution

Model No.: WL01

Brand Name: Icomera

FCC Classification: Unlicensed National Information Infrastructure (UNII)

FCC Rule Part(s): Part15 Subpart E (Section 15.407)

Test Procedure(s): ANSI C63.10-2013, KDB 789033 D02v02r01
KDB 662911 D01v02r01

Test Date: July 18 ~ August 07, 2019

Reviewed By:



(Jame Yuan)

Approved By:

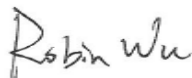

(Robin Wu)



The test results relate only to the samples tested.

This equipment has been shown to be capable of compliance with the applicable technical standards as indicated in the measurement report and was tested in accordance with the measurement procedures specified in KDB 789033 D02v02r01. Test results reported herein relate only to the item(s) tested.

The test report shall not be reproduced except in full without the written approval of MRT Technology (Suzhou) Co., Ltd.

Revision History

Report No.	Version	Description	Issue Date	Note
1906RSU020-U1	Rev. 01	Initial Report	08-10-2019	Valid

CONTENTS

Description	Page
1. INTRODUCTION	7
1.1. Scope	7
1.2. MRT Test Location	7
2. PRODUCT INFORMATION	8
2.1. Equipment Description.....	8
2.2. Product Specification Subjective to this Report.....	8
2.3. Working Frequencies for this report	9
2.4. Description of Available Antennas	10
2.5. Description of Antenna RF Port	11
2.6. Test Mode	11
2.7. Test Software	12
2.8. Device Capabilities	13
2.9. Test Configuration	15
2.10. EMI Suppression Device(s)/Modifications	15
2.11. Labeling Requirements.....	15
3. DESCRIPTION OF TEST	16
3.1. Evaluation Procedure	16
3.2. AC Line Conducted Emissions	16
3.3. Radiated Emissions.....	17
4. ANTENNA REQUIREMENTS.....	18
5. TEST EQUIPMENT CALIBRATION DATE.....	19
6. MEASUREMENT UNCERTAINTY.....	21
7. TEST RESULT	22
7.1. Summary	22
7.2. 26dB Bandwidth Measurement.....	23
7.2.1. Test Limit	23
7.2.2. Test Procedure Used	23
7.2.3. Test Setting.....	23
7.2.4. Test Setup	23
7.2.5. Test Result.....	24
7.3. 6dB Bandwidth Measurement.....	32
7.3.1. Test Limit	32
7.3.2. Test Procedure Used	32

7.3.3. Test Setting.....	32
7.3.4. Test Setup	32
7.3.5. Test Result.....	33
7.4. Output Power Measurement	38
7.4.1. Test Limit	38
7.4.2. Test Procedure Used	38
7.4.3. Test Setting.....	38
7.4.4. Test Setup	39
7.4.5. Test Result.....	40
7.5. Power Spectral Density Measurement	43
7.5.1. Test Limit	43
7.5.2. Test Procedure Used	43
7.5.3. Test Setting.....	43
7.5.4. Test Setup	44
7.5.5. Test Result.....	45
7.6. Frequency Stability Measurement.....	65
7.6.1. Test Limit	65
7.6.2. Test Procedure Used	65
7.6.3. Test Setup	66
7.6.4. Test Result.....	67
7.7. Radiated Spurious Emission Measurement	68
7.7.1. Test Limit	68
7.7.2. Test Procedure Used	68
7.7.3. Test Setting.....	68
7.7.4. Test Setup	70
7.7.5. Test Result.....	71
7.8. Radiated Restricted Band Edge Measurement	129
7.8.1. Test Limit	129
7.8.2. Test Procedure Used	130
7.8.3. Test Setting.....	130
7.8.4. Test Setup	131
7.8.5. Test Result.....	132
7.9. AC Conducted Emissions Measurement.....	178
7.9.1. Test Limit	178
7.9.2. Test Setup	178
7.9.3. Test Result.....	179
8. CONCLUSION.....	181
Appendix A - Test Setup Photograph	182



Appendix B - EUT Photograph..... 183

§2.1033 General Information

Applicant:	Icomera AB
Applicant Address:	Odinsgatan 28, SE-411 03 Gothenborg, Sweden
Manufacturer:	Icomera AB
Manufacturer Address:	Odinsgatan 28, SE-411 03 Gothenborg, Sweden
Test Site:	MRT Technology (Suzhou) Co., Ltd
Test Site Address:	D8 Building, No.2 Tian'edang Rd., Wuzhong Economic Development Zone, Suzhou, China
Test Device Serial No.:	N/A <input type="checkbox"/> Production <input checked="" type="checkbox"/> Pre-Production <input type="checkbox"/> Engineering

Test Facility / Accreditations

Measurements were performed at MRT Laboratory located in Tian'edang Rd., Suzhou, China.

- MRT facility is a FCC registered (MRT Reg. No. 893164) test facility with the site description report on file and has met all the requirements specified in ANSI C63.4-2014.
- MRT facility is an IC registered (MRT Reg. No. 11384A-1) test laboratory with the site description on file at Industry Canada.
- MRT facility is a VCCI registered (R-20025, G-20034, C-20020, T-20020) test laboratory with the site description on file at VCCI Council.
- MRT Lab is accredited to ISO 17025 by the American Association for Laboratory Accreditation (A2LA) under the American Association for Laboratory Accreditation Program (A2LA Cert. No. 3628.01) in EMC, Telecommunications, Radio and SAR testing.



1. INTRODUCTION

1.1. Scope

Measurement and determination of electromagnetic emissions (EMC) of radio frequency devices including intentional and/or unintentional radiators for compliance with the technical rules and regulations of the Federal Communications Commission and the Innovation, Science and Economic Development Canada and Certification and Engineering Bureau.

1.2. MRT Test Location

The map below shows the location of the MRT LABORATORY, its proximity to the Taihu Lake. These measurement tests were conducted at the MRT Technology (Suzhou) Co., Ltd. Facility located at D8 Building, No.2 Tian'edang Rd., Wuzhong Economic Development Zone, Suzhou, China. The measurement facility compliant with the test site requirements specified in ANSI C63.4-2014.



2. PRODUCT INFORMATION

2.1. Equipment Description

Product Name	Icomera TraXside solution
Model No.	WL01
Brand Name	Icomera
Wi-Fi Specification	802.11a/n/ac
Operating Temperature	-20 ~ 70 °C
Power Type	POE input (Power range: 37 ~ 57 Vdc)

Note1: Configuration for FCC Certification (Type 02): Host board (BBD 0009) and 2 * 5GHz WiFi Modules, M/N: TR-1X. WiFi Module 1 operating in UNII Band 1, WiFi Module 2 operating in UNII Band 3.

2.2. Product Specification Subjective to this Report

Frequency Range	For 802.11a/n-HT20/ac-VHT20: 5180~5240MHz, 5745~5825MHz For 802.11n-HT40/ac-VHT40: 5190~5230MHz, 5755~5795MHz For 802.11ac-VHT80: 5210MHz, 5775MHz
Channel Number	For 802.11a/n-HT20/ac-VHT20: 9 For 802.11n-HT40/ac-VHT40: 4 For 802.11ac-VHT80: 2
Type of Modulation	802.11a/n/ac: OFDM
Data Rate	802.11a: 6/9/12/18/24/36/48/54Mbps 802.11n: up to 450Mbps 802.11ac: up to 1300Mbps

Note: For other features of this EUT, test report will be issued separately.

2.3. Working Frequencies for this report

802.11a/n-HT20/ac-VHT20

Channel	Frequency	Channel	Frequency	Channel	Frequency
36	5180 MHz	40	5200 MHz	44	5220 MHz
48	5240 MHz	149	5745 MHz	153	5765 MHz
157	5785 MHz	161	5805 MHz	165	5825 MHz

802.11n-HT40/ac-VHT40

Channel	Frequency	Channel	Frequency	Channel	Frequency
38	5190 MHz	46	5230 MHz	151	5755 MHz
159	5795 MHz	--	--	--	--

802.11ac-VHT80

Channel	Frequency	Channel	Frequency	Channel	Frequency
42	5210 MHz	155	5775 MHz	--	--

2.4. Description of Available Antennas

Antenna No.	Antenna Type	Frequency Band (GHz)	T _x Paths	Max Antenna Gain (dBi)	CDD Directional Gain (dBi)	
					For Power	For PSD
Antenna Configuration 1# (1 * Ant 1 + 1 * Ant 2)						
1	Patch Array	5	2	23	23	26.01
2	Patch Array	5	1	23		
Antenna Configuration 2# (3 * Ant 3)						
3	Monopole	5	1	12	12	15.01

Note:

- The EUT supports Cyclic Delay Diversity (CDD) mode, and CDD signals are correlated.
For CDD transmissions, directional gain is calculated as follows, $N_{ANT} = 2$, $N_{SS} = 1$.
If all antennas have the same gain, G_{ANT} , Directional gain = $G_{ANT} + \text{Array Gain}$, where Array Gain is as follows.
 - For power spectral density (PSD) measurements on all devices,
Array Gain = $10 \log (N_{ANT} / N_{SS})$ dB = 3.01;
 - For power measurements on IEEE 802.11 devices,
Array Gain = 0 dB for $N_{ANT} \leq 4$;
- The EUT doesn't support Beam-forming technology.
- Ant 1 has Cross-Polarized design, see the antenna specification for further details.
- Both antenna configurations had been accessed in this report.

2.5. Description of Antenna RF Port

Antenna RF Port						
Software Control Port	5.1GHz RF Port			5.8GHz RF Port		
	Ant 0	Ant 1	Ant 2	Ant 0	Ant 1	Ant 2

2.6. Test Mode

Test Mode	Mode 1: Transmit by 802.11a
	Mode 2: Transmit by 802.11n-HT20
	Mode 3: Transmit by 802.11n-HT40
	Mode 4: Transmit by 802.11ac-VHT20
	Mode 5: Transmit by 802.11ac-VHT40
	Mode 6: Transmit by 802.11ac-VHT80

2.7. Test Software

The test utility software used during testing was “artgui.exe”, and the version was “2.3”.

Power Parameter Value:

Test Mode	Test Frequency (MHz)	Power Parameter Value
802.11a	5180	21.5
	5220	21.5
	5240	21.5
	5745	26.5
	5785	27.0
	5825	26.5
802.11n-HT20	5180	22.0
	5220	22.5
	5240	22.0
	5745	26.5
	5785	27.0
	5825	27.5
802.11n-HT40	5190	24.0
	5230	24.5
	5755	27.0
	5795	27.5
802.11ac-VHT20	5180	22.0
	5220	22.0
	5240	22.0
	5745	26.5
	5785	27.0
	5825	27.5
802.11ac-VHT40	5190	24.0
	5230	24.5
	5755	27.0
	5795	27.5
802.11ac-VHT80	5210	25.5
	5775	27.0

2.8. Device Capabilities

This device contains the following capabilities:

5GHz WLAN (NII)

Note: 5GHz (NII) operation is possible in 20MHz, 40MHz and 80MHz channel bandwidths. The maximum achievable duty cycles for all modes were determined based on measurements performed on a spectrum analyzer in zero-span mode with RBW = 8MHz, VBW = 50MHz, and detector = average. The RBW and VBW were both greater than 50/T, where T is the minimum transmission duration, and the number of sweep points across T was greater than 100. The duty cycles are as follows:

Test Mode	Duty Cycle
802.11a	95.61%
802.11n-HT20	95.75%
802.11n-HT40	92.82%
802.11ac-VHT20	95.72%
802.11ac-VHT40	92.42%
802.11ac-VHT80	74.76%

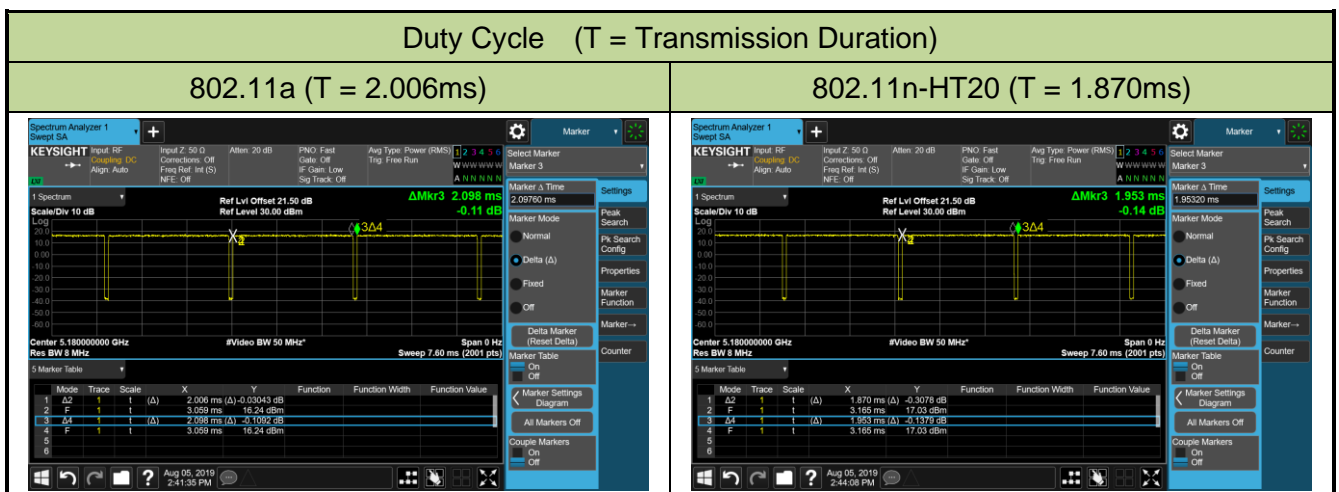

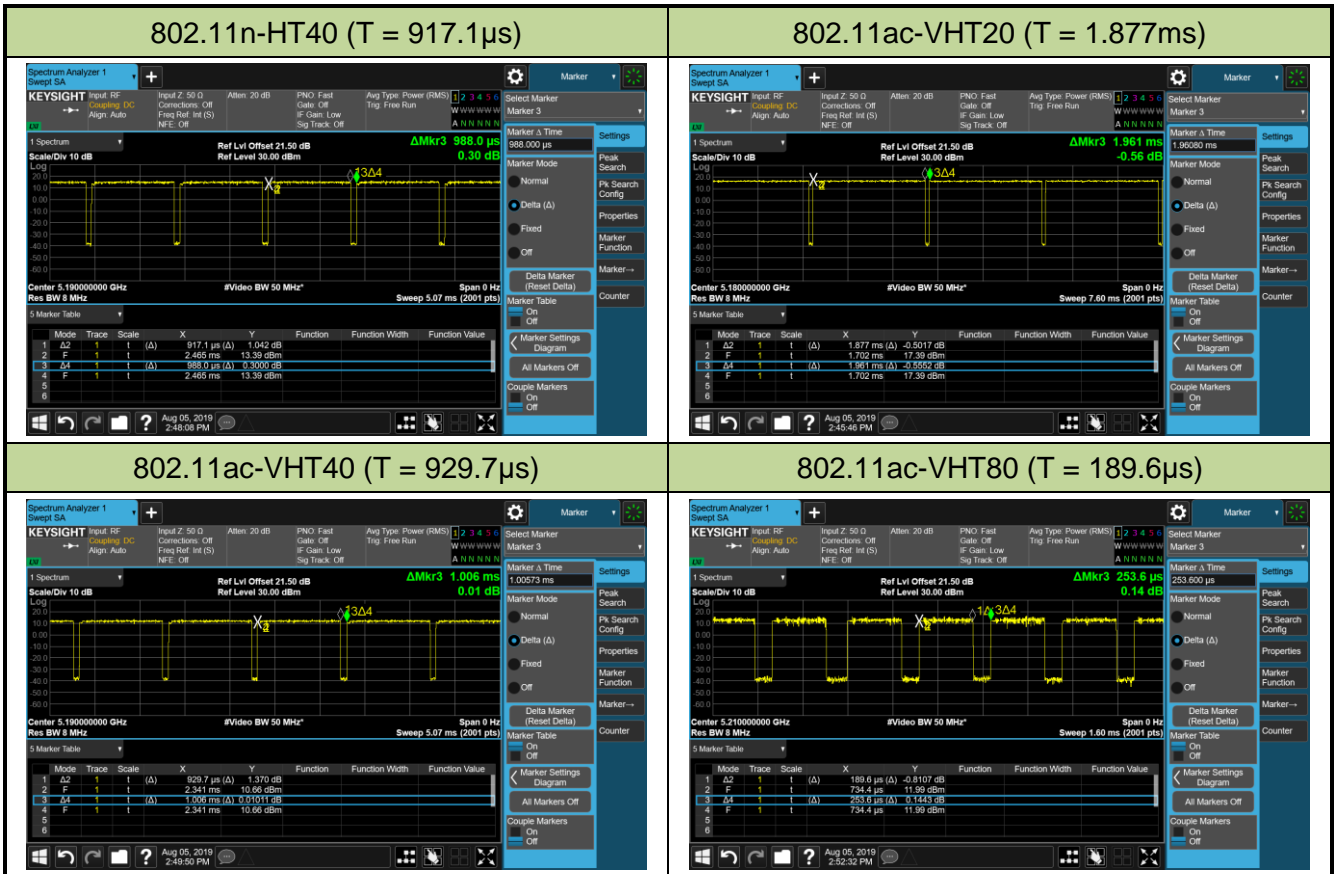

2.9. Test Configuration

The device was tested per the guidance of KDB 789033 D02v02r01. ANSI C63.10-2013 was used to reference the appropriate EUT setup for radiated spurious emissions testing and AC line conducted testing.

2.10. EMI Suppression Device(s)/Modifications

No EMI suppression device(s) were added and/or no modifications were made during testing.

2.11. Labeling Requirements

Per 2.1074 & 15.19; Docket 95-19

The label shall be permanently affixed at a conspicuous location on the device; instruction manual or pamphlet supplied to the user and be readily visible to the purchaser at the time of purchase. However, when the device is so small wherein placement of the label with specified statement is not practical, only the FCC ID must be displayed on the device per Section 15.19(a)(5). Please see attachment for FCC ID label and label location.

3. DESCRIPTION OF TEST

3.1. Evaluation Procedure

The measurement procedures described in the American National Standard of Procedures for Compliance Testing of Unlicensed Wireless Devices (ANSI C63.10-2013), and the guidance provided in KDB 789033 D02v02r01 were used in the measurement.

Deviation from measurement procedure.....None

3.2. AC Line Conducted Emissions

The line-conducted facility is located inside an 8'x4'x4' shielded enclosure. A 1m x 2m wooden table 80cm high is placed 40cm away from the vertical wall and 80cm away from the sidewall of the shielded room. Two 10kHz-30MHz, 50Ω/50uH Line-Impedance Stabilization Networks (LISNs) are bonded to the shielded room floor. Power to the LISNs is filtered by external high-current high-insertion loss power line filters. These filters attenuate ambient signal noise from entering the measurement lines. These filters are also bonded to the shielded enclosure.

The EUT is powered from one LISN and the support equipment is powered from the second LISN. All interconnecting cables more than 1 meter were shortened to a 1 meter length by non-inductive bundling (serpentine fashion) and draped over the back edge of the test table. All cables were at least 40cm above the horizontal reference ground-plane. Power cables for support equipment were routed down to the second LISN while ensuring that that cables were not draped over the second LISN.

Sufficient time for the EUT, support equipment, and test equipment was allowed in order for them to warm up to their normal operating condition. The RF output of the LISN was connected to the receiver and exploratory measurements were made to determine the frequencies producing the maximum emission from the EUT. The receiver was scanned from 150kHz to 30MHz. The detector function was set to peak mode for exploratory measurements while the bandwidth of the analyzer was set to 9kHz. The EUT, support equipment, and interconnecting cables were arranged and manipulated to maximize each emission. Each emission was also maximized by varying: power lines, the mode of operation or data exchange speed, or support equipment whichever determined the worst-case emission. Once the worst case emissions have been identified, the one EUT cable configuration/arrangement and mode of operation that produced these emissions are used for final measurements on the same test site. The analyzer is set to CISPR quasi-peak and average detectors with a 9kHz resolution bandwidth for final measurements.

An extension cord was used to connect to a single LISN which powered by EUT. The extension cord was calibrated with LISN, the impedance and insertion loss are compliance with the requirements as stated in ANSI C63.10-2013.

3.3. Radiated Emissions

The radiated test facilities consisted of an indoor 3 meter semi-anechoic chamber used for final measurements and exploratory measurements, when necessary. The measurement area is contained within the semi-anechoic chamber which is shielded from any ambient interference. For measurements above 1GHz absorbers are arranged on the floor between the turn table and the antenna mast in such a way so as to maximize the reduction of reflections. For measurements below 1GHz, the absorbers are removed. A MF Model 210SS turntable is used for radiated measurement. It is a continuously rotatable, remotecontrolled, metallic turntable and 2 meters (6.56 ft.) in diameter. The turn table is flush with the raised floor of the chamber in order to maintain its function as a ground plane. An 80cm high PVC support structure is placed on top of the turntable.

For all measurements, the spectrum was scanned through all EUT azimuths and from 1 to 4 meter receive antenna height using a broadband antenna from 30MHz up to the upper frequency shown in 15.33(b)(1) depending on the highest frequency generated or used in the device or on which the device operates or tunes. For frequencies above 1GHz, linearly polarized double ridge horn antennas were used. For frequencies below 30MHz, a calibrated loop antenna was used. When exploratory measurements were necessary, they were performed at 1 meter test distance inside the semi-anechoic chamber using broadband antennas, broadband amplifiers, and spectrum analyzers to determine the frequencies and modes producing the maximum emissions. Sufficient time for the EUT, support equipment, and test equipment was allowed in order for them to warm up to their normal operating condition. The test set-up for frequencies below 1GHz was placed on top of the 0.8 meter high, 1 x 1.5 meter table; and test set-up for frequencies 1-40GHz was placed on top of the 1.5 meter high, 1 x 1.5 meter table. The EUT, support equipment, and interconnecting cables were arranged and manipulated to maximize each emission. Appropriate precaution was taken to ensure that all emissions from the EUT were maximized and investigated. The system configuration, clock speed, mode of operation or video resolution, if applicable, turntable azimuth, and receive antenna height was noted for each frequency found.

Final measurements were made in the semi-anechoic chamber using calibrated, linearly polarized broadband and horn antennas. The test setup was configured to the setup that produced the worst case emissions. The spectrum analyzer was set to investigate all frequencies required for testing to compare the highest radiated disturbances with respect to the specified limits. The turntable containing the EUT was rotated through 360 degrees and the height of the receive antenna was varied 1 to 4 meters and stopped at the azimuth and height producing the maximum emission. Each emission was maximized by changing the orientation of the EUT through three orthogonal planes and changing the polarity of the receive antenna, whichever produced the worst-case emissions. According to 3dB Beam-Width of horn antenna, the horn antenna should be always directed to the EUT when rising height.

4. ANTENNA REQUIREMENTS

Excerpt from §15.203 of the FCC Rules/Regulations:

“An intentional radiator antenna shall be designed to ensure that no antenna other than that furnished by the responsible party can be used with the device. The use of a permanently attached antenna or of an antenna that uses a unique coupling to the intentional radiator shall be considered sufficient to comply with the provisions of this section.”

Conclusion:

The product is defined as the professional installation of equipment by the manufacturer, there is no necessary to comply with the requirement of §15.203.

5. TEST EQUIPMENT CALIBRATION DATE

Conducted Emissions - SR2

Instrument	Manufacturer	Type No.	Asset No.	Cali. Interval	Cali. Due Date
EMI Test Receiver	R&S	ESR3	MRTSUE06185	1 year	2020/04/15
Two-Line V-Network	R&S	ENV 216	MRTSUE06002	1 year	2020/06/13
Two-Line V-Network	R&S	ENV 216	MRTSUE06003	1 year	2020/06/13
Thermohygrometer	Testo	608-H1	MRTSUE06404	1 year	2019/08/14
Shielding Room	MIX-BEP	Chamber-SR2	MRTSUE06215	N/A	N/A

Radiated Disturbance - AC1

Instrument	Manufacturer	Type No.	Asset No.	Cali. Interval	Cali. Due Date
EMI Test Receiver	R&S	ESR7	MRTSUE06001	1 year	2019/08/13
PXA Signal Analyzer	Keysight	9030B	MRTSUE06395	1 year	2019/09/25
Loop Antenna	Schwarzbeck	FMZB 1519	MRTSUE06025	1 year	2019/11/09
Bilog Period Antenna	Schwarzbeck	VULB 9168	MRTSUE06172	1 year	2020/03/31
Broad Band Horn Antenna	Schwarzbeck	BBHA 9120D	MRTSUE06023	1 year	2019/10/19
Broad Band Horn Antenna	Schwarzbeck	BBHA 9170	MRTSUE06024	1 year	2019/12/17
Microwave System Amplifier	Agilent	83017A	MRTSUE06076	1 year	2019/11/16
Preamplifier	Schwarzbeck	BBV 9721	MRTSUE06121	1 year	2020/06/11
Thermohygrometer	Testo	608-H1	MRTSUE06403	1 year	2019/08/14
Anechoic Chamber	TDK	Chamber-AC1	MRTSUE06212	1 year	2020/04/30

Radiated Disturbance - AC2

Instrument	Manufacturer	Type No.	Asset No.	Cali. Interval	Cali. Due Date
Spectrum Analyzer	Keysight	N9038A	MRTSUE06125	1 year	2019/08/13
Loop Antenna	Schwarzbeck	FMZB 1519	MRTSUE06025	1 year	2019/11/09
Bilog Period Antenna	Schwarzbeck	VULB 9162	MRTSUE06022	1 year	2019/10/19
Horn Antenna	Schwarzbeck	BBHA9120D	MRTSUE06171	1 year	2019/11/09
Broad Band Horn Antenna	Schwarzbeck	BBHA 9170	MRTSUE06024	1 year	2019/12/17
Broadband Coaxial Preamplifier	Schwarzbeck	BBV 9718	MRTSUE06176	1 year	2019/11/16
Preamplifier	Schwarzbeck	BBV 9721	MRTSUE06121	1 year	2020/06/11
Temperature/Humidity Meter	Minggao	ETH529	MRTSUE06170	1 year	2019/12/13
Anechoic Chamber	RIKEN	Chamber-AC2	MRTSUE06213	1 year	2020/04/30

Conducted Test Equipment - TR3

Instrument	Manufacturer	Type No.	Asset No.	Cali. Interval	Cali. Due Date
EXA Signal Analyzer	Agilent	N9020A	MRTSUE06106	1 year	2020/04/15
EXA Signal Analyzer	Keysight	N9010B	MRTSUE06452	1 year	2020/07/11
Signal Analyzer	R&S	FSV40	MRTSUE06218	1 year	2020/04/15
Power Meter	Agilent	U2021XA	MRTSUE06030	1 year	2019/11/16
Bluetooth Test Set	Anritsu	MT8852B-042	MRTSUE06389	1 year	2020/06/13
Audio Analyzer	Agilent	U8903B	MRTSUE06143	1 year	2020/06/13
Modulation Analyzer	HP	8901A	MRTSUE06098	1 year	2019/10/18
DC Power Supply	GWINSTEK	DPS-3303C	MRTSUE06064	N/A	N/A
Temperature & Humidity Chamber	BAOYT	BYH-150CL	MRTSUE06051	1 year	2019/11/16
Thermohygrometer	testo	608-H1	MRTSUE06401	1 year	2019/08/14

Software	Version	Function
e3	V 8.3.5	EMI Test Software

6. MEASUREMENT UNCERTAINTY

Where relevant, the following test uncertainty levels have been estimated for tests performed on the EUT as specified in CISPR 16-4-2. This uncertainty represents an expanded uncertainty expressed at approximately the 95% confidence level using a coverage factor of $k = 2$.

Conducted Emission Measurement - SR2
<p>The maximum measurement uncertainty is evaluated as:</p> <p>9kHz~150kHz: 3.84dB</p> <p>150kHz~30MHz: 3.46dB</p>
Radiated Emission Measurement - AC1
<p>The maximum measurement uncertainty is evaluated as:</p> <p>Horizontal: 30MHz~300MHz: 4.07dB</p> <p style="padding-left: 40px;">300MHz~1GHz: 3.63dB</p> <p style="padding-left: 40px;">1GHz~18GHz: 4.16dB</p> <p>Vertical: 30MHz~300MHz: 4.18dB</p> <p style="padding-left: 40px;">300MHz~1GHz: 3.60dB</p> <p style="padding-left: 40px;">1GHz~18GHz: 4.76dB</p>
Radiated Emission Measurement - AC2
<p>The maximum measurement uncertainty is evaluated as:</p> <p>Horizontal: 30MHz~300MHz: 3.75dB</p> <p style="padding-left: 40px;">300MHz~1GHz: 3.53dB</p> <p style="padding-left: 40px;">1GHz~18GHz: 4.28dB</p> <p>Vertical: 30MHz~300MHz: 3.86dB</p> <p style="padding-left: 40px;">300MHz~1GHz: 3.53dB</p> <p style="padding-left: 40px;">1GHz~18GHz: 4.33dB</p>

7. TEST RESULT

7.1. Summary

FCC Section(s)	Test Description	Test Limit	Test Condition	Test Result	Reference
15.407(a)	26dB Bandwidth	N/A	Conducted	Pass	Section 7.2
15.407(e)	6dB Bandwidth	$\geq 500\text{kHz}$		Pass	Section 7.3
15.407(a)(1)(iii), (3)	Maximum Conducted Output Power	$\leq 1\text{W}$		Pass	Section 7.4
15.407(a)(1)(iii), (3)	Maximum Power Spectral Density	U-NII-1: $\leq 17\text{dBm/MHz}$ U-NII-3: $\leq 30\text{dBm}/500\text{kHz}$		Pass	Section 7.6
15.407(g)	Frequency Stability	N/A		Pass	Section 7.7
15.407(b)(1), (4)(i)	Undesirable Emissions	$\leq -27\text{dBm/MHz}$ EIRP Detail see section 7.9	Radiated	Pass	Section 7.8 Section 7.9
15.205, 15.209 15.407(b)(5), (6), (7)	General Field Strength Limits (Restricted Bands and Radiated Emission Limits)	Emissions in restricted bands must meet the radiated limits detailed in 15.209		Pass	
15.207	AC Conducted Emissions 150kHz-30MHz	$< \text{FCC } 15.207 \text{ limits}$	Line Conducted	Pass	Section 7.10

Notes:

- The analyzer plots shown in this section were all taken with a correction table loaded into the analyzer. The correction table was used to account for the losses of the cables and attenuators used as part of the system to connect the EUT to the analyzer at all frequencies of interest.
- All modes of operation and data rates were investigated. For radiated emission test, every axis (X, Y, Z) was also verified. The test results shown in the following sections represent the worst case emissions.

7.2. 26dB Bandwidth Measurement

7.2.1. Test Limit

N/A

7.2.2. Test Procedure Used

ANSI C63.10-2013 - Section 12.4.1

7.2.3. Test Setting

For 26dB Bandwidth Measurement

1. The analyzers' automatic bandwidth measurement capability was used to perform the 26dB bandwidth measurement. The "X" dB bandwidth parameter was set to $X = 26$. The automatic bandwidth measurement function also has the capability of simultaneously measuring the 99% occupied bandwidth. The bandwidth measurement was not influenced by any intermediated power nulls in the fundamental emission.
2. RBW = Approximately 1% of the emission bandwidth.
3. VBW \geq RBW.
4. Detector = Peak.
5. Trace mode = Max hold.

7.2.4. Test Setup

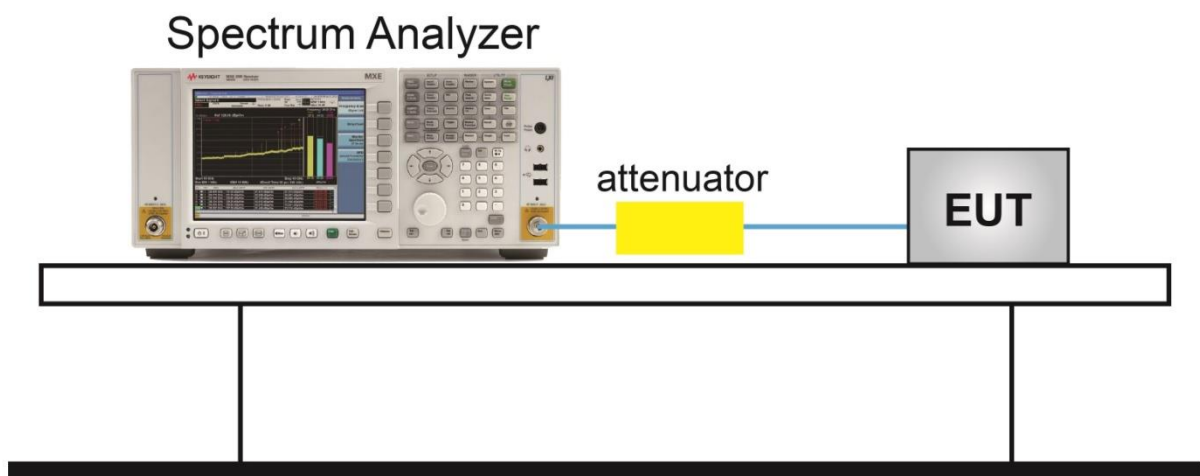

7.2.5. Test Result

Product	Icomera TraXside solution	Temperature	23°C
Test Engineer	Dandy Li	Relative Humidity	52%
Test Site	TR3	Test Date	2019/08/05
Test Item	26dB Bandwidth Measurement		

Test Mode	Data Rate/ MCS	Channel No.	Frequency (MHz)	26dB Bandwidth (MHz)	99% Bandwidth (MHz)
Ant 1 / Ant 0 + 1 + 2					
802.11a	6Mbps	36	5180	20.73	16.60
802.11a	6Mbps	44	5220	20.70	16.54
802.11a	6Mbps	48	5240	20.69	16.52
802.11a	6Mbps	149	5745	21.36	16.56
802.11a	6Mbps	157	5785	21.73	16.56
802.11a	6Mbps	165	5825	23.35	16.57
802.11n-HT20	MCS0	36	5180	21.62	17.70
802.11n-HT20	MCS0	44	5220	21.11	17.75
802.11n-HT20	MCS0	48	5240	21.70	17.68
802.11n-HT20	MCS0	149	5745	21.76	17.73
802.11n-HT20	MCS0	157	5785	22.26	17.82
802.11n-HT20	MCS0	165	5825	25.16	17.79
802.11n-HT40	MCS0	38	5190	42.83	36.41
802.11n-HT40	MCS0	46	5230	43.51	36.36
802.11n-HT40	MCS0	151	5755	41.29	36.13
802.11n-HT40	MCS0	159	5795	44.72	36.36
802.11ac-VHT20	MCS0	36	5180	21.60	17.74
802.11ac-VHT20	MCS0	44	5220	22.39	17.74
802.11ac-VHT20	MCS0	48	5240	21.21	17.71
802.11ac-VHT20	MCS0	149	5745	21.29	17.71
802.11ac-VHT20	MCS0	157	5785	24.19	17.77
802.11ac-VHT20	MCS0	165	5825	24.91	17.77
802.11ac-VHT40	MCS0	38	5190	42.70	36.34
802.11ac-VHT40	MCS0	46	5230	42.03	36.34
802.11ac-VHT40	MCS0	151	5755	41.65	36.21
802.11ac-VHT40	MCS0	159	5795	45.98	36.38

Test Mode	Data Rate/ MCS	Channel No.	Frequency (MHz)	26dB Bandwidth (MHz)	99% Bandwidth (MHz)
Ant 1 / Ant 0 + 1 + 2					
802.11ac-VHT80	MCS0	42	5210	86.03	75.93
802.11ac-VHT80	MCS0	155	5775	82.90	75.46

802.11a 26dB Bandwidth & 99% Bandwidth - Ant 1 / Ant 0 + 1 + 2

Channel 36 (5180MHz)

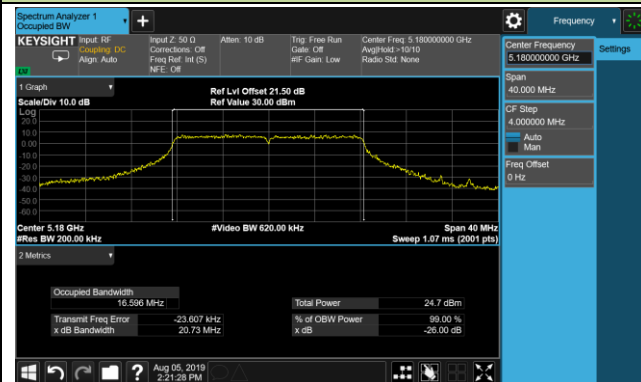

Channel 44 (5220MHz)

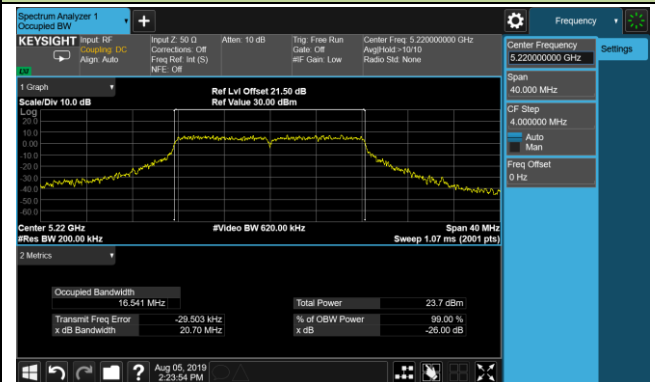

Channel 48 (5240MHz)

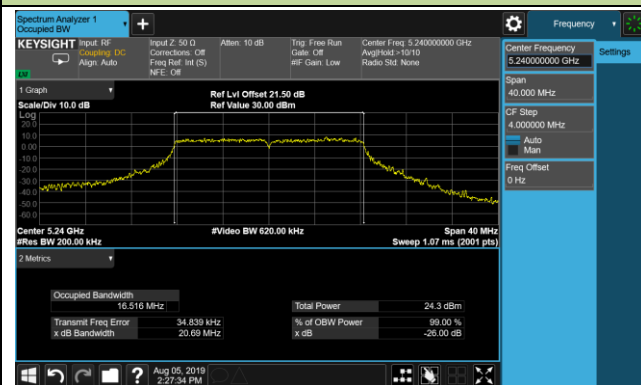

Channel 149 (5745MHz)

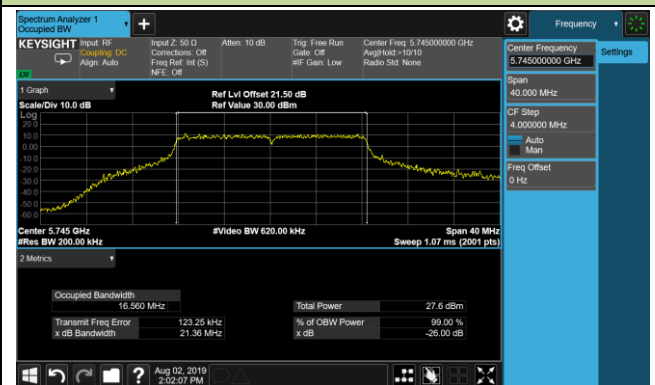

Channel 157 (5785MHz)

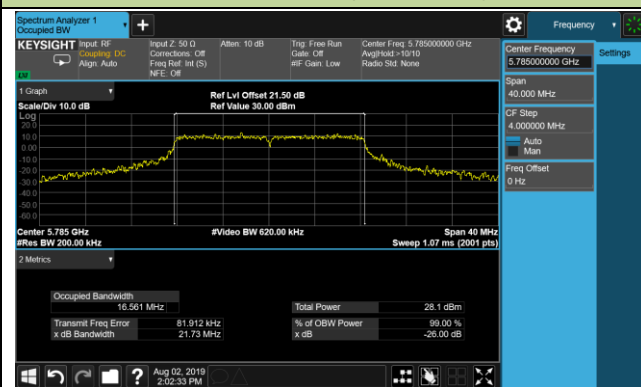

Channel 165 (5825MHz)

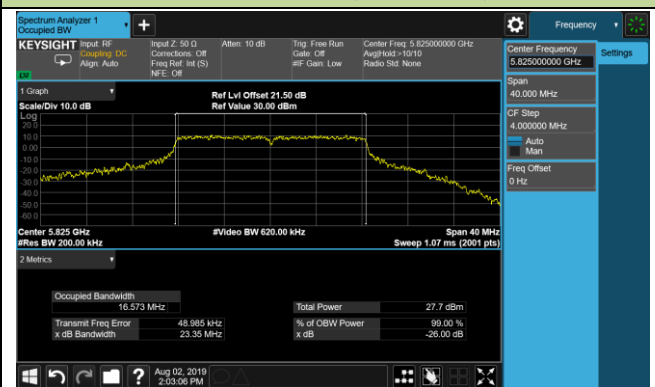

802.11n-HT20 26dB Bandwidth & 99% Bandwidth - Ant 1 / Ant 0 + 1 + 2

Channel 36 (5180MHz)

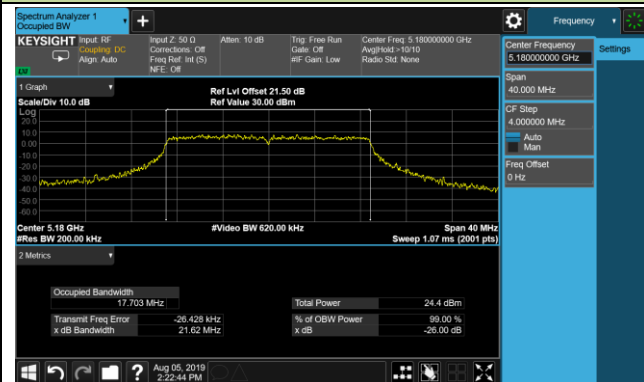

Channel 44 (5220MHz)

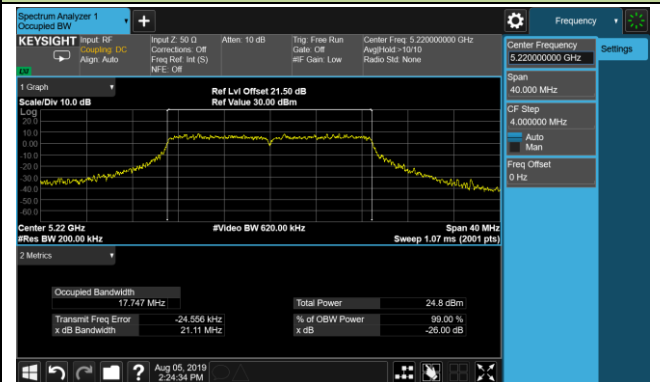

Channel 48 (5240MHz)

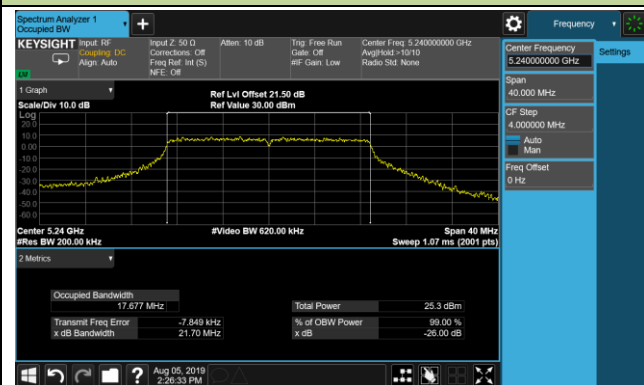

Channel 149 (5745MHz)

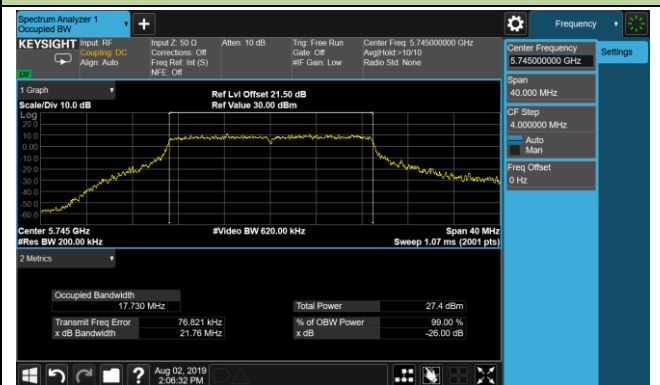

Channel 157 (5785MHz)



Channel 165 (5825MHz)



802.11n-HT40 26dB Bandwidth & 99% Bandwidth - Ant 1 / Ant 0 + 1 + 2

Channel 38 (5190MHz)

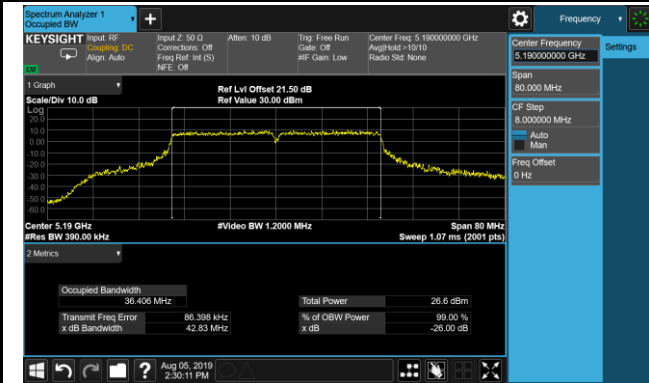

Channel 46 (5230MHz)

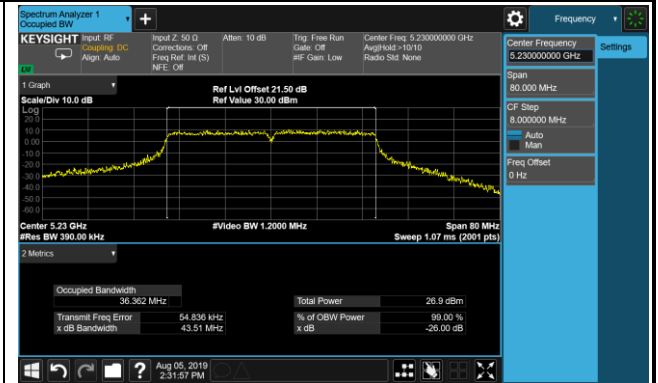

Channel 151 (5755MHz)



Channel 159 (5795MHz)

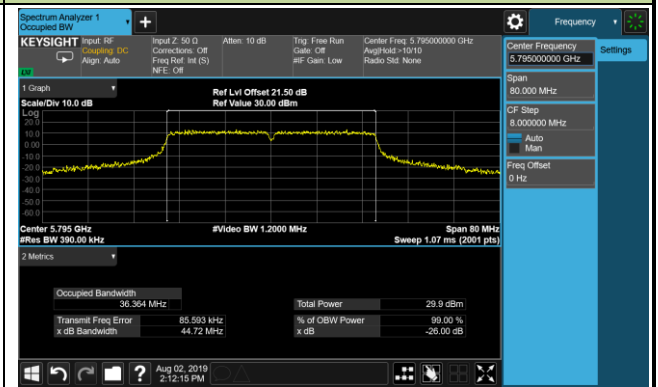

802.11ac-VHT20 26dB Bandwidth & 99% Bandwidth - Ant 1 / Ant 0 + 1 + 2

Channel 36 (5180MHz)

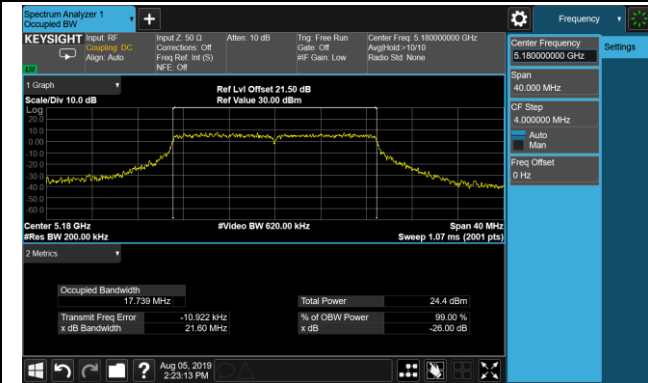

Channel 44 (5220MHz)

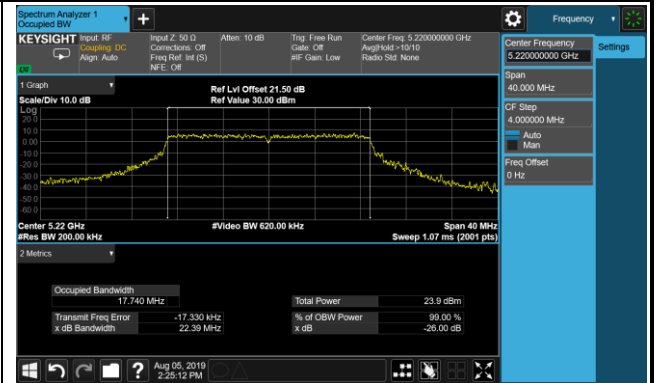

Channel 48 (5240MHz)

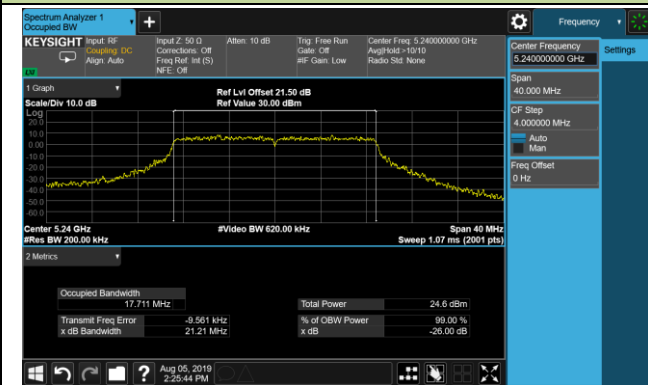

Channel 149 (5745MHz)

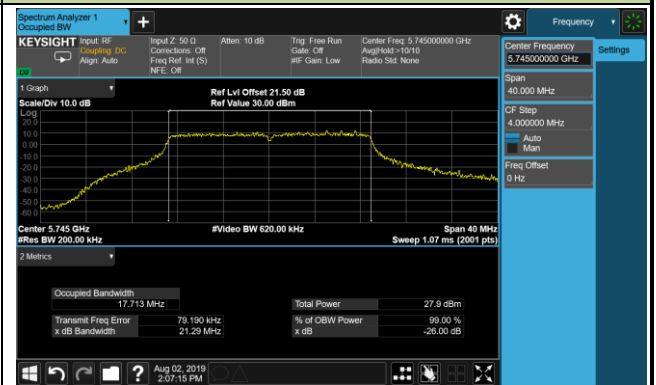

Channel 157 (5785MHz)

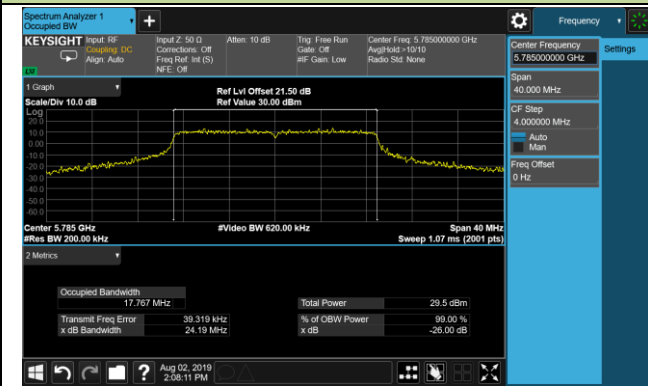

Channel 165 (5825MHz)

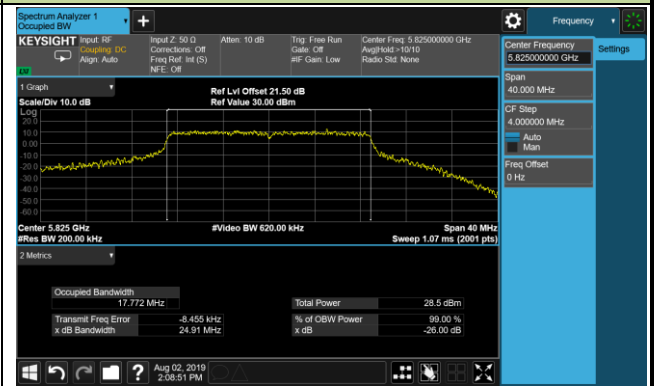

802.11ac-VHT40 26dB Bandwidth & 99% Bandwidth - Ant 1 / Ant 0 + 1 + 2

Channel 38 (5190MHz)

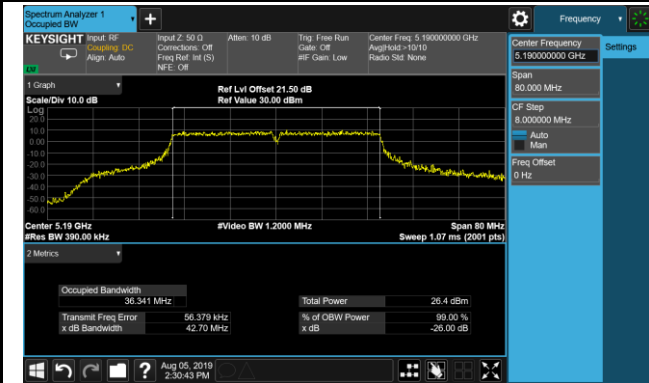

Channel 46 (5230MHz)

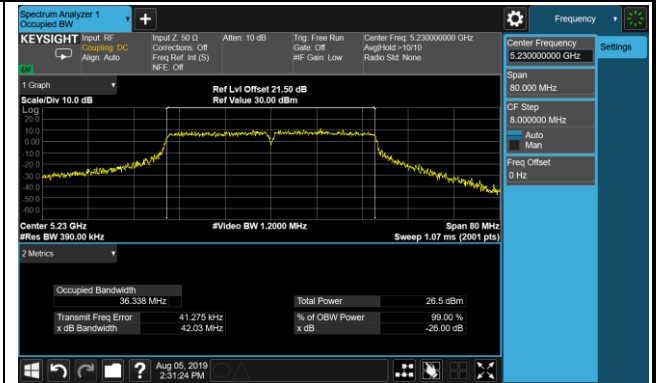

Channel 151 (5755MHz)



Channel 159 (5795MHz)

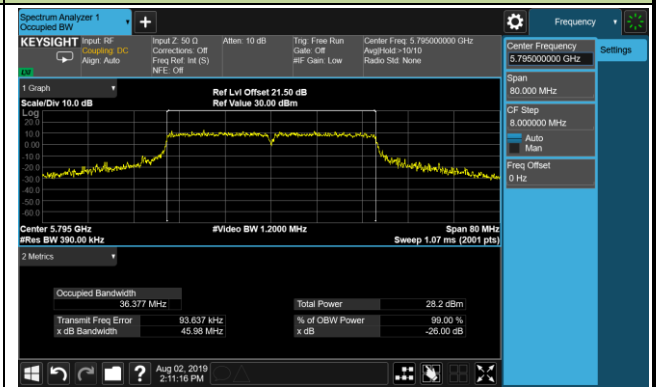

802.11ac-VHT80 26dB Bandwidth & 99% Bandwidth - Ant 1 / Ant 0 + 1 + 2

Channel 42 (5210MHz)

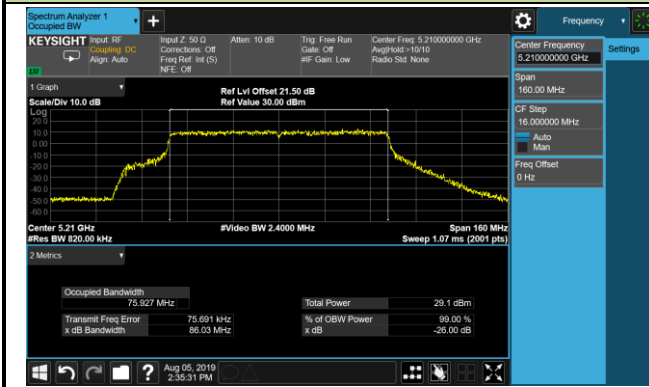

Channel 155 (5775MHz)

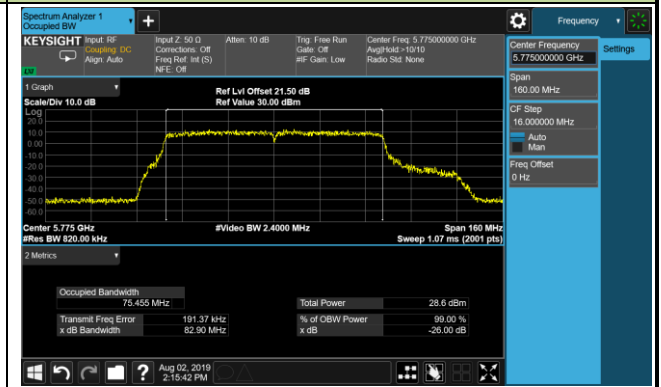

7.3. 6dB Bandwidth Measurement

7.3.1. Test Limit

The minimum 6dB bandwidth shall be at least 500 kHz.

7.3.2. Test Procedure Used

ANSI C63.10-2013 - Section 6.9.2

7.3.3. Test Setting

1. Set center frequency to the nominal EUT channel center frequency.
2. RBW = 100 kHz.
3. $VBW \geq 3 \times RBW$.
4. Detector = Peak.
5. Trace mode = max hold.
6. Sweep = auto couple.
7. Allow the trace to stabilize.
8. Measure the maximum width of the emission that is constrained by the frequencies associated with the two outermost amplitude points (upper and lower frequencies) that are attenuated by 6 dB relative to the maximum level measured in the fundamental emission.

7.3.4. Test Setup

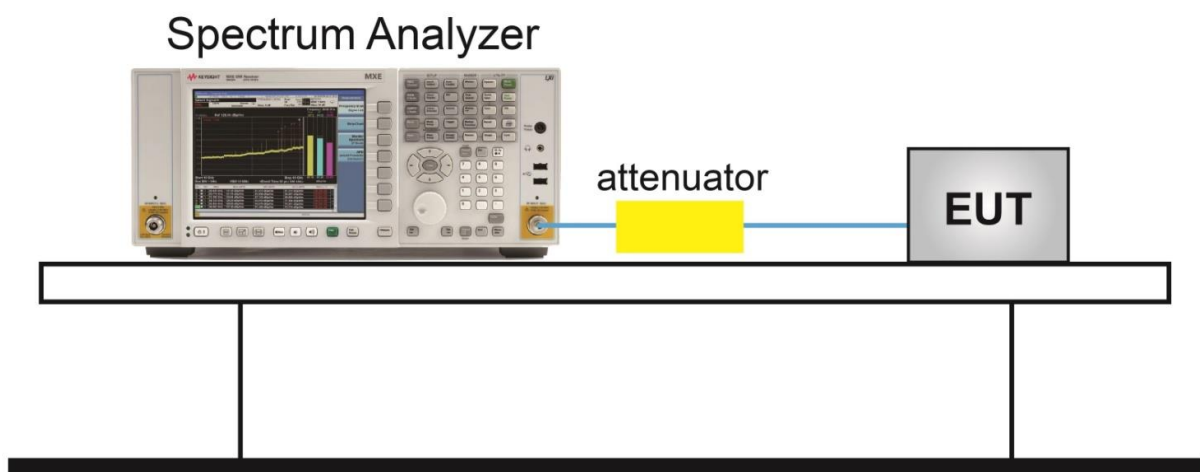

7.3.5. Test Result

Product	Icomera TraXside solution	Temperature	23°C
Test Engineer	Dandy Li	Relative Humidity	52%
Test Site	TR3	Test Date	2019/08/02
Test Item	6dB Bandwidth Measurement		

Test Mode	Data Rate/ MCS	Channel No.	Frequency (MHz)	6dB Bandwidth (MHz)	Limit (MHz)	Result
Ant 1 / Ant 0 + 1 + 2						
802.11a	6Mbps	149	5745	16.53	≥ 0.5	Pass
802.11a	6Mbps	157	5785	16.37	≥ 0.5	Pass
802.11a	6Mbps	165	5825	16.33	≥ 0.5	Pass
802.11n-HT20	MCS0	149	5745	15.65	≥ 0.5	Pass
802.11n-HT20	MCS0	157	5785	17.55	≥ 0.5	Pass
802.11n-HT20	MCS0	165	5825	17.58	≥ 0.5	Pass
802.11n-HT40	MCS0	151	5755	34.03	≥ 0.5	Pass
802.11n-HT40	MCS0	159	5795	36.03	≥ 0.5	Pass
802.11ac-VHT20	MCS0	149	5745	17.64	≥ 0.5	Pass
802.11ac-VHT20	MCS0	157	5785	17.05	≥ 0.5	Pass
802.11ac-VHT20	MCS0	165	5825	17.57	≥ 0.5	Pass
802.11ac-VHT40	MCS0	151	5755	35.06	≥ 0.5	Pass
802.11ac-VHT40	MCS0	159	5795	36.03	≥ 0.5	Pass
802.11ac-VHT80	MCS0	155	5775	72.58	≥ 0.5	Pass

802.11a 6dB Bandwidth - Ant 1 / Ant 0 + 1 + 2

Channel 149 (5745MHz)

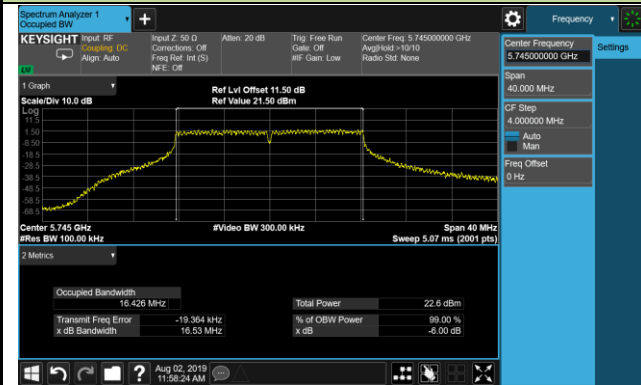

Channel 157 (5785MHz)

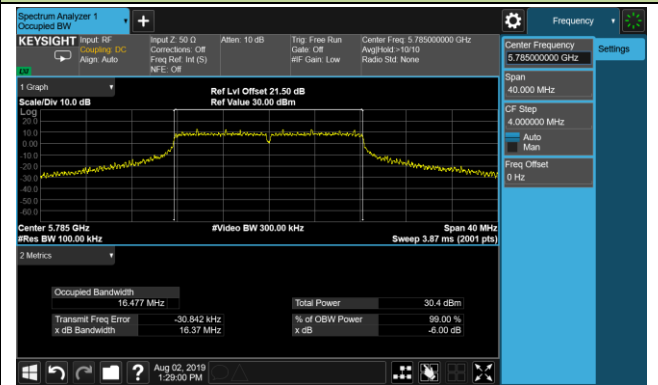

Channel 165 (5825MHz)

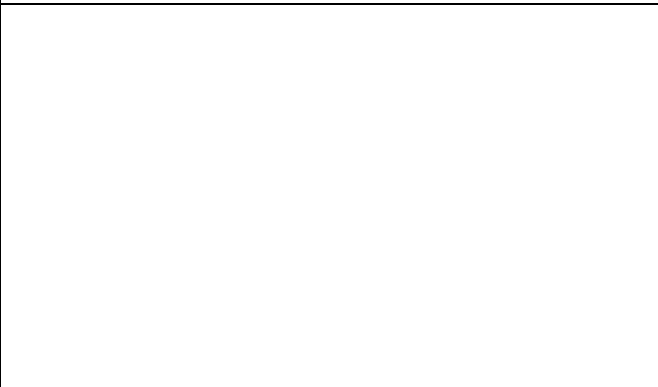
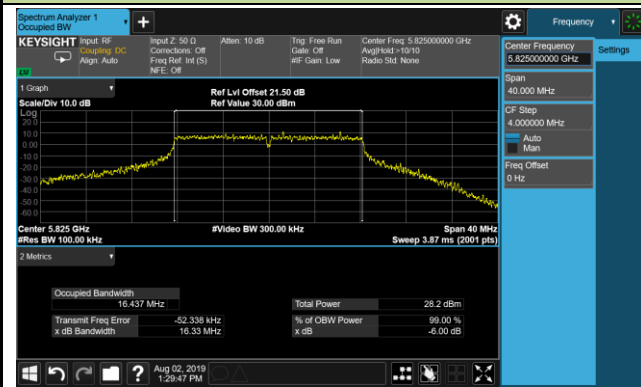

802.11n-HT20 6dB Bandwidth - Ant 1 / Ant 0 + 1 + 2

Channel 149 (5745MHz)

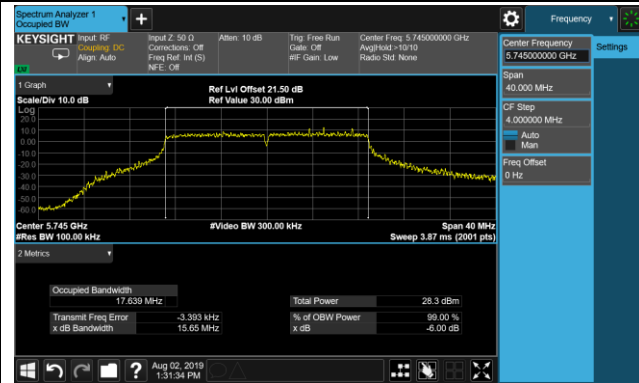

Channel 157 (5785MHz)

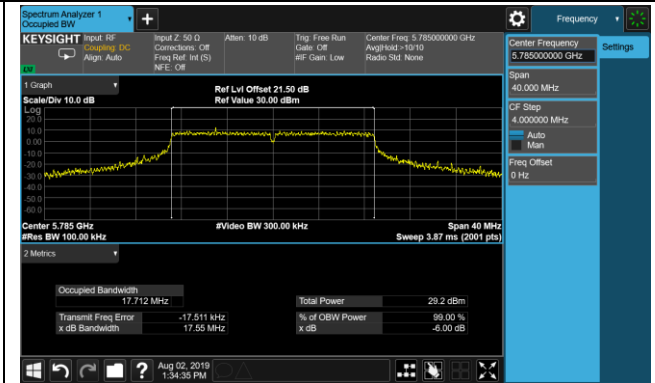

Channel 165 (5825MHz)

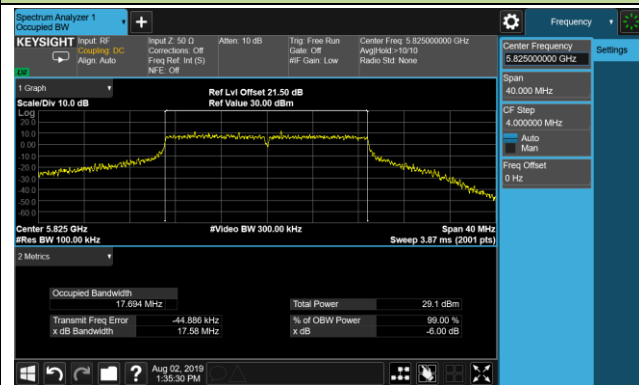

802.11n-HT40 6dB Bandwidth - Ant 1 / Ant 0 + 1 + 2

Channel 151 (5755MHz)

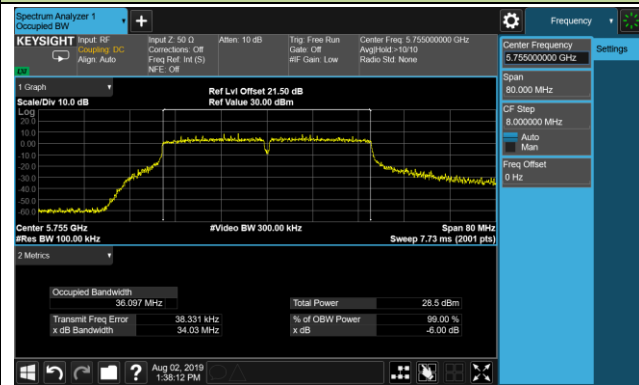

Channel 159 (5795MHz)

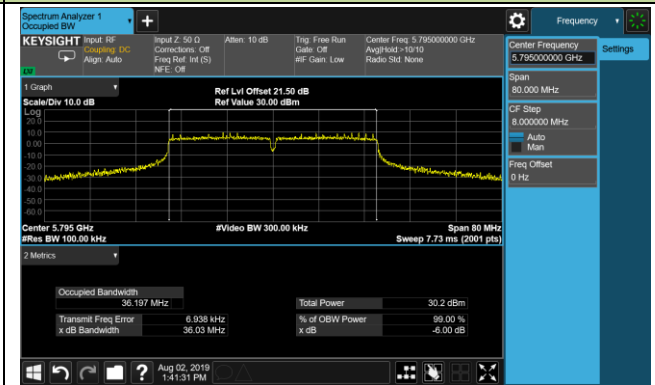

802.11ac-VHT20 6dB Bandwidth - Ant 1 / Ant 0 + 1 + 2

Channel 149 (5745MHz)

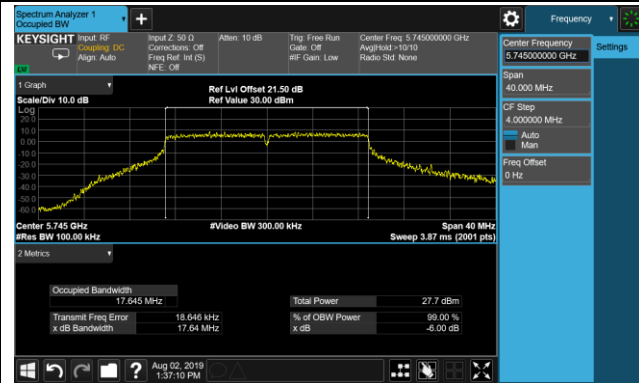

Channel 157 (5785MHz)

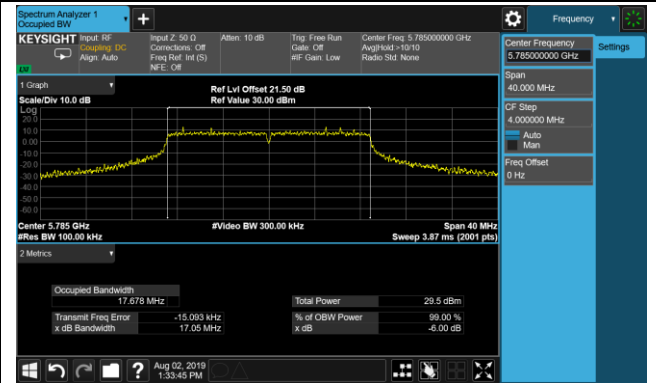

Channel 165 (5825MHz)

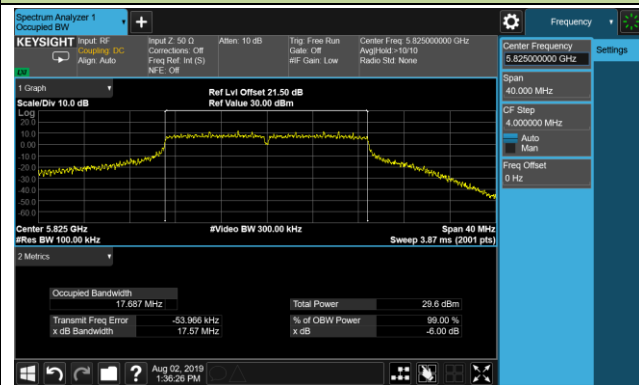

802.11ac-VHT40 6dB Bandwidth - Ant 1 / Ant 0 + 1 + 2

Channel 151 (5755MHz)

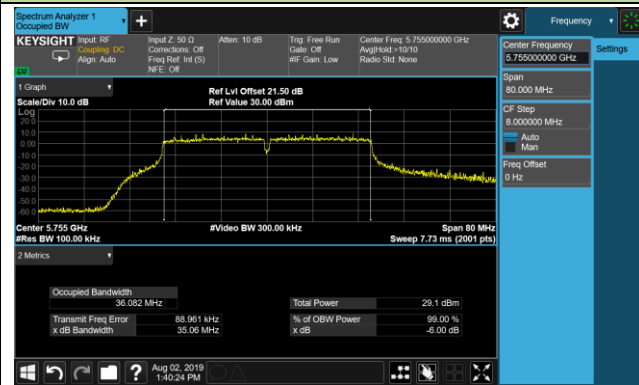

Channel 159 (5795MHz)

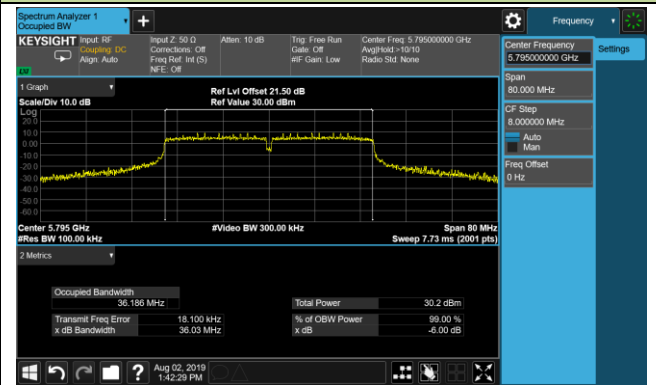

802.11ac-VHT80 6dB Bandwidth - Ant 1 / Ant 0 + 1 + 2

Channel 155 (5775MHz)

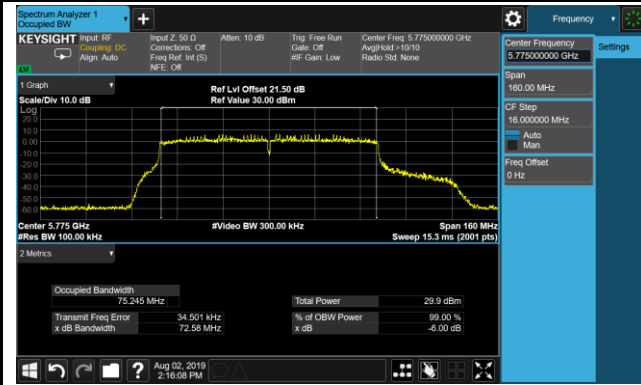

7.4. Output Power Measurement

7.4.1. Test Limit

For fixed point-to-point access points operating in the band 5.15-5.25 GHz, the maximum conducted output power over the frequency band of operation shall not exceed 1 W. Fixed point-to-point U-NII devices may employ antennas with directional gain up to 23 dBi without any corresponding reduction in the maximum conducted output power or maximum power spectral density. For fixed point-to-point transmitters that employ a directional antenna gain greater than 23 dBi, a 1 dB reduction in maximum conducted output power is required for each 1 dB of antenna gain in excess of 23 dBi. For the band 5.725-5.85 GHz, the maximum conducted output power over the frequency band of operation shall not exceed 1 W. If transmitting antennas of directional gain greater than 6 dBi are used, the maximum conducted output power shall be reduced by the amount in dB that the directional gain of the antenna exceeds 6 dBi. However, fixed point-to-point U-NII devices operating in this band may employ transmitting antennas with directional gain greater than 6 dBi without any corresponding reduction in transmitter conducted power.

7.4.2. Test Procedure Used

ANSI C63.10-2013 - Section 12.3.3.2 Method PM-G

7.4.3. Test Setting

Average power measurements were performed only when the EUT was transmitting at its maximum power control level using a broadband power meter with a pulse sensor. The power meter implemented triggering and gating capabilities which were set up such that power measurements were recorded only during the ON time of the transmitter. The trace was averaged over 100 traces to obtain the final measured average power.

7.4.4. Test Setup

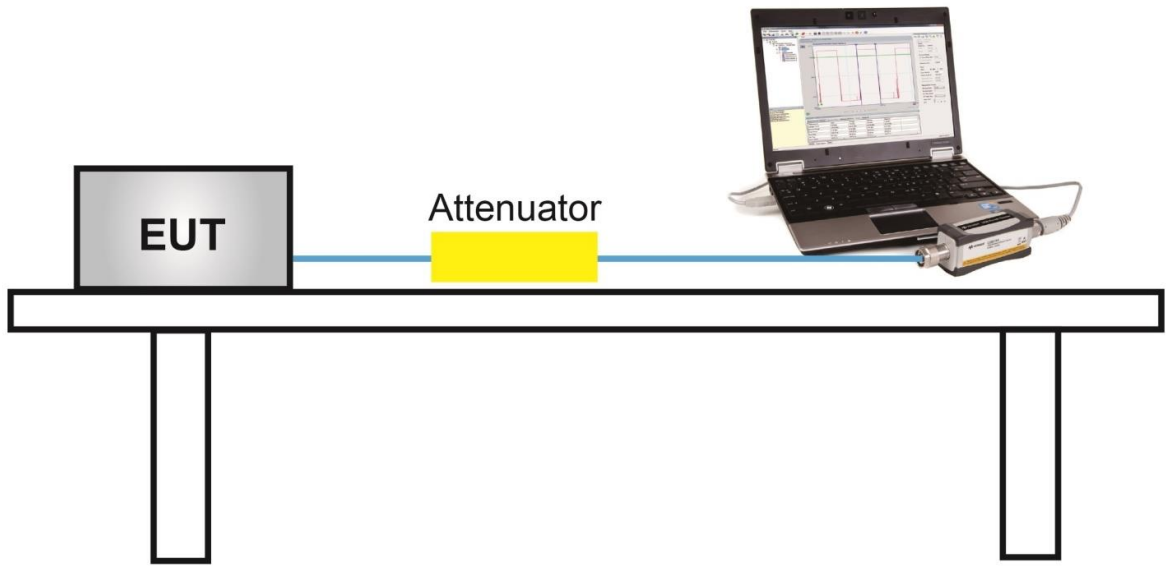

7.4.5. Test Result

Power output test was verified over all data rates of each mode shown as below table, and then choose the maximum power output (gray marker) for final test of each channel.

Output power at various data rates:

Test Mode	Bandwidth	Channel No.	Frequency (MHz)	Data Rate/ MCS	Average Power (dBm)
802.11a	20	36	5180	6Mbps	20.14
				24Mbps	19.89
				54Mbps	19.72
802.11n	20	36	5180	MCS0	20.89
				MCS4	20.82
				MCS7	20.71
802.11n	40	38	5190	MCS0	22.18
				MCS4	22.12
				MCS7	21.96
802.11ac	20	36	5180	MCS0	20.75
				MCS4	20.63
				MCS8	20.34
802.11ac	40	38	5190	MCS0	21.95
				MCS4	21.71
				MCS9	21.42
802.11ac	80	42	5210	MCS0	22.16
				MCS4	21.92
				MCS9	21.77



Product	Icomera TraXside solution	Temperature	23°C
Test Engineer	Dandy Li	Relative Humidity	52%
Test Site	TR3	Test Date	2019/07/18
Test Item	Output Power		

Test Mode	Data Rate/MCS	Channel No.	Frequency (MHz)	Ant 0 Average Power (dBm)	Ant 1 Average Power (dBm)	Ant 2 Average Power (dBm)	Total Average Power (dBm)	Average Power Limit (dBm)	Result
11a	6Mbps	36	5180	19.68	20.14	20.07	24.74	≤ 30.00	Pass
11a	6Mbps	44	5220	18.94	19.90	19.48	24.23	≤ 30.00	Pass
11a	6Mbps	48	5240	18.75	20.21	19.78	24.39	≤ 30.00	Pass
11a	6Mbps	149	5745	21.74	22.26	21.18	26.52	≤ 30.00	Pass
11a	6Mbps	157	5785	21.98	22.41	23.18	27.32	≤ 30.00	Pass
11a	6Mbps	165	5825	21.38	21.77	22.74	26.77	≤ 30.00	Pass
11n-HT20	MCS0	36	5180	20.02	20.89	20.22	25.16	≤ 30.00	Pass
11n-HT20	MCS0	44	5220	20.14	20.76	20.34	25.19	≤ 30.00	Pass
11n-HT20	MCS0	48	5240	19.30	20.53	20.01	24.75	≤ 30.00	Pass
11n-HT20	MCS0	149	5745	22.15	22.08	22.46	27.00	≤ 30.00	Pass
11n-HT20	MCS0	157	5785	22.13	22.41	23.52	27.50	≤ 30.00	Pass
11n-HT20	MCS0	165	5825	21.64	21.34	23.45	27.02	≤ 30.00	Pass
11n-HT40	MCS0	38	5190	21.45	22.18	21.30	26.43	≤ 30.00	Pass
11n-HT40	MCS0	46	5230	21.90	22.31	21.49	26.68	≤ 30.00	Pass
11n-HT40	MCS0	151	5755	22.70	22.27	22.38	27.23	≤ 30.00	Pass
11n-HT40	MCS0	159	5795	22.20	22.39	23.25	27.41	≤ 30.00	Pass
11ac-VHT20	MCS0	36	5180	20.23	20.75	20.27	25.19	≤ 30.00	Pass
11ac-VHT20	MCS0	44	5220	19.46	20.43	19.83	24.70	≤ 30.00	Pass
11ac-VHT20	MCS0	48	5240	19.36	20.53	20.01	24.76	≤ 30.00	Pass
11ac-VHT20	MCS0	149	5745	22.15	22.24	22.51	27.07	≤ 30.00	Pass
11ac-VHT20	MCS0	157	5785	22.65	22.85	22.44	27.42	≤ 30.00	Pass
11ac-VHT20	MCS0	165	5825	22.33	21.61	22.98	27.11	≤ 30.00	Pass
11ac-VHT40	MCS0	38	5190	21.60	21.95	20.93	26.28	≤ 30.00	Pass
11ac-VHT40	MCS0	46	5230	21.29	22.16	21.23	26.35	≤ 30.00	Pass
11ac-VHT40	MCS0	151	5755	22.47	21.97	21.77	26.85	≤ 30.00	Pass
11ac-VHT40	MCS0	159	5795	22.09	21.97	22.54	26.98	≤ 30.00	Pass
11ac-VHT80	MCS0	42	5210	22.04	22.16	21.41	26.65	≤ 30.00	Pass
11ac-VHT80	MCS0	155	5775	14.21	12.47	12.39	17.88	≤ 30.00	Pass

Note: Total Average Power (dBm) = $10 \cdot \log \{10^{(\text{Ant 0 Average Power} / 10)} + 10^{(\text{Ant 1 Average Power} / 10)} + 10^{(\text{Ant 2 Average Power} / 10)}\}$
(dBm).

7.5. Power Spectral Density Measurement

7.5.1. Test Limit

For fixed point-to-point access points operating in the band 5.15-5.25 GHz, the maximum power spectral density shall not exceed 17dBm in any 1 megahertz band. Fixed point-to-point U-NII devices may employ antennas with directional gain up to 23 dBi without any corresponding reduction in maximum power spectral density. For fixed point-to-point transmitters that employ a directional antenna gain greater than 23 dBi, a 1 dB reduction in maximum power spectral density is required for each 1 dB of antenna gain in excess of 23 dBi.

For the band 5.725-5.85 GHz, the maximum power spectral density shall not exceed 30 dBm in any 500-kHz band. If transmitting antennas of directional gain greater than 6 dBi are used, the maximum power spectral density shall be reduced by the amount in dB that the directional gain of the antenna exceeds 6 dBi. However, fixed point-to-point U-NII devices operating in this band may employ transmitting antennas with directional gain greater than 6 dBi without any corresponding reduction in maximum power spectral density.

7.5.2. Test Procedure Used

ANSI C63.10 - Section 12.5

7.5.3. Test Setting

1. Analyzer was set to the center frequency of the UNII channel under investigation
2. Span was set to encompass the entire 26dB EBW of the signal.
3. RBW = 1MHz, if measurement bandwidth of Maximum PSD is specified in 500 kHz,
RBW = 100 kHz
4. VBW = 3MHz
5. Number of sweep points $\geq 2 \times (\text{span} / \text{RBW})$
6. Detector = power averaging (Average)
7. Sweep time = auto
8. Trigger = free run
9. Use the peak search function on the instrument to find the peak of the spectrum and record its value.

10. Add $10 \cdot \log(1/x)$, where x is the duty cycle, to the measured power in order to compute the average power during the actual transmission times (because the measurement represents an average over both the on and off times of the transmission). For example, add $10 \cdot \log(1/0.25) = 6$ dB if the duty cycle is 25 percent.
11. When the measurement bandwidth of Maximum PSD is specified in 500 kHz, add a constant factor $10 \cdot \log(500\text{kHz}/100\text{kHz}) = 6.99$ dB to the measured result.

7.5.4. Test Setup

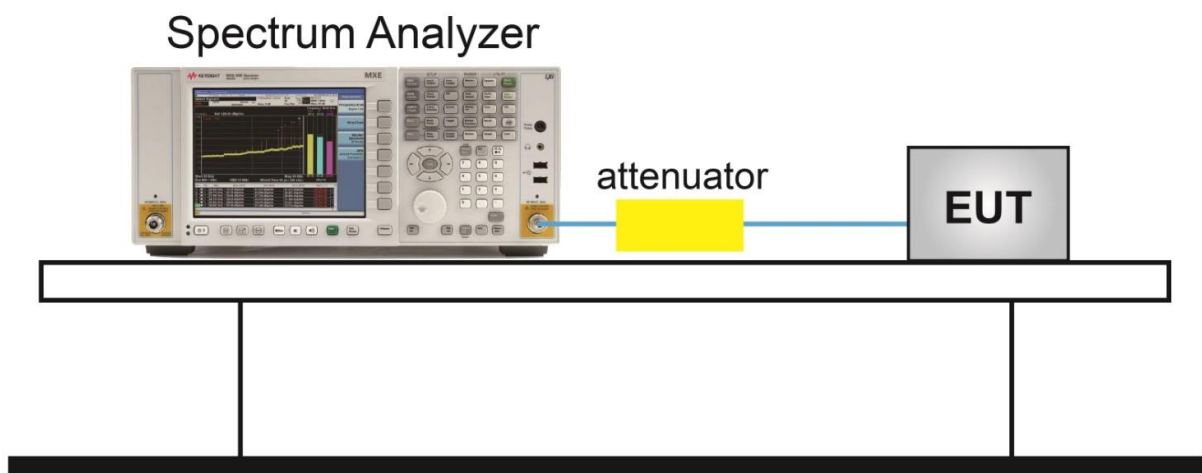

7.5.5. Test Result

Product	Icomera TraXside solution	Temperature	23°C
Test Engineer	Dandy Li	Relative Humidity	52%
Test Site	TR3	Test Date	2019/08/01 ~ 2019/08/04
Test Item	Power Spectral Density (UNII-Band 1)		

Test Mode	Data Rate/ MCS	Channel	Frequency (MHz)	Ant 0 PSD (dBm/ MHz)	Ant 1 PSD (dBm/ MHz)	Ant 2 PSD (dBm/ MHz)	Duty Cycle (%)	Total PSD (dBm/ MHz)	PSD Limit (dBm/ MHz)	Result
11a	6Mbps	36	5180	8.45	8.95	8.52	95.61	13.61	≤ 13.99	Pass
11a	6Mbps	44	5220	7.75	8.51	8.68	95.61	13.30	≤ 13.99	Pass
11a	6Mbps	48	5240	7.62	9.20	8.82	95.61	13.56	≤ 13.99	Pass
11n-HT20	MCS0	36	5180	8.61	9.21	8.67	95.75	13.80	≤ 13.99	Pass
11n-HT20	MCS0	44	5220	8.47	9.54	8.71	95.75	13.89	≤ 13.99	Pass
11n-HT20	MCS0	48	5240	8.03	9.38	8.86	95.75	13.75	≤ 13.99	Pass
11n-HT40	MCS0	38	5190	7.04	7.56	6.93	92.82	12.28	≤ 13.99	Pass
11n-HT40	MCS0	46	5230	7.34	8.04	7.70	92.82	12.80	≤ 13.99	Pass
11ac-VHT20	MCS0	36	5180	8.68	9.19	8.51	95.72	13.76	≤ 13.99	Pass
11ac-VHT20	MCS0	44	5220	8.27	9.09	8.86	95.72	13.71	≤ 13.99	Pass
11ac-VHT20	MCS0	48	5240	7.90	9.46	8.59	95.72	13.66	≤ 13.99	Pass
11ac-VHT40	MCS0	38	5190	7.22	7.66	6.56	92.42	12.28	≤ 13.99	Pass
11ac-VHT40	MCS0	46	5230	7.26	8.36	7.32	92.42	12.79	≤ 13.99	Pass
11ac-VHT80	MCS0	42	5210	4.33	4.75	4.47	74.76	10.55	≤ 13.99	Pass

Note 1: When EUT duty cycle ≥ 98%, Total PSD (dBm/MHz) = $10 \cdot \log \{10^{(\text{Ant 0 PSD}/10)} + 10^{(\text{Ant 1 PSD}/10)} + 10^{(\text{Ant 2 PSD}/10)}\}$.

Note 2: When EUT duty cycle < 98%, Total PSD (dBm/MHz) = $10 \cdot \log \{10^{(\text{Ant 0 PSD}/10)} + 10^{(\text{Ant 1 PSD}/10)} + 10^{(\text{Ant 2 PSD}/10)}\} + 10 \cdot \log (1/\text{Duty Cycle})$.

Note 3: PSD Limit = 17dBm - (26.01dBi - 23dBi) = 13.99dBm.

Product	Icomera TraXside solution	Temperature	23°C
Test Engineer	Dandy Li	Relative Humidity	52%
Test Site	TR3	Test Date	2019/08/01 ~ 2019/08/04
Test Item	Power Spectral Density (UNII-Band 3)		

Test Mode	Data Rate/MCS	Channel	Frequency (MHz)	Ant 0 PSD (dBm/100kHz)	Ant 1 PSD (dBm/100kHz)	Ant 2 PSD (dBm/100kHz)	Duty Cycle (%)	Constant Factor	Total PSD (dBm/500kHz)	Limit (dBm/500kHz)	Result
11a	6Mbps	149	5745	2.73	2.80	1.88	95.61	6.99	14.44	≤ 30.00	Pass
11a	6Mbps	157	5785	2.83	3.15	2.79	95.61	6.99	14.88	≤ 30.00	Pass
11a	6Mbps	165	5825	2.09	1.79	3.06	95.61	6.99	14.30	≤ 30.00	Pass
11n-HT20	MCS0	149	5745	2.29	1.84	2.98	95.75	6.99	14.34	≤ 30.00	Pass
11n-HT20	MCS0	157	5785	1.81	1.80	2.84	95.75	6.99	14.13	≤ 30.00	Pass
11n-HT20	MCS0	165	5825	2.06	1.87	3.24	95.75	6.99	14.38	≤ 30.00	Pass
11n-HT40	MCS0	151	5755	-0.51	-0.86	-0.59	92.82	6.99	11.43	≤ 30.00	Pass
11n-HT40	MCS0	159	5795	-7.46	-0.04	0.29	92.82	6.99	10.82	≤ 30.00	Pass
11ac-VHT20	MCS0	149	5745	2.82	2.31	2.68	95.72	6.99	14.56	≤ 30.00	Pass
11ac-VHT20	MCS0	157	5785	2.86	1.95	3.41	95.72	6.99	14.73	≤ 30.00	Pass
11ac-VHT20	MCS0	165	5825	2.42	1.93	3.30	95.72	6.99	14.54	≤ 30.00	Pass
11ac-VHT40	MCS0	151	5755	-0.72	-1.86	-2.08	92.42	6.99	10.60	≤ 30.00	Pass
11ac-VHT40	MCS0	159	5795	-2.32	-1.56	-0.71	92.42	6.99	10.63	≤ 30.00	Pass
11ac-VHT80	MCS0	155	5775	-3.43	-3.54	-3.36	74.76	6.99	9.58	≤ 30.00	Pass

Note 1: When EUT duty cycle ≥ 98%, Total PSD (dBm/500kHz) = $10 \cdot \log \{10^{(\text{Ant 0 PSD}/10)} + 10^{(\text{Ant 1 PSD}/10)} + 10^{(\text{Ant 2 PSD}/10)}\}$ (dBm/100kHz) + Constant Factor.

Note 2: When EUT duty cycle < 98%, Total PSD (dBm/500kHz) = $10 \cdot \log \{10^{(\text{Ant 0 PSD}/10)} + 10^{(\text{Ant 1 PSD}/10)} + 10^{(\text{Ant 2 PSD}/10)}\}$ (dBm/100kHz) + Constant Factor + $10 \cdot \log (1/\text{Duty Cycle})$.

802.11a Power Spectral Density - Ant 0 / Ant 0 + 1 + 2

Channel 36 (5180MHz)

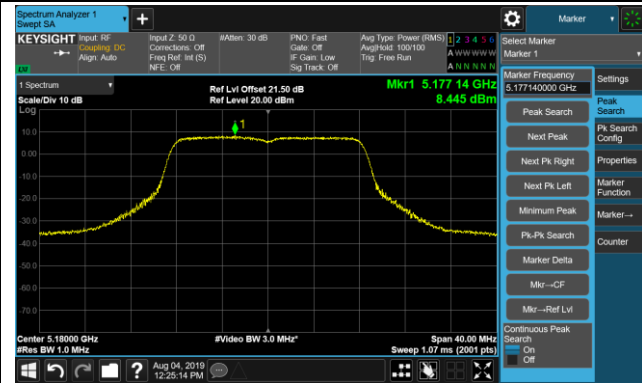

Channel 44 (5220MHz)

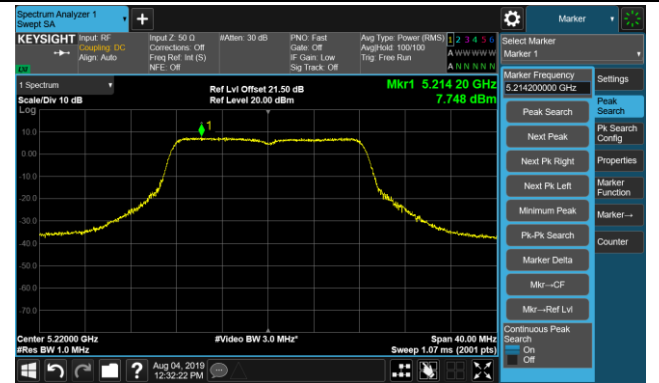

Channel 48 (5240MHz)

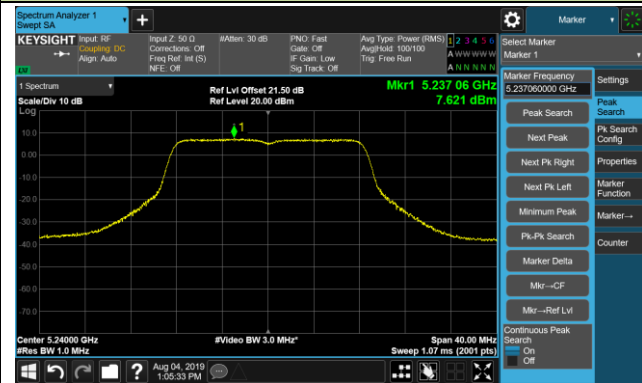

Channel 149 (5745MHz)

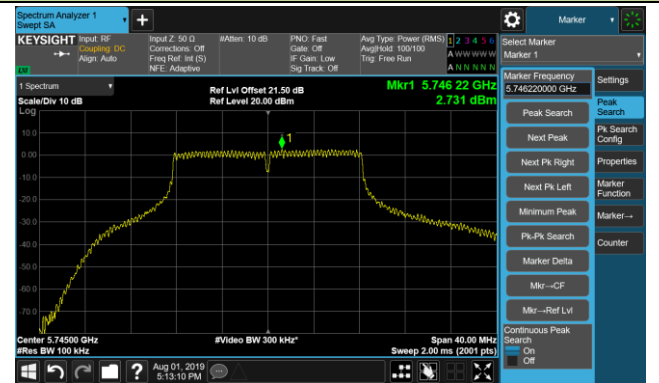

Channel 157 (5785MHz)

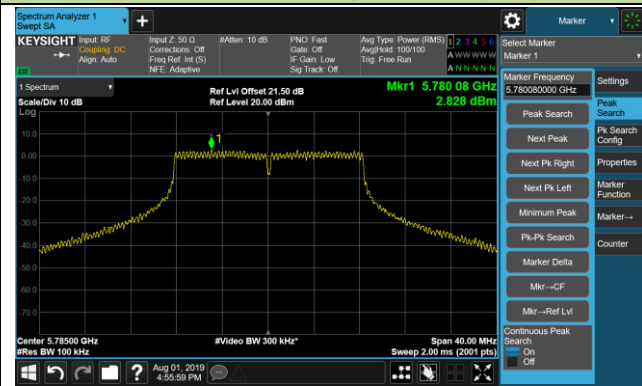

Channel 165 (5825MHz)

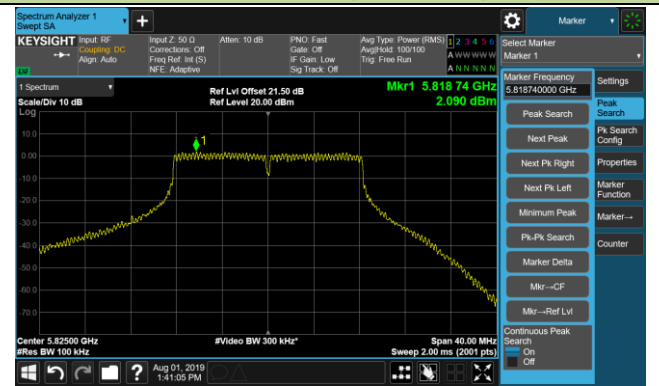

802.11n-HT20 Power Spectral Density - Ant 0 / Ant 0 + 1 + 2

Channel 36 (5180MHz)

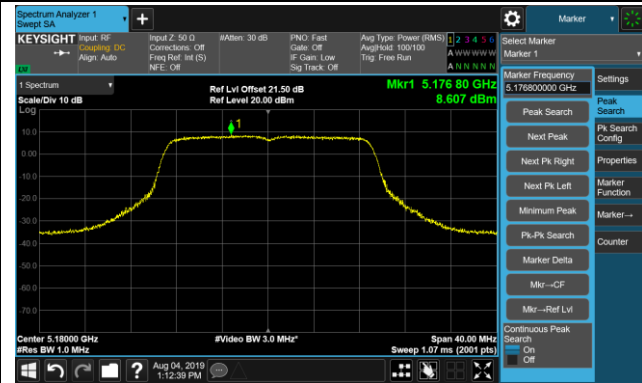

Channel 44 (5220MHz)

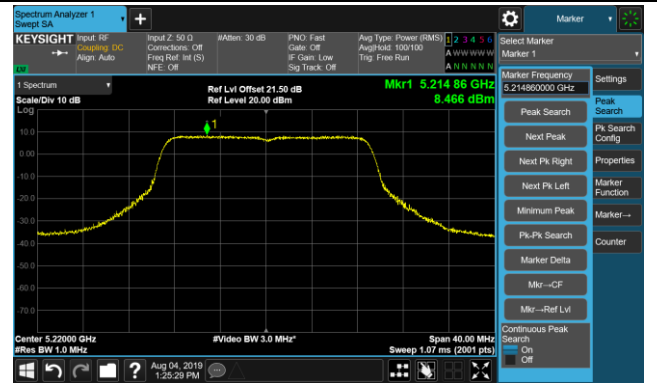

Channel 48 (5240MHz)

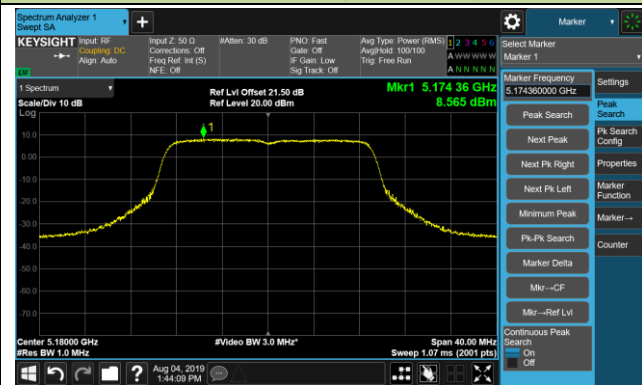

Channel 149 (5745MHz)

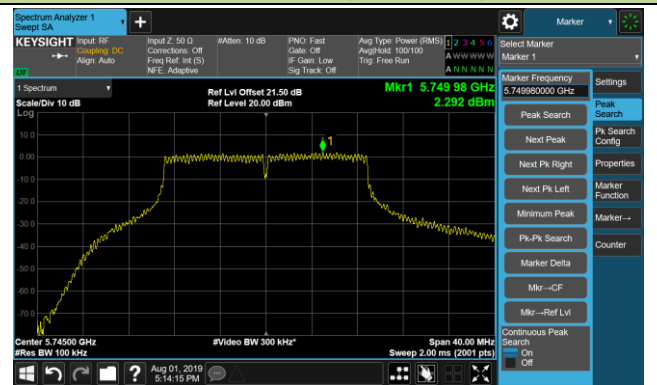

Channel 157 (5785MHz)

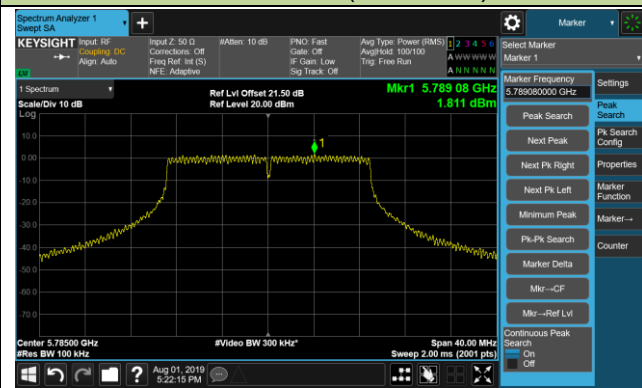

Channel 165 (5825MHz)

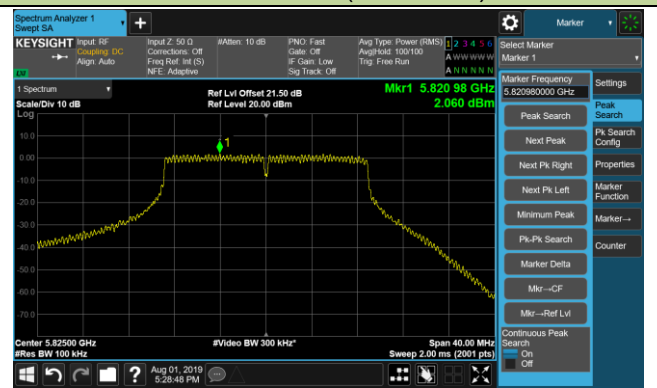

802.11n-HT40 Power Spectral Density - Ant 0 / Ant 0 + 1 + 2

Channel 38 (5190MHz)

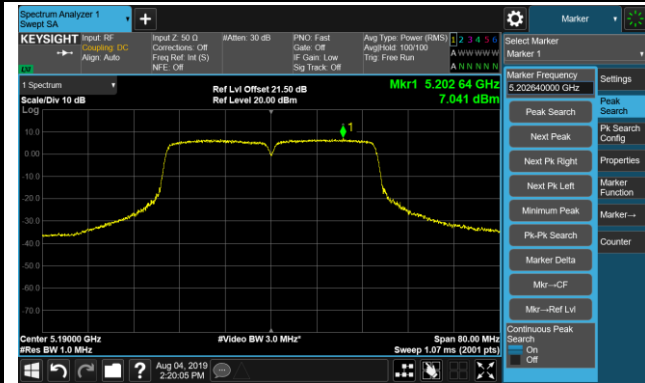

Channel 46 (5230MHz)

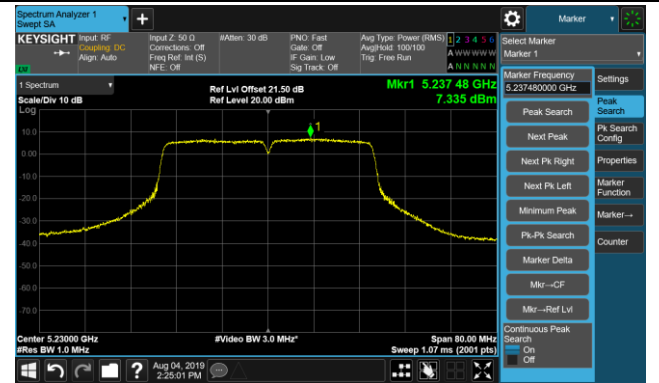

Channel 151 (5755MHz)

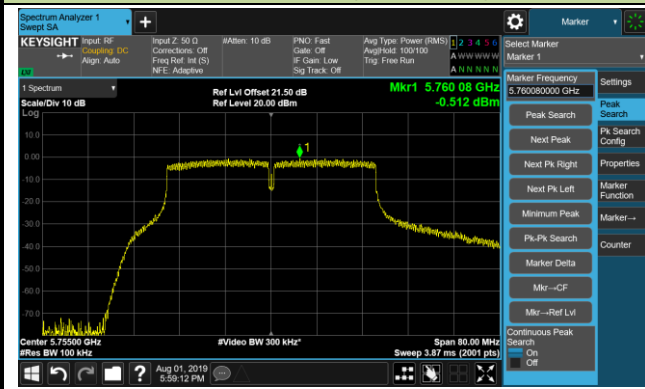

Channel 159 (5795MHz)

