

FCC TEST REPORT
for
Aputure Imaging Industries Co., Ltd

Wireless Remote Adapter
Model No.: DEC LensRegain for MFT, DEC LensRegain for E-mount, Adapter

Prepared for : Aputure Imaging Industries Co., Ltd
Address : 3rd Floor, Building 21, Longjun Industrial Estate, Longhua,
Bao'an, Shenzhen, P.R.China

Prepared By : Shenzhen Anbotek Compliance Laboratory Limited
Address : 1/F., Building 1, SEC Industrial Park, No.0409 Qianhai Road,
Nanshan District, Shenzhen, Guangdong, China
Tel: (86) 755-26066544
Fax: (86) 755-26014772

Report Number : R011512804I
Date of Test : Dec. 23, 2015~ Jan. 21, 2016
Date of Report : Jan. 21, 2016

TABLE OF CONTENTS

Description	Page
Test Report	
1. GENERAL INFORMATION.....	4
1.1. Description of Device (EUT).....	4
1.2. Auxiliary Equipment Used during Test.....	5
1.3. Description of Test Facility.....	5
1.4. Measurement Uncertainty.....	5
2. TEST PROCEDURE.....	6
3. Conducted Emission Test.....	7
3.1. Block Diagram of Test Setup.....	7
3.2. Power Line Conducted Emission Measurement Limits (15.207).....	7
3.3. Configuration of EUT on Measurement.....	7
3.4. Operating Condition of EUT.....	7
3.5. Test Procedure.....	8
3.6. Test equipment.....	8
3.7. Power Line Conducted Emission Measurement Results.....	8
4. RADIATION INTERFERENCE.....	13
4.1. Requirements (15.249, 15.209):.....	13
4.2. Test Procedure.....	13
4.3. Test Results.....	14
5. BANDEDGE.....	20
5.1. Requirements (15.249):.....	20
5.2. Test Procedure.....	20
5.3. Test Configuration:.....	20
5.4. Test Results.....	21
6. OCCUPIED BANDWIDTH.....	30
6.1. Requirements :.....	30
6.2. Test SET-UP.....	30
6.3 Test Equipment.....	30
6.4. Test Results.....	30
7. ANTENNA APPLICATION.....	33
7.1. Antenna requirement.....	33
7.2. Result.....	33
8. PHOTOGRAPH.....	34
8.1. Photo of Conducted Emission Test.....	34
8.2. Photo of Radiation Emission Test.....	34

TEST REPORT

Applicant : Aputure Imaging Industries Co., Ltd
Manufacturer : Aputure Imaging Industries Co., Ltd
EUT : Wireless Remote Adapter
Model No. : DEC LensRegain for MFT, DEC LensRegain for E-mount, Adapter
Serial No. : N.A.
Trade Mark : 
Rating : DC 3.7V, 0.5A

Measurement Procedure Used:

FCC Part15 Subpart C, Paragraph 15.207, 15.249 & 15.209

The device described above is tested by Shenzhen Anbotek Compliance Laboratory Limited to determine the maximum emission levels emanating from the device and the severe levels of the device can endure and its performance criterion. The measurement results are contained in this test report and Shenzhen Anbotek Compliance Laboratory Limited is assumed full of responsibility for the accuracy and completeness of these measurements. Also, this report shows that the EUT (Equipment Under Test) is technically compliant with the FCC Part 15 Subpart C requirements.

This report applies to above tested sample only and shall not be reproduced in part without written approval of Shenzhen Anbotek Compliance Laboratory Limited.

Date of Test : Dec. 23, 2015~ Jan. 21, 2016

Prepared by : 
(Tested Engineer / Kebo Zhang)

Reviewer : 
(Project Manager / Amy Ding)

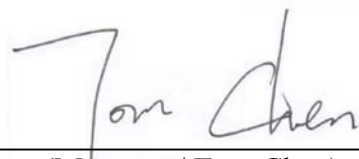
Approved & Authorized Signer : 
(Manager / Tom Chen)

1. GENERAL INFORMATION

1.1. Description of Device (EUT)

EUT	: Wireless Remote Adapter
Model Number	: DEC LensRegain for MFT, DEC LensRegain for E-mount, Adapter (Note: All samples are the same except the model number and colour, so we prepare “DEC LensRegain for MFT” for test only.)
Test Power Supply	: AC 120V, 60Hz for adapter/ AC 240V, 60Hz for adapter/ DC 3.7V Battery inside
Frequency	: 2402-2479.5MHz
Channel Space	: 500kHz
No. of Channels	: 156
Antenna Specification	: 0 dBi
Applicant Address	: Aputure Imaging Industries Co., Ltd 3rd Floor, Building 21, Longjun Industrial Estate, Longhua, Bao'an, Shenzhen, P.R.China
Manufacturer Address	: Aputure Imaging Industries Co., Ltd 3rd Floor, Building 21, Longjun Industrial Estate, Longhua, Bao'an, Shenzhen, P.R.China
Factory Address	: Aputure Imaging Industries Co., Ltd 3rd Floor, Building 21, Longjun Industrial Estate, Longhua, Bao'an, Shenzhen, P.R.China
Date of receipt	: Dec. 23, 2015
Date of Test	: Dec. 23, 2015~ Jan. 21, 2016

1.2. Auxiliary Equipment Used during Test

Adapter : Manufacturer: ZTE
M/N: STC-A2050I1000USBA-C
S/N: 201202102100876
Input: 100-240V~50/60Hz 0.3A
Output: DC 5V, 1000mA

1.3. Description of Test Facility

The test facility is recognized, certified, or accredited by the following organizations:

FCC-Registration No.: 752021

Shenzhen Anbotek Compliance Laboratory Limited, EMC Laboratory has been registered and fully described in a report filed with the (FCC) Federal Communications Commission. The acceptance letter from the FCC is maintained in our files. Registration 752021, July 10, 2013.

IC-Registration No.: 8058A-1

Shenzhen Anbotek Compliance Laboratory Limited., EMC Laboratory has been registered and fully described in a report filed with the (IC) Industry Canada. The acceptance letter from the IC is maintained in our files. Registration 8058A-1, February 22, 2013.

Test Location

All Emissions tests were performed at
Shenzhen Anbotek Compliance Laboratory Limited. at 1/F., Building 1, SEC
Industrial Park, No.0409 Qianhai Road, Nanshan District, Shenzhen, Guangdong,
China

1.4. Measurement Uncertainty

Radiation Uncertainty : Ur = 4.1 dB (Horizontal)
Ur = 4.3 dB (Vertical)
Conduction Uncertainty : Uc = 3.4dB

2. Test Procedure

GENERAL: This report shall NOT be reproduced except in full without the written approval of Shenzhen Anbotek Compliance Laboratory Limited. The EUT was transmitting a test signal during the testing.

RADIATION INTERFERENCE: The test procedure used was ANSI STANDARD C63.10-2013 using a spectrum analyzer with a pre-selector. The analyzer was calibrated in dB above a microvolt at the output of the antenna. The resolution bandwidth was 100KHz and the video bandwidth was 300KHz up to 1.0GHz and 1.0MHz with a video BW of 3.0MHz above 1.0GHz. The ambient temperature of the EUT was 74.3oF with a humidity of 69%.

FORMULA OF CONVERSION FACTORS: The Field Strength at 3m was established by adding the meter reading of the spectrum analyzer (which is set to read in units of dBuV) to the antenna correction factor supplied by the antenna manufacturer. The antenna correction factors are stated in terms of dB. The gain of the Preselector was accounted for in the Spectrum Analyzer Meter Reading.

Example:

Freq (MHz) METER READING + ACF = FS
20 dBuV + 10.36 dB = 30.36 dBuV/m @ 3m

ANSI STANDARD C63.10-2013 10.1.7 MEASUREMENT PROCEDURES: The EUT was placed on a table 80 cm high and with dimensions of 1m by 1.5m. The EUT was placed in the center of the table (1.5m side). The table used for radiated measurements is capable of continuous rotation.

When an emission was found, the table was rotated to produce the maximum signal strength. At this point, the antenna was raised and lowered from 1m to 4m. The antenna was placed in both the horizontal and vertical planes.

3. Conducted Emission Test

3.1. Block Diagram of Test Setup

3.1.1. Block diagram of connection between the EUT and simulators

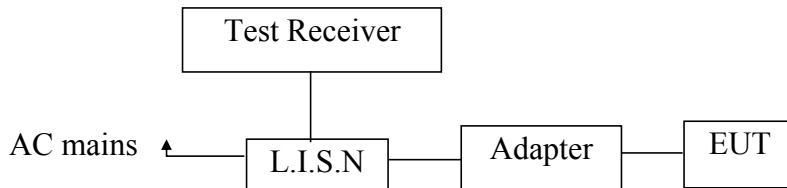

3.2. Power Line Conducted Emission Measurement Limits (15.207)

Frequency MHz	Limits dB(μV)	
	Quasi-peak Level	Average Level
0.15 ~ 0.50	66 ~ 56*	56 ~ 46*
0.50 ~ 5.00	56	46
5.00 ~ 30.00	60	50

- Notes: 1. *Decreasing linearly with logarithm of frequency.
2. The lower limit shall apply at the transition frequencies.

3.3. Configuration of EUT on Measurement

The following equipments are installed on Power Line Conducted Emission Measurement to meet the commission requirement and operating regulations in a manner which tends to maximize its emission characteristics in a normal application.

3.4. Operating Condition of EUT

- 3.4.1. Setup the EUT and simulator as shown as Section 3.1.
- 3.4.2. Turn on the power of all equipment.
- 3.4.3. Let the EUT work in test mode (Charging) and measure it.

3.5. Test Procedure

The EUT system is connected to the power mains through a line impedance stabilization network (L.I.S.N.). This provides a 50ohm coupling impedance for the EUT system. Please refer the block diagram of the test setup and photographs. Both sides of AC line are checked to find out the maximum conducted emission. In order to find the maximum emission levels, the relative positions of equipment and all of the interface cables shall be changed according to FCC ANSI C63.10-2013 on Conducted Emission Measurement.

The bandwidth of test receiver (ESCI) set at 9KHz.

The frequency range from 150KHz to 30MHz is checked.

The test results are reported on Section 3.6.

3.6. Test equipment

Item	Equipment	Manufacturer	Model No.	Serial No.	Last Cal.	Cal. Interval
1.	Two-Line V-network	Rohde & Schwarz	ENV216	100055	Apr. 17, 2015	1 Year
2.	EMI Test Receiver	Rohde & Schwarz	ESCI	100627	Apr. 17, 2015	1 Year
3.	RF Switching Unit	Compliance Direction	RSU-M2	38303	Apr. 17, 2015	1 Year

3.7. Power Line Conducted Emission Measurement Results

PASS.

The frequency range from 150KHz to 30 MHz is investigated.

Please refer the following pages.

CONDUCTED EMISSION TEST DATA

Test Site: 1# Shielded Room
 Operating Condition: Charging
 Test Specification: AC 120V, 60Hz for adapter
 Comment: Live Line
 Tem.:25°C Hum.:50%

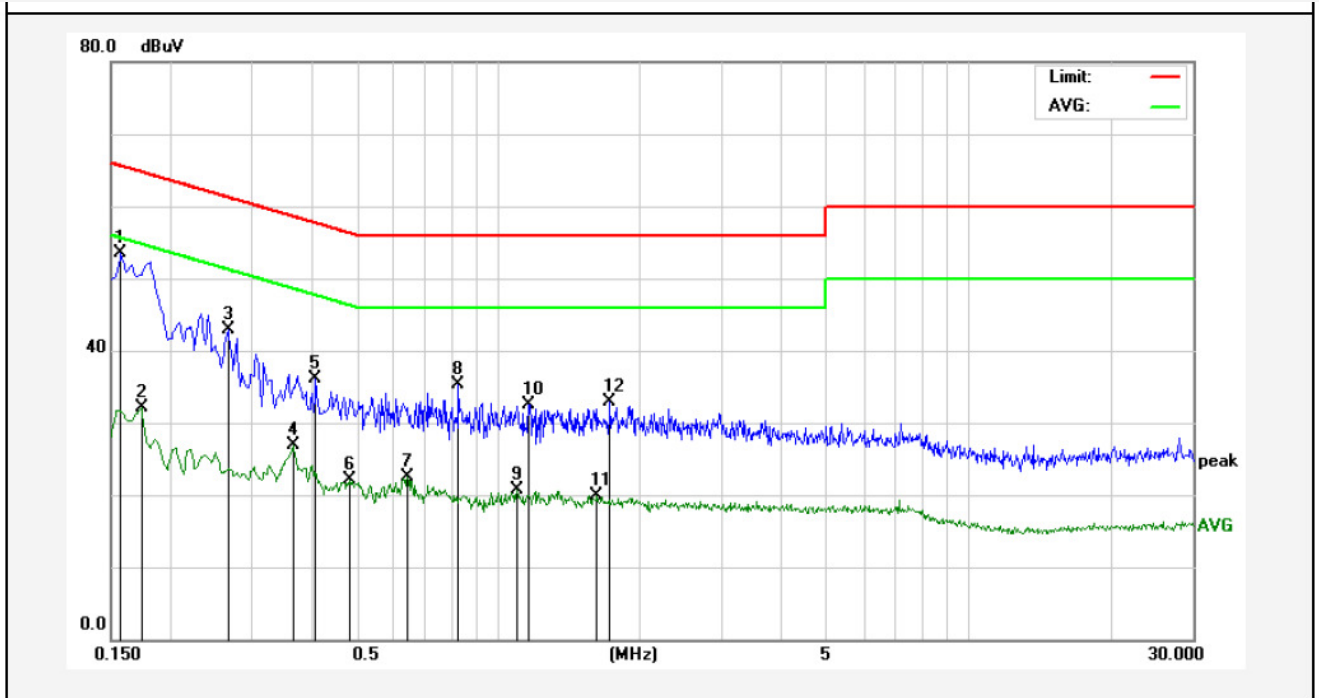

No.	Freq. (MHz)	Reading (dBuV)	Factor (dB)	Result (dBuV)	Limit dBuV	Over Limit (dB)	Detector	Remark
1	0.1580	33.56	20.00	53.56	65.56	-12.00	QP	
2	0.1740	12.01	20.00	32.01	54.76	-22.75	AVG	
3	0.2660	22.99	20.00	42.99	61.24	-18.25	QP	
4	0.3660	6.84	20.00	26.84	48.59	-21.75	AVG	
5	0.4100	16.17	20.00	36.17	57.65	-21.48	QP	
6	0.4820	2.19	20.00	22.19	46.30	-24.11	AVG	
7	0.6419	2.47	20.00	22.47	46.00	-23.53	AVG	
8	0.8260	15.38	20.00	35.38	56.00	-20.62	QP	
9	1.0940	0.72	20.00	20.72	46.00	-25.28	AVG	
10	1.1620	12.53	20.00	32.53	56.00	-23.47	QP	
11	1.6220	-0.03	20.00	19.97	46.00	-26.03	AVG	
12	1.7300	12.92	20.00	32.92	56.00	-23.08	QP	

CONDUCTED EMISSION TEST DATA

Test Site: 1# Shielded Room
 Operating Condition: Charging
 Test Specification: AC 120V, 60Hz for adapter
 Comment: Neutral Line
 Tem.:25°C Hum.:50%

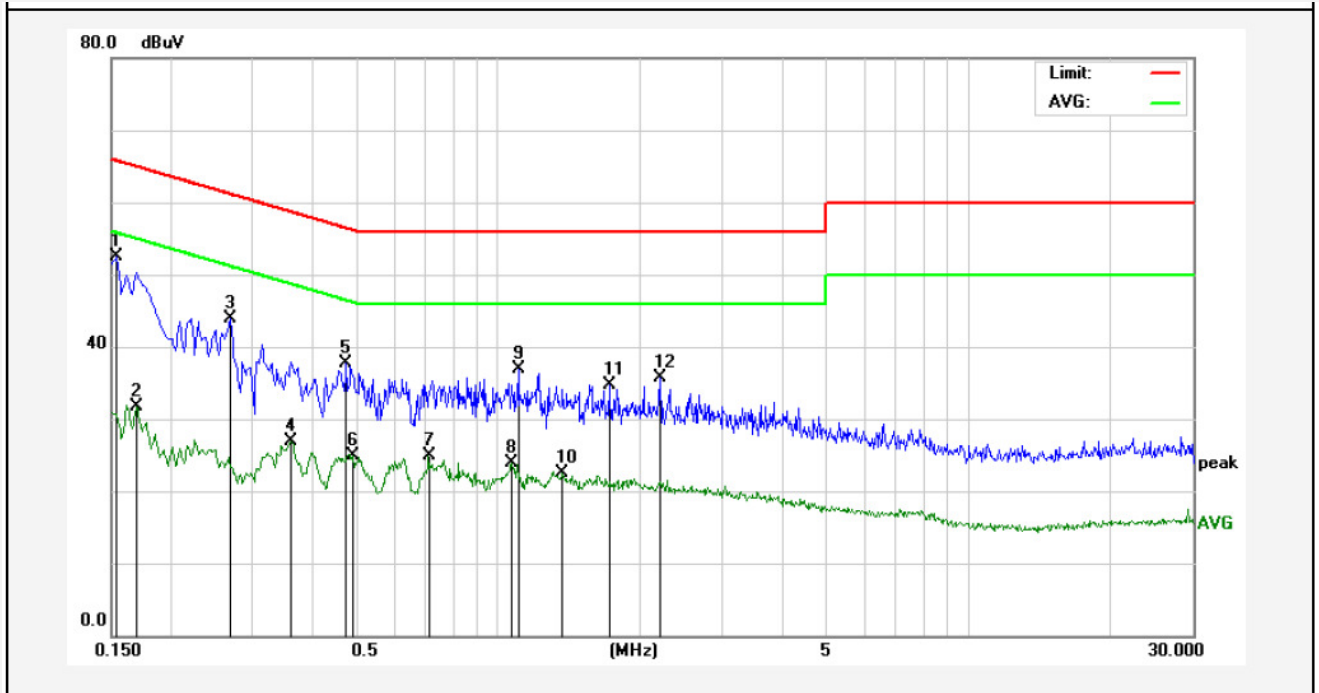

No.	Freq. (MHz)	Reading (dBuV)	Factor (dB)	Result (dBuV)	Limit dBuV	Over Limit (dB)	Detector	Remark
1	0.1539	32.47	20.00	52.47	65.78	-13.31	QP	
2	0.1700	11.66	20.00	31.66	54.96	-23.30	AVG	
3	0.2700	23.88	20.00	43.88	61.12	-17.24	QP	
4	0.3620	6.86	20.00	26.86	48.68	-21.82	AVG	
5	0.4740	17.69	20.00	37.69	56.44	-18.75	QP	
6	0.4900	4.96	20.00	24.96	46.17	-21.21	AVG	
7	0.7100	4.84	20.00	24.84	46.00	-21.16	AVG	
8	1.0700	3.91	20.00	23.91	46.00	-22.09	AVG	
9	1.1019	16.87	20.00	36.87	56.00	-19.13	QP	
10	1.3700	2.41	20.00	22.41	46.00	-23.59	AVG	
11	1.7180	14.75	20.00	34.75	56.00	-21.25	QP	
12	2.2100	15.80	20.00	35.80	56.00	-20.20	QP	

CONDUCTED EMISSION TEST DATA

Test Site: 1# Shielded Room
 Operating Condition: Charging
 Test Specification: AC 240V, 60Hz for adapter
 Comment: Live Line
 Tem.:25°C Hum.:50%

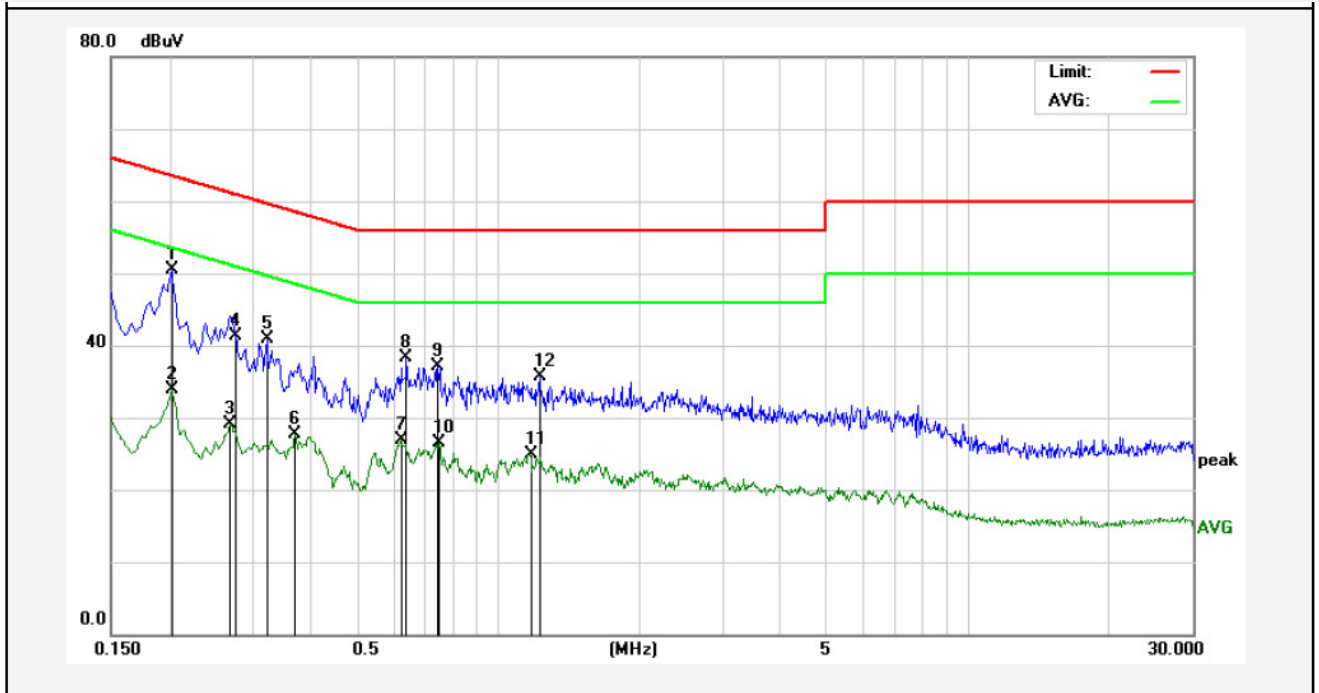

No.	Freq. (MHz)	Reading (dBuV)	Factor (dB)	Result (dBuV)	Limit dBuV	Over Limit (dB)	Detector	Remark
1	0.2020	30.55	20.00	50.55	63.52	-12.97	QP	
2	0.2020	13.85	20.00	33.85	53.52	-19.67	AVG	
3	0.2700	9.09	20.00	29.09	51.12	-22.03	AVG	
4	0.2757	21.24	20.00	41.24	60.94	-19.70	QP	
5	0.3220	20.89	20.00	40.89	59.65	-18.76	QP	
6	0.3699	7.65	20.00	27.65	48.50	-20.85	AVG	
7	0.6219	6.82	20.00	26.82	46.00	-19.18	AVG	
8	0.6380	18.25	20.00	38.25	56.00	-17.75	QP	
9	0.7459	17.04	20.00	37.04	56.00	-18.96	QP	
10	0.7500	6.43	20.00	26.43	46.00	-19.57	AVG	
11	1.1699	4.86	20.00	24.86	46.00	-21.14	AVG	
12	1.2259	15.76	20.00	35.76	56.00	-20.24	QP	

CONDUCTED EMISSION TEST DATA

Test Site: 1# Shielded Room
 Operating Condition: Charging
 Test Specification: AC 240V, 60Hz for adapter
 Comment: Neutral Line
 Tem.:25°C Hum.:50%

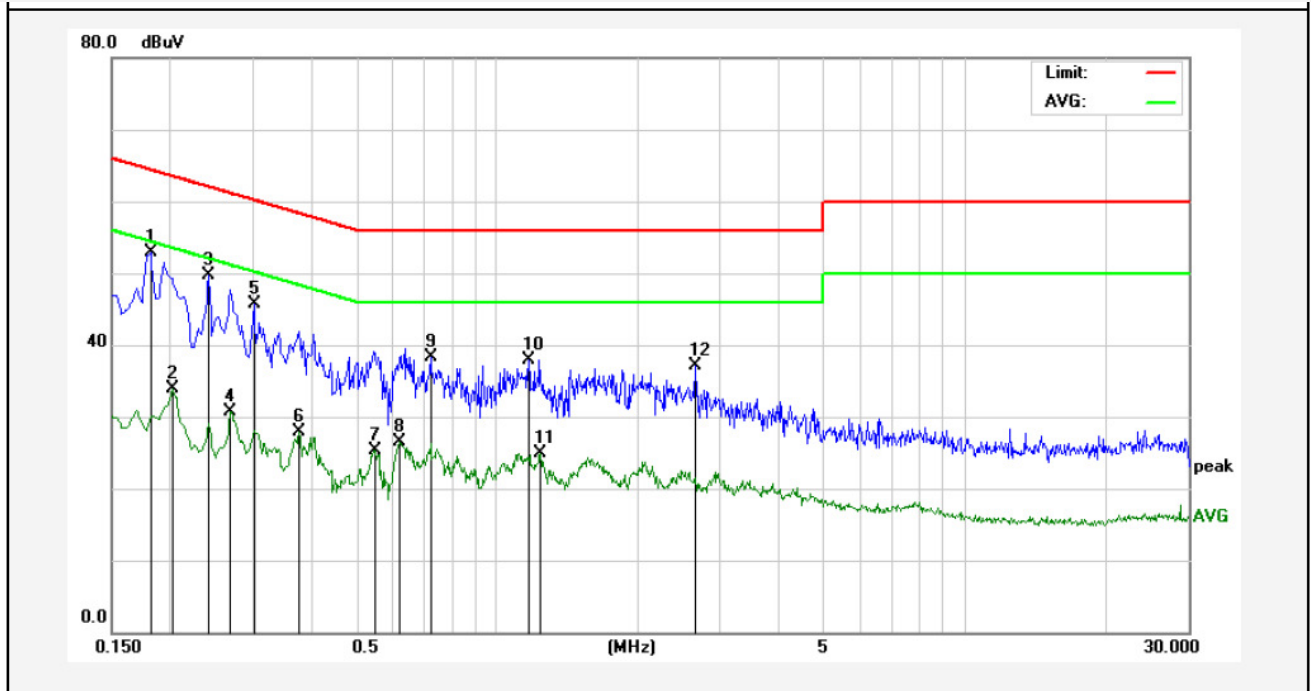

No.	Freq. (MHz)	Reading (dBuV)	Factor (dB)	Result (dBuV)	Limit dBuV	Over Limit (dB)	Detector	Remark
1	0.1819	32.82	20.00	52.82	64.39	-11.57	QP	
2	0.2020	13.93	20.00	33.93	53.52	-19.59	AVG	
3	0.2419	29.78	20.00	49.78	62.03	-12.25	QP	
4	0.2700	10.80	20.00	30.80	51.12	-20.32	AVG	
5	0.3019	25.69	20.00	45.69	60.19	-14.50	QP	
6	0.3780	7.87	20.00	27.87	48.32	-20.45	AVG	
7	0.5500	5.37	20.00	25.37	46.00	-20.63	AVG	
8	0.6179	6.57	20.00	26.57	46.00	-19.43	AVG	
9	0.7219	18.33	20.00	38.33	56.00	-17.67	QP	
10	1.1659	17.90	20.00	37.90	56.00	-18.10	QP	
11	1.2379	4.96	20.00	24.96	46.00	-21.04	AVG	
12	2.6538	17.16	20.00	37.16	56.00	-18.84	QP	

4. Radiation Interference

4.1. Requirements (15.249, 15.209):

FIELD STRENGTH of Fundamental: @3M	FIELD STRENGTH of Harmonics	S15.209	
902-928 MHz		30 - 88 MHz	40 dBuV/m
2.4-2.4835 GHz		88 - 216 MHz	43.5
94 dB μ V/m @3m	54 dB μ V/m @3m	216 - 960 MHz	46
		ABOVE 960 MHz	54dBuV/m

Emissions radiated outside of the specified frequency bands, except for harmonics, shall be attenuated by at least 50 dB below the level of the fundamental or to the general radiated emission limits in 15.209, whichever is the lesser attenuation.

4.2. Test Procedure

For below 1GHz, the EUT is placed on a turn table which is 0.8 meter high above the ground. For above 1GHz, the EUT is placed on a turn table which is 1.5 meter high above the ground. The turn table can rotate 360 degrees to determine the position of the maximum emission level. The EUT is set 3 meters away from the receiving antenna which is mounted on a antenna tower. The antenna can be moved up and down from 1 to 4 meters to find out the maximum emission level. Both horizontal and vertical polarization of the antenna are set on test.

All readings from 30MHz to 1GHz are quasi-peak values with a resolution bandwidth of 120kHz. All reading are above 1GHz, peak & average values with a resolution bandwidth of 1MHz. The EUT is tested in 9*6*6 Chamber. The device is evaluated in xyz orientation. The test results are listed in Section 4.3.

Test Equipment

Item	Equipment	Manufacturer	Model No.	Serial No.	Last Cal.	Cal. Interval
1.	Spectrum Analysis	Agilent	E4407B	US39390582	Apr. 17, 2015	1 Year
2.	Preamplifier	Instruments corporation	EMC011830	980100	Apr. 17, 2015	1 Year
3.	EMI Test Receiver	Rohde & Schwarz	ESPI	101604	Apr. 17, 2015	1 Year
4.	Double Ridged Horn Antenna	Instruments corporation	GTH-0118	351600	Apr. 20, 2015	1 Year
5.	Bilog Broadband Antenna	Schwarzbeck	VULB9163	VULB 9163-289	Apr. 20, 2015	1 Year
6.	Pre-amplifier	SONOMA	310N	186860	Apr. 17, 2015	1 Year
7.	EMI Test Software EZ-EMC	SHURPLE	N/A	N/A	N/A	N/A
8	Power Sensor	DAER	RPR3006W	15I00041SN046	Jun 30, 2015	1 Year
9	MXA Spectrum Analysis	Agilent	N9020A	MY51170037	Jun 30, 2015	1 Year
10	MXG RF Vector Signal Generator	Agilent	N5182A	MY48180656	Jun 30, 2015	1 Year
11	Signal Generator	Agilent	E4421B	MY41000743	Jun 30, 2015	1 Year
12	DC Power supply	IV	IV-8080	YQSB0096	Jun 30, 2015	1 Year
13	TEMP&HUMI PROGRAMMABLE CHAMBER	Bell Group	BE-THK-150M8	SE-0137	Mar 16, 2015	1 Year

4.3. Test Results

PASS.

The EUT was tested on (Charging, On) modes, only the worst data of (ON) is attached in the following pages.

Only the worst case (x orientation).

Below 1GHz:

Job No.:	011512804I	Polarization:	Horizontal
Standard:	(RE)FCC PART15 C _3m	Power Source:	DC 3.7V
Test item:	Radiation Test	Temp.(C)/Hum.(%RH):	24.3(C)/55%RH
Mode:	ON	Distance:	3m
Note:	30-1000MHz		

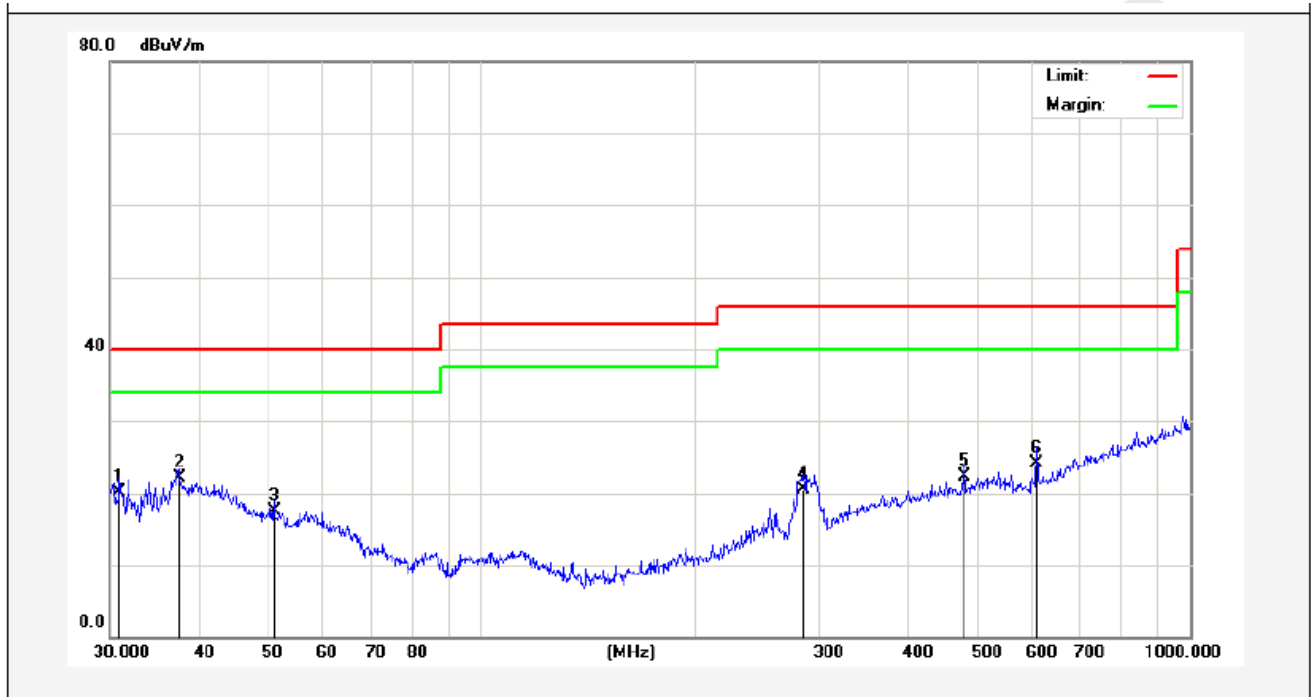

No.	Freq. (MHz)	Reading (dBuV/m)	Factor (dB/m)	Result (dBuV/m)	Limit (dBuV/)	Over Limit (dB)	Detector	Height (cm)	degree (deg)	Remark
1	30.9619	36.61	-16.44	20.17	40.00	-19.83	QP			
2	37.5479	34.39	-12.29	22.10	40.00	-17.90	QP			
3	51.1209	32.11	-14.65	17.46	40.00	-22.54	QP			
4	284.9767	38.63	-18.09	20.54	46.00	-25.46	QP			
5	480.5276	33.83	-11.53	22.30	46.00	-23.70	QP			
6	607.7867	35.15	-11.03	24.12	46.00	-21.88	QP			

Job No.:	011512804I	Polarization:	Vertical
Standard:	(RE)FCC PART15 C_3m	Power Source:	DC 3.7V
Test item:	Radiation Test	Temp.(C)/Hum.(%RH):	24.3(C)/55% RH
Mode:	ON	Distance:	3m
Note:	30-1000MHz		

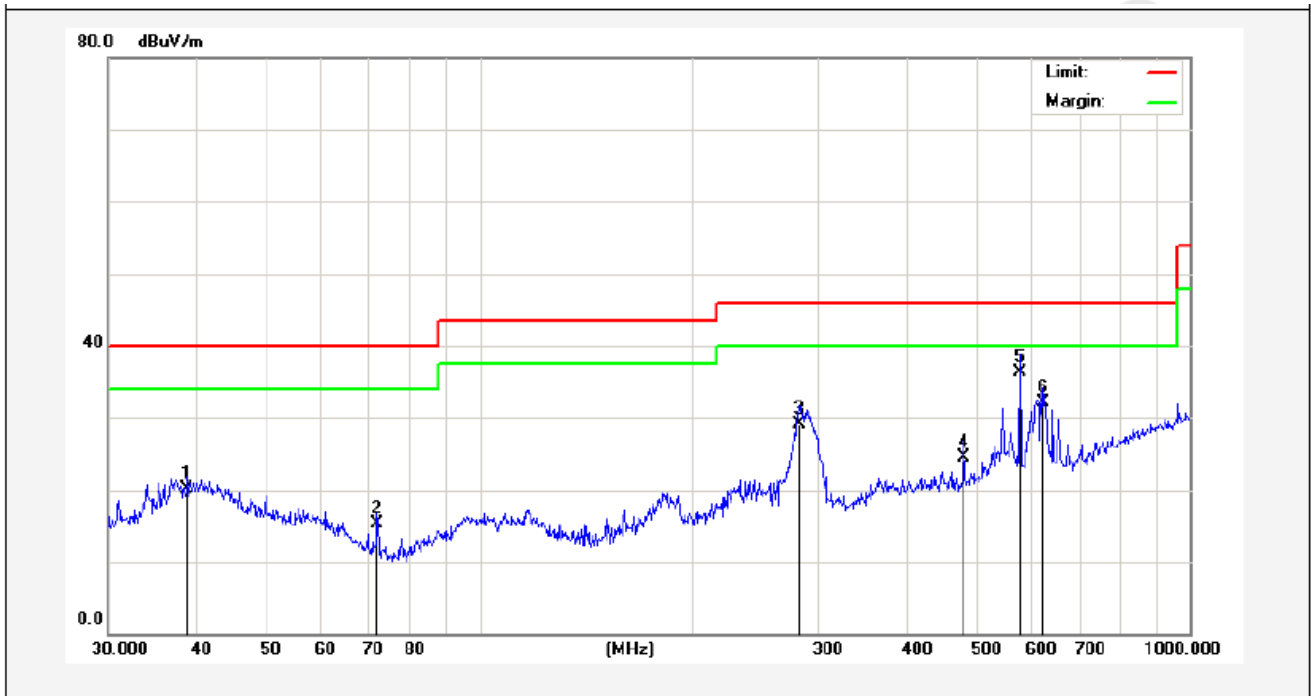

No.	Freq. (MHz)	Reading (dBuV/m)	Factor (dB/m)	Result (dBuV/m)	Limit (dBuV/)	Over Limit (dB)	Detector	Height (cm)	degree (deg)	Remark
1	38.7518	31.48	-11.35	20.13	40.00	-19.87	QP			
2	71.8320	35.34	-19.98	15.36	40.00	-24.64	QP			
3	281.9946	44.34	-15.17	29.17	46.00	-16.83	QP			
4	480.5276	36.03	-11.53	24.50	46.00	-21.50	QP			
5	576.6443	45.89	-9.64	36.25	46.00	-9.75	QP			
6	622.8900	41.18	-9.06	32.12	46.00	-13.88	QP			

Above 1 GHz:

Horizontal CH Low (2402MHz)								
Frequency MHz	Cable Loss dB	Ant Factor dB/m	Preamp Factor dB	Read Level dBμV	Level dBμV/m	Limit dBμV/m	Over Limit dB	Remark
2402.000	2.17	31.21	35.30	87.94	86.02	114.0	-27.98	Peak
2402.000	2.17	31.21	35.30	75.22	73.30	94.0	-20.70	AV
4804.220	2.56	34.01	34.71	47.35	49.21	74.0	-24.79	Peak
4804.220	2.56	34.01	34.71	35.41	37.27	54.0	-16.73	AV
7206.450	2.98	36.16	35.15	42.62	46.61	74.0	-27.39	Peak
7206.450	2.98	36.16	35.15	32.57	36.56	54.0	-17.44	AV
9608.000	---	---	---	---	---	---	---	---
12010.00	---	---	---	---	---	---	---	---
14412.00	---	---	---	---	---	---	---	---
16814.00	---	---	---	---	---	---	---	---
---	---	---	---	---	---	---	---	---

Vertical CH Low (2402MHz)								
Frequency MHz	Cable Loss dB	Ant Factor dB/m	Preamp Factor dB	Read Level dBμV	Level dBμV/m	Limit dBμV/m	Over Limit dB	Remark
2402.000	2.17	31.21	35.30	90.19	88.27	114.0	-25.73	Peak
2402.000	2.17	31.21	35.30	81.33	79.41	94.0	-14.59	AV
4804.220	2.56	34.01	34.71	46.52	48.38	74.0	-25.62	Peak
4804.220	2.56	34.01	34.71	37.09	38.95	54.0	-15.05	AV
7206.450	2.98	36.16	35.15	41.54	45.53	74.0	-28.47	Peak
7206.450	2.98	36.16	35.15	33.87	37.86	54.0	-16.14	AV
9608.000	---	---	---	---	---	---	---	---
12010.00	---	---	---	---	---	---	---	---
14412.00	---	---	---	---	---	---	---	---
16814.00	---	---	---	---	---	---	---	---
---	---	---	---	---	---	---	---	---

Horizontal
CH Middle (2440MHz)

Frequency MHz	Cable Loss dB	Ant Factor dB/m	Preamplifier Factor dB	Read Level dBμV	Level dBμV/m	Limit dBμV/m	Over Limit dB	Remark
2440.000	2.19	31.22	34.60	90.04	88.85	114.0	-25.15	Peak
2440.000	2.19	31.22	34.60	82.65	81.46	94.0	-12.54	AV
4880.310	2.57	35.00	34.58	47.88	50.87	74.0	-23.13	Peak
4880.310	2.57	35.00	34.58	39.19	42.18	54.0	-11.82	AV
7320.680	3.00	36.17	35.14	40.04	44.07	74.0	-29.93	Peak
7320.680	3.00	36.17	35.14	37.25	41.28	54.0	-12.72	AV
9760.000	---	---	---	---	---	---	---	---
12200.00	---	---	---	---	---	---	---	---
14640.00	---	---	---	---	---	---	---	---
17080.00	---	---	---	---	---	---	---	---
---	---	---	---	---	---	---	---	---

Vertical
CH Middle (2440MHz)

Frequency MHz	Cable Loss dB	Ant Factor dB/m	Preamplifier Factor dB	Read Level dBμV	Level dBμV/m	Limit dBμV/m	Over Limit dB	Remark
2440.000	2.19	31.22	34.60	91.13	89.94	114.0	-24.06	Peak
2440.000	2.19	31.22	34.60	82.57	81.38	94.0	-12.62	AV
4880.340	2.57	35.00	34.58	46.09	49.08	74.0	-24.92	Peak
4880.340	2.57	35.00	34.58	38.52	41.51	54.0	-12.49	AV
7320.620	3.00	36.17	35.14	46.11	50.14	74.0	-23.86	Peak
7320.620	3.00	36.17	35.14	38.75	42.78	54.0	-11.22	AV
9760.000	---	---	---	---	---	---	---	---
12200.00	---	---	---	---	---	---	---	---
14640.00	---	---	---	---	---	---	---	---
17080.00	---	---	---	---	---	---	---	---
---	---	---	---	---	---	---	---	---

Horizontal
CH High (2479.5MHz)

Frequency MHz	Cable Loss dB	Ant Factor dB/m	Preamp Factor dB	Read Level dB μ V	Level dB μ V/m	Limit dB μ V/m	Over Limit dB	Remark
2479.500	2.20	31.65	36.00	92.05	89.90	114.0	-24.10	Peak
2479.500	2.20	31.65	36.00	81.57	79.42	94.0	-14.58	AV
4959.270	2.58	35.06	34.79	49.55	52.40	74.0	-21.60	Peak
4959.370	2.58	35.06	34.79	36.26	39.11	54.0	-14.89	AV
7439.010	3.02	36.19	34.90	45.19	49.50	74.0	-24.50	Peak
7439.010	3.02	36.20	35.20	37.21	41.23	54.0	-12.77	AV
9918.000	---	---	---	---	---	---	---	---
12397.50	---	---	---	---	---	---	---	---
14877.00	---	---	---	---	---	---	---	---
17356.50	---	---	---	---	---	---	---	---
---	---	---	---	---	---	---	---	---

Vertical
CH High (2479.5MHz)

Frequency MHz	Cable Loss dB	Ant Factor dB/m	Preamp Factor dB	Read Level dB μ V	Level dB μ V/m	Limit dB μ V/m	Over Limit dB	Remark
2479.500	2.20	31.65	36.00	92.54	90.39	114.0	-23.61	Peak
2479.500	2.20	31.65	36.00	86.43	84.28	94.0	-9.72	AV
4959.270	2.58	35.06	34.79	49.11	51.96	74.0	-22.04	Peak
4959.370	2.58	35.06	34.79	37.65	40.50	54.0	-13.50	AV
7439.010	3.02	36.19	34.90	47.11	51.42	74.0	-22.58	Peak
7439.010	3.02	36.20	35.20	38.02	42.04	54.0	-11.96	AV
9918.000	---	---	---	---	---	---	---	---
12397.50	---	---	---	---	---	---	---	---
14877.00	---	---	---	---	---	---	---	---
17356.50	---	---	---	---	---	---	---	---
---	---	---	---	---	---	---	---	---

NOTE: “ --- ” in the table above means the reading of emissions are attenuated more than 20dB below the permissible limits or the field strength is too small to be measured. The results of different modulations are the same.

5. Bandedge

5.1. Requirements (15.249):

The field strength of any emissions appearing outside the band edges and up to 10 kHz above and below the band edges shall be attenuated at least 50 dB below the level of the carrier or to the general limits of 15.249.

5.2. Test Procedure

The EUT is placed on a turn table which is 1.5 meter high above the ground. The turn table can rotate 360 degrees to determine the position of the maximum emission level. The EUT is set 3 meters away from the receiving antenna which is mounted on a antenna tower. The antenna can be moved up and down from 1 to 4 meters to find out the maximum emission level. Both horizontal and vertical polarization of the antenna are set on test. The device is evaluated in xyz orientation.

Test Equipment

Item	Equipment	Manufacturer	Model No.	Serial No.	Last Cal.	Cal. Interval
1.	Spectrum Analysis	Agilent	E4407B	US39390582	Apr. 17, 2015	1 Year
2.	Preamplifier	Instruments corporation	EMC011830	980100	Apr. 17, 2015	1 Year
3.	EMI Test Receiver	Rohde & Schwarz	ESPI	101604	Apr. 17, 2015	1 Year
4.	Double Ridged Horn Antenna	Instruments corporation	GTH-0118	351600	Apr. 20, 2015	1 Year
5.	Bilog Broadband Antenna	Schwarzbeck	VULB9163	VULB 9163-289	Apr. 20, 2015	1 Year
6.	Pre-amplifier	SONOMA	310N	186860	Apr. 17, 2015	1 Year
7.	EMI Test Software EZ-EMC	SHURPLE	N/A	N/A	N/A	N/A
8	Power Sensor	DAER	RPR3006W	15I00041SN046	Jun 30, 2015	1 Year
9	MXA Spectrum Analysis	Agilent	N9020A	MY51170037	Jun 30, 2015	1 Year
10	MXG RF Vector Signal Generator	Agilent	N5182A	MY48180656	Jun 30, 2015	1 Year
11	Signal Generator	Agilent	E4421B	MY41000743	Jun 30, 2015	1 Year
12	DC Power supply	IV	IV-8080	YQSB0096	Jun 30, 2015	1 Year
13	TEMP&HUMI PROGRAMMABLE CHAMBER	Bell Group	BE-THK-150M8	SE-0137	Mar 16, 2015	1 Year

5.3. Test Configuration:

30M to 1G emissions:

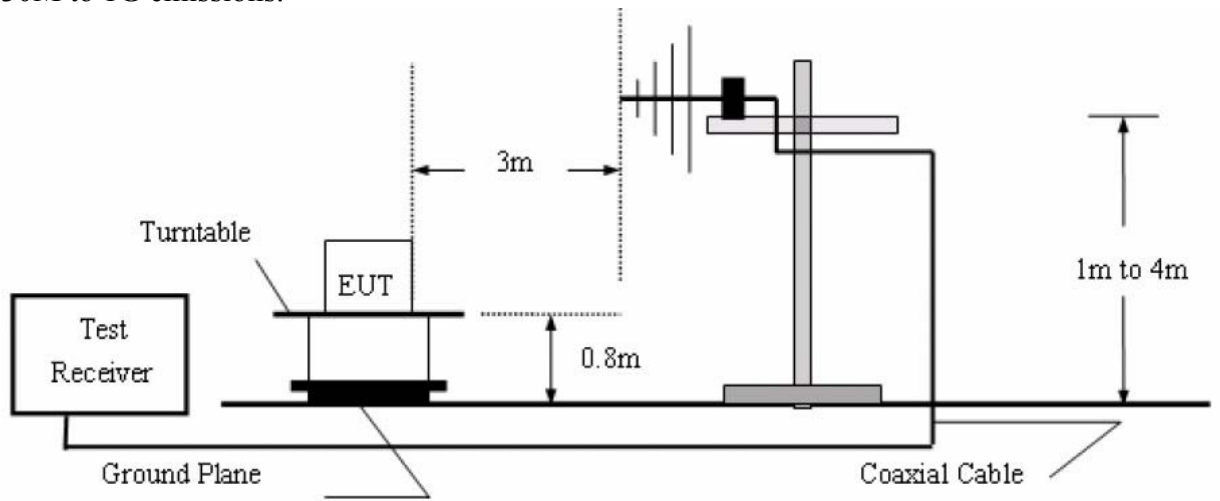

1G to 40G emissions:

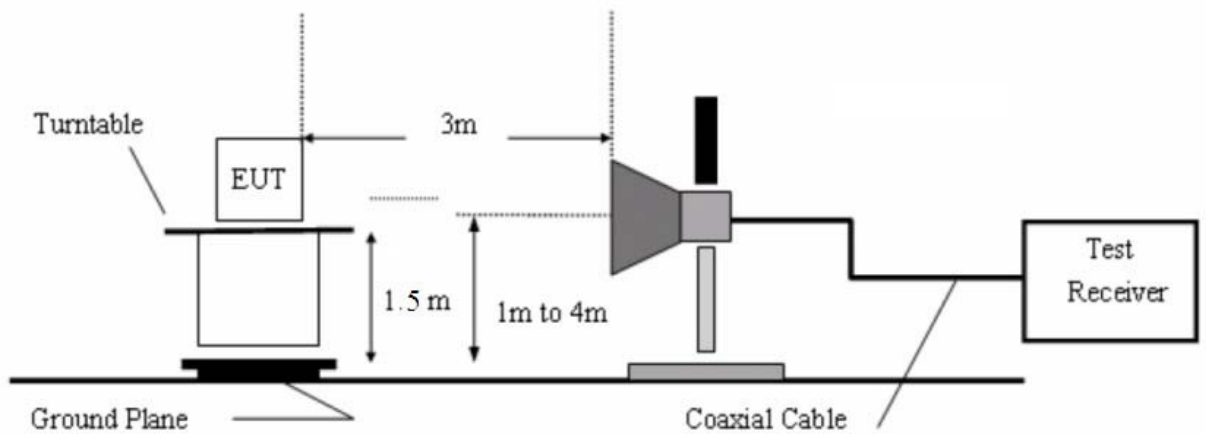

5.4. Test Results

Pass.

Please refer the following plot. Only the worst case (x orientation).

Job No.:	011512804I	Polarization:	Horizontal
Standard:	(RE)FCC PART15 C_3m	Power Source:	DC 3.7V
Test item:	Radiation Test	Temp.(C)/Hum.(%RH):	24.3(C)/55% RH
Note:	PEAK	Distance:	3m

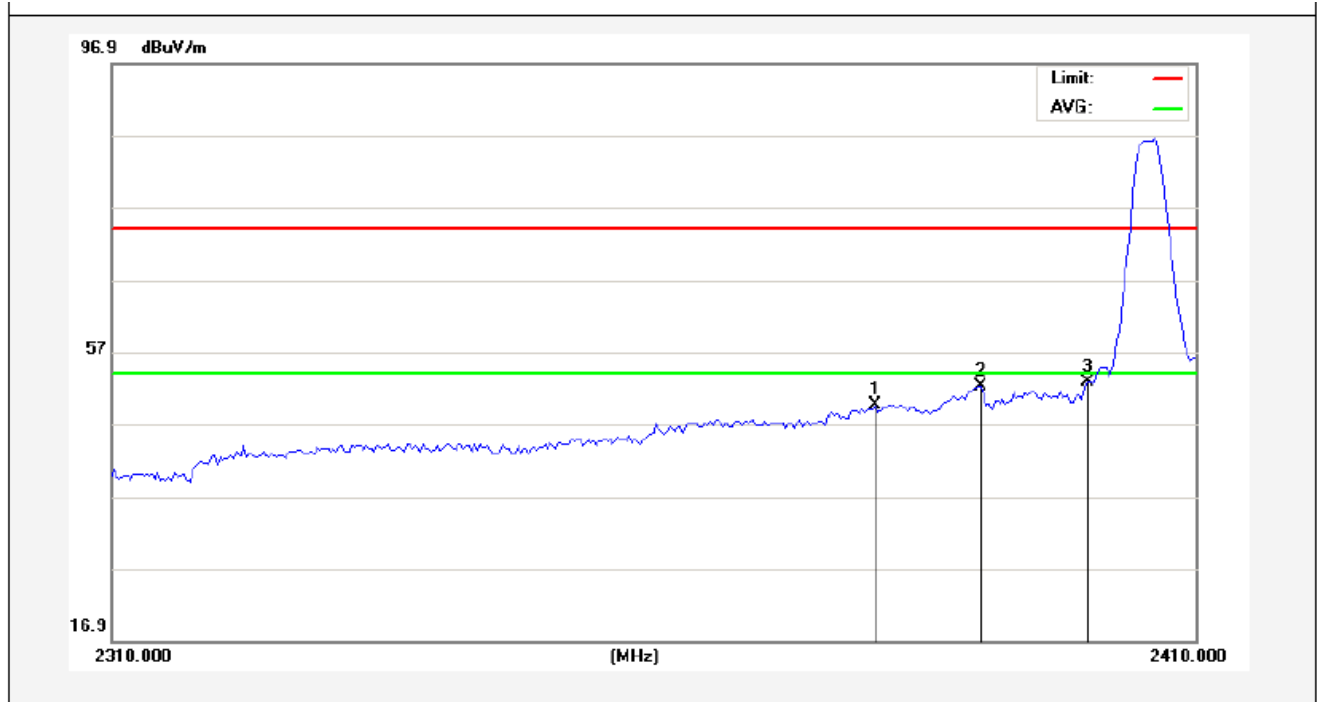

No.	Freq. (MHz)	Reading (dBuV/m)	Factor (dB/m)	Result (dBuV/m)	Limit (dBuV/)	Over Limit (dB)	Detector	Height (cm)	degree (deg)	Remark
1	2380.250	52.18	-2.54	49.64	74.00	-24.36	peak			
2	2390.000	54.76	-2.51	52.25	74.00	-21.75	peak			
3	2400.000	55.20	-2.49	52.71	74.00	-21.29	peak			

AM

Job No.:	011512804I	Polarization:	Vertical
Standard:	(RE)FCC PART15 C _3m	Power Source:	DC 3.7V
Test item:	Radiation Test	Temp.(C)/Hum.(%RH):	24.3(C)/55%RH
Note:	PEAK	Distance:	3m

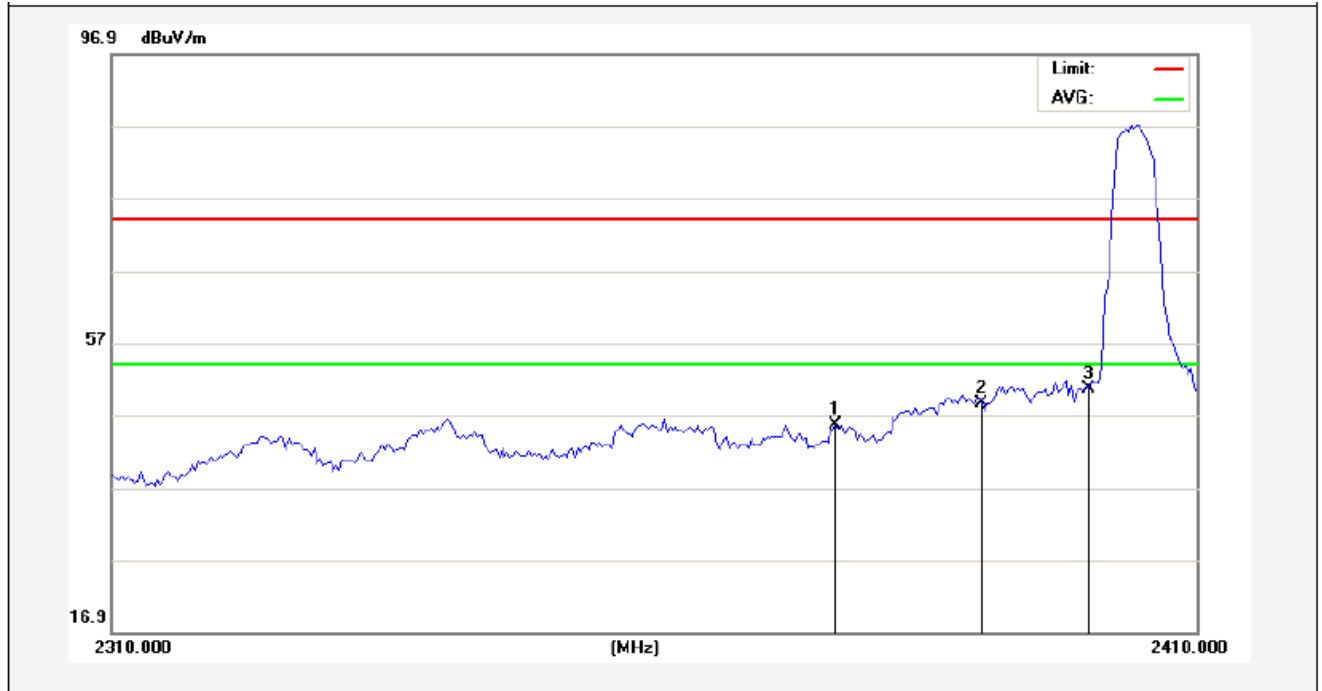

No.	Freq. (MHz)	Reading (dBuV/m)	Factor (dB/m)	Result (dBuV/m)	Limit (dBuV/)	Over Limit (dB)	Detector	Height (cm)	degree (deg)	Remark
1	2376.500	48.23	-2.54	45.69	74.00	-28.31	peak			
2	2390.000	51.06	-2.51	48.55	74.00	-25.45	peak			
3	2400.000	53.03	-2.49	50.54	74.00	-23.46	peak			

A.M.

Job No.:	011512804I	Polarization:	Horizontal
Standard:	(RE)FCC PART15 C _3m	Power Source:	DC 3.7V
Test item:	Radiation Test	Temp.(C)/Hum.(%RH):	24.3(C)/55% RH
Note:	AV	Distance:	3m

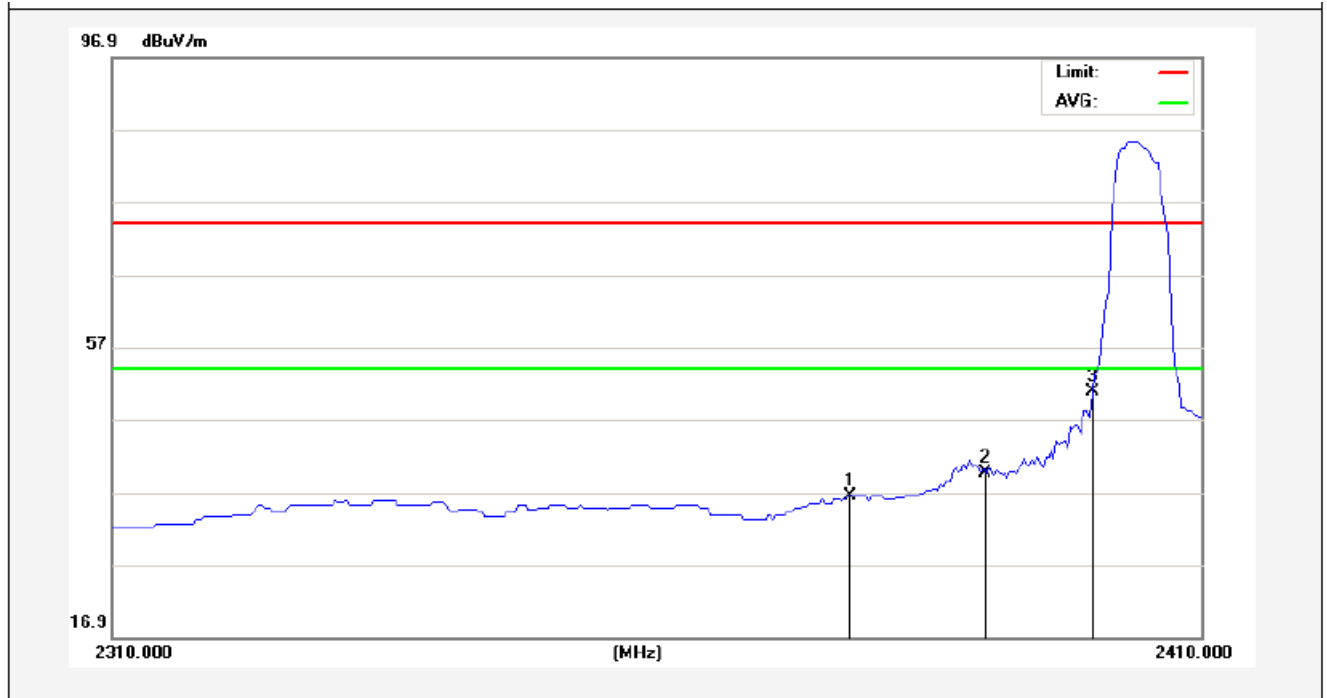

No.	Freq. (MHz)	Reading (dBuV/m)	Factor (dB/m)	Result (dBuV/m)	Limit (dBuV/)	Over Limit (dB)	Detector	Height (cm)	degree (deg)	Remark
1	2377.500	39.04	-2.54	36.50	54.00	-17.50	AVG			
2	2390.000	42.06	-2.51	39.55	54.00	-14.45	AVG			
3	2400.000	53.30	-2.49	50.81	54.00	-3.19	AVG			

A.M.

Job No.:	011512804I	Polarization:	Vertical
Standard:	(RE)FCC PART15 C_3m	Power Source:	DC 3.7V
Test item:	Radiation Test	Temp.(C)/Hum.(%RH):	24.3(C)/55%RH
Note:	AV	Distance:	3m

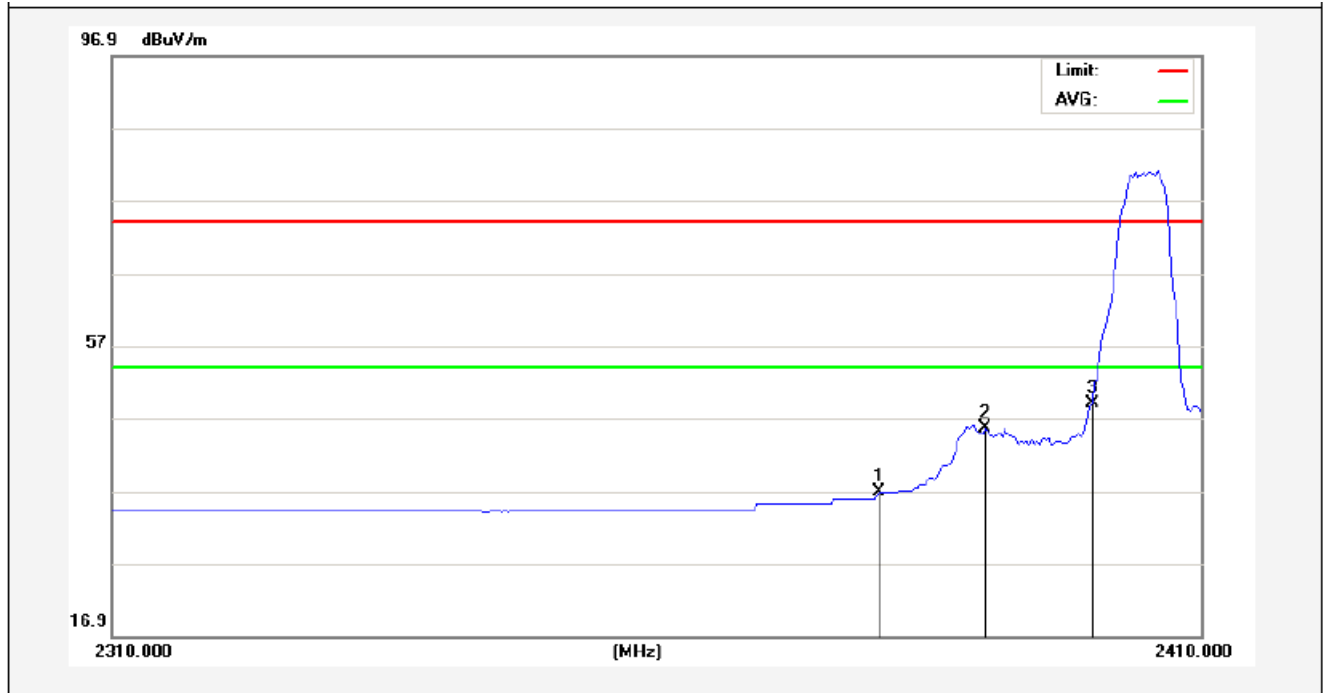

No.	Freq. (MHz)	Reading (dBuV/m)	Factor (dB/m)	Result (dBuV/m)	Limit (dBuV/)	Over Limit (dB)	Detector	Height (cm)	degree (deg)	Remark
1	2380.250	39.30	-2.54	36.76	54.00	-17.24	AVG			
2	2390.000	48.05	-2.51	45.54	54.00	-8.46	AVG			
3	2400.000	51.51	-2.49	49.02	54.00	-4.98	AVG			

Job No.:	011512804I	Polarization:	Horizontal
Standard:	(RE)FCC PART15 C_3m	Power Source:	DC 3.7V
Test item:	Radiation Test	Temp.(C)/Hum.(%RH):	24.3(C)/55% RH
Note:	PEAK	Distance:	3m

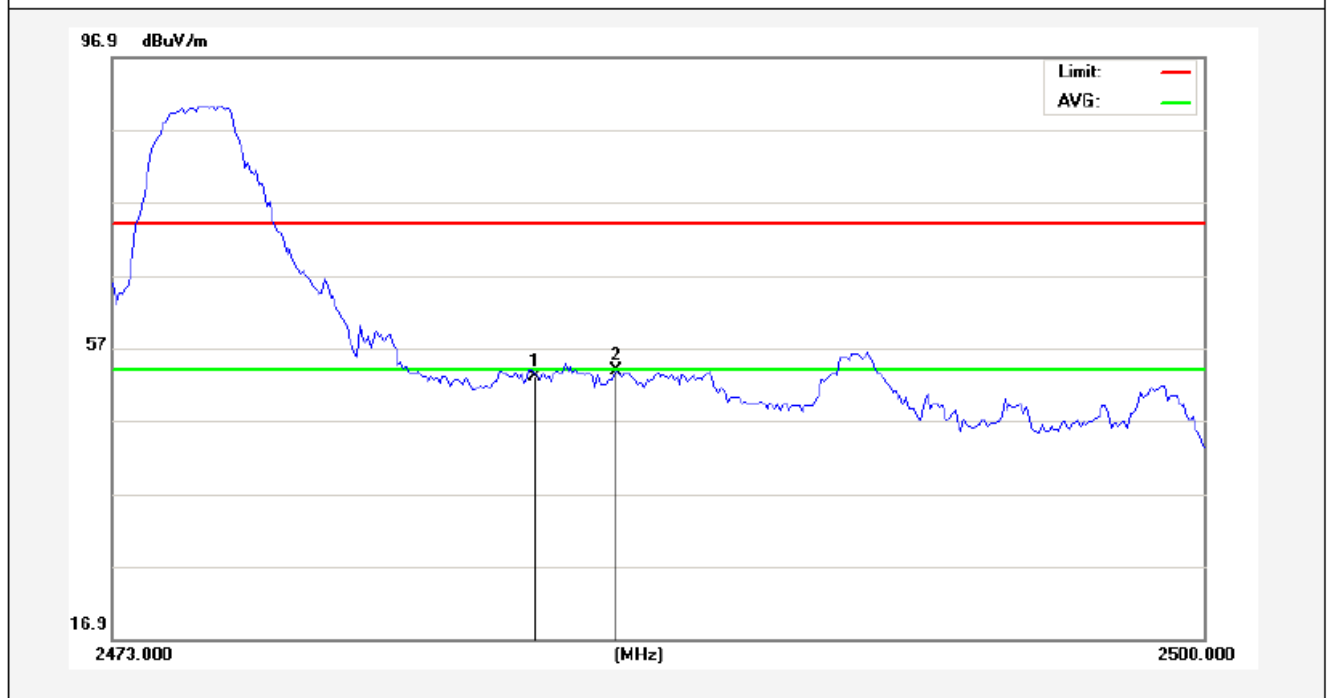

No.	Freq. (MHz)	Reading (dBuV/m)	Factor (dB/m)	Result (dBuV/m)	Limit (dBuV/)	Over Limit (dB)	Detector	Height (cm)	degree (deg)	Remark
1	2483.500	55.36	-2.31	53.05	74.00	-20.95	peak			
2	2485.488	56.05	-2.30	53.75	74.00	-20.25	peak			



Job No.:	011512804I	Polarization:	Vertical
Standard:	(RE)FCC PART15 C _3m	Power Source:	DC 3.7V
Test item:	Radiation Test	Temp.(C)/Hum.(%RH):	24.3(C)/55%RH
Note:	PEAK	Distance:	3m

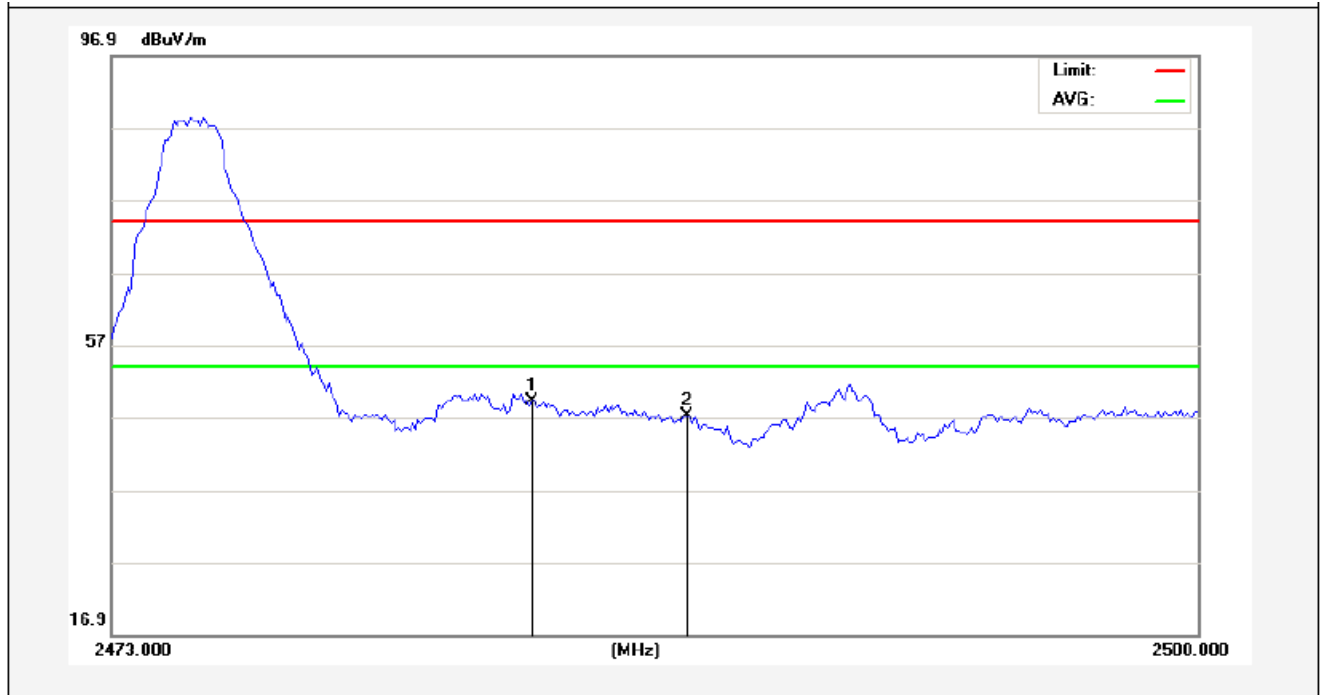

No.	Freq. (MHz)	Reading (dBuV/m)	Factor (dB/m)	Result (dBuV/m)	Limit (dBuV/)	Over Limit (dB)	Detector	Height (cm)	degree (deg)	Remark
1	2483.500	51.44	-2.31	49.13	74.00	-24.87	peak			
2	2487.310	49.59	-2.30	47.29	74.00	-26.71	peak			

AM

Job No.:	011512804I	Polarization:	Horizontal
Standard:	(RE)FCC PART15 C _3m	Power Source:	DC 3.7V
Test item:	Radiation Test	Temp.(C)/Hum.(%RH):	24.3(C)/55% RH
Note:	AV	Distance:	3m

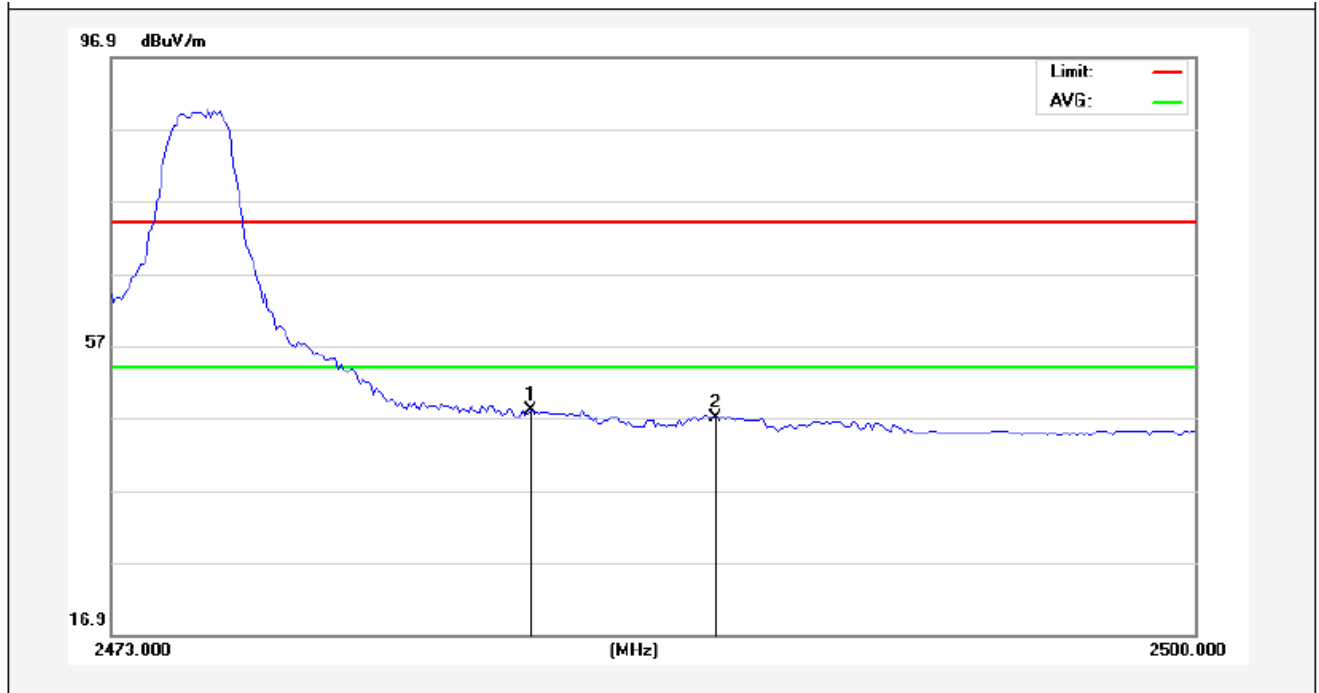

No.	Freq. (MHz)	Reading (dBuV/m)	Factor (dB/m)	Result (dBuV/m)	Limit (dBuV/)	Over Limit (dB)	Detector	Height (cm)	degree (deg)	Remark
1	2483.500	50.30	-2.31	47.99	54.00	-6.01	AVG			
2	2488.052	49.39	-2.30	47.09	54.00	-6.91	AVG			

A.M.

Job No.:	011512804I	Polarization:	Vertical
Standard:	(RE)FCC PART15 C_3m	Power Source:	DC 3.7V
Test item:	Radiation Test	Temp.(C)/Hum.(%RH):	24.3(C)/55%RH
Note:	AV	Distance:	3m

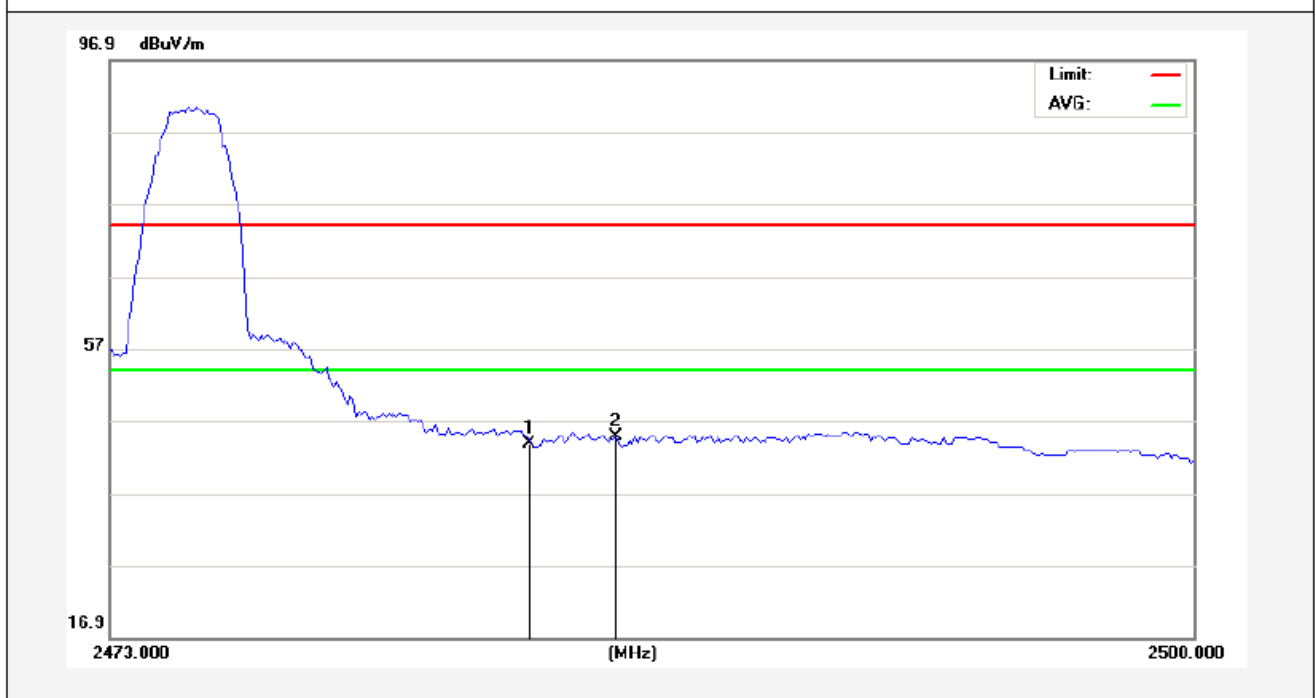

No.	Freq. (MHz)	Reading (dBuV/m)	Factor (dB/m)	Result (dBuV/m)	Limit (dBuV/)	Over Limit (dB)	Detector	Height (cm)	degree (deg)	Remark
1	2483.500	46.21	-2.31	43.90	54.00	-10.10	AVG			
2	2485.622	47.08	-2.30	44.78	54.00	-9.22	AVG			



6. Occupied Bandwidth

6.1. Requirements :

According to 15.215 (c), intentional radiators operating under the alternative provisions to the general emission limits, as contained in §§15.217 through 15.257 and in Subpart E of this part, must be designed to ensure that the 20 dB bandwidth of the emission, or whatever bandwidth may otherwise be specified in the specific rule section under which the equipment operates, is contained within the frequency band designated in the rule section under which the equipment is operated. The requirement to contain the designated bandwidth of the emission within the specified frequency band includes the effects from frequency sweeping, frequency hopping and other modulation techniques that may be employed as well as the frequency stability of the transmitter over expected variations in temperature and supply voltage. If a frequency stability is not specified in the regulations, it is recommended that the fundamental emission be kept within at least the central 80% of the permitted band in order to minimize the possibility of out-of-band operation.

6.2. Test SET-UP

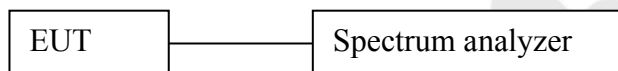

6.3 Test Equipment

Item	Equipment	Manufacturer	Model No.	Serial No.	Last Cal.	Cal. Interval
1.	Spectrum Analysis	Agilent	E4407B	US39390582	Apr. 17, 2015	1 Year
2.	Preamplifier	Instruments corporation	EMC011830	980100	Apr. 17, 2015	1 Year
3.	EMI Test Receiver	Rohde & Schwarz	ESPI	101604	Apr. 17, 2015	1 Year
4.	Double Ridged Horn Antenna	Instruments corporation	GTH-0118	351600	Apr. 20, 2015	1 Year
5.	Bilog Broadband Antenna	Schwarzbeck	VULB9163	VULB 9163-289	Apr. 20, 2015	1 Year
6.	Pre-amplifier	SONOMA	310N	186860	Apr. 17, 2015	1 Year
7.	EMI Test Software EZ-EMC	SHURPLE	N/A	N/A	N/A	N/A
8	Power Sensor	DAER	RPR3006W	15I00041SN046	Jun 30, 2015	1 Year
9	MXA Spectrum Analysis	Agilent	N9020A	MY51170037	Jun 30, 2015	1 Year
10	MXG RF Vector Signal Generator	Agilent	N5182A	MY48180656	Jun 30, 2015	1 Year
11	Signal Generator	Agilent	E4421B	MY41000743	Jun 30, 2015	1 Year
12	DC Power supply	IV	IV-8080	YQSB0096	Jun 30, 2015	1 Year
13	TEMP&HUMI PROGRAMMABLE CHAMBER	Bell Group	BE-THK-15 0M8	SE-0137	Mar 16, 2015	1 Year

6.4. Test Results

Pass.

Please refer the following plot.

20dB Down:

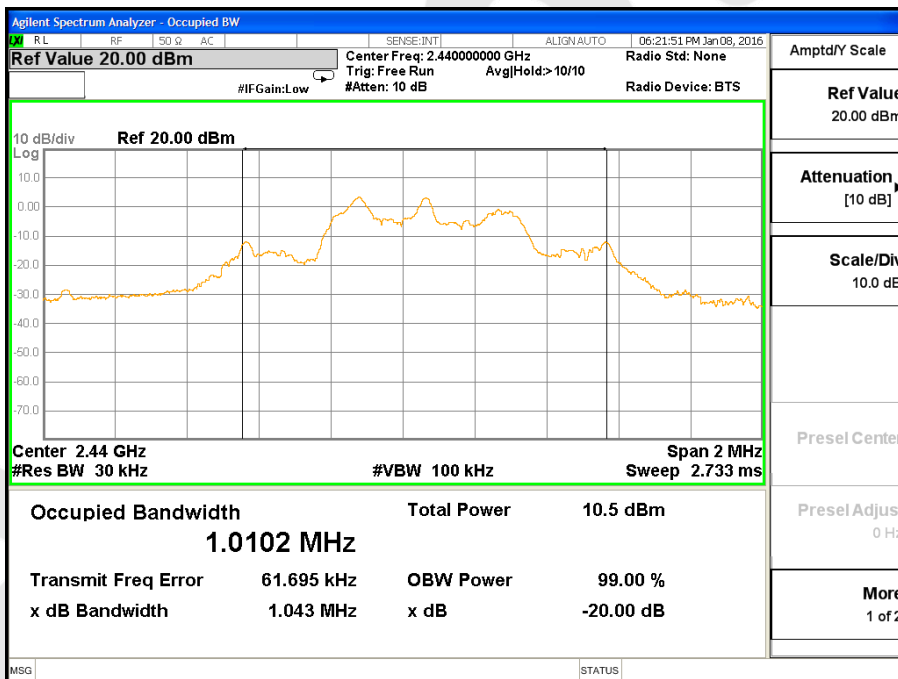
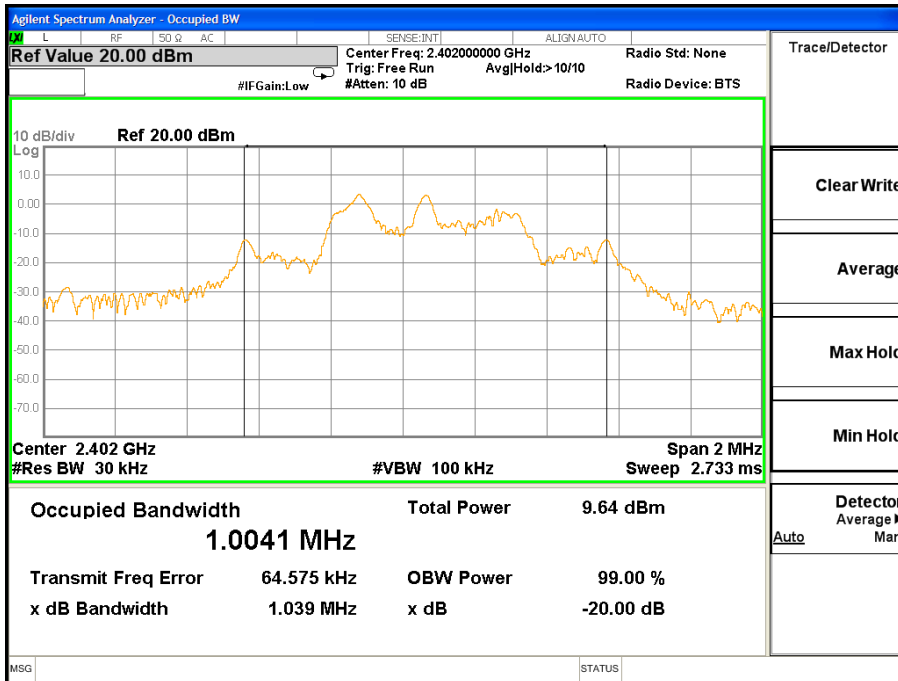

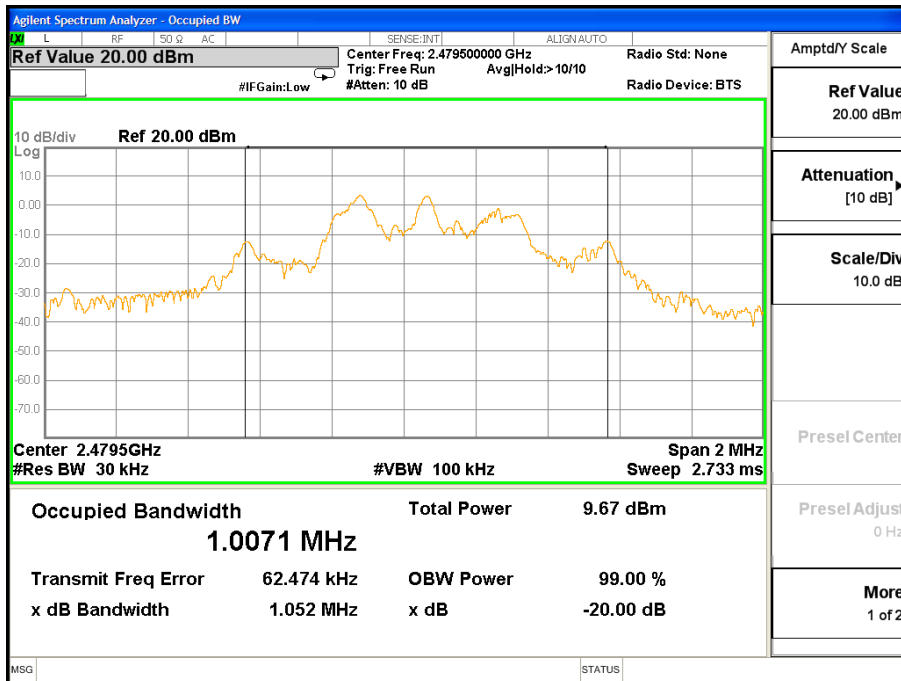

7. ANTENNA APPLICATION

7.1. Antenna requirement

The EUT'S antenna is met the requirement of FCC part 15C section 15.203.

An intentional radiator shall be designed to ensure that no antenna other than that furnished by the responsible party shall be used with the device. The use of a permanently attached antenna or of an antenna that uses a unique coupling to the intentional radiator shall be considered sufficient to comply with the provisions of this section. The manufacturer may design the unit so that a broken antenna can be replaced by the user, but the use of a standard antenna jack or electrical connector is prohibited. This requirement does not apply to carrier current devices or to devices operated under the provisions of §15.211, §15.213, §15.217, §15.219, or §15.221. Further, this requirement does not apply to intentional radiators that must be professionally installed, such as perimeter protection systems and some field disturbance sensors, or to other intentional radiators which, in accordance with §15.31(d), must be measured at the installation site. However, the installer shall be responsible for ensuring that the proper antenna is employed so that the limits in this part are not exceeded.

7.2. Result

The EUT's antenna used an antenna with glue which is permanently attached, The antenna's gain is 0dBi and meets the requirement.

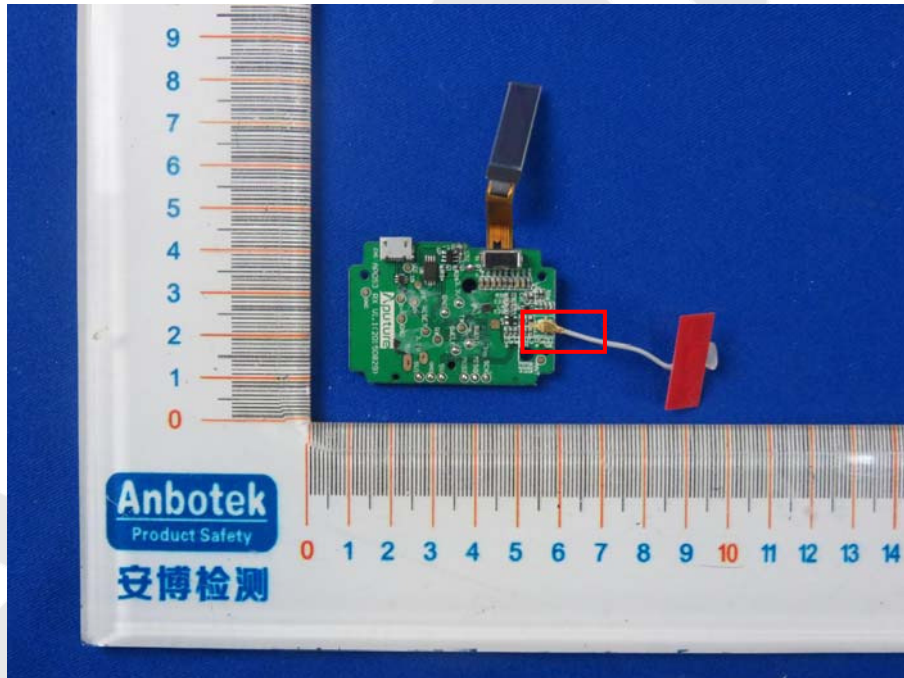

8. PHOTOGRAPH

8.1. Photo of Conducted Emission Test



8.2. Photo of Radiation Emission Test

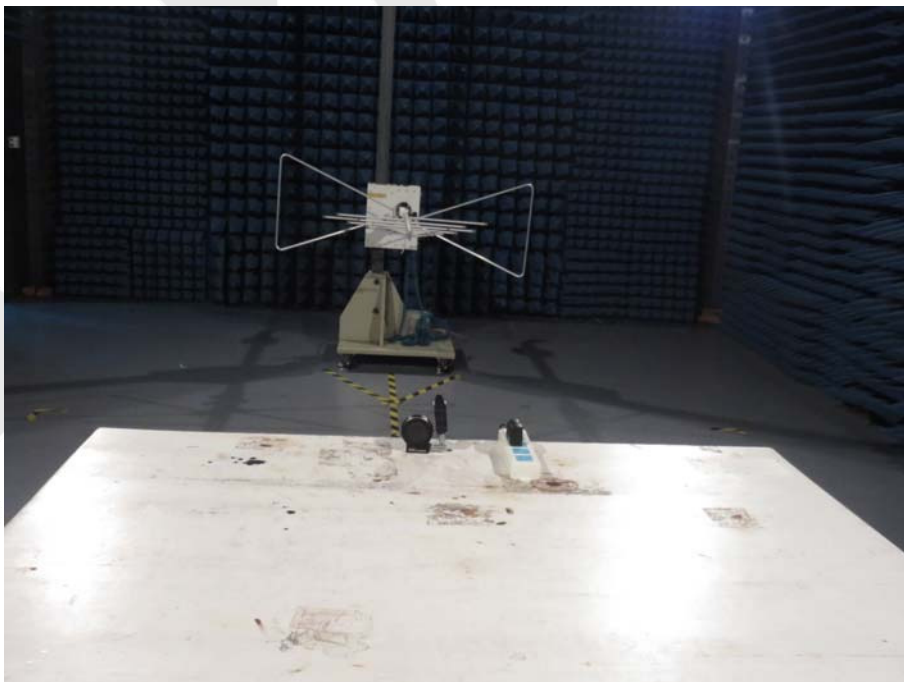

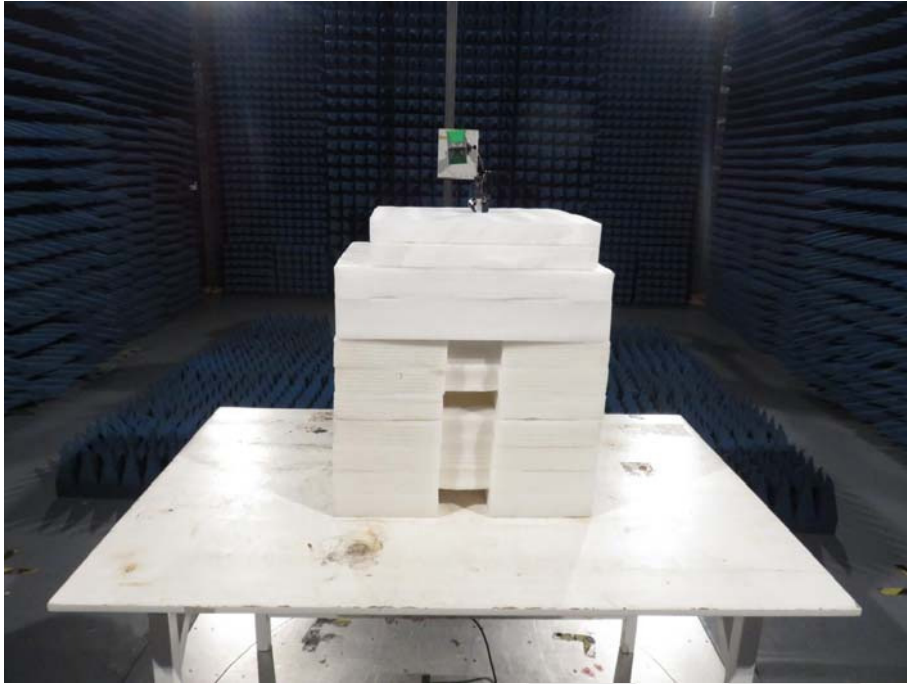

Anbotek

APPENDIX I (External Photos)

Figure 1
The EUT-Overall View



Figure 2
The EUT-Top View



Figure 3
The EUT-Bottom View



Figure 4
The EUT-Front View

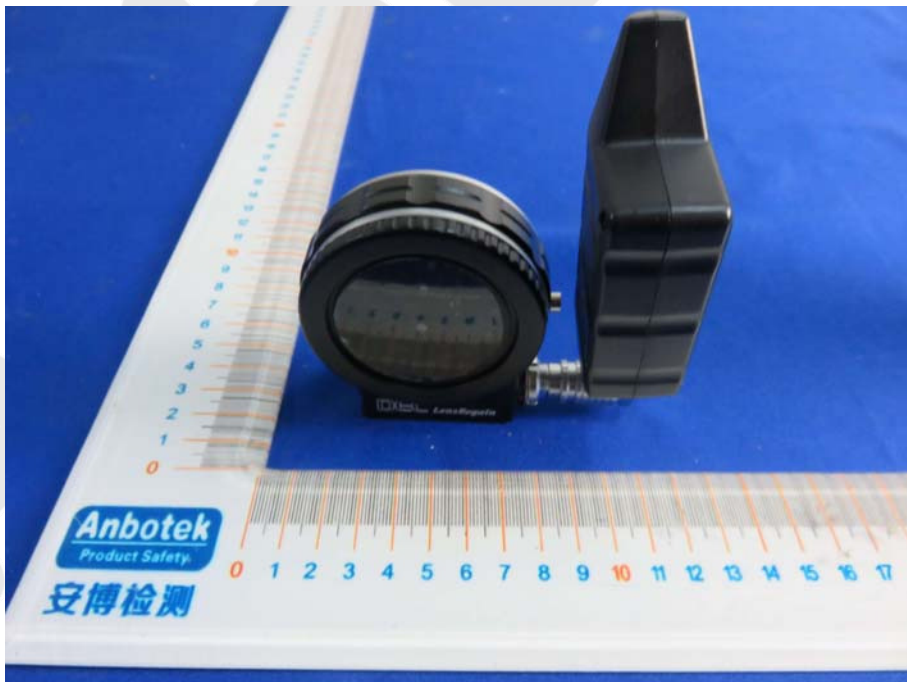

Figure 5
The EUT-Back View



Figure 6
The EUT-Right View

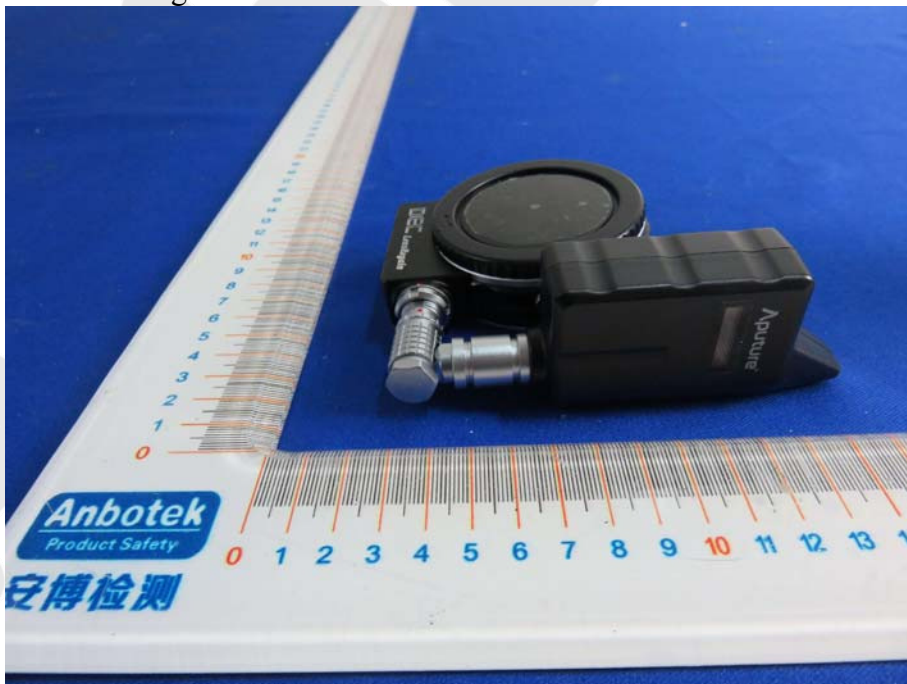

Figure 7
The EUT-Left View



APPENDIX II (Internal Photos)

Figure 8
The EUT-Inside View



Figure 9
The EUT-Battery View

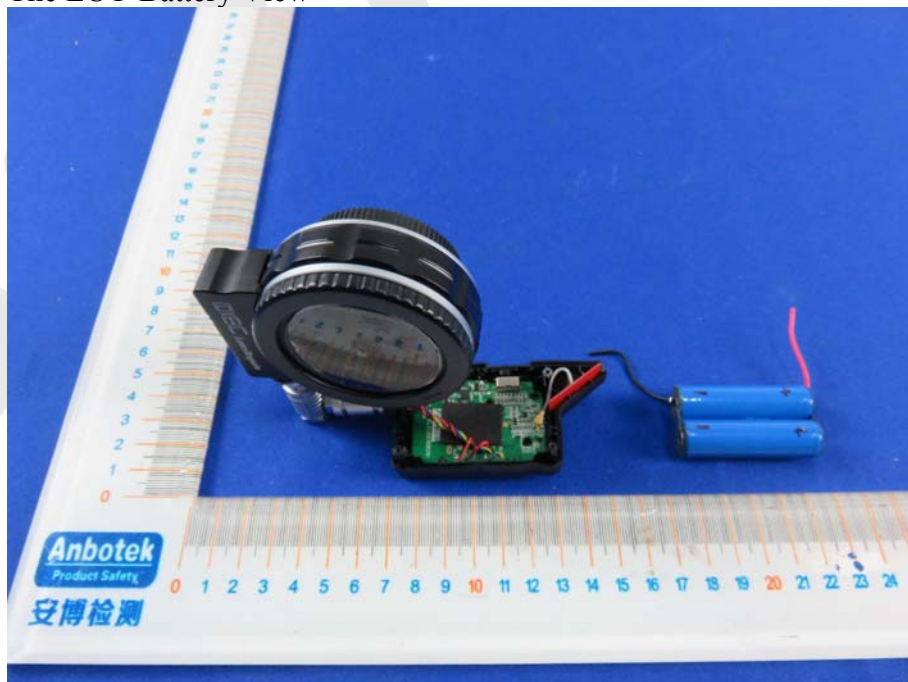

Figure 10
PCB of the EUT-Front View

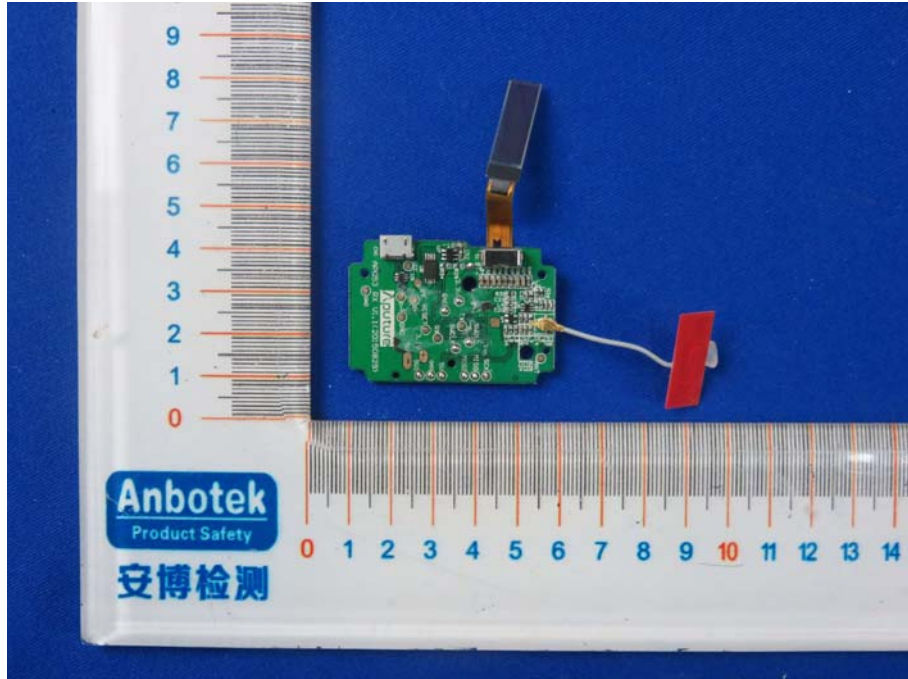

Figure 11
PCB of the EUT-Back View

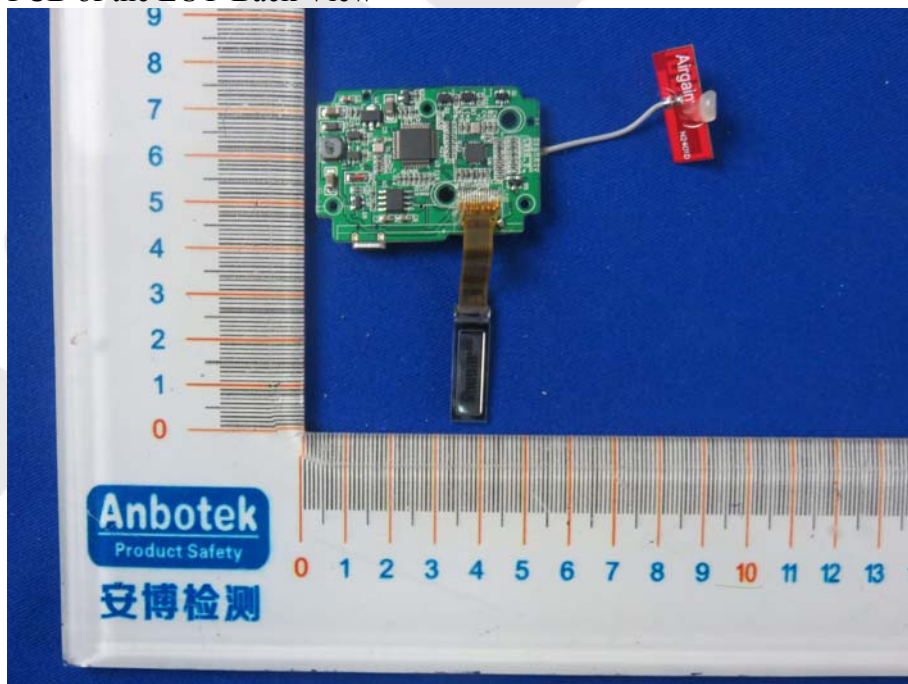

Figure 12
PCB of the EUT-Front View

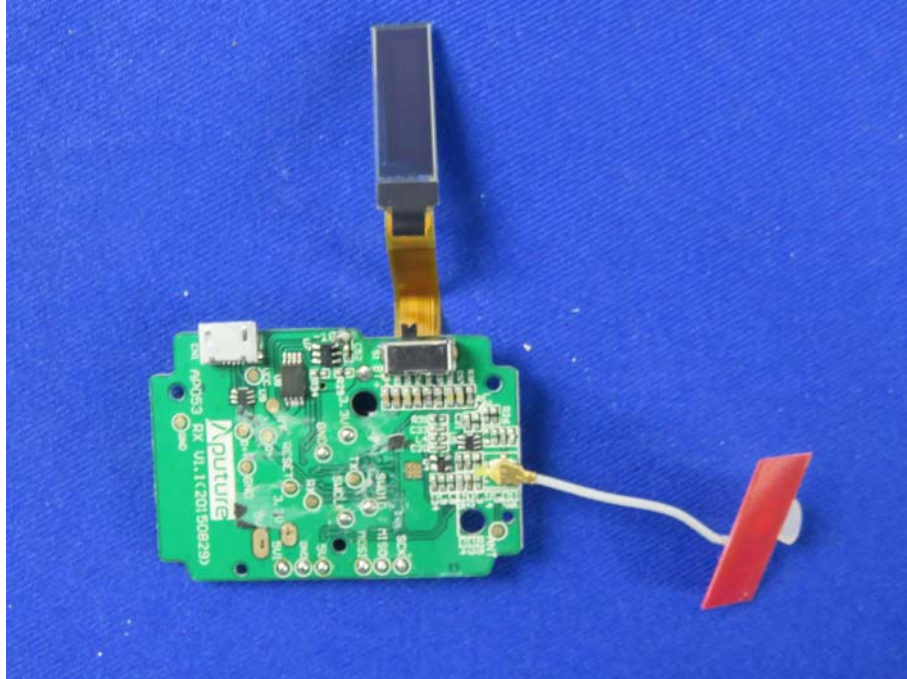

Figure 13
PCB of the EUT-Back View

