

Aputure®

Light  storm

LS 600d Pro
Product Manual

English

Foreword

Thank you for purchasing Aputure “Light Storm” LS 600d Pro.

The Aputure LS 600d Pro is a perfect fixture with big power. It owns all features of previous series products, and further it will support the battery charging under the operation and another feature of it is that it can work on raining .

IMPORTANT SAFETY INSTRUCTIONS

When using this unit, basic safety precautions should always be followed, including the following:

1. Read and understand all instructions before using.
2. Close supervision is necessary when any fixture is used by or near children. Do not leave the fixture unattended while in use.
3. Care must be taken as burns can occur from touching hot surfaces.
4. Do not operate the fixture if a cord is damaged, or if the fixture has been dropped or damaged, until it has been examined by qualified service personnel.
5. Position any power cables such that they will not be tripped over, pulled, or put into contact with hot surfaces.
6. If an extension cord is necessary, a cord with an amperage rating at least equal to that of the fixture should be used. Cords rated for less amperage than the fixture may overheat.
7. Always unplug the lighting fixture from the electrical outlet before cleaning and servicing, or when not in use. Never yank the cord to remove the plug from the outlet.

Detailed product manual for Light Storm can be found on www.aputure.com .

8. Let the lighting fixture cool completely before storing.
9. To reduce the risk of electric shock, do not immerse this fixture in water or any other liquids.
10. To reduce the risk of fire or electric shock, do not disassemble this fixture. Contact cs@aputure.com or take it to qualified service personnel when service or repair work is required. Incorrect reassembly may cause electric shock when the lighting fixture is in use.
11. The use of an accessory attachment not recommended by the manufacturer may increase the risk of fire, electric shock, or injury to any persons operating the fixture.
12. Power this fixture by connecting it to a grounded outlet.
13. Please remove the protective cover before powering on the light.
14. Please remove the protection cover before using the reflector.
15. Please do not block the ventilation and do not look at the light directly when it is powered on.
16. Please do not place the LED lighting fixture near any liquids or other flammable objects.
17. Only use a dry microfiber cloth to clean the product.
18. Please have the product checked by an authorized service personnel agent if your product has a problem.
19. The malfunctions caused by unauthorized disassembly are not covered under the warranty.
20. We recommend only using the original Aputure cable accessories. Please note that our warranty for this product does not apply to any repairs required due to any malfunctions of unauthorized Aputure accessories, although you may request such repairs for a fee.



21. This product is certified by RoHS, CE, KC, PSE, and FCC. Please operate the product in full compliance with the operation standards. Please note that this warranty does not apply to repairs arising from malfunctions, although you may request such repairs on a chargeable basis.
22. The instructions and information in this manual are based on thorough, controlled company testing procedures. Further notice will not be given if the design or specifications change.

SAVE THESE INSTRUCTIONS

FCC Compliance Statement

This device complies with Part 15 of the FCC Rules. Operation is subject to the following two conditions:

- (1) This device may not cause harmful interference.
- (2) This device must accept any interference received, including interference that may cause undesired operation.

Warning: Changes or modifications not expressly approved by the party responsible for compliance could void the user's authority to operate the equipment.

NOTE: This equipment has been tested and found to comply with the limits for a Class B digital device, pursuant to Part 15 of the FCC Rules. These limits are designed to provide reasonable protection against harmful interference in a residential installation. This equipment generates, uses, and can radiate radio frequency energy and, if not installed and used in accordance with the instructions, may cause harmful interference to radio communications. However, there is no guarantee that interference will not occur in a particular installation. If this equipment does cause harmful interference to radio or television reception, which can be determined by turning the equipment off and on, the user is encouraged to try reorient or relocate the receiving antenna.

- Increase the separation between the equipment and receiver.
- Connect the equipment to an outlet on a different circuit than the receiver is connected to.
- Consult the dealer or an experienced radio/TV technician for help.

RF Warning Statement:

This device has been evaluated to meet general RF exposure requirements. This equipment should be installed and operated with minimum distance 20cm between the radiator & your body.

Check list

Please make sure all accessories listed below are completed before using. If not, please contact with your sellers immediately.

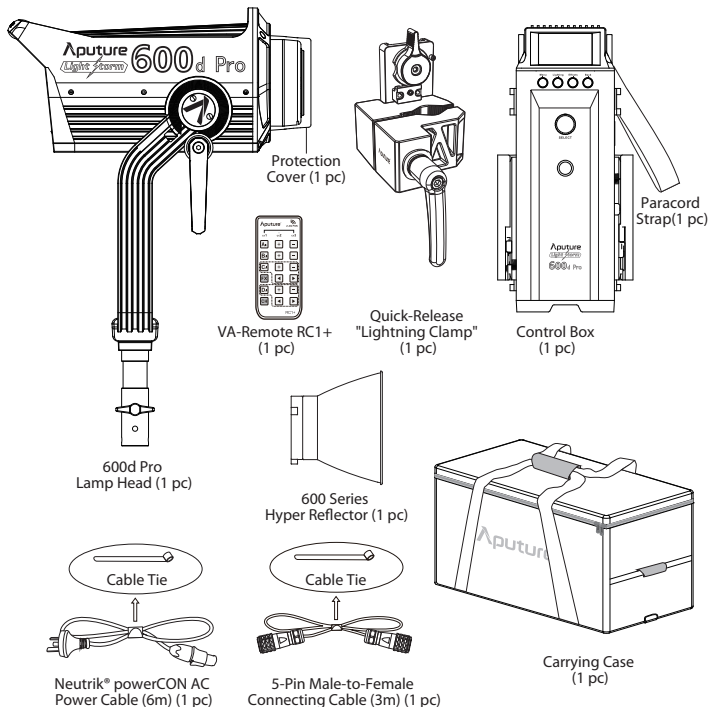

Product Details

1. Lamp Head

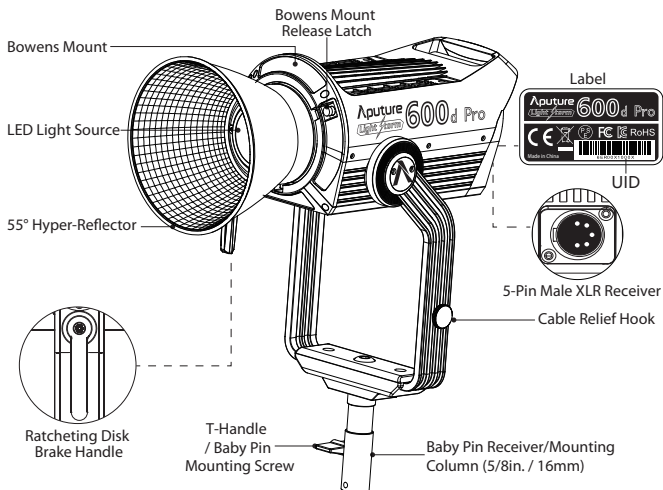

2. Control Box

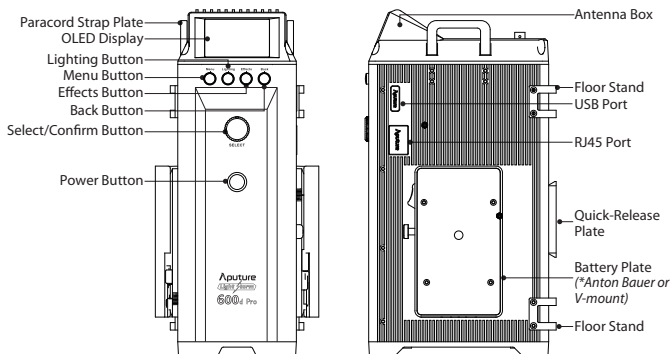

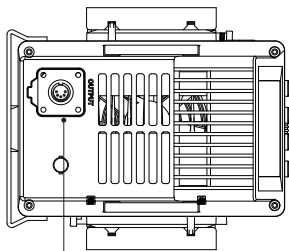

5-Pin Female XLR Power Output

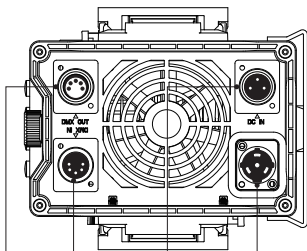

DMX OUT Port DMX IN Port Battery Input (DC) Neutrik® powerCON Power Input

3. VA-Remote RC1+

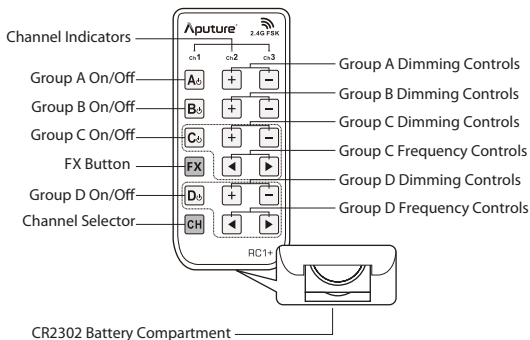

Installations

1. Attaching/detaching the protection cover

Pull back the retaining pin, rotate the cover clockwise, then detach the cover.

To reattach the cover, insert it into the Bowens mount and rotate counterclockwise.

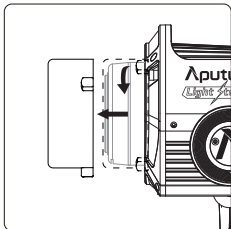
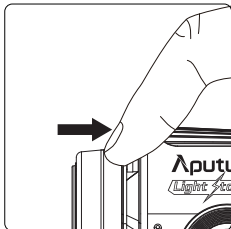

Notice: Always remove the protection cover prior to turning on the light. Always re-install the cover when packing it away.

2. Attaching/detaching the Hyper-Reflector

To install the reflector, pull back the retaining pin, insert the reflector into the Bowens mount, and rotate it counterclockwise as shown in the following pictures.

To remove the reflector, pull back the retaining pin and rotate the reflector clockwise.

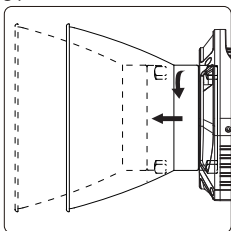
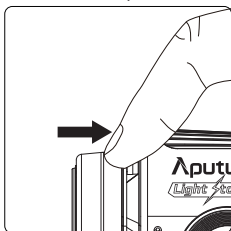

3. Setting up the Lamp Head

Mount the Lamp Head onto a light stand, then fix it in place using the T-Handle/Mounting Screw on the Baby Pin Receiver/Mounting Column (5/8in. / 16mm). Then loosen/tighten the handbrake locking mechanism on the yoke to adjust the fixture's angle of tilt.

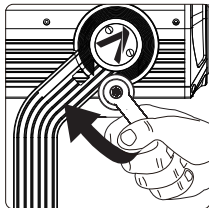
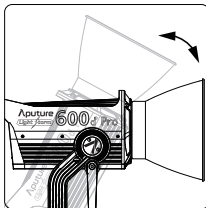
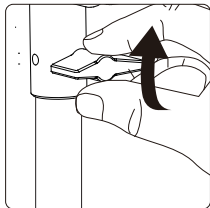

4. Instructions for the Quick-Release "Lightning Clamp"

- 1) Clamp the Lightning Clamp onto a light stand.
- 2) To attach the control box, rotate the release lever to unlock the quick-release baseplate, then mount the control box onto the Lightning Clamp (the release lever will automatically spring back).
- 3) To remove the control box, grasp it firmly, then unlock the quick-release plate by turning the release lever, and detach the control box.

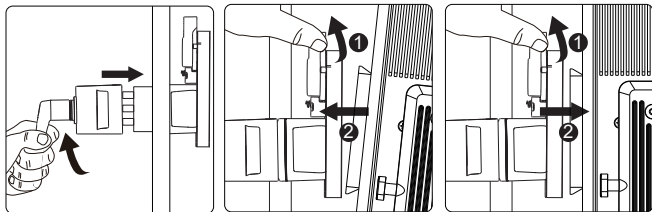

Specifications

Weight	670g / 1.48lbs	Sizes (L*W*H)	10.35x8.74x12.5cm / 4.07x3.44x4.92in
* The Quick-Release "Lightning Clamp" can clamp onto square or round pipe with a diameter between 2-5cm or 0.79-1.97in.			

5. Connect the Lamp Head to the control box

Connect the Lamp Head to the control box using the 5-Pin Male-to-Female XLR Head Cable.

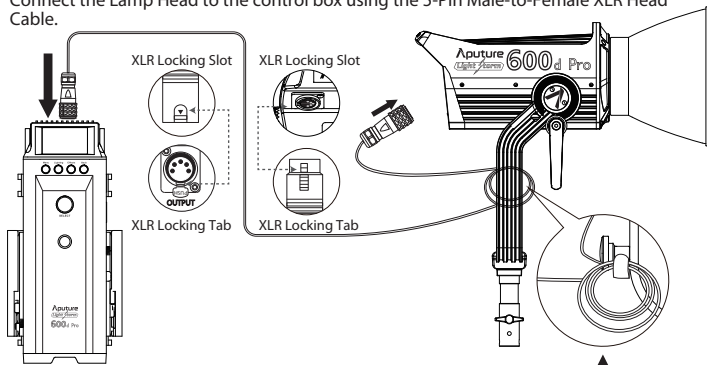

* Hang the cable from the head cable relief hook to manage and reduce tension on the cable.

* Disconnect the XLR head cable by pushing down on the locking tabs on the female XLR connectors, then remove the cable.

6. Powering up the controller

1) Powering by AC

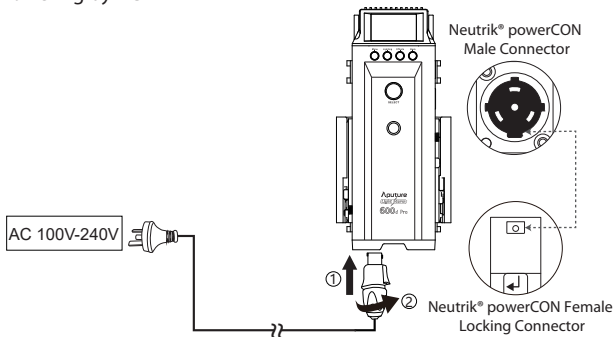

To disconnect the Neutrik® powerCON cable, pull back on the yellow release tab on the cable connector, and rotate the connector counterclockwise.

2) Powering by Batteries

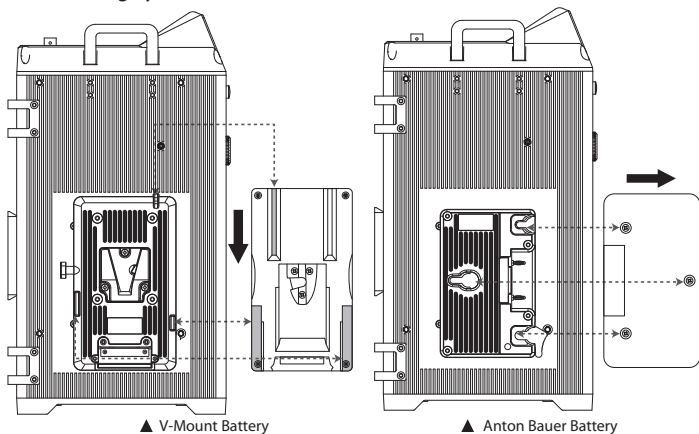

* Batteries Spec: Voltage 14.4~28.8V, but the capacity is higher 180Wh.

* Customers can choose V-Mount or A-Mount battery plates for their control boxes upon purchase according to their needs.

* It can be supported charge when the fixture operate.

Operations

1. Press the power button to turn the light on and off

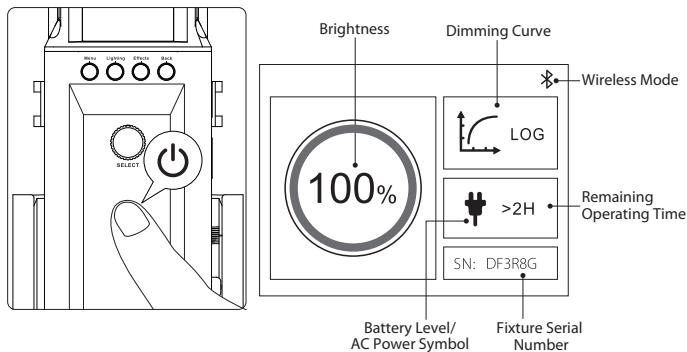

2. Manual Control

1) Rotate the select button to adjust the intensity of the light from 0-100%.

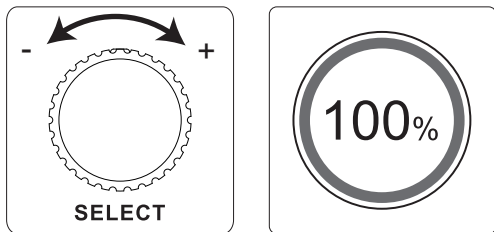

2) Press the MENU button to enter the system menu interface, They are DMX Mode、 Dimming curve、 Fan Mode、 Studio Mode、 Control System、 Language、 Update、 Effects.

2.1) DMX Mode

Press the MENU button to enter the system menu, rotate the select knob to select DMX Mode, and press the select button again to enter DMX Mode.

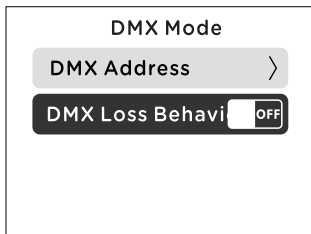

2.2) Dimming curve

Press the MENU button to enter the system menu, rotate the select knob to select Dimming Curve, and press the select button again to enter the dimming curve. rotate the select knob can choose your choice from exponential (Exp), logarithmic (Log), S-Curve, or linear dimming curves.

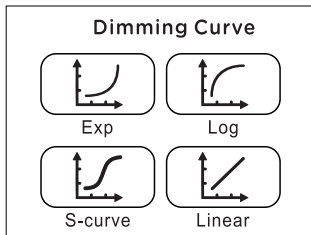

2.3) Fan Mode

Press the MENU button to enter the system menu, rotate the select knob to select Fan Mode, and press the select button again to enter Fan Mode. And you can select on or off.

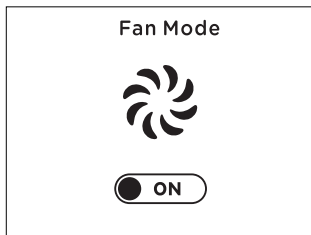

2.4) Studio Mode

Press the MENU button to enter the system menu, rotate the select knob to select Studio Mode, and press the select button again to enter the Studio Mode. Via press select button can choose "YES" or "NO".

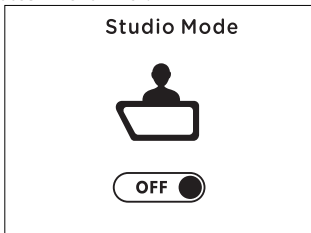

2.5) Control System

There are 4 control systems on it, namely Bluetooth、2.4G、Lumenradio and Art-Net.

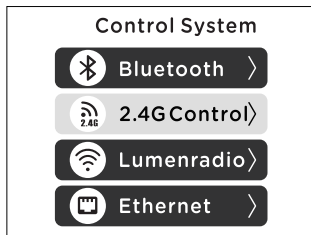

2.5.1) Bluetooth

(1) Under the control system, rotate the select knob to select on or off or Bluetooth Reset. Press the select button again to enter the Bluetooth Menu. Use the wheel to select "YES" to reset the Bluetooth pairing (the pop-up window displays the current reset progress and is completed within 2 seconds); or select "NO" to return to the previous menu.

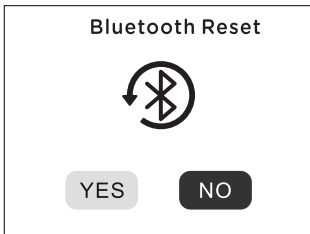
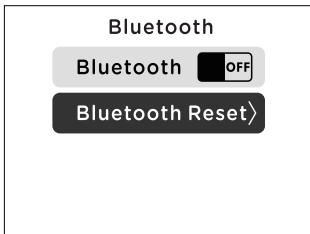

(2) After resetting the light's Bluetooth connection, your mobile phone or tablet will be able to connect to and control the light;If the Bluetooth Reset fails, a [Reset Failed] screen will pop-up, and the light will return to Bluetooth mode after 2 seconds.

2.5.2) 2.4G Control

Under the control system, rotate the select knob to select 2.4G Control.Press the select button again to enter the 2.4G Control.You can adjust on or off- channel and group via rotate and press select button.

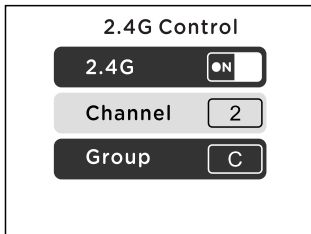

2.5.3) Lumenradio

Under the control system, rotate the select knob to select Lumenradio.Press the select button again to enter the Lumenradio, You can adjust on or off- pair via rotate and press select button.

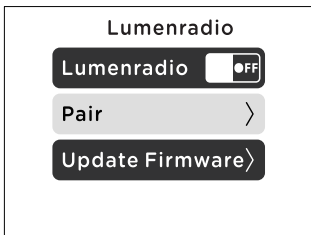

2.5.4) Art-Net

Under the control system, rotate the select knob to select Art-Net. Press the select button again to enter the Art-Net, You can see the information of Local IP、 Remote IP、 Gateway and MAC Address.

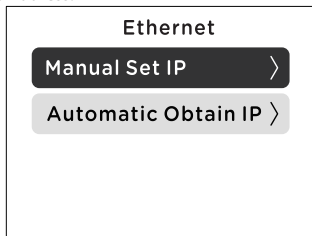

2.6) Language

Press the MENU button to enter the system menu, rotate the select knob to select Language, and press the select button again to enter the Language menu. Use the knob to select from the available languages. Initial languages include "English" and "Chinese".



2.7) Update

Press the MENU button to enter the system menu, rotate the select knob to select Update, and press the select button again to enter the Update. Under update, you can update firmware, also you can check the Firmware Version via rotate and press select knob.



2.8) Effects

Press the MENU button to enter the system menu, rotate the select knob to select Effects, and press the select button again to enter the Effects toggled between Paparazzi, Fireworks, Faulty Bulb, Lightning, TV, Pulsing, Strobe, Explosion.

a. Paparazzi Effect

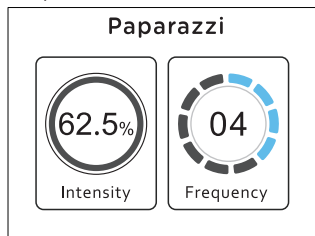

b. Fireworks Effect

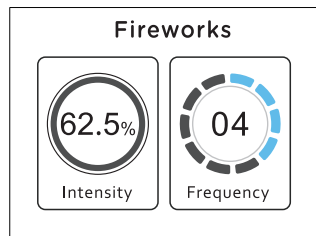

c. Faulty Bulb Effect

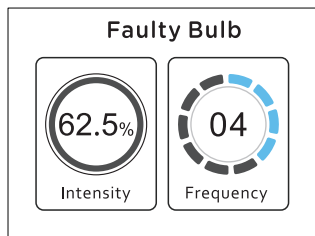

d. Lightning Effect*

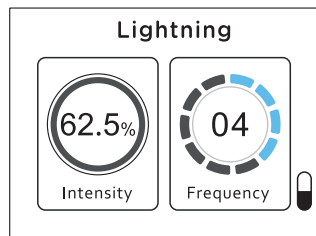

* In lightning mode, short press the Effects button to single trigger the light effect.

e. TV Effect

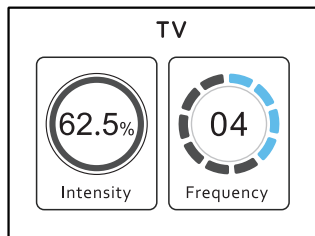

f. Pulsing Effect

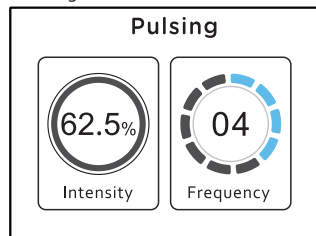

g. Strobe Effect

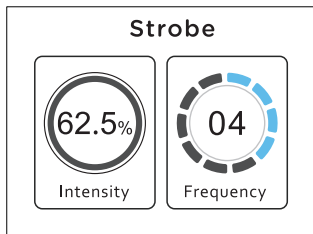

h. Explosion Effect*

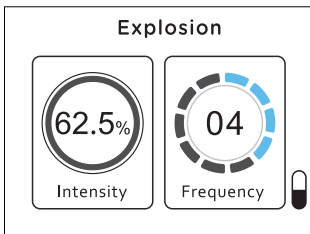

* In explosion mode, short press the Effects button to single trigger the light effect.

When in Lighting FX mode, short press the "select" button to enter Intensity Adjustment Mode. Then rotate the select wheel to adjust the intensity from 0% to 100% as displayed on the screen.

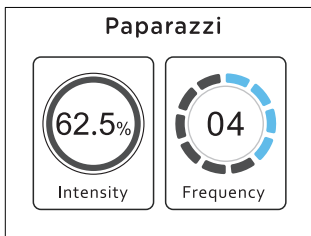

When in Lighting FX menu, short press the "select" button to enter Frequency Adjustment Mode. Then rotate the select wheel to adjust the frequency of the effect from 1 to 10 and R(Random) as displayed on the screen.

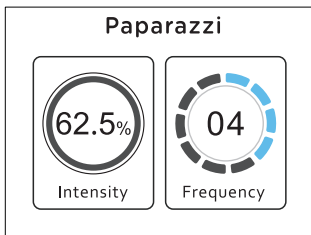

* If the light is powered off, upon turning on again, the light resumes its last saved setting.

3) You can return lighting interface whatever under any status via press Lighting button.

4) You can return effects interface whatever under any status via press Effects button.

5) You can also do an OTA wireless firmware update using the Sidus Link mobile app.

3. Remote Control

You can control the LS 600d Pro from any channel or group configuration.

* Light Storm lights have three channels (1/2/3) and four groups (A/B/C/D).

* Only groups "C" or "D" can be used to control brightness and lighting effects, while groups "A" and "B" can only be used to control brightness.

1) Configuring channel settings on the remote



Press the CH button to toggle between channels 1, 2, and 3)



"ch2" indicator lights

2) Adjusting brightness

Press A/B/C/D to toggle the lights on or off, press (+ / -) to adjust the brightness of the light from 0 to 100% accordingly.

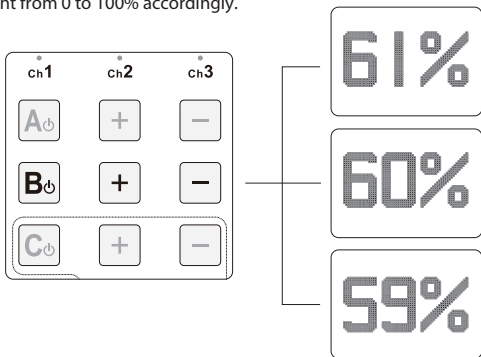

* This remote will not work when the light is in DMX mode.

** The remote control will only control the operation of the light when the fixture is in 2.4Ghz Wireless Control Mode.

3) FX Control

Press the (FX) + (C₀) / (D₀) button to enter or exit lighting effect mode. Press the

(FX) + (+) / (-) to toggle between different effects.

Press the (+) / (-) buttons to adjust the output of the light. Press the (◀) / (▶) buttons to toggle the effect frequency.

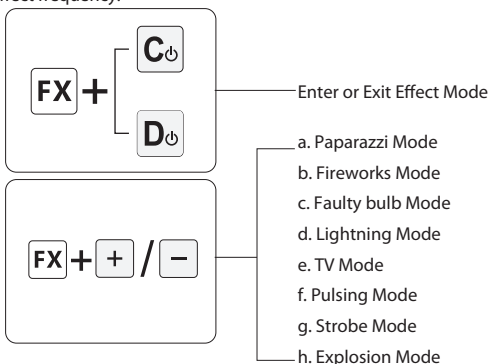

* The remote control can only be used to operate lighting effects if the lights are in groups C or D.

4. Connecting to DMX

1) Connect a standard DMX controller

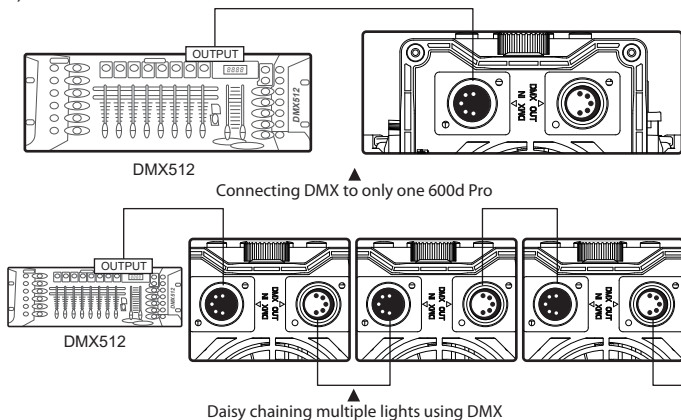

* The DMX interface schematic is shown in the pictures below:

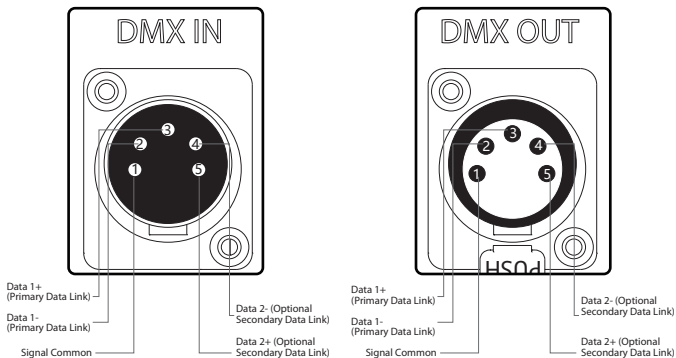

2) Channel Selection

In DMX mode, match the channel of your DMX controller with the light, and then adjust accordingly.

* The default DMX channel is "001".

** The range of DMX channels is 1 to 512.

5. Controlling Device Via DMX

1) Connect the DMX controller's OUTPUT to the 600d Pro's controller INPUT as shown in the figure below.

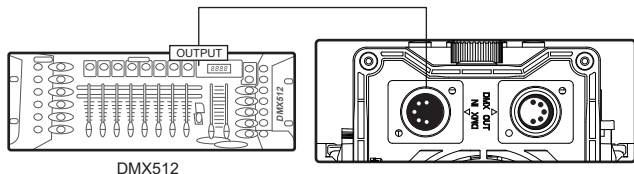

2) DMX Chart

DMX Channel Values / Functions (5 DMX Channels)		
Channel	Value	Function
1		Dimmer
	0-255	Intensity 0 to 100%
2		Mode Selection
	0-127	Manual Mode
	128-255	FX Mode
3		FX Control
	0-19	Paparazzi
	20-39	Fireworks
	40-59	Fault Bulb
	60-79	Lightning
	80-99	TV
	100-119	Pulsing
	120-139	Strobe
	140-159	Explosion
	160-255	Undefined
		FX Frequency Control
	0-19	1

4	20-39	2
	40-59	3
	60-79	4
	80-99	5
	100-119	6
	120-139	7
	140-159	8
	160-179	9
	180-199	10
	200-219	R
5	220-255	Undefined
		IN Lightning mode
	0-9	Start Point
	10-127	Single Trigger
	128-255	Cycle Mode
		IN Explosion Mode
	0-9	Start Point
	10-127	Single Trigger
128-255	Undefined	

* In DMX mode, intensity, FX frequency and lighting effects can only be controlled by a DMX controller.

** When controlling multiple 600d Pro lights independently (i.e., A and B), offset each light by 5 channels. If you set light A at DMX 001, set light B at DMX 006, to control A and B separately on the DMX controller.

6. Using the Sidus Link APP

You can download the Sidus Link app from the iOS App Store or Google Play Store for enhancing the functionality of the light. Please visit sidus.link/app/help for more details regarding how to use the app to control your Aputure lights.



Get Sidus Link® App



[Sidus.link/app/help](https://sidus.link/app/help)

Specifications

Operating Current	8A	Power Supply	100V~240V 50Hz/60Hz
Power Input	≤720W	Power Output	≤600W
CRI	≥96	TLCI	≥96
CQS	≥95	Radio Frequency	2.4GHz
Channels	1/2/3	Groups	A/B/C/D
CCT	5600±200K	Waterproof Grade	IP54
Battery requirement	14.4V-15A ≥180Wh 26V-8.5A ≥180Wh 28.8V-7.5A ≥180Wh	Cooling Mode	Active Cooling
Remote Ability	≤100 metre	APP Control Type	Bluetooth
Sizes (L*W*H)	Lamp Head	30.78*24.36*15.01cm/12.12*9.59*5.91 in	
	Controller box Anton Bauer Battery	32.83*17.56*14.11cm/12.93*6.91*5.56 in	
	Controller box (V-Mount)	32.83*17.56*14.54cm/12.93*6.91*5.72 in	

Photometrics

Distance	1m	3m	5m
Bare Bulb	22150 (lux)	2600 (lux)	1020 (lux)
	2058 (fc)	242 (fc)	95 (fc)
Hyper-Reflector	98500 (lux)	8500 (lux)	3000 (lux)
	9150 (fc)	790 (fc)	280 (fc)

** This is an averaged result, the number might be slightly different on each light.*

Trademarks

Bowens is a trademark registered by Bowens in China and other countries.

Anton Bauer is a trademark registered by Anton Bauer in the US and other countries.

Neutrik® is a trademark registered by Neutrik® in the US and other countries.

Aputure[®]
爱图仕

Light Storm
光 · 风暴

LS 600d Pro
使用者指南

中文

前言

感谢您购买爱图仕“光·风暴”系列LED摄影灯—LS 600d Pro。

爱图仕LS 600d Pro 是一款大功率LED灯具。它拥有以往光风暴系列产品所有的特性，并且在工作中支持电池充电，另外一个显著特点是雨天也能正常工作。

重要的安全说明

使用此摄影灯时，应始终遵循基本的安全预防措施，包括：

1. 使用前阅读并理解所有说明。
2. 当儿童靠近设备或使用设备时，必须进行密切监督。在使用设备时，请勿将设备置于无人看管状态。
3. 必须小心接触高温部件防止被烫伤。
4. 请勿操作电源线损坏的设备以及掉落或损坏的设备，直到合格的维修人员检查过。
5. 请归置好电源线，防止被电源线绊倒或拉扯电源线导致设备断电，且电源线不可接触灼热表面。
6. 如果需要延长线，应使用额定电流至少等于设备额定电流的延长线。额定电流小于设备的电线可能过热。
7. 在清洁和维修之前以及不使用时，务必从电源插座上拔下电器插头。切勿拉扯电线从插座拔出插头，应抓住插头并拉动来拔出。
8. 在存放前让设备完全冷却。存放时，请将电源线从设备上拔出，待冷却后归置在手提包对应位置。
9. 为降低电击风险，请勿将本产品浸入水中或其他液体中。

- 10.为降低电击风险，请勿拆卸本产品，在需要维修时将其交给合格的维修人员。不正确的重装可能会在随后使用设备时引起电击。
- 11.使用非制造商推荐的配件可能会引起火灾、电击或人身伤害。
- 12.请将本产品连接到接地插座。
- 13.使用前请将保护罩取下。
- 14.使用标准罩前将EVA内托取下。
- 15.本产品工作时，请勿遮挡散热孔，勿直视灯珠；
任何情况下勿触摸灯珠。
- 16.勿将本产品置于液体或其他易燃，易挥发溶剂附近，避免损坏产品。
- 17.请用软布、干布清洁本设备。
- 18.请勿在潮湿的环境下使用本设备，否则有短路或电击的危险。
- 19.需要维修时请联系授权的维修人员。本设备内有精密电子线路。未经许可擅自拆卸导致故障不在本司保修范围内，但用户可以付费维修。
- 20.建议使用爱图仕原厂线缆。由于使用非爱图仕原厂附件导致本产品的任何损坏，不在本司保修范围内，但用户可以付费维修。
- 21.本产品已通过RoHS, CE, KC, PSE和FCC认证，请参考相关国家标准使用和操作。因使用操作不当而造成机器损坏，不在保修范围内，但用户可以付费维修。
- 22.此使用者指南依据本公司严格测试制定。设计和规格如有变更，恕不另行通知。



保存这些说明

FCC 符合声明:

此设备符合 FCC 规则第 15 部分中的规范。操作设备须符合以下两个条件:

- (1) 此设备不会导致有害干扰;
- (2) 此设备可承受任何外来干扰, 包括可能导致非预期操作的干扰。

【警告】 如果用户未经爱图仕明确许可而进行改动或改装, 可能会丧失继续操作该设备的权利。

【注】 此设备经测试确定符合 B 类数码设备 (依照 FCC 规则第 15 部分规范) 的限制。这些限制的设计旨在为居住场所安装条件下的有害干扰提供合理的保护。此设备生成、使用并可以发射射频能量。如果未按照指示安装和使用, 可能对无线电通信造成有害干扰。但是, 在特定安装条件下, 不保证这类干扰不会发生。如果此设备确实对无线电或电视机接收信号造成有害干扰, 而这点可以通过关闭和打开设备来确定, 那么建议用户尝试使用以下一种或多种措施来消除干扰:

- 扩大设备与接收器之间的距离。
- 将设备连接到其他电路的插座中, 而不是接收器所连接电路的插座。
- 咨询经销商或有经验的无线电/电视机技术人员以获得帮助。

FCC 辐射暴露声明

本设备符合 FCC 针对未受控制环境所制定的辐射暴露限制。

物品清单

使用本产品前，请检查包装内是否包含所有以下物品。如有缺失，请与经销商联系。

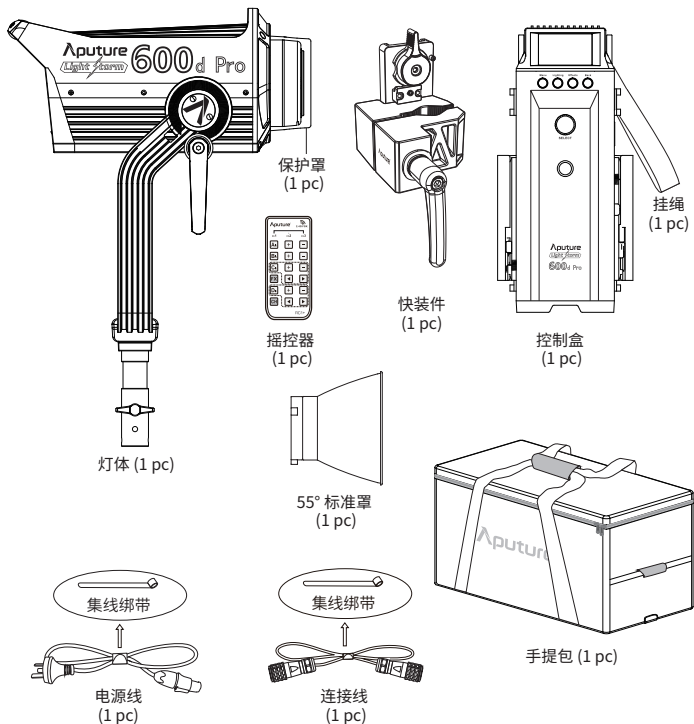

产品视图

1. 灯体

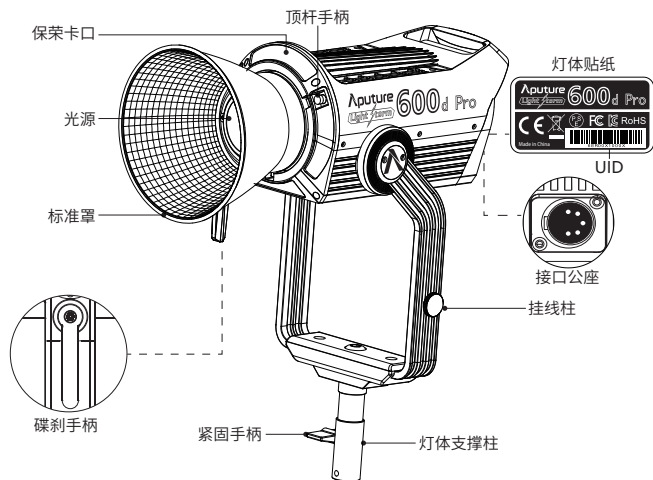

2. 控制盒

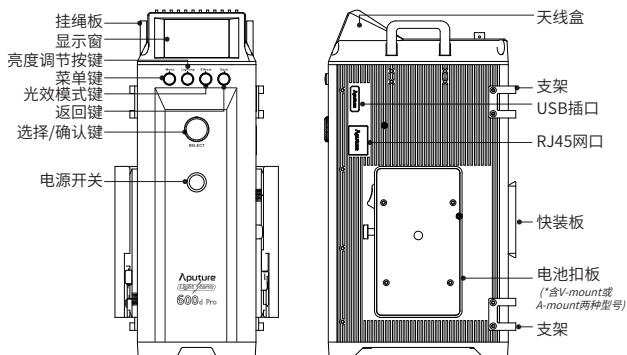

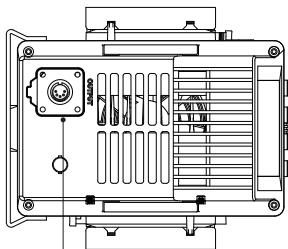

控制盒输出接口

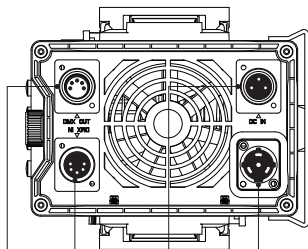

DMX OUT
接口

DMX IN
接口

电池输入接口
(DC)

NEUTRIK®
电源接口

3. 遥控器

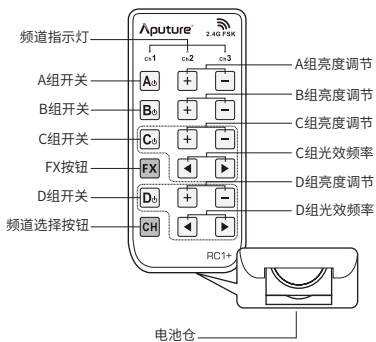

安装

1. 保护罩的拆卸与安装

按照图示箭头方向拨顶杆手柄，同时将保护罩旋转拔出。反方向旋转则将保护罩装入。

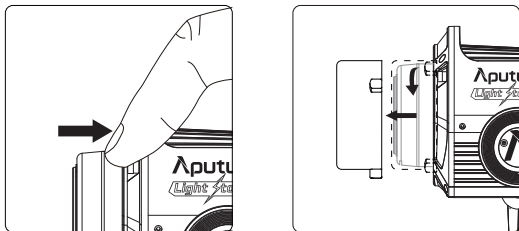

* 使用时, 务必将保护罩拔出, 否则会烧掉。不使用时, 将保护罩装入以保护灯头。

2. 标准罩的安装与拆卸

按照图示箭头方向拨顶杆手柄，同时将标准罩旋转装入。反方向旋转则将标准罩拔出。

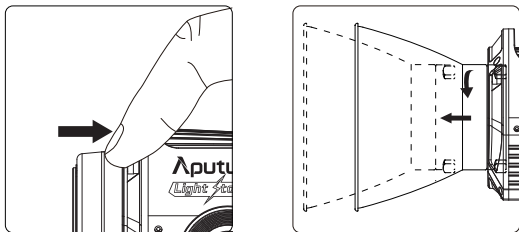

3. 固定灯体

调节灯体到合适角度，旋转紧固手柄安装灯体在三脚架上，再旋转把手固定灯体。

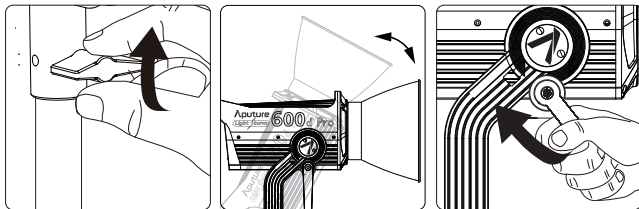

4. 快装件使用说明

- 1) 将快装件装到灯架或支架上；
- 2) 打开快装件旋柄，将控制盒装进快装件（旋钮自动弹回）；
- 3) 打开快装件（必须抓住控制盒，不然会摔落），取下控制盒。

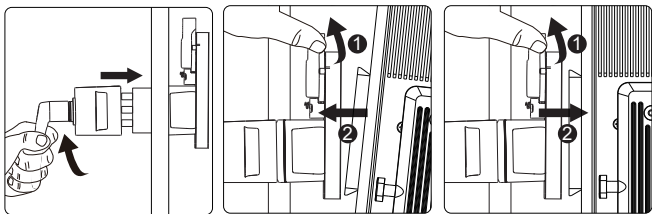

快装件规格

重量	670g / 1.48lbs	尺寸（长X宽X高）	10.35x8.74x12.5cm / 4.07x3.44x4.92in
* 快装件能夹直径2-5cm / 0.79-1.97in的圆管或方管。			

5. 连接灯体和控制盒

用连接线连接灯体和控制盒（如图）。

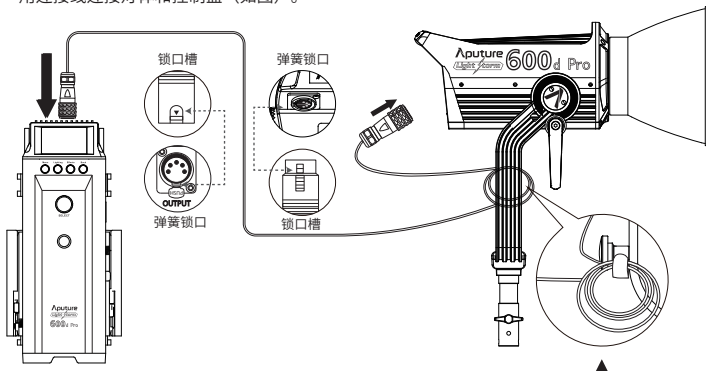

* 您可将绑有连接线的集线绑带系到挂线柱上

* 拆卸连接线时，请压住灯体和控制盒上的弹簧锁口再拆卸，切勿硬拔。

6. 供电

1) 交流电供电

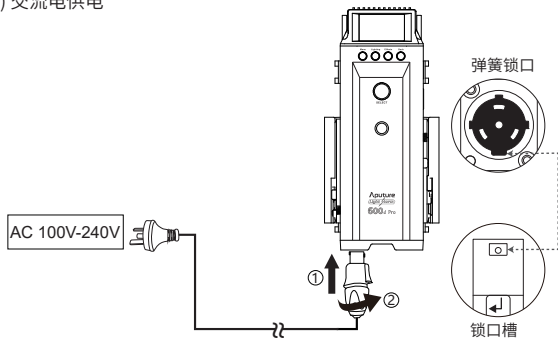

* 拆卸电源线时，请下拉电源线上的弹簧锁口按钮再拆卸，切勿硬拔。

2) 电池供电

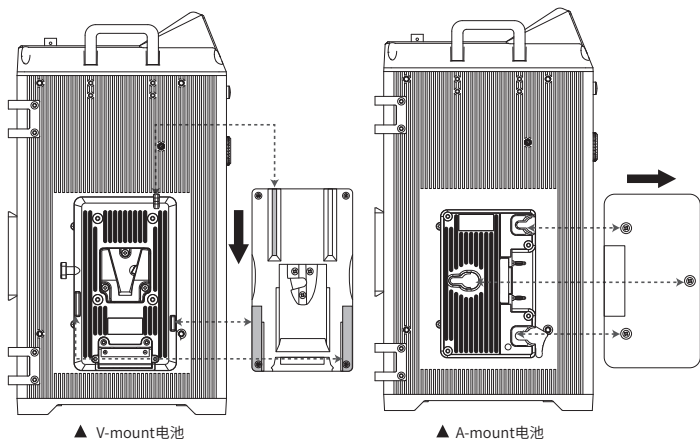

* 电池规格：支持14.4~28.8V的电池使用，但容量必须大于180Wh。

* 客户可以根据需要购买V扣或A扣电池。

* 当灯具在工作时，也可对电池充电。

操作

1. 接通电源，打开控制盒电源开关。

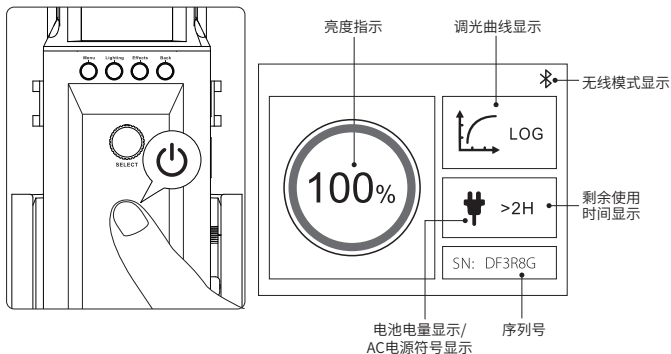

2. 控制盒手动控制

1) 旋转选择按键旋钮来调节亮度，顺时针变强，逆时针变弱。可实现无级调节。

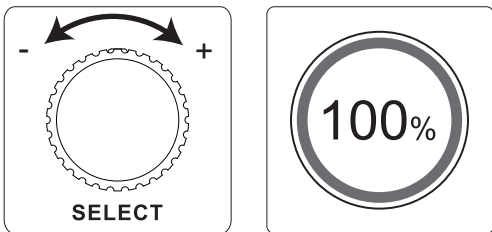

2) 短按Select键，进入菜单界面，包含DMX模式、调光曲线、风扇模式、演播室模式、控制系统、语言、系统更新、光效。

2.1) DMX模式

按MENU键进入菜单界面，旋转Select键并选择进入DMX模式。



2.2) 调光曲线

按MENU键进入菜单模式，旋转Select键并选择进入调光曲线，可以选择对应的指数型、对数型、“S”型、线型曲线。

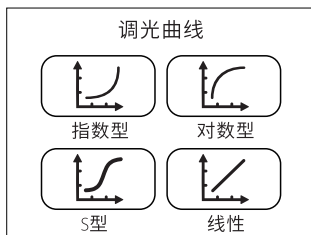

2.3) 风扇模式

按MENU键进入菜单模式，旋转Select键并选择进入风扇模式，可以选择开或关。



2.4) 演播室模式

按MENU键进入菜单模式，旋转Select键选择演播厅模式，短按Select键进入演播厅模式菜单，再旋转Select键选择“是”或“否”，短按Select键开启或关闭演播厅模式。



2.5) 控制系统

有四种控制方式，它们分别是蓝牙、2.4G、Lumenradio和以太网。



2.5.1) 蓝牙

(1) 在控制界面，旋转Select键选择演蓝牙模式，短按Select键进入演蓝牙子模式，可以选择开与关或蓝牙重置，蓝牙重置界面可以选择升级或返回上菜单。



(2) 蓝牙重置成功后，可使用智能终端（手机或平板电脑）与灯进行配对连接，连接成功后，可以对灯进行相关控制；如果蓝牙重置不成功，将会弹出界面【Reset Failed】，显示2秒后返回蓝牙界面。

2.5.2) 2.4G 控制

在控制界面，旋转Select键选择2.4G 模式，短按menu键进入2.4G子界面，通过旋转、按压Select键可以调节2.4G的开关、频道以及群组的选择。



2.5.3) Lumenradio

在控制界面，旋转Select键选择Lumenradio 模式，短按Select键进入lumenradio子界面，通过旋转、按压Select键可以调节Lumenradio的开关、以及配对状况。



2.5.4) 以太网

在控制界面，旋转Select键选择以太网，短按Select键进入以太网子界面，你可以看到子网、IP地址、网关以及MAC地址。

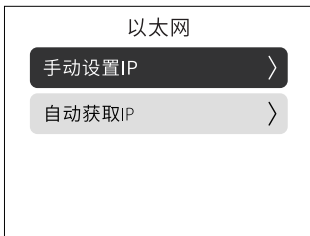

2.6) 语言

按MENU键进入菜单模式，旋转Select键选择Language，短按Select键进入语言菜单，旋转Select键选择English或中文，再短按Select键确认选择。



2.7) 系统更新

按MENU键进入菜单模式，旋转Select键选择升级，短按Select键进入升级菜单，在升级子界面可以升级固件，也可以查看固件版本号。



2.8) 光效

按MENU键进入菜单模式，旋转Select键选择光效，短按Select键进入光效子界面，可以选择狗仔队模式、烟花模式、故障灯泡模式、闪电模式、电视模式、脉搏模式、闪光灯模式、爆炸模式。

a. 狗仔队模式

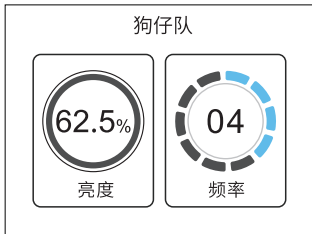

b. 烟花模式

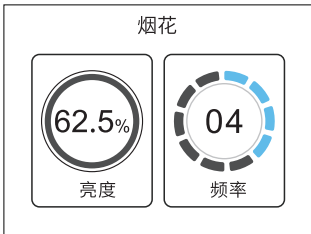

c. 故障灯泡模式

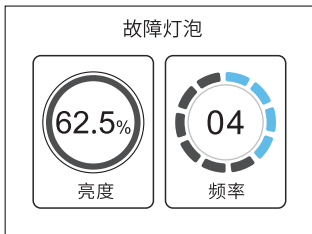

d. 闪电模式

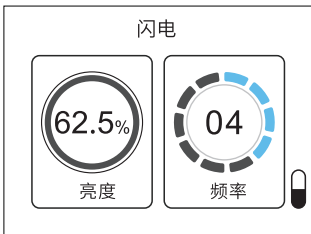

* 闪电模式下，需通过Effects按键触发光效，短按一次Effects按键触发一次光效。

e. 电视模式

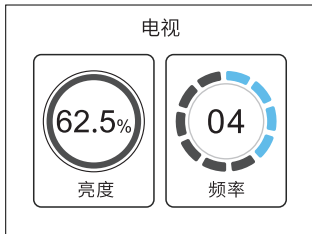

f. 脉搏模式

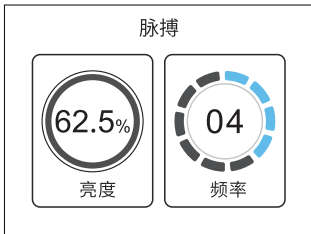

g. 闪光灯模式

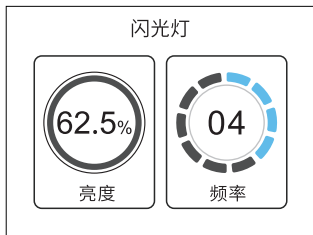

h. 爆炸模式

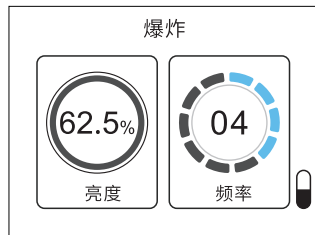

*爆炸模式下，需通过Effects按键触发光效，短按一次Effects按键触发一次光效。

短按select键选择亮度调整，如下图，再调节旋钮改变灯的亮度值，亮度调节范围为0%~100%。

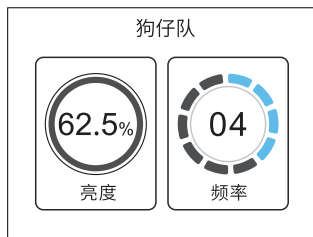

短按select键选择频率调整，如下图，再调节旋钮改变灯的频率值，频率调节范围为1~10，R（随机）。

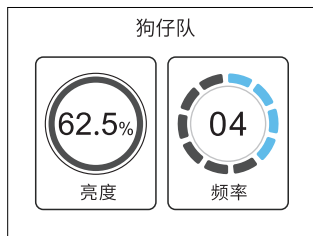

*光效模式下，若突然断电，机器再次上电后，OLED屏显示断电前的界面并根据界面的数值作响应。

3) 可以通过按压Lighting按键直接返回常规灯光界面，无论处于什么状态下。

4) 可以通过按压Effects按键快速回到光效界面，无论处于什么状态下。

5) 固件升级可以通过Sidus Link app进行OTA在线升级更新。

3. 遥控器远程遥控

设置遥控频道为2，群组为B时，控制亮度可按如下操作：

* 光·风暴控制盒和遥控器分1、2、3三个频道和A、B、C、D四个群组。

* A、B只能控制亮度，C、D控制亮度和光效的选择。

1) 遥控器设置和显示

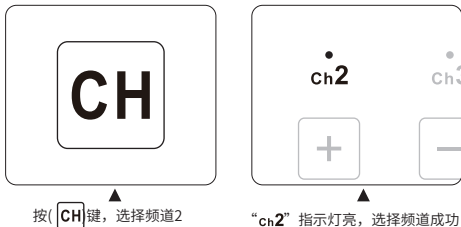

2) 亮度调节

按遥控器B组的(+) / (-)按键调节亮度，亮度以0.1%的变量均匀变化。亮度可调节范围为0~100%。

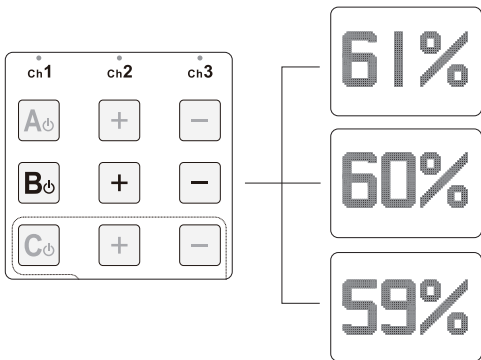

* DMX、DMX光效模式下，不可以进行遥控操作。

* 使用遥控器进行调节操作，必须切换至2.4G模式，否则操作无效。

(3) 光效控制

按遥控器的(FX+ C_⏻ / D_⏻)按键进入或退出光效模式, 按(FX+ + / -)切换光效模式。

按遥控器的(+ / -)控制光效的亮度, 按(◀ / ▶)控制光效的频率。

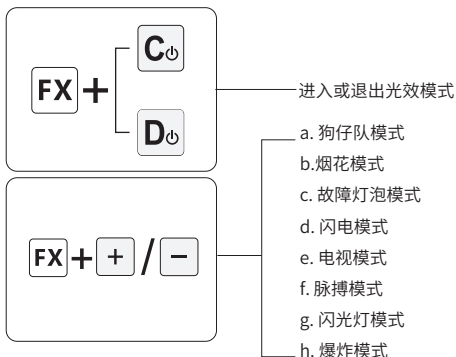

* 遥控器只能在灯处于C或D组时用于控制光效。

4. DMX控制台控制

1) 连接DMX标准控制台与光·风暴LS 600d Pro。

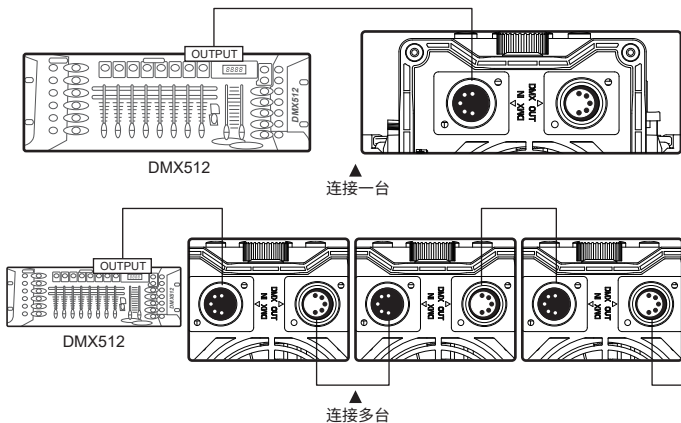

*DMX接口定义如图所示：

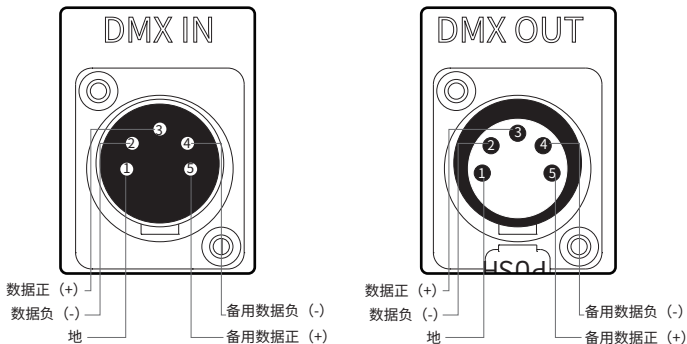

2) 频道选择

DMX控制台通道数与控制盒DMX通道数保持一致时，可使用控制台进行亮度调节操作。
适用于单台或多台连接方式。

*光·风暴在DMX模式下，控制通道号出厂默认值为1。

*光·风暴在DMX模式下，LS 600d Pro可设置通道范围为1-512。

5. DMX控制操作

1) DMX控制台与控制盒连接，见下图所示

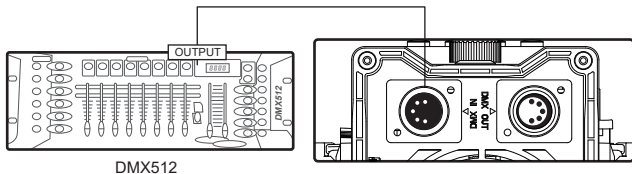

2) DMX 实用表

DMX 频道数值-功能对应表 (5个频道)		
频道	数值	功能
1		亮度调节
	0-255	亮度0-100%
2		模式选择
	0-127	常规模式
	128-255	光效模式
3		光效控制
	0-19	狗仔队
	20-39	烟花
	40-59	故障灯
	60-79	闪电
	80-99	电视
	100-119	脉搏
	120-139	闪光灯
	140-159	爆炸
	160-255	备用
		频率控制
	0-19	1档
4	20-39	2档
	40-59	3档
	60-79	4档
	80-99	5档
	100-119	6档
	120-139	7档
	140-159	8档
	160-179	9档
	180-199	10档
	200-219	R档
220-255	备用	
5		闪电模式
	0-9	起始点
	10-127	单次触发
	128-255	循环模式
		爆炸模式
	0-9	起始点
	10-127	单次触发
	128-255	备用

* 进入DMX光效模式后，只能通过DMX控制台进行亮度、频率及光效调节。

* 当独立控制多个600d Pro灯（即A和B）时，将每个灯偏移5个通道。如果将灯A设置为DM001，则将灯B设置为DM006，以便在DMX控制器上分别控制A和B。

6. Sidus Link APP 的使用

您可以在App store和安卓市场搜索sidus link下载专业控制软件来控制爱图仕灯具，更多详细使用方法请访问:sidus.link/app/help



Get Sidus Link® App



Sidus.link/app/help

Specifications

工作电流	8A	工作电压	100V~240V 50Hz/60Hz
输入功率	≤720W	输出功率	≤600W
CRI	≥96	TLCI	≥96
CQS	≥95	工作频率	2.4GHz
频道	1/2/3	群组	A/B/C/D
色温	5600±200K	防水等级	IP54
电池要求	14.4V-15A ≥180Wh 26V-8.5A ≥180Wh 28.8V-7.5A ≥180Wh	散热方式	主动散热
遥控距离	≤100 米	APP控制方式	蓝牙
尺寸 (长X宽X高)	灯体	30.78*24.36*15.01cm/12.12*9.59*5.91 in	
	控制盒 (A-mount)	32.83*17.56*14.11cm/12.93*6.91*5.56 in	
	控制盒 (V-mount)	32.83*17.56*14.54cm/12.93*6.91*5.72 in	

亮度测试数据

距离	1m	3m	5m
裸光源	22150 (lux)	2600 (lux)	1020 (lux)
	2058 (fc)	242 (fc)	95 (fc)
标准罩	98500 (lux)	8500 (lux)	3000 (lux)
	9150 (fc)	790 (fc)	280 (fc)

* 亮度数据为平均数据，不同灯的亮度会有微小差异。

商标声明

Bowens是保荣公司在中国或其他国家的商标及产品型号。

Anton bauer是安东保尔公司在美国或其他国家的商标及产品型号。

Neutrik®是 Neutrik® 公司在美国或其他国家的商标及产品型号。

Aputure®

GUARANTEE CARD

Serial No.	
Item Name	
Purchase Date	
Buyer Name	
Buyer Phone	
Buyer Add	
Franchiser Seal	

Aputure®

Aputure Imaging Industries Co., Ltd.

Inspection: Qualified

Addr: F/3, Building 21, Longjun Industrial Estate, HePing West Road, Shenzhen, Guangdong

Service Warranty (EN)

Aputure Imaging Industries Co., Ltd. warrants the original consumer purchaser from defects in material and workmanship for a period of one (1) year after the date of purchase. For more details of warranty visit www.aputure.com

Important:

Keep your original sales receipt. Be sure the dealer has written on it the date, serial No. of the product. This information is required for warranty service.

This warranty does not cover:

- Damage that is the result of misuse, abuse, accident (including but not limited to damage by water), faulty connection, defective or maladjusted associated equipment, or the use of the product with equipment for which it was not intended.
- Cosmetic defects that appear more than thirty (30) days after the date of purchase. Cosmetic damage caused by improper handling is also excluded.
- Damage that occurs while the product is being shipped to whoever will service it.

This warranty is void if:

- The product identification or serial No. label is removed or defaced in any way.
- The product is serviced or repaired by any one other than Aputure or an authorized Aputure dealer or service agency.

Aputure Imaging Industries Co., Ltd.

Addr: F/3, Building 21, Longjun Industrial estate,
HePing West Road, Shenzhen, Guangdong

E-MAIL: cs@aputure.com

Sales Contact: (86)0755-83285569-613

Aputure®

保修卡

保修条款(中文)

本公司对产品第一买主客户提供为期一年的质量保证期。质保内容和细节,请登陆我们的网站www.aputure.com。

重要说明:

请保留您原始购买单据及保修卡,确定您购买的供应商资料都在此单据,同时包括您的购买日期,产品序列号等,这些资料质保服务时都会需要提供。

质保范围不包括:

- 产品不当使用,破坏,意外,错误接线,不良或失调的外接装置,不适合的外接装置所造成的损坏(包括暴露于雨水等损坏),不在质保范围。
- 自购买日30天后产品外观的损伤,或是不当的表面处理接触造成的外观损伤,不在质保范围。
- 经销商运送所造成的损坏,不在质保范围。

质保无效说明:

- 产品序列号标识已经被撕去或无法辨识,本质保条款无效。
- 产品未经本公司或者指定授权维修公司的检修及改装,本质保条款无效。

深圳市爱图仕影像器材有限公司

地址:广东省深圳市龙华和平西路部九窝龙军工工业區21栋3楼

邮箱: cs@aputure.com

销售热线: 0755-83285569-613

服务热线: 400-0999-028

产品编号	
产品名称	
购买日期	
用户姓名	
用户电话	
用户地址	
经销商印章	

Aputure®

爱图仕

深圳市爱图仕影像器材有限公司

检验:合格

地址:深圳市龙华新区和平西路部九窝龙军工工业區