



TEST REPORT

Applicant Name & Address : Polygroup Limited(Macao Commercial Offshore)
Avenida Xian Xing Hai, Centro Golden Dragon, 11 Andar Macau

Sample Description

Product : Christmas Tree Lighting
Model No. : LxGxYxS(the first x=30-120; the second x=0-5; the third x=0100-2300)
LlxYx(the first x=06-220; the second x=0010-2300)
Electrical Rating : 120V/60Hz
FCC ID : 2AABT-CW004

Date Received : 13 January 2017

Date Test Conducted : 13 January 2017-10 February 2017

Test standards : **FCC Part 15: 2015 Subpart B**

Test Result : Pass

Conclusion : The submitted samples complied with the above rules/standards.

Remark : TRF No.: FCC Part 15 2015 (Subpart B)-a
Effective date: 11 November 2016

Prepared and Checked By:

Approved By:

Sky Zhu
Sky Zhu
Project Engineer
Intertek Guangzhou

Helen Ma *Signature*
Helen Ma
Team Leader
Intertek Guangzhou
09 February 2017 *Date*

This report is for the exclusive use of Intertek's Client and is provided pursuant to the agreement between Intertek and its Client. Intertek's responsibility and liability are limited to the terms and conditions of the agreement. Intertek assumes no liability to any party, other than to the Client in accordance with the agreement, for any loss, expense or damage occasioned by the use of this report. Only the Client is authorized to permit copying or distribution of this report and then only in its entirety. Any use of the Intertek name or one of its marks for the sale or advertisement of the tested material, product or service must first be approved in writing by Intertek. The observations and test results in this report are relevant only to the sample tested. This report by itself does not imply that the material, product, or service is or has ever been under an Intertek certification program. The test report only allows to be revised within three years from its original issued date unless further standard or the requirement was noticed.

Intertek Testing Services Shenzhen Ltd. Guangzhou Branch
Block E, No.7-2 Guang Dong Software Science Park, Caipin Road, Guangzhou Science City, GETDD Guangzhou, China
Tel / Fax: 86-20-8213 9688/86-20-3205 7538
© 2016 Intertek



CONTENT

TEST REPORT.....1

CONTENT.....2

1 TEST RESULTS SUMMARY3

2 TEST RESULTS CONCLUSION.....4

3 LABORATORY MEASUREMENTS6

4 EQUIPMENT USED DURING TEST.....7

5 TEST RESULTS.....8

5.1 CONDUCTED DISTURBANCE VOLTAGE AT MAINS PORTS8

5.1.1 *Block Diagram of Test Setup*.....8

5.1.2 *Test Setup and Procedure*8

5.1.3 *Limit*9

5.1.4 *Test Data and Curve*10

5.1.5 *Measurement Uncertainty*.....15

5.2 RADIATED EMISSION (30 MHz -1000 MHz)16

5.2.1 *Block Diagram of Test Setup*.....16

5.2.2 *Test Setup and Procedure*16

5.2.3 *Limit*17

5.2.4 *Test Data and Curve*18

5.2.5 *Measurement uncertainty*.....23

5.3 RADIATED EMISSION ABOVE 1 GHz24

5.3.1 *Block Diagram of Test Setup*.....24

5.3.2 *Test Setup and Procedure*25

5.3.3 *Limit*25

5.3.4 *Test Data*.....26

5.3.5 *Measurement uncertainty*.....27

1

TEST RESULTS SUMMARY

Classification of EUT: Class B

Test Item	Standard	Result
Conducted disturbance voltage at mains ports	FCC Part 15: 2015, Subpart B	Pass
Radiated emission (30 MHz–1 GHz)	FCC Part 15: 2015, Subpart B	Pass
Radiated emission (Above 1 GHz)	FCC Part 15: 2015, Subpart B	Pass
Remark: Reference publication is used for methods of measurement: ANSI C63.4:2014		

**Remark: 1. The symbol “N/A” in above table means Not Applicable.
2. When determining the test results, measurement uncertainty of tests has been considered.**

2

Test Results Conclusion
(with Justification)

RE: EMC Testing Pursuant to FCC Part 15, Subpart B Performed on the Christmas Tree Lighting, Models: LxGxYxS(the first x=30-120; the second x=0-5; the third x=0100-2300), LlxYx(the first x=06-220; the second x=0010-2300).

We tested the Christmas Tree Lighting, Model: LI06Y2300 to determine if it was in compliance with the relevant FCC rules as marked on the Test Results Summary. We found that the unit met the requirement of FCC Part 15, Subpart B when tested as received. The worst case's test data was presented in this test report.

The LlxYx series are same as LxGxYxS, only except nomenclature and LlxYx series include Wreath /Garland/ Teardrop/Tree /Swag products.

The Christmas Tree Light can be power by below adapter:
Adapter model TS-3W28V, input 120V, 60Hz, output DC28V0.1A 3W
Adapter model TS-8W29V, input 120V, 60Hz, output DC29V0.28A 8W
Adapter model TS-13W29V, input 120V, 60Hz, output DC29V0.45A 13W
Adapter model TS-29V0.9A, input 120V, 60Hz, output DC29V0.9A 26.1W
Adapter model MTS810-29V, input 120V, 60Hz, output DC29V 15W
Adapter model MTS811-29V, input 120V, 60Hz, output DC29V 15W
Adapter model TS-17W29V, input 120V, 60Hz, output DC29V17W
Adapter model TS-29V0.6A, input 120V, 60Hz, output DC29V0.6A
Adapter model TS-20W29V, input 120V, 60Hz, output DC29V20W

Adapter TS-8W29V, TS-13W29V, TS-3W28V they have the same circuit and mechanical design, their different is that the output current and output electronic components parameters. Adapter MTS810-29V and MTS-810-29V are all identical except the model number. Adapter TS-17W29V, TS-29V0.6A, TS-20W29V, TS-29V0.9A they have the same circuit and mechanical design, their different is that the output current and output electronic components parameters.

All models can use the receiver PDR-007-29V-R or PDR-007-29V-AR or PDR-012-29V-R or PDR-012-29V-AR and with Remote control PDT-001-29V. The receiver PDR-007-29V-R, PDR-007-29V-AR, PDR-012-29V-R and PDR-012-29V-AR are identical except the model number.

So the Model: LI06Y2300 with receiver PDR-007-29V-R and adapter mode TS-3W28V, MTS810-29V, TS-29V0.9A was tested in this report.

Product information:

LxGxYxS (the first x=30-120; the second x=0-5; the third x=0100-2300)

Note: "L" means that the low voltage. The first "x" indicates the size of the tree, said the use of height from 3ft-12ft. "Gx" number of lines, G0 represents 0 drag line G5 on behalf of 5 drag line. "Y" means tree stand. M means the tree is to use ordinary tree foot. R which means

that the tree is to use rotating tree foot, The third "x" represents the number of lamp, from 100 to 2300 lamp, "S" means that the tree pin

LlxYx(the first x=06-220; the second x=0010-2300)

Note: "L" means low voltage, "I" indicates for indoor use only, if blank means for indoor and outdoor use. The first "x" indicates the size of Wreath/Garland/Teardrop/Tree/Swag, the size is from 06 in-220 in, for Wreath/Teardrop/Tree/Swag, The size is from 06 ft-50 ft in for Garland. "Y" means type of product. The second "x" represents the number of lamps from 10 to 2300 lamps.

The receiver frequency is 433.92MHz, So, An un-modulated CW signal at the operating frequency 433.92MHz of the EUT is supplied to the EUT for all measurements.

The receiver type of the EUT is super heterodyne.

Conclusion:

The sample as received complied with the FCC Part 15 requirement.

The production units are required to conform to the initial sample as received when the units are placed on the market.



3

LABORATORY MEASUREMENTS

Configuration Information

Equipment Under Test (EUT):	Christmas Tree Lighting
Model:	LI06Y2300
Serial No.:	Not Labeled
Support Equipment:	N/A
Rated Voltage:	120V/60Hz
Condition of Environment:	Temperature : 22~28°C Relative Humidity: 35~60% Atmosphere Pressure 86~106kPa

Notes:

1. The EMI measurements had been made in the operating mode producing the largest emission in the frequency band being investigated consistent with normal applications.
An attempt had been made to maximize the emission by varying the configuration of the EUT.

2. Test Sites:

All of the tests are performed at:

Intertek Testing Services Shenzhen Ltd. Guangzhou Branch. located at Block E, No.7-2 Guang Dong Software Science Park, Caipin Road, Guangzhou Science City, GETDD Guangzhou, 510663, China. This test facility and site measurement data have been fully placed on file with the FCC, test firm registration number is 549654.

4 Equipment used during test

Conducted Disturbance-Mains Terminal (1)

Equipment No.	Equipment	Model	Manufacturer	Cal. Due date (MM-DD-YYYY)	Calibration Interval
EM080-05	EMI receiver	ESCI	R&S	2017/7/26	1Y
EM006-05	LISN	ENV216	R&S	2017/9/18	1Y
SA047-79	Digital Temperature-Humidity Recorder	RC-HT601A	HATAIKE	2017/6/8	1Y
EM084-02	SIGNAL Generator	SML02	R&S	2017/6/9	1Y
EM004-04	EMC shield Room	8m×3m×3m	Zhongyu	2018/1/23	1Y

Radiated Disturbance (30 MHz-1 GHz)

Equipment No.	Equipment	Model	Manufacturer	Cal. Due date (MM-DD-YYYY)	Calibration Interval
EM030-04	3m Semi-Anechoic Chamber	9×6×6 m3	ETS-LINDGREN	2017/5/9	1Y
EM031-02	EMI Test Receiver (9 kHz~7 GHz)	R&S ESR7	R&S	2018/2/8	1Y
EM033-01	TRILOG Super Broadband test Antenna (30 MHz-3 GHz)	VULB 9163	SCHWARZBECK	2017/9/8	1Y
EM084-02	SIGNAL Generator	SML02	R&S	2017/6/9	1Y
EM031-02-01	Coaxial cable	/	R&S	2017/5/30	1Y
SA047-118	Digital Temperature-Humidity Recorder	RS210	YIJIE	2017/7/29	1Y

Radiated Disturbance (1-18 GHz)

Equipment No.	Equipment	Model	Manufacturer	Cal. Due date (MM-DD-YYYY)	Calibration Interval
EM030-04	3m Semi-Anechoic Chamber	9×6×6 m3	ETS-LINDGREN	2017/5/9	1Y
EM031-02	EMI Test Receiver (9 kHz~7 GHz)	R&S ESR7	R&S	2018/2/8	1Y
EM031-03	Signal and Spectrum Analyzer (10 Hz~40 GHz)	R&S FSV40	R&S	2017/4/1	1Y
EM033-02	Bouble-Ridged Waveguide Horn Antenna (800 MHz-18 GHz)	R&S HF907	R&S	2017/6/6	1Y
EM084-02	SIGNAL Generator	SML02	R&S	2017/6/9	1Y
EM031-02-01	Coaxial cable	/	R&S	2017/5/30	1Y
EM022-03	2.45 GHz Filter	BRM 50702	Micro-Tronics	2017/5/9	1Y
SA047-118	Digital Temperature-Humidity Recorder	RS210	YIJIE	2017/7/29	1Y

5 TEST RESULTS

5.1 Conducted Disturbance Voltage at mains ports

Test Result: Pass

5.1.1 Block Diagram of Test Setup

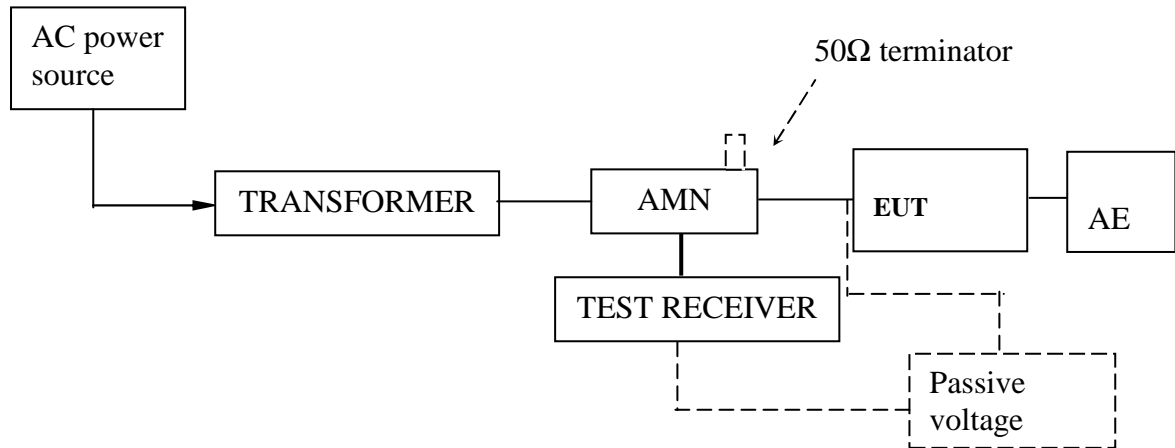

5.1.2 Test Setup and Procedure

Test was performed according to ANSI C63.4: 2014. The EUT was set to achieve the maximum emission level. The mains terminal disturbance voltage was measured with the EUT in a shielded room. The EUT was connected to AC power source through an Artificial Mains Network which provides a 50Ω linear impedance Artificial hand is used if appropriate (for handheld apparatus). The load/control terminal disturbance voltage was measured with passive voltage probe if appropriate.

The table-top EUT was placed on a 0.8m high non-metallic table above earthed ground plane(Ground Reference Plane).And for floor standing EUT, was placed on a 0.1m high non-metallic supported on GRP. The EUT keeps a distance of at least 0.8m from any other of the metallic surface. The Artificial Mains Network is situated at a distance of 0.8m from the EUT.

During the test, mains lead of EUT excess 0.8m was folded back and forth parallel to the lead so as to form a horizontal bundle with a length between 0.3m and 0.4m.

The bandwidth of test receiver was set at 9 kHz. The frequency range from 150 kHz to 30MHz was checked.

5.1.3 Limit
 Class B

Frequency range MHz	AC mains terminals dB (uV)	
	Quasi-peak	Average
0.15 to 0.5	66 to 56	56 to 46
0.5 to 5	56	46
5 to 30	60	50

Note 1: The limit decreases linearly with the logarithm of the frequency in the range 0.15 MHz to 0.5 MHz.
 Note 2: The lower limit is applicable at the transition frequency.

5.1.4 Test Data and Curve

At main terminal: Pass

Adaptor Model: TS-29V0.9A

Tested Wire: Live

Operation Mode: Receiving mode + Lighting on

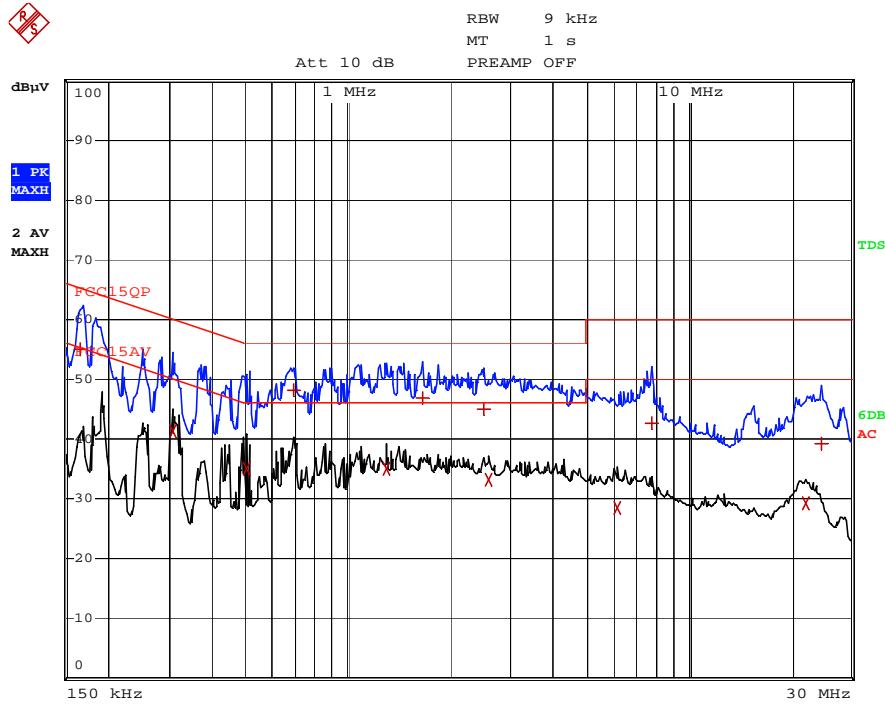

EDIT PEAK LIST (Final Measurement Results)				
Trace1:		FCC15QP		
Trace2:		FCC15AV		
Trace3:		---		
TRACE	FREQUENCY	LEVEL dBμV		DELTA LIMIT dB
1 Quasi Peak	694 kHz	48.16 L1		-7.83
2 Average	306 kHz	41.21 L1		-8.86
1 Quasi Peak	1.662 MHz	46.86 L1		-9.13
1 Quasi Peak	166 kHz	54.86 L1		-10.29
2 Average	1.294 MHz	35.01 L1		-10.98
2 Average	506 kHz	35.00 L1		-10.99
1 Quasi Peak	2.506 MHz	44.90 L1		-11.09
2 Average	2.582 MHz	33.32 L1		-12.67
1 Quasi Peak	7.77 MHz	42.55 L1		-17.44
1 Quasi Peak	24.558 MHz	39.35 L1		-20.64
2 Average	22.038 MHz	29.30 L1		-20.69
2 Average	6.182 MHz	28.47 L1		-21.52

Tested Wire: Neutral

Operation Mode: Receiving mode + Lighting on

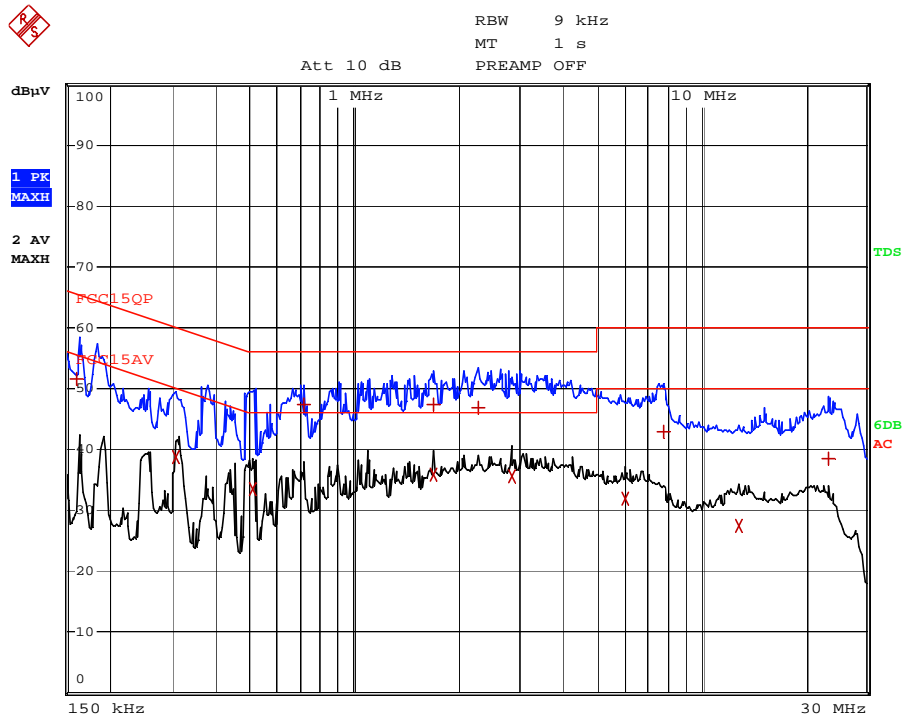

EDIT PEAK LIST (Final Measurement Results)				
TRACE	FREQUENCY	LEVEL dBμV	DELTA	LIMIT dB
Trace1:	FCC15QP			
Trace2:	FCC15AV			
Trace3:	---			
1 Quasi Peak	1.686 MHz	47.32	L1	-8.67
1 Quasi Peak	714 kHz	47.26	L1	-8.73
1 Quasi Peak	2.27 MHz	46.75	L1	-9.24
2 Average	1.686 MHz	35.85	L1	-10.14
2 Average	2.854 MHz	35.61	L1	-10.38
2 Average	310 kHz	38.61	L1	-11.35
2 Average	510 kHz	33.41	L1	-12.58
1 Quasi Peak	162 kHz	51.67	L1	-13.68
1 Quasi Peak	7.802 MHz	42.88	L1	-17.12
2 Average	6.054 MHz	31.85	L1	-18.14
1 Quasi Peak	23.218 MHz	38.44	L1	-21.55
2 Average	12.858 MHz	27.43	L1	-22.56

Adaptor Model: MTS810-29V

Tested Wire: Live

Operation Mode: Receiving mode + Lighting on



RBW 9 kHz
 MT 1 s
 PREAMP OFF

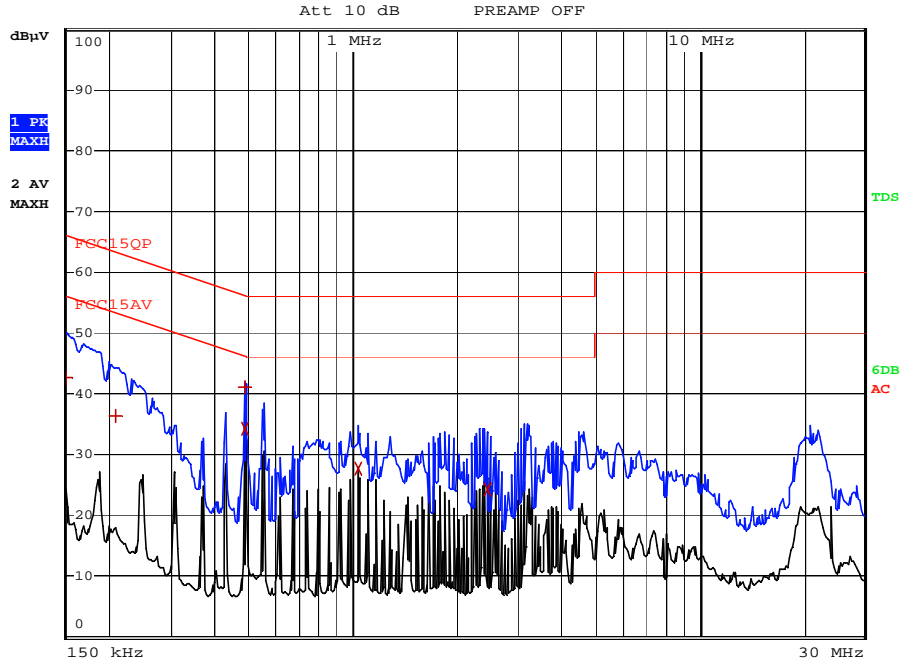

EDIT PEAK LIST (Final Measurement Results)				
TRACE	FREQUENCY	LEVEL dBµV	DELTA	LIMIT dB
Trace1:	FCC15QP			
Trace2:	FCC15AV			
Trace3:	---			
1 Quasi Peak	150 kHz	42.71 L1	-23.28	
1 Quasi Peak	210 kHz	36.42 L1	-26.77	
1 Quasi Peak	490 kHz	41.05 L1	-15.11	
2 Average	490 kHz	34.18 L1	-11.98	
2 Average	1.042 MHz	27.61 L1	-18.38	
2 Average	2.454 MHz	24.31 L1	-21.68	

Tested Wire: Neutral

Operation Mode: Receiving mode + Lighting on

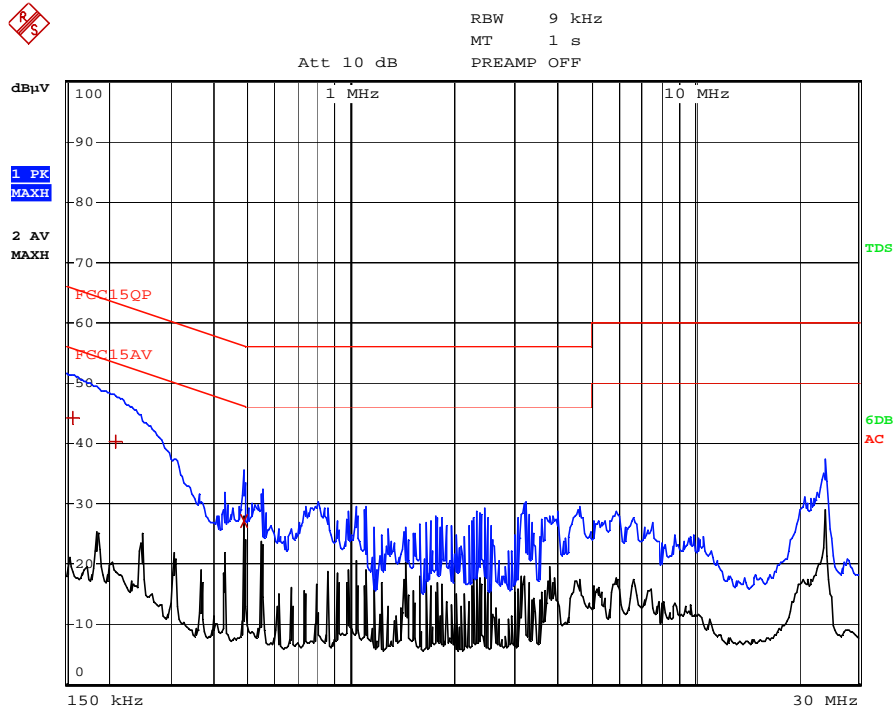

EDIT PEAK LIST (Final Measurement Results)				
Trace1:	FCC15QP			
Trace2:	FCC15AV			
Trace3:	---			
TRACE	FREQUENCY	LEVEL dBμV		DELTA LIMIT dB
1 Quasi Peak	158 kHz	44.23 L1		-21.33
1 Quasi Peak	210 kHz	40.27 L1		-22.93
2 Average	490 kHz	27.17 L1		-18.99

Adaptor Model: TS-3W28V

Tested Wire: Live

Operation Mode: Receiving mode + Lighting on

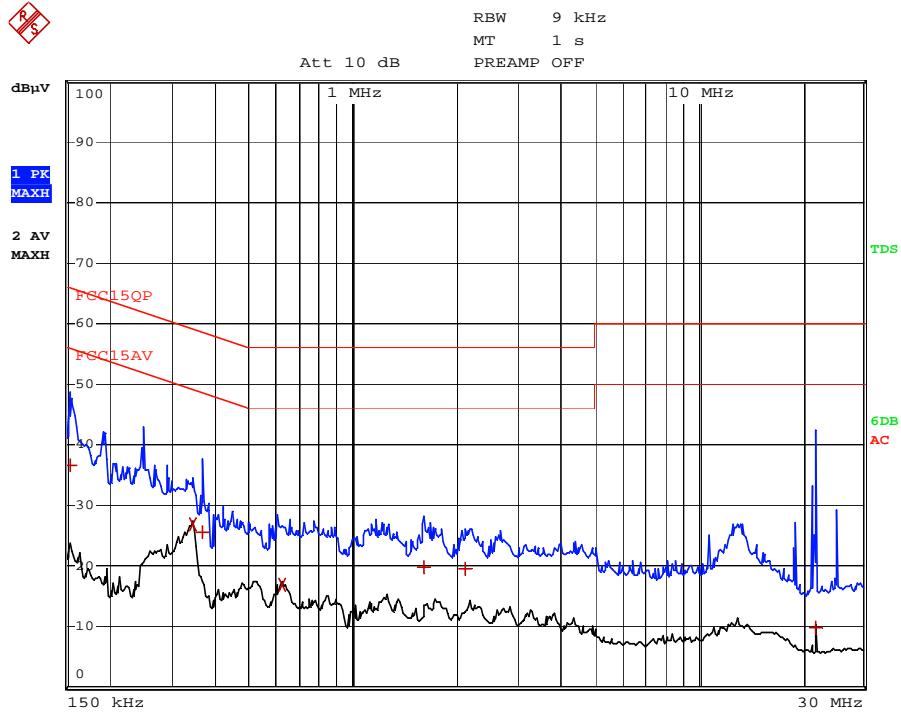

EDIT PEAK LIST (Final Measurement Results)			
Trace1:	FCC15QP		
Trace2:	FCC15AV		
Trace3:	---		
TRACE	FREQUENCY	LEVEL dBµV	DELTA LIMIT dB
1 Quasi Peak	154 kHz	36.50 L1	-29.27
2 Average	342 kHz	26.95 L1	-22.20
1 Quasi Peak	366 kHz	25.62 L1	-32.96
2 Average	622 kHz	16.93 L1	-29.06
1 Quasi Peak	1.61 MHz	19.88 L1	-36.11
1 Quasi Peak	2.122 MHz	19.46 L1	-36.54
1 Quasi Peak	21.898 MHz	9.81 L1	-50.18

Tested Wire: Neutral

Operation Mode: Receiving mode + Lighting on

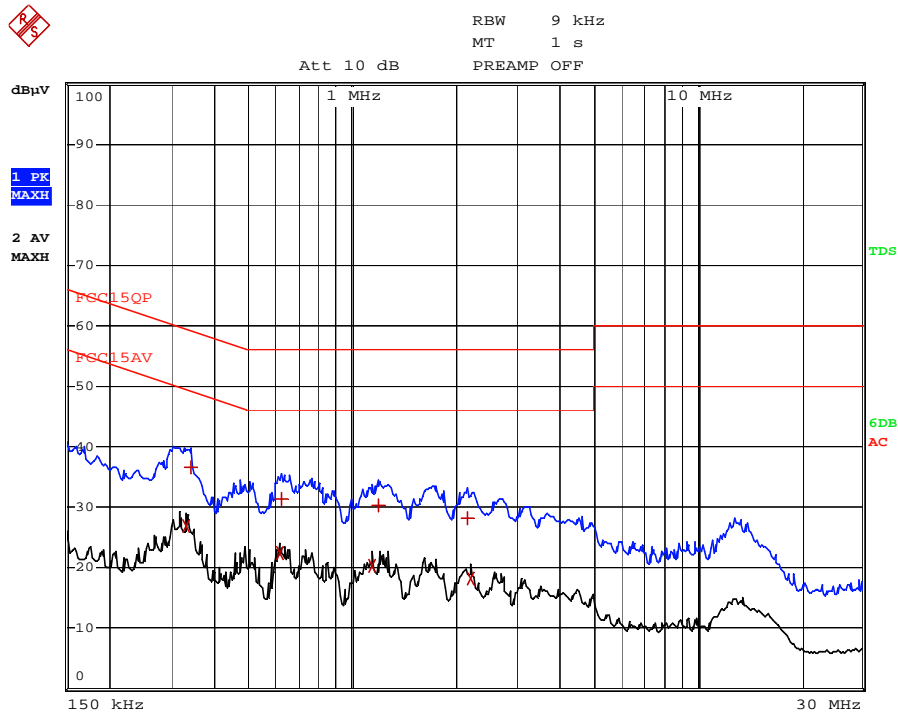

EDIT PEAK LIST (Final Measurement Results)				
Trace1:	FCC15QP			
Trace2:	FCC15AV			
Trace3:	---			
TRACE	FREQUENCY	LEVEL	dBµV	DELTA LIMIT
2 Average	330 kHz	26.97	L1	-22.48
1 Quasi Peak	338 kHz	36.55	L1	-22.70
2 Average	618 kHz	22.52	L1	-23.47
1 Quasi Peak	622 kHz	31.41	L1	-24.58
2 Average	1.142 MHz	20.39	L1	-25.60
1 Quasi Peak	1.198 MHz	30.25	L1	-25.74
1 Quasi Peak	2.154 MHz	28.29	L1	-27.70
2 Average	2.21 MHz	18.23	L1	-27.76

5.1.5 ement Uncertainty

Uncertainty: 2.58 dB at a level of confidence of 95%

5.2 Radiated Emission (30 MHz -1000 MHz)

Test Result: Pass

5.2.1 Block Diagram of Test Setup

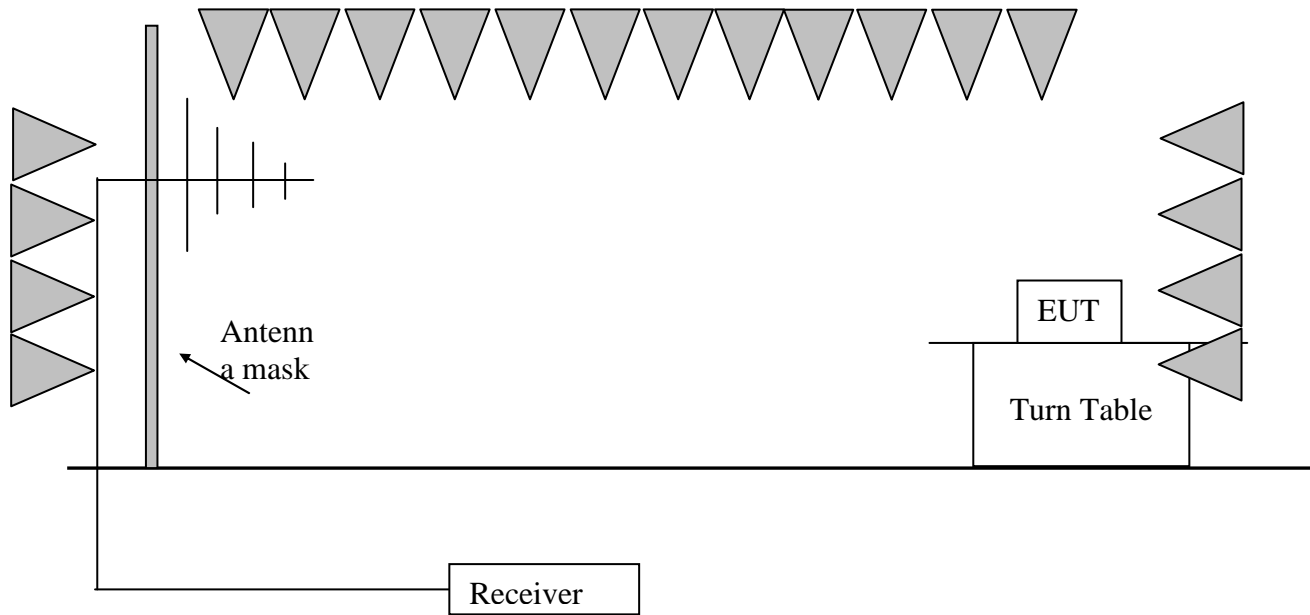

5.2.2 Test Setup and Procedure

The measurement was applied in a 3 m semi-anechoic chamber. The EUT and simulators were placed on a 0.8m high wooden turntable above the horizontal metal ground plane. The turn table rotated 360 degrees to determine the position of the maximum emission level. The EUT was set 3 meters away from the receiving antenna which was mounted on an antenna mask. The antenna moved up and down between from 1meter to 4 meters to find out the maximum emission level.

Broadband antenna was used as receiving antenna. Both horizontal and vertical polarization of the antenna was set on measurement. In order to find the maximum emission, all of the interface cables were manipulated according to ANSI C63.4: 2014 requirement during radiated test. The bandwidth setting on R&S Test Receiver was 120 kHz. The frequency range from 30MHz to 1000MHz was checked.

For an unintentional radiator, including a digital device, the spectrum shall be investigated from the lowest radio frequency signal generated or used in the device, without going below the lowest frequency for which a radiated emission limit is specified, up to the frequency shown in the following table:

Highest frequency generated or used in the device or on which the device operates or tunes (MHz)	Upper Frequency of Radiated Measurement
Below 1.705 MHz	30MHz
1.705 MHz – 108 MHz	1 GHz
108 MHz – 500 MHz	2 GHz
500 MHz – 1 GHz	5 GHz
Above 1 GHz	5th harmonic of the highest frequency or 40 GHz, whichever is lower.
At transitional frequencies the lower limit applies.	

Remark: Radiated Emission was performed from 30 MHz to 1 GHz.

5.2.3 Limit

Class B limit at 3m test distance:

Frequency range MHz	Quasi-peak limits dB (μV/m)
30 to 88	40
88 to 216	43.5
216 to 960	46
960 to 1000	54
At transitional frequencies the lower limit applies.	

5.2.4 Test Data and Curve

Adaptor model: TS-29V0.9A

Test Voltage: AC120 V, 60 Hz

Test mode: Receiver function + Lighting on

Horizontal:

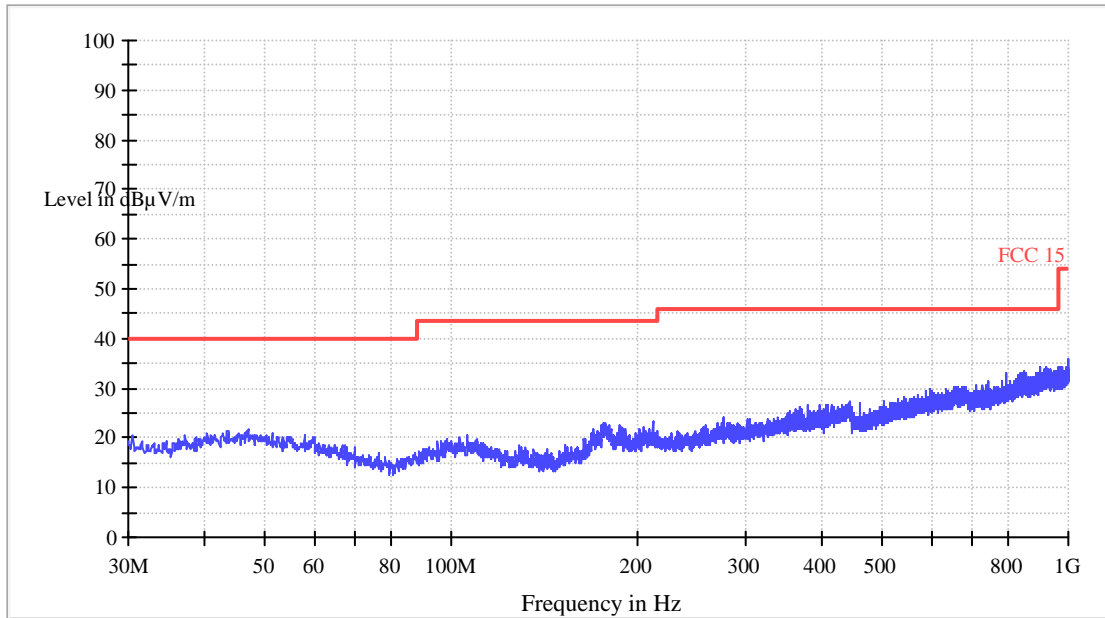

Remarks: the final QP value below the limit more than 20dBm.

Vertical

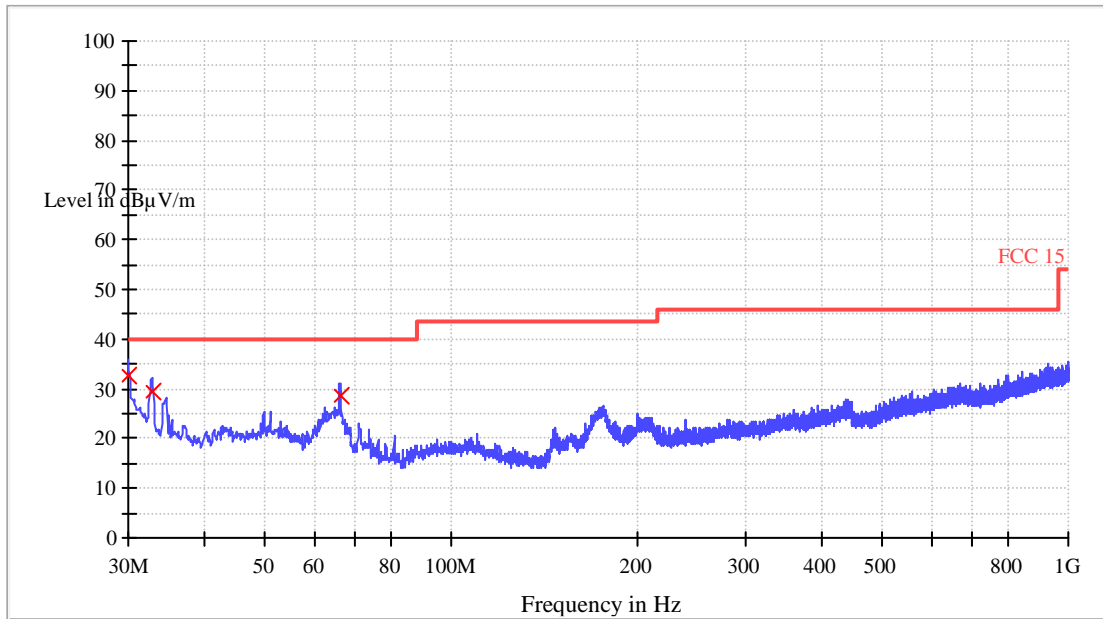

QP

Frequency (MHz)	QuasiPeak (dBµV/m)	Bandwidth (kHz)	Pol	Corr. (dB)	Margin - QPK (dB)	Limit - QPK (dBµV/m)
30.000000	32.5	120.000	V	11.2	7.5	40.0
32.760000	29.5	120.000	V	11.4	10.5	40.0
66.040000	28.5	120.000	V	11.2	11.5	40.0

Adaptor model: MTS810-29V
Test Voltage: AC120 V, 60 Hz
Horizontal:

Test mode: Receiver function + Lighting on

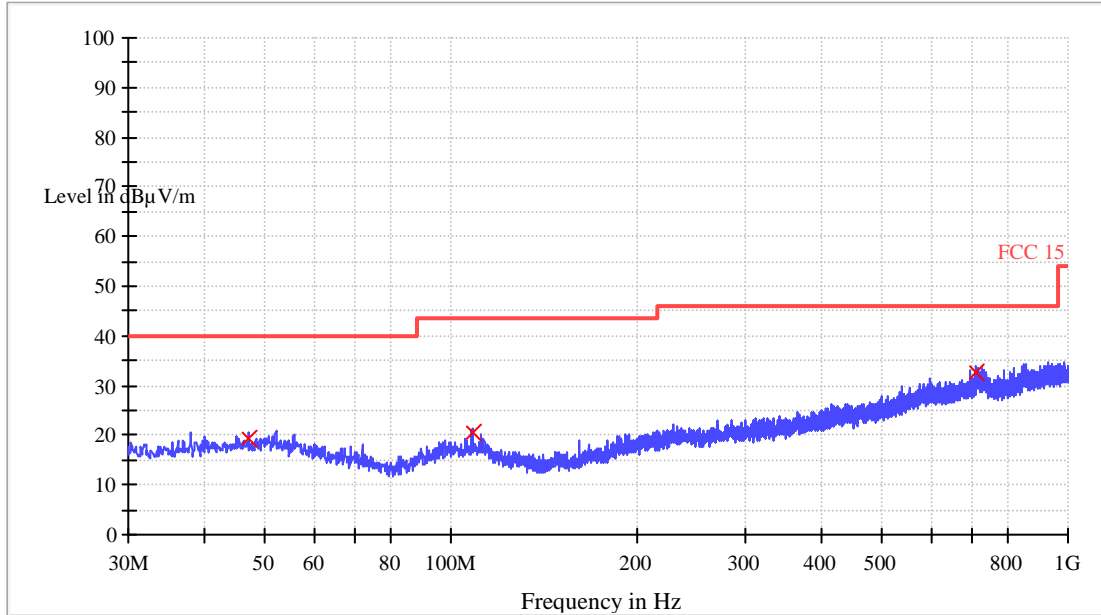

QP

Frequency (MHz)	QuasiPeak (dBµV/m)	Bandwidth (kHz)	Pol	Corr. (dB)	Margin - QPK (dB)	Limit - QPK (dBµV/m)
46.920000	19.6	120.000	H	14.1	20.5	40.0
108.200000	20.6	120.000	H	12.3	23.0	43.5
710.480000	32.8	120.000	H	23.1	13.2	46.0

Vertical

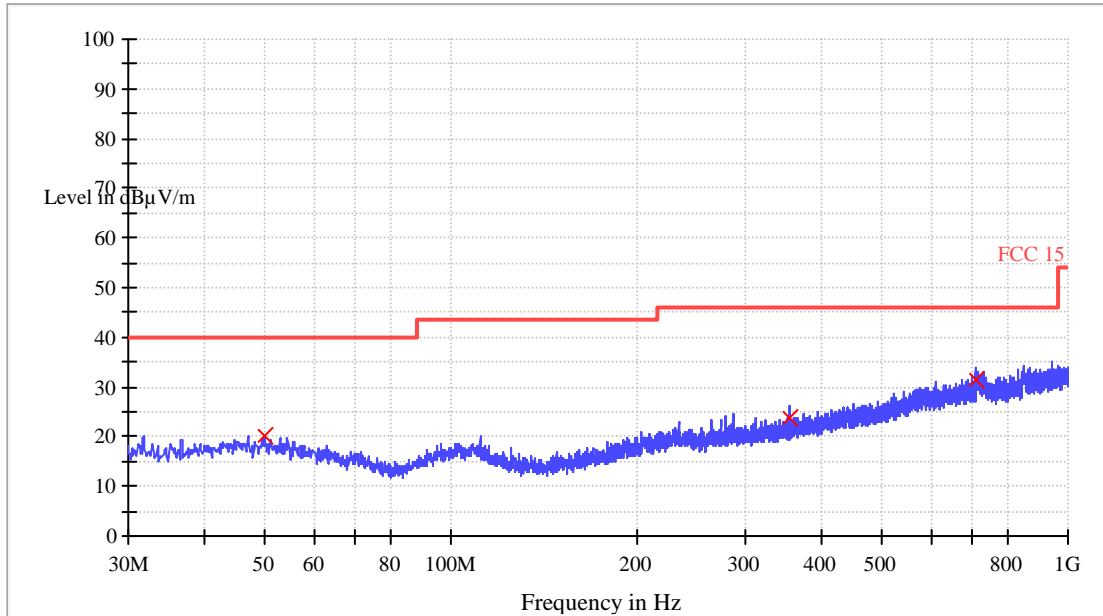

QP

Frequency (MHz)	QuasiPeak (dBµV/m)	Bandwidth (kHz)	Pol	Corr. (dB)	Margin - QPK (dB)	Limit - QPK (dBµV/m)
49.800000	20.0	120.000	V	14.1	20.0	40.0
353.960000	23.7	120.000	V	16.6	22.3	46.0
710.000000	31.6	120.000	V	23.1	14.4	46.0

Adaptor model: TS-3W28V
Test Voltage: AC120 V, 60 Hz
Horizontal:

Test mode: Receiver function + Lighting on

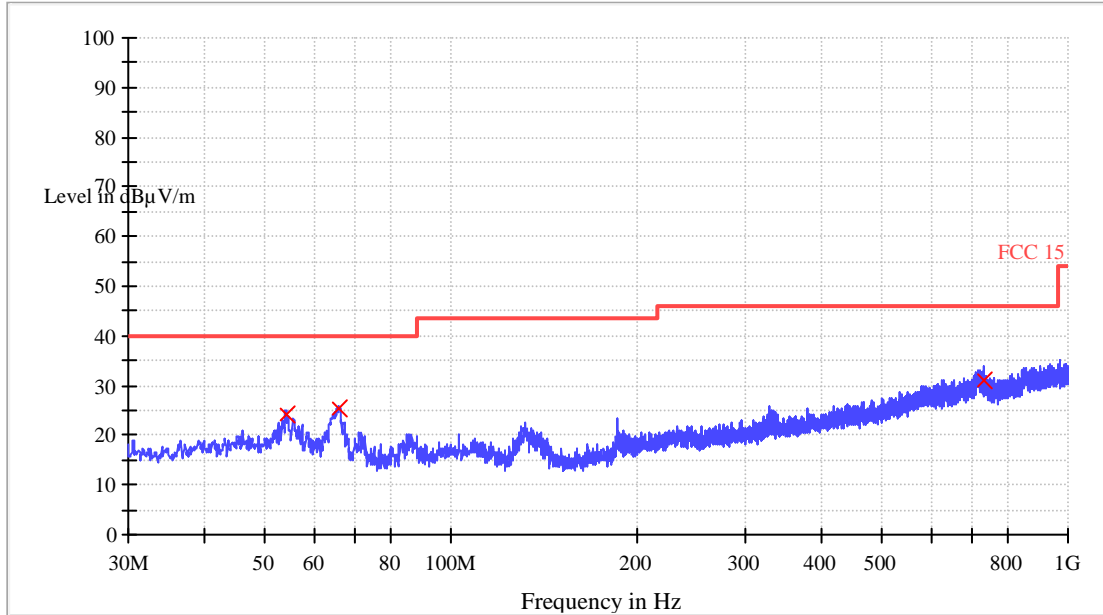

QP

Frequency (MHz)	QuasiPeak (dBµV/m)	Bandwidth (kHz)	Pol	Corr. (dB)	Margin - QPK (dB)	Limit - QPK (dBµV/m)
53.960000	24.3	120.000	H	13.6	15.7	40.0
65.920000	25.4	120.000	H	11.2	14.6	40.0
729.880000	31.2	120.000	H	23.3	14.8	46.0

Vertical

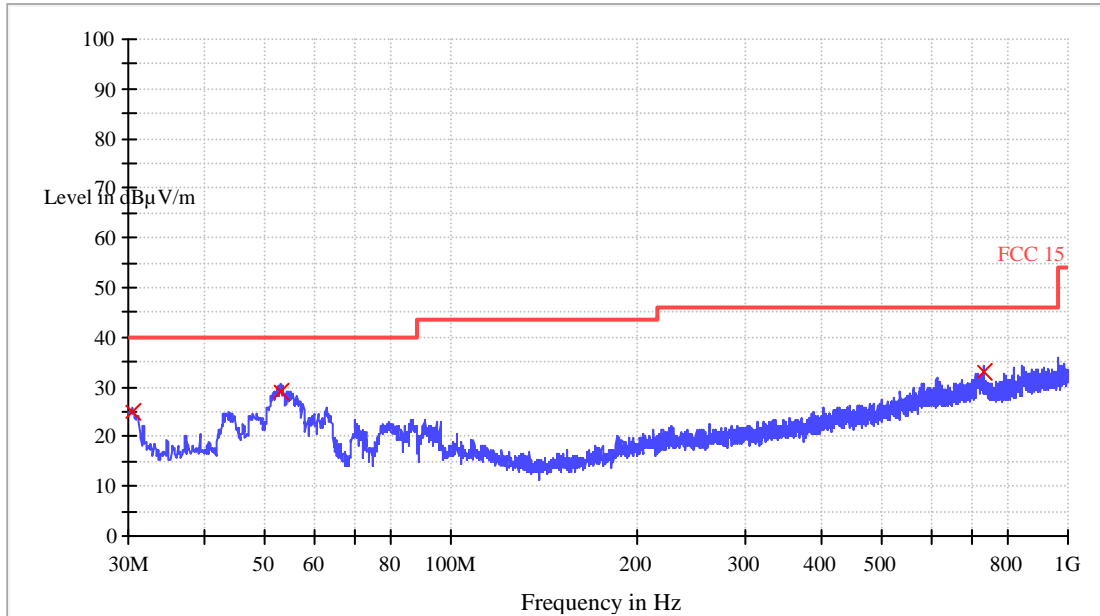

QP

Frequency (MHz)	QuasiPeak (dBµV/m)	Bandwidth (kHz)	Pol	Corr. (dB)	Margin - QPK (dB)	Limit - QPK (dBµV/m)
30.400000	24.9	120.000	V	11.2	15.1	40.0
52.960000	29.0	120.000	V	13.7	11.0	40.0
729.000000	33.2	120.000	V	23.3	12.8	46.0

5.2.5 Measurement uncertainty

Uncertainty: 4.87 dB in the frequency range of 30-1000 MHz at a level of confidence of 95%

5.3 Radiated Emission above 1 GHz
Test Result: Pass

5.3.1 Block Diagram of Test Setup

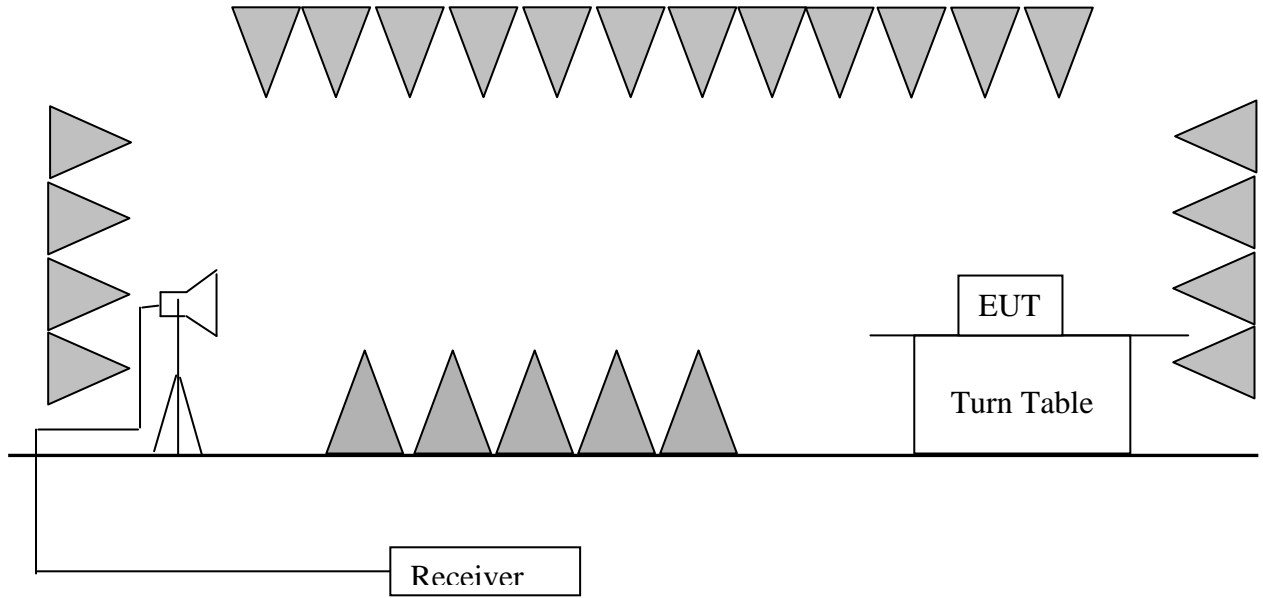

5.3.2 Test Setup and Procedure

The measurement was applied in a semi-anechoic chamber with absorbing material placed on the ground. The EUT were placed on a 0.8m high wooden turntable above the horizontal metal ground plane. The turntable varied every 30 degrees to determine the position of the maximum emission level. The EUT was set 3 meters away from the receiving antenna which was mounted on an antenna pole. The antenna was set as same as the height of the radiation centre of the EUT.

Horn antenna was used as receiving antenna. Both horizontal and vertical polarization of the antenna was set on measurement. In order to find the maximum emission, all of the interface cables were manipulated during radiated test.

For an unintentional radiator, including a digital device, the spectrum shall be investigated from the lowest radio frequency signal generated or used in the device, without going below the lowest frequency for which a radiated emission limit is specified, up to the frequency shown in the following table:

Highest Frequency Generated or Used in Device	Upper Frequency of Radiated Measurement
Below 1.705 MHz	30MHz
1.705 MHz – 108 MHz	1 GHz
108 MHz – 500 MHz	2 GHz
500 MHz – 1 GHz	5 GHz
Above 1 GHz	5th harmonic of the highest frequency or 40 GHz, whichever is lower.
At transitional frequencies the lower limit applies.	

Remark: Radiated Emission was performed from 1 GHz to 2 GHz since the highest frequency generated form the EUT was 433.92MHz.

5.3.3 Limit

Class B limit at 3m test distance:

Frequency range MHz	Linear Average Detector dB (µV/m)	Peak Detector dB (µV/m)
> 1000	54	74
At transitional frequencies the lower limit applies.		

5.3.4 Test Data

Adaptor Model: TS-29V0.9A

Receiver mode + Lighting on

Horizontal

Frequency (GHz)	Read Level (dBuV)	Correction Factor (dB)	Level (dBuV/m)	Limit Line (dBµV/m)	Over Limit (dB)	Detector Function
1.10	47.20	-14.00	33.20	54.00	-20.80	Peak
1.52	47.30	-13.40	33.90	54.00	-20.10	Peak
1.74	45.70	-9.70	36.00	54.00	-18.00	Peak

Vertical

Frequency (GHz)	Read Level (dBuV)	Correction Factor (dB)	Level (dBuV/m)	Limit Line (dBµV/m)	Over Limit (dB)	Detector Function
1.09	47.40	-14.10	33.30	54.00	-20.70	Peak
1.52	46.60	-12.30	34.30	54.00	-19.70	Peak
1.84	47.10	-8.80	38.30	54.00	-15.70	Peak

Adaptor Model: MTS810-29V

Receiver mode + Lighting on

Horizontal

Frequency (GHz)	Read Level (dBuV)	Correction Factor (dB)	Level (dBuV/m)	Limit Line (dBµV/m)	Over Limit (dB)	Detector Function
1.16	49.50	-14.60	34.90	54.00	-19.10	Peak
1.68	46.19	-12.98	33.21	54.00	-20.79	Peak
1.88	44.05	-8.70	35.35	54.00	-18.65	Peak

Vertical

Frequency (GHz)	Read Level (dBuV)	Correction Factor (dB)	Level (dBuV/m)	Limit Line (dBµV/m)	Over Limit (dB)	Detector Function
1.21	47.08	-13.40	33.68	54.00	-20.32	Peak
1.42	44.30	-12.00	32.30	54.00	-21.70	Peak
1.96	46.10	-7.80	38.30	54.00	-15.70	Peak

Adaptor Model: TS-3W28V

Receiver mode + Lighting on
 Horizontal

Frequency (GHz)	Read Level (dBuV)	Correction Factor (dB)	Level (dBuV/m)	Limit Line (dBμV/m)	Over Limit (dB)	Detector Function
1.28	46.80	-13.30	33.50	54.00	-20.50	Peak
1.53	46.37	-12.68	33.69	54.00	-20.31	Peak
1.79	45.17	-8.70	36.47	54.00	-17.53	Peak

Vertical

Frequency (GHz)	Read Level (dBuV)	Correction Factor (dB)	Level (dBuV/m)	Limit Line (dBμV/m)	Over Limit (dB)	Detector Function
1.34	49.08	-15.80	33.28	54.00	-20.72	Peak
1.47	45.23	-13.12	32.11	54.00	-21.89	Peak
1.69	45.02	-9.67	35.35	54.00	-18.65	Peak

Remark: The measured PK value is below AV limit so the result was passed.

5.3.5 Measurement uncertainty

Uncertainty: 4.8 dB in the frequency range of 1GHz-25 GHz at a level of confidence of 95%

*****End of Report*****