FCC Test Report

Report No: WD-RF-R-200309-B0

Product Name : BT Dual mode Module
Model Name : BTA-QC3031-3M
FCC ID : 2AABGQ3031-3M
Applicant : EnzyTek Technoloy Inc.
Received Date : Sep. 02, 2020
Tested Date : Sep. 08, 2020 ~ Oct. 21, 2020
Applicable Standard : 47 CFR FCC Part 15, Subpart C (Section 15.247)
KDB 558074 D01 DTS Meas. Guidance v05
ANSI C63.10 : 2013



Wendell Industrial Co., Ltd
Wendell EMC & RF Laboratory

Caution:

This report sets forth our findings solely with respect to the test samples identified herein. The results set forth in this report are not indicative or representative of the quality or characteristics of the lot from which a test sample was taken or any similar or identical product unless specifically and expressly noted.

The test results shown in the test report are traceable to the national/international standard through the calibration report of the equipment.

Please note that the measurement uncertainty are provided for informational purpose only and are not used in determining the Pass/Fail results.

This report must not be used to claim product endorsement by TAF or any agency of the government.

The test report shall not be reproduced without the written approval of Wendell Industrial Co., Ltd..

Test Report

Issued Date: October 22, 2020

Project No.: 20Q090203

Product Name	BT Dual mode Module
Trade Name	Enzytek
Model Name	BTA-QC3031-3M
FCC ID	2AABGQ3031-3M
Applicant	EnzyTek Technoloy Inc.
Manufacturer	EnzyTek Technoloy Inc.
EUT Rated Voltage	USB 5V
EUT Test Voltage	USB 5V
EUT Supports Radios Application	Bluetooth BR/EDR/LE
Applicable Standard	47 CFR FCC Part 15, Subpart C (Section 15.247) KDB 558074 D01 DTS Meas. Guidance v05 ANSI C63.10 : 2013
Output Power	12.45 dBm
Test Result	Complied

Documented :

(Specialist / Emma Lu)

Technical Engineer :

(Deputy Section Manager / Jack Chang)

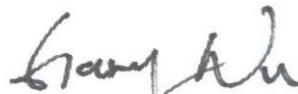
Approved :

(Project Manager / Gary Wu)

Table of Contents

Document Revision History	5
Summary of Test Result.....	6
1 Generation Information	7
1.1 Applicant.....	7
1.2 Manufacturer.....	7
1.3 Description of Equipment under Test.....	7
1.4 Test Mode Applicability And Tested Channel Detail	10
1.5 Configuration of Tested System	12
1.6 EUT Exercise Software	12
1.7 Tested System Details.....	13
1.8 Test Facility	14
1.9 Measurement Uncertainty	15
1.10 List of Test Equipment.....	16
2 Test Result	20
2.1 Antenna Requirement.....	20
2.1.1 Applicable Standard.....	20
2.1.2 Antenna Connected Construction	20
2.1.3 Antenna Gain	20
2.2 Peak Output Power Measurement.....	21
2.2.1 Limit	21
2.2.2 Test Setup.....	21
2.2.3 Test Procedure.....	21
2.2.4 Test Result	22
2.3 Number of Hopping Frequency	23
2.3.1 Limit	23
2.3.2 Test Setup.....	23
2.3.3 Test Procedure.....	23
2.3.4 Test Result	24
2.4 Hopping Channel Separation Measurement.....	25
2.4.1 Limit	25
2.4.2 Test Setup.....	25
2.4.3 Test Procedure.....	25
2.4.4 Test Result	26
2.5 Dwell Time Measurement.....	28
2.5.1 Limit	28
2.5.2 Test Setup.....	28
2.5.3 Test Procedure.....	28
2.5.4 Test Result	29
2.6 20dB Bandwidth Measurement.....	31
2.6.1 Limit	31
2.6.2 Test Setup.....	31
2.6.3 Test Procedure.....	31
2.6.4 Test Result	32
2.7 Conducted Band Edges and Spurious Emission Measurement	34
2.7.1 Limit	34
2.7.2 Test Setup.....	34

2.7.3	Test Procedure.....	34
2.7.4	Test Result	35
2.8	Radiated Band Edges and Spurious Emission Measurement	38
2.8.1	Limit	38
2.8.2	Test Setup.....	39
2.8.3	Test Procedure.....	40
2.8.4	Duty Cycle	41
2.8.5	Test Result of Radiated Band Edge Measurement.....	41
2.8.6	Test Result of Radiated Spurious Emission Measurement	50
2.9	AC Conducted Emissions Measurement.....	65
2.9.1	Limit	65
2.9.2	Test Setup.....	65
2.9.3	Test Procedure.....	66
2.9.4	Test Result	67
Attachment 1: EUT Test Photographs		
Attachment 2: EUT Detailed Photographs		

Document Revision History

Report No.	Issue date	Description
WD-RF-R-200309-B0	October 22, 2020	Initial report

Summary of Test Result

Ref. Std. Clause	Test Items	Result
15.203 15.247(C)	Antenna Requirement	Pass
15.247(b)(1)	Peak Conducted Output Power	Pass
15.247(a)(1)	Number of Hopping Frequency	Pass
15.247(a)(1)	Hopping Channel Separation	Pass
15.247(a)(1)	Dwell Time of Each Channel	Pass
15.247(a)(1)	20dB Bandwidth	Pass
15.247(d)	Conducted Band Edges and Conducted Spurious Emission	Pass
15.247(d)	Radiated Band Edges and Radiated Spurious Emission	Pass
15.207	AC Conducted Emission	N/A

1 Generation Information

1.1 Applicant

EnzyTek Technoloy Inc.
 7F,No.35,Hsueh Fu Rd., Hsinchu 300, Taiwan , R.O.C.

1.2 Manufacturer

EnzyTek Technoloy Inc.
 7F,No.35,Hsueh Fu Rd., Hsinchu 300, Taiwan , R.O.C.

1.3 Description of Equipment under Test

Product Name	BT Dual mode Module
Model No.	BTA-QC3031-3M
FCC ID	2AABGQ3031-3M
Frequency Range	2402~2480MHz
Number of Channels	79
Channel separation	1MHz
Type of Modulation	FHSS: GFSK(1Mbps) / π /4DQPSK(2Mbps) / 8DPSK(3Mbps)
Antenna Information	Refer to the table "Antenna List"
EUT Supports Radios Application	Bluetooth BR/EDR/LE
EUT Rated Voltage	USB 5V
EUT Test Voltage	USB 5V

Antenna List

No.	Manufacturer	Model No.	Antenna Type	Peak Gain
1	Enzytek	QC-AN24-1	PCB Antenna	-0.46 dBi for 2.4GHz

Remark: The antenna of EUT is conforming to FCC 15.203

Channel List

Channel	Frequency (MHz)	Channel	Frequency (MHz)	Channel	Frequency (MHz)	Channel	Frequency (MHz)
00	2402	20	2422	40	2442	60	2462
01	2403	21	2423	41	2443	61	2463
02	2404	22	2424	42	2444	62	2464
03	2405	23	2425	43	2445	63	2465
04	2406	24	2426	44	2446	64	2466
05	2407	25	2427	45	2447	65	2467
06	2408	26	2428	46	2448	66	2468
07	2409	27	2429	47	2449	67	2469
08	2410	28	2430	48	2450	68	2470
09	2411	29	2431	49	2451	69	2471
10	2412	30	2432	50	2452	70	2472
11	2413	31	2433	51	2453	71	2473
12	2414	32	2434	52	2454	72	2474
13	2415	33	2435	53	2455	73	2475
14	2416	34	2436	54	2456	74	2476
15	2417	35	2437	55	2457	75	2477
16	2418	36	2438	56	2458	76	2478
17	2419	37	2439	57	2459	77	2479
18	2420	38	2440	58	2460	78	2480
19	2421	39	2441	59	2461	--	--

Test Frequencies in each operating band

Frequency range over which the device operates in each operating band (Note 1)	Number of test frequencies required	Location of test frequencies inside the operating frequency range (Note 1,2)
≤ 1 MHz	1	near centre
> 1 MHz and ≤ 10 MHz	2	1 near high end, 1 near low end
> 10 MHz	3	1 near high end, 1 near centre, and 1 near low end

Note 1: The frequency range over which the device operates in a given operating band is the difference between the highest and lowest frequencies on which the device can be tuned within that given operating band. The frequency range can be smaller than or equal to the operating band, but cannot be greater than the operating band.

Note 2: In the third column of table 1, “near” means as close as possible to or at the centre / low end / high end of the frequency range over which the device operates.

Firmware / Software Version

1	Product Name	BT Dual mode Module
2	Model No.	BTA-QC3031-3M
3	Test SW Version	BlueTest 3.2.2
4	RF power setting in TEST SW	<input type="checkbox"/> RF power setting was not able to alter during testing. <input checked="" type="checkbox"/> RF power setting was able to alter during testing. (See the following table)

Parameters of test software setting

Type of Modulation	Channel	Frequency (MHz)	Set Value
BT(GFSK)	00	2402	0,2,0
	39	2441	0,2,0
	78	2480	0,2,0
BT($\pi/4$ DQPSK)	00	2402	0,2,0
	39	2441	0,2,0
	78	2480	0,2,0
BT(8DPSK)	00	2402	0,2,0
	39	2441	0,2,0
	78	2480	0,2,0

1.4 Test Mode Applicability And Tested Channel Detail

1. This device is a BT Dual mode Module with a built-in Bluetooth transceiver.
2. These tests were performed on a sample of equipment to demonstrate compliance with 47 CFR FCC Part 15, Subpart C (Section 15.247).
3. Pre-Scan has been conducted to determine the worst-case mode from all possible combinations between available modulations, data rates, XYZ axis and antenna ports.
4. The worst case was found when positioned on X axis for radiated emission. Following test modes were selected for the final test, and the final worst case is recorded in the report:

EUT Configure Mode	RE < 1G	RE ≥ 1G	ACM	ACP	Description
--	<input checked="" type="checkbox"/>	<input checked="" type="checkbox"/>	<input checked="" type="checkbox"/>	<input type="checkbox"/>	Transmit BT
--	<input type="checkbox"/>	<input type="checkbox"/>	<input type="checkbox"/>	<input type="checkbox"/>	Normal Link

Note : RE<1G: Radiated Emission below 1GHz RE≥1G: Radiated Emission above 1GHz
 ACM: Antenna Port Conducted Measurement ACP: AC Power Line Conducted Emission

Following channel(s) was (were) selected for the final test as listed below:

Radiated Spurious Emission Measurement(Below 1GHz):

EUT Configure Mode	Mode	Available Channel	Tested Channel	Modulation Type	Data Rate (Mbps)
--	BT	0 ~ 78	39	GFSK	1

Radiated Spurious Emission Measurement(Above 1GHz):

EUT Configure Mode	Mode	Available Channel	Tested Channel	Modulation Type	Data Rate (Mbps)
--	BT	0 ~ 78	0, 39, 78	GFSK	1
--	BT	0 ~ 78	0, 39, 78	8DPSK	3

Radiated Band Edge Emission Measurement(Above 1GHz):

EUT Configure Mode	Mode	Available Channel	Tested Channel	Modulation Type	Data Rate (Mbps)
--	BT	0 ~ 78	0, 78	GFSK	1
--	BT	0 ~ 78	0, 78	8DPSK	3

Peak Output Power, Hopping Channel Separation Measurement, 20dB Bandwidth, Conducted Spurious Emission:

EUT Configure Mode	Mode	Available Channel	Tested Channel	Modulation Type	Data Rate (Mbps)
--	BT	0 ~ 78	0, 39, 78	GFSK	1
--	BT	0 ~ 78	0, 39, 78	8DPSK	3

Number of Hopping Frequency, Dwell Time Measurement, Conducted Band Edges

EUT Configure Mode	Mode	Available Channel	Tested Channel	Modulation Type	Data Rate (Mbps)
--	BT	0 ~ 78	Hopping	GFSK	1
--	BT	0 ~ 78	Hopping	8DPSK	3

Conducted Band Edges

EUT Configure Mode	Mode	Available Channel	Tested Channel	Modulation Type	Data Rate (Mbps)
--	BT	0 ~ 78	0, 78	GFSK	1
--	BT	0 ~ 78	0, 78	8DPSK	3

AC Conducted Emission:

EUT Configure Mode	Mode	Available Channel	Tested Channel	Modulation Type	Data Rate (Mbps)
--	--	--	--	--	--

1.5 Configuration of Tested System

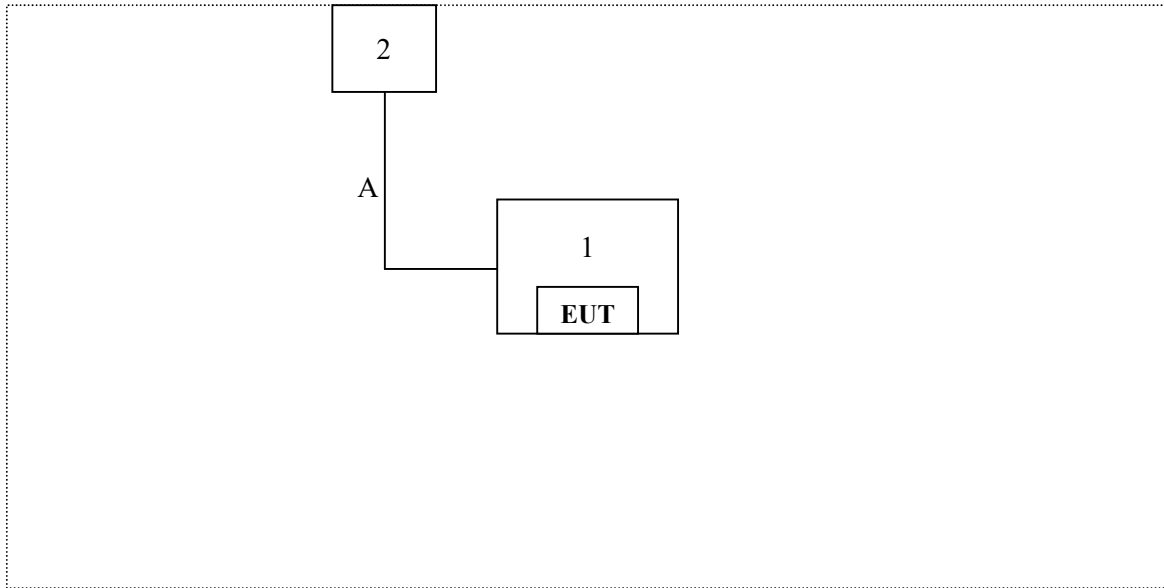

Test Table

1.6 EUT Exercise Software

1. Setup the EUT as shown in Section 1.5
2. Execute software “BlueTest 3.2.2”.
3. Configure the test mode, the test channel, and the data rate.
4. Press “OK” to start the continuous transmit.
5. Verify that the EUT works properly.

1.7 Tested System Details

The types for all equipment, plus descriptions of all cables used in the tested system (including inserted cards) are:

No.	Product	Manufacturer	Model No.	Serial No.	Power Cord
1	Fixture	N/A	BTA-QC30XX/51XX-MB V01	N/A	N/A
2	Notebook PC	acer	N16Q1	NXVF4TA023742254147600	Non-shielded, 1 Core, 0.8m

No.	Signal Cable Type	Signal cable Description
A	USB Cable	Shielded, Non-Core, 1.2m

1.8 Test Facility

Items	Required (IEC 60068-1)	Actual
Temperature (°C)	15-35	25
Humidity (% RH)	25-75	65
Barometric pressure (mbar)	860-1060	1001

Description: Accredited by TAF
Accredited Number: 2965

Issued by: Wendell Industrial Co., Ltd

Lab Address: 6F/6F-1, No.188, Baoqiao Rd., Xindian Dist.,
New Taipei City 23145, Taiwan R.O.C

Test Lab: Wendell EMC & RF Laboratory

Test Location: 1F., No. 119, Wugong 3rd Rd., Wugu Dist.,
New Taipei City 248, Taiwan (R.O.C.)

Designation Number: TW0025

Test Firm Registration Number: 665221

1.9 Measurement Uncertainty

ISO/IEC 17025 requires that an estimate of the measurement uncertainties associated with the emissions test results be included in the report. The measurement uncertainties given below are based on a 95% confidence (level based on a coverage factor K=2)

Measurement Project	Measuring Range	Expended Uncertainty
AC Conducted Emission	0.150 ~ 30 MHz	2.9 dB
Radiated Emission	0.009 ~ 30 MHz	4.2 dB
	30 ~ 1000 MHz	3.7 dB
	1000 ~ 18000 MHz	3.8 dB
	18000 ~ 40000 MHz	3.7 dB
RF Power, Conducted	1000 ~ 6000 MHz	0.51 dB
Occupied Bandwidth	1000 ~ 6000 MHz	2.4 %
Power Density	1000 ~ 6000 MHz	1.7 dB
Duty Cycle	1000 ~ 6000 MHz	1.3 %
Conducted Unwanted Emission Strength	1000 ~ 6000 MHz	1.8 dB
Frequency Stability	1000 ~ 6000 MHz	6.3×10^{-8}
DC Power Supply	0.5 ~ 30 V	3.2 %
Temperature	15 ~ 30 °C	1.1 °C
Humidity	40 ~ 80 %	3.4 %

Note: Please note that the measurement uncertainty are provided for informational purpose only and are not used in determining the Pass/Fail results.

1.10 List of Test Equipment

For Conducted measurements / W08-Conducted Measurement

Equipment	Manufacturer	Model No.	Serial No.	Cal. Date	Due Date
✓ Spectrum analyzer	Keysight	N9010A	MY54200737	2020/9/3	2021/9/2
✓ Wideband Peak Power Meter	Anritsu	ML2495A	1733007	2020/9/2	2021/9/1
✓ Pulse Power Sensor + Precision Adaptor	Anritsu	MA2411B	1726022	2020/9/2	2021/9/1
Temperature Chamber	TAICHY	MHK-225LK	1061121	2020/4/28	2021/4/27
Wireless Connectivity Tester	R&S	CMW270	101307	2020/5/19	2021/5/18
✓ Attenuator	MVE	MVE2211-10	CT-9-056	2020/9/3	2021/9/2
Attenuator	MVE	MVE2211-20	CT-9-057	2020/9/3	2021/9/2
Attenuator	MVE	MVE2211-30	CT-9-058	2020/9/3	2021/9/2
Power Divider	MVE	MVE8546	170826003	2020/9/3	2021/9/2
Power Splitter	MVE	MVE8547	170302047	2020/9/3	2021/9/2
DC Power Supply	GW INSTEK	GPC-3060D	GER817636	2020/9/4	2021/9/3

Remark:

1. All equipments are calibrated every one year.
2. The test instruments marked with “✓” are used to measure the final test results.

For AC Conduction measurements / Conducted Room

Equipment	Manufacturer	Model No.	Serial No.	Cal. Date	Due Date
EMI Test Receiver	R&S	ESR3	102309	2020/5/21	2021/5/20
2-Line V-Network LISN	R&S	ENV216	101185	2020/5/27	2021/5/26
LISN	SCHWARZBECK	NSLK 8127RC	05028	2020/5/27	2021/5/26
Transient Limiter	EM Electronics Corporation	EM-7600	857	2020/5/25	2021/5/24
50ohm Cable	EMCI	EMCCFD300-BM-BM- 5000	170613	2020/5/25	2021/5/24
50 ohm terminal impedance	HUBER+SUHNER	50 ohm terminal impedance	CT-1-109-1	2020/5/26	2021/5/25

Remark:

1. All equipments are calibrated every one year.
2. The test instruments marked with “√” are used to measure the final test results.
3. Test Software version: FARAD EZ-EMC Ver.EMC-CON 3A1

For Radiated measurements / W08-996-1

Equipment	Manufacturer	Model No.	Serial No.	Cal. Date	Due Date
✓ Signal Analyzer	KEYSIGHT	N9010A	MY52220228	2020/7/28	2021/7/ 27
✓ EMI Receiver	KEYSIGHT	N9038A	MY56400089	2020/7/30	2021/7/ 29
✓ Pre-Amplifier	EMEC	EMC330	060668	2020/7/28	2021/7/ 29
✓ Pre-Amplifier	JPT	EM01G18G	060648	2020/9/4	2021/9/3
✓ Pre-Amplifier	EMCI	EMC051845SE	980525	2020/9/4	2021/9/3
✓ Pre-Amplifier	EMCI	EMC184045SE	980515	2020/9/4	2021/9/3
✓ Loop Antenna	EMCI	LPA600(Loop)+SAS-562 B(Amp)	277 & 282	2020/9/2	2021/9/1
✓ Trilog Broadband Antenna with 5 dB Attenuator	SCHWARZBECK	VULB 9168 & FAT-NM5NF5T3G2W5	VULB 9168-373	2020/7/29	2021/7/28
✓ Horn Antenna	Schwarzbeck	BBHA 9120D	01557	2020/7/28	2021/7/27
✓ Horn Antenna	Schwarzbeck	BBHA 9170	703	2019/12/4	2020/12/3
✓ Cable	EMCI	EMCCFD400-NM-NM-1 000	190642	2020/7/29	2021/7/28
✓ Cable	PEWC	CFD400NL-LW-NM-NM -3000	191001	2020/7/30	2021/7/ 29
✓ Cable	EMCI	EMCCFD400-NM-NM-1 5000	190643	2020/7/30	2021/7/ 29
✓ Cable	EMCI	EMC104-SM-35M-600	190644	2020/7/30	2021/7/ 29
✓ Cable	EMCI	EMC104-SM-35M-15000	190645	2020/7/30	2021/7/ 29
✓ Cable	EMCI	EMC102-KM-KM-600	190646	2020/7/30	2021/7/ 29
✓ Cable	MVE	140140.LL404.700	A40098C	2020/7/30	2021/7/ 29
✓ RF Filter	EMEC	BRF-2400-2500	002	2020/9/3	2021/9/2
RF Filter	EMEC	BRF-5150-5350	104	2020/9/3	2021/9/2
RF Filter	EMEC	BRF-5470-5725	092	2020/9/3	2021/9/2
RF Filter	EMEC	BRF-5725-5875	091	2020/9/3	2021/9/2
✓ RF Filter	EMEC	HPF-2800	002	2020/9/3	2021/9/2
RF Filter	EMEC	HPF-5850	059	2020/9/3	2021/9/2
SMA Notch Filter	MVE	MFN-902.928.S1	190604001	2020/9/3	2021/9/2

Remark:

1. All equipments are calibrated every one year.
2. The test instruments marked with “✓” are used to measure the final test results.
3. Test Software version: FARAD EZ-EMC Ver.WD-03A1-1

2 Test Result

2.1 Antenna Requirement

2.1.1 Applicable Standard

An intentional radiator shall be designed to ensure that no antenna other than that furnished by the responsible party shall be used with the device. The use of a permanently attached antenna or of an antenna that uses a unique coupling to the intentional radiator shall be considered sufficient to comply with the provisions of this section. The manufacturer may design the unit so that a broken antenna can be replaced by the user, but the use of a standard antenna jack or electrical connector is prohibited.

An intentional radiator shall be designed to ensure that no antenna other than as furnished by the responsible party shall be used with the device. If transmitting antennas of directional gain greater than 6dBi are using the power shall be reduced by the amount in dB that the directional gain of the antenna exceeds 6 dBi, for compliance to FCC 47CFR 15.247 (c) requirements.

2.1.2 Antenna Connected Construction

Non-standard antenna connector is used.

2.1.3 Antenna Gain

No.	Manufacturer	Model No.	Antenna Type	Peak Gain
1	Enzytek	QC-AN24-1	PCB Antenna	-0.46 dBi for 2.4GHz

2.2 Peak Output Power Measurement

2.2.1 Limit

For frequency hopping systems operating in the 2400-2483.5 MHz band employing at least 75 non-overlapping hopping channels, and all frequency hopping systems in the 5725-5850 MHz band: 1 watt. For all other frequency hopping systems in the 2400-2483.5 MHz band 0.125 watts.

2.2.2 Test Setup

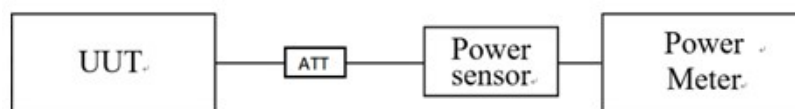

2.2.3 Test Procedure

1. Enable the EUT transmit continuously.
2. Measure the conducted output power with cable loss and record the results in the test report.

2.2.4 Test Result

Data Rate	Channel	Frequency (MHz)	Packet Type	Peak Power (dBm)	Power Limit (dBm)	Result
1 Mbps (GFSK)	00	2402	DH1	9.65	≤ 21	Pass
			DH3	9.78	≤ 21	Pass
			DH5	9.91	≤ 21	Pass
	39	2441	DH1	9.96	≤ 21	Pass
			DH3	10.10	≤ 21	Pass
			DH5	10.24	≤ 21	Pass
	78	2480	DH1	9.84	≤ 21	Pass
			DH3	9.98	≤ 21	Pass
			DH5	10.12	≤ 21	Pass
2 Mbps ($\pi/4$ -DQPSK)	00	2402	DH1	11.81	≤ 21	Pass
			DH3	11.95	≤ 21	Pass
			DH5	12.08	≤ 21	Pass
	39	2441	DH1	12.14	≤ 21	Pass
			DH3	12.26	≤ 21	Pass
			DH5	12.40	≤ 21	Pass
	78	2480	DH1	12.11	≤ 21	Pass
			DH3	12.26	≤ 21	Pass
			DH5	12.39	≤ 21	Pass
3 Mbps (8DPSK)	00	2402	DH1	11.87	≤ 21	Pass
			DH3	12.00	≤ 21	Pass
			DH5	12.14	≤ 21	Pass
	39	2441	DH1	12.19	≤ 21	Pass
			DH3	12.32	≤ 21	Pass
			DH5	12.45	≤ 21	Pass
	78	2480	DH1	12.14	≤ 21	Pass
			DH3	12.27	≤ 21	Pass
			DH5	12.41	≤ 21	Pass

Remark:

1. Peak Power = Reading value on power meter + cable loss
2. $10 \log(X/mW) = \text{dBm}$, $X=0.125$ watt (Limit)
 0.125 watt = 21 dBm

2.3 Number of Hopping Frequency

2.3.1 Limit

Frequency hopping systems operating in the 2400MHz-2483.5MHz bands shall use at least 15 hopping frequencies.

2.3.2 Test Setup



2.3.3 Test Procedure

1. Enable the EUT transmit continuously.
2. Spectrum analyzer set:
 - a) Span = the frequency band of operation
 - b) RBW = (RBW to less than 30% of the channel spacing or the 20 dB bandwidth, whichever is smaller)
 - c) VBW \geq RBW
 - d) Sweep = auto
 - e) Detector function = peak
 - f) Trace = max hold.
3. The number of hopping frequency used is defined as the number of total channel.

2.3.4 Test Result

Frequency (MHz)	Data Rate (Mbps)	Measurement (Hopping Channel)	Required Limit (Hopping Channel)	Result
2402 ~ 2480	1	79	≥ 15	Pass
2402 ~ 2480	3	79	≥ 15	Pass



2.4 Hopping Channel Separation Measurement

2.4.1 Limit

Frequency hopping systems operating in the 2400-2483.5 MHz band may have hopping channel carrier frequencies that are separated by 25 kHz or two-thirds of the 20 dB bandwidth of the hopping channel, whichever is greater, provided the systems operate with an output power no greater than 125 mW.

2.4.2 Test Setup



2.4.3 Test Procedure

1. Enable the EUT transmit continuously.
2. Spectrum analyzer set:
 - a) Span = wide enough to capture the peaks of two adjacent channels
 - b) RBW set to approximately 30% of the channel spacing
 - c) $VBW \geq RBW$
 - d) Sweep = auto
 - e) Detector function = peak
 - f) Trace = max hold.

2.4.4 Test Result

Channel	Frequency (MHz)	Data Rate (Mbps)	Measurement Level (MHz)	Limit of (2/3)*20dB (MHz)	Result
00	2402	1	0.996	≥ 0.642	Pass
39	2441	1	0.999	≥ 0.643	Pass
78	2480	1	0.999	≥ 0.641	Pass

Remark: 25kHz < two-thirds of the 20 dB bandwidth , whichever is two-thirds of the 20 dB bandwidth

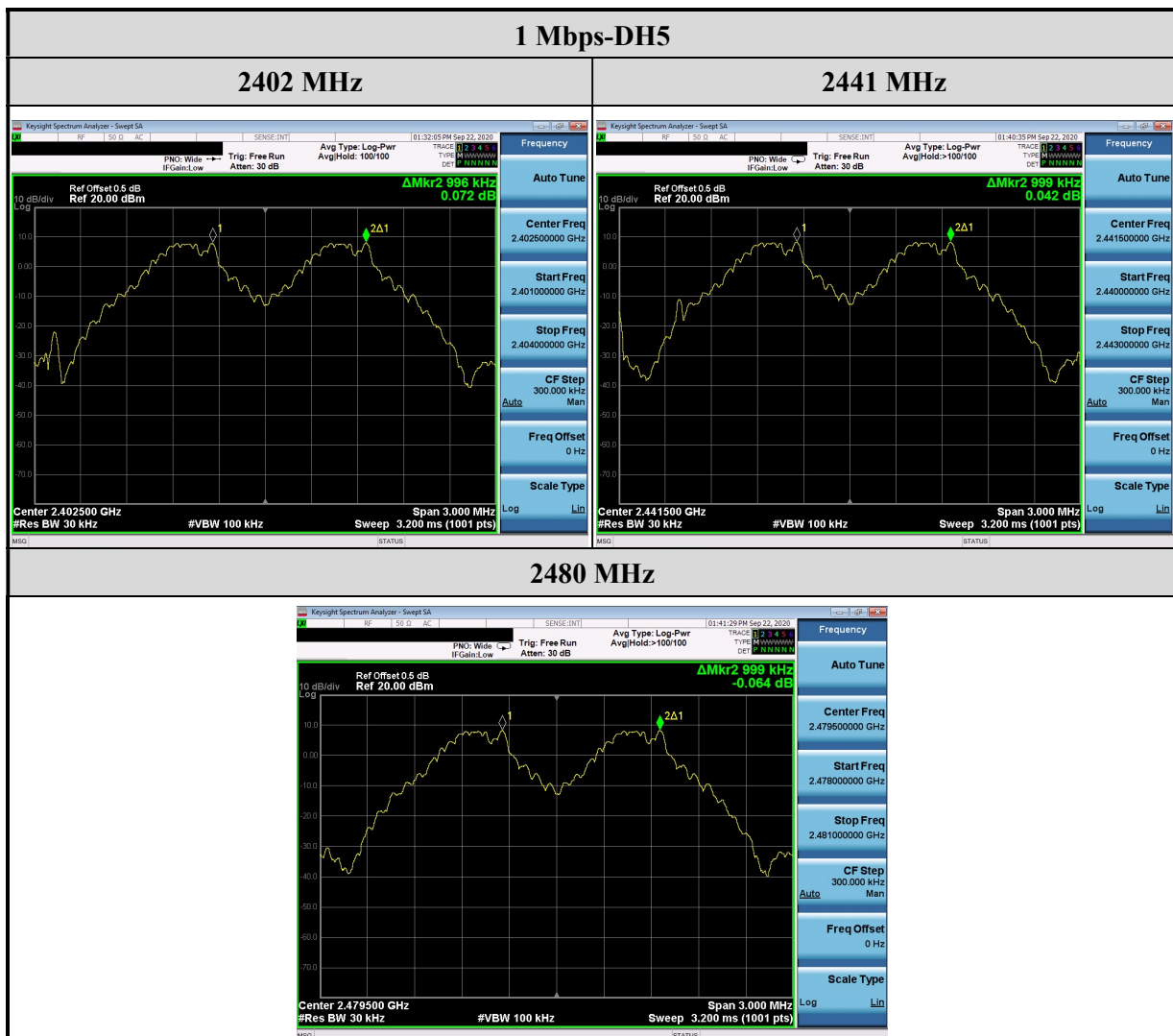

Channel	Frequency (MHz)	Data Rate (Mbps)	Measurement Level (MHz)	Limit of (2/3)*20dB (MHz)	Result
00	2402	3	0.999	≥ 0.871	Pass
39	2441	3	0.999	≥ 0.873	Pass
78	2480	3	1.002	≥ 0.872	Pass

Remark: 25kHz < two-thirds of the 20 dB bandwidth , whichever is two-thirds of the 20 dB bandwidth

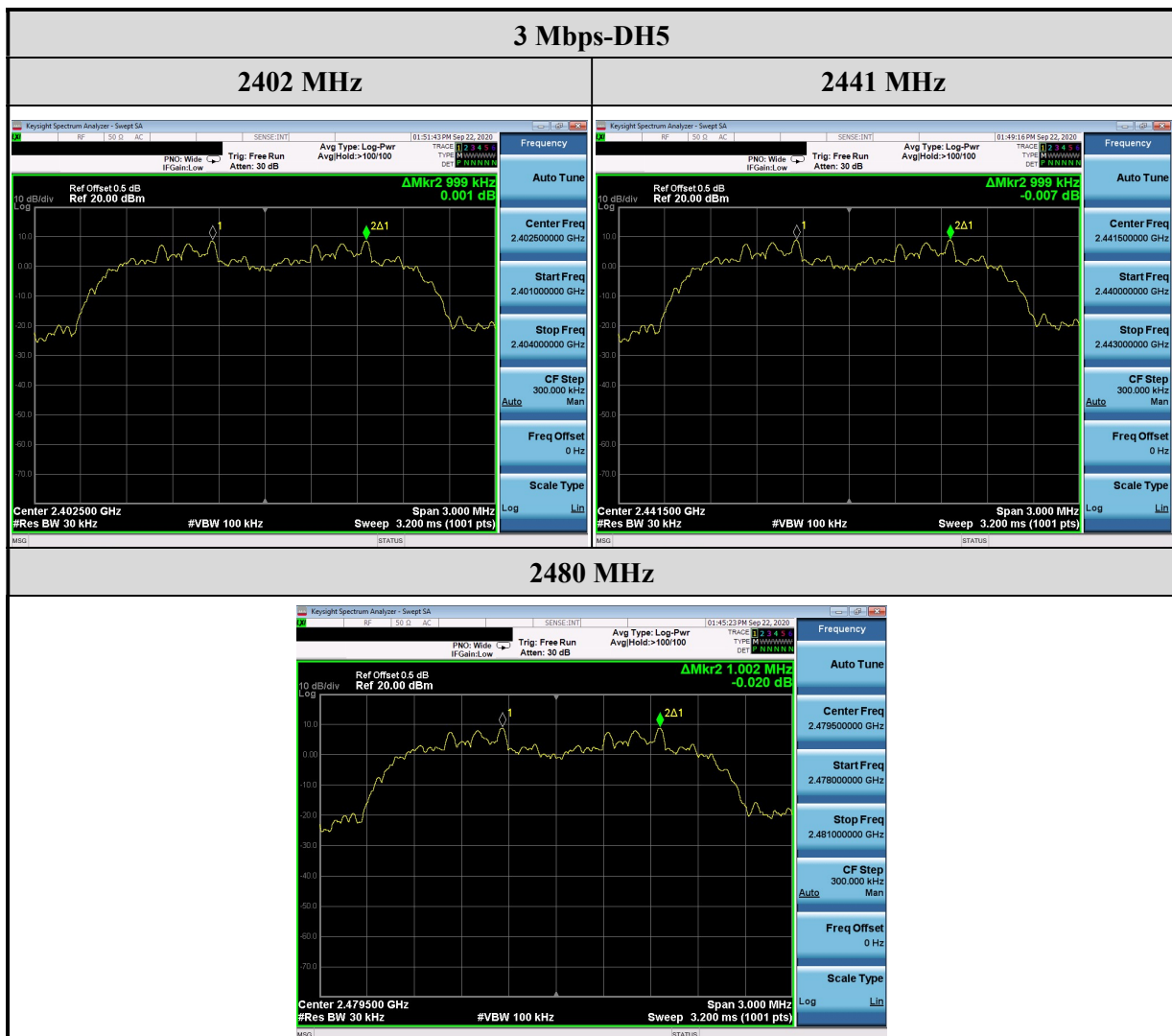

2.5 Dwell Time Measurement

2.5.1 Limit

The average time of occupancy on any channel shall not be greater than 0.4 seconds within a period of 0.4 seconds multiplied by the number of hopping channels employed.

2.5.2 Test Setup

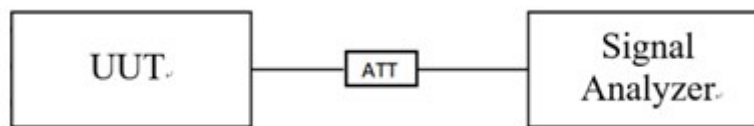

2.5.3 Test Procedure

1. Enable the EUT transmit continuously.
2. Spectrum analyzer set:
 - a) Span = zero span, centered on a hopping channel
 - b) RBW should be set $\gg 1 / T$, where T is the expected dwell time per channel
 - c) VBW \geq RBW
 - d) Sweep = as necessary to capture the entire dwell time per hopping channel
 - e) Detector function = peak
 - f) Trace = max hold.

2.5.4 Test Result

Data Rate (Mbps)	Data Packet	Pulse Duration (ms)	Number of hops during the actual observation period (in 3.16s)	Average time of occupancy (s)	Limit (s)	Result
1	DH1	0.408	32	0.1307	≤ 0.4	Pass
1	DH3	1.667	16	0.2667	≤ 0.4	Pass
1	DH5	2.917	10	0.2917	≤ 0.4	Pass

Remark:

1. Number of frequency hopping = 79
2. Standard observation period = 31.6 s
3. Average time of occupancy = Pulse Duration × (Standard Observation period / Number of hops during the actual observation period (in 3.16s))

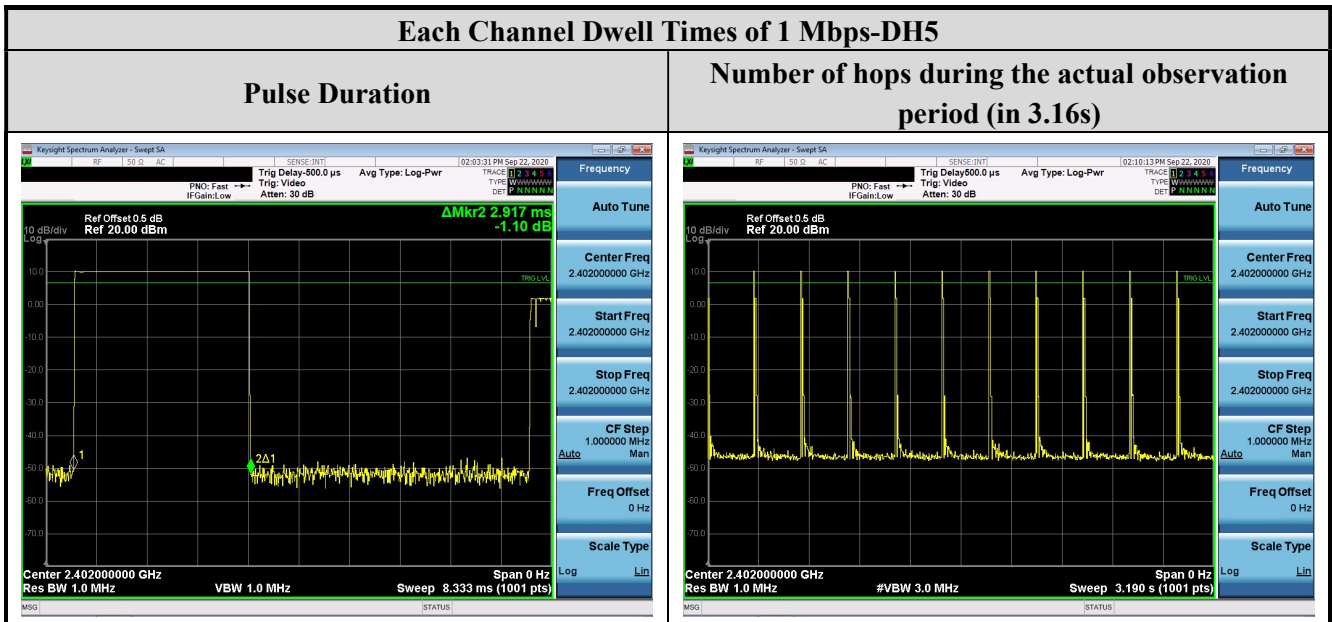

Data Rate (Mbps)	Data Packet	Pulse Duration (ms)	Number of hops during the actual observation period (in 3.16s)	Average time of occupancy (s)	Limit (s)	Result
3	DH1	0.425	32	0.1360	≤ 0.4	Pass
3	DH3	1.675	16	0.2680	≤ 0.4	Pass
3	DH5	2.925	10	0.2925	≤ 0.4	Pass

Remark:

1. Number of frequency hopping = 79
2. Standard observation period = 31.6 s
3. Average time of occupancy = Pulse Duration × (Standard Observation period / Number of hops during the actual observation period (in 3.16s))

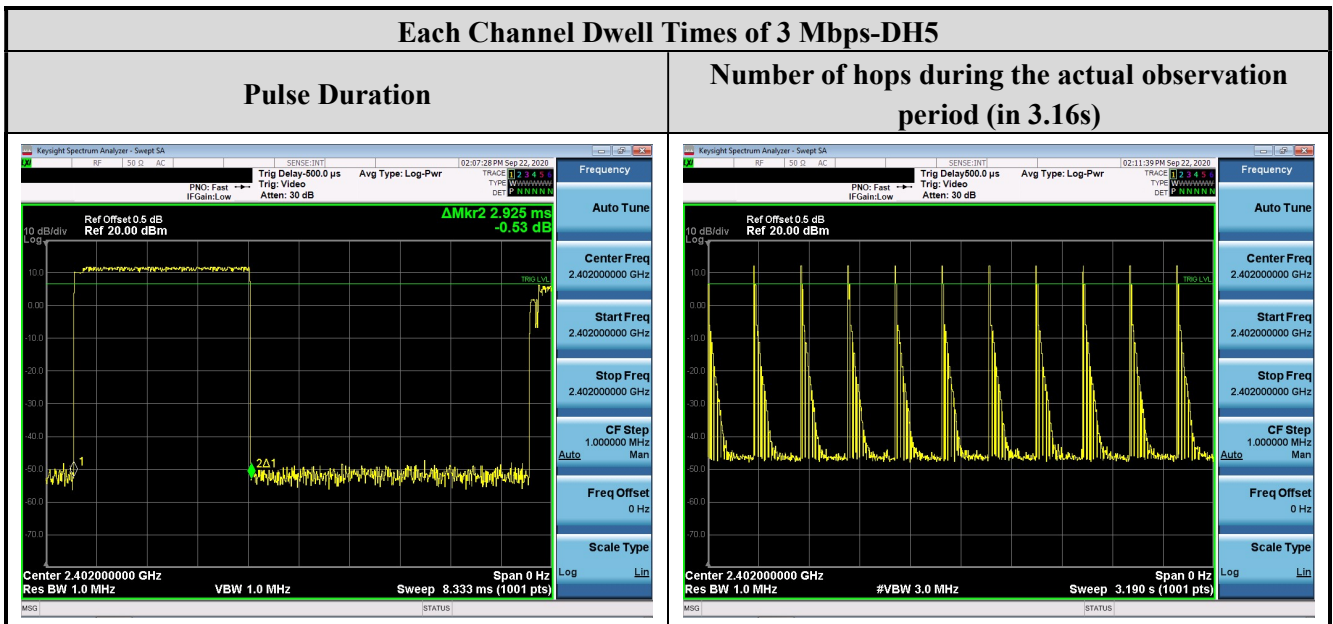

2.6 20dB Bandwidth Measurement

2.6.1 Limit

None.

2.6.2 Test Setup

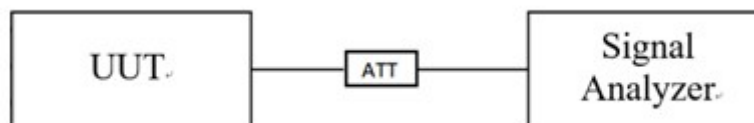

2.6.3 Test Procedure

1. Enable the EUT transmit continuously.
2. Spectrum analyzer set:
 - a) approximately 2 to 5 times the 20 dB bandwidth, centered on a hopping channel
 - b) RBW shall be in the range of 1% to 5% of the OBW
 - c) VBW shall be approximately three times RBW
 - d) Sweep time = auto
 - e) Detector function = peak
 - f) Trace mode = max hold.

2.6.4 Test Result

Channel	Frequency (MHz)	Data Rate (Mbps)	Measurement Level (MHz)	Required Limit (MHz)	Result
00	2402	1	0.964	None	N/A
39	2441	1	0.965	None	N/A
78	2480	1	0.962	None	N/A



Channel	Frequency (MHz)	Data Rate (Mbps)	Measurement Level (MHz)	Required Limit (MHz)	Result
00	2402	3	1.307	None	N/A
39	2441	3	1.309	None	N/A
78	2480	3	1.308	None	N/A



2.7 Conducted Band Edges and Spurious Emission Measurement

2.7.1 Limit

In any 100 KHz bandwidth outside the frequency bands in which the spread spectrum intentional radiator is operating, the radio frequency power that is produced by the intentional radiator shall be at least 20dB below that in the 100KHz bandwidth within the band that contains the highest level of the desired power, In addition, radiated emissions which fall in the restricted bands, as defined in must also comply with the radiated emission limits. If the transmitter complies with the conducted power limits based on the use of RMS averaging over a time interval, the attenuation required under this paragraph shall be 30 dB instead of 20 dB

2.7.2 Test Setup



2.7.3 Test Procedure

1. Enable the EUT transmit continuously.
2. Spectrum analyzer set :
 - a) RBW = 100 kHz
 - b) VBW = 300 kHz
 - c) Detector = peak
 - d) Sweep time = auto couple
 - e) Trace mode = max hold.