

EMC Test Report

Application for Grant of Equipment Authorization

Industry Canada RSS-Gen Issue 3 / RSS 210 Issue 8 FCC Part 15, Subpart E

Model: SR1410

FCC ID: 2AAAS-SR1410

APPLICANT: Vivint, Inc.
2500 W. Executive Parkway, Suite 200
Lehi, UT 84043

TEST SITE(S): National Technical Systems - Silicon Valley
41039 Boyce Road.
Fremont, CA. 94538-2435

IC SITE REGISTRATION #: 2845B-3; 2845B-7

REPORT DATE: August 9, 2013

FINAL TEST DATES: March 22, 26, 27 and 28, 2013

TOTAL NUMBER OF PAGES: 72

PROGRAM MGR /
TECHNICAL REVIEWER:

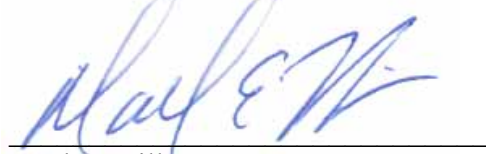

Mark E Hill
Staff Engineer

QUALITY ASSURANCE DELEGATE /
FINAL REPORT PREPARER:



David Guidotti
Senior Technical Writer



National Technical Systems - Silicon Valley is accredited by the A2LA, certificate number 0214.26, to perform the test(s) listed in this report, except where noted otherwise. This report and the information contained herein represent the results of testing test articles identified and selected by the client performed to specifications and/or procedures selected by the client. National Technical Systems (NTS) makes no representations, expressed or implied, that such testing is adequate (or inadequate) to demonstrate efficiency, performance, reliability, or any other characteristic of the articles being tested, or similar products. This report should not be relied upon as an endorsement or certification by NTS of the equipment tested, nor does it represent any statement whatsoever as to its merchantability or fitness of the test article, or similar products, for a particular purpose. This report shall not be reproduced except in full

REVISION HISTORY

Rev#	Date	Comments	Modified By
-	08-09-2013	First release	

TABLE OF CONTENTS

REVISION HISTORY2

TABLE OF CONTENTS3

SCOPE.....4

OBJECTIVE4

STATEMENT OF COMPLIANCE.....5

DEVIATIONS FROM THE STANDARDS.....5

TEST RESULTS SUMMARY6

 UNII / LELAN DEVICES6

 GENERAL REQUIREMENTS APPLICABLE TO ALL BANDS8

 MEASUREMENT UNCERTAINTIES.....9

EQUIPMENT UNDER TEST (EUT) DETAILS.....10

 GENERAL.....10

 OTHER EUT DETAILS.....10

 ANTENNA SYSTEM10

 ENCLOSURE.....10

 MODIFICATIONS.....10

 SUPPORT EQUIPMENT.....11

 EUT INTERFACE PORTS11

 EUT OPERATION11

TEST SITE.....12

 GENERAL INFORMATION.....12

 CONDUCTED EMISSIONS CONSIDERATIONS12

 RADIATED EMISSIONS CONSIDERATIONS12

MEASUREMENT INSTRUMENTATION13

 RECEIVER SYSTEM13

 INSTRUMENT CONTROL COMPUTER13

 LINE IMPEDANCE STABILIZATION NETWORK (LISN).....13

 FILTERS/ATTENUATORS14

 ANTENNAS.....14

 ANTENNA MAST AND EQUIPMENT TURNTABLE.....14

 INSTRUMENT CALIBRATION.....14

TEST PROCEDURES15

 EUT AND CABLE PLACEMENT15

 CONDUCTED EMISSIONS.....15

 RADIATED EMISSIONS.....16

 CONDUCTED EMISSIONS FROM ANTENNA PORT18

 BANDWIDTH MEASUREMENTS18

 SPECIFICATION LIMITS AND SAMPLE CALCULATIONS19

 CONDUCTED EMISSIONS SPECIFICATION LIMITS: FCC 15.207; FCC 15.107(A), RSS GEN19

 GENERAL TRANSMITTER RADIATED EMISSIONS SPECIFICATION LIMITS20

 RECEIVER RADIATED SPURIOUS EMISSIONS SPECIFICATION LIMITS20

 FCC 15.407 (A) OUTPUT POWER LIMITS21

 OUTPUT POWER LIMITS –LELAN DEVICES.....21

 SPURIOUS EMISSIONS LIMITS –UNII AND LELAN DEVICES22

 SAMPLE CALCULATIONS - CONDUCTED EMISSIONS22

 SAMPLE CALCULATIONS - RADIATED EMISSIONS.....22

 SAMPLE CALCULATIONS - FIELD STRENGTH TO EIRP CONVERSION.....23

APPENDIX A TEST EQUIPMENT CALIBRATION DATA24

APPENDIX B TEST DATA25

END OF REPORT72

SCOPE

An electromagnetic emissions test has been performed on the Vivint, Inc. model SR1410, pursuant to the following rules:

Industry Canada RSS-Gen Issue 3
RSS 210 Issue 8 “Low-power Licence-exempt Radiocommunication Devices (All Frequency Bands): Category I Equipment”
FCC Part 15, Subpart E requirements for UNII Devices (using FCC DA 02-2138, August 30, 2002)

Conducted and radiated emissions data has been collected, reduced, and analyzed within this report in accordance with measurement guidelines set forth in the following reference standards and as outlined in National Technical Systems - Silicon Valley test procedures:

ANSI C63.10-2009
FCC General UNII Test Procedures KDB789033

The intentional radiator above has been tested in a simulated typical installation to demonstrate compliance with the relevant Industry Canada performance and procedural standards.

Final system data was gathered in a mode that tended to maximize emissions by varying orientation of EUT, orientation of power and I/O cabling, antenna search height, and antenna polarization.

Every practical effort was made to perform an impartial test using appropriate test equipment of known calibration. All pertinent factors have been applied to reach the determination of compliance.

OBJECTIVE

The primary objective of the manufacturer is compliance with the regulations outlined in the previous section.

Prior to marketing in the USA, all unlicensed transmitters and transceivers require certification. Receive-only devices operating between 30 MHz and 960 MHz are subject to either certification or a manufacturer’s declaration of conformity, with all other receive-only devices exempt from the technical requirements.

Prior to marketing in Canada, Class I transmitters, receivers and transceivers require certification. Class II devices are required to meet the appropriate technical requirements but are exempt from certification requirements.

Certification is a procedure where the manufacturer submits test data and technical information to a certification body and receives a certificate or grant of equipment authorization upon successful completion of the certification body’s review of the submitted documents. Once the equipment authorization has been obtained, the label

indicating compliance must be attached to all identical units, which are subsequently manufactured.

Maintenance of compliance is the responsibility of the manufacturer. Any modification of the product which may result in increased emissions should be checked to ensure compliance has been maintained (i.e., printed circuit board layout changes, different line filter, different power supply, harnessing or I/O cable changes, etc.).

STATEMENT OF COMPLIANCE

The tested sample of Vivint, Inc. model SR1410 complied with the requirements of the following regulations:

RSS 210 Issue 8 “Low-power Licence-exempt Radiocommunication Devices (All Frequency Bands): Category I Equipment”
FCC Part 15, Subpart E requirements for UNII Devices

Maintenance of compliance is the responsibility of the manufacturer. Any modifications to the product should be assessed to determine their potential impact on the compliance status of the device with respect to the standards detailed in this test report.

The test results recorded herein are based on a single type test of Vivint, Inc. model SR1410 and therefore apply only to the tested sample. The sample was selected and prepared by Venkat Kalkunte of Vivint, Inc..

DEVIATIONS FROM THE STANDARDS

No deviations were made from the published requirements listed in the scope of this report.

TEST RESULTS SUMMARY**UNII / LELAN DEVICES****Operation in the 5.25 – 5.35 GHz Band**

Note: The device may be used outdoors, therefore the spectral density of spurious emissions in the 5.15 – 5.25 GHz band were limited to the -27dBm/MHz limit.

FCC Rule Part	RSS Rule Part	Description	Measured Value / Comments	Limit / Requirement	Result (margin)
15.407(a)(2)		26dB Bandwidth	43.1MHz	N/A – limits output power if < 20MHz	N/A
15.407(a)(2)	A9.2(2)	Output Power	n40: 19.3dBm (0.086 W) (Max eirp: 0.543 W)	24dBm (250mW)	Complies
15.407(a)(2)	-	Power Spectral Density	n40: 3.7 dBm/MHz	9.0 dBm/MHz	Complies
-	A9.2(2) / A9.5 (2)	Power Spectral Density		11.0 dBm / MHz ¹	Complies

Operation in the 5.47 – 5.725 GHz Band

FCC Rule Part	RSS Rule Part	Description	Measured Value / Comments	Limit / Requirement	Result (margin)
15.407(a)(2)		26dB Bandwidth	46.5MHz	N/A – limits output power if < 20MHz	N/A
15.407(a)(2)	A9.2(2)	Output Power	n40: 19.9dBm (0.098 W) (Max eirp: 0.621 W)	24 dBm / 250mW (eirp < 30dBm)	Complies
15.407(a)(2)		Power Spectral Density	n40: 4.8 dBm/MHz	9.0 dBm/MHz	Complies
	A9.2(2) / A9.5 (2)	Power Spectral Density		11.0 dBm / MHz ²	Complies
KDB 443999	A9	Non-operation in 5600 – 5650 MHz sub band	Device cannot operate in the 5600 – 5650 MHz band –refer to Operational Description		Complies

¹ Reduced from 11dBm because highest value exceeded the average value by more than 3dB

² Reduced from 11dBm because highest value exceeded the average value by more than 3dB

Requirements for all U-NII/LELAN bands

FCC Rule Part	RSS Rule Part	Description	Measured Value / Comments	Limit / Requirement	Result
15.407	A9.5a	Modulation	Device uses OFDM	Digital modulation is required	Complies
15.407(b)(5) / 15.209	A9.3	Spurious Emissions	53.8 dB μ V/m @ 5350.0 MHz (-0.2 dB)	Refer to page 22	Complies
15.407(a)(6)	-	Peak Excursion Ratio	9.0 dB	< 13dB	Complies
	A9.5 (3)	Channel Selection	Spurious emissions tested at outermost channels in each band	Device was tested on the top, bottom and center channels in each band	N/A
15			Measurements on three channels in each band		
15.407 (c)	A9.5(4)	Operation in the absence of information to transmit	Operation is discontinued in the absence of information	Device shall automatically discontinue operation in the absence of information to transmit	Complies
15.407 (g)	A9.5 (5)	Frequency Stability	Frequency stability is better than 10ppm	Signal shall remain within the allocated band	Complies
15.407 (h1)	A9.4	Transmit Power Control	TCP mechanism is discussed in the Operational Description	The U-NII device shall have the capability to operate with a mean EIRP value lower than 24dBm (250mW)	Complies
15.407 (h2)	A9.4	Dynamic frequency Selection (device with radar detection)	Refer to separate test report, reference R91946	Threshold -62dBm (-64dBm if eirp > 200mW) Channel Availability Check > 60s Channel closing transmission time < 260ms Channel move time < 10s Non occupancy period > 30minutes	Complies
	A9.9g	User Manual information	Refer to Exhibit 6 for details	Warning regarding interference from Satellite Systems	Complies

GENERAL REQUIREMENTS APPLICABLE TO ALL BANDS

FCC Rule Part	RSS Rule part	Description	Measured Value / Comments	Limit / Requirement	Result (margin)
15.203	-	RF Connector	Uses standard SMA connectors – device is professionally installed	Unique or integral antenna required	Complies
15.207	RSS GEN Table 2	AC Conducted Emissions	62.6 dB μ V @ 0.154 MHz (-3.2 dB)	Refer to page 19	Complies
15.109	RSS GEN 7.2.3 Table 1	Receiver spurious emissions	-	Refer to page 20	N/A
15.247 (b) (5) 15.407 (f)	RSS 102	RF Exposure Requirements	Refer to MPE calculations in Exhibit 11, RSS 102 declaration and User Manual statements.	Refer to OET 65, FCC Part 1 and RSS 102	Complies
-	RSP 100 RSS GEN 4.4.1	99% Bandwidth	n40: 36.4 MHz	Information only	N/A

MEASUREMENT UNCERTAINTIES

ISO/IEC 17025 requires that an estimate of the measurement uncertainties associated with the emissions test results be included in the report. The measurement uncertainties given below are based on a 95% confidence level and were calculated in accordance with UKAS document LAB 34.

Measurement Type	Measurement Unit	Frequency Range	Expanded Uncertainty
RF power, conducted (power meter)	dBm	25 to 7000 MHz	± 0.52 dB
RF power, conducted (Spectrum analyzer)	dBm	25 to 7000 MHz	± 0.7 dB
Conducted emission of transmitter	dBm	25 to 26500 MHz	± 0.7 dB
Conducted emission of receiver	dBm	25 to 26500 MHz	± 0.7 dB
Radiated emission (substitution method)	dBm	25 to 26500 MHz	± 2.5 dB
Radiated emission (field strength)	dB μ V/m	25 to 1000 MHz	± 3.6 dB
		1000 to 40000 MHz	± 6.0 dB
Conducted Emissions (AC Power)	dB μ V	0.15 to 30 MHz	± 2.4 dB

EQUIPMENT UNDER TEST (EUT) DETAILS**GENERAL**

The Vivint, Inc. model SR1410 is a multiple high-definition (HD) video transceiver that streams using 5GHz 4x4 802.11 over long haul mesh networks at very low packet error rates. The EUT was treated as tabletop equipment during testing to simulate the end-user environment. The EUT is powered via POE interface.

The sample was received on March 22, 2013 and tested on March 22, 26, 27 and 28, 2013. The EUT consisted of the following component(s):

Company	Model	Description	Serial Number	FCC ID
Vivint, Inc.	SR1410	5GHz 4x4 802.11 Outdoor Access Point	10042	2AAAS-SR1410

OTHER EUT DETAILS

The following EUT details should be noted:
Device supports 40MHz operation only.
Minimum of MCS8, 2 spatial streams
CDD and Beamforming operation
TPC supported
Master Device
Outdoor use

ANTENNA SYSTEM

Four 5dBi omni antennas
EUT has standard SMA connectors

ENCLOSURE

The EUT enclosure is primarily constructed of cast aluminum. It measures approximately 10 cm wide by 16.2 cm deep by 6.5 cm high.

MODIFICATIONS

No modifications were made to the EUT during the time the product was at National Technical Systems - Silicon Valley.

SUPPORT EQUIPMENT

No local support equipment was used during testing.

The following equipment was used as remote support equipment for emissions testing:

Company	Model	Description	Serial Number	FCC ID
-	EH120150T	AC/DC Adapter	-	-
-	-	POE Injector	-	-
-	-	Laptop	-	-

EUT INTERFACE PORTS

The I/O cabling configuration during testing was as follows:

Port	Connected To	Description	Cable(s)	
			Shielded or Unshielded	Length(m)
EUT - POE	Remote POE Injector- POE	CAT5	Unshielded	10
POE Injector - LAN	Laptop	CAT5	Unshielded	2
POE Injector - DC	AC/DC Adapter	2wire	Unshielded	1.5

EUT OPERATION

During emissions testing the EUT was configured to continuously transmit on the noted channel at the lowest supported data rate of MCS8. This is the worst case condition.

TEST SITE**GENERAL INFORMATION**

Final test measurements were taken at the test sites listed below. Pursuant to section 2.948 of the FCC's Rules and section 3.3 of RSP-100, construction, calibration, and equipment data has been filed with the Commission and with industry Canada.

Site	Registration Numbers		Location
	FCC	Canada	
Chamber 4	769238	2845B-4	41039 Boyce Road Fremont, CA 94538-2435
Chamber 7	A2LA accreditation	2845B-7	

ANSI C63.4 recommends that ambient noise at the test site be at least 6 dB below the allowable limits. Ambient levels are below this requirement. The test site(s) contain separate areas for radiated and conducted emissions testing. Considerable engineering effort has been expended to ensure that the facilities conform to all pertinent requirements of ANSI C63.4.

CONDUCTED EMISSIONS CONSIDERATIONS

Conducted emissions testing is performed in conformance with ANSI C63.10. Measurements are made with the EUT connected to the public power network through a nominal, standardized RF impedance, which is provided by a line impedance stabilization network, known as a LISN. A LISN is inserted in series with each current-carrying conductor in the EUT power cord.

RADIATED EMISSIONS CONSIDERATIONS

The FCC has determined that radiation measurements made in a shielded enclosure are not suitable for determining levels of radiated emissions. Radiated measurements are performed in an open field environment or in a semi-anechoic chamber. The test sites are maintained free of conductive objects within the CISPR defined elliptical area incorporated in ANSI C63.4 guidelines and meet the Normalized Site Attenuation (NSA) requirements of ANSI C63.4.

MEASUREMENT INSTRUMENTATION

RECEIVER SYSTEM

An EMI receiver as specified in CISPR 16-1-1 is used for emissions measurements. The receivers used can measure over the frequency range of 9 kHz up to 2000 MHz. These receivers allow both ease of measurement and high accuracy to be achieved. The receivers have Peak, Average, and CISPR (Quasi-peak) detectors built into their design so no external adapters are necessary. The receiver automatically sets the required bandwidth for the CISPR detector used during measurements. If the repetition frequency of the signal being measured is below 20Hz, peak measurements are made in lieu of Quasi-Peak measurements.

For measurements above the frequency range of the receivers, a spectrum analyzer is utilized because it provides visibility of the entire spectrum along with the precision and versatility required to support engineering analysis. Average measurements above 1000MHz are performed on the spectrum analyzer using the linear-average method with a resolution bandwidth of 1 MHz and a video bandwidth of 10 Hz, unless the signal is pulsed in which case the average (or video) bandwidth of the measuring instrument is reduced to onset of pulse desensitization and then increased.

INSTRUMENT CONTROL COMPUTER

The receivers utilize either a Rohde & Schwarz EZM Spectrum Monitor/Controller or contain an internal Spectrum Monitor/Controller to view and convert the receiver measurements to the field strength at an antenna or voltage developed at the LISN measurement port, which is then compared directly with the appropriate specification limit. This provides faster, more accurate readings by performing the conversions described under Sample Calculations within the Test Procedures section of this report. Results are printed in a graphic and/or tabular format, as appropriate. A personal computer is used to record all measurements made with the receivers.

The Spectrum Monitor provides a visual display of the signal being measured. In addition, the controller or a personal computer run automated data collection programs which control the receivers. This provides added accuracy since all site correction factors, such as cable loss and antenna factors are added automatically.

LINE IMPEDANCE STABILIZATION NETWORK (LISN)

Line conducted measurements utilize a fifty microhenry Line Impedance Stabilization Network as the monitoring point. The LISN used also contains a 250 uH CISPR adapter. This network provides for calibrated radio frequency noise measurements by the design of the internal low pass and high pass filters on the EUT and measurement ports, respectively.

FILTERS/ATTENUATORS

External filters and precision attenuators are often connected between the receiving antenna or LISN and the receiver. This eliminates saturation effects and non-linear operation due to high amplitude transient events.

ANTENNAS

A loop antenna is used below 30 MHz. For the measurement range 30 MHz to 1000 MHz either a combination of a biconical antenna and a log periodic or a bi-log antenna is used. Above 1000 MHz, horn antennas are used. The antenna calibration factors to convert the received voltage to an electric field strength are included with appropriate cable loss and amplifier gain factors to determine an overall site factor, which is then programmed into the test receivers or incorporated into the test software.

ANTENNA MAST AND EQUIPMENT TURNTABLE

The antennas used to measure the radiated electric field strength are mounted on a non-conductive antenna mast equipped with a motor-drive to vary the antenna height. Measurements below 30 MHz are made with the loop antenna at a fixed height of 1m above the ground plane.

ANSI C63.10 specifies that the test height above ground for table mounted devices shall be 80 centimeters. Floor mounted equipment shall be placed on the ground plane if the device is normally used on a conductive floor or separated from the ground plane by insulating material from 3 to 12 mm if the device is normally used on a non-conductive floor as specified in ANSI C63.4. During radiated measurements, the EUT is positioned on a motorized turntable in conformance with this requirement.

INSTRUMENT CALIBRATION

All test equipment is regularly checked to ensure that performance is maintained in accordance with the manufacturer's specifications. All antennas are calibrated at regular intervals with respect to tuned half-wave dipoles. An exhibit of this report contains the list of test equipment used and calibration information.

TEST PROCEDURES

EUT AND CABLE PLACEMENT

The regulations require that interconnecting cables be connected to the available ports of the unit and that the placement of the unit and the attached cables simulate the worst case orientation that can be expected from a typical installation, so far as practicable. To this end, the position of the unit and associated cabling is varied within the guidelines of ANSI C63.10, and the worst-case orientation is used for final measurements.

CONDUCTED EMISSIONS

Conducted emissions are measured at the plug end of the power cord supplied with the EUT. Excess power cord length is wrapped in a bundle between 30 and 40 centimeters in length near the center of the cord. Preliminary measurements are made to determine the highest amplitude emission relative to the specification limit for all the modes of operation. Placement of system components and varying of cable positions are performed in each mode. A final peak mode scan is then performed in the position and mode for which the highest emission was noted on all current carrying conductors of the power cord.

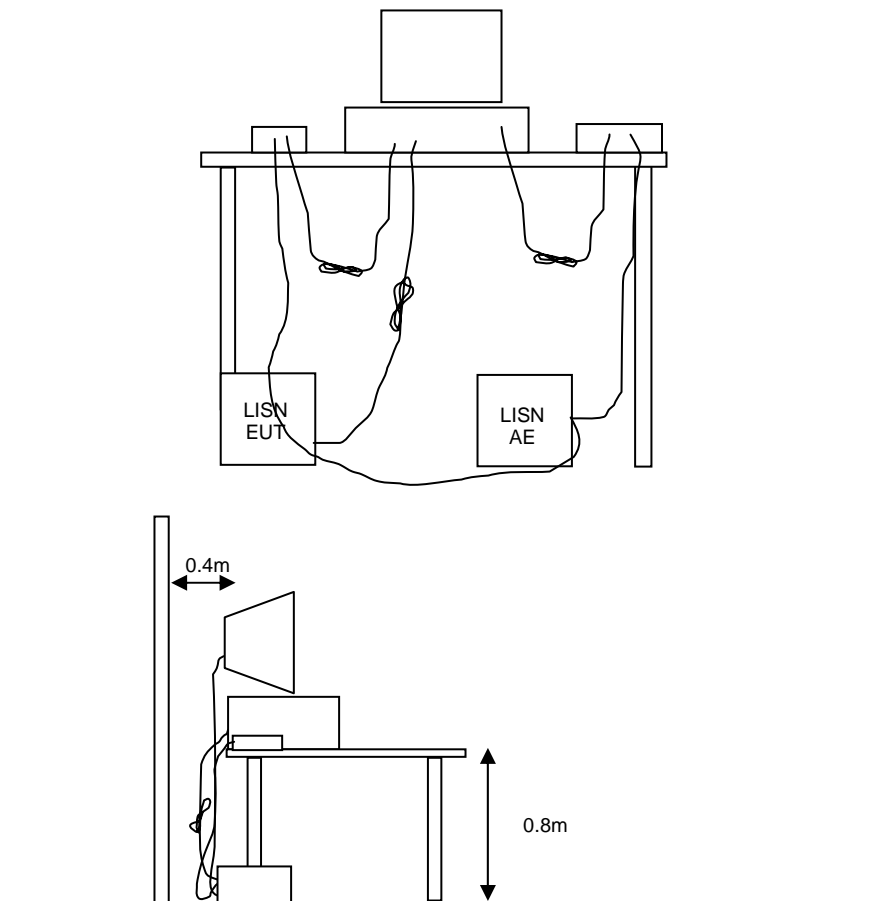

Figure 1 Typical Conducted Emissions Test Configuration

RADIATED EMISSIONS

A preliminary scan of the radiated emissions is performed in which all significant EUT frequencies are identified with the system in a nominal configuration. At least two scans are performed, one scan for each antenna polarization (horizontal and vertical; loop parallel and perpendicular to the EUT). During the preliminary scans, the EUT is rotated through 360°, the antenna height is varied (for measurements above 30 MHz) and cable positions are varied to determine the highest emission relative to the limit. Preliminary scans may be performed in a fully anechoic chamber for the purposes of identifying the frequencies of the highest emissions from the EUT.

A speaker is provided in the receiver to aid in discriminating between EUT and ambient emissions. Other methods used during the preliminary scan for EUT emissions involve scanning with near field magnetic loops, monitoring I/O cables with RF current clamps, and cycling power to the EUT.

Final maximization is a phase in which the highest amplitude emissions identified in the spectral search are viewed while the EUT azimuth angle is varied from 0 to 360 degrees relative to the receiving antenna. The azimuth, which results in the highest emission is then maintained while varying the antenna height from one to four meters (for measurements above 30 MHz, measurements below 30 MHz are made with the loop antenna at a fixed height of 1m). The result is the identification of the highest amplitude for each of the highest peaks. Each recorded level is corrected in the receiver using appropriate factors for cables, connectors, antennas, and preamplifier gain.

When testing above 18 GHz, the receive antenna is located at 1 meter from the EUT and the antenna height is restricted to a maximum of 2.5 meters.

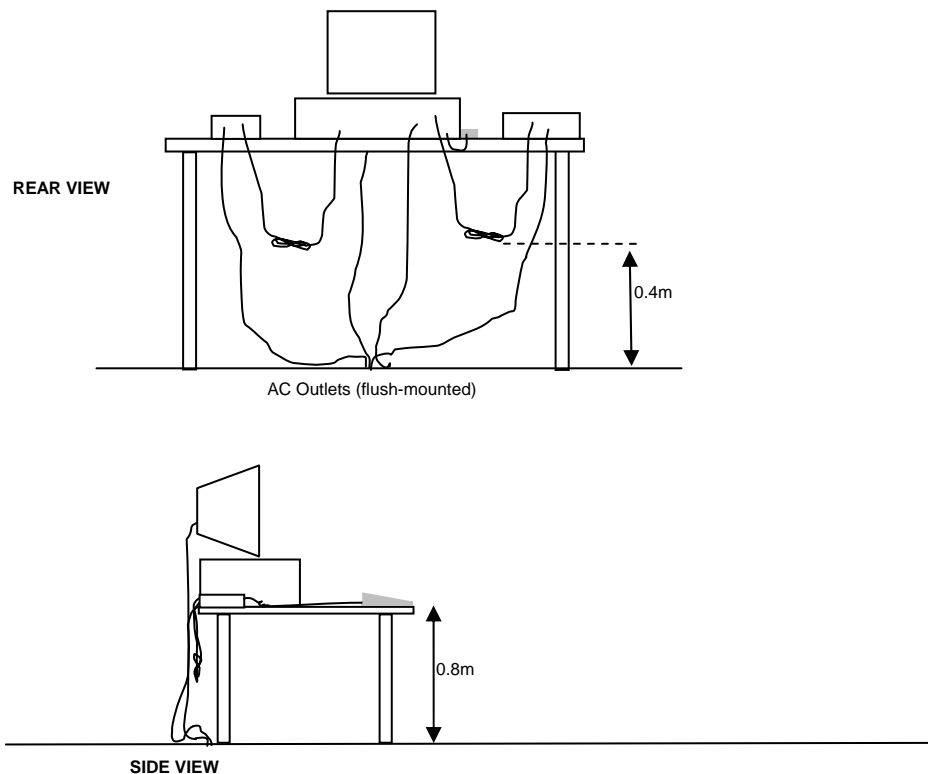

Typical Test Configuration for Radiated Field Strength Measurements

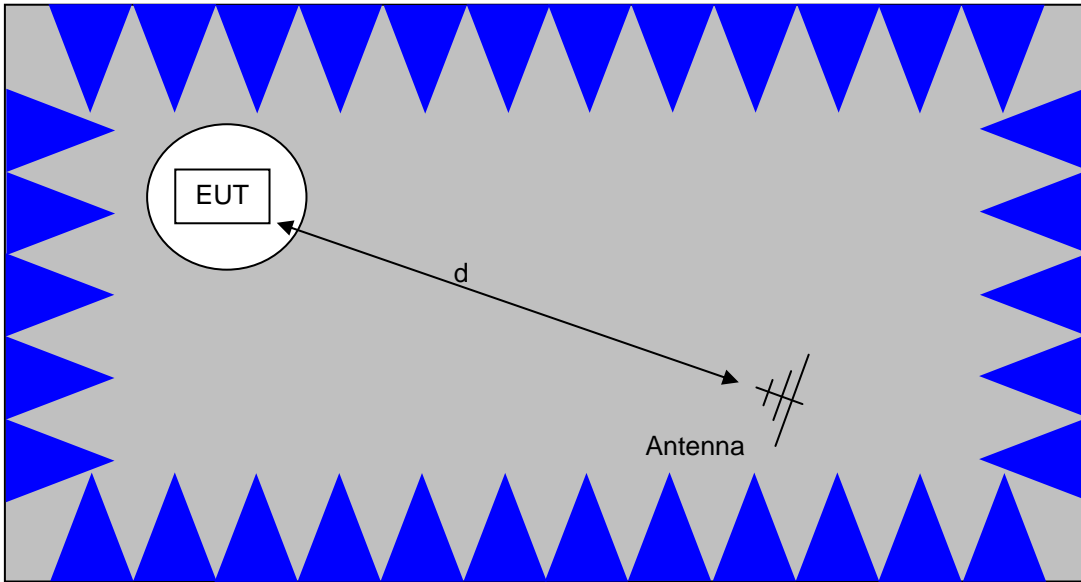

The anechoic materials on the walls and ceiling ensure compliance with the normalized site attenuation requirements of CISPR 16 / CISPR 22 / ANSI C63.4 for an alternate test site at the measurement distances used.

Floor-standing equipment is placed on the floor with insulating supports between the unit and the ground plane.

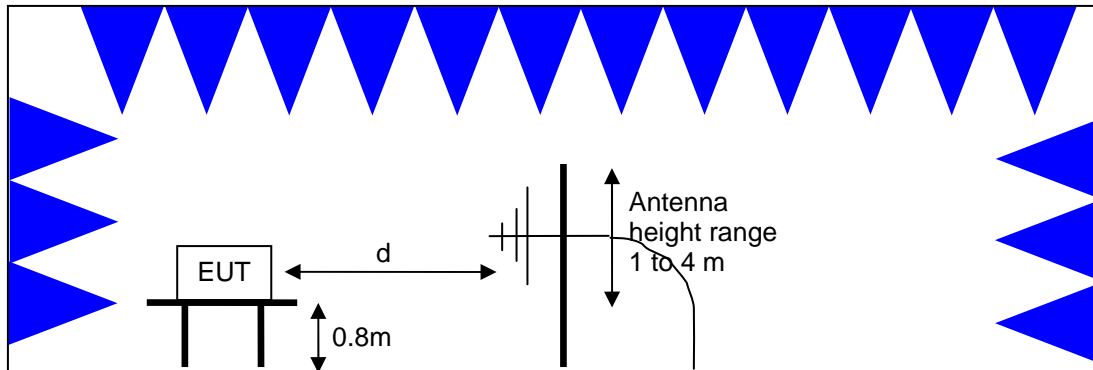

Test Configuration for Radiated Field Strength Measurements
Semi-Anechoic Chamber, Plan and Side Views

CONDUCTED EMISSIONS FROM ANTENNA PORT

Direct measurements of power, bandwidth and power spectral density are performed, where possible, with the antenna port of the EUT connected to either the power meter or spectrum analyzer via a suitable attenuator and/or filter. These are used to ensure that the front end of the measurement instrument is not overloaded by the fundamental transmission.

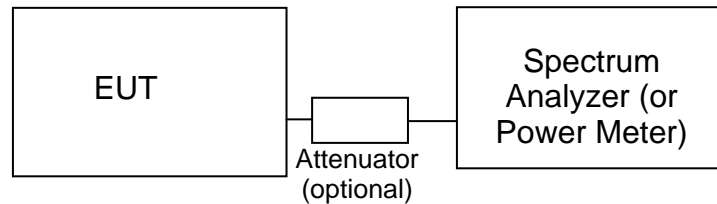
**Test Configuration for Antenna Port Measurements**

Measurement bandwidths (video and resolution) are set in accordance with the relevant standards and National Technical Systems - Silicon Valley's test procedures for the type of radio being tested. When power measurements are made using a resolution bandwidth less than the signal bandwidth the power is calculated by summing the power across the signal bandwidth using either the analyzer channel power function or by capturing the trace data and calculating the power using software. In both cases the summed power is corrected to account for the equivalent noise bandwidth (ENBW) of the resolution bandwidth used.

If power averaging is used (typically for certain digital modulation techniques), the EUT is configured to transmit continuously. Power averaging is performed using either the built-in function of the analyzer or, if the analyzer does not feature power averaging, using external software. In both cases the average power is calculated over a number of sweeps (typically 100). When the EUT cannot be configured to continuously transmit then either the analyzer is configured to perform a gated sweep to ensure that the power is averaged over periods that the device is transmitting or power averaging is disabled and a max-hold feature is used.

If a power meter is used to make output power measurements the sensor head type (peak or average) is stated in the test data table.

BANDWIDTH MEASUREMENTS

The 6dB, 20dB, 26dB and/or 99% signal bandwidth are measured using the bandwidths recommended by ANSI C63.10 and RSS GEN.

SPECIFICATION LIMITS AND SAMPLE CALCULATIONS

The limits for conducted emissions are given in units of microvolts, and the limits for radiated emissions are given in units of microvolts per meter at a specified test distance. Data is measured in the logarithmic form of decibels relative to one microvolt, or dB microvolts (dBuV). For radiated emissions, the measured data is converted to the field strength at the antenna in dB microvolts per meter (dBuV/m). The results are then converted to the linear forms of uV and uV/m for comparison to published specifications.

For reference, converting the specification limits from linear to decibel form is accomplished by taking the base ten logarithm, then multiplying by 20. These limits in both linear and logarithmic form are as follows:

CONDUCTED EMISSIONS SPECIFICATION LIMITS: FCC 15.207; FCC 15.107(a), RSS GEN

The table below shows the limits for the emissions on the AC power line from an intentional radiator and a receiver.

Frequency (MHz)	Average Limit (dBuV)	Quasi Peak Limit (dBuV)
0.150 to 0.500	Linear decrease on logarithmic frequency axis between 56.0 and 46.0	Linear decrease on logarithmic frequency axis between 66.0 and 56.0
0.500 to 5.000	46.0	56.0
5.000 to 30.000	50.0	60.0

GENERAL TRANSMITTER RADIATED EMISSIONS SPECIFICATION LIMITS

The table below shows the limits for the spurious emissions from transmitters that fall in restricted bands³ (with the exception of transmitters operating under FCC Part 15 Subpart D and RSS 210 Annex 9), the limits for all emissions from a low power device operating under the general rules of RSS 310 (tables 3 and 4), RSS 210 (table 2) and FCC Part 15 Subpart C section 15.209.

Frequency Range (MHz)	Limit (uV/m)	Limit (dBuV/m @ 3m)
0.009-0.490	2400/F _{KHz} @ 300m	67.6-20*log ₁₀ (F _{KHz}) @ 300m
0.490-1.705	24000/F _{KHz} @ 30m	87.6-20*log ₁₀ (F _{KHz}) @ 30m
1.705 to 30	30 @ 30m	29.5 @ 30m
30 to 88	100 @ 3m	40 @ 3m
88 to 216	150 @ 3m	43.5 @ 3m
216 to 960	200 @ 3m	46.0 @ 3m
Above 960	500 @ 3m	54.0 @ 3m

RECEIVER RADIATED SPURIOUS EMISSIONS SPECIFICATION LIMITS

The table below shows the limits for the spurious emissions from receivers as detailed in FCC Part 15.109, RSS 210 Table 2, RSS GEN Table 1 and RSS 310 Table 3. Note that receivers operating outside of the frequency range 30 MHz – 960 MHz are exempt from the requirements of 15.109.

Frequency Range (MHz)	Limit (uV/m @ 3m)	Limit (dBuV/m @ 3m)
30 to 88	100	40
88 to 216	150	43.5
216 to 960	200	46.0
Above 960	500	54.0

³ The restricted bands are detailed in FCC 15.203, RSS 210 Table 1 and RSS 310 Table 2

FCC 15.407 (a) OUTPUT POWER LIMITS

The table below shows the limits for output power and output power density. Where the signal bandwidth is less than 20 MHz the maximum output power is reduced to the power spectral density limit plus 10 times the log of the bandwidth (in MHz).

Operating Frequency (MHz)	Output Power	Power Spectral Density
5150 – 5250	50mW (17 dBm)	4 dBm/MHz
5250 – 5350	250 mW (24 dBm)	11 dBm/MHz
5725 – 5825	1 Watts (30 dBm)	17 dBm/MHz

For system using antennas with gains exceeding 6dBi, the output power and power spectral density limits are reduced by 1dB for every dB the antenna gain exceeds 6dBi. Fixed point-to-point applications using the 5725 – 5825 MHz band may use antennas with gains of up to 23dBi without this limitation. If the gain exceeds 23dBi then the output power limit of 1 Watt is reduced by 1dB for every dB the gain exceeds 23dBi.

The peak excursion envelope is limited to 13dB.

OUTPUT POWER LIMITS –LELAN DEVICES

The table below shows the limits for output power and output power density defined by RSS 210. Where the signal bandwidth is less than 20 MHz the maximum output power is reduced to the power spectral density limit plus 10 times the log of the bandwidth (in MHz).

Operating Frequency (MHz)	Output Power	Power Spectral Density
5150 – 5250	200mW (23 dBm) eirp	10 dBm/MHz eirp
5250 – 5350	250 mW (24 dBm) ⁴ 1W (30dBm) eirp	11 dBm/MHz
5470 – 5725	250 mW (24 dBm) ⁵ 1W (30dBm) eirp	11 dBm/MHz
5725 – 5825	1 Watts (30 dBm) 4W eirp	17 dBm/MHz

In addition, the power spectral density limit shall be reduced by 1dB for every dB the highest power spectral density exceeds the “average” power spectral density) by more than 3dB. The “average” power spectral density is determined by dividing the output power by $10\log(\text{EBW})$ where EBW is the 99% power bandwidth.

Fixed point-to-point applications using the 5725 – 5825 MHz band may use antennas with gains of up to 23dBi without this limitation. If the gain exceeds 23dBi then the output power limit of 1 Watt is reduced by 1dB for every dB the gain exceeds 23dBi.

⁴ If EIRP exceeds 500mW the device must employ TPC

⁵ If EIRP exceeds 500mW the device must employ TPC

SPURIOUS EMISSIONS LIMITS –UNII and LELAN DEVICES

The spurious emissions limits for signals below 1GHz are the FCC/RSS-GEN general limits. For emissions above 1GHz, signals in restricted bands are subject to the FCC/RSS GEN general limits. All other signals have a limit of -27dBm/MHz , which is a field strength of 68.3dBuV/m/MHz at a distance of 3m. This is an average limit so the peak value of the emission may not exceed -7dBm/MHz (88.3dBuV/m/MHz at a distance of 3m). For devices operating in the 5725-5850Mhz bands under the LELAN/UNII rules, the limit within 10Mhz of the allocated band is increased to -17dBm/MHz .

SAMPLE CALCULATIONS - CONDUCTED EMISSIONS

Receiver readings are compared directly to the conducted emissions specification limit (decibel form) as follows:

$$R_r - S = M$$

where:

R_r = Receiver Reading in dBuV

S = Specification Limit in dBuV

M = Margin to Specification in +/- dB

SAMPLE CALCULATIONS - RADIATED EMISSIONS

Receiver readings are compared directly to the specification limit (decibel form). The receiver internally corrects for cable loss, preamplifier gain, and antenna factor. The calculations are in the reverse direction of the actual signal flow, thus cable loss is added and the amplifier gain is subtracted. The Antenna Factor converts the voltage at the antenna coaxial connector to the field strength at the antenna elements.

A distance factor, when used for electric field measurements above 30MHz, is calculated by using the following formula:

$$F_d = 20 * \text{LOG}_{10} (D_m/D_s)$$

where:

F_d = Distance Factor in dB

D_m = Measurement Distance in meters

D_s = Specification Distance in meters

For electric field measurements below 30MHz the extrapolation factor is either determined by making measurements at multiple distances or a theoretical value is calculated using the formula:

$$F_d = 40 * \text{LOG}_{10} (D_m/D_s)$$

Measurement Distance is the distance at which the measurements were taken and Specification Distance is the distance at which the specification limits are based. The antenna factor converts the voltage at the antenna coaxial connector to the field strength at the antenna elements.

The margin of a given emission peak relative to the limit is calculated as follows:

$$R_c = R_r + F_d$$

and

$$M = R_c - L_s$$

where:

R_r = Receiver Reading in dBuV/m

F_d = Distance Factor in dB

R_c = Corrected Reading in dBuV/m

L_s = Specification Limit in dBuV/m

M = Margin in dB Relative to Spec

SAMPLE CALCULATIONS - FIELD STRENGTH TO EIRP CONVERSION

Where the radiated electric field strength is expressed in terms of the equivalent isotropic radiated power (eirp), or where a field strength measurement of output power is made in lieu of a direct measurement, the following formula is used to convert between eirp and field strength at a distance of d (meters) from the equipment under test:

$$E = \frac{1000000 \sqrt{30 P}}{d} \quad \text{microvolts per meter}$$

where P is the eirp (Watts)

For a measurement at 3m the conversion from a logarithmic value for field strength (dBuV/m) to an eirp power (dBm) is -95.3dB.

Appendix A Test Equipment Calibration Data

<u>Manufacturer</u>	<u>Description</u>	<u>Model</u>	<u>Asset #</u>	<u>Cal Due</u>
Radiated Emissions, 30 - 6,500 MHz, 22-Mar-13				
EMCO	Antenna, Horn, 1-18 GHz	3115	487	7/19/2014
Rohde & Schwarz	EMI Test Receiver, 20 Hz-7 GHz	ESIB7	1538	12/12/2013
Radiated Spurious Emissions, 1000 - 40,000 MHz, 25-Mar-13				
EMCO	Antenna, Horn, 1-18 GHz (SA40-Red)	3115	1142	8/23/2014
Rohde & Schwarz	EMI Test Receiver, 20 Hz-7 GHz	ESIB7	1630	5/31/2013
Hewlett Packard	Microwave Preamplifier, 1-26.5GHz	8449B	2199	2/19/2014
Micro-Tronics	Band Reject Filter, 5725-5875 MHz	BRC50705-02	2241	10/4/2013
Hewlett Packard	SpecAn 9 kHz - 40 GHz, (SA40) Purple	8564E (84125C)	2415	8/10/2013
Radiated Spurious Emissions, 1000 - 40,000 MHz, 26-Mar-13				
Hewlett Packard	Microwave Preamplifier, 1-26.5GHz	8449B	785	11/9/2013
Narda West	High Pass Filter, 8 GHz	HPF 180	821	3/13/2014
Hewlett Packard	Head (Inc flex cable, 1143, 2198) Red	84125C	1145	7/5/2013
Hewlett Packard	SpecAn 30 Hz -40 GHz, SV (SA40) Red	8564E (84125C)	1148	9/14/2013
EMCO	Antenna, Horn, 1-18 GHz	3115	1561	7/12/2014
Micro-Tronics	Band Reject Filter, 5725-5875 MHz	BRC50705-02	1682	3/13/2014
A.H. Systems	Blue System Horn, 18-40GHz	SAS-574, p/n: 2581	2159	5/30/2013
Micro-Tronics	Band Reject Filter, 5150-5350 MHz	BRC50703-02	2239	10/4/2013
Micro-Tronics	Band Reject Filter, 5470-5725 MHz	BRC50704-02	2240	10/4/2013
Radiated Emissions, 30 - 1,000 MHz, 26-Mar-13				
Sunol Sciences	Biconilog, 30-3000 MHz	JB3	1657	6/4/2014
Rohde & Schwarz	EMI Test Receiver, 20 Hz-7 GHz	ESIB7	1756	5/21/2013
Com-Power Corp.	Preamplifier, 30-1000 MHz	PAM-103	2380	11/9/2013
Radio Antenna Port (Power and Spurious Emissions), 27-Mar-13				
Hewlett Packard	SpecAn 30 Hz -40 GHz, SV (SA40) Red	8564E (84125C)	1148	9/14/2013
Rohde & Schwarz	EMI Test Receiver, 20 Hz-7 GHz	ESIB7	1756	5/21/2013
Radiated Emissions, Digital Device, 30 - 1,000 MHz, 28-Mar-13				
Sunol Sciences	Biconilog, 30-3000 MHz	JB3	1657	6/4/2014
Rohde & Schwarz	EMI Test Receiver, 20 Hz-7 GHz	ESIB7	1756	5/21/2013
Com-Power Corp.	Preamplifier, 30-1000 MHz	PAM-103	2380	11/9/2013
Conducted Emissions - AC Power Ports, 28-Mar-13				
Rohde & Schwarz	Pulse Limiter	ESH3 Z2	372	3/15/2014
Rohde & Schwarz	EMI Test Receiver, 20 Hz-7 GHz	ESIB7	1756	5/21/2013
Com-Power Corp.	9KHz-30MHz, 50uH, 15Aac, 10Adc, max	LI-215A	2671	5/25/2013

Appendix B Test Data

T91470 Pages 26 - 71



EMC Test Data

Client:	Vivint, Inc.	Job Number:	J91375
Product:	SR1410	T-Log Number:	T91470
		Account Manager:	Christine Krebill
Contact:	Venkat Kalkunte		
Emissions Standard(s):	FCC 15.E / FCC 15.B	Class:	A
Immunity Standard(s):	-	Environment:	-

EMC Test Data

For The

Vivint, Inc.

Product

SR1410

Date of Last Test: 4/19/2013



EMC Test Data

Client: Vivint, Inc.	Job Number: J91375
Model: SR1410	T-Log Number: T91470
	Account Manager: Christine Krebill
Contact: Venkat Kalkunte	
Standard: FCC 15.E / FCC 15.B	Class: A

Conducted Emissions

(Elliott Laboratories Fremont Facility, Semi-Anechoic Chamber)

Test Specific Details

Objective: The objective of this test session is to perform final qualification testing of the EUT with respect to the specification listed above.

Date of Test: 3/28/2013	Config. Used: 1
Test Engineer: John Caizzi	Config Change: none
Test Location: Fremont Chamber #7	EUT Voltage: PoE

General Test Configuration

For tabletop equipment, the EUT was located on a wooden table inside the semi-anechoic chamber, 40 cm from a vertical coupling plane and 80cm from the LISN. Any cables running to remote support equipment were routed through metal conduit and passed through a ferrite clamp upon exiting the chamber.

Ambient Conditions:	Temperature:	22 °C
	Rel. Humidity:	43 %

Summary of Results

Run #	Test Performed	Limit	Result	Margin
2	CE, AC Power, 120V/60Hz	FCC 15.207	Pass	62.6 dBµV @ 0.154 MHz (-3.2 dB)

Modifications Made During Testing

No modifications were made to the EUT during testing

Deviations From The Standard

No deviations were made from the requirements of the standard.

Client: Vivint, Inc.	Job Number: J91375
Model: SR1410	T-Log Number: T91470
Contact: Venkat Kalkunte	Account Manager: Christine Krebill
Standard: FCC 15.E / FCC 15.B	Class: A

Run #2: AC Power Port Conducted Emissions, 0.15 - 30MHz, 120V/60Hz. EUT transmitting on channel 102 at power setting 16.

Note: Plots show the FCC Class A limit. Tabular results calculated again the 15.207 limit.

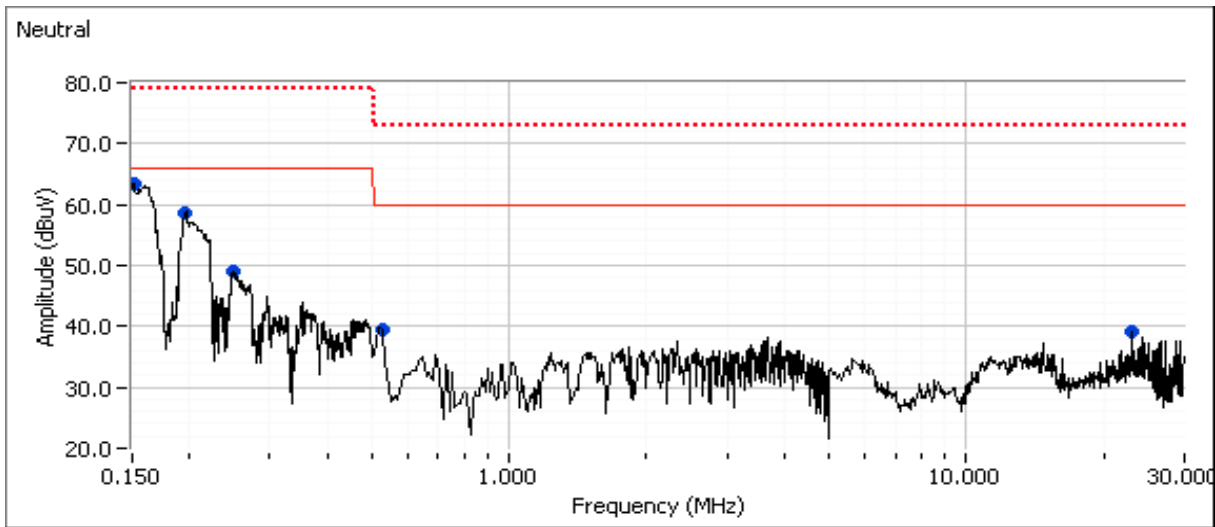
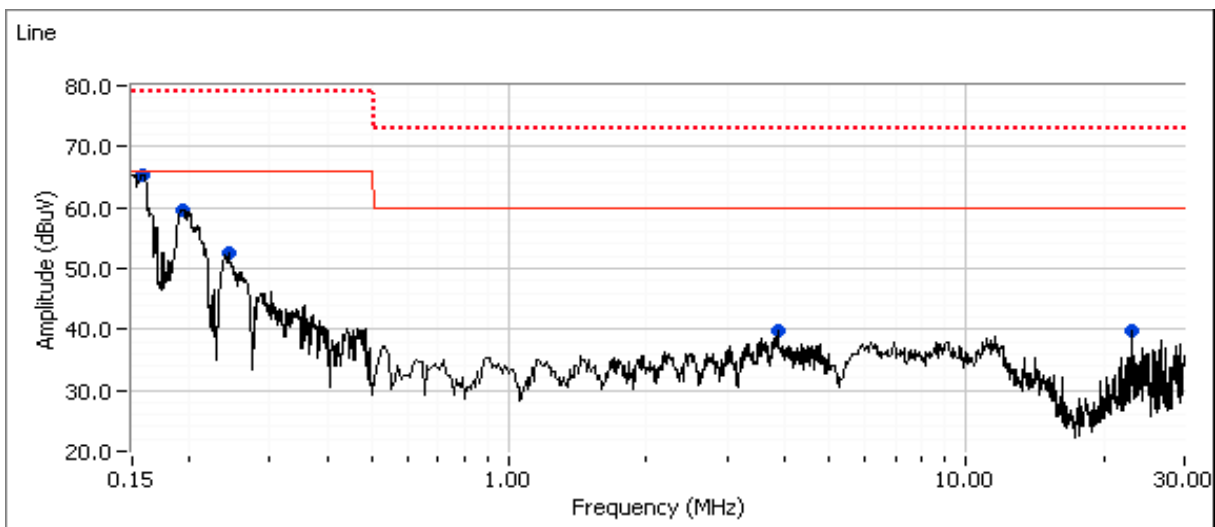



EMC Test Data

Client: Vivint, Inc.	Job Number: J91375
Model: SR1410	T-Log Number: T91470
	Account Manager: Christine Krebill
Contact: Venkat Kalkunte	
Standard: FCC 15.E / FCC 15.B	Class: A

Preliminary peak readings captured during pre-scan (peak readings vs. average limit)

Frequency MHz	Level dB μ V	AC Line	15.207		Detector QP/Ave	Comments
			Limit	Margin		
0.154	65.4	Line	55.8	9.6	Peak	
0.195	59.6	Line	53.8	5.8	Peak	
0.247	52.5	Line	51.9	0.6	Peak	
3.873	39.6	Line	46.0	-6.2	Peak	
23.136	39.7	Line	50.0	-10.3	Peak	
0.152	63.4	Neutral	55.9	7.5	Peak	
0.199	58.7	Neutral	53.6	5.1	Peak	
0.247	48.9	Neutral	51.9	-3.0	Peak	
0.527	39.6	Neutral	46.0	-6.4	Peak	
23.136	39.1	Neutral	50.0	-10.9	Peak	

Final quasi-peak and average readings

Frequency MHz	Level dB μ V	AC Line	15.207		Detector QP/Ave	Comments
			Limit	Margin		
0.154	62.6	Line	65.8	-3.2	QP	
0.152	60.8	Neutral	65.9	-5.1	QP	
0.154	49.0	Line	55.8	-6.8	AVG	
0.195	55.6	Line	63.8	-8.2	QP	
0.152	45.6	Neutral	55.9	-10.3	AVG	
0.199	52.7	Neutral	63.7	-11.0	QP	
0.195	38.8	Line	53.8	-15.0	AVG	
0.247	45.9	Line	61.9	-16.0	QP	
0.247	44.8	Neutral	61.9	-17.1	QP	
0.199	36.2	Neutral	53.7	-17.5	AVG	
0.247	27.9	Line	51.9	-24.0	AVG	
0.247	25.9	Neutral	51.9	-26.0	AVG	



EMC Test Data

Client: Vivint, Inc.	Job Number: J91375
Model: SR1410	T-Log Number: T91470
Contact: Venkat Kalkunte	Account Manager: Christine Krebill
Standard: FCC 15.E / FCC 15.B	Class: N/A

RSS 210 and FCC 15.407 (UNII) Radiated Spurious Emissions

Test Specific Details

Objective: The objective of this test session is to perform final qualification testing of the EUT with respect to the specification listed above.

General Test Configuration

The EUT and all local support equipment were located on the turntable for radiated spurious emissions testing. All remote support equipment was located outside the chamber.

For radiated emissions testing the measurement antenna was located 3 meters from the EUT.

Ambient Conditions: Temperature: 20-25 °C
 Rel. Humidity: 35-45 %

Summary of Results

Run #	Mode	Channel	Power Setting	Measured Power	Test Performed	Limit	Result / Margin
1	40MHz	62 @ 5310MHz	15	-	Restricted Band Edge at 5350 MHz	15.209	53.8 dBµV/m @ 5350.0 MHz (-0.2 dB)
2	40MHz	102 @ 5510MHz	16	-	Restricted Band Edge at 5460 MHz	15.209	50.7 dBµV/m @ 5460.0 MHz (-3.3 dB)
	40MHz	102 @ 5510MHz	15	-	Band Edge 5460 - 5470 MHz	15E	67.0 dBµV/m @ 5467.5 MHz (-1.3 dB)
	40MHz	110 @ 5550MHz	16	-	20dB BW at 5600MHz	15E	5569.339 MHz
	40MHz	134 @ 5670MHz	16	-	20dB BW at 5650MHz	15E	5651.263 MHz
	40MHz	134 @ 5670MHz	16	-	Band Edge 5725MHz	15E	62.4 dBµV/m @ 5729.8 MHz (-4.9 dB)

Modifications Made During Testing

No modifications were made to the EUT during testing

Deviations From The Standard

No deviations were made from the requirements of the standard.



EMC Test Data

Client: Vivint, Inc.	Job Number: J91375
Model: SR1410	T-Log Number: T91470
Contact: Venkat Kalkunte	Account Manager: Christine Krebill
Standard: FCC 15.E / FCC 15.B	Class: N/A

Test Procedure Comments:

Unless otherwise noted, average measurements above 1GHz were performed as documented in FCC KDB 789033 G) 6) d) Method VB

Antenna: 5dBi Omni
Duty Cycle: >98%

Note: Worse case antenna polarization was evaluated at channel 62. That polarity was used for all measurements.

Run #1, Radiated Spurious Emissions, Bandedge. Operation in the 5250-5350 MHz Band

Date of Test: 03/22/13

Test Location: chamber #4

Test Engineer: M. Birgani

Run #1b: High Channel - 62 @ 5310MHz

5350 MHz Band Edge Signal Radiated Field Strength

Frequency MHz	Level dB μ V/m	Pol v/h	FCC 15.209		Detector Pk/QP/Avg	Azimuth degrees	Height meters	Comments
			Limit	Margin				
5350.000	53.8	V	54.0	-0.2	AVG	32	1.0	Power setting: 15
5350.400	66.1	V	74.0	-7.9	PK	32	1.0	Power setting: 15
5351.280	42.0	H	54.0	-12.0	AVG	215	1.0	Power setting: 15
5350.240	54.1	H	74.0	-19.9	PK	215	1.0	Power setting: 15

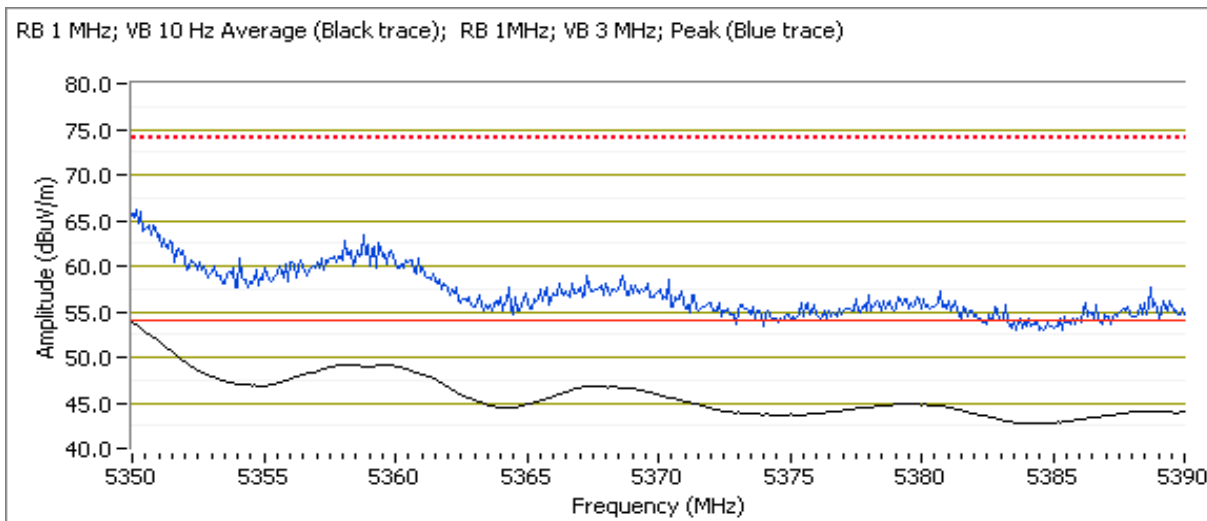



EMC Test Data

Client: Vivint, Inc.	Job Number: J91375
Model: SR1410	T-Log Number: T91470
Contact: Venkat Kalkunte	Account Manager: Christine Krebill
Standard: FCC 15.E / FCC 15.B	Class: N/A

Run #2, Radiated Spurious Emissions, 30 - 40,000 MHz. Operation in the 5470-5725 MHz Band
 Date of Test: 03/22/13 Test Location: chamber #4
 Test Engineer: M. Birgani

Run #2a: Low Channel - 102 @ 5510MHz
 5350-5460 MHz Restricted Band Edge Signal Radiated Field Strength

Frequency	Level	Pol	FCC 15.209		Detector	Azimuth	Height	Comments
MHz	dB μ V/m	v/h	Limit	Margin	Pk/QP/Avg	degrees	meters	
5460.000	50.7	V	54.0	-3.3	AVG	0	1.1	Power setting: 16
5460.000	65.8	V	74.0	-8.2	PK	0	1.1	Power setting: 16

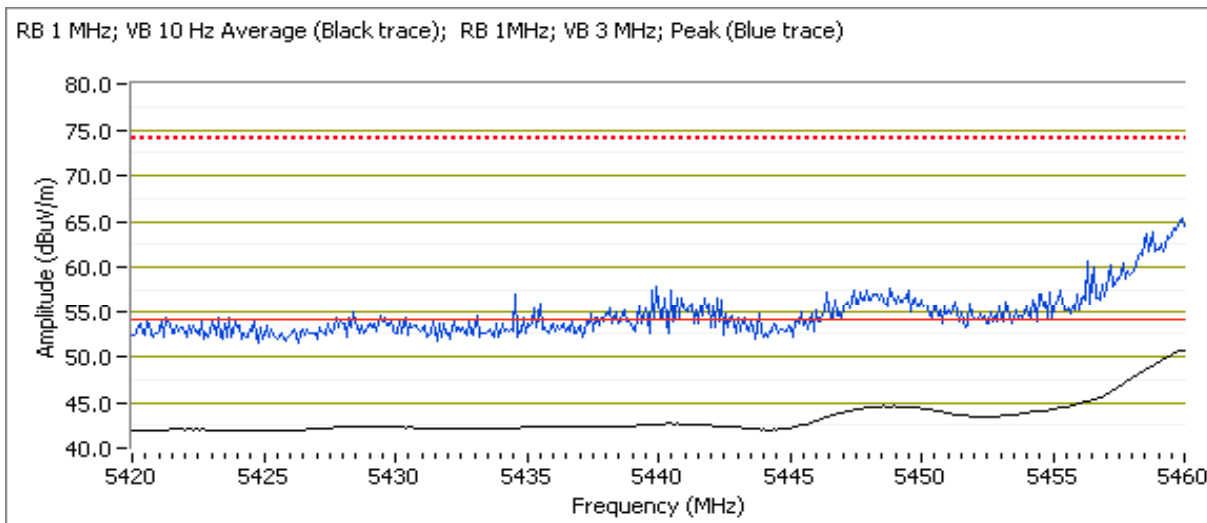



EMC Test Data

Client: Vivint, Inc.	Job Number: J91375
Model: SR1410	T-Log Number: T91470
Contact: Venkat Kalkunte	Account Manager: Christine Krebill
Standard: FCC 15.E / FCC 15.B	Class: N/A

5460 - 5470 MHz Band Edge Radiated Field Strength

Frequency MHz	Level dB μ V/m	Pol v/h	15 E		Detector Pk/QP/Avg	Azimuth degrees	Height meters	Comments
			Limit	Margin				
5467.460	67.0	V	68.3	-1.3	PK	0	1.1	Power setting: 15
5469.580	51.7	V	54.0	-2.3	AVG	0	1.1	Power setting: 15
5467.460	67.0	V	74.0	-7.0	PK	0	1.1	Power setting: 15

For emissions in the 5460-5470MHz frequency range the limit is -27dBm/MHz eirp (68.3dBuV/m). The measurement method required is a peak measurement (RB=1MHz, VB \geq 3MHz, peak detector).

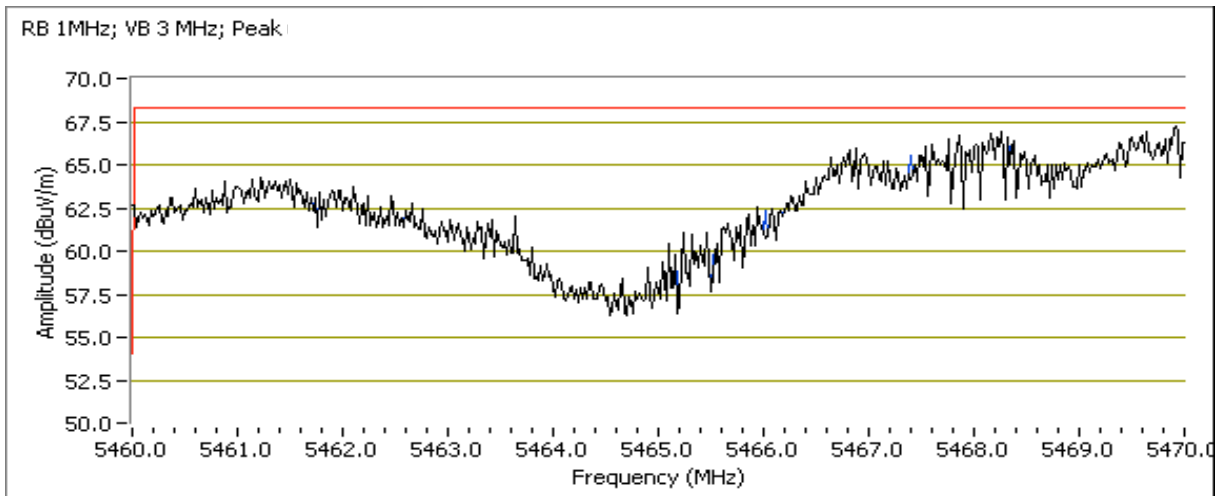

Client: Vivint, Inc.	Job Number: J91375
Model: SR1410	T-Log Number: T91470
Contact: Venkat Kalkunte	Account Manager: Christine Krebill
Standard: FCC 15.E / FCC 15.B	Class: N/A

Run #2b: Mid Channel - 110 @ 5550MHz
5600 MHz Band Edge Radiated Field Strength

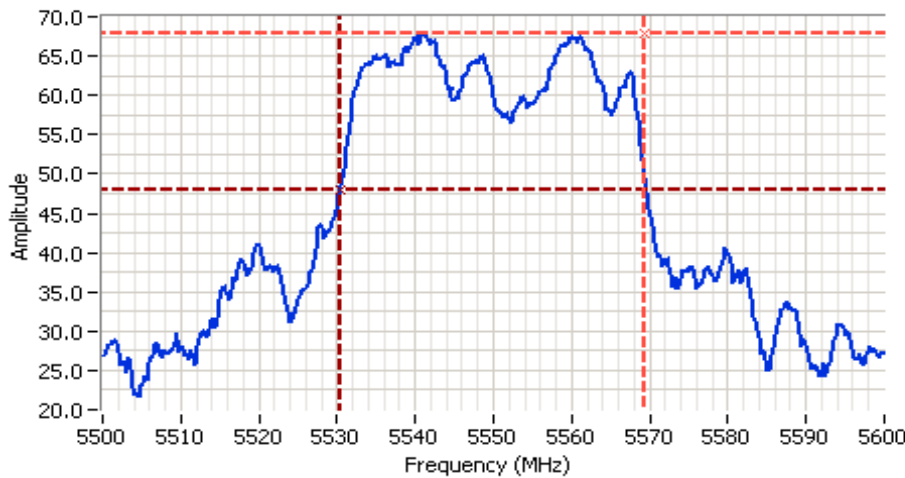

Analyzer Settings
 Rohde&Schwarz,ESI
 CF: 5550.000 MHz
 SPAN: 100.000 MHz
 RB: 1.000 MHz
 VB: 3.000 MHz
 Detector: POS
 Attn: 0 DB
 RL Offset: 0.0 DB
 Sweep Time: 5.0ms
 Ref Lvl: 72.0 DBUV

Comments
 20dB BW: 38.9 MHz
 FH: 5569.339 MHz

Cursor 1 5569.3387 67.87

Cursor 2 5530.4609 47.87

Delta Freq. 38.878

Delta Amplitude 20.00



Run #2c: High Channel - 134 @ 5670MHz

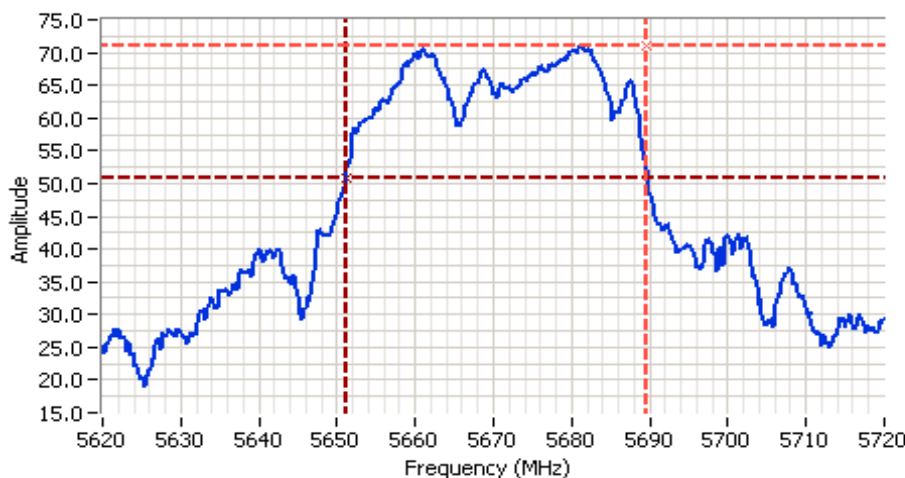

Analyzer Settings
 Rohde&Schwarz,ESI
 CF: 5670.000 MHz
 SPAN: 100.000 MHz
 RB: 1.000 MHz
 VB: 3.000 MHz
 Detector: POS
 Attn: 0 DB
 RL Offset: 0.0 DB
 Sweep Time: 5.0ms
 Ref Lvl: 72.0 DBUV

Comments
 20dB BW: 38.3 MHz
 FL: 5651.263 MHz

Cursor 1 5689.5391 70.91

Cursor 2 5651.2625 50.91

Delta Freq. 38.277

Delta Amplitude 20.00





EMC Test Data

Client: Vivint, Inc.	Job Number: J91375
Model: SR1410	T-Log Number: T91470
Contact: Venkat Kalkunte	Account Manager: Christine Krebill
Standard: FCC 15.E / FCC 15.B	Class: N/A

5725 MHz Band Edge Radiated Field Strength

Frequency	Level	Pol	15 E		Detector	Azimuth	Height	Comments
MHz	dB μ V/m	v/h	Limit	Margin	PK/QP/Avg	degrees	meters	
5729.810	62.4	V	67.3	-4.9	PK	0	1.1	Power setting: 16

For emissions in the 5725-5745 MHz frequency range the limit is -27dBm/MHz eirp (68.3dBuV/m). The measurement method required is a peak measurement (RB=1MHz, VB \geq 3MHz, peak detector).

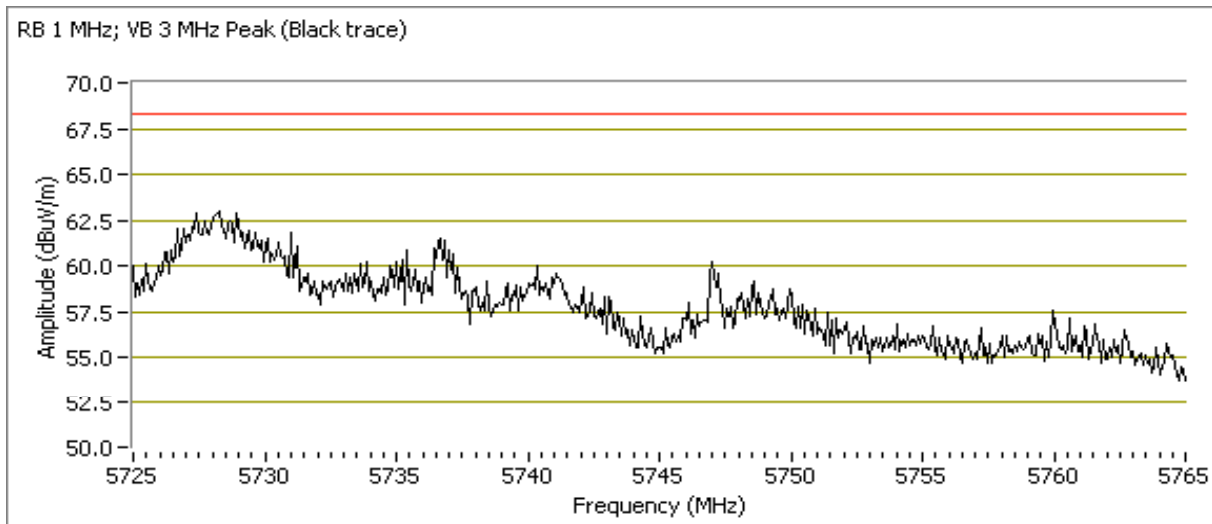



EMC Test Data

Client: Vivint, Inc.	Job Number: J91375
Model: SR1410	T-Log Number: T91470
Contact: Venkat Kalkunte	Account Manager: Christine Krebill
Standard: FCC 15.E / FCC 15.B	Class: N/A

RSS 210 and FCC 15.407 (UNII) Radiated Spurious Emissions

Test Specific Details

Objective: The objective of this test session is to perform final qualification testing of the EUT with respect to the specification listed above.

General Test Configuration

The EUT and all local support equipment were located on the turntable for radiated spurious emissions testing. All remote support equipment was located outside the chamber, with all I/O connections running under the groundplane, through brass pipe.

For radiated emissions testing the measurement antenna was located 3 meters from the EUT.

Ambient Conditions:

Temperature: 20 °C
Rel. Humidity: 40 %

Summary of Results

Run #	Mode	Channel	Power Setting	Measured Power	Test Performed	Limit	Result / Margin
2	40MHz	62 @ 5310MHz	16	-	Radiated Emissions, 1 - 40 GHz	FCC 15.209 / 15 E	60.1 dBµV/m @ 7080.0 MHz (-8.2 dB)
	40MHz	102 @ 5510MHz	16	-	Radiated Emissions, 1 - 40 GHz	FCC 15.209 / 15 E	48.2 dBµV/m @ 7346.8 MHz (-5.8 dB)
3	40MHz	110 @ 5550MHz	16	-	Radiated Emissions, 1 - 40 GHz	FCC 15.209 / 15 E	48.9 dBµV/m @ 7400.1 MHz (-5.1 dB)
	40MHz	134 @ 5670MHz	16	-	Radiated Emissions, 30MHz - 40 GHz	FCC 15.209 / 15 E	41.0 dBµV/m @ 125.01 MHz (-2.5 dB)

Modifications Made During Testing

No modifications were made to the EUT during testing

Deviations From The Standard

No deviations were made from the requirements of the standard.



EMC Test Data

Client: Vivint, Inc.	Job Number: J91375
Model: SR1410	T-Log Number: T91470
	Account Manager: Christine Krebill
Contact: Venkat Kalkunte	
Standard: FCC 15.E / FCC 15.B	Class: N/A

Test Procedure Comments:

Unless otherwise noted, average measurements above 1GHz were performed as documented in FCC KDB 789033 G) 6) d) Method VB

Antenna: 5dBi Omni
Duty Cycle: >98%

Testing for 30-1000 MHz was performed at the High Channel for UNII and Low Channel for DTS.



EMC Test Data

Client: Vivint, Inc.	Job Number: J91375
Model: SR1410	T-Log Number: T91470
Contact: Venkat Kalkunte	Account Manager: Christine Krebill
Standard: FCC 15.E / FCC 15.B	Class: N/A

Run #2, Radiated Spurious Emissions, 30 - 40,000 MHz. Operation in the 5250-5350 MHz Band

Date of Test: 3/26/2013
 Test Engineer: John Caizzi
 Test Location: Chamber 7

Run #1b: High Channel - 62 @ 5310MHz

Spurious Radiated Emissions:

Frequency MHz	Level dB μ V/m	Pol v/h	15.209 / 15E		Detector Pk/QP/Avg	Azimuth degrees	Height meters	Comments
			Limit	Margin				
7080.030	60.1	V	68.3	-8.2	PK	356	1.04	
10620.070	42.3	V	54.0	-11.7	AVG	340	1.00	
10618.070	54.4	V	74.0	-19.6	PK	340	1.00	
4950.140	45.1	V	54.0	-8.9	AVG	209	1.16	
4966.600	57.3	V	74.0	-16.7	PK	209	1.16	
4633.330	46.7	V	54.0	-7.3	Peak	218	1.5	Refer to DTS results
4800.000	48.5	V	54.0	-5.5	Peak	226	1.0	
4475.000	44.5	V	68.3	-23.8	Peak	229	1.5	

- Note 1: For emissions in restricted bands, the limit of 15.209 was used which requires average and peak measurements.
- Note 2: For emissions outside of the restricted bands the limit is -27dBm/MHz eirp (68.3dB μ V/m). The measurement method required is a peak measurement (RB=1MHz, VB \geq 3MHz, peak detector).

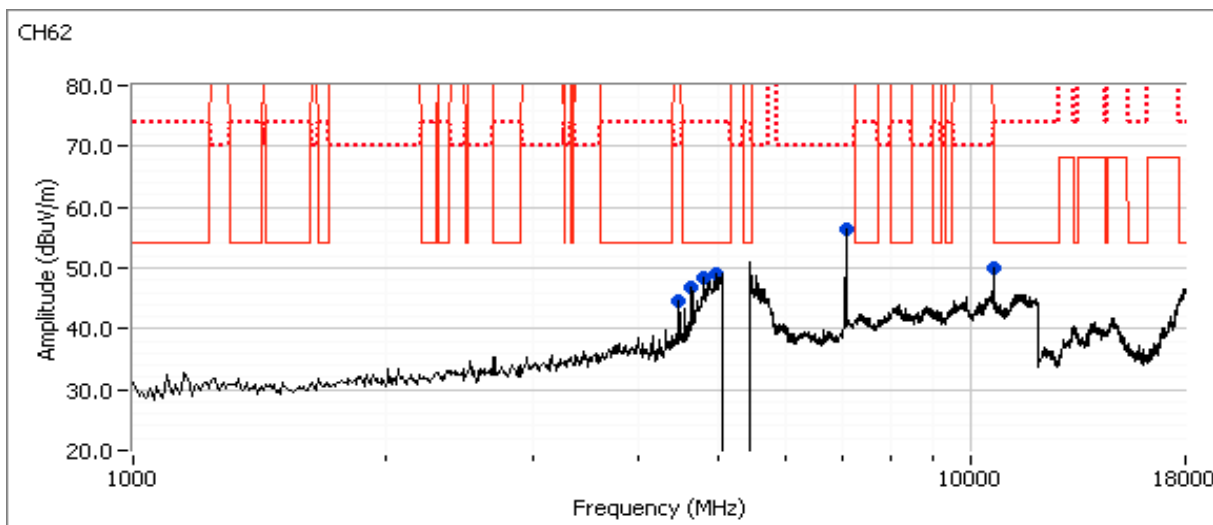

Client: Vivint, Inc.	Job Number: J91375
Model: SR1410	T-Log Number: T91470
Contact: Venkat Kalkunte	Account Manager: Christine Krebill
Standard: FCC 15.E / FCC 15.B	Class: N/A

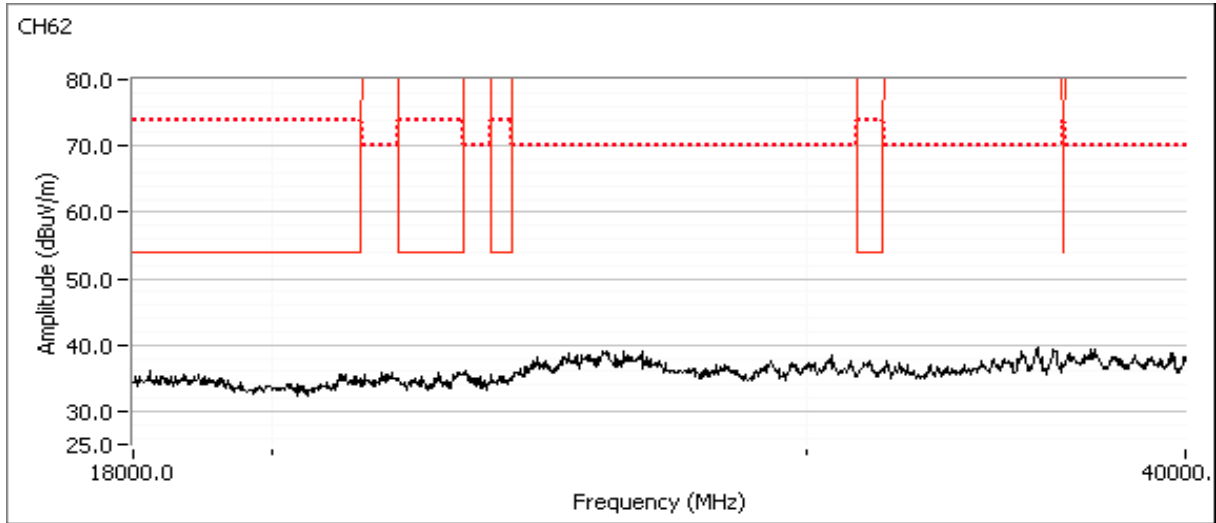



EMC Test Data

Client: Vivint, Inc.	Job Number: J91375
Model: SR1410	T-Log Number: T91470
	Account Manager: Christine Krebill
Contact: Venkat Kalkunte	
Standard: FCC 15.E / FCC 15.B	Class: N/A

Run #2, Radiated Spurious Emissions, 30 - 40,000 MHz. Operation in the 5470-5725 MHz Band

Date of Test: 3/26/2013
 Test Engineer: John Caizzi
 Test Location: Chamber 7

Run #2a: Low Channel - 102 @ 5510MHz

Spurious Radiated Emissions:

Frequency MHz	Level dB μ V/m	Pol v/h	15.209 / 15E		Detector Pk/QP/Avg	Azimuth degrees	Height meters	Comments
			Limit	Margin				
7346.770	48.2	V	54.0	-5.8	AVG	352	1.50	
7346.850	53.8	V	74.0	-20.2	PK	352	1.50	
4475.000	44.5	V	68.3	-23.8	Peak	335	1.50	
4641.670	46.0	V	54.0	-8.0	Peak	223	1.50	Refer to DTS results
4916.670	45.4	V	54.0	-8.6	Peak	215	1.00	Refer to DTS results

Note 1: For emissions in restricted bands, the limit of 15.209 was used which requires average and peak measurements.

Note 2: For emissions outside of the restricted bands the limit is -27dBm/MHz eirp (68.3dB μ V/m). The measurement method required is a peak measurement (RB=1MHz, VB \geq 3MHz, peak detector).

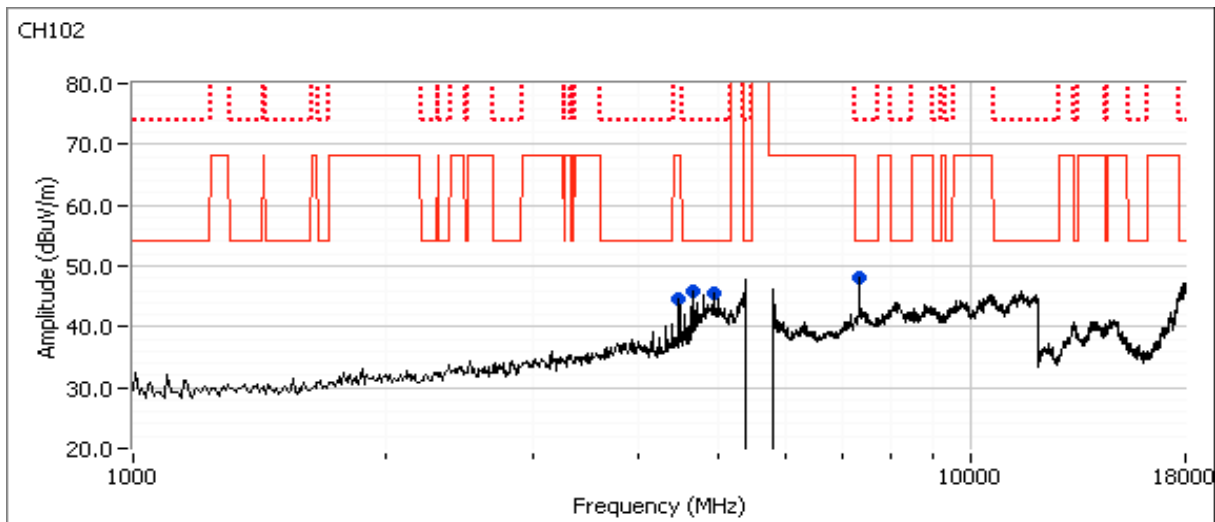

Client: Vivint, Inc.	Job Number: J91375
Model: SR1410	T-Log Number: T91470
Contact: Venkat Kalkunte	Account Manager: Christine Krebill
Standard: FCC 15.E / FCC 15.B	Class: N/A

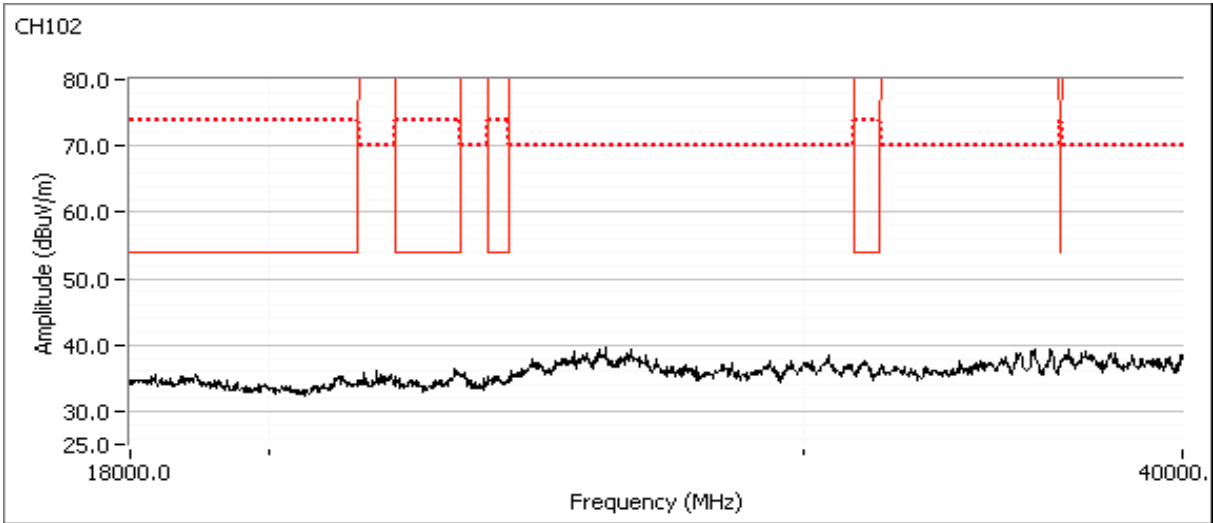



EMC Test Data

Client: Vivint, Inc.	Job Number: J91375
Model: SR1410	T-Log Number: T91470
Contact: Venkat Kalkunte	Account Manager: Christine Krebill
Standard: FCC 15.E / FCC 15.B	Class: N/A

Run #2b: Mid Channel - 110 @ 5550MHz

Spurious Radiated Emissions:

Frequency MHz	Level dB μ V/m	Pol v/h	15.209 / 15E		Detector Pk/QP/Avg	Azimuth degrees	Height meters	Comments
			Limit	Margin				
7400.080	48.9	V	54.0	-5.1	AVG	2	1.47	
7400.200	54.3	V	74.0	-19.7	PK	2	1.47	
4475.000	44.2	V	68.3	-24.1	Peak	12	1.50	
4633.330	45.1	V	54.0	-8.9	Peak	224	1.50	Refer to DTS Results
4800.000	47.0	V	54.0	-7.0	Peak	175	1.00	Refer to DTS Results

Note 1: For emissions in restricted bands, the limit of 15.209 was used which requires average and peak measurements.

Note 2: For emissions outside of the restricted bands the limit is -27dBm/MHz eirp (68.3dB μ V/m). The measurement method required is a peak measurement (RB=1MHz, VB \geq 3MHz, peak detector).

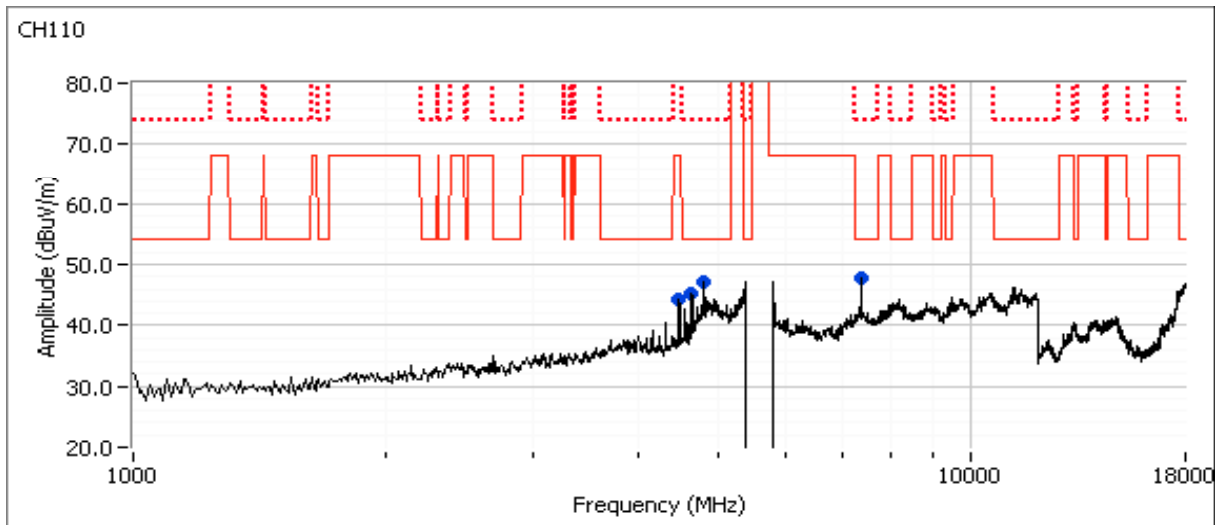

Client: Vivint, Inc.	Job Number: J91375
Model: SR1410	T-Log Number: T91470
	Account Manager: Christine Krebill
Contact: Venkat Kalkunte	
Standard: FCC 15.E / FCC 15.B	Class: N/A

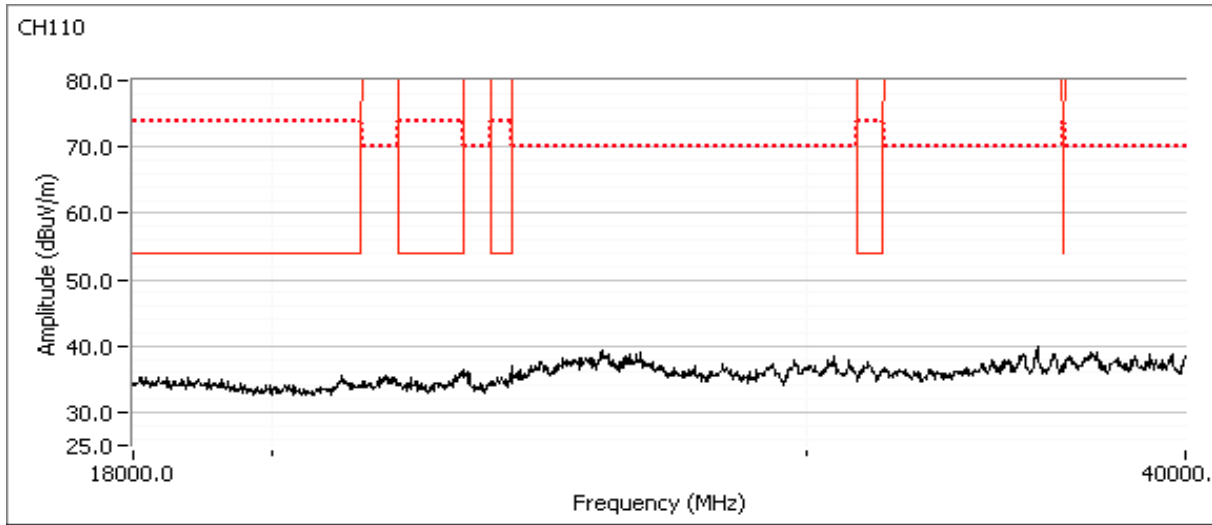



EMC Test Data

Client: Vivint, Inc.	Job Number: J91375
Model: SR1410	T-Log Number: T91470
	Account Manager: Christine Krebill
Contact: Venkat Kalkunte	
Standard: FCC 15.E / FCC 15.B	Class: N/A

Run #2c: High Channel - 134 @ 5670MHz

Spurious Radiated Emissions:

Frequency MHz	Level dB μ V/m	Pol v/h	15.209 / 15E		Detector Pk/QP/Avg	Azimuth degrees	Height meters	Comments
			Limit	Margin				
125.008	41.0	H	43.5	-2.5	QP	124	2.4	
30.588	40.7	V	68.3	-27.6	QP	350	1.0	
103.949	35.7	V	68.3	-32.6	QP	283	1.0	
600.013	46.2	H	68.3	-22.1	QP	172	1.1	
625.007	45.0	H	68.3	-23.3	QP	166	1.0	
960.003	42.4	H	54.0	-11.6	QP	188	1.1	
575.012	45.6	H	68.3	-22.7	QP	163	1.2	
200.011	42.8	H	68.3	-25.5	QP	161	1.2	
280.006	39.6	V	46.0	-6.4	QP	73	1.5	
799.998	44.8	V	68.3	-23.5	QP	7	1.1	
7560.080	50.5	V	54.0	-3.5	AVG	357	1.73	
7560.100	54.6	V	74.0	-19.4	PK	357	1.73	
3780.050	41.8	V	54.0	-12.2	AVG	16	1.00	
3780.030	48.6	V	74.0	-25.4	PK	16	1.00	
5000.130	44.0	V	54.0	-10.0	AVG	14	1.00	
5000.200	52.9	V	74.0	-21.1	PK	14	1.00	
4483.330	44.2	V	68.3	-24.1	Peak	223	1.50	
4641.670	45.5	V	54.0	-8.5	Peak	223	1.50	Refer to DTS results

Note 1: For emissions in restricted bands, the limit of 15.209 was used which requires average and peak measurements.

Note 2: For emissions outside of the restricted bands the limit is -27dBm/MHz eirp (68.3dBuV/m). The measurement method required is a peak measurement (RB=1MHz, VB≥3MHz, peak detector).

Client: Vivint, Inc.	Job Number: J91375
Model: SR1410	T-Log Number: T91470
Contact: Venkat Kalkunte	Account Manager: Christine Krebill
Standard: FCC 15.E / FCC 15.B	Class: N/A

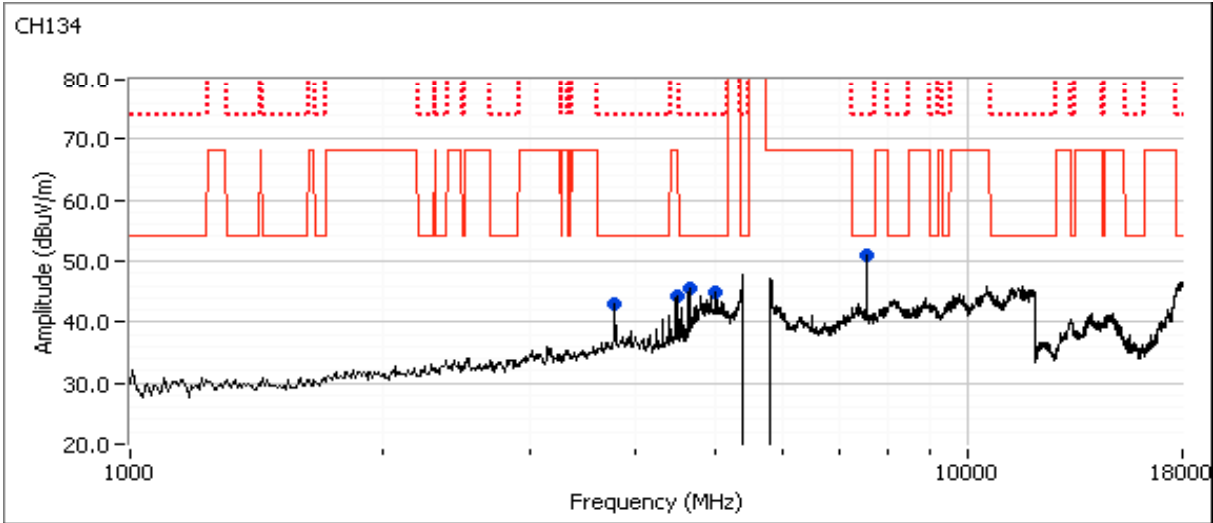
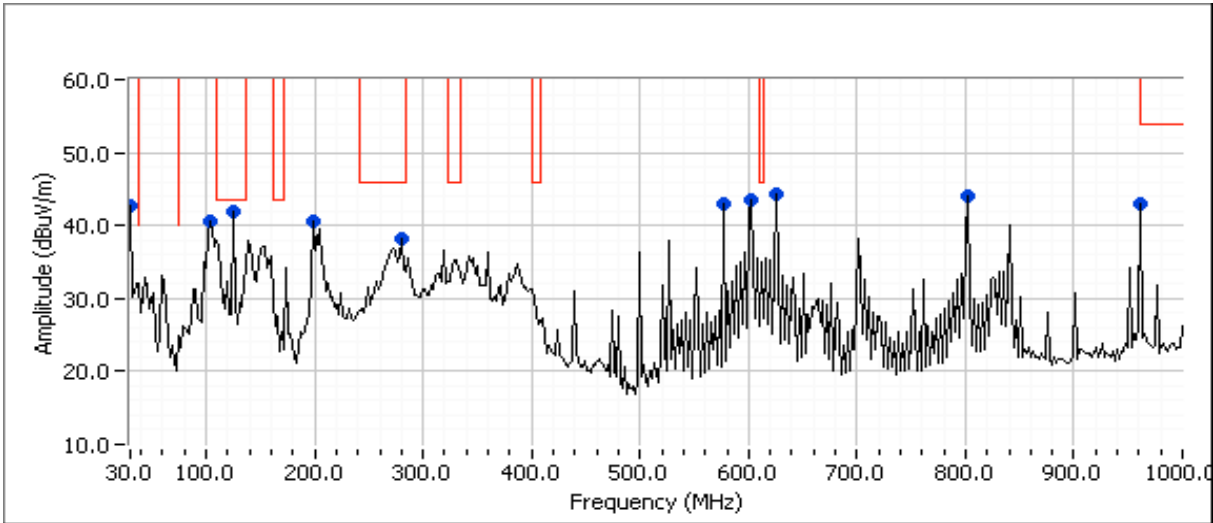

Client: Vivint, Inc.	Job Number: J91375
Model: SR1410	T-Log Number: T91470
Contact: Venkat Kalkunte	Account Manager: Christine Krebill
Standard: FCC 15.E / FCC 15.B	Class: N/A

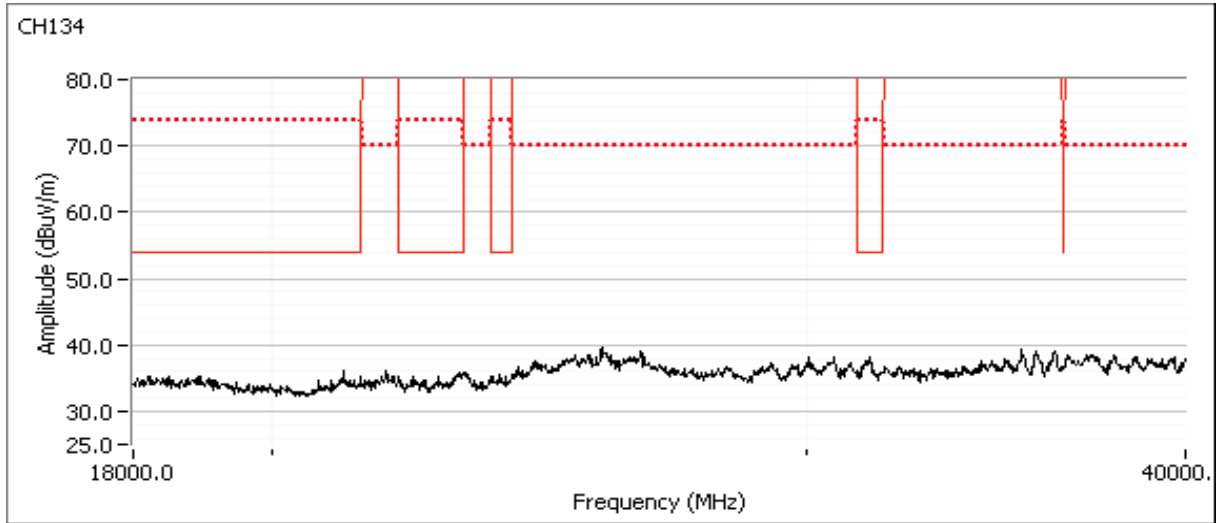

Client: Vivint, Inc.	Job Number: J91375
Model: SR1410	T-Log Number: T91470
	Account Manager: Christine Krebill
Contact: Venkat Kalkunte	
Standard: FCC 15.E / FCC 15.B	Class: N/A

RSS-210 (LELAN) and FCC 15.407(UNII)
Antenna Port Measurements
 Power, PSD, Peak Excursion, Bandwidth and Spurious Emissions

Test Specific Details

Objective: The objective of this test session is to perform final qualification testing of the EUT with respect to the specification listed above.

Summary of Results

Run #	Test Performed	Limit	Pass / Fail	Result / Margin
1	Power, 5250 - 5350MHz	15.407(a) (1), (2)	Pass	n40: 85.8 mW
1	PSD, 5250 - 5350MHz	15.407(a) (1), (2)	Pass	n40: 3.7 dBm/MHz
1	Max EIRP 5250 - 5350MHz	TPC required if EIRP ≥ 500mW (27dBm). EIRP ≥ 200mW (23dBm) DFS threshold = -64dBm.	Pass	EIRP = 542.796 mW
1	Power, 5470 - 5725MHz	15.407(a) (1), (2)	Pass	n40: 98.3 mW
1	PSD, 5470 - 5725MHz	15.407(a) (1), (2)	Pass	n40: 4.8 dBm/MHz
1	Max EIRP 5470 - 5725MHz	TPC required if EIRP ≥ 500mW (27dBm). EIRP ≥ 200mW (23dBm) DFS threshold = -64dBm.	Pass	EIRP = 621 mW
1	26dB Bandwidth	15.407 (Information only)	-	> 20MHz for all modes
1	99% Bandwidth	RSS 210 (Information only)	N/A	n40: 36.4 MHz
2	Peak Excursion Envelope	15.407(a) (6) 13dB	Pass	9.0 dB (-4.0 dB)
3	Antenna Conducted - Out of Band Spurious	15.407(b) -27dBm/MHz	Pass	All emissions below the -27dBm/MHz limit

Client: Vivint, Inc.	Job Number: J91375
Model: SR1410	T-Log Number: T91470
	Account Manager: Christine Krebill
Contact: Venkat Kalkunte	
Standard: FCC 15.E / FCC 15.B	Class: N/A

General Test Configuration

When measuring the conducted emissions from the EUT's antenna port, the antenna port of the EUT was connected to the spectrum analyzer or power meter via a suitable attenuator to prevent overloading the measurement system. All measurements are corrected to allow for the external attenuators and cables used.

Ambient Conditions:

Temperature: 21 °C
 Rel. Humidity: 38 %

Modifications Made During Testing

No modifications were made to the EUT during testing

Deviations From The Standard

No deviations were made from the requirements of the standard.



EMC Test Data

Client: Vivint, Inc.	Job Number: J91375
Model: SR1410	T-Log Number: T91470
Contact: Venkat Kalkunte	Account Manager: Christine Krebill
Standard: FCC 15.E / FCC 15.B	Class: N/A

Run #1: Bandwidth, Output Power and Power Spectral Density - MIMO Systems

Date of Test: 3/27/2013 Config. Used: 1
 Test Engineer: John Caizzi Config Change: none
 Test Location: Chamber 7 EUT Voltage: PoE

Note:	Output power and PSD limits includes correction for antenna gains greater than 6dBi, if applicable.
Note 1:	Output power measured using a spectrum analyzer (see plots below). RBW=1MHz, VB=3 MHz, # of points in sweep $\geq 2 \cdot \text{span}/\text{RBW}$, sample detector, power averaging on (transmitted signal was not continuous but the analyzer was configured with a gated sweep such that the analyzer was only sweeping when the device was transmitting) and power integration over 50 MHz (method SA-1 of KDB 789033).
Note 2:	Measured using the same analyzer settings used for output power.
Note 4:	99% Bandwidth measured in accordance with RSS GEN - RB > 1% of span and VB $\geq 3 \cdot \text{RB}$
Note 5:	For MIMO systems the total output power and total PSD are calculated from the sum of the powers of the individual chains (in linear terms). The antenna gain used to determine the EIRP and limits for PSD/output power depends on the operating mode of the MIMO device. If the signals are non-coherent between the transmit chains, then the gain used to determine the limits is the highest gain of the individual chains and the EIRP is the sum of the products of gain and power on each chain. If the signals are coherent, then the effective antenna gain is the sum (in linear terms) of the gains for each chain and the EIRP is the product of the effective gain and total power.

MIMO Device - 5250-5350 MHz Band

Antenna Gain Information

Freq	Antenna Gain (dBi) / Chain				BF	MultiChain Legacy	CDD	Sectorized / Xpol	Dir G (PWR)	Dir G (PSD)
	1	2	3	4						
5150-5250					Yes	No	Yes	No	-	-
5250-5350	5	5	5	5	Yes	No	Yes	No	8.0	8.0
5470-5725	5	5	5	5	Yes	No	Yes	No	8.0	8.0
5725-5825	5	5	5	5	Yes	No	Yes	No	8.0	8.0

For devices that support CDD modes

Min # of spatial streams: 2 MCS8 is the lowest rate supported
 Max # of spatial streams: 4

Client: Vivint, Inc.	Job Number: J91375
Model: SR1410	T-Log Number: T91470
Contact: Venkat Kalkunte	Account Manager: Christine Krebill
Standard: FCC 15.E / FCC 15.B	Class: N/A

Notes:	BF = beamforming mode supported, Multichain Legacy = 802.11 legacy data rates supported for multichain transmissions, CDD = Cyclic Delay Diversity (or Cyclic Shift Diversity) modes supported, Sectorized / Xpol = antennas are sectorized or cross polarized
Notes:	Dir G (PWR) = total gain (Gant + Array Gain) for power calculations; GA (PSD) = total gain for PSD calculations based on FCC KDB 662911. Depending on the modes supported, the Array Gain value for power could be different from the PSD value.
Notes:	Array gain for power/psd calculated per DKB 662911 D01, v01r02. Spatial Multiplexing with Nant=4, Nss=2, for worse case condition. Array gain = $10 \cdot \log(4/2) = 3\text{dB}$

5250-5350MHz - Power
Mode: 40MHz

Max EIRP (mW): 542.79601

Frequency (MHz)	Chain	Software Setting	26dB BW (MHz)	Duty Cycle %	Power dBm	Total Power ¹ mW	Total Power ¹ dBm	Limit dBm	Max Power (W)	Result
5270	1	Not Supported							0.086	
	3									
	4									
	2									
5310	1	15	43.1	100	13.3	85.8	19.3	22.0	0.086	Pass
	3				13.6					
	4				13.5					
	2				12.9					

5250-5350 PSD

Mode: 40MHz

Frequency (MHz)	Chain	Software Setting	99% BW (MHz)	Duty Cycle %	PSD dBm/MHz	Total PSD ¹ mW/MHz	Total PSD ¹ dBm/MHz	FCC Limit dBm/MHz	IC Limit dBm/MHz	Result
5270	1	Not Supported								
	3									
	4									
	2									
5310	1	15	36.4	100	-2.3	2.3	3.7	9.0	11.0	Pass
	3				-2.0					
	4				-2.2					
	2				-3.0					

Client: Vivint, Inc.	Job Number: J91375
Model: SR1410	T-Log Number: T91470
	Account Manager: Christine Krebill
Contact: Venkat Kalkunte	
Standard: FCC 15.E / FCC 15.B	Class: N/A

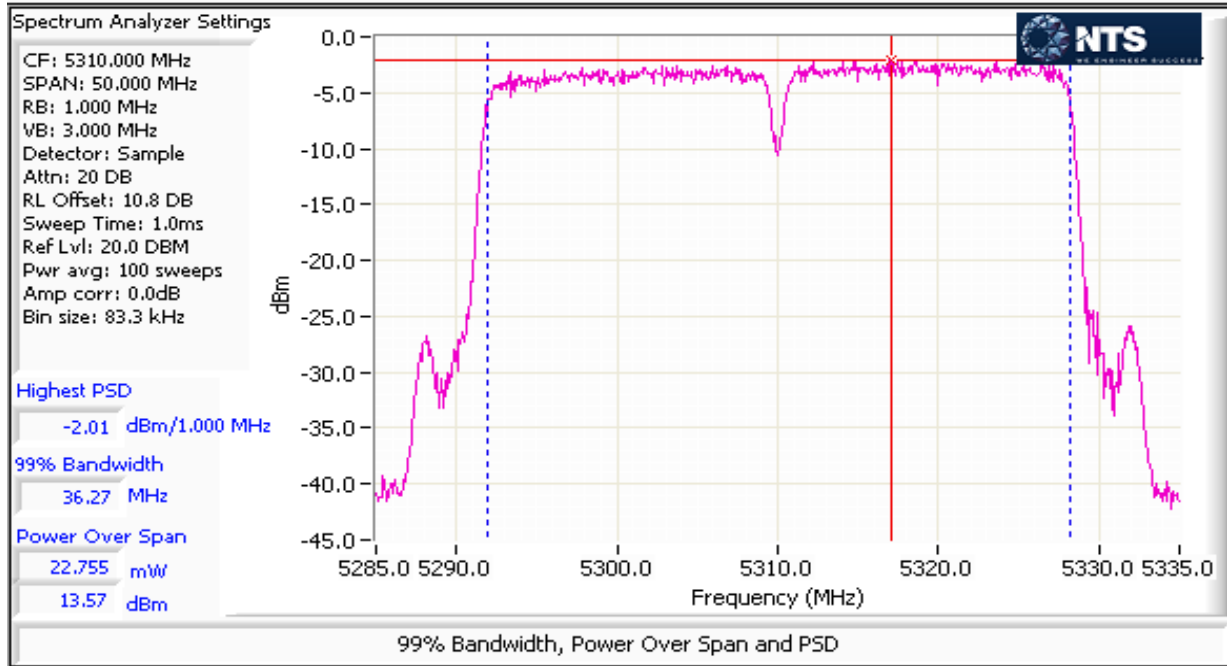
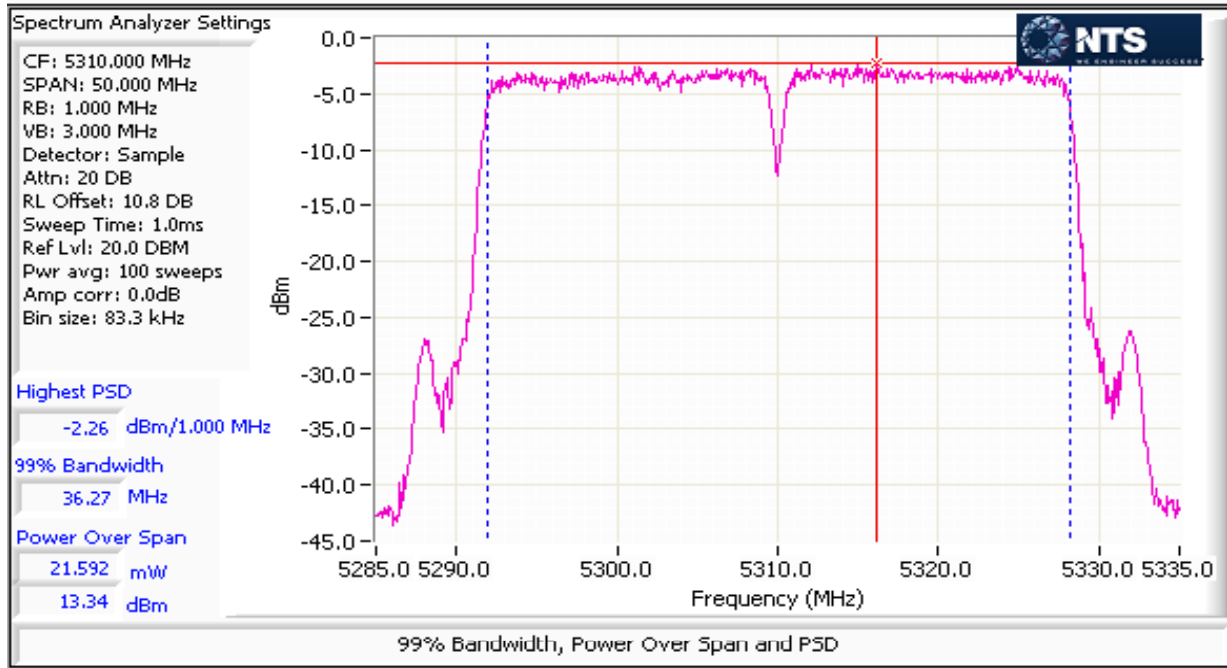

Client: Vivint, Inc.	Job Number: J91375
Model: SR1410	T-Log Number: T91470
	Account Manager: Christine Krebill
Contact: Venkat Kalkunte	
Standard: FCC 15.E / FCC 15.B	Class: N/A

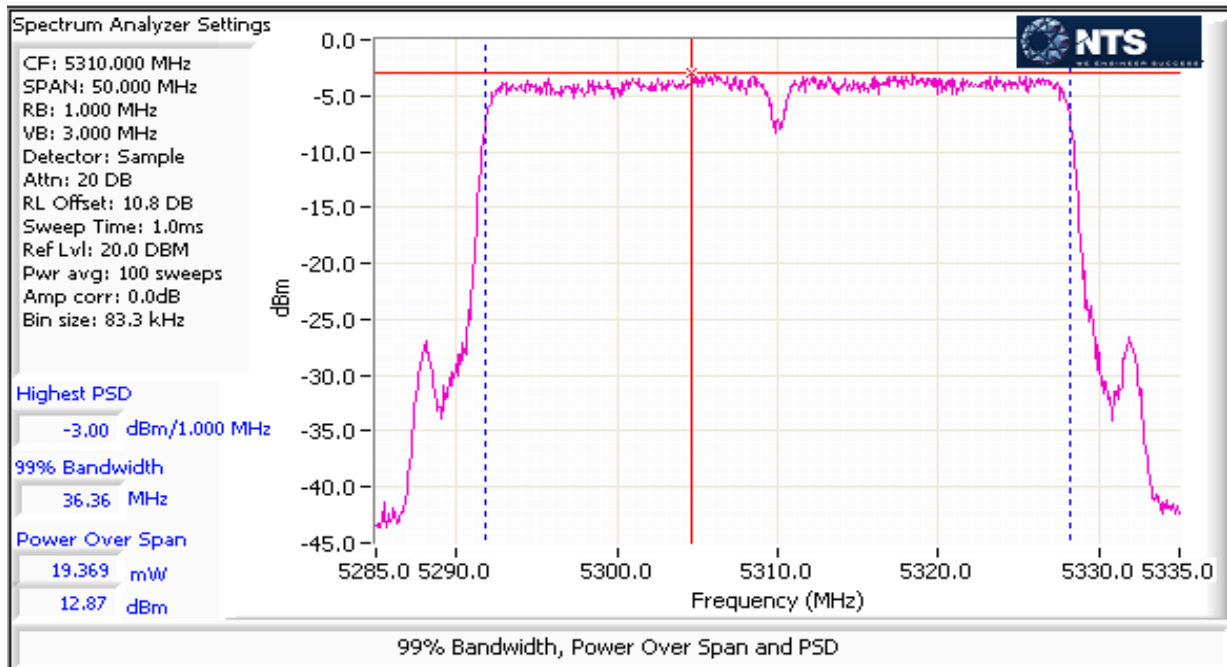
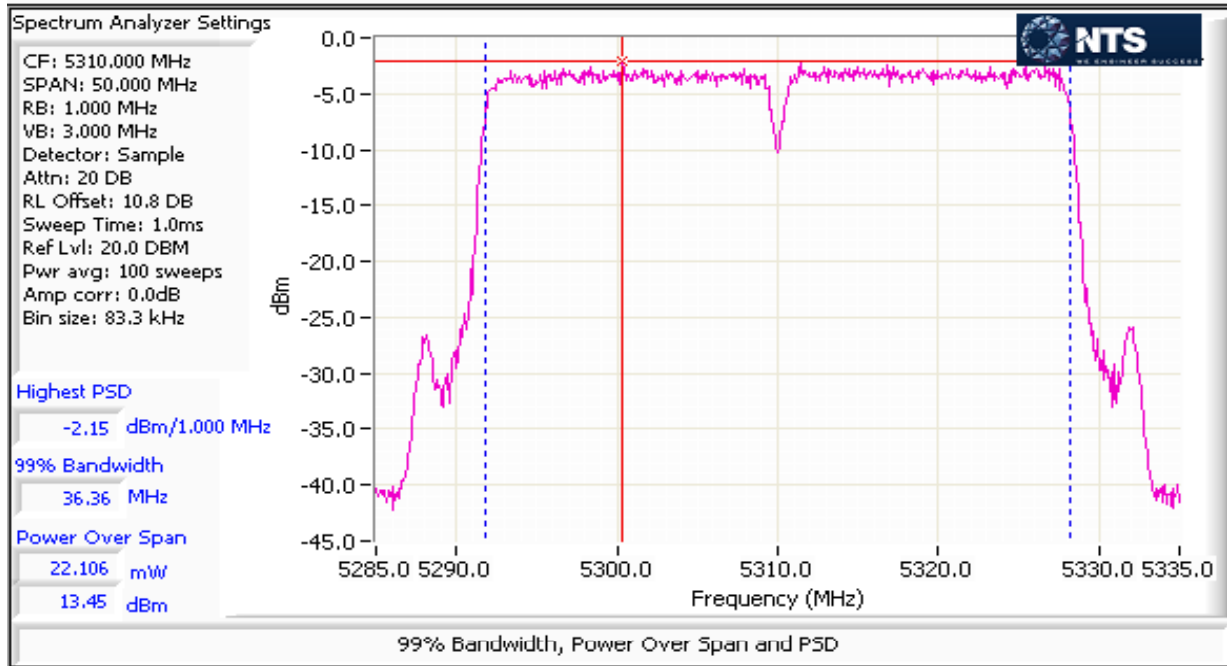

Client: Vivint, Inc.	Job Number: J91375
Model: SR1410	T-Log Number: T91470
	Account Manager: Christine Krebill
Contact: Venkat Kalkunte	
Standard: FCC 15.E / FCC 15.B	Class: N/A

5470-5725MHz - Power
 Mode: 40MHz Max EIRP (mW): 621.4754

Frequency (MHz)	Chain	Software Setting	26dB BW (MHz)	Duty Cycle %	Power dBm	Total Power ¹ mW	Total Power ¹ dBm	Limit dBm	Max Power (W)	Result
5510	1	15	46.7	100.0	12.8	73.6	18.7	22.0	0.098	Pass
	3				12.4					
	4				13.1					
	2				12.3					
5550	1	16	47.3	100.0	13.8	98.3	19.9	22.0		Pass
	3				14.8					
	4				13.1					
	2				13.7					
5670	1	16	46.5	100.0	13.8	95.2	19.8	22.0		Pass
	3				14.3					
	4				13.3					
	2				13.7					

5470-5725 PSD
 Mode: 40MHz

Frequency (MHz)	Chain	Software Setting	99% BW (MHz)	Duty Cycle %	PSD dBm/MHz	Total PSD ¹ mW/MHz	Total PSD ¹ dBm/MHz	FCC Limit dBm/MHz	IC Limit dBm/MHz	Result
5510	1	15	36.4	100	-2.8	2.0	3.0	9.0	11.0	Pass
	3				-3.3					
	4				-2.7					
	2				-3.4					
5550	1	16	36.4	100	-1.5	2.8	4.4	9.0	11.0	Pass
	3				-0.6					
	4				-2.6					
	2				-1.8					
5670	1	16	36.4	100	-1.4	3.0	4.8	9.0	11.0	Pass
	3				-0.8					
	4				-2.4					
	2				-0.6					

Client: Vivint, Inc.	Job Number: J91375
Model: SR1410	T-Log Number: T91470
	Account Manager: Christine Krebill
Contact: Venkat Kalkunte	
Standard: FCC 15.E / FCC 15.B	Class: N/A

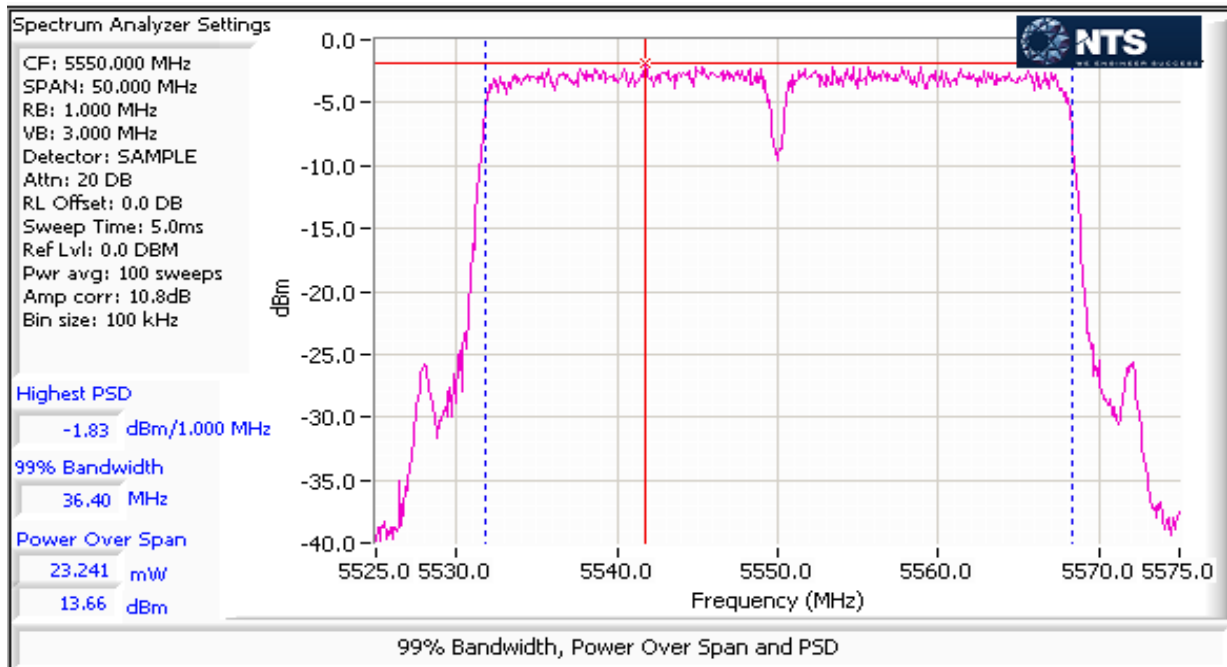
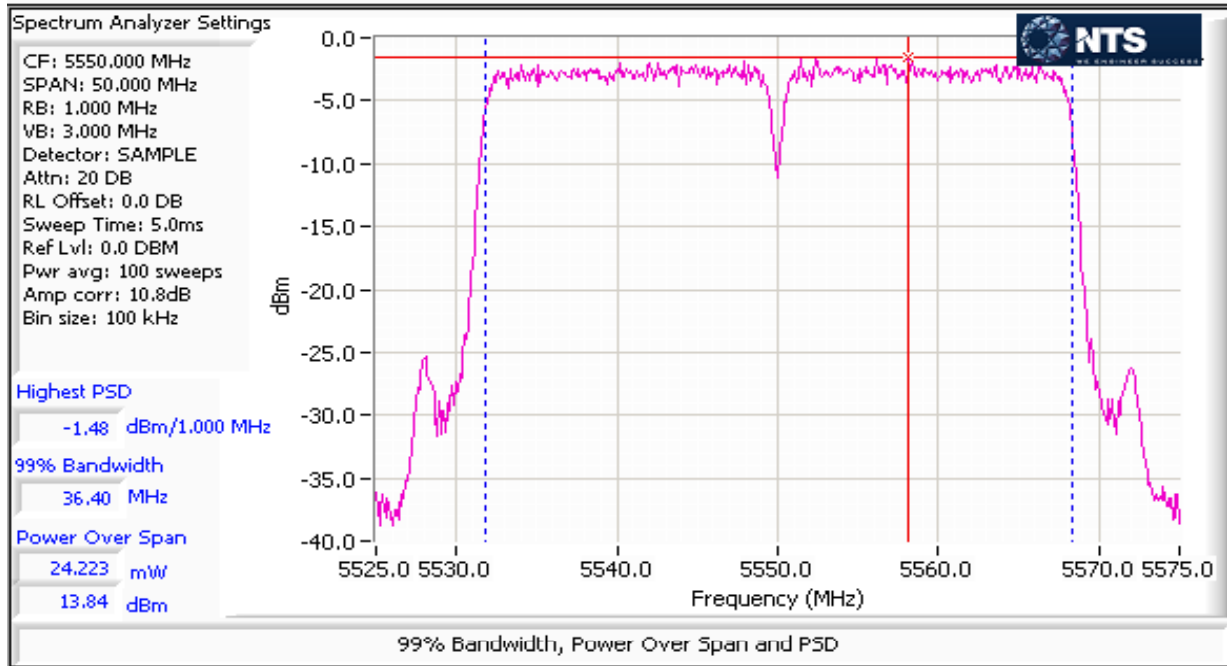

Client: Vivint, Inc.	Job Number: J91375
Model: SR1410	T-Log Number: T91470
Contact: Venkat Kalkunte	Account Manager: Christine Krebill
Standard: FCC 15.E / FCC 15.B	Class: N/A

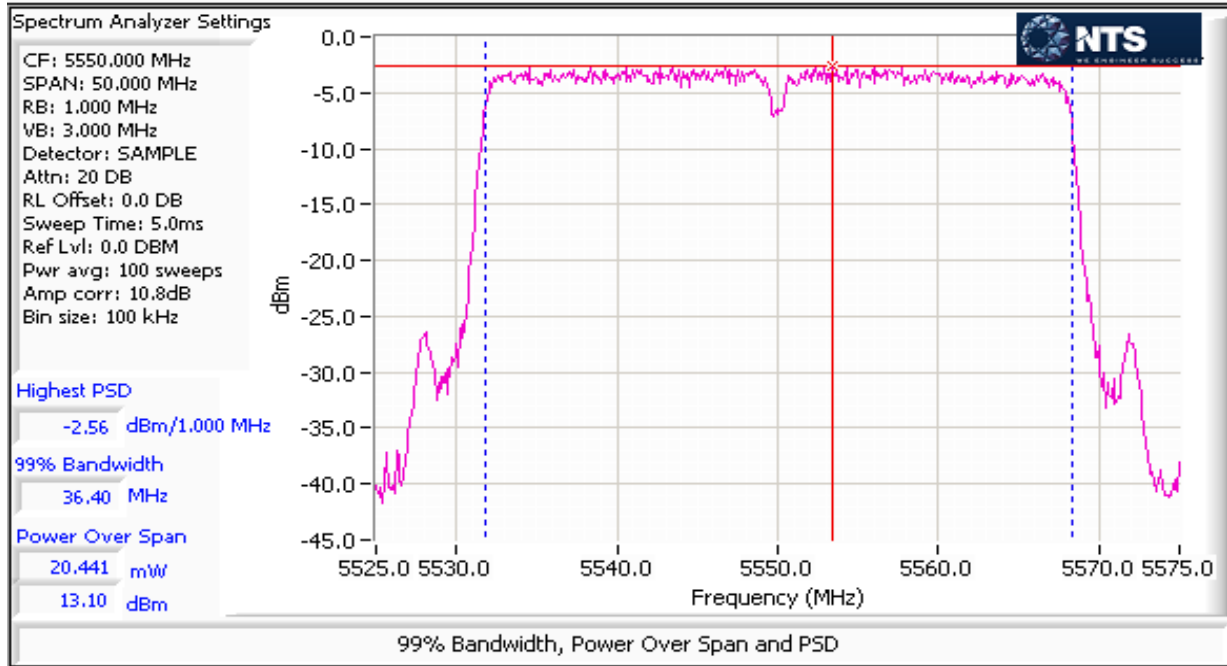
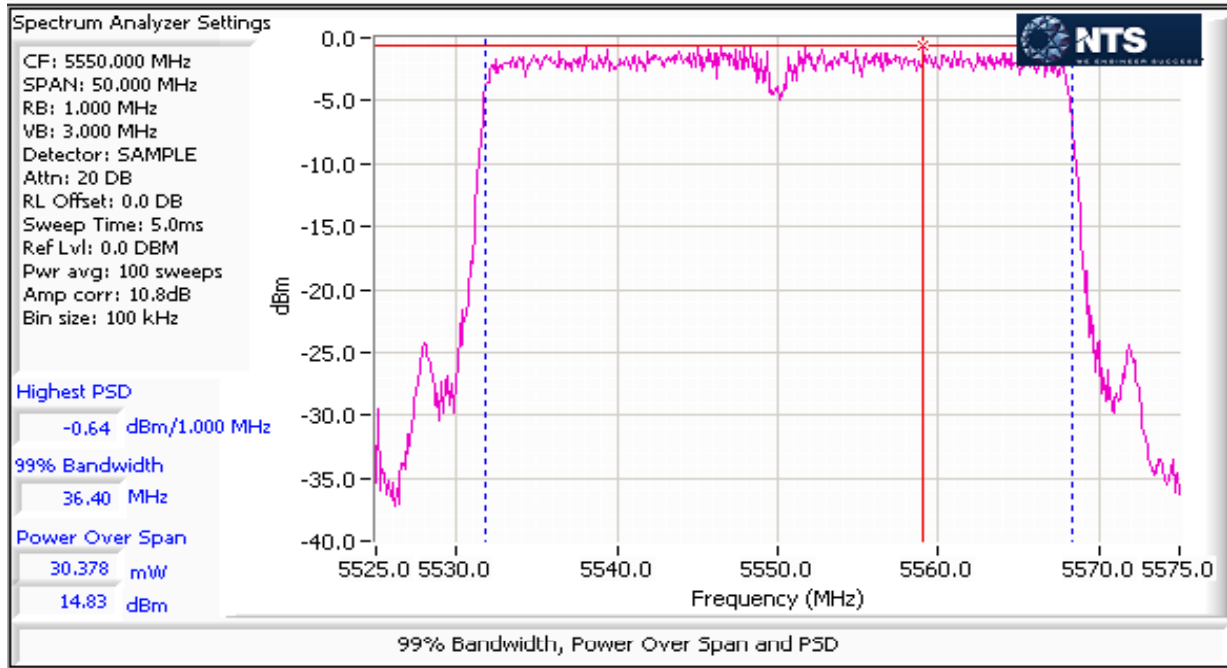

Client: Vivint, Inc.	Job Number: J91375
Model: SR1410	T-Log Number: T91470
	Account Manager: Christine Krebill
Contact: Venkat Kalkunte	
Standard: FCC 15.E / FCC 15.B	Class: N/A

Run #2: Peak Excursion Measurement

40MHz: Device meets the requirement for the peak excursion

Freq		Peak Excursion(dB)		Freq		Peak Excursion(dB)		
(MHz)	Value	Limit	(MHz)	Value	Limit	(MHz)	Value	Limit
						5510	8.9	13.0
			5310	7.4	13.0	5550	9.0	13.0
						5670	8.5	13.0

Client: Vivint, Inc.	Job Number: J91375
Model: SR1410	T-Log Number: T91470
Contact: Venkat Kalkunte	Account Manager: Christine Krebill
Standard: FCC 15.E / FCC 15.B	Class: N/A

Plots Showing Peak Excursion

Trace A: RBW = 1MHz, VBW = 3MHz, Peak hold

Trace B: Same settings as used for power/PSD measurements (RBW = 1 MHz, VBW = 3MHz, Integrated average power)

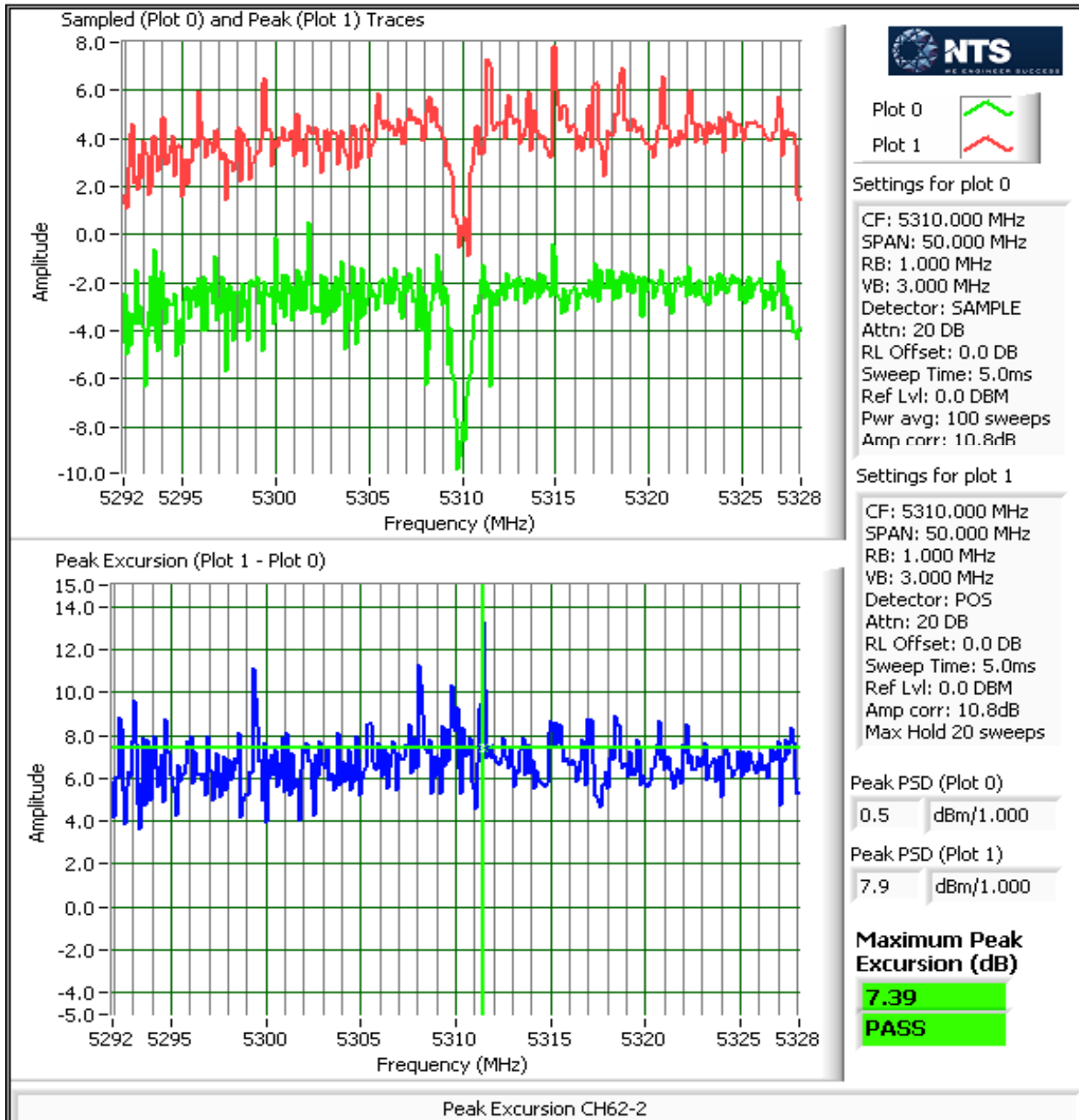

Client: Vivint, Inc.	Job Number: J91375
Model: SR1410	T-Log Number: T91470
Contact: Venkat Kalkunte	Account Manager: Christine Krebill
Standard: FCC 15.E / FCC 15.B	Class: N/A

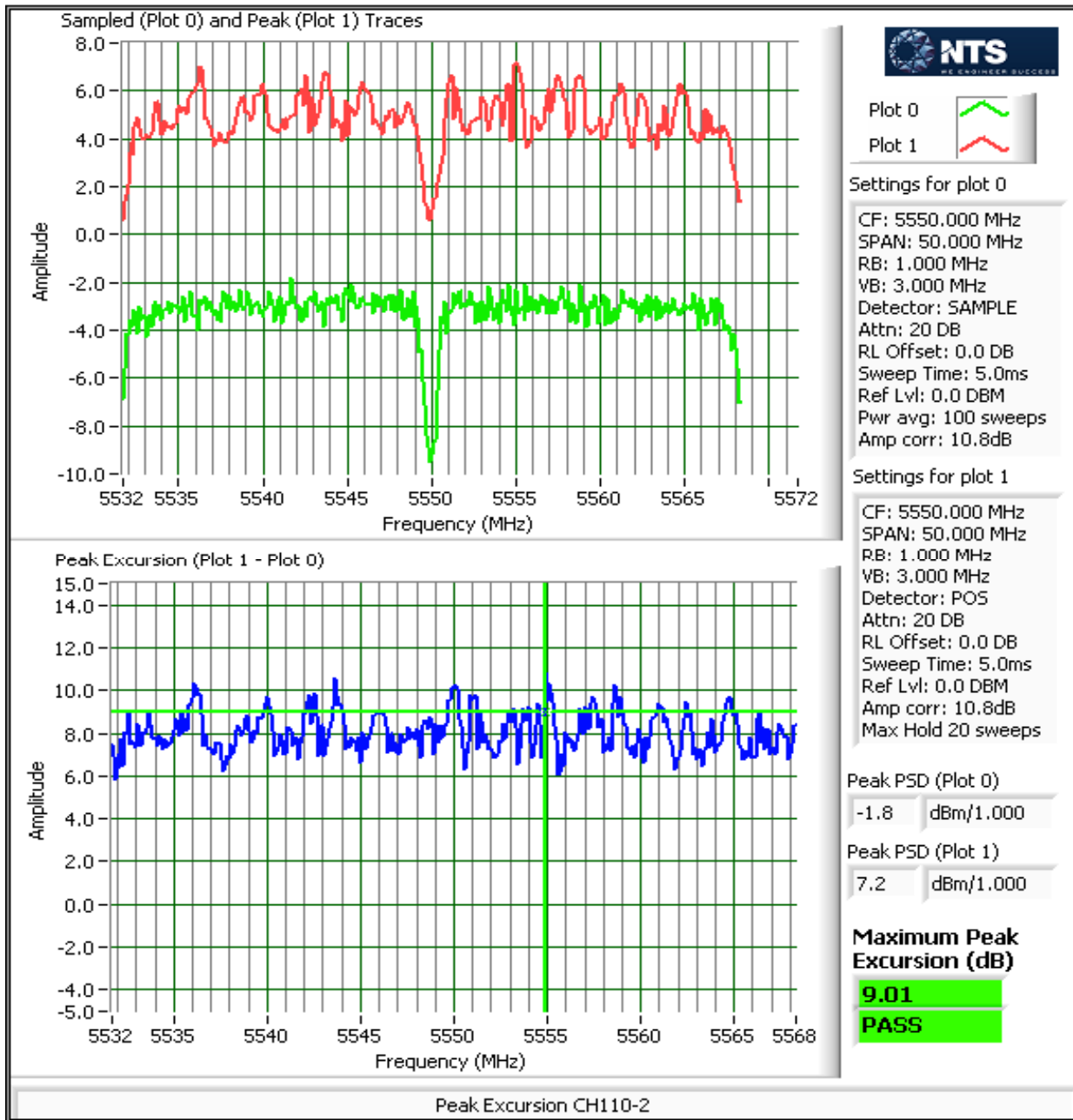

Client: Vivint, Inc.	Job Number: J91375
Model: SR1410	T-Log Number: T91470
	Account Manager: Christine Krebill
Contact: Venkat Kalkunte	
Standard: FCC 15.E / FCC 15.B	Class: N/A

Run #3: Out Of Band Spurious Emissions - Antenna Conducted

MIMO Devices: Antenna gain used is the effective gain calculated in the power section of this data sheet. The plots were obtained for each chain individually and the limit was adjusted to account for all chains transmitting simultaneously

Number of transmit chains: 4
 Maximum Antenna Gain: 8.0 dBi
 Spurious Limit: -27.0 dBm/MHz eirp
 Adjustment for 4 chains: -6.0 dB adjustment for multiple chains.
 Limit Used On Plots ^{Note 1}: -41.0 dBm/MHz Peak Limit (RB=VB=1MHz)

Note 1:	The -27dBm/MHz limit is an eirp limit. The limit for antenna port conducted measurements is adjusted to take into consideration the maximum antenna gain (limit = -27dBm - antenna gain). Radiated field strength measurements for signals more than 50MHz from the bands and that are close to the limit are made to determine compliance as the antenna gain is not known at these frequencies.
Note 2:	All spurious signals below 1GHz are measured during digital device radiated emissions test.
Note 3:	Signals within 10MHz of the 5.725 or 5.825 Band edge are subject to a limit of -17dBm EIRP
Note 4:	If the device is for outdoor use then the -27dBm eirp limit also applies in the 5150 - 5250 MHz band.
Note 5:	Signals that fall in the restricted bands of 15.205 are subject to the limit of 15.209.

Client: Vivint, Inc.	Job Number: J91375
Model: SR1410	T-Log Number: T91470
Contact: Venkat Kalkunte	Account Manager: Christine Krebill
Standard: FCC 15.E / FCC 15.B	Class: N/A

Plots Showing Out-Of-Band Emissions (RBW=VBW=1MHz)

High channel, 5250 - 5350 MHz Band

Note - compliance with the radiated limits for the restricted band immediately above 5350MHz is demonstrated through the radiated emissions tests.

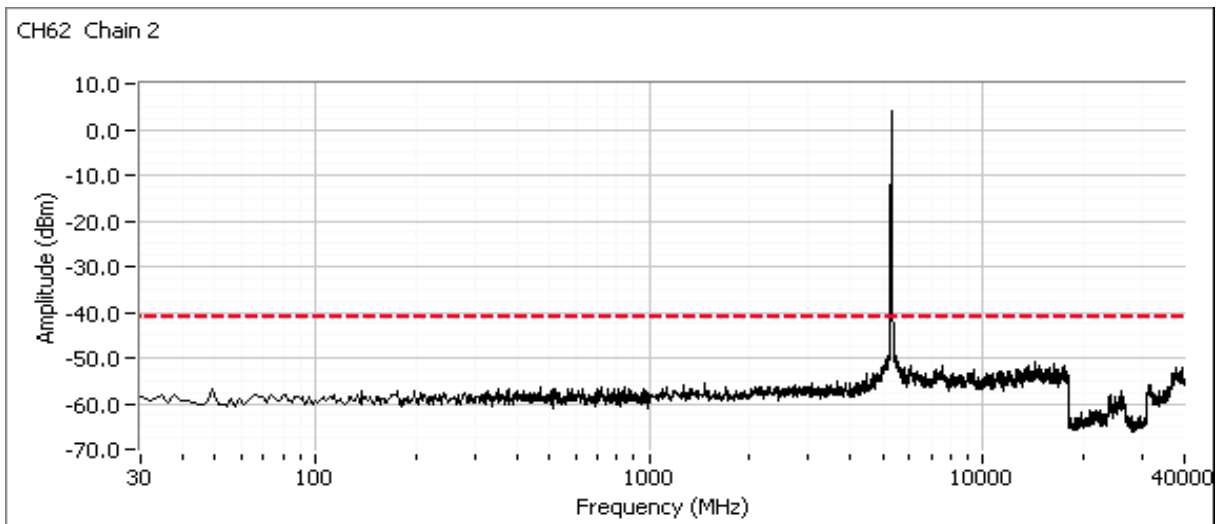
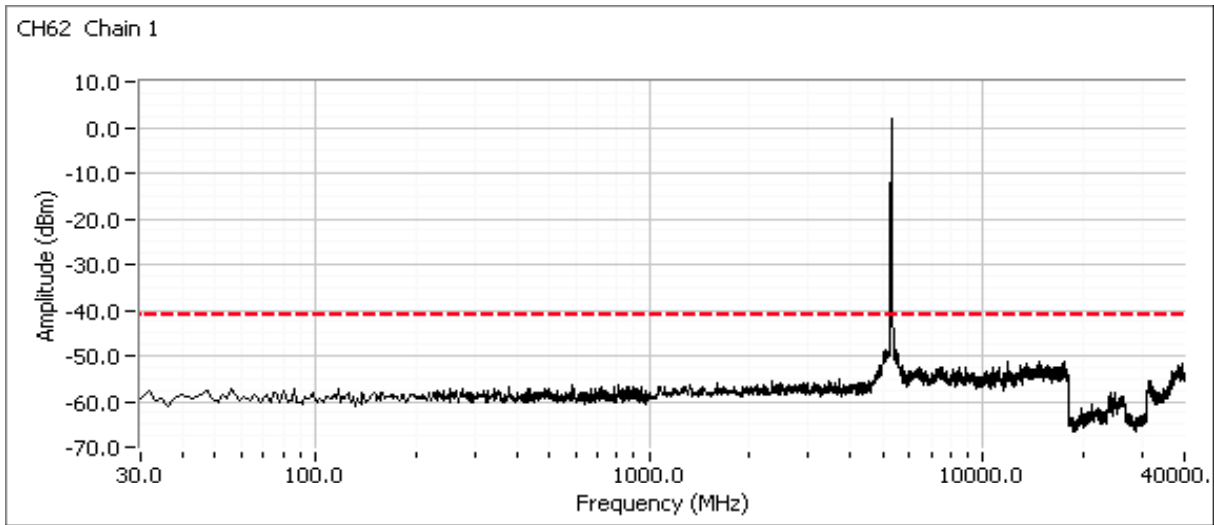

Client: Vivint, Inc.	Job Number: J91375
Model: SR1410	T-Log Number: T91470
	Account Manager: Christine Krebill
Contact: Venkat Kalkunte	
Standard: FCC 15.E / FCC 15.B	Class: N/A

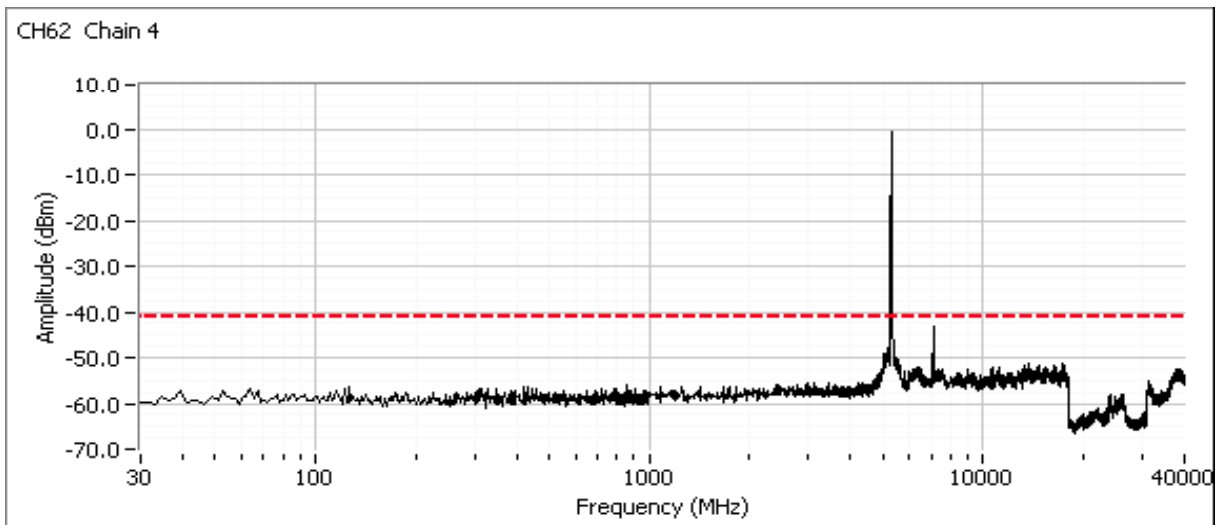
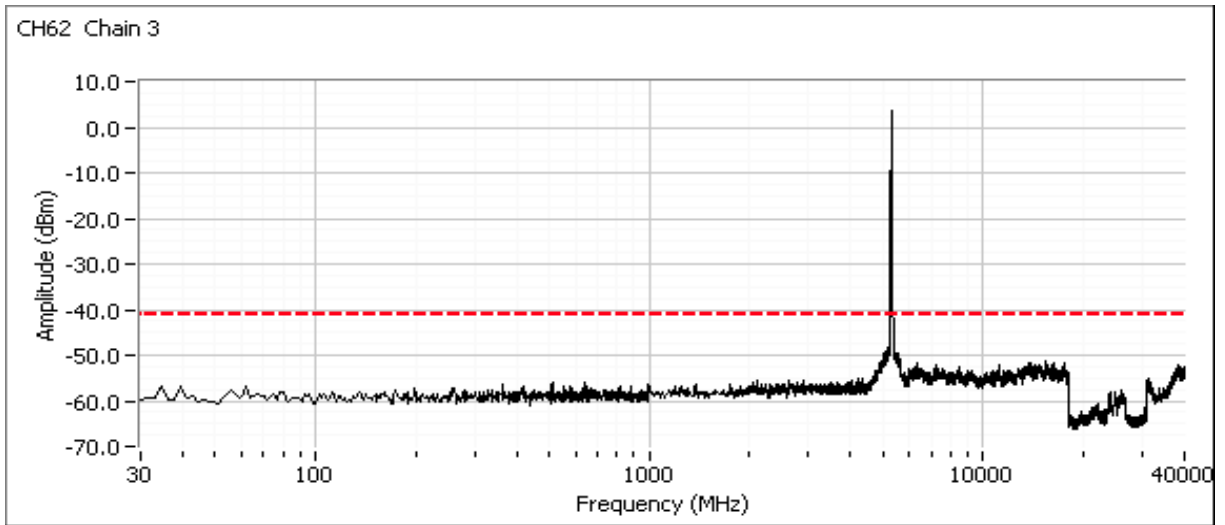

Client: Vivint, Inc.	Job Number: J91375
Model: SR1410	T-Log Number: T91470
Contact: Venkat Kalkunte	Account Manager: Christine Krebill
Standard: FCC 15.E / FCC 15.B	Class: N/A

Low channel, 5470 - 5725 MHz Band

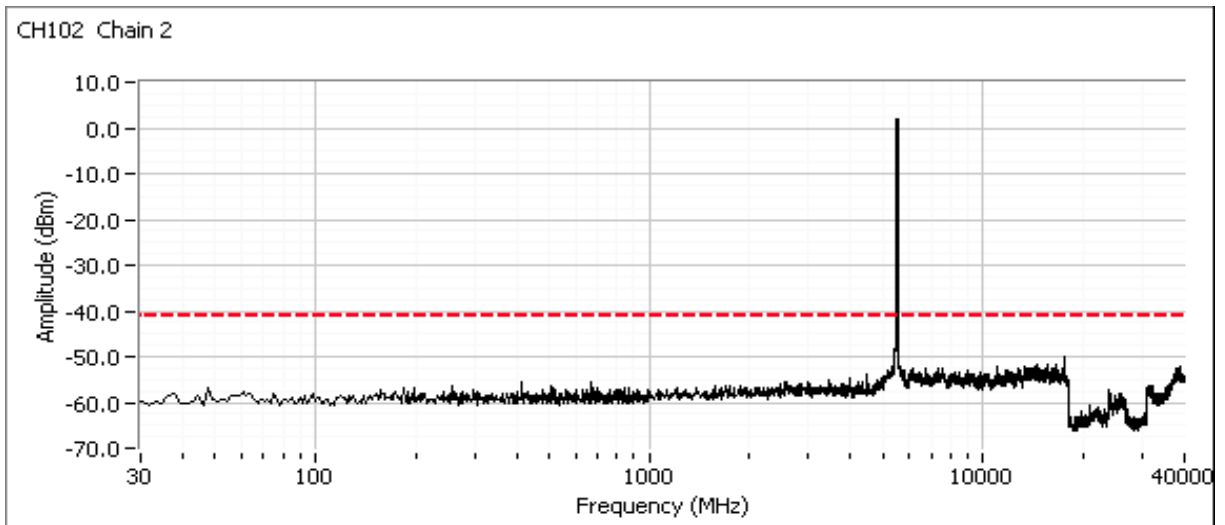
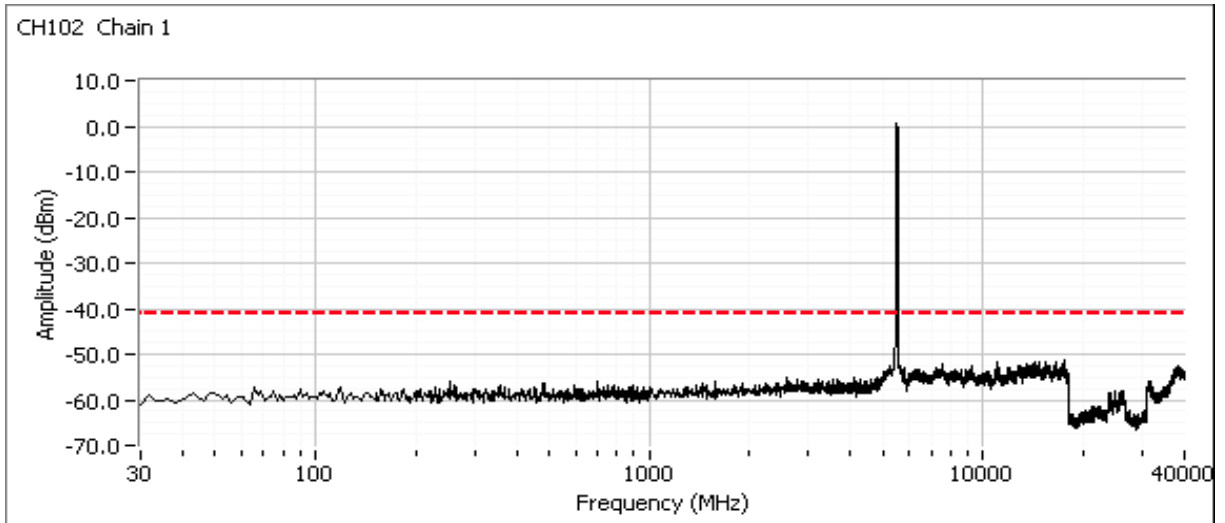

Client: Vivint, Inc.	Job Number: J91375
Model: SR1410	T-Log Number: T91470
	Account Manager: Christine Krebill
Contact: Venkat Kalkunte	
Standard: FCC 15.E / FCC 15.B	Class: N/A

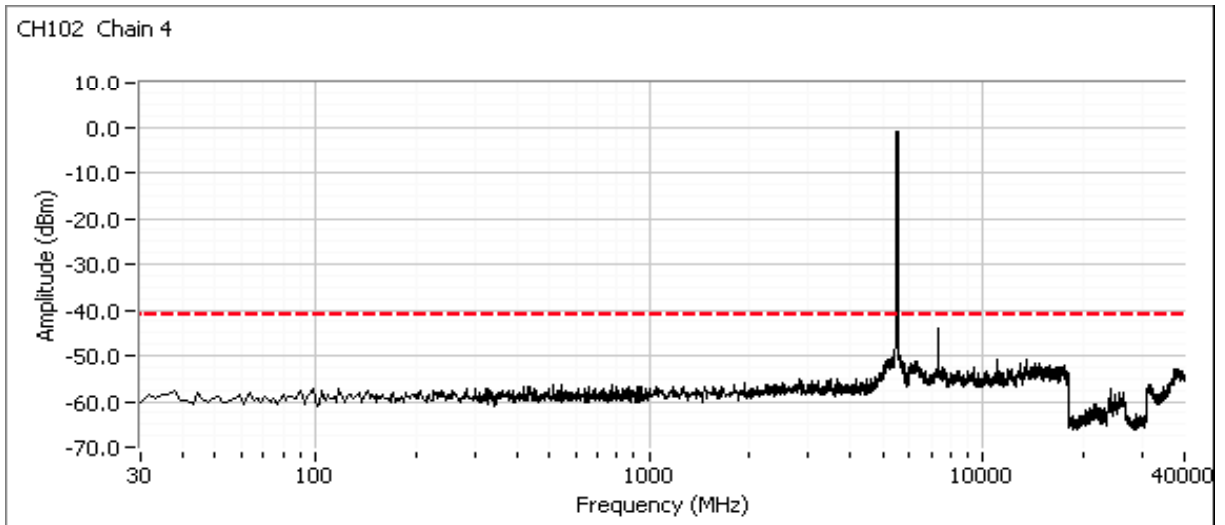
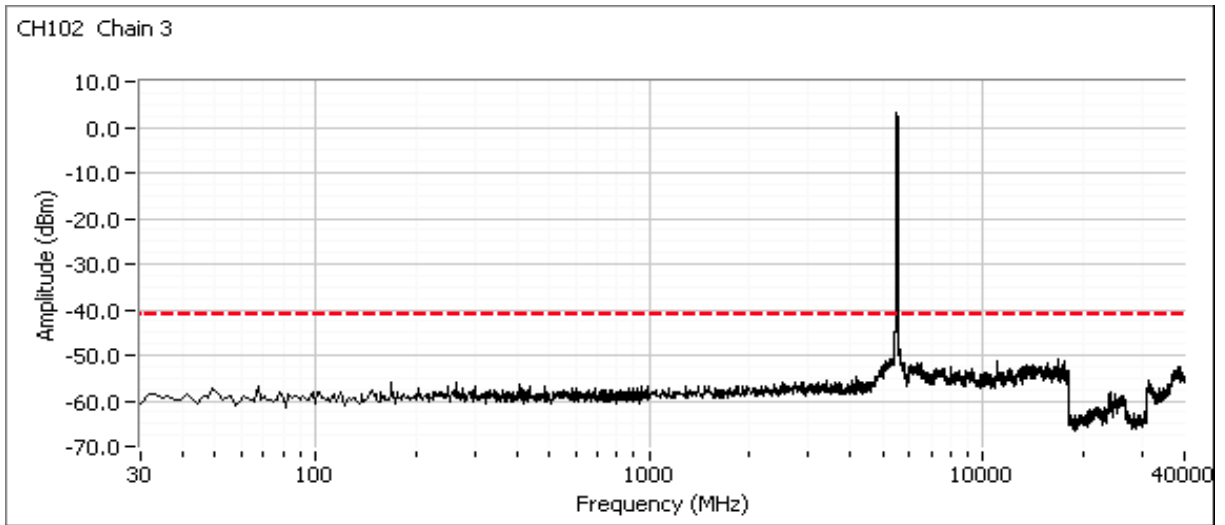

Client: Vivint, Inc.	Job Number: J91375
Model: SR1410	T-Log Number: T91470
	Account Manager: Christine Krebill
Contact: Venkat Kalkunte	
Standard: FCC 15.E / FCC 15.B	Class: N/A

Center channel, 5470 - 5725 MHz Band

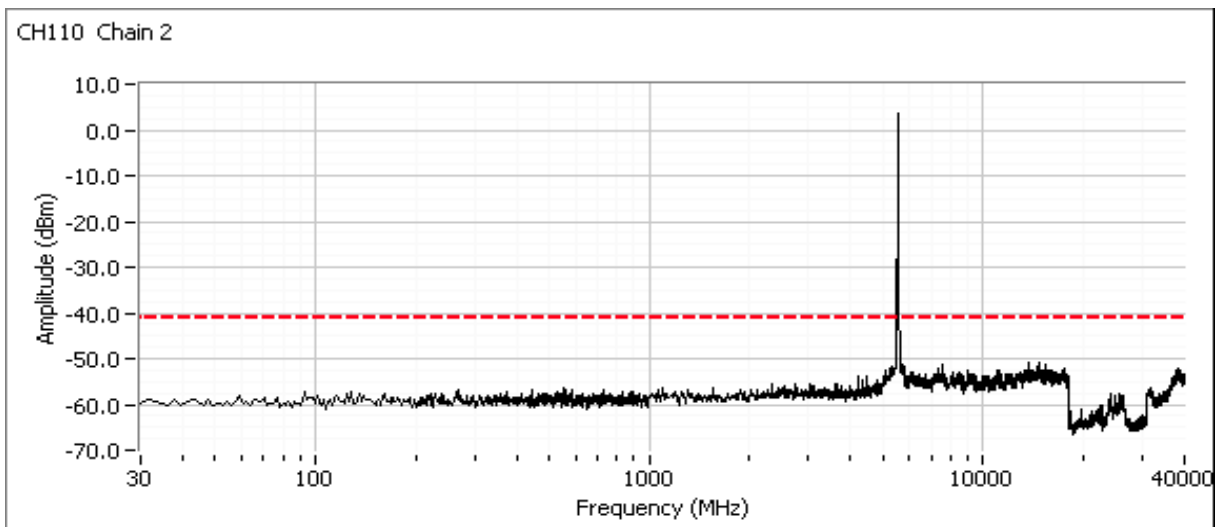
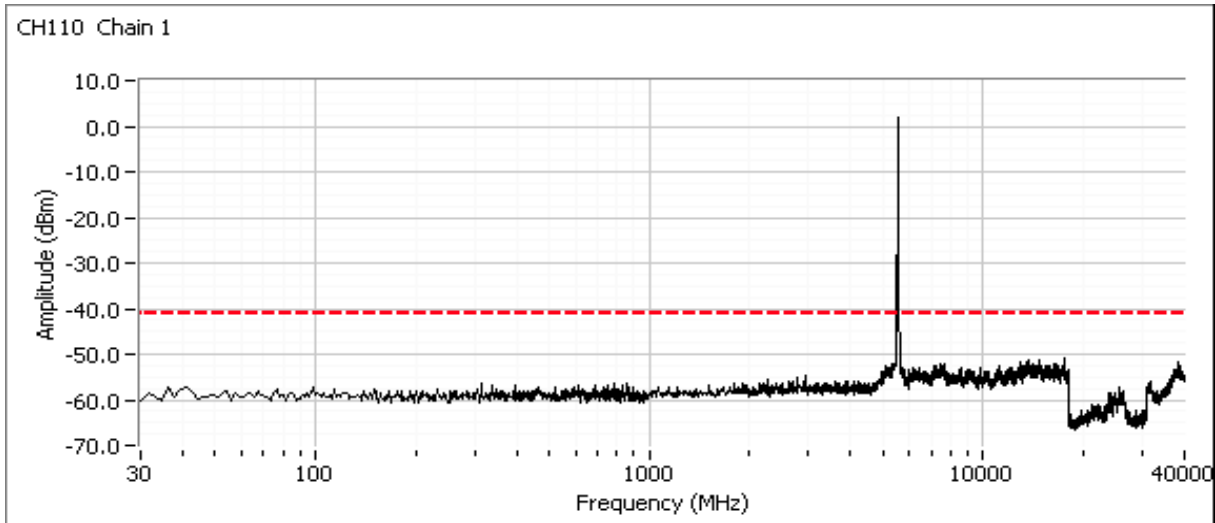

Client: Vivint, Inc.	Job Number: J91375
Model: SR1410	T-Log Number: T91470
	Account Manager: Christine Krebill
Contact: Venkat Kalkunte	
Standard: FCC 15.E / FCC 15.B	Class: N/A

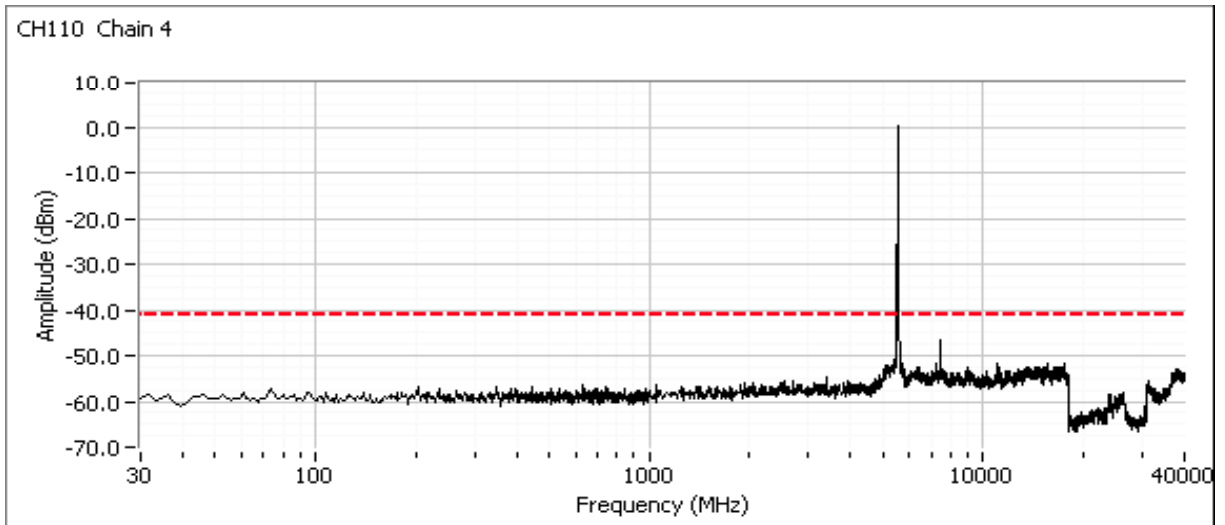
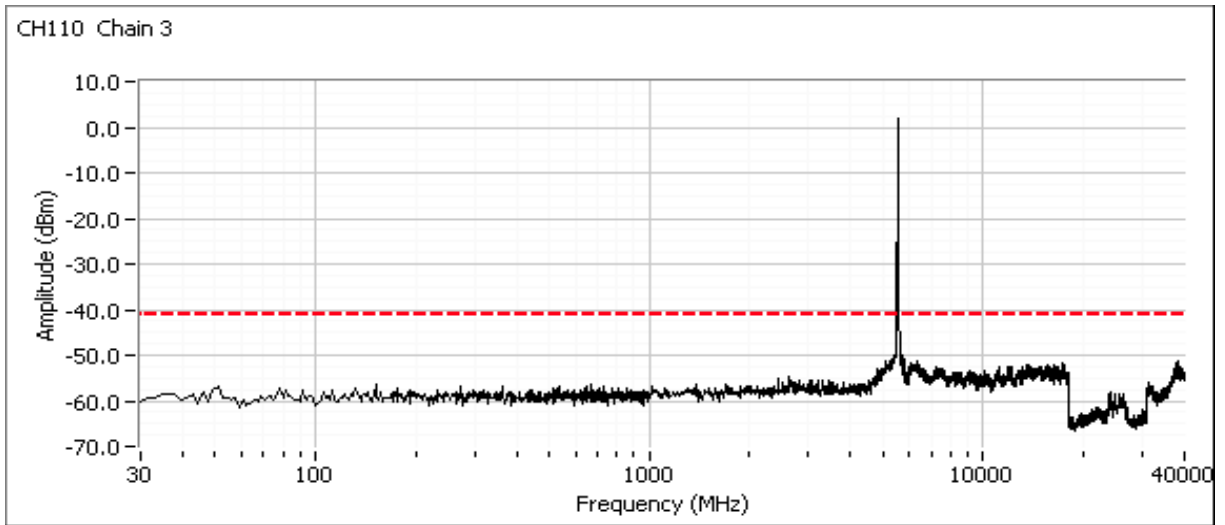

Client: Vivint, Inc.	Job Number: J91375
Model: SR1410	T-Log Number: T91470
	Account Manager: Christine Krebill
Contact: Venkat Kalkunte	
Standard: FCC 15.E / FCC 15.B	Class: N/A

High channel, 5470 - 5725 MHz Band

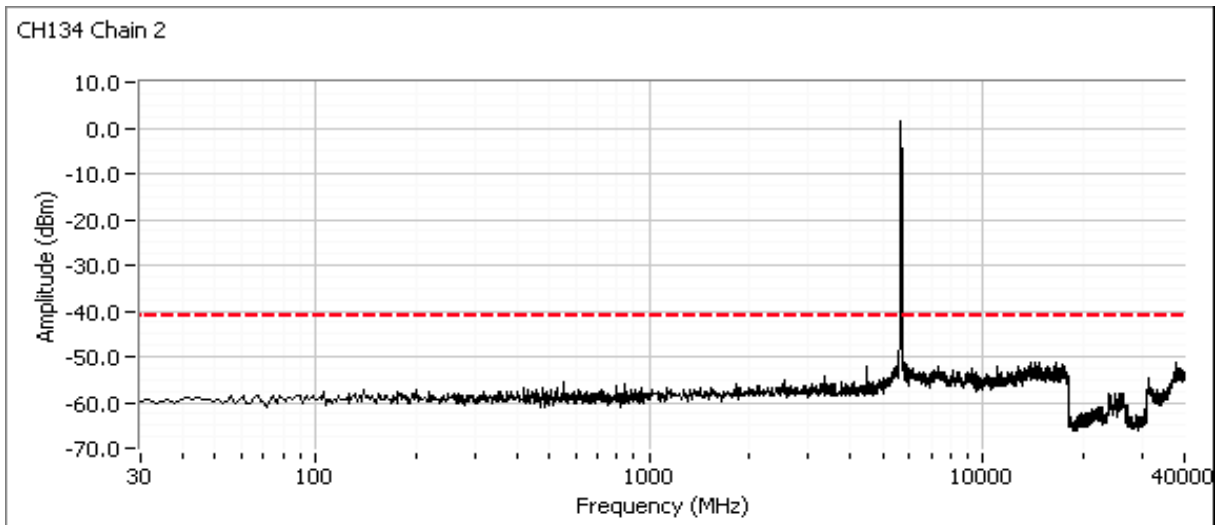
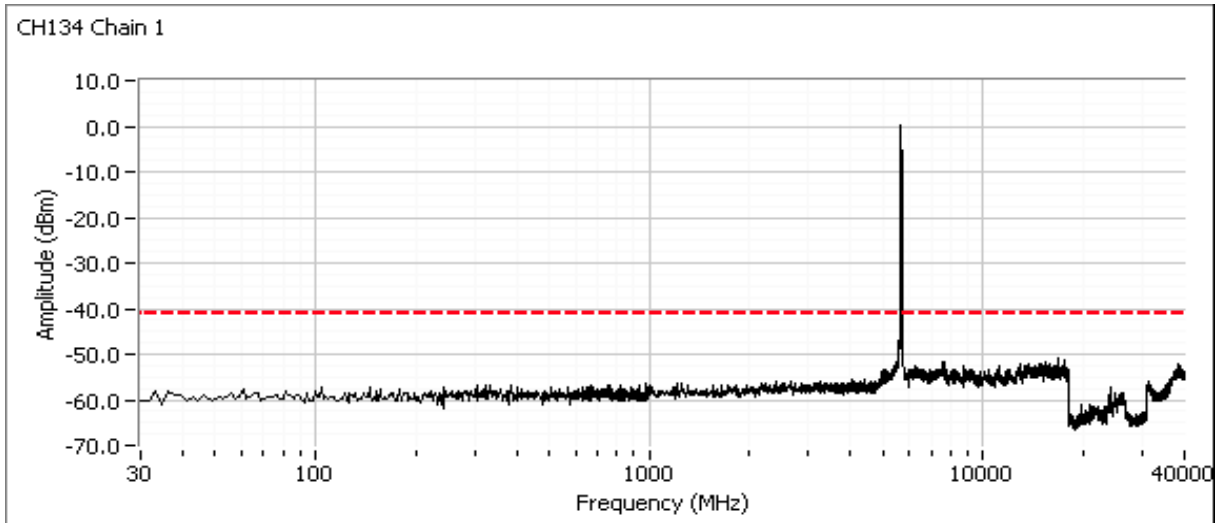

Client: Vivint, Inc.	Job Number: J91375
Model: SR1410	T-Log Number: T91470
	Account Manager: Christine Krebill
Contact: Venkat Kalkunte	
Standard: FCC 15.E / FCC 15.B	Class: N/A

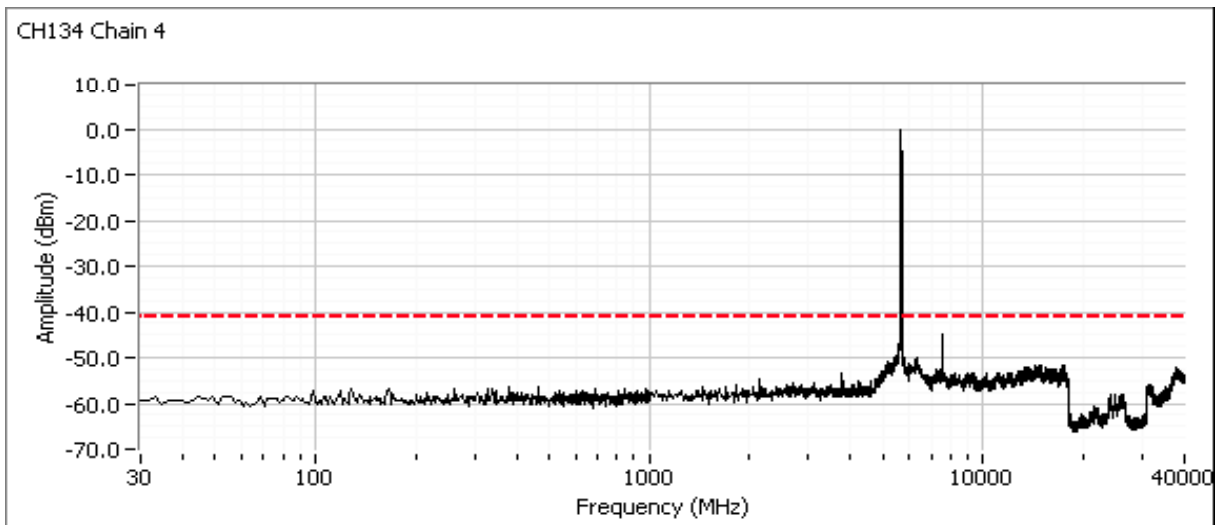
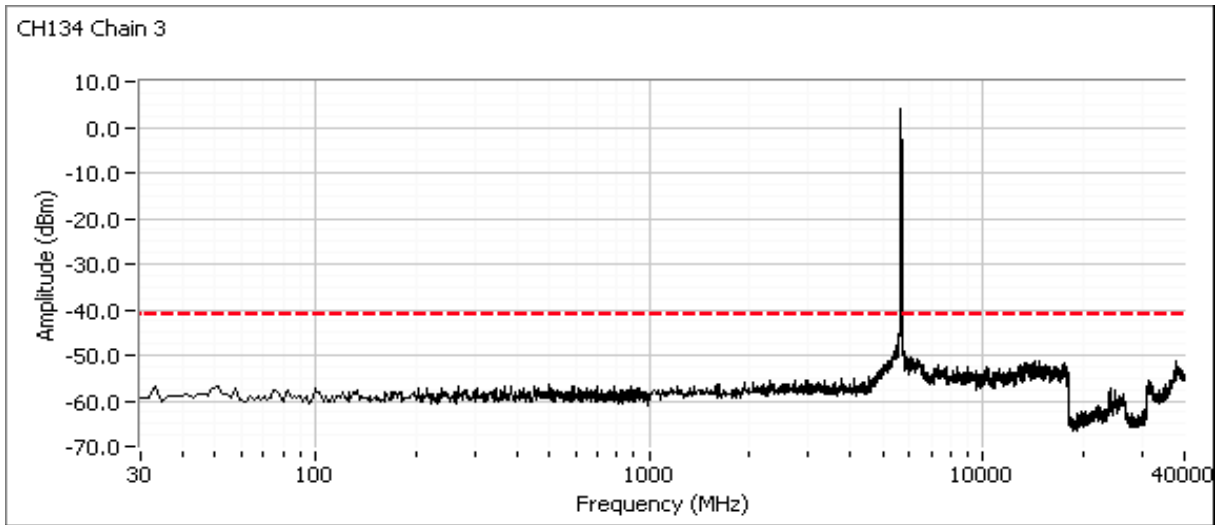



EMC Test Data

Client:	Vivint, Inc.	Job Number:	J91375
Model:	SR1410	T-Log Number:	T91470
Contact:	Venkat Kalkunte	Account Manager:	Christine Krebill
Standard:	FCC 15.E / FCC 15.B	Class:	A

Radiated Emissions

(Elliott Laboratories Fremont Facility, Semi-Anechoic Chamber)

Test Specific Details

Objective: The objective of this test session is to perform final qualification testing of the EUT with respect to the specification listed above.

Date of Test: 3/28/2013
 Test Engineer: John Caizzi
 Test Location: Fremont Chamber #7

Config. Used: 1
 Config Change: none
 EUT Voltage: PoE

General Test Configuration

The EUT was located on the turntable for radiated emissions testing. Any remote support equipment was located outside the semi-anechoic chamber. Any cables running to remote support equipment were routed through metal conduit and passed through a ferrite clamp upon exiting the chamber.

The test distance and extrapolation factor (if applicable) are detailed under each run description.

Note, preliminary testing indicates that the emissions were maximized by orientation of the EUT and elevation of the measurement antenna. Maximized testing indicated that the emissions were maximized by orientation of the EUT, elevation of the measurement antenna, and manipulation of the EUT's interface cables.

Ambient Conditions:

Temperature: 21 °C
 Rel. Humidity: 43 %

Summary of Results (ANSI C63.4:2009)

Run #	Test Performed	Limit	Result	Margin
1	Radiated Emissions 30 - 1000 MHz, Preliminary	Class A	Eval	33.4 dBµV/m @ 60.23 MHz (-5.7 dB)
2	Radiated Emissions 30 - 1000 MHz, Maximized	Class A	Pass	33.4 dBµV/m @ 60.23 MHz (-5.7 dB)

Modifications Made During Testing

No modifications were made to the EUT during testing

Deviations From The Standard

No deviations were made from the requirements of the standard.



EMC Test Data

Client: Vivint, Inc.	Job Number: J91375
Model: SR1410	T-Log Number: T91470
Contact: Venkat Kalkunte	Account Manager: Christine Krebill
Standard: FCC 15.E / FCC 15.B	Class: A

Run #1: Preliminary Radiated Emissions, 30 - 1000 MHz. EUT transmitting on channel 102 at power setting 16.

Test Parameters for Preliminary Scan(s)			
Frequency Range (MHz)	Prescan Distance (meters)	Limit Distance (meters)	Extrapolation Factor (dB, applied to data)
30 - 1000	5	10	-6.0

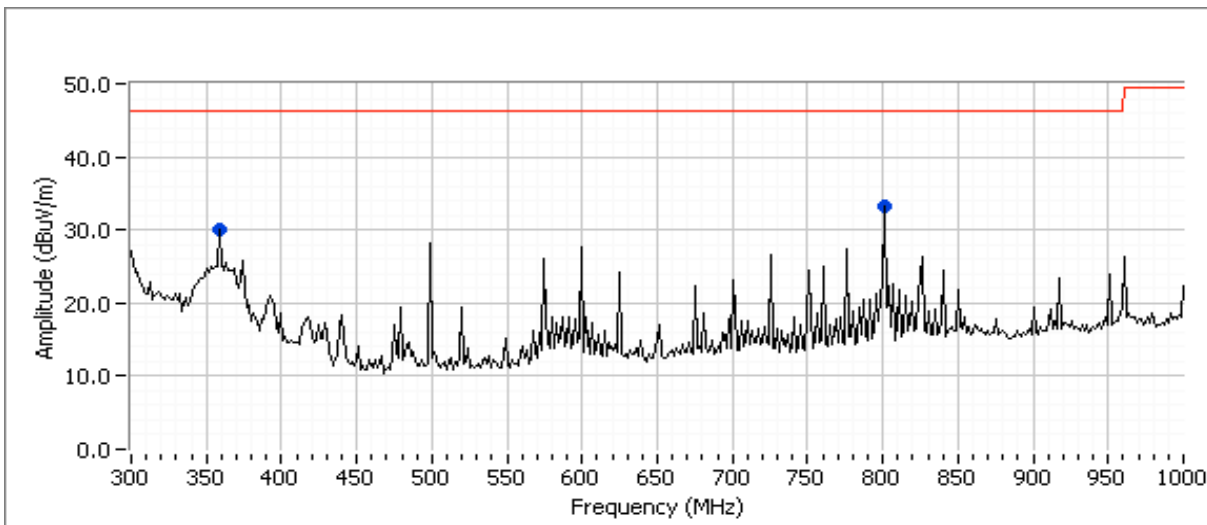
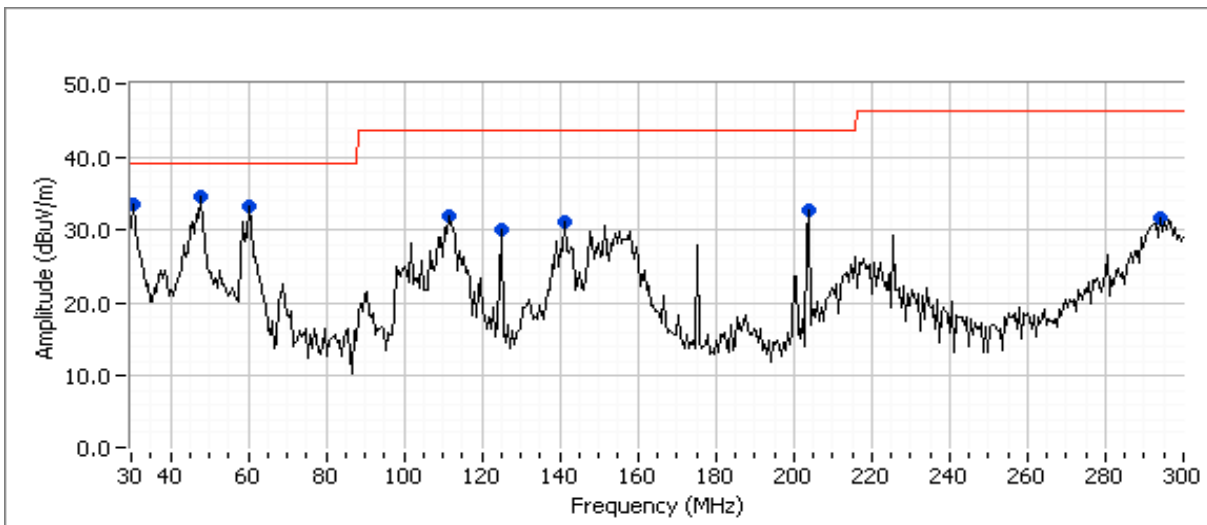



EMC Test Data

Client: Vivint, Inc.	Job Number: J91375
Model: SR1410	T-Log Number: T91470
Contact: Venkat Kalkunte	Account Manager: Christine Krebill
Standard: FCC 15.E / FCC 15.B	Class: A

Preliminary peak readings captured during pre-scan

Frequency MHz	Level dB μ V/m	Pol v/h	FCC 15B		Detector Pk/QP/Avg	Azimuth degrees	Height meters	Comments
			Limit	Margin				
47.790	34.7	V	39.1	-4.4	Peak	236	1.0	
30.604	33.4	V	39.1	-5.7	Peak	133	1.5	
60.226	33.3	V	39.1	-5.8	Peak	0	1.0	
203.687	32.7	V	43.5	-10.8	Peak	42	2.0	
111.581	31.8	V	43.5	-11.7	Peak	274	1.0	
141.194	31.0	V	43.5	-12.5	Peak	65	3.5	
799.997	33.3	V	46.4	-13.1	Peak	178	1.5	
124.997	30.1	V	43.5	-13.4	Peak	254	1.0	
294.048	31.6	V	46.4	-14.8	Peak	319	2.5	
358.918	30.1	H	46.4	-16.3	Peak	188	1.0	

Preliminary quasi-peak readings (no manipulation of EUT interface cables)

Frequency MHz	Level dB μ V/m	Pol v/h	FCC 15B		Detector Pk/QP/Avg	Azimuth degrees	Height meters	Comments
			Limit	Margin				
60.226	33.4	V	39.1	-5.7	QP	328	1.00	
47.790	33.2	V	39.1	-5.9	QP	302	1.00	
30.604	31.5	V	39.1	-7.6	QP	171	1.00	
111.581	31.4	V	43.5	-12.1	QP	230	1.00	
124.997	30.3	V	43.5	-13.2	QP	255	1.00	
141.194	30.3	V	43.5	-13.2	QP	89	3.28	
799.997	32.9	V	46.4	-13.5	QP	182	1.55	



EMC Test Data

Client: Vivint, Inc.	Job Number: J91375
Model: SR1410	T-Log Number: T91470
	Account Manager: Christine Krebill
Contact: Venkat Kalkunte	
Standard: FCC 15.E / FCC 15.B	Class: A

Run #2: Maximized Readings From Run #1

Test Parameters for Maximized Reading(s)			
Frequency Range (MHz)	Test Distance (meters)	Limit Distance (meters)	Extrapolation Factor (dB, applied to data)
30 - 1000	5	10	-6.0

Maximized quasi-peak readings (includes manipulation of EUT interface cables)

Frequency MHz	Level dB μ V/m	Pol v/h	FCC 15B		Detector Pk/QP/Avg	Azimuth degrees	Height meters	Comments
			Limit	Margin				
60.226	33.4	V	39.1	-5.7	QP	328	1.00	Moving cable lowered reading.
47.790	33.2	V	39.1	-5.9	QP	302	1.00	Moving cable lowered reading.
30.604	31.5	V	39.1	-7.6	QP	171	1.00	Moving cable lowered reading.
111.581	31.4	V	43.5	-12.1	QP	230	1.00	Moving cable lowered reading.
124.997	30.3	V	43.5	-13.2	QP	255	1.00	Moving cable lowered reading.
141.194	30.3	V	43.5	-13.2	QP	89	3.28	Moving cable lowered reading.

End of Report

This page is intentionally blank and marks the last page of this test report.