

Nemko-CCL, Inc.
1940 West Alexander Street
Salt Lake City, UT 84119
801-972-6146

Test Report

Certification

Test Of: PB01

Test Specifications:

FCC Part 15, Subpart C

FCC ID: 2AAAS-PB01

Test Report Serial No: 271375-2.2

Applicant:
Vivint, Inc.
4931 N 300 W
Provo, UT 84604
U.S.A

Date of Test: August 14, 2014 and December 12, 2014

Report Issue Date: December 15, 2014

Accredited Testing Laboratory By:



NVLAP Lab Code 100272-0

CERTIFICATION OF ENGINEERING REPORT

This report has been prepared by Nemko-CCL, Inc. to document compliance of the device described below with the certification requirements of FCC Part 15, Subpart C. This report may be reproduced in full. Partial reproduction of this report may only be made with the written consent of the laboratory. The results in this report apply only to the sample tested.

- Applicant: Vivint, Inc.
- Manufacturer: Flextronics
- Manufacturer: Houri Linear Electronics Manufactory
- Brand Name: Vivint
- Model Number: PB01
- FCC ID: 2AAAS-PB01

On this 15th day of December 2014, I, individually and for Nemko-CCL, Inc., certify that the statements made in this engineering report are true, complete, and correct to the best of my knowledge, and are made in good faith.

Although NVLAP has accredited the Nemko-CCL, Inc. EMC testing facilities, this report must not be used to claim product certification, approval, or endorsement by NVLAP, NIST, or any agency of the federal government.

Nemko-CCL, Inc.



Tested by: Norman P. Hansen
Test Technician



Reviewed by: Thomas C. Jackson
Certification Manager

TABLE OF CONTENTS

	PAGE
<u>SECTION 1.0 CLIENT INFORMATION</u>	4
<u>SECTION 2.0 EQUIPMENT UNDER TEST (EUT)</u>	5
<u>SECTION 3.0 TEST SPECIFICATION, METHODS & PROCEDURES</u>	6
<u>SECTION 4.0 OPERATION OF EUT DURING TESTING</u>	10
<u>SECTION 5.0 SUMMARY OF TEST RESULTS</u>	11
<u>SECTION 6.0 MEASUREMENTS, EXAMINATIONS AND DERIVED RESULTS</u>	12
<u>APPENDIX 1 TEST PROCEDURES AND TEST EQUIPMENT</u>	19
<u>APPENDIX 2 PHOTOGRAPHS</u>	21

SECTION 1.0 CLIENT INFORMATION

1.1 Applicant:

Company Name: Vivint, Inc.
4931 N 300 W
Provo, UT 84604
U.S.A

Contact Name: Greg Hansen
Title: Regulatory Compliance Manager

1.2 Manufacturer:

Company Name: Flextronics
89 Yong Fu Road
Tong Fu Yu Industrial Park
Fu Yong Town, Bao An District
Shenzhen 518103 P.R. China

Contact Name: Feng Zhou
Title: QA Engineer

1.3 Manufacturer:

Company Name: Hourui Linear Electronics Manufactory
Hourui Second Industrial Zone
Hourui Village
Xixang, Bao An District, Shenzhen
P.R. China

Contact Name: Henry Luk
Title: Senior Electronic Engineering Supervisor

SECTION 2.0 EQUIPMENT UNDER TEST (EUT)**2.1 Identification of EUT:**

Brand Name:	Vivint
Model Number:	PB01
Serial Number:	None
Dimensions:	4.5 cm x 2.9 cm x 1.25 cm
Country of Manufacture:	China

2.2 Description of EUT:

The PB01 is used by an individual to indicate a safety or security incident. The PB01 has a button to press to activate a 345 MHz transmitter that will indicate to the security system controller action is needed to assist an individual. The PB01 is powered by a CR23032 battery. The PB01 can be worn on a lanyard, with a belt clip, or on a wrist band.

This report covers the transmitter circuitry of the device subject to FCC Part 15, Subpart C. The circuitry of the device, subject to FCC Part 15, Subpart B is covered in Nemko-CCL, Inc. report 271375-1.

2.3 EUT and Support Equipment:

Brand Name Model Number Serial Number	FCC ID Number or Compliance	Description	Name of Interface Ports / Interface Cables
BN: Vivint MN: PB01 (Note 1) SN: None	2AAAS-PB01	Security System Alert Button	See Section 2.4

Note: (1) EUT

2.4 Interface Ports on EUT:

There are no interface ports on the EUT.

2.5 Modification Incorporated/Special Accessories on EUT:

There were no modifications or special accessories required to comply with the specification.

SECTION 3.0 TEST SPECIFICATION, METHODS & PROCEDURES**3.1 Test Specification:**

Title: FCC PART 15, Subpart C (47 CFR 15)
Section 15.203, Section 15.207, and Section 15.231

Periodic operation in the band 40.66-40.70 MHz and above 70 MHz

Purpose of Test: The tests were performed to demonstrate initial compliance.

3.2 Methods & Procedures:**3.2.1 §15.203**

An intentional radiator shall be designed to ensure that no antenna other than that furnished by the responsible party shall be used with the device. The use of a permanently attached antenna or of an antenna that uses a unique coupling to the intentional radiator shall be considered sufficient to comply with the provisions of this Section. The manufacturer may design the unit so that a broken antenna can be replaced by the user, but the use of a standard antenna jack or electrical connector is prohibited. This requirement does not apply to carrier current devices or to devices operated under the provisions of Sections 15.211, 15.213, 15.217, 15.219, or 15.221. Further, this requirement does not apply to intentional radiators that must be professionally installed, such as perimeter protection systems and some field disturbance sensors, or to other intentional radiators which, in accordance with Section 15.31(d), must be measured at the installation site. However, the installer shall be responsible for ensuring that the proper antenna is employed so that the limits in this Part are not exceeded.

3.2.2 §15.207 Conducted Limits

(a) Except for Class A digital devices, for equipment that is designed to be connected to the public utility (AC) power line, the radio frequency voltage that is conducted back onto the AC power line on any frequency or frequencies within the band 150 kHz to 30 MHz shall not exceed the limits in the following table, as measured using a 50 μ H/50 ohms line impedance stabilization network (LISN). Compliance with the provisions of this paragraph shall be based on the measurement of the radio frequency voltage between each power line and ground at the power terminal. The lower limit applies at the band edges.

Frequency of Emission (MHz)	Conducted Limit (dB μ V)	
	Quasi-peak	Average
0.15 – 0.5*	66 to 56*	56 to 46*
0.5 – 5	56	46
5 - 30	60	50

*Decreases with the logarithm of the frequency.

3.2.3 §15.231

(a) The provisions of this section are restricted to periodic operation within the band 40.66-40.70 MHz and above 70 MHz. Except as Shown in paragraph (e) of this section, the intentional radiator is restricted to the transmission of a control signal such as those used with alarm systems, door openers, remote switches, etc. Radio control of toys is not permitted. Continuous transmissions, such as voice or video, and data transmissions are not permitted. The prohibition against data transmissions does not preclude the use of recognition codes. Those codes are used to identify the sensor that is activated or to identify the particular component as being part of the system. The following conditions shall be met to comply with the provisions for this periodic operation:

(1) A manually operated transmitter shall employ a switch that will automatically deactivate the transmitter within not more than 5 seconds of being released.

(2) A transmitter activated automatically shall cease transmission within 5 seconds after activation.

(3) Periodic transmissions at regular predetermined intervals are not permitted. However, polling or supervision transmission to determine system integrity of transmitters used in security or safety applications are allowed if the periodic rate of transmission does not exceed one transmission of not more than one second duration per hour for each transmitter.

(4) Intentional radiators which are employed for radio control purposes during emergencies involving fire, security, and safety of life, when activated to signal an alarm, may operate during the pendency of the alarm condition.

(b) In addition to the provisions of §15.205, the field strength of emission from intentional radiators operated under this section shall not exceed the following:

Fundamental frequency (MHz)	Field strength of fundamental (microvolts/meter)	Field strength of spurious emissions (microvolts/meter)
40.66 - 40.70	2,250	225
70 - 130	1,250	125
130 - 174	1,250 to 3,750 **	125 to 375 **
174 - 260	3,750	375
260 - 470	3,750 to 12,500 **	375 to 1,250 **
Above 470	12,500	1,250

** Linear interpolations

[Where F is the frequency in MHZ, the formula for calculating the maximum permitted field strengths are as follows: for the band 130 – 174 MHz, $\mu\text{V}/\text{m}$ at 3 meters = $56.81818(F) - 6136.3636$; for the band 260 – 470 MHz, $\mu\text{V}/\text{m}$ at 3 meters = $41.6667(F) - 7083.3333$. The maximum permitted unwanted emission level is 20 dB below the maximum permitted fundamental level.]

(1) The above field strength limits are specified at a distance of 3 meters. The tighter limits apply at the band edges.

(2) Intentional radiators operating under the provisions of this section shall demonstrate compliance with the limits on the field strength of emissions, as shown in the above table, based on the average value of the measured emissions. As an alternative, compliance with the limits in the above table may be based on the use of measurement instrumentation with a CISPR quasi-peak detector. The specific method of measurement employed shall be specified in the application for equipment authorization. If average emission measurements are employed, the provision in §15.35 for averaging pulsed emission and for limiting peak emissions apply. Further, compliance with the provisions of §15.205 shall be demonstrated using the measurement instrumentation specified in that section.

(3) The limits on the field strength of the spurious emission in the above table are based on the fundamental frequency of the intentional radiator. Spurious emission shall be attenuated to the average (or, alternatively, CISPR quasi-peak) limits shown in this table or to the general limits shown in §15.209, whichever limit permits a higher field strength.

(c) The bandwidth of the emission shall be no wider than 0.25% of the center frequency for devices operating above 70 MHz and below 900 MHz. For devices operating above 900 MHz, the emission shall be no wider than 0.5% of the center frequency. Bandwidth is determined at the points 20 dB down from the modulated carrier.

(d) For devices operation within the frequency band 40.66-40.70 MHz, the bandwidth of the emission shall be confined within the band edges and the frequency tolerance of the carrier shall be $\pm 0.01\%$. This frequency tolerance shall be maintained for a temperature variation of -20 degrees to +50 degrees C at normal supply voltage, and for a variation on the primary supply voltage from 85% to 115% of the rated supply voltage at a temperature of 20 degrees C. For battery operated equipment, the equipment tests shall be performed using a new battery.

(e) Intentional radiators may operate at a periodic rate exceeding that specified in paragraph (a) of this section and may be employed for any type of operation, including operation prohibited in paragraph (a) of this section, provided that intentional radiator complies with the provisions of paragraphs (b) through (d) of this section except the field strength table in paragraph (b) of this section is replaced by the following:

Fundamental frequency (MHz)	Field strength of fundamental (microvolts/meter)	Field strength of spurious emissions (microvolts/meter)
40.66 - 40.70	1,000	100
70 - 130	500	50
130 - 174	500 to 1,500 **	50 to 150 **
174 - 260	1,500	150
260 - 470	1,500 to 5,000 **	150 to 500 **
Above 470	5,000	500

** Linear interpolations

[Where F is the frequency in MHZ, the formula for calculating the maximum permitted field strengths are as follows: for the band 130 – 174 MHz, $\mu\text{V}/\text{m}$ at 3 meters = $22.72727(F) - 2454.545$; for the band 260 – 470 MHz, $\mu\text{V}/\text{m}$ at 3 meters = $16.6667(F) - 2833.3333$. The maximum permitted unwanted emission level is 20 dB below the maximum permitted fundamental level.]

In addition, devices operated under the provisions of this paragraph shall be provided with a means for automatically limiting operation so that the duration of each transmission shall not be greater than one second and the silent periods between transmissions shall be at least 30 times the duration of the transmission but in no case less than 10 seconds.

3.3 Test Procedure

The conducted disturbance at mains ports and radiated disturbance testing was performed according to the procedures in ANSI C63.4: 2003 and 47 CFR Part 15. Testing was performed at Nemko-CCL, Inc. Wanship open area test site #2, located at 29145 Old Lincoln Highway, Wanship, UT. This site has been registered with the FCC, and was renewed February 15, 2012 (90504). This registration is valid for three years.

Nemko-CCL, Inc. is accredited by National Voluntary Laboratory Accreditation Program (NVLAP); NVLAP Lab Code: 100272-0, which is effective until September 30, 2015.

SECTION 4.0 OPERATION OF EUT DURING TESTING

4.1 Operating Environment:

Power Supply: 3 VDC from CR2032 battery

4.2 Operating Modes:

The EUT was tested on 3 orthogonal axes while in a constantly transmitting. A new battery was used for testing. The worst-case emissions were seen with the EUT placed flat on the table.

4.3 EUT Exercise Software:

Internal firmware was used to exercise the EUT.

SECTION 5.0 SUMMARY OF TEST RESULTS**5.1 FCC Part 15, Subpart C****5.1.1 Summary of Tests:**

Part 15, Subpart C Reference	Test Performed	Frequency Range (MHz)	Result
15.203	Antenna Requirement	N/A	Complied
15.207	Emissions at the AC Mains	0.15 - 30	Not Applicable
15.231 (a)	Periodic Operation	345	Complied
15.231 (b)	Radiated Emissions	0.009 - 3450	Complied
15.231 (c)	Bandwidth	345	Complied
15.231 (d)	Frequency Stability	40.66 – 40.70	Not Applicable
15.231 (e)	Radiated Emissions	0.009 - 3450	Not Applicable

5.2 Result

In the configuration tested, the EUT complied with the requirements of the specification.

SECTION 6.0 MEASUREMENTS, EXAMINATIONS AND DERIVED RESULTS

6.1 General Comments:

This section contains the test results only. Details of the test methods used and a list of the test equipment used during the measurements can be found in Appendix 1 of this report.

6.2 Test Results:

6.2.1 §15.203

The antenna is an etched portion of the PCB and cannot be replaced by the user.

RESULT

The EUT complied with the requirements of this section.

6.2.2 §15.231 (a)

1. The EUT is manually activated. The emission when the button is pressed, held for 2 seconds, then released is shown below.

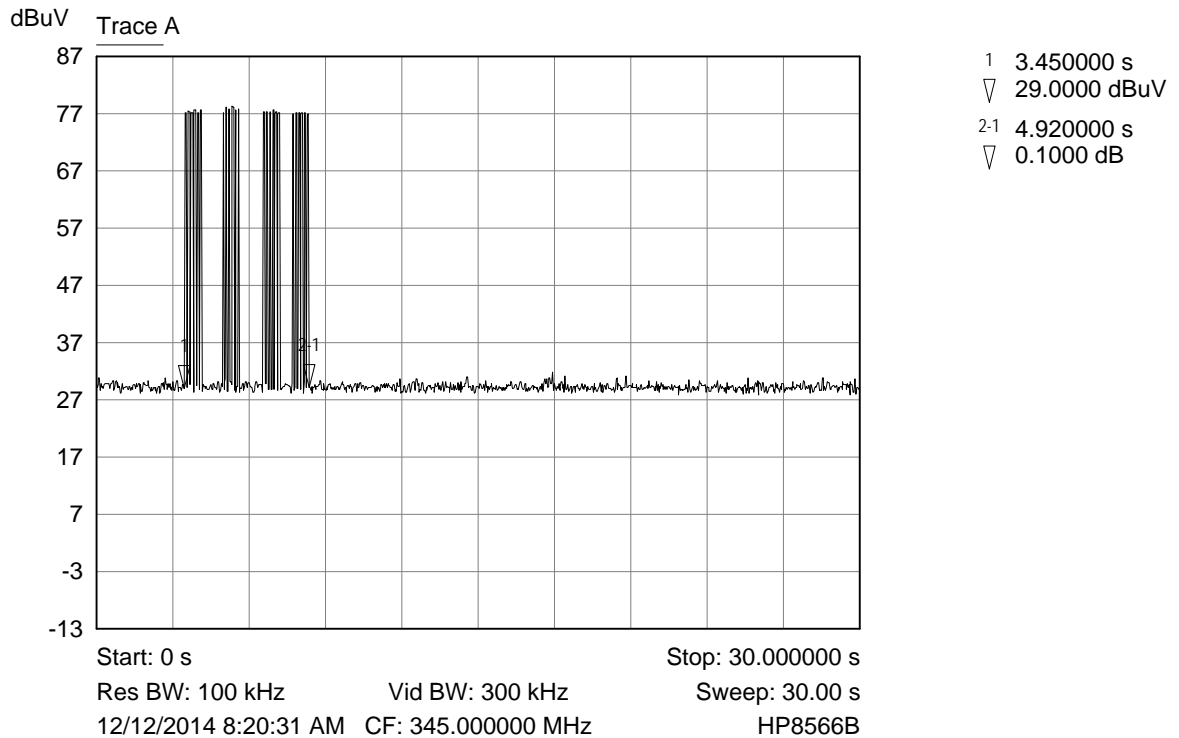

2. The EUT is not automatically activated.

3. The PB01 does not transmit at regular predetermined intervals
4. The EUT is used during an emergency that involves fire and safety of life.
5. The EUT is installed by a professional installer and the setup information is contained in the first 12 pulses, each 25.74 ms in duration, of a normal transmission in 2.55 seconds. This will also occur when the battery is replaced. The requirement is that these transmissions occur within in a 10 second period.

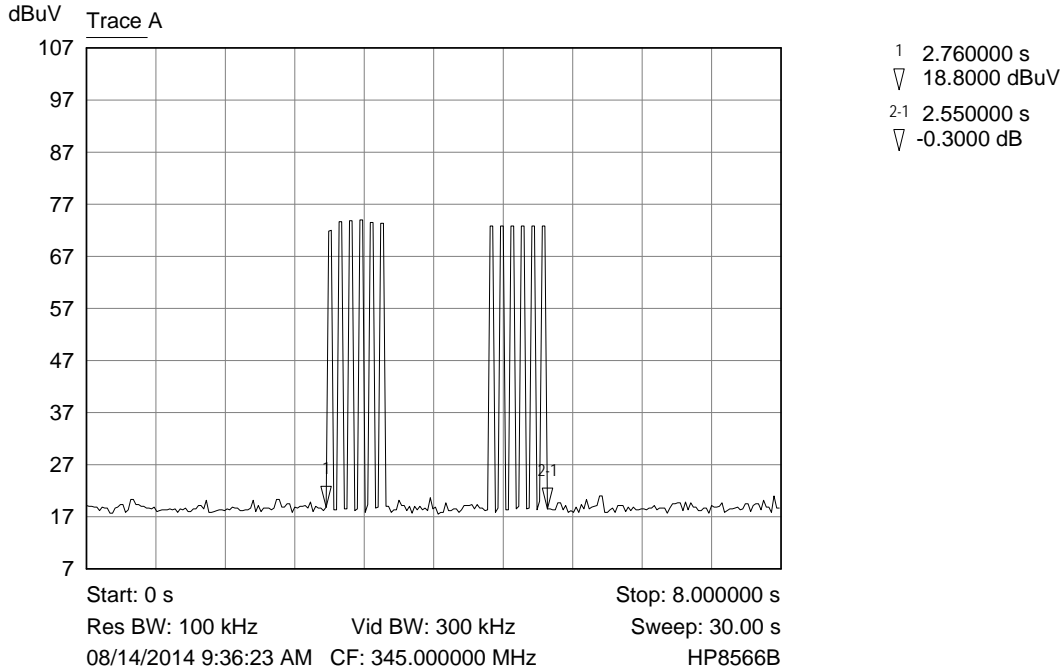

RESULT

In the configuration tested, the EUT complied with the requirements of this section.

6.2.3 §15.231 (b) Radiated Emissions

The PB01 operates at 345 MHz, therefore; the field strength of the fundamental must be not exceed 7291.7 $\mu\text{V/m}$ (77.3 dB $\mu\text{V/m}$) at 3 meters. The maximum permitted field strength of any unwanted emission must be 20 dB below the maximum allowable fundamental field strength (57.3 dB $\mu\text{V/m}$).

Emissions in the restricted bands of §15.205 must meet the limits specified in §15.209.

Measurement Data Fundamental and Harmonic Emissions:

The frequency range from the lowest frequency to the tenth harmonic of the highest fundamental frequency was investigated to measure any radiated emissions.

Pulsed Emission Averaging Factor

The PB01 transmitter is a pulsed emission device using Manchester encoding: therefore, the method of §15.35 for averaging a pulsed emission may be used. A timing diagram of the pulsed transmission, plots of the pulse train, and the average factor calculations are shown below:

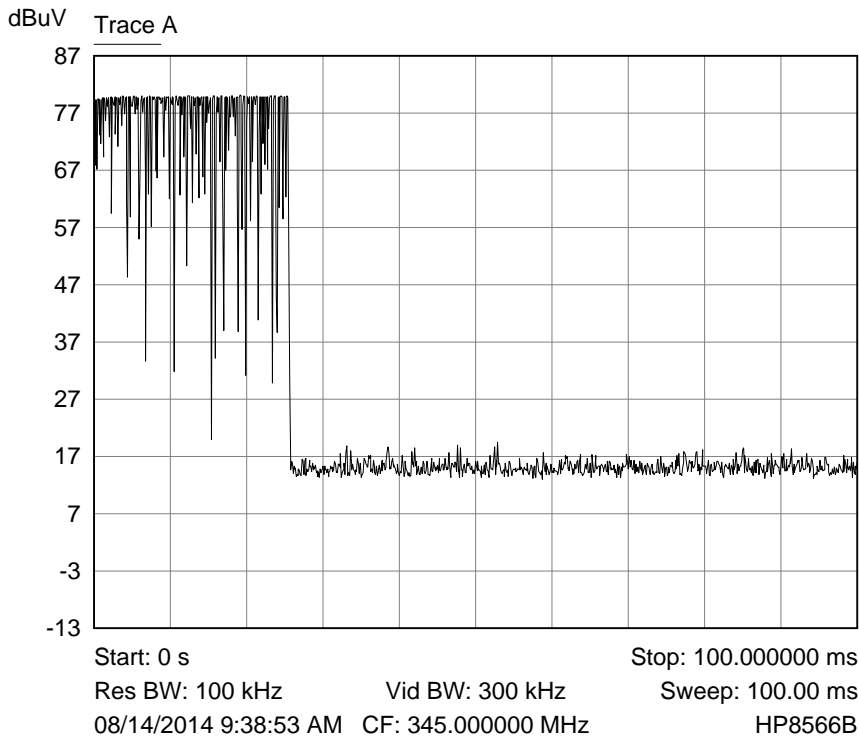

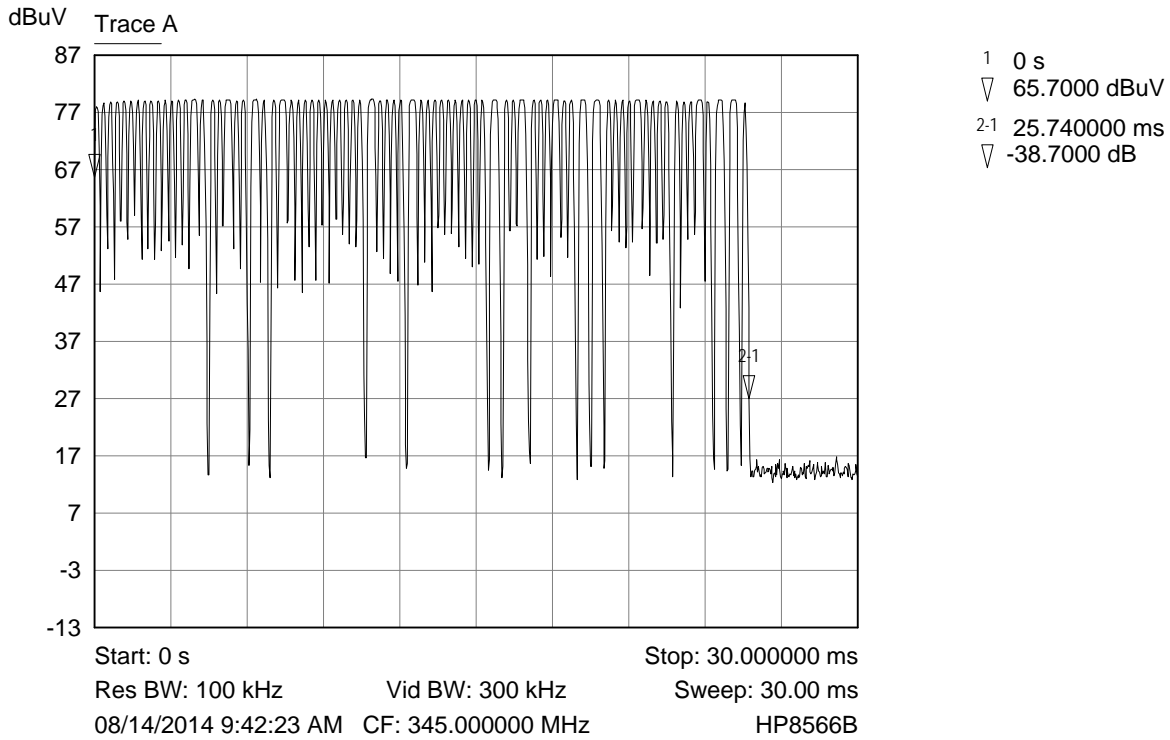

Average factor calculation

From the plots, the pulse train exceeds 100 ms in duration. The Average Factor will be calculated using 100 ms as specified in FCC §15.35(c). The pulsed transmission is 25.74 ms and uses Manchester encoding that gives a 50% duty cycle in all cases.

The Average Factor is calculated by the equation:

$$\text{Average Factor} = 20 \log (\text{on time/pulse train time})$$

Pulse train time = 100 ms

On time = 25.74 x 0.5 = 12.87 ms

$$\begin{aligned} \text{Average Factor} &= 20 \log (12.87 / 100) \\ &= -17.8 \text{ dB} \end{aligned}$$

§15.35(b) specifies a 20 dB maximum between the peak and average measurements; therefore, a -17.8 dB averaging factor will be used.

6.2.3.1 Radiated Interference Measurements – (Vertical Polarity)

Frequency (MHz)	Detector	Receiver Reading (dB μ V)	Average Factor (dB)	Correction Factor (dB/m)	Field Strength (dB μ V/m)	Limit (dB μ V/m)	Delta (dB)
345.0	Peak	67.7	-17.8	19.4	69.3	77.3	-8.0
690.0	Peak	15.5	-17.8	27.6	25.3	57.3	-32.0
1035.0*	Peak	23.2	-17.8	26.9	32.3	54.0	-21.7
1380.0*	Peak	21.9	-17.8	28.2	32.3	54.0	-21.7
1725.0	Peak	20.6	-17.8	29.5	32.3	57.3	-25.0
2070.0	Peak	25.0	-17.8	30.9	38.1	57.3	-19.2
2415.0	Peak	25.6	-17.8	31.8	39.6	57.3	-17.7
2760.0*	Peak	30.2	-17.8	33.1	45.5	54.0	-8.5
3105.0	Peak	35.8	-17.8	34.3	52.3	57.3	-5.0
3450.0	Peak	24.3	-17.8	35.3	41.8	57.3	-15.5
* Emissions within restricted bands							

6.2.3.2 Radiated Interference Measurements - (Horizontal Polarity)

Frequency (MHz)	Detector	Receiver Reading (dB μ V)	Average Factor (dB)	Correction Factor (dB/m)	Field Strength (dB μ V/m)	Limit (dB μ V/m)	Delta (dB)
345.0	Peak	70.6	-17.8	19.4	72.2	77.3	-5.1
690.0	Peak	17.5	-17.8	27.6	27.3	57.3	-30.0
1035.0*	Peak	17.6	-17.8	26.9	26.7	54.0	-27.3
1380.0*	Peak	21.9	-17.8	28.2	32.3	54.0	-21.7
1725.0	Peak	20.1	-17.8	29.5	31.8	57.3	-25.5
2070.0	Peak	24.9	-17.8	30.9	38.0	57.3	-19.3
2415.0	Peak	27.6	-17.8	31.8	41.6	57.3	-15.7
2760.0*	Peak	32.6	-17.8	33.1	47.9	54.0	-6.1
3105.0	Peak	36.9	-17.8	34.3	53.4	57.3	-3.9
3450.0	Peak	26.8	-17.8	35.3	44.3	57.3	-13.0
* Emissions within restricted bands							

6.2.3.3 Sample Field Strength Calculation:

The field strength is calculated by adding the Correction Factor (Antenna Factor + Cable Factor) and the Average Factor to the measured level of the receiver. The receiver amplitude reading is compensated for any amplifier gain.

The basic equation with a sample calculation is shown below:

$$FS = RA + CF + AV \text{ Where}$$

FS = Field Strength

RA = Receiver Amplitude Reading

CF = Correction Factor (Antenna Factor + Cable Factor)

AV = Averaging Factor

Assume a receiver reading of 44.2 dB μ V is obtained from the receiver, with an average factor of -8.6 dB and a correction factor of 17.5 dB. The field strength is calculated by adding the correction factor and the average factor, giving a field strength of 53.1 dB μ V/m, $FS = 44.2 + 17.5 + (-8.6) = 53.1 \text{ dB}\mu\text{V/m}$

RESULT

In the configuration tested, the EUT complied with the requirements of this section.

6.2.4 §15.231 (c) Bandwidth

Demonstration of Compliance:

The bandwidth of the emission must not be wider than 0.25% of the center frequency. The center frequency is 345 MHz, therefore the bandwidth must not be wider than 862.5 kHz. The PB01 bandwidth was 43 kHz. See spectrum analyzer plot below.

Bandwidth Plot

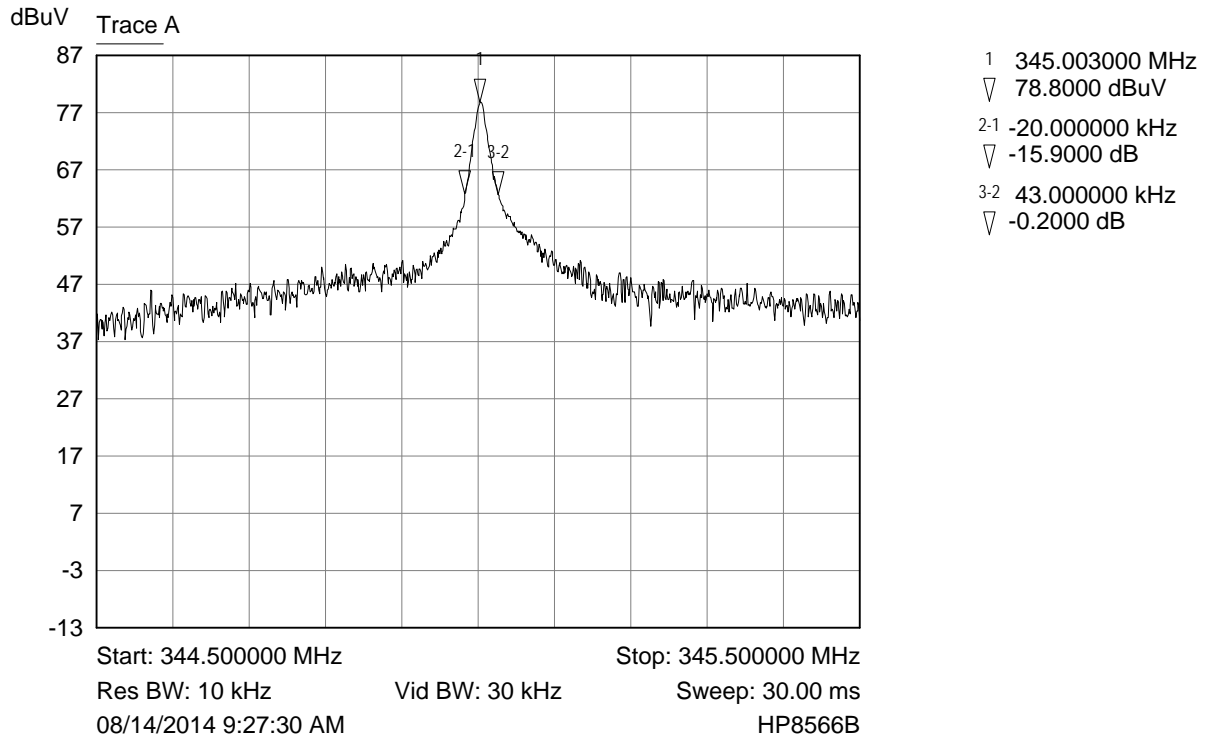

RESULT

In the configuration tested, the EUT complied with the requirements of this section.

APPENDIX 1 TEST PROCEDURES AND TEST EQUIPMENT

A1.1 Radiated Disturbance:

The radiated disturbance from the EUT was measured using a spectrum analyzer with a quasi-peak adapter for peak and quasi-peak readings.

A preamplifier with a fixed gain of 26 dB was used to increase the sensitivity of the measuring instrumentation. The quasi-peak adapter uses a bandwidth of 120 kHz, with the spectrum analyzer's resolution bandwidth set at 1 MHz, for readings in the 30 to 1000 MHz frequency ranges. A 31 dB preamp was used for measurements above 1000 MHz with the spectrum analyzer RBW set to 1 MHz and VBW at 3 MHz..

A loop antenna was used to measure emissions below 30 MHz. Emission readings more than 20 dB below the limit at any frequency may not be listed in the reported data. For frequencies between 9 kHz and 30 MHz, or the lowest frequency generated or used in the device greater than 9 kHz, and less than 30 MHz, the spectrum analyzer resolution bandwidth was set to 9 kHz and the video bandwidth was set to 30 kHz. For average measurements, the spectrum analyzer average detector was used.

For frequencies above 30 MHz, an amplifier and preamplifier were used to increase the sensitivity of the measuring instrumentation. The quasi-peak adapter uses a bandwidth of 120 kHz, with the spectrum analyzer's resolution bandwidth set at 1 MHz, for readings in the 30 to 1000 MHz frequency ranges. For peak emissions above 1000 MHz the spectrum analyzer's resolution bandwidth was set to 1 MHz and the video bandwidth was set to 3 MHz. For average measurements above 1000 MHz the spectrum analyzer's resolution bandwidth was set to 1 MHz and the average detector of the analyzer was used.

A biconilog antenna was used to measure the frequency range of 30 to 1000 MHz, at a distance of 3 meters from the EUT. The readings obtained by these antennas are correlated to the levels obtained with a tuned dipole antenna by adding antenna factors. A double-ridged guide antenna was used to measure the emissions at frequencies above 1000 MHz at a distance of 3 meters from the EUT.

The configuration of the EUT was varied to find the maximum radiated emission. The EUT was connected to the peripherals listed in Section 2.3 via the interconnecting cables listed in Section 2.4. A technician manually manipulated these interconnecting cables to obtain worst-case radiated disturbance. The EUT was rotated 360 degrees, and the antenna height was varied from 1 to 4 meters to find the maximum radiated emission. Where there were multiple interface ports all of the same type, cables are either placed on all of the ports or cables added to these ports until the emissions do not increase by more than 2 dB.

Desktop EUT are measured on a non-conducting table 0.8 meters above the ground plane. The table is placed on a turntable, which is level with the ground plane. For equipment normally placed on floors, the equipment shall be placed directly on the turntable.

For radiated emission testing at 30 MHz or above that is performed at distances closer than the specified distance, an inverse proportionality factor of 20 dB per decade is used to normalize the measured data for determining compliance.

Type of Equipment	Manufacturer	Model Number	Barcode Number	Date of Last Calibration	Due Date of Calibration
Wanship Open Area Test Site #2	Nemko	N/A	830	12/10/2013	12/10/2014
Test Software	Nemko	Radiated Emissions	Revision 1.3	N/A	N/A
Spectrum Analyzer/Receiver	Rohde & Schwarz	ESU40	1229	04/08/2014	04/08/2015
Spectrum Analyzer	Hewlett Packard	8566B	644	02/25/2014	02/25/2015
Quasi-Peak Detector	Hewlett Packard	85650A	572	03/10/2014	03/10/2015
Biconilog Antenna	EMCO	3142	714	4/25/2013	4/25/2015
Double Ridged Guide Antenna	EMCO	3115	735	03/07/2013	03/07/2015
High Frequency Amplifier	Miteq	AFS4-00102650-35-10P-4	1299	05/08/2014	05/08/2015
20' High Frequency Cable	Microcoax	UFB197C-1-3120-000000	1297	05/08/2014	05/08/2015
10 Meter Radiated Emissions Cable Wanship Site #2	Nemko	Cable L	842	12/19/2013	12/19/2014
Pre/Power-Amplifier	Hewlett Packard	8447F	762	09/05/2014	09/05/2015
6 dB Attenuator	Hewlett Packard	8491A	1103	12/23/2013	12/23/2014

An independent calibration laboratory or Nemko-CCL, Inc. personnel calibrates all the equipment listed above at intervals defined in ANSI C63.4:2003 Section 4.4 following outlined calibration procedures. All measurement instrumentation is traceable to the National Institute of Standards and Technology (NIST). Supporting documentation relative to tractability is on file and is available for examination upon request.

Radiated Emissions Test Setup

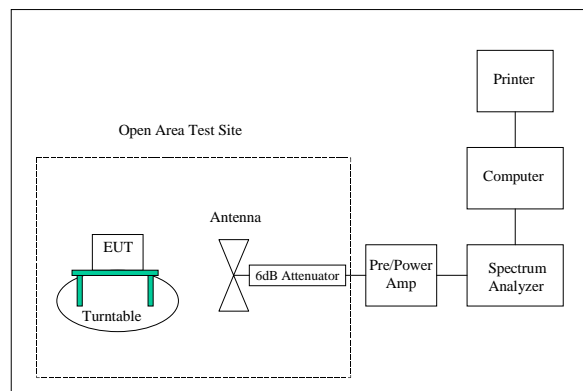

APPENDIX 2 PHOTOGRAPHS

Photograph 1 – Front View Radiated Disturbance Worst Case Configuration – Flat on Table



Photograph 2 – Back View Radiated Disturbance Worst Case Configuration – Flat on Table



Photograph 3 – Front View Radiated Disturbance Configuration – Vertical on Table

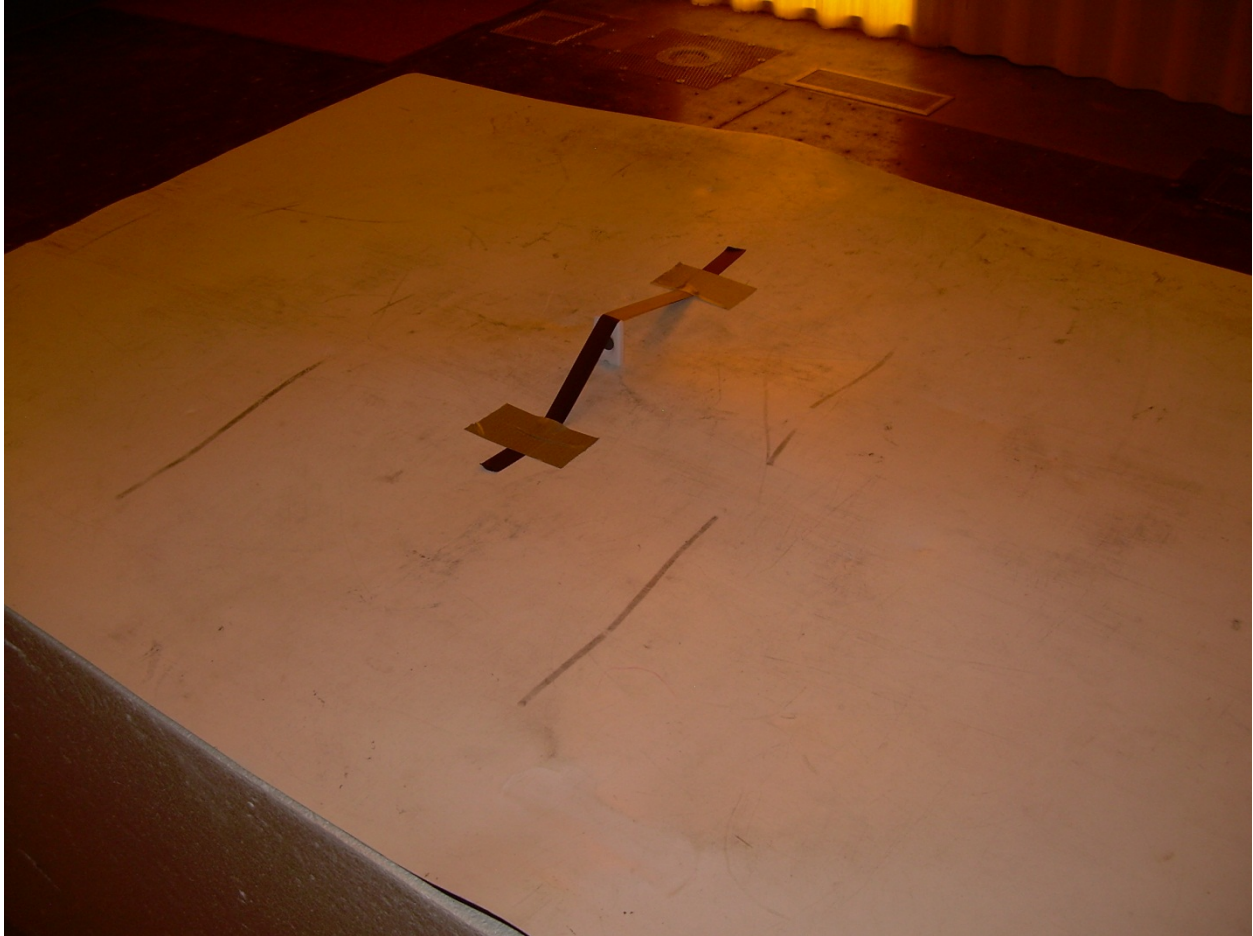

Photograph 4 – Front View Radiated Disturbance Configuration – On Edge on Table

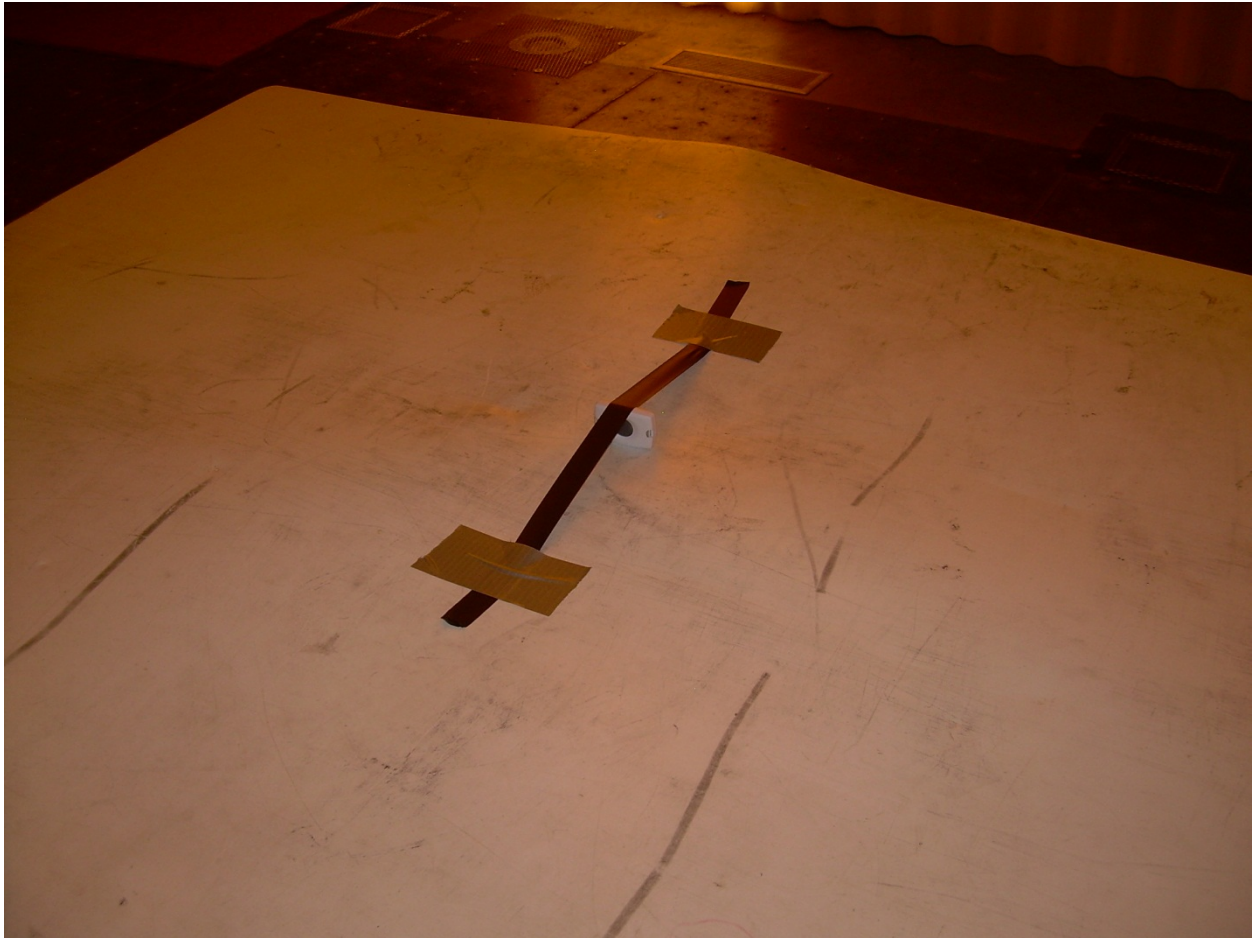

Photograph 5 – Front View of the EUT



Photograph 6 – Back View of the EUT



Photograph 7 – View of the Front of the PCB



Photograph 8 – View of the Back of the PCB

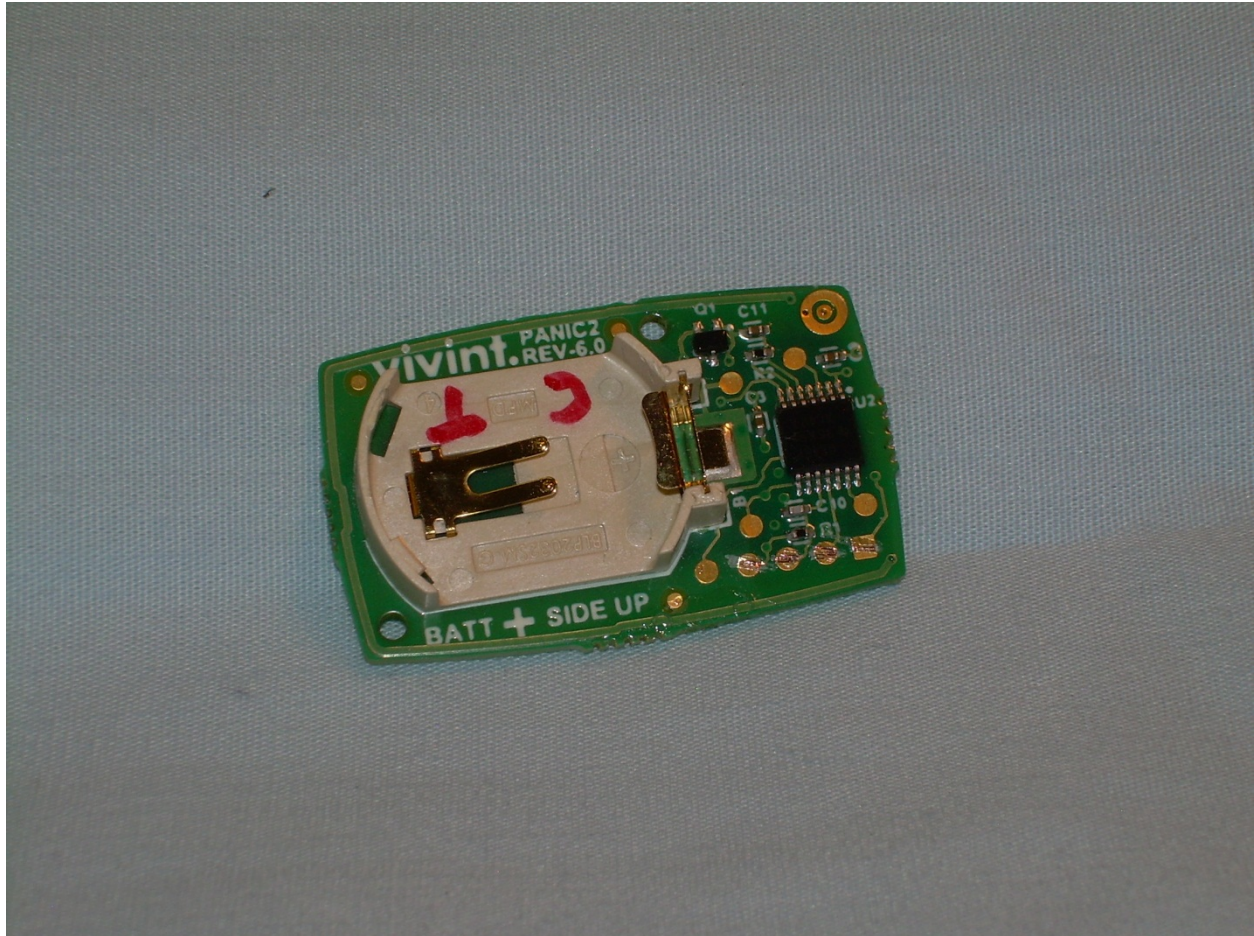

Photograph 9 – View of the Lanyard



Photograph 10 – View of the Belt Clip

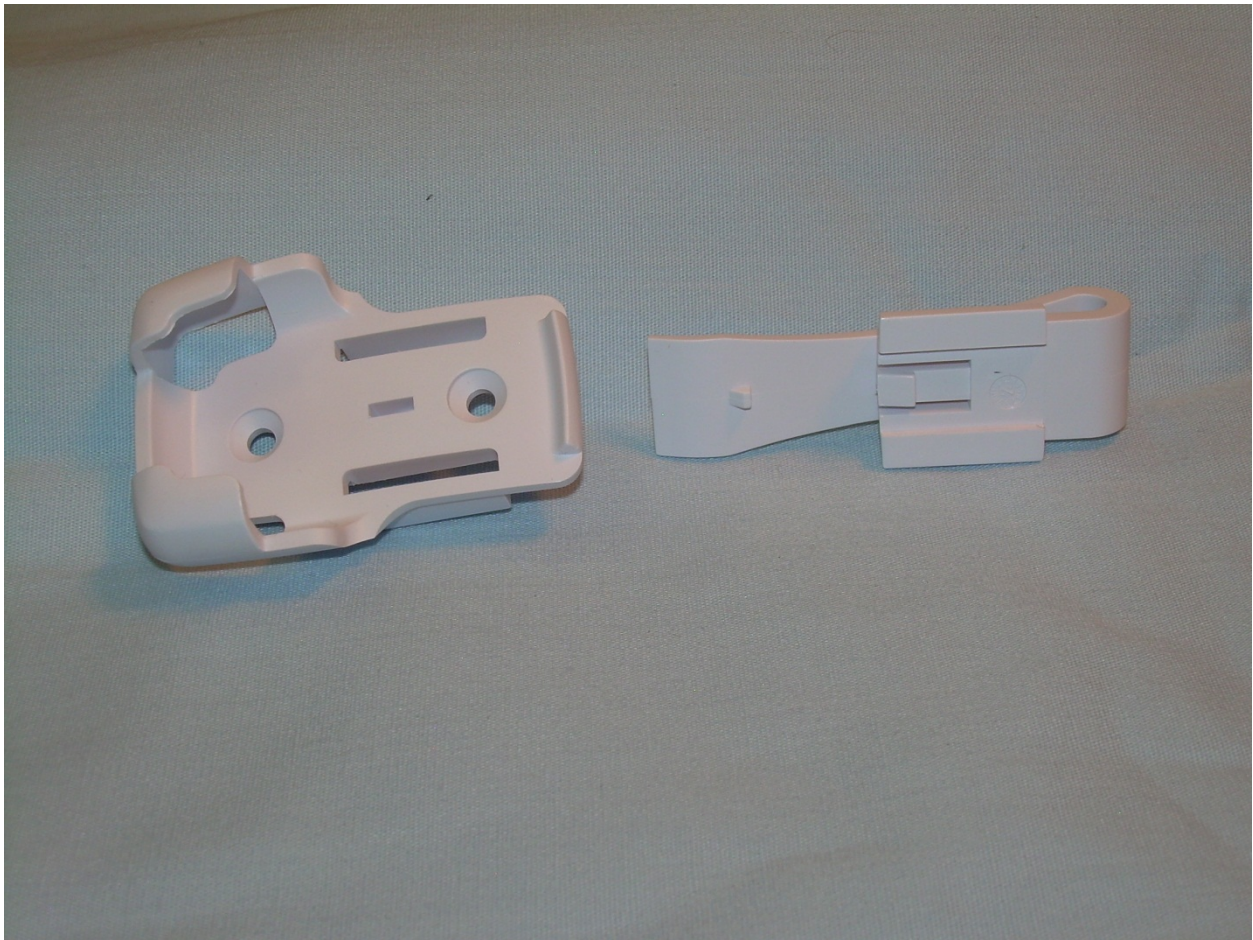

Photograph 11 – View of the Wrist Strap

