



*FCC PART 15, SUBPART B and C; and FCC SECTION 15.247; RSS-247 and RSS-GEN
TEST REPORT*

for

VIVINT ZIGBEE BRIDGE

Model: BB03

Prepared for

VIVINT, INC.
4931 N. 300 W.
PROVO, UTAH 84604

Prepared by: _____

JAMES ROSS

Approved by: _____

KYLE FUJIMOTO

COMPATIBLE ELECTRONICS INC.
114 OLINDA DRIVE
BREA, CALIFORNIA 92823
(714) 579-0500

DATE: NOVEMBER 1, 2022

	REPORT BODY	APPENDICES					TOTAL
		A	B	C	D	E	
PAGES	22	2	2	2	15	137	180

This report shall not be reproduced except in full, without the written approval of Compatible Electronics.



Brea Division
114 Olinda Drive
Brea, CA 92823
(714) 579-0500

Lake Forest Division
20621 Pascal Way
Lake Forest, CA 92630
(949) 587-0400

Newbury Park Division
1050 Lawrence Drive
Newbury Park, CA 91320
(805) 480-4044



TABLE OF CONTENTS

Section / Title	PAGE
GENERAL REPORT SUMMARY	4
SUMMARY OF TEST RESULTS	5
1. PURPOSE	6
1.1 DECISION RULE & RISK	6
2. ADMINISTRATIVE DATA	7
2.1 Location of Testing	7
2.2 Traceability Statement	7
2.3 Cognizant Personnel	7
2.4 Date Test Sample was Received	7
2.5 Disposition of the Test Sample	7
2.6 Abbreviations and Acronyms	7
3. APPLICABLE DOCUMENTS	8
4. DESCRIPTION OF TEST CONFIGURATION	9
4.1.1 Cable Construction and Termination	9
5. LISTS OF EUT, ACCESSORIES AND TEST EQUIPMENT	10
5.1 EUT and Accessory List	10
5.2 Emissions Test Equipment	11
6. TEST SITE DESCRIPTION	12
6.1 Test Facility Description	12
6.2 EUT Mounting, Bonding and Grounding	12
6.3 Measurement Uncertainty	12
7. CHARACTERISTICS OF THE TRANSMITTER	13
7.1 Channel Number and Frequencies	13
7.2 Antenna	13
8. TEST PROCEDURES	14
8.1 RF Emissions	14
8.1.1 Conducted Emissions Test	14
8.1.2 Radiated Emissions Test	15
8.1.3 RF Emissions Test Results	16
8.1.4 Sample Calculations	17
8.2 DTS Bandwidth	18
8.3 Maximum Peak Conducted Output Power	18
8.4 Emissions in Non-restricted Frequency Bands	19
8.5 RF Band Edges	19
8.6 Spectral Density Test	20
8.7 99 % Bandwidth	20
8.8 Duty Cycle Calculation	21
8.9 Variation of the Input Power	21
9. CONCLUSIONS	22

LIST OF APPENDICES

APPENDIX	TITLE
A	Laboratory Accreditations and Recognitions
B	Modifications to the EUT
C	Models Covered Under This Report
D	Diagrams and Charts <ul style="list-style-type: none"> • Test Setup Diagrams • Antenna and Effective Gain Factors
E	Data Sheets

LIST OF FIGURES

FIGURE	TITLE
1	Conducted Emissions Test Setup
2	Layout of the Semi-Anechoic Test Chamber

LIST OF TABLES

TABLE	TITLE
1	Conducted Emission Results
2	Radiated Emission Results



GENERAL REPORT SUMMARY

This electromagnetic emission test report is generated by Compatible Electronics Inc., which is an independent testing and consulting firm. The test report is based on testing performed by Compatible Electronics personnel according to the measurement procedures described in the test specifications given below and in the "Test Procedures" section of this report.

The measurement data and conclusions appearing herein relate only to the sample tested and this report may not be reproduced without the written permission of Compatible Electronics, unless done so in full.

This report must not be used by the client to claim product certification, approval or endorsement by NVLAP, NIST or any agency of the U.S. government.

Device Tested: Vivint ZigBee Bridge
Model: BB03
S/N: N/A

Product Description: The equipment under test is a Zigbee bridge that allows home devices that have a Zigbee wireless connection to be controlled via a computer or laptop.

Dimensions: 2.7 cm (H) x 7 cm (W) x 7 cm (L)

Clock(s): 32.768 kHz, 32 MHz, and 40 MHz

Modifications: The EUT was not modified in order to meet the specifications.

Customer: Vivint, Inc.
4931 N. 300 W.
Provo, Utah 84604

Test Dates: September 13, 15, 20, 21 and 22, 2022

Test Specification covered by accreditation:



Test Specifications: Emissions requirements
CFR Title 47, Part 15, Subpart B; and Subpart C, sections 15.205, 15.207, 15.209, and 15.247; RSS-247 and RSS-GEN

Test Procedures: ANSI C63.4 and ANSI C63.10

Test Deviations: The test procedure was not deviated from during the testing.



SUMMARY OF TEST RESULTS

TEST	DESCRIPTION	RESULTS
1	Conducted RF Emissions, 150 kHz - 30 MHz	Complies with the Class B limits of CFR Title 47, Part 15 Subpart B; the limits of CFR Title 47, Part 15, Subpart C, section 15.207; RSS-247 and RSS-GEN See section 6.3 for Measurement Uncertainty
2	Radiated RF Emissions, 9 kHz – 25000 MHz	Complies with the Class B limits of CFR Title 47, Part 15, Subpart B; and the limits of CFR Title 47, Part 15 Subpart C, 15.205, 15.209 and 15.247 (d); RSS-247 and RSS-GEN See section 6.3 for Measurement Uncertainty
3	DTS Bandwidth	Complies with the relevant requirements of CFR Title 47, Part 15, Subpart C, section 15.247 (a)(2); RSS-247
4	Peak Output Power	Complies with the relevant requirements of FCC Title 47, Part 15, Subpart C, section 15.247 (b)(3); RSS-247
5	RF Band Edges	Complies with the relevant requirements of FCC Title 47, Part 15, Subpart C, section 15.247 (d); RSS-247
6	Spectral Density	Complies with the relevant requirements of FCC Title 47, Part 15, Subpart C, section 15.247 (e); RSS-247



1. PURPOSE

This document is a qualification test report based on the emissions tests performed on the Vivint ZigBee Bridge, Model: BB03 (EUT). The emissions measurements were performed according to the measurement procedure described in ANSI C 63.4 and ANSI C 63.10. The tests were performed in order to determine whether the electromagnetic emissions from the equipment under test, referred to as EUT hereafter, are within the **Class B specification limits defined by CFR Title 47, Part 15, Subpart B; and Subpart C, sections 15.205, 15.207, 15.209, and 15.247; RSS-247 and RSS-Gen.**

1.1 DECISION RULE & RISK

If a measured value exceeds a specification limit it implies non-compliance. If the value is below a specification limit it implies compliance. Measurement uncertainty of the laboratory is reported with all measurement results but generally not taken into consideration unless a standard, rule or law requires it to be considered.

Qualification test reports are only produced for products that are in compliance with the test requirements, therefore results are always in conformity. Otherwise, an engineering report or just the data is provided to the customer.

When performing a measurement and making a statement of conformity, in or out-of-specification to manufacturer's specifications or Pass/Fail against a requirement, there are two possible outcomes:

- The result is reported as conforming with the specification
- The result is reported as not conforming with the specification

The decision rule is defined below.

When the test result is found to be below the limit but within our measurement uncertainty of the limit, it is our policy that the final acceptance decision is left to the customer, after discussing the implications and potential risks of the decision.

When the test result is found to be exactly on the specification, it is our policy, in the case of unwanted emissions measurements to consider the result non-compliant; however, the final decision is left to the customer, after discussing the implications and potential risks of the decision.

When the test result is found to be over the specification limit under any condition, it is our policy to consider the result non-compliant.

In terms of uncertainty of measurement, the laboratory is a calibrated and tightly controlled environment and generally exceptionally stable, the measurement uncertainties are evaluated without the consideration of the test sample. When it comes to the test sample however, as most testing is performed on a single sample rather than a sample population, and that sample is often a pre-production representation of the final product that test sample represents a significantly higher source of measurement uncertainty. We advise our customers of this and that when in doubt (small test to limit margins), they may wish to perform statistical sampling on a population to gain a higher confidence in the results. All lab reported results are that of a single sample in any event.



2. ADMINISTRATIVE DATA

2.1 Location of Testing

The emissions tests described herein were performed at the test facility of Compatible Electronics, 114 Olinda Drive, Brea, California 92823.

2.2 Traceability Statement

The calibration certificates of all test equipment used during the test are on file at the location of the test. The calibration is traceable to the National Institute of Standards and Technology (NIST).

2.3 Cognizant Personnel

Vivint, Inc.

Greg Hansen Regulatory Compliance Manager

Compatible Electronics Inc.

Kyle Fujimoto Sr. Test Engineer

James Ross Sr. Test Engineer

2.4 Date Test Sample was Received

The test sample was received prior to initial date of testing. Received as defined in product description.

2.5 Disposition of the Test Sample

The test sample has not been returned to Vivint, Inc. as of the date of this test report.

2.6 Abbreviations and Acronyms

The following abbreviations and acronyms may be used in this document.

EMI	Electromagnetic Interference
EUT	Equipment Under Test
P/N	Part Number
S/N	Serial Number
ITE	Information Technology Equipment
DoC	Declaration of Conformity
FCC	Federal Communications Commission
IC	Industry Canada
RSS	Radio Standards Specification
N/A	Not Applicable
Tx	Transmit
Rx	Receive
Inc.	Incorporated
RF	Radio Frequency
GND	Ground
LED	Light Emitting Diode



3. APPLICABLE DOCUMENTS

The following documents are referenced or used in the preparation of this emissions Test Report.

SPEC	TITLE
FCC Title 47, Part 15 Subpart C	FCC Rules – Radio frequency devices (including digital devices) – Intentional Radiators
FCC Title 47, Part 15 Subpart B	FCC Rules – Radio frequency devices (including digital devices) – Unintentional Radiators
558074 D01 DTS Meas Guidance v05r02	Guidance for Performing Compliance Measurements on Digital Transmissions Systems (DTS) Operating Under Section 15.247
EN 50147-2: 1997	Anechoic chambers. Alternative test site suitability with respect to site attenuation
ANSI C63.4: 2014	American National Standard for Methods of Measurement of Radio-Noise Emissions from Low-Voltage Electrical and Electronic Equipment in the Range of 9 kHz to 40 GHz
ANSI C63.10: 2013	American National Standard for Testing Unlicensed Wireless Devices
RSS Gen Issue 5: 2018 Amendment 1: 2019 Amendment 2: 2021	General Requirements for Compliance of Radio Apparatus
RSS-247 Issue 2: 2017	Digital Transmissions Systems (DTSS), Frequency Hopping Systems (FHSs) and License-Exempt Local Area Network (LE-LAN) Devices



4. DESCRIPTION OF TEST CONFIGURATION

The Vivint ZigBee Bridge, Model: BB03 (EUT) was tested connected to a router and an AC Adapter via its Ethernet and power ports, respectively. The router was also connected to a laptop and internet via its Ethernet ports. The router and laptop were placed 50 feet away from the EUT in an accessory room. A Zigbee light bulb was placed inside the test chamber, away from the EUT. The EUT was pinging the laptop while turning on and off the light via a Zigbee wireless connection. on a continuous basis. Note: The EUT respectively used its “Antenna 0” and “Antenna 1” during testing.

The EUT was is powered by 5 volts DC provided by an AC Adapter.

The EUT was tested for emissions while in the X, Y, and Z axis. The X orientation is when the EUT is parallel to the ground mounted horizontally. The Y orientation is when the EUT is perpendicular to the ground mounted vertically. The Z orientation is when the EUT is perpendicular to the ground mounted horizontally.

The firmware inside the EUT to continuously transmit at the low, middle, and high during the intentional radiator tests.

The firmware is stored on the company’s servers.

The radiated data was taken in the continuously exercising mode of operation. All initial investigations were performed with the EMI Receiver in manual mode scanning the frequency range continuously. The cables were bundled and routed as shown in the photographs in Appendix D.

4.1.1 Cable Construction and Termination

- Cable 1** This is a 2-meter braid cable connecting the EUT to the AC Adapter. The cable has a USB Type ‘A’ connector at the AC Adapter end and USB-C connector at the EUT end. The cable was bundled to a length of 1-meter. The shield of the cable was grounded to the chassis via the connectors.
- Cable 2** This is a 15.24-meter unshielded cable connecting the EUT to the router. The cable has an RJ-45 connector at each end.
- Cable 3** This is a 3-meter unshielded cable connecting the router to the internet. The cable has an RJ-45 connector at each end
- Cable 4** This is a 1-meter unshielded cable connecting the router to the laptop. The cable has an RJ-45 connector at each end.
- Cable 5** This is a 2-meter unshielded cable connecting laptop to the AC Adapter. The cable has a single pin connector at the laptop end and is hard wired into the AC Adapter.



5. LISTS OF EUT, ACCESSORIES AND TEST EQUIPMENT

5.1 EUT and Accessory List

EQUIPMENT	MANUFACTURER	MODEL NUMBER	SERIAL NUMBER	ID
VIVINT ZIGBEE BRIDGE (EUT)	VININT, INC.	BB03	N/A	FCC: 2AAAS-BB03 IC: 10941A-BB03
LAPTOP	HEWLETT PACKARD	HSTNN-C82C	N/A	N/A
AC ADAPTER FOR LAPTOP	HEWLETT PACKARD	HSTNN-DA40	N/A	N/A
ETHERNET ROUTER	NETGEAR	EN 108	ENT8114202	N/A
ZIGBEE LIGHTBULB	N/A	N/A	N/A	N/A
AC ADAPTER FOR EUT	LPS	NSA6UU-05012001	N/A	N/A
FIRMWARE*	UNIVERSAL ELECTRONICS, INC.	RADIO CONTROL CONSOLE	v4.6.2	N/A

*Only used to program the EUT to continuously transmit at the low, middle, and high channels



5.2 Emissions Test Equipment

EQUIPMENT TYPE	MANUFACTURER	MODEL NUMBER	SERIAL NUMBER	CAL. DATE	CAL. DUE DATE
RF RADIATED AND AC CONDUCTED EMISSIONS TEST EQUIPMENT					
TDK TestLab	TDK RF Solutions, Inc.	9.22	700145	N/A	N/A
EMI Receiver, 20 Hz – 26.5 GHz	Keysight Technologies, Inc.	N9038A	MY51210510	September 17, 2021	September 17, 2023
System Controller	Sunol Sciences Corporation	SC110V	112213-1	N/A	N/A
Turntable	Sunol Sciences Corporation	2011VS	N/A	N/A	N/A
Antenna-Mast	Sunol Sciences Corporation	TWR95-4	112213-3	N/A	N/A
Loop Antenna	Com-Power	AL-130R	121090	February 10, 2022	February 10, 2025
CombiLog Antenna	Com-Power	AC-220	61093	December 14, 2021	December 14, 2023
Preamplifier	Com-Power	PA-840	711013	April 8, 2022	April 8, 2024
Horn Antenna	Com-Power	AH-826	71957	N/A	N/A
Horn Antenna	Com-Power	AH-118	10050113	December 16, 2021	December 16, 2023
Preamplifier	Com-Power	PA-118	181653	March 7, 2022	March 7, 2023
Computer	Hewlett Packard	p6716f	MXX1030PX0	N/A	N/A
LISN (EUT)	Com-Power	LI-215A	191951	August 16, 2022	August 16, 2023
LISN (ACCY)	Com-Power	LI-215A	191952	August 16, 2022	August 16, 2023
Attenuator 10 dB	SureCall	SC-ATT-10	17100174	December 7, 2021	December 7, 2022
LCD Monitor	Hewlett Packard	52031a	3CQ046N3MG	N/A	N/A

6. TEST SITE DESCRIPTION

6.1 Test Facility Description

Please refer to section 2.1 of this report for emissions test location.

6.2 EUT Mounting, Bonding and Grounding

For frequencies 1 GHz and below: The EUT was mounted on a 0.6 by 1.2 meter non-conductive table 0.8 meters above the ground plane.

For frequencies above 1 GHz: The EUT was mounted on a 0.6 by 1.2 meter non-conductive table 1.5 meters above the ground plane.

For conducted AC emissions: The EUT was mounted on a 0.6 by 1.2 meter non-conductive table 0.8 meters above the ground plane.

The EUT was not grounded.

6.3 Measurement Uncertainty

“Compatible Electronics” U_{lab} value is less than U_{cispr} , thus based on this – compliance is deemed to occur if no measured disturbance exceeds the disturbance limit.

The uncertainty represents an expanded uncertainty expressed at approximately the 95% confidence level, using a coverage factor of $k=2$

$$u_c(y) = \sqrt{\sum_i c_i^2 u^2(x_i)}$$

Measurement		U_{cispr}	$U_{lab} = 2u_c(y)$
Conducted disturbance (mains port)	(150 kHz – 30 MHz)	3.4 dB	2.72 dB
Radiated disturbance (electric field strength on an open area test site or alternative test site)	(30 MHz – 1,000 MHz)	6.3 dB	3.32 dB (Vertical) 3.30 dB (Horizontal)
Radiated disturbance (electric field strength on an open area test site or alternative test site)	(1 GHz – 6 GHz)	5.2 dB	4.06 dB
Radiated disturbance (electric field strength on an open area test site or alternative test site)	(6 GHz – 18 GHz)	5.5 dB	4.06 dB
Radiated disturbance (electric field strength on an open area test site or alternative test site)	(18 GHz – 26 GHz)	N/A	4.43 dB
Radiated disturbance (electric field strength on an open area test site or alternative test site)	(26.5 GHz – 40 GHz)	N/A	4.57 dB



7. CHARACTERISTICS OF THE TRANSMITTER

The following sections describe the test methods and the specifications for the tests. Test results are also included in this section.

7.1 Channel Number and Frequencies

The EUT uses a total of 15 channels.

The low channel is 2405 MHz

The middle channel is 2440 MHz

The high channel is 2475 MHz

7.2 Antenna

The EUT utilizes two antennas, respectively.

Antenna 0: 3.06 dBi gain inverted "F" type PCB trace antenna

Antenna 1: 3.30 dBi gain inverted "F" type PCB trace antenna



8. TEST PROCEDURES

The following sections describe the test methods and the specifications for the tests. Test results are also included in this section.

8.1 RF Emissions

8.1.1 Conducted Emissions Test

The EMI Receiver was used as a measuring meter. A quasi-peak and/or average reading was taken only where indicated in the data sheets. A 10 dB attenuator used for the protection of the EMI Receiver input stage, and the offset was adjusted accordingly to read the actual data measured. The LISN output was measured using the EMI Receiver. The output of the second LISN was terminated by a 50-ohm termination. The effective measurement bandwidth used for this test was 9 kHz.

Please see section 6.2 of this report for mounting, bonding, and grounding of the EUT. The EUT was powered through the LISN, which was bonded to the ground plane. The LISN power was filtered and the filter was bonded to the ground plane. The EUT was set up with the minimum distances from any conductive surfaces as specified in ANSI 63:4. The excess power cord was wrapped in a figure eight pattern to form a bundle not exceeding 0.4 meters in length.

The conducted emissions from the EUT were maximized for operating mode as well as cable placement. The final data was collected under program control by computer software. The final qualification data is located in Appendix E.

Test Results:

The EUT complies with the **Class B** limits of CFR Title 47, Part 15 Subpart B; the limits of CFR Title 47, Part 15, Subpart C, Section 15.207; and RSS-Gen for conducted emissions.

8.1.2 Radiated Emissions Test

The EMI Receiver was used as the measuring meter. Above 1000 MHz, preamplifiers were used to increase the sensitivity of the instrument. The EMI Receiver was initially used with the Analyzer mode feature activated. In this mode, the EMI receiver can then record the actual frequency to be measured. This final reading is then taken accurately in the EMI Receiver mode, which takes into account the cable loss, amplifier gain and antenna factors, so that a true reading is compared to the true limit. The effective measurement bandwidth used for the radiated emissions test was according to the frequency measured.

The frequencies below 1 GHz were quasi-peaked using the quasi-peak detector of the EMI Receiver.

The frequencies above 1 GHz were averaged using the duty cycle correction factor in section 8.8 of this test report.

The EMI test chamber of Compatible Electronics, Inc. was used for radiated emissions testing. This test site is in full compliance with ANSI C63.4 and ANSI C63.10. Please see section 6.2 of this report for mounting, bonding and grounding of the EUT. The turntable supporting the EUT is remote controlled using a motor. The turntable permits EUT rotation of 360 degrees in order to maximize emissions. Also, the antenna mast allows height variation of the antenna from 1 meter to 4 meters. Data was collected in the worst case (highest emission) configuration of the EUT. At each reading, the EUT was rotated 360 degrees and the antenna height was varied from 1 to 4 meters (for E field radiated field strength). The gunsight method was used when measuring with the horn antenna in order to ensure accurate results.

The EUT was tested at a 3-meter test distance. The six highest emissions are listed in Table 1.

The measurement bandwidths and transducers used for the radiated emissions test were:

FREQUENCY RANGE	EFFECTIVE MEASUREMENT BANDWIDTH	TRANSDUCER
9 kHz to 150 kHz	200 Hz	Loop Antenna
150 kHz to 30 MHz	9 kHz	Loop Antenna
30 MHz to 1 GHz	120 kHz	CombiLog Antenna
1 GHz to 25 GHz	1 MHz	Horn Antenna

Test Results:

The EUT complies with the **Class B** limits of CFR Title 47, Part 15, Subpart B; the limits of CFR Title 47, Part 15, Subpart C sections 15.205, 15.209 and 15.247; and the limits of RSS-247 and RSS-Gen for radiated emissions.



8.1.3 RF Emissions Test Results

Table 1 CONDUCTED EMISSION RESULTS
Vivint ZigBee Bridge
Model: BB03

Frequency (MHz)	Average Emission Level* (dB μ V/m)	Average Specification Limit (dB μ V/m)	Delta (Emission – Spec limit) (dB)
0.362 (BL)	41.20	48.62	-7.41
0.378 (BL)	40.78	48.34	-7.56
0.358 (BL)	40.89	48.62	-7.73
0.374 (BL)	40.02	48.27	-8.25
0.370 (WL)	36.84	48.33	-11.49
0.222 (WL)	35.41	52.70	-17.30

Table 2 RADIATED EMISSION RESULTS
Vivint ZigBee Bridge
Model: BB03

Frequency (MHz)	EMI Reading (dB μ V/m)	Specification Limit (dB μ V/m)	Delta (Cor. Reading – Spec. Limit) (dB)
73.80 (V) (Spurious Emission) (ANT-0)	35.23 (QP)	40.00	-4.77
58.70 (V) (Spurious Emission) (ANT-0)	34.82 (QP)	40.00	-5.18
51.30 (V) (Spurious Emission) (ANT-0)	34.01 (QP)	40.00	-5.99
51.90 (V) (Spurious Emission) (ANT-0)	32.81 (QP)	40.00	-7.19
2483.50 (H) (BE) (HC) (ANT-1) (X-Axis)	44.63 (AV)	53.97	-9.34
60.20 (V) (Spurious Emission) (ANT-0)	29.87 (QP)	40.00	-10.13

Notes: * The complete emissions data is given in Appendix E of this report.

(BL) Black Lead
(WL) White Lead
(V) Vertical
(H) Horizontal
(QP) Quasi-Peak
(AV) Average
(BE) Band Edge
(ANT-0) Antenna “0”
(ANT-1) Antenna “1”
(HC) High Channel



8.1.4 Sample Calculations

A correction factor for the antenna, cable and a distance factor (if any) must be applied to the meter reading before a true field strength reading can be obtained. This Corrected Meter Reading is then compared to the specification limit in order to determine compliance with the limits.

Conversion to logarithmic terms: Specification limit ($\mu\text{V}/\text{m}$) $\log \times 20 =$ Specification Limit in dBuV/m

To correct for distance when measuring at a distance other than the specification

For measurements below 30 MHz: (Specification distance / test distance) $\log \times 40 =$ distance factor

For measurements above 30 MHz: (Specification distance / test distance) $\log \times 20 =$ distance factor

Note: When using an Active Antenna, the Antenna factor shall be subtracted due to the combination of the internal amplification and antenna loss.

Corrected Meter Reading = meter reading + F – A + C

where: F = antenna factor

A = amplifier gain

C = cable loss

The correction factors for the antenna and the amplifier gain are attached in Appendix D of this report. The data sheets are attached in Appendix E.

The distance factor D is 0 when the test is performed at the required specification distance.



8.2 DTS Bandwidth

The DTS Bandwidth was measured using the EMI Receiver. The following steps were performed for measuring the DTS Bandwidth.

1. Set RBW = 100 kHz
2. Set the video bandwidth (VBW) to equal or greater than 3 times the RBW
3. Detector = Peak
4. Trace Mode = Max Hold
5. Sweep = Auto Couple
6. Allow the trace to stabilize
7. Measure the maximum width of the emission that is constrained by the frequencies associated with the two outermost amplitude points (upper and lower frequencies) that are attenuated by 6 dB relative to the maximum level measured in the fundamental emission.

Test Results:

The EUT complies with the relevant requirements of FCC Title 47, Part 15, Subpart C section 15.247 (a)(2); and RSS-247.

8.3 Maximum Peak Conducted Output Power

The Maximum Peak Conducted Output Power was measured using the EMI Receiver. The Maximum Peak Conducted Output Power was measured using the procedure described in section 11.9.1.1 of ANSI C63.10. The Maximum Peak Conducted Output Power was then taken. The following steps were performed for measuring the Maximum Peak Conducted Output Power.

1. Set the RBW \geq DTS bandwidth
2. Set VBW \geq [3 x RBW]
3. Set span \geq [3 x RBW]
4. Sweep time = auto couple
5. Detector = peak
6. Trace mode = max hold
7. Allow trace to fully stabilize
8. Use peak marker function to determine the peak amplitude level

Test Results:

The EUT complies with the relevant requirements of FCC Title 47, Part 15, Subpart C section 15.247 (b)(3); and RSS-247.



8.4 Emissions in Non-restricted Frequency Bands

The emissions in the non-restricted frequency bands measurements were performed using the EMI receiver directly connected to the EUT. The reference level was established by setting the instrument center frequency to the DTS channel center frequency. The span was set to ≥ 1.5 times the DTS bandwidth. The RBW was set to 100 kHz and the VBW was set to 300 kHz. A peak detector was used with sweep set to auto. A max hold trace was used and allowed to fully stabilize. The peak marker function was used to determine the reference level. For emission level measurement, the center frequency and span were set to encompass the frequency range to be measured. The RBW was set to 100 kHz and the VBW was set to 300 kHz. A peak detector was used with a sweep time set to auto. The number of measurement points were greater than the span/RBW. A max hold trace was used and allowed to fully stabilize. The peak marker function was used to determine the maximum amplitude level. The final qualification data sheets are located in Appendix E.

Test Results:

The EUT complies with the relevant requirements of FCC Title 47, Part 15, Subpart C section 15.247 (d); and RSS-247.

8.5 RF Band Edges

The RF band edges were taken at 2390 MHz when the EUT was on the low channel and 2483.5 MHz when the EUT was on the high channel using the EMI Receiver. A preamplifier was used to boost the signal level, with the plots being taken at a 3 meter test distance. The radiated emissions test procedure as describe in section 8.1.2 of this test report was used to maximize the emission.

Test Results:

The EUT complies with the relevant requirements of FCC Title 47, Part 15, Subpart C section 15.247 (d); and RSS-247. The RF power at the restricted bands closest to the band edges at 2390 MHz and 2483.5 MHz also meet the limits of section 15.209. Please see the data sheets located in Appendix E.



8.6 Spectral Density Test

The spectrum density output was measured using the EMI Receiver. The spectral density output was measured using a direct connection from the RF out on the EUT into the input of the EMI Receiver. The following steps were performed for measuring the spectral density.

1. Set analyzer center frequency to DTS channel center frequency
2. Set the span to 1.5 times the OBW.
3. Set the RBW to $3 \text{ kHz} \leq \text{RBW} \leq 100 \text{ kHz}$
4. Set the VBW $\geq [3 \times \text{RBW}]$
5. Detector = peak
6. Sweep time = auto couple
7. Trace mode = max hold
8. Allow the trace to fully stabilize.
9. Use the peak marker function to determine the maximum amplitude level within the RBW
10. If measured value exceeds limit, reduce RBW (no less than 3 kHz) and repeat.

Test Results:

The EUT complies with the relevant requirements of FCC Title 47, Part 15, Subpart C section 15.247 (e); and RSS-247.

8.7 99 % Bandwidth

The 99 % bandwidth was measured using an EMI Receiver.

The following steps were performed for measuring the 99 % bandwidth per RSS-GEN, Issue 5, clause 6.7:

1. Set RBW to 1 % to 5 % of the actual occupied bandwidth.
2. Set VBW to greater than 3 times the RBW.
3. Set the EMI Receiver to the occupied bandwidth Function set at 99 %
4. Set the peak detector to max hold.
5. Set the sweep time to auto
6. Allow the trace to stabilize.

Please note that this was only used to determine the emission bandwidth and that there are no limits or pass/fail criteria for this test. Please see the data sheets located in Appendix E.

8.8 Duty Cycle Calculation

The EMI Receiver was used to obtain the final test data. The final qualification data sheets are located in Appendix E.

Where

$$\delta(\text{dB}) = 20 \log \left[\frac{\sum (nt_1 + mt_2 + \dots + \xi t_x)}{T} \right]$$

n is the number of pulses of duration t_1

m is the number of pulses of duration t_2

ξ is the number of pulses of duration t_x

T is the period of the pulse train or 100 ms if the pulse train length is greater than 100 ms

The worst case was when the EUT was in light off data mode

Duty Cycle Correction Factor = -11.76 dB

Total On Time = 25.8 ms

Duty Cycle = 25.8 ms / 100 ms = 0.258 = 25.8 %

The peak to average ratio is -11.76 dB

8.9 Variation of the Input Power

The variation of the input power test was performed using the EMI Receiver. The EUT input power was varied between 85 % and 115 % of the nominal rated supply voltage. The carrier frequency was monitored for any change in amplitude.

Test Results:

The EUT complies with the relevant requirements of FCC Title 47, Part 15, Subpart A section 15.31 (e); and RSS-GEN. The variation of the input voltage was varied from 85 % to 115 % and did not change the amplitude nor the frequency of the fundamental emissions.



9. CONCLUSIONS

The Vivint ZigBee Bridge, Model: BB03 (EUT), as tested, meets all of the specification limits defined in CFR Title 47, Part 15, Subpart B; and Subpart C, sections 15.205, 15.207, 15.209, and 15.247; RSS-GEN and RSS-247.





APPENDIX A

LABORATORY ACCREDITATIONS AND RECOGNITIONS

Brea Division
114 Olinda Drive
Brea, CA 92823
(714) 579-0500

Lake Forest Division
20621 Pascal Way
Lake Forest, CA 92630
(949) 587-0400

Newbury Park Division
1050 Lawrence Drive
Newbury Park, CA 91320
(805) 480-4044

LABORATORY ACCREDITATIONS AND RECOGNITIONS



For US, Canada, Australia/New Zealand, Japan, Taiwan, Korea, and the European Union, Compatible Electronics is currently accredited by NVLAP to ISO/IEC 17025.

For the most up-to-date version of our scopes and certificates please visit

<http://celectronics.com/quality/scope/>

Quote from ISO-ILAC-IAF Communiqué on the Management Systems Requirements of ISO/IEC 17025, General Requirements for the competence of testing and calibration laboratories:

"A laboratory's fulfilment of the requirements of ISO/IEC 17025 means the laboratory meets both the technical competence requirements and management system requirements that are necessary for it to consistently deliver technically valid test results and calibrations. The management system requirements in ISO/IEC 17025 are written in language relevant to laboratory operations and operate generally in accordance with the principles of ISO 9001"

ISED Test Site Registration Number: 2154A



APPENDIX B

MODIFICATIONS TO THE EUT



MODIFICATIONS TO THE EUT

The modifications listed below were made to the EUT to pass FCC Subpart B and FCC 15.247; RSS-GEN and RSS-247 specifications.

All the rework described below was implemented during the test in a method that could be reproduced in all the units by the manufacturer.

No modifications were made to the EUT during the testing.





APPENDIX C

***MODELS COVERED
UNDER THIS REPORT***



MODELS COVERED UNDER THIS REPORT

USED FOR THE PRIMARY TEST

Vivint ZigBee Bridge

Model: BB03

S/N: N/A

There are no additional models covered under this report.





APPENDIX D

DIAGRAMS AND CHARTS



FIGURE 1: CONDUCTED EMISSIONS TEST SETUP

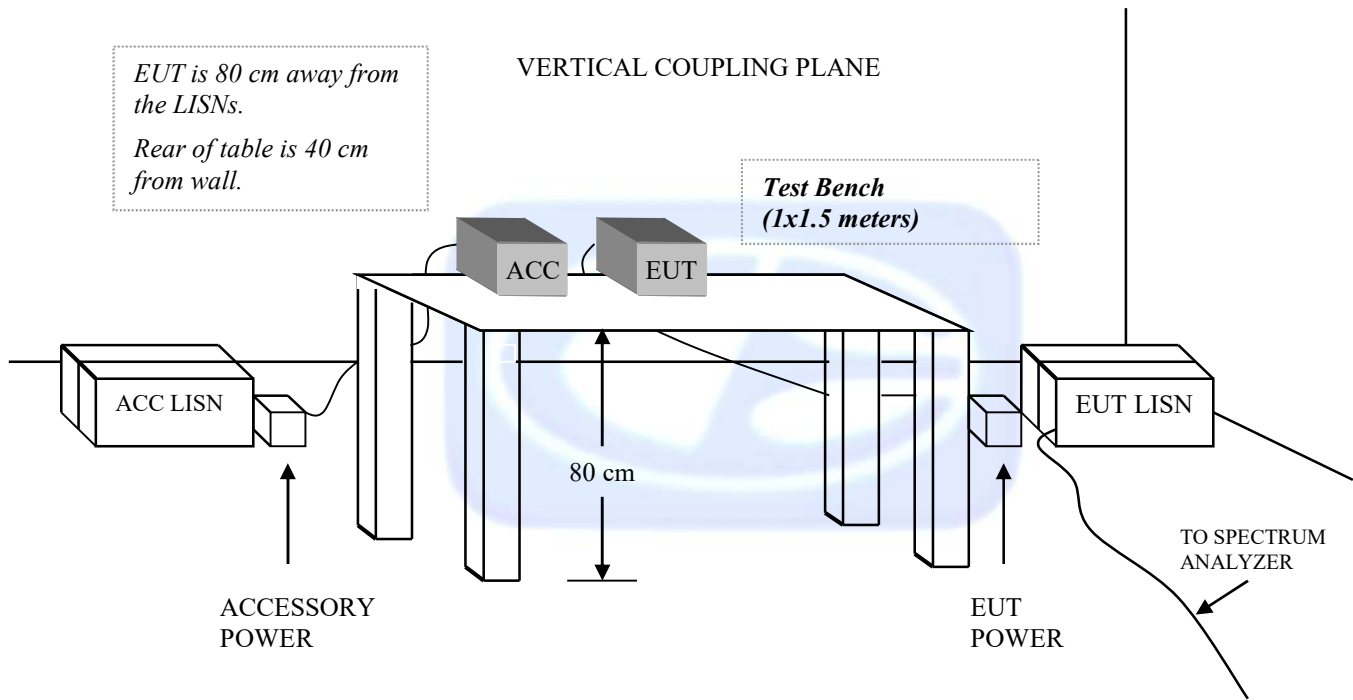
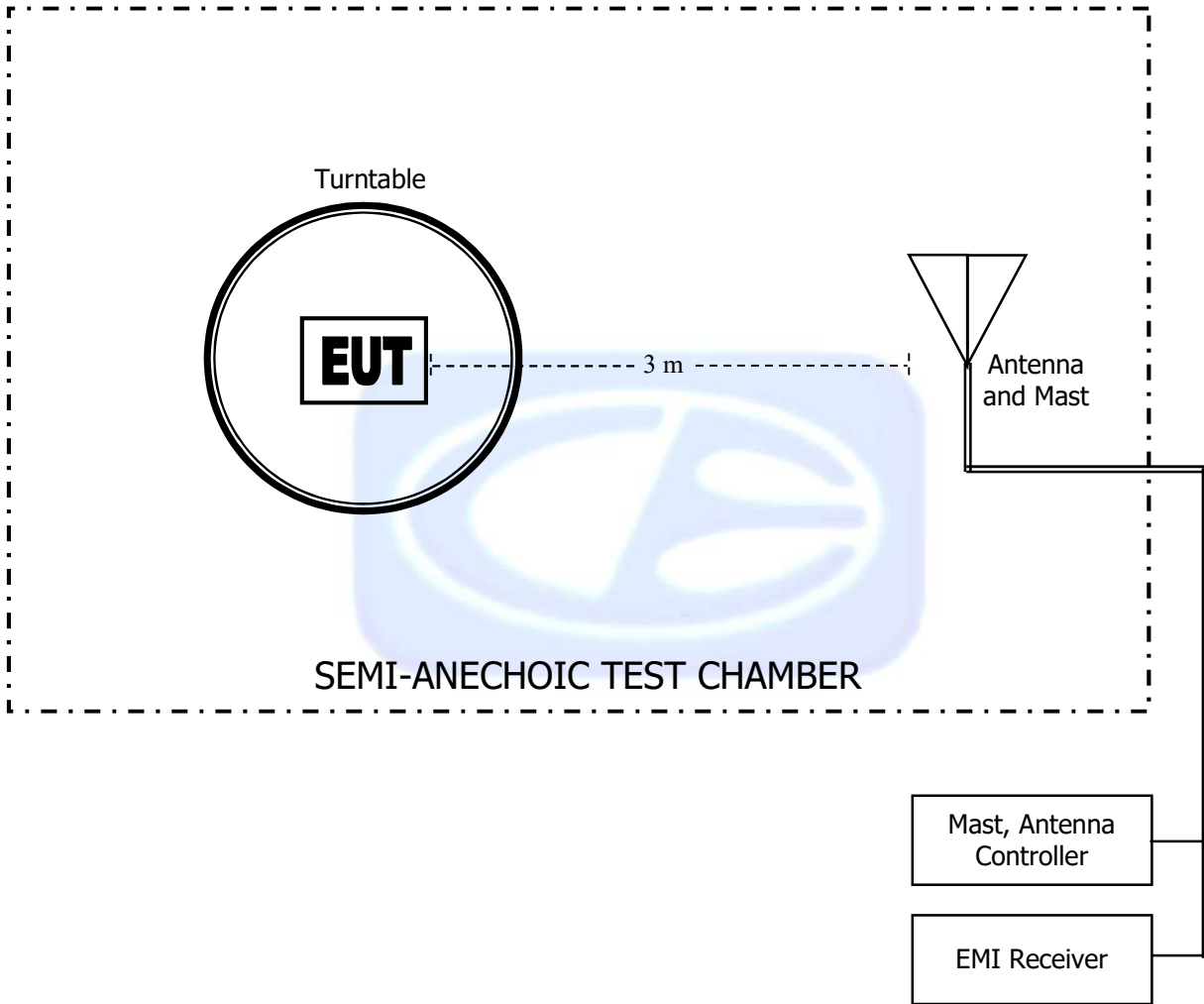

FIGURE 2: LAYOUT OF THE SEMI-ANECHOIC TEST CHAMBER





COM-POWER AL-130R

LOOP ANTENNA

S/N: 121090

CALIBRATION DATE: FEBRUARY 10, 2022

FREQUENCY (MHz)	MAGNETIC (dB/m)	ELECTRIC (dB/m)
0.009	15.6	-35.8
0.01	15.8	-35.6
0.02	14.8	-36.6
0.03	15.6	-35.9
0.04	15.0	-36.5
0.05	14.4	-37.1
0.06	14.6	-36.9
0.07	14.3	-37.2
0.08	14.3	-37.2
0.09	14.4	-37.0
0.10	14.1	-37.4
0.20	14.1	-37.4
0.30	14.0	-37.5
0.40	13.9	-37.6
0.50	14.1	-37.3
0.60	14.1	-37.3
0.70	14.2	-37.3
0.80	14.2	-37.3
0.90	14.2	-37.2
1.00	14.4	-37.0
2.00	14.6	-36.9
3.00	14.6	-36.8
4.00	14.9	-36.6
5.00	14.9	-36.7
6.00	14.8	-36.7
7.00	14.6	-36.8
8.00	14.5	-37.0
9.00	14.3	-37.2
10.00	14.5	-37.0
11.00	14.6	-36.9
12.00	14.7	-36.7
13.00	14.9	-36.6
14.00	15.0	-36.5
15.00	14.9	-36.6
16.00	14.9	-36.6
17.00	14.6	-36.8
18.00	14.4	-37.1
19.00	14.5	-37.0
20.00	14.5	-37.0
21.00	14.2	-37.3
22.00	13.9	-37.5
23.00	13.9	-37.5
24.00	13.8	-37.7
25.00	13.4	-38.0
26.00	13.2	-38.2
27.00	13.2	-38.3
28.00	12.7	-38.7
29.00	12.7	-38.8
30.00	12.4	-39.0

Brea Division
114 Olinda Drive
Brea, CA 92823
(714) 579-0500

Lake Forest Division
20621 Pascal Way
Lake Forest, CA 92630
(949) 587-0400

Newbury Park Division
1050 Lawrence Drive
Newbury Park, CA 91320
(805) 480-4044



COM-POWER AC-220

COMBILOG ANTENNA

S/N: 61093

CALIBRATION DATE: DECEMBER 14, 2021

FREQUENCY (MHz)	FACTOR (dB)	FREQUENCY (MHz)	FACTOR (dB)
30	22.50	200	16.00
35	21.40	250	17.40
40	21.00	300	19.70
45	20.60	350	20.00
50	19.70	400	22.20
60	16.10	450	22.40
70	12.80	500	23.10
80	12.50	550	23.40
90	14.20	600	24.90
100	15.40	650	25.30
120	16.50	700	25.40
125	16.80	750	26.40
140	15.90	800	26.70
150	16.60	850	27.10
160	18.50	900	27.90
175	15.90	950	28.00
180	15.50	1000	28.00



COM POWER AH-118

HORN ANTENNA

S/N: 10050113

CALIBRATION DATE: DECEMBER 16, 2021

FREQUENCY (GHz)	FACTOR (dB)	FREQUENCY (GHz)	FACTOR (dB)
1.0	23.86	10.0	38.91
1.5	25.67	10.5	39.94
2.0	28.25	11.0	39.10
2.5	29.17	11.5	39.70
3.0	29.78	12.0	40.29
3.5	30.88	12.5	41.93
4.0	31.21	13.0	41.34
4.5	32.96	13.5	40.57
5.0	33.30	14.0	40.23
5.5	34.24	14.5	42.25
6.0	34.57	15.0	43.63
6.5	35.61	15.5	39.96
7.0	36.60	16.0	40.38
7.5	37.49	16.5	40.56
8.0	37.44	17.0	40.93
8.5	37.98	17.5	42.27
9.0	38.01	18.0	43.77
9.5	38.53		



COM-POWER AH-826

HORN ANTENNA

S/N: 71957

FREQUENCY (GHz)	FACTOR (dB)	FREQUENCY (GHz)	FACTOR (dB)
18.0	33.5	22.5	35.5
18.5	33.5	23.0	35.9
19.0	34.0	23.5	35.7
19.5	34.0	24.0	35.6
20.0	34.3	24.5	36.0
20.5	34.9	25.0	36.2
21.0	34.7	25.5	36.1
21.5	35.0	26.0	36.2
22.0	35.0	26.5	35.7



COM-POWER PA-118

PREAMPLIFIER

S/N: 181653

CALIBRATION DATE: MARCH 7, 2022

FREQUENCY (GHz)	FACTOR (dB)	FREQUENCY (GHz)	FACTOR (dB)
1.0	40.02	6.0	38.84
1.1	39.72	6.5	39.20
1.2	39.93	7.0	39.46
1.3	39.98	7.5	39.67
1.4	39.99	8.0	39.28
1.5	40.20	8.5	38.63
1.6	40.05	9.0	38.96
1.7	40.15	9.5	39.33
1.8	40.20	10.0	39.58
1.9	40.33	11.0	38.25
2.0	40.33	12.0	40.03
2.5	40.60	13.0	40.55
3.0	40.76	14.0	40.36
3.5	40.87	15.0	39.34
4.0	40.39	16.0	37.34
4.5	39.55	17.0	42.14
5.0	40.34	18.0	42.54
5.5	39.45		



COM-POWER PA-840

MICROWAVE PREAMPLIFIER

S/N: 711013

CALIBRATION DATE: APRIL 8, 2022

FREQUENCY (GHz)	FACTOR (dB)
18.0	24.85
19.0	24.25
20.0	22.69
21.0	22.17
22.0	22.78
23.0	23.23
24.0	23.72
25.0	24.13
26.0	24.28
26.5	25.06

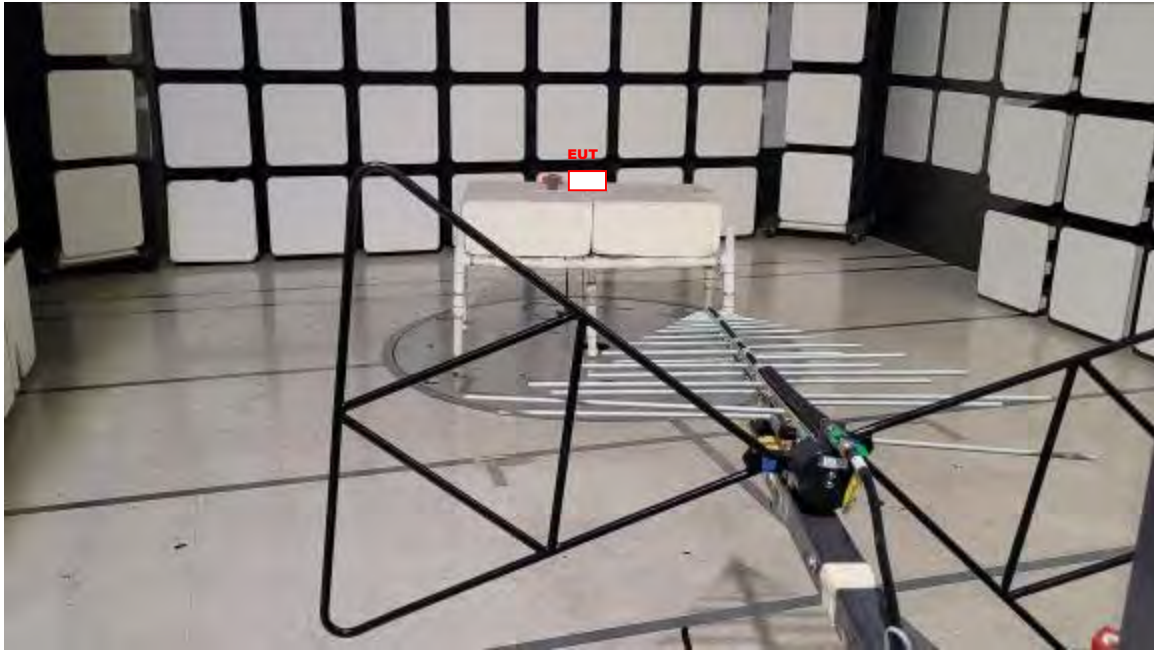

FRONT VIEW

VIVINT, INC.

VIVINT ZIGBEE BRIDGE

MODEL: BB03

FCC SUBPART B AND C; RSS-GEN and RSS-247 – RADIATED EMISSIONS – BELOW 1 GHz

**PHOTOGRAPH SHOWING THE EUT CONFIGURATION
FOR MAXIMUM EMISSIONS**

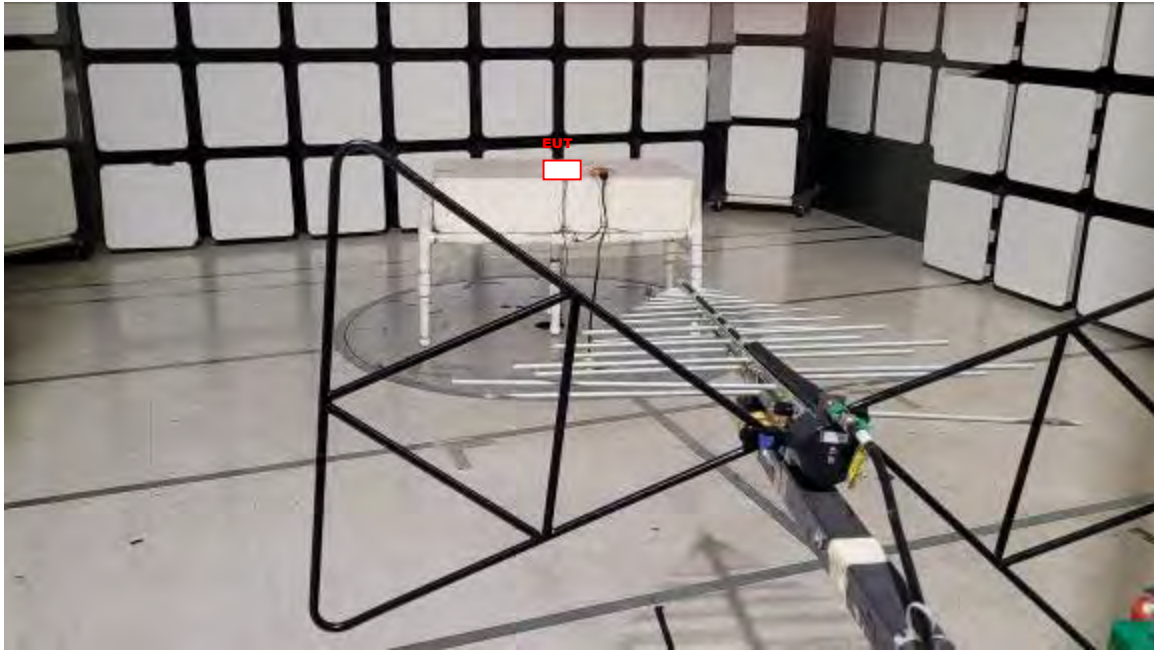

REAR VIEW

VIVINT, INC.

VIVINT ZIGBEE BRIDGE

MODEL: BB03

FCC SUBPART B AND C; RSS-GEN and RSS-247 – RADIATED EMISSIONS – BELOW 1 GHz

**PHOTOGRAPH SHOWING THE EUT CONFIGURATION
FOR MAXIMUM EMISSIONS**

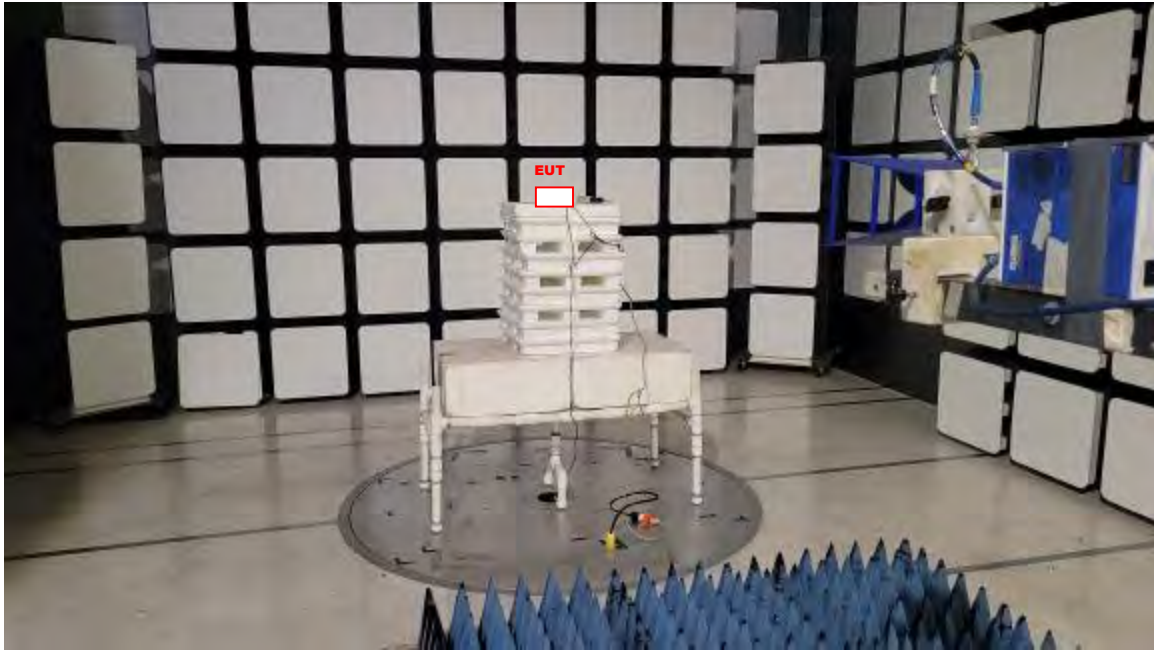

FRONT VIEW

VIVINT, INC.

VIVINT ZIGBEE BRIDGE

MODEL: BB03

FCC SUBPART B AND C; RSS-GEN and RSS-247 – RADIATED EMISSIONS – ABOVE 1 GHz

**PHOTOGRAPH SHOWING THE EUT CONFIGURATION
FOR MAXIMUM EMISSIONS**



REAR VIEW

VIVINT, INC.

VIVINT ZIGBEE BRIDGE

MODEL: BB03

FCC SUBPART B AND C; RSS-GEN and RSS-247 – RADIATED EMISSIONS – ABOVE 1 GHz

**PHOTOGRAPH SHOWING THE EUT CONFIGURATION
FOR MAXIMUM EMISSIONS**



FRONT VIEW

VIVINT, INC.
VIVINT ZIGBEE BRIDGE
MODEL: BB03
FCC SUBPART B AND C; AND RSS-GEN
AC CONDUCTED EMISSIONS

**PHOTOGRAPH SHOWING THE EUT CONFIGURATION
FOR MAXIMUM EMISSIONS**



REAR VIEW

VIVINT, INC.
VIVINT ZIGBEE BRIDGE
MODEL: BB03
FCC SUBPART B AND C; AND RSS-GEN
AC CONDUCTED EMISSIONS

**PHOTOGRAPH SHOWING THE EUT CONFIGURATION
FOR MAXIMUM EMISSIONS**





***RADIATED EMISSIONS
DATA SHEETS***

Brea Division
114 Olinda Drive
Brea, CA 92823
(714) 579-0500

Lake Forest Division
20621 Pascal Way
Lake Forest, CA 92630
(949) 587-0400

Newbury Park Division
1050 Lawrence Drive
Newbury Park, CA 91320
(805) 480-4044



***30 MHz to 1000 MHz
SPURIOUS EMISSIONS
(WORST CASE)
DATA SHEETS***



FCC Part 15 Subpart B and C; FCC Section 15.247; RSS-247; and RSS-GEN Test Report

Vivint ZigBee Bridge

Model: BB03

Title: Pre-Scan - FCC Class B
File: 1 - Pre-Scan - FCC Class B - 09-13-2022.set
Operator: Kyle Fujimoto
EUT Type: Vivint Zigbee Bridge
EUT Condition: EUT Connected to Ethernet and Turning on and off an LED Zigbee bulb every 2 seconds
Company: Vivint, Inc.
Model: BB03
Antenna # 0 (Worst Case)

9/13/2022 10:25:04 AM
Sequence: Preliminary Scan

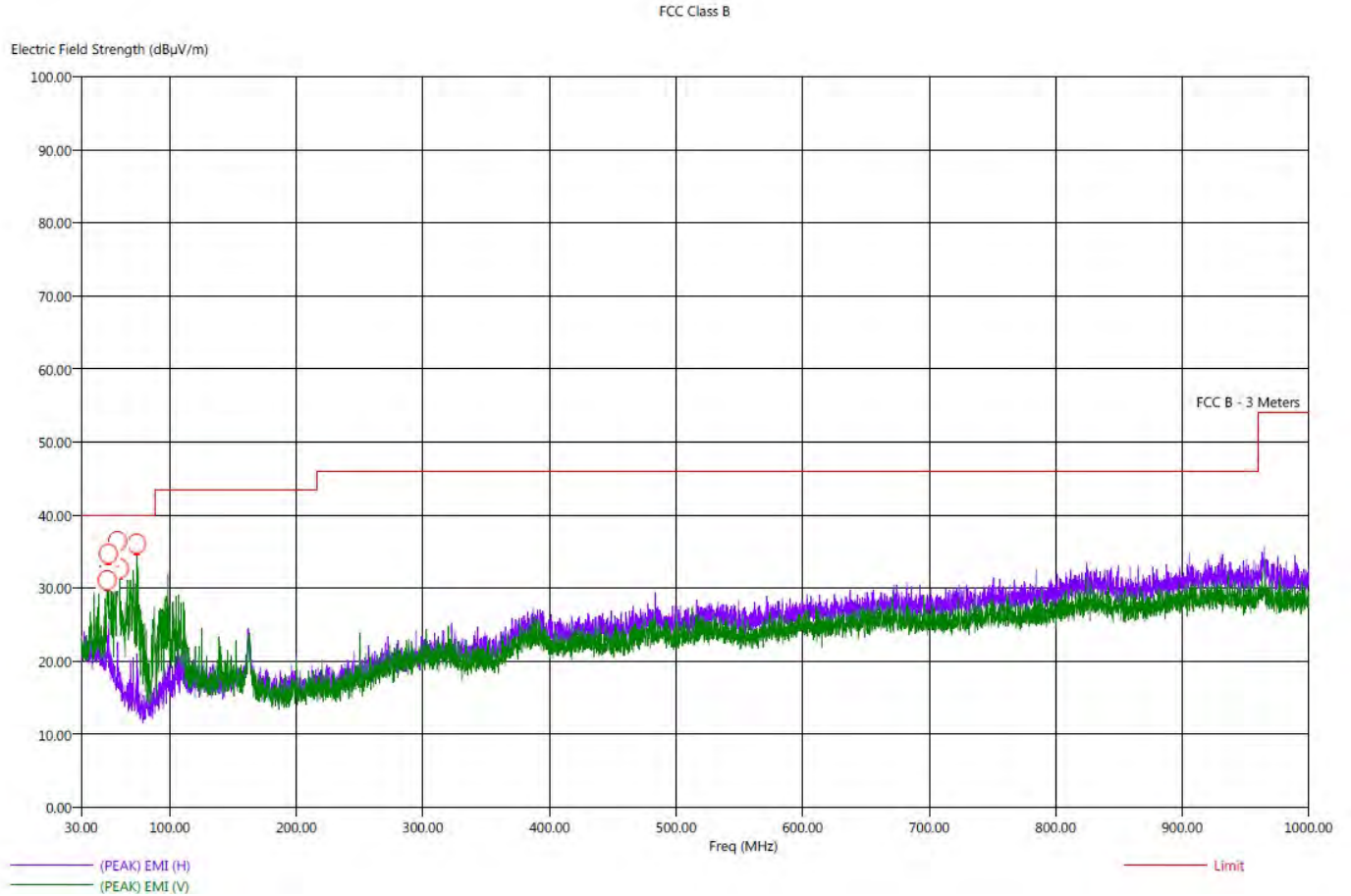

Brea Division
114 Olinda Drive
Brea, CA 92823
(714) 579-0500

Lake Forest Division
20621 Pascal Way
Lake Forest, CA 92630
(949) 587-0400

Newbury Park Division
1050 Lawrence Drive
Newbury Park, CA 91320
(805) 480-4044



FCC Part 15 Subpart B and C; FCC Section 15.247; RSS-247; and RSS-GEN Test Report

Vivint ZigBee Bridge

Model: BB03

Title: Radiated Final - FCC Class B
 File: 1 - Final Scan - FCC Class B - 09-13-2022.set
 Operator: Kyle Fujimoto
 EUT Type: Vivint Zigbee Bridge
 EUT Condition: EUT Connected to Ethernet and Turning on and off an LED Zigbee bulb every 2 seconds
 Company: Vivint, Inc.
 Model: BB03
 Antenna # 0 (Worst Case)

9/13/2022 10:45:01 AM
 Sequence: Final Measurements

FCC Class B

Freq (MHz)	Pol	(PEAK) EMI (dBµV/m)	(QP) EMI (dBµV/m)	(PEAK) Margin (dB)	(QP) Margin (dB)	Limit (dBµV/m)	Transducer (dB)	Cable (dB)	Ttbl Agl (deg)	Twr Ht (cm)
50.50	V	32.59	29.57	-7.41	-10.43	40.00	19.57	0.53	26.00	381.91
51.30	V	37.41	34.01	-2.59	-5.99	40.00	19.35	0.54	146.00	111.16
51.90	V	35.58	32.81	-4.42	-7.19	40.00	19.24	0.54	156.25	143.04
58.70	V	39.87	34.82	-0.13	-5.18	40.00	16.60	0.57	40.25	159.04
60.20	V	37.37	29.87	-2.63	-10.13	40.00	15.99	0.58	30.25	111.58
73.80	V	37.89	35.23	-2.11	-4.77	40.00	12.32	0.64	30.25	127.16



Brea Division
 114 Olinda Drive
 Brea, CA 92823
 (714) 579-0500

Lake Forest Division
 20621 Pascal Way
 Lake Forest, CA 92630
 (949) 587-0400

Newbury Park Division
 1050 Lawrence Drive
 Newbury Park, CA 91320
 (805) 480-4044



***TRANSMIT HARMONICS
USING “ANTENNA 0”
DATA SHEETS***

Brea Division
114 Olinda Drive
Brea, CA 92823
(714) 579-0500

Lake Forest Division
20621 Pascal Way
Lake Forest, CA 92630
(949) 587-0400

Newbury Park Division
1050 Lawrence Drive
Newbury Park, CA 91320
(805) 480-4044

**FCC 15.247**

Vivint, Inc.
Vivint Zigbee Bridge
Model: BB03

Date: 09/13/2022
Lab: D
Tested By: Kyle Fujimoto

Harmonics - Low Channel
Transmit Mode - X-Axis - Antenna 0

Freq. (MHz)	Level (dBuV/m)	Pol (v/h)	Limit	Margin	Peak / QP / Avg	Table Angle (deg)	Ant. Height (cm)	Comments
4810.00	41.69	V	73.97	-32.28	Peak	258.00	158.98	
4810.00	29.93	V	53.97	-24.04	Avg	258.00	158.98	
7215.00								Not in Restricted Band
7215.00								Done via Conducted
9620.00								Not in Restricted Band
9620.00								Done via Conducted
12025.00	46.78	V	73.97	-27.19	Peak	285.00	111.34	
12025.00	35.02	V	53.97	-18.95	Avg	285.00	111.34	
14430.00								No Emission Detected
14430.00								
16835.00								No Emission Detected
16835.00								
19240.00								No Emission Detected
19240.00								
21645.00								No Emission Detected
21645.00								
24050.00								No Emission Detected
24050.00								

**FCC 15.247**

Vivint, Inc.
Vivint Zigbee Bridge
Model: BB03

Date: 09/13/2022
Lab: D
Tested By: Kyle Fujimoto

Harmonics - Low Channel
Transmit Mode - Y-Axis - Antenna 0

Freq. (MHz)	Level (dBuV/m)	Pol (v/h)	Limit	Margin	Peak / QP / Avg	Table Angle (deg)	Ant. Height (cm)	Comments
4810.00	41.69	V	73.97	-32.28	Peak	29.50	113.49	
4810.00	29.93	V	53.97	-24.04	Avg	29.50	113.49	
7215.00								Not in Restricted Band
7215.00								Done via Conducted
9620.00								Not in Restricted Band
9620.00								Done via Conducted
12025.00	47.04	V	73.97	-26.93	Peak	133.00	208.11	
12025.00	35.28	V	53.97	-18.69	Avg	133.00	208.11	
14430.00								No Emission Detected
14430.00								Detected
16835.00								No Emission Detected
16835.00								Detected
19240.00								No Emission Detected
19240.00								Detected
21645.00								No Emission Detected
21645.00								Detected
24050.00								No Emission Detected
24050.00								Detected

**FCC 15.247**

Vivint, Inc.
Vivint Zigbee Bridge
Model: BB03

Date: 09/13/2022

Lab: D

Tested By: Kyle Fujimoto

Harmonics - Low Channel
Transmit Mode - Z-Axis - Antenna 0

Freq. (MHz)	Level (dBuV/m)	Pol (v/h)	Limit	Margin	Peak / QP / Avg	Table Angle (deg)	Ant. Height (cm)	Comments
4810.00	41.19	V	73.97	-32.78	Peak	305.50	158.74	
4810.00	29.43	V	53.97	-24.54	Avg	305.50	158.74	
7215.00								Not in Restricted Band
7215.00								Done via Conducted
9620.00								Not in Restricted Band
9620.00								Done via Conducted
12025.00	46.05	V	73.97	-27.92	Peak	235.00	223.22	
12025.00	34.29	V	53.97	-19.68	Avg	235.00	223.22	
14430.00								No Emission Detected
14430.00								
16835.00								No Emission Detected
16835.00								
19240.00								No Emission Detected
19240.00								
21645.00								No Emission Detected
21645.00								
24050.00								No Emission Detected
24050.00								

**FCC 15.247**

Vivint, Inc.
Vivint Zigbee Bridge
Model: BB03

Date: 09/13/2022
Lab: D
Tested By: Kyle Fujimoto

Harmonics - Low Channel
Transmit Mode - X-Axis - Antenna 0

Freq. (MHz)	Level (dBuV/m)	Pol (v/h)	Limit	Margin	Peak / QP / Avg	Table Angle (deg)	Ant. Height (cm)	Comments
4810.00	43.21	H	73.97	-30.76	Peak	216.00	143.10	
4810.00	31.45	H	53.97	-22.52	Avg	216.00	143.10	
7215.00								Not in Restricted Band
7215.00								Done via Conducted
9620.00								Not in Restricted Band
9620.00								Done via Conducted
12025.00	46.86	H	73.97	-27.11	Peak	61.00	238.74	
12025.00	35.10	H	53.97	-18.87	Avg	61.00	238.74	
14430.00								No Emission Detected
14430.00								
16835.00								No Emission Detected
16835.00								
19240.00								No Emission Detected
19240.00								
21645.00								No Emission Detected
21645.00								
24050.00								No Emission Detected
24050.00								

**FCC 15.247**

Vivint, Inc.
Vivint Zigbee Bridge
Model: BB03

Date: 09/13/2022
Lab: D
Tested By: Kyle Fujimoto

Harmonics - Low Channel
Transmit Mode - Y-Axis - Antenna 0

Freq. (MHz)	Level (dBuV/m)	Pol (v/h)	Limit	Margin	Peak / QP / Avg	Table Angle (deg)	Ant. Height (cm)	Comments
4810.00	43.68	H	73.97	-30.29	Peak	331.00	127.34	
4810.00	31.92	H	53.97	-22.05	Avg	331.00	127.34	
7215.00								Not in Restricted Band
7215.00								Done via Conducted
9620.00								Not in Restricted Band
9620.00								Done via Conducted
12025.00	46.20	H	73.97	-27.77	Peak	158.25	191.10	
12025.00	34.44	H	53.97	-19.53	Avg	158.25	191.10	
14430.00								No Emission Detected
14430.00								Detected
16835.00								No Emission Detected
16835.00								Detected
19240.00								No Emission Detected
19240.00								Detected
21645.00								No Emission Detected
21645.00								Detected
24050.00								No Emission Detected
24050.00								Detected

**FCC 15.247**

Vivint, Inc.
Vivint Zigbee Bridge
Model: BB03

Date: 09/13/2022
Lab: D
Tested By: Kyle Fujimoto

Harmonics - Low Channel
Transmit Mode - Z-Axis - Antenna 0

Freq. (MHz)	Level (dBuV/m)	Pol (v/h)	Limit	Margin	Peak / QP / Avg	Table Angle (deg)	Ant. Height (cm)	Comments
4810.00	40.36	H	73.97	-33.61	Peak	169.50	145.19	
4810.00	28.60	H	53.97	-25.37	Avg	169.50	145.19	
7215.00								Not in Restricted Band
7215.00								Done via Conducted
9620.00								Not in Restricted Band
9620.00								Done via Conducted
12025.00	46.41	H	73.97	-27.56	Peak	131.50	192.11	
12025.00	34.65	H	53.97	-19.32	Avg	131.50	192.11	
14430.00								No Emission Detected
14430.00								
16835.00								No Emission Detected
16835.00								
19240.00								No Emission Detected
19240.00								
21645.00								No Emission Detected
21645.00								
24050.00								No Emission Detected
24050.00								

**FCC 15.247**

Vivint, Inc.
Vivint Zigbee Bridge
Model: BB03

Date: 09/13/2022

Lab: D

Tested By: Kyle Fujimoto

Harmonics - Middle Channel
Transmit Mode - X-Axis - Antenna 0

Freq. (MHz)	Level (dBuV/m)	Pol (v/h)	Limit	Margin	Peak / QP / Avg	Table Angle (deg)	Ant. Height (cm)	Comments
4880.00	39.45	V	73.97	-34.52	Peak	225.25	127.40	
4880.00	27.69	V	53.97	-26.28	Avg	225.25	127.40	
7320.00	42.90	V	73.97	-31.07	Peak	169.25	175.10	
7320.00	31.14	V	53.97	-22.83	Avg	169.25	175.10	
9760.00								Not in Restricted Band
9760.00								Done via Conducted
12200.00	46.67	V	73.97	-27.30	Peak	0.00	205.98	
12200.00	34.91	V	53.97	-19.06	Avg	0.00	205.98	
14640.00								No Emission Detected
14640.00								Detected
17080.00								No Emission Detected
17080.00								Detected
19520.00								No Emission Detected
19520.00								Detected
21960.00								No Emission Detected
21960.00								Detected
24400.00								No Emission Detected
24400.00								Detected

**FCC 15.247**

Vivint, Inc.
Vivint Zigbee Bridge
Model: BB03

Date: 09/13/2022
Lab: D
Tested By: Kyle Fujimoto

Harmonics - Middle Channel
Transmit Mode - Y-Axis - Antenna 0

Freq. (MHz)	Level (dBuV/m)	Pol (v/h)	Limit	Margin	Peak / QP / Avg	Table Angle (deg)	Ant. Height (cm)	Comments
4880.00	43.58	V	73.97	-30.39	Peak	149.25	160.00	
4880.00	31.82	V	53.97	-22.15	Avg	149.25	160.00	
7320.00	43.25	V	73.97	-30.72	Peak	217.50	143.16	
7320.00	31.49	V	53.97	-22.48	Avg	217.50	143.16	
9760.00								Not in Restricted Band
9760.00								Done via Conducted
12200.00	46.86	V	73.97	-27.11	Peak	148.00	143.40	
12200.00	35.10	V	53.97	-18.87	Avg	148.00	143.40	
14640.00								No Emission
14640.00								Detected
17080.00								No Emission
17080.00								Detected
19520.00								No Emission
19520.00								Detected
21960.00								No Emission
21960.00								Detected
24400.00								No Emission
24400.00								Detected

**FCC 15.247**

Vivint, Inc.
Vivint Zigbee Bridge
Model: BB03

Date: 09/13/2022

Lab: D

Tested By: Kyle Fujimoto

Harmonics - Middle Channel
Transmit Mode - Z-Axis - Antenna 0

Freq. (MHz)	Level (dBuV/m)	Pol (v/h)	Limit	Margin	Peak / QP / Avg	Table Angle (deg)	Ant. Height (cm)	Comments
4880.00	42.14	V	73.97	-31.83	Peak	0.00	175.40	
4880.00	30.38	V	53.97	-23.59	Avg	0.00	175.40	
7320.00	31.42	V	73.97	-42.55	Peak	39.25	127.94	
7320.00	19.66	V	53.97	-34.31	Avg	39.25	127.94	
9760.00								Not in Restricted Band
9760.00								Done via Conducted
12200.00	47.01	V	73.97	-26.96	Peak	226.00	111.46	
12200.00	35.25	V	53.97	-18.72	Avg	226.00	111.46	
14640.00								No Emission Detected
14640.00								Detected
17080.00								No Emission Detected
17080.00								Detected
19520.00								No Emission Detected
19520.00								Detected
21960.00								No Emission Detected
21960.00								Detected
24400.00								No Emission Detected
24400.00								Detected

**FCC 15.247**

Vivint, Inc.
Vivint Zigbee Bridge
Model: BB03

Date: 09/13/2022
Lab: D
Tested By: Kyle Fujimoto

Harmonics - Middle Channel
Transmit Mode - X-Axis - Antenna 0

Freq. (MHz)	Level (dBuV/m)	Pol (v/h)	Limit	Margin	Peak / QP / Avg	Table Angle (deg)	Ant. Height (cm)	Comments
4880.00	42.24	H	73.97	-31.73	Peak	264.75	142.98	
4880.00	30.48	H	53.97	-23.49	Avg	264.75	142.98	
7320.00	43.32	H	73.97	-30.65	Peak	240.25	206.86	
7320.00	31.56	H	53.97	-22.41	Avg	240.25	206.86	
9760.00								Not in Restricted Band
9760.00								Done via Conducted
12200.00	47.00	H	73.97	-26.97	Peak	269.00	175.40	
12200.00	35.24	H	53.97	-18.73	Avg	269.00	175.40	
14640.00								No Emission Detected
14640.00								Detected
17080.00								No Emission Detected
17080.00								Detected
19520.00								No Emission Detected
19520.00								Detected
21960.00								No Emission Detected
21960.00								Detected
24400.00								No Emission Detected
24400.00								Detected

**FCC 15.247**

Vivint, Inc.
Vivint Zigbee Bridge
Model: BB03

Date: 09/13/2022

Lab: D

Tested By: Kyle Fujimoto

Harmonics - Middle Channel
Transmit Mode - Y-Axis - Antenna 0

Freq. (MHz)	Level (dBuV/m)	Pol (v/h)	Limit	Margin	Peak / QP / Avg	Table Angle (deg)	Ant. Height (cm)	Comments
4880.00	43.08	H	73.97	-30.89	Peak	177.00	176.29	
4880.00	31.32	H	53.97	-22.65	Avg	177.00	176.29	
7320.00	43.16	H	73.97	-30.81	Peak	141.00	239.10	
7320.00	31.40	H	53.97	-22.57	Avg	141.00	239.10	
9760.00								Not in Restricted Band
9760.00								Done via Conducted
12200.00	46.74	H	73.97	-27.23	Peak	238.00	207.88	
12200.00	34.98	H	53.97	-18.99	Avg	238.00	207.88	
14640.00								No Emission
14640.00								Detected
17080.00								No Emission
17080.00								Detected
19520.00								No Emission
19520.00								Detected
21960.00								No Emission
21960.00								Detected
24400.00								No Emission
24400.00								Detected

**FCC 15.247**

Vivint, Inc.
Vivint Zigbee Bridge
Model: BB03

Date: 09/13/2022
Lab: D
Tested By: Kyle Fujimoto

Harmonics - Middle Channel
Transmit Mode - Z-Axis - Antenna 0

Freq. (MHz)	Level (dBuV/m)	Pol (v/h)	Limit	Margin	Peak / QP / Avg	Table Angle (deg)	Ant. Height (cm)	Comments
4880.00	45.00	H	73.97	-28.97	Peak	188.75	144.53	
4880.00	33.24	H	53.97	-20.73	Avg	188.75	144.53	
7320.00	43.12	H	73.97	-30.85	Peak	101.50	249.97	
7320.00	31.36	H	53.97	-22.61	Avg	101.50	249.97	
9760.00								Not in Restricted Band
9760.00								Done via Conducted
12200.00	46.91	H	73.97	-27.06	Peak	100.75	175.10	
12200.00	35.15	H	53.97	-18.82	Avg	100.75	175.10	
14640.00								No Emission Detected
14640.00								
17080.00								No Emission Detected
17080.00								
19520.00								No Emission Detected
19520.00								
21960.00								No Emission Detected
21960.00								
24400.00								No Emission Detected
24400.00								

**FCC 15.247**

Vivint, Inc.
Vivint Zigbee Bridge
Model: BB03

Date: 09/13/2022

Lab: D

Tested By: Kyle Fujimoto

Harmonics - High Channel
Transmit Mode - X-Axis - Antenna 0

Freq. (MHz)	Level (dBuV/m)	Pol (v/h)	Limit	Margin	Peak / QP / Avg	Table Angle (deg)	Ant. Height (cm)	Comments
4950.00	39.34	V	73.97	-34.63	Peak	284.75	238.74	
4950.00	27.58	V	53.97	-26.39	Avg	284.75	238.74	
7425.00	43.42	V	73.97	-30.55	Peak	93.75	206.80	
7425.00	31.66	V	53.97	-22.31	Avg	93.75	206.80	
9900.00								Not in Restricted Band
9900.00								Done via Conducted
12375.00	48.13	V	73.97	-25.84	Peak	276.75	159.22	
12375.00	36.37	V	53.97	-17.60	Avg	276.75	159.22	
14850.00								No Emission
14850.00								Detected
17325.00								No Emission
17325.00								Detected
19800.00								No Emission
19800.00								Detected
22275.00								No Emission
22275.00								Detected
24750.00								No Emission
24750.00								Detected

**FCC 15.247**

Vivint, Inc.
Vivint Zigbee Bridge
Model: BB03

Date: 09/13/2022
Lab: D
Tested By: Kyle Fujimoto

Harmonics - High Channel
Transmit Mode - Y-Axis - Antenna 0

Freq. (MHz)	Level (dBuV/m)	Pol (v/h)	Limit	Margin	Peak / QP / Avg	Table Angle (deg)	Ant. Height (cm)	Comments
4950.00	38.51	V	73.97	-35.46	Peak	130.75	191.04	
4950.00	26.75	V	53.97	-27.22	Avg	130.75	191.04	
7425.00	43.82	V	73.97	-30.15	Peak	241.75	159.22	
7425.00	32.06	V	53.97	-21.91	Avg	241.75	159.22	
9900.00								Not in Restricted Band
9900.00								Done via Conducted
12375.00	48.50	V	73.97	-25.47	Peak	318.25	207.40	
12375.00	36.74	V	53.97	-17.23	Avg	318.25	207.40	
14850.00								No Emission Detected
14850.00								
17325.00								No Emission Detected
17325.00								
19800.00								No Emission Detected
19800.00								
22275.00								No Emission Detected
22275.00								
24750.00								No Emission Detected
24750.00								

**FCC 15.247**

Vivint, Inc.
Vivint Zigbee Bridge
Model: BB03

Date: 09/13/2022
Lab: D
Tested By: Kyle Fujimoto

Harmonics - High Channel
Transmit Mode - Z-Axis - Antenna 0

Freq. (MHz)	Level (dBuV/m)	Pol (v/h)	Limit	Margin	Peak / QP / Avg	Table Angle (deg)	Ant. Height (cm)	Comments
4950.00	42.55	V	73.97	-31.42	Peak	297.25	143.52	
4950.00	30.79	V	53.97	-23.18	Avg	297.25	143.52	
7425.00	43.00	V	73.97	-30.97	Peak	78.75	249.95	
7425.00	31.24	V	53.97	-22.73	Avg	78.75	249.95	
9900.00								Not in Restricted Band
9900.00								Done via Conducted
12375.00	48.17	V	73.97	-25.80	Peak	152.00	206.80	
12375.00	36.41	V	53.97	-17.56	Avg	152.00	206.80	
14850.00								No Emission
14850.00								Detected
17325.00								No Emission
17325.00								Detected
19800.00								No Emission
19800.00								Detected
22275.00								No Emission
22275.00								Detected
24750.00								No Emission
24750.00								Detected

**FCC 15.247**

Vivint, Inc.
Vivint Zigbee Bridge
Model: BB03

Date: 09/13/2022

Lab: D

Tested By: Kyle Fujimoto

Harmonics - High Channel**Transmit Mode - X-Axis - Antenna 0**

Freq. (MHz)	Level (dBuV/m)	Pol (v/h)	Limit	Margin	Peak / QP / Avg	Table Angle (deg)	Ant. Height (cm)	Comments
4950.00	41.00	H	73.97	-32.97	Peak	259.00	175.04	
4950.00	29.24	H	53.97	-24.73	Avg	259.00	175.04	
7425.00	44.17	H	73.97	-29.80	Peak	233.00	174.00	
7425.00	32.41	H	53.97	-21.56	Avg	233.00	174.00	
9900.00								Not in Restricted Band
9900.00								Done via Conducted
12375.00	47.97	H	73.97	-26.00	Peak	324.25	190.14	
12375.00	36.21	H	53.97	-17.76	Avg	324.25	190.14	
14850.00								No Emission
14850.00								Detected
17325.00								No Emission
17325.00								Detected
19800.00								No Emission
19800.00								Detected
22275.00								No Emission
22275.00								Detected
24750.00								No Emission
24750.00								Detected

**FCC 15.247**

Vivint, Inc.
Vivint Zigbee Bridge
Model: BB03

Date: 09/13/2022

Lab: D

Tested By: Kyle Fujimoto

Harmonics - High Channel**Transmit Mode - Y-Axis - Antenna 0**

Freq. (MHz)	Level (dBuV/m)	Pol (v/h)	Limit	Margin	Peak / QP / Avg	Table Angle (deg)	Ant. Height (cm)	Comments
4950.00	40.41	H	73.97	-33.56	Peak	167.50	208.35	
4950.00	28.65	H	53.97	-25.32	Avg	167.50	208.35	
7425.00	43.30	H	73.97	-30.67	Peak	322.00	144.00	
7425.00	31.54	H	53.97	-22.43	Avg	322.00	144.00	
9900.00								Not in Restricted Band
9900.00								Done via Conducted
12375.00	48.02	H	73.97	-25.95	Peak	59.00	111.52	
12375.00	36.26	H	53.97	-17.71	Avg	59.00	111.52	
14850.00								No Emission
14850.00								Detected
17325.00								No Emission
17325.00								Detected
19800.00								No Emission
19800.00								Detected
22275.00								No Emission
22275.00								Detected
24750.00								No Emission
24750.00								Detected

**FCC 15.247**

Vivint, Inc.
Vivint Zigbee Bridge
Model: BB03

Date: 09/13/2022

Lab: D

Tested By: Kyle Fujimoto

Harmonics - High Channel**Transmit Mode - Z-Axis - Antenna 0**

Freq. (MHz)	Level (dBuV/m)	Pol (v/h)	Limit	Margin	Peak / QP / Avg	Table Angle (deg)	Ant. Height (cm)	Comments
4950.00	39.79	H	73.97	-34.18	Peak	297.25	109.37	
4950.00	28.03	H	53.97	-25.94	Avg	297.25		
7425.00	43.45	H	73.97	-30.52	Peak	154.50	191.04	
7425.00	31.69	H	53.97	-22.28	Avg	154.50	191.04	
9900.00								Not in Restricted Band
9900.00								Done via Conducted
12375.00	48.24	H	73.97	-25.73	Peak	255.00	175.04	
12375.00	36.48	H	53.97	-17.49	Avg	255.00	175.04	
14850.00								No Emission
14850.00								Detected
17325.00								No Emission
17325.00								Detected
19800.00								No Emission
19800.00								Detected
22275.00								No Emission
22275.00								Detected
24750.00								No Emission
24750.00								Detected



FCC 15.247 and FCC Class B

Vivint, Inc.
 Vivint Zigbee Bridge
 Model: BB03

Date: 09/13/2022
 Lab: D
 Tested By: Kyle Fujimoto

Non Harmonic Emissions from the Tx and Digital Portion - 9 kHz to 30 MHz
Non Harmonic Emissions from the Tx and Digital Portion - 1 GHz to 25 GHz
Antenna 0

Freq. (MHz)	Level (dBuV/m)	Pol (v/h)	Limit	Margin	Peak / QP / Avg	Table Angle (deg)	Ant. Height (cm)	Comments
								No Emissions Detected from 9 kHz to 30 MHz for the digital portion of the EUT
								No Emissions Detected from 9 kHz to 30 MHz for the Non-Harmonic Emissions of the Transmitter for the EUT
								No Emissions Detected from 1 GHz to 25 GHz for the digital portion of the EUT
								No Emissions Detected from 1 GHz to 25 GHz for the Non-Harmonic Emissions of the Transmitter of the EUT
								Investigated in the X-Axis, Y-Axis, and Z-Axis



***TRANSMIT HARMONICS
USING “ANTENNA 1”
DATA SHEETS***

Brea Division
114 Olinda Drive
Brea, CA 92823
(714) 579-0500

Lake Forest Division
20621 Pascal Way
Lake Forest, CA 92630
(949) 587-0400

Newbury Park Division
1050 Lawrence Drive
Newbury Park, CA 91320
(805) 480-4044

**FCC 15.247**

Vivint, Inc.
Vivint Zigbee Bridge
Model: BB03

Date: 09/20/2022

Lab: D

Tested By: Kyle Fujimoto

Harmonics - Low Channel
Transmit Mode - X-Axis - Antenna 1

Freq. (MHz)	Level (dBuV/m)	Pol (v/h)	Limit	Margin	Peak / QP / Avg	Table Angle (deg)	Ant. Height (cm)	Comments
4810.00	42.91	V	73.97	-31.06	Peak	13.25	111.26	
4810.00	31.15	V	53.97	-22.82	Avg	13.25	111.26	
7215.00								Not in Restricted Band
7215.00								Done via Conducted
9620.00								Not in Restricted Band
9620.00								Done via Conducted
12025.00	46.56	V	73.97	-27.41	Peak	171.50	159.16	
12025.00	34.80	V	53.97	-19.17	Avg	171.50	159.16	
14430.00								No Emission
14430.00								Detected
16835.00								No Emission
16835.00								Detected
19240.00								No Emission
19240.00								Detected
21645.00								No Emission
21645.00								Detected
24050.00								No Emission
24050.00								Detected

**FCC 15.247**

Vivint, Inc.
Vivint Zigbee Bridge
Model: BB03

Date: 09/20/2022
Lab: D
Tested By: Kyle Fujimoto

Harmonics - Low Channel
Transmit Mode - Y-Axis - Antenna 1

Freq. (MHz)	Level (dBuV/m)	Pol (v/h)	Limit	Margin	Peak / QP / Avg	Table Angle (deg)	Ant. Height (cm)	Comments
4810.00	47.20	V	73.97	-26.77	Peak	15.00	160.05	
4810.00	35.44	V	53.97	-18.53	Avg	15.00	160.05	
7215.00								Not in Restricted Band
7215.00								Done via Conducted
9620.00								Not in Restricted Band
9620.00								Done via Conducted
12025.00	46.70	V	73.97	-27.27	Peak	329.50	238.92	
12025.00	34.94	V	53.97	-19.03	Avg	329.50	238.92	
14430.00								No Emission Detected
14430.00								Detected
16835.00								No Emission Detected
16835.00								Detected
19240.00								No Emission Detected
19240.00								Detected
21645.00								No Emission Detected
21645.00								Detected
24050.00								No Emission Detected
24050.00								Detected

**FCC 15.247**

Vivint, Inc.
Vivint Zigbee Bridge
Model: BB03

Date: 09/20/2022

Lab: D

Tested By: Kyle Fujimoto

Harmonics - Low Channel
Transmit Mode - Z-Axis - Antenna 1

Freq. (MHz)	Level (dBuV/m)	Pol (v/h)	Limit	Margin	Peak / QP / Avg	Table Angle (deg)	Ant. Height (cm)	Comments
4810.00	45.95	V	73.97	-28.02	Peak	249.75	127.94	
4810.00	34.19	V	53.97	-19.78	Avg	249.50	127.94	
7215.00								Not in Restricted Band
7215.00								Done via Conducted
9620.00								Not in Restricted Band
9620.00								Done via Conducted
12025.00	46.94	V	73.97	-27.03	Peak	228.00	143.34	
12025.00	35.18	V	53.97	-18.79	Avg	228.00	143.34	
14430.00								No Emission
14430.00								Detected
16835.00								No Emission
16835.00								Detected
19240.00								No Emission
19240.00								Detected
21645.00								No Emission
21645.00								Detected
24050.00								No Emission
24050.00								Detected

**FCC 15.247**

Vivint, Inc.
Vivint Zigbee Bridge
Model: BB03

Date: 09/20/2022

Lab: D

Tested By: Kyle Fujimoto

Harmonics - Low Channel
Transmit Mode - X-Axis - Antenna 1

Freq. (MHz)	Level (dBuV/m)	Pol (v/h)	Limit	Margin	Peak / QP / Avg	Table Angle (deg)	Ant. Height (cm)	Comments
4810.00	45.23	H	73.97	-28.74	Peak	242.50	190.80	
4810.00	33.47	H	53.97	-20.50	Avg	242.50	190.80	
7215.00								Not in Restricted Band
7215.00								Done via Conducted
9620.00								Not in Restricted Band
9620.00								Done via Conducted
12025.00	46.23	H	73.97	-27.74	Peak	132.25	249.08	
12025.00	34.47	H	53.97	-19.50	Avg	132.25	249.08	
14430.00								No Emission Detected
14430.00								
16835.00								No Emission Detected
16835.00								
19240.00								No Emission Detected
19240.00								
21645.00								No Emission Detected
21645.00								
24050.00								No Emission Detected
24050.00								

**FCC 15.247**

Vivint, Inc.
Vivint Zigbee Bridge
Model: BB03

Date: 09/20/2022
Lab: D
Tested By: Kyle Fujimoto

Harmonics - Low Channel
Transmit Mode - Y-Axis - Antenna 1

Freq. (MHz)	Level (dBuV/m)	Pol (v/h)	Limit	Margin	Peak / QP / Avg	Table Angle (deg)	Ant. Height (cm)	Comments
4810.00	43.48	H	73.97	-30.49	Peak	356.75	111.40	
4810.00	31.72	H	53.97	-22.25	Avg	356.75	111.40	
7215.00								Not in Restricted Band
7215.00								Done via Conducted
9620.00								Not in Restricted Band
9620.00								Done via Conducted
12025.00	46.49	H	73.97	-27.48	Peak	275.00	191.22	
12025.00	34.73	H	53.97	-19.24	Avg	275.00	191.22	
14430.00								No Emission Detected
14430.00								Detected
16835.00								No Emission Detected
16835.00								Detected
19240.00								No Emission Detected
19240.00								Detected
21645.00								No Emission Detected
21645.00								Detected
24050.00								No Emission Detected
24050.00								Detected

**FCC 15.247**

Vivint, Inc.
Vivint Zigbee Bridge
Model: BB03

Date: 09/20/2022
Lab: D
Tested By: Kyle Fujimoto

Harmonics - Low Channel
Transmit Mode - Z-Axis - Antenna 1

Freq. (MHz)	Level (dBuV/m)	Pol (v/h)	Limit	Margin	Peak / QP / Avg	Table Angle (deg)	Ant. Height (cm)	Comments
4810.00	44.95	H	73.97	-29.02	Peak	179.75	175.22	
4810.00	33.19	H	53.97	-20.78	Avg	179.75	175.22	
7215.00								Not in Restricted Band
7215.00								Done via Conducted
9620.00								Not in Restricted Band
9620.00								Done via Conducted
12025.00	46.46	H	73.97	-27.51	Peak	92.75	127.28	
12025.00	34.70	H	53.97	-19.27	Avg	92.75	127.28	
14430.00								No Emission Detected
14430.00								
16835.00								No Emission Detected
16835.00								
19240.00								No Emission Detected
19240.00								
21645.00								No Emission Detected
21645.00								
24050.00								No Emission Detected
24050.00								

**FCC 15.247**

Vivint, Inc.
Vivint Zigbee Bridge
Model: BB03

Date: 09/20/2022
Lab: D
Tested By: Kyle Fujimoto

Harmonics - Middle Channel
Transmit Mode - X-Axis - Antenna 1

Freq. (MHz)	Level (dBuV/m)	Pol (v/h)	Limit	Margin	Peak / QP / Avg	Table Angle (deg)	Ant. Height (cm)	Comments
4880.00	43.43	V	73.97	-30.54	Peak	314.50	111.52	
4880.00	31.67	V	53.97	-22.30	Avg	314.50	111.52	
7320.00	43.02	V	73.97	-30.95	Peak	152.00	191.26	
7320.00	31.26	V	53.97	-22.71	Avg	152.00	191.26	
9760.00								Not in Restricted Band
9760.00								Done via Conducted
12200.00	48.00	V	73.97	-25.97	Peak	233.25	143.40	
12200.00	36.24	V	53.97	-17.73	Avg	233.25	143.40	
14640.00								No Emission Detected
14640.00								Detected
17080.00								No Emission Detected
17080.00								Detected
19520.00								No Emission Detected
19520.00								Detected
21960.00								No Emission Detected
21960.00								Detected
24400.00								No Emission Detected
24400.00								Detected

**FCC 15.247**

Vivint, Inc.
Vivint Zigbee Bridge
Model: BB03

Date: 09/20/2022

Lab: D

Tested By: Kyle Fujimoto

Harmonics - Middle Channel
Transmit Mode - Y-Axis - Antenna 1

Freq. (MHz)	Level (dBuV/m)	Pol (v/h)	Limit	Margin	Peak / QP / Avg	Table Angle (deg)	Ant. Height (cm)	Comments
4880.00	42.78	V	73.97	-31.19	Peak	79.00	127.10	
4880.00	31.02	V	53.97	-22.95	Avg	79.00	127.10	
7320.00	42.84	V	73.97	-31.13	Peak	69.25	159.22	
7320.00	31.08	V	53.97	-22.89	Avg	69.25	159.22	
9760.00								Not in Restricted Band
9760.00								Done via Conducted
12200.00	47.84	V	73.97	-26.13	Peak	209.25	111.28	
12200.00	36.08	V	53.97	-17.89	Avg	209.25	111.28	
14640.00								No Emission
14640.00								Detected
17080.00								No Emission
17080.00								Detected
19520.00								No Emission
19520.00								Detected
21960.00								No Emission
21960.00								Detected
24400.00								No Emission
24400.00								Detected

**FCC 15.247**

Vivint, Inc.
Vivint Zigbee Bridge
Model: BB03

Date: 09/20/2022

Lab: D

Tested By: Kyle Fujimoto

Harmonics - Middle Channel
Transmit Mode - Z-Axis - Antenna 1

Freq. (MHz)	Level (dBuV/m)	Pol (v/h)	Limit	Margin	Peak / QP / Avg	Table Angle (deg)	Ant. Height (cm)	Comments
4880.00	44.00	V	73.97	-29.97	Peak	60.50	111.34	
4880.00	32.24	V	53.97	-21.73	Avg	60.50	111.34	
7320.00	43.25	V	73.97	-30.72	Peak	202.50	249.98	
7320.00	31.49	V	53.97	-22.48	Avg	202.50	249.98	
9760.00								Not in Restricted Band
9760.00								Done via Conducted
12200.00	47.78	V	73.97	-26.19	Peak	3.75	175.28	
12200.00	36.02	V	53.97	-17.95	Avg	3.75	175.28	
14640.00								No Emission Detected
14640.00								Detected
17080.00								No Emission Detected
17080.00								Detected
19520.00								No Emission Detected
19520.00								Detected
21960.00								No Emission Detected
21960.00								Detected
24400.00								No Emission Detected
24400.00								Detected

**FCC 15.247**

Vivint, Inc.
Vivint Zigbee Bridge
Model: BB03

Date: 09/20/2022

Lab: D

Tested By: Kyle Fujimoto

Harmonics - Middle Channel
Transmit Mode - X-Axis - Antenna 1

Freq. (MHz)	Level (dBuV/m)	Pol (v/h)	Limit	Margin	Peak / QP / Avg	Table Angle (deg)	Ant. Height (cm)	Comments
4880.00	42.17	H	73.97	-31.80	Peak	164.75	111.46	
4880.00	30.41	H	53.97	-23.56	Avg	164.75	111.46	
7320.00	42.98	H	73.97	-30.99	Peak	339.25	249.98	
7320.00	31.22	H	53.97	-22.75	Avg	339.25	249.98	
9760.00								Not in Restricted Band
9760.00								Done via Conducted
12200.00	48.58	H	73.97	-25.39	Peak	58.50	127.28	
12200.00	36.82	H	53.97	-17.15	Avg	58.50	127.28	
14640.00								No Emission Detected
14640.00								Detected
17080.00								No Emission Detected
17080.00								Detected
19520.00								No Emission Detected
19520.00								Detected
21960.00								No Emission Detected
21960.00								Detected
24400.00								No Emission Detected
24400.00								Detected

**FCC 15.247**

Vivint, Inc.
Vivint Zigbee Bridge
Model: BB03

Date: 09/20/2022

Lab: D

Tested By: Kyle Fujimoto

Harmonics - Middle Channel
Transmit Mode - Y-Axis - Antenna 1

Freq. (MHz)	Level (dBuV/m)	Pol (v/h)	Limit	Margin	Peak / QP / Avg	Table Angle (deg)	Ant. Height (cm)	Comments
4880.00	43.81	H	73.97	-30.16	Peak	80.75	111.34	
4880.00	32.05	H	53.97	-21.92	Avg	80.75	111.34	
7320.00	42.72	H	73.97	-31.25	Peak	66.50	249.14	
7320.00	30.96	H	53.97	-23.01	Avg	66.50	249.14	
9760.00								Not in Restricted Band
9760.00								Done via Conducted
12200.00	48.52	H	73.97	-25.45	Peak	240.00	143.34	
12200.00	36.76	H	53.97	-17.21	Avg	240.00	143.34	
14640.00								No Emission
14640.00								Detected
17080.00								No Emission
17080.00								Detected
19520.00								No Emission
19520.00								Detected
21960.00								No Emission
21960.00								Detected
24400.00								No Emission
24400.00								Detected

**FCC 15.247**

Vivint, Inc.
Vivint Zigbee Bridge
Model: BB03

Date: 09/20/2022
Lab: D
Tested By: Kyle Fujimoto

Harmonics - Middle Channel
Transmit Mode - Z-Axis - Antenna 1

Freq. (MHz)	Level (dBuV/m)	Pol (v/h)	Limit	Margin	Peak / QP / Avg	Table Angle (deg)	Ant. Height (cm)	Comments
4880.00	43.29	H	73.97	-30.68	Peak	266.25	111.28	
4880.00	31.53	H	53.97	-22.44	Avg	266.25	111.28	
7320.00	43.50	H	73.97	-30.47	Peak	225.00	127.34	
7320.00	31.74	H	53.97	-22.23	Avg	225.00	127.34	
9760.00								Not in Restricted Band
9760.00								Done via Conducted
12200.00	48.06	H	73.97	-25.91	Peak	179.50	159.22	
12200.00	36.30	H	53.97	-17.67	Avg	179.50	159.22	
14640.00								No Emission Detected
14640.00								Detected
17080.00								No Emission Detected
17080.00								Detected
19520.00								No Emission Detected
19520.00								Detected
21960.00								No Emission Detected
21960.00								Detected
24400.00								No Emission Detected
24400.00								Detected

**FCC 15.247**

Vivint, Inc.
Vivint Zigbee Bridge
Model: BB03

Date: 09/20/2022

Lab: D

Tested By: Kyle Fujimoto

Harmonics - High Channel
Transmit Mode - X-Axis - Antenna 1

Freq. (MHz)	Level (dBuV/m)	Pol (v/h)	Limit	Margin	Peak / QP / Avg	Table Angle (deg)	Ant. Height (cm)	Comments
4950.00	39.12	V	73.97	-34.85	Peak	304.75	127.22	
4950.00	27.36	V	53.97	-26.61	Avg	304.75	127.22	
7425.00	43.09	V	73.97	-30.88	Peak	156.25	191.28	
7425.00	31.33	V	53.97	-22.64	Avg	156.25	191.28	
9900.00								Not in Restricted Band
9900.00								Done via Conducted
12375.00	47.99	V	73.97	-25.98	Peak	287.75	175.22	
12375.00	36.23	V	53.97	-17.74	Avg	287.75	175.22	
14850.00								No Emission Detected
14850.00								
17325.00								No Emission Detected
17325.00								
19800.00								No Emission Detected
19800.00								
22275.00								No Emission Detected
22275.00								
24750.00								No Emission Detected
24750.00								

**FCC 15.247**

Vivint, Inc.
Vivint Zigbee Bridge
Model: BB03

Date: 09/20/2022
Lab: D
Tested By: Kyle Fujimoto

Harmonics - High Channel
Transmit Mode - Y-Axis - Antenna 1

Freq. (MHz)	Level (dBuV/m)	Pol (v/h)	Limit	Margin	Peak / QP / Avg	Table Angle (deg)	Ant. Height (cm)	Comments
4950.00	41.91	V	73.97	-32.06	Peak	206.00	175.40	
4950.00	30.15	V	53.97	-23.82	Avg	206.00	175.40	
7425.00	42.81	V	73.97	-31.16	Peak	209.00	223.10	
7425.00	31.05	V	53.97	-22.92	Avg	209.00	223.10	
9900.00								Not in Restricted Band
9900.00								Done via Conducted
12375.00	47.57	V	73.97	-26.40	Peak	145.00	239.04	
12375.00	35.81	V	53.97	-18.16	Avg	145.00	239.04	
14850.00								No Emission Detected
14850.00								
17325.00								No Emission Detected
17325.00								
19800.00								No Emission Detected
19800.00								
22275.00								No Emission Detected
22275.00								
24750.00								No Emission Detected
24750.00								

**FCC 15.247**

Vivint, Inc.
Vivint Zigbee Bridge
Model: BB03

Date: 09/20/2022
Lab: D
Tested By: Kyle Fujimoto

Harmonics - High Channel
Transmit Mode - Z-Axis - Antenna 1

Freq. (MHz)	Level (dBuV/m)	Pol (v/h)	Limit	Margin	Peak / QP / Avg	Table Angle (deg)	Ant. Height (cm)	Comments
4950.00	41.33	V	73.97	-32.64	Peak	20.25	127.10	
4950.00	29.57	V	53.97	-24.40	Avg	20.25	127.10	
7425.00	43.20	V	73.97	-30.77	Peak	151.50	159.26	
7425.00	31.44	V	53.97	-22.53	Avg	151.50	159.28	
9900.00								Not in Restricted Band
9900.00								Done via Conducted
12375.00	47.96	V	73.97	-26.01	Peak	356.50	111.40	
12375.00	36.20	V	53.97	-17.77	Avg	356.50	111.40	
14850.00								No Emission Detected
14850.00								Detected
17325.00								No Emission Detected
17325.00								Detected
19800.00								No Emission Detected
19800.00								Detected
22275.00								No Emission Detected
22275.00								Detected
24750.00								No Emission Detected
24750.00								Detected

**FCC 15.247**

Vivint, Inc.
Vivint Zigbee Bridge
Model: BB03

Date: 09/20/2022

Lab: D

Tested By: Kyle Fujimoto

Harmonics - High Channel
Transmit Mode - X-Axis - Antenna 1

Freq. (MHz)	Level (dBuV/m)	Pol (v/h)	Limit	Margin	Peak / QP / Avg	Table Angle (deg)	Ant. Height (cm)	Comments
4950.00	42.61	H	73.97	-31.36	Peak	265.25	111.64	
4950.00	30.85	H	53.97	-23.12	Avg	265.25	111.64	
7425.00	43.29	H	73.97	-30.68	Peak	42.00	111.34	
7425.00	31.53	H	53.97	-22.44	Avg	42.00	111.34	
9900.00								Not in Restricted Band
9900.00								Done via Conducted
12375.00	49.47	H	73.97	-24.50	Peak	276.25	159.34	
12375.00	37.71	H	53.97	-16.26	Avg	276.25	159.34	
14850.00								No Emission
14850.00								Detected
17325.00								No Emission
17325.00								Detected
19800.00								No Emission
19800.00								Detected
22275.00								No Emission
22275.00								Detected
24750.00								No Emission
24750.00								Detected

**FCC 15.247**

Vivint, Inc.
Vivint Zigbee Bridge
Model: BB03

Date: 09/20/2022

Lab: D

Tested By: Kyle Fujimoto

Harmonics - High Channel
Transmit Mode - Y-Axis - Antenna 1

Freq. (MHz)	Level (dBuV/m)	Pol (v/h)	Limit	Margin	Peak / QP / Avg	Table Angle (deg)	Ant. Height (cm)	Comments
4950.00	40.94	H	73.97	-33.03	Peak	178.50	142.26	
4950.00	29.18	H	53.97	-24.79	Avg	178.50	142.26	
7425.00	42.60	H	73.97	-31.37	Peak	28.50	238.98	
7425.00	30.84	H	53.97	-23.13	Avg	28.50	238.98	
9900.00								Not in Restricted Band
9900.00								Done via Conducted
12375.00	49.31	H	73.97	-24.66	Peak	303.75	127.28	
12375.00	37.55	H	53.97	-16.42	Avg	303.75	127.28	
14850.00								No Emission
14850.00								Detected
17325.00								No Emission
17325.00								Detected
19800.00								No Emission
19800.00								Detected
22275.00								No Emission
22275.00								Detected
24750.00								No Emission
24750.00								Detected

**FCC 15.247**

Vivint, Inc.
Vivint Zigbee Bridge
Model: BB03

Date: 09/20/2022

Lab: D

Tested By: Kyle Fujimoto

Harmonics - High Channel**Transmit Mode - Z-Axis - Antenna 1**

Freq. (MHz)	Level (dBuV/m)	Pol (v/h)	Limit	Margin	Peak / QP / Avg	Table Angle (deg)	Ant. Height (cm)	Comments
4950.00	40.61	H	73.97	-33.36	Peak	166.25	111.64	
4950.00	28.85	H	53.97	-25.12	Avg	166.25	111.64	
7425.00	42.79	H	73.97	-31.18	Peak	15.50	249.98	
7425.00	31.03	H	53.97	-22.94	Avg	15.50	249.98	
9900.00								Not in Restricted Band
9900.00								Done via Conducted
12375.00	48.79	H	73.97	-25.18	Peak	277.75	249.97	
12375.00	37.03	H	53.97	-16.94	Avg	277.75	249.97	
14850.00								No Emission
14850.00								Detected
17325.00								No Emission
17325.00								Detected
19800.00								No Emission
19800.00								Detected
22275.00								No Emission
22275.00								Detected
24750.00								No Emission
24750.00								Detected



FCC 15.247 and FCC Class B

Vivint, Inc.
 Vivint Zigbee Bridge
 Model: BB03

Date: 09/20/2022
 Lab: D
 Tested By: Kyle Fujimoto

Non Harmonic Emissions from the Tx and Digital Portion - 9 kHz to 30 MHz

Non Harmonic Emissions from the Tx and Digital Portion - 1 GHz to 25 GHz

Antenna 1

Freq. (MHz)	Level (dBuV/m)	Pol (v/h)	Limit	Margin	Peak / QP / Avg	Table Angle (deg)	Ant. Height (cm)	Comments
								No Emissions Detected from 9 kHz to 30 MHz for the digital portion of the EUT
								No Emissions Detected from 9 kHz to 30 MHz for the Non-Harmonic Emissions of the Transmitter for the EUT
								No Emissions Detected from 1 GHz to 25 GHz for the digital portion of the EUT
								No Emissions Detected from 1 GHz to 25 GHz for the Non-Harmonic Emissions of the Transmitter for the EUT
								Investigated in the X-Axis, Y-Axis, and Z-Axis



***CONDUCTED EMISSIONS
DATA SHEETS***

Brea Division
114 Olinda Drive
Brea, CA 92823
(714) 579-0500

Lake Forest Division
20621 Pascal Way
Lake Forest, CA 92630
(949) 587-0400

Newbury Park Division
1050 Lawrence Drive
Newbury Park, CA 91320
(805) 480-4044



Title: FCC Class B - Black Lead
File: 1 - BL - Pre-Scan - 09-22-2022.set
Operator: Kyle Fujimoto
EUT Type: Vivint Zigbee Bridge
EUT Condition: EUT Connected to Ethernet and turning on and off an LED Zigbee bulb every 2 seconds
Company: Vivint, Inc.
Model: BB03
S/N: N/A

9/22/2022 11:12:59 AM
Sequence: Preliminary Scan

Black Lead

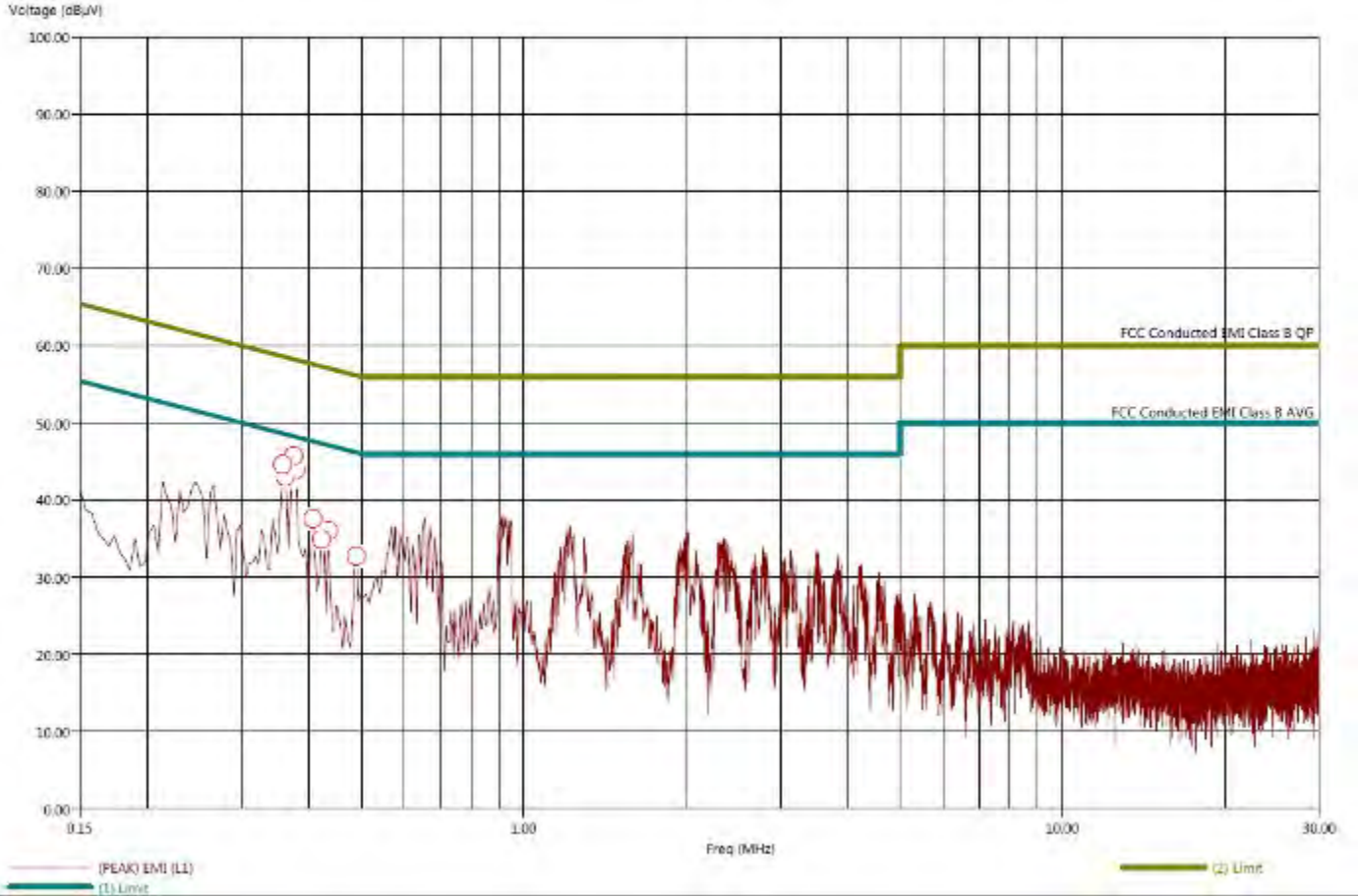

Brea Division
114 Olinda Drive
Brea, CA 92823
(714) 579-0500

Lake Forest Division
20621 Pascal Way
Lake Forest, CA 92630
(949) 587-0400

Newbury Park Division
1050 Lawrence Drive
Newbury Park, CA 91320
(805) 480-4044



FCC Part 15 Subpart B and C; FCC Section 15.247; RSS-247; and RSS-GEN Test Report
 Vivint ZigBee Bridge
 Model: BB03

Title: FCC Class B - Black Load
 File: 1 - BL - Final Scan - 09-22-2022.set
 Operator: Kyle Fujimoto
 EUT Type: Vivint Zigbee Bridge
 EUT Condition: EUT Connected to Ethernet and Turning on and off an LED Zigbee bulb every 2 seconds
 Company: Vivint, Inc.
 Model: BB03
 S/N: N/A

9/22/2022 11:15:25 AM
 Sequence: Final Measurements

Black Lead - Average

Freq (MHz)	(PEAK) EMI (dBµV)	(AVG) EMI (dBµV)	(PEAK) Margin (dB)	(AVG) Margin (AVG) (dB)	(AVG) Limit (dBµV)	Cable (dB)	Transducer (dB)	Filter (dB)
0.358	46.63	40.89	-1.99	-7.73	48.62	0.13	0.14	10.00
0.362	46.70	41.20	-1.91	-7.41	48.62	0.13	0.14	10.00
0.374	47.13	40.02	-1.14	-8.25	48.27	0.13	0.14	10.00
0.378	48.95	40.78	0.61	-7.56	48.34	0.13	0.14	10.00
0.406	35.89	25.28	-11.81	-22.42	47.70	0.14	0.14	10.00
0.422	36.58	27.72	-10.79	-19.65	47.36	0.14	0.14	10.00
0.434	38.08	27.60	-8.98	-19.46	47.05	0.14	0.14	10.00
0.490	41.78	28.66	-4.24	-17.36	46.02	0.14	0.14	10.00





Title: FCC Class B - White Lead
File: 2 - WL - Pre-Scan - 09-22-2022.set
Operator: Kyle Fujimoto
EUT Type: Vivint Zigbee Bridge
EUT Condition: EUT Connected to Ethernet and Turning on and off an LED Zigbee bulb every 2 seconds
Company: Vivint, Inc.
Model: BB03
S/N: N/A

9/22/2022 11:17:48
Sequence: Preliminary 3

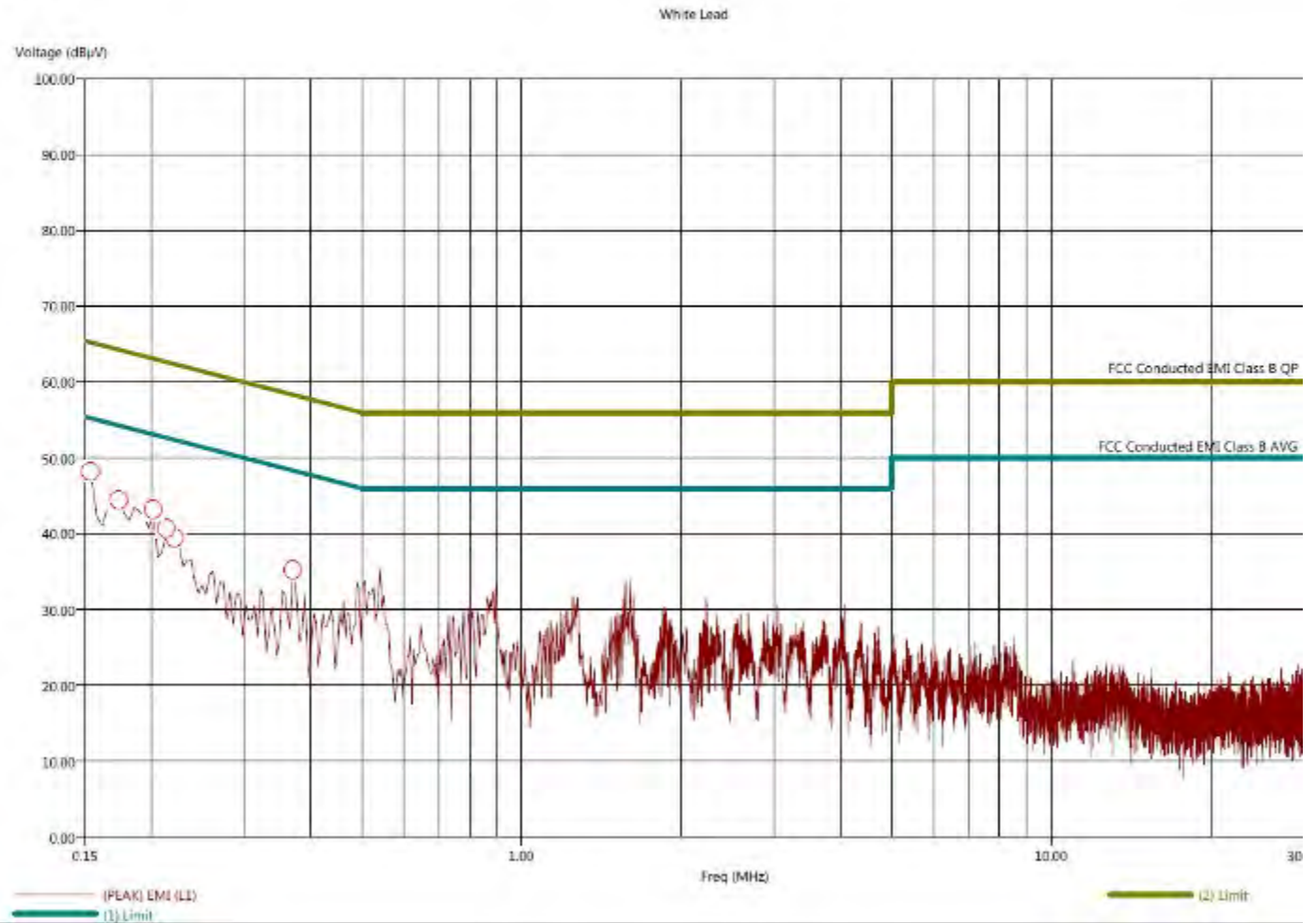

Brea Division
114 Olinda Drive
Brea, CA 92823
(714) 579-0500

Lake Forest Division
20621 Pascal Way
Lake Forest, CA 92630
(949) 587-0400

Newbury Park Division
1050 Lawrence Drive
Newbury Park, CA 91320
(805) 480-4044



FCC Part 15 Subpart B and C; FCC Section 15.247; RSS-247; and RSS-GEN Test Report
 Vivint ZigBee Bridge
 Model: BB03

Title: FCC Class B - White Lead
 File: 2 - WL - Final Scan - 09-22-2022.set
 Operator: Kyle Fujimoto
 EUT Type: Vivint Zigbee Bridge
 EUT Condition: EUT Connected to Ethernet and Turning on and off an LED Zigbee bulb every 2 seconds
 Company: Vivint, Inc.
 Model: BB03
 SN: N/A

9/22/2022 11:24:22 AM
 Sequence: Final Measurements

White Lead - Average										
Freq (MHz)	(PEAK) EMI (dBµV)	(AVG) EMI (dBµV)	(PEAK) Margin (dB)	(AVG) Margin (AVG) (dB)	(AVG) Limit (dBµV)	Cable (dB)	Transducer (dB)	Filter (dB)		
0.154	50.91	33.87	-4.65	-21.69	55.56	0.13	0.18	10.00		
0.174	48.40	31.72	-6.23	-22.91	54.63	0.13	0.17	10.00		
0.202	45.51	31.43	-7.54	-21.62	53.05	0.12	0.15	10.00		
0.214	43.32	31.00	-6.67	-21.99	52.99	0.12	0.15	10.00		
0.222	43.59	35.41	-9.12	-17.30	52.70	0.12	0.15	10.00		
0.370	44.38	36.84	-3.95	-11.49	48.33	0.13	0.13	10.00		



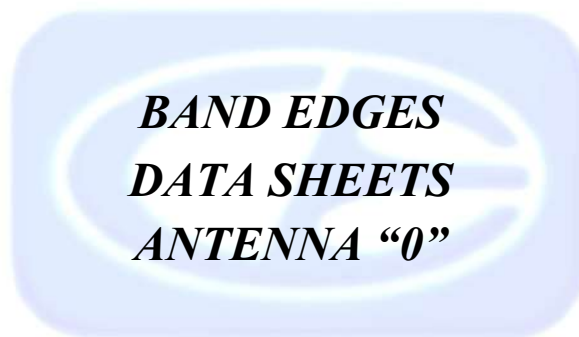



FCC Part 15 Subpart B and C; FCC Section 15.247; RSS-247; and RSS-GEN Test Report
 Vivint ZigBee Bridge
 Model: BB03

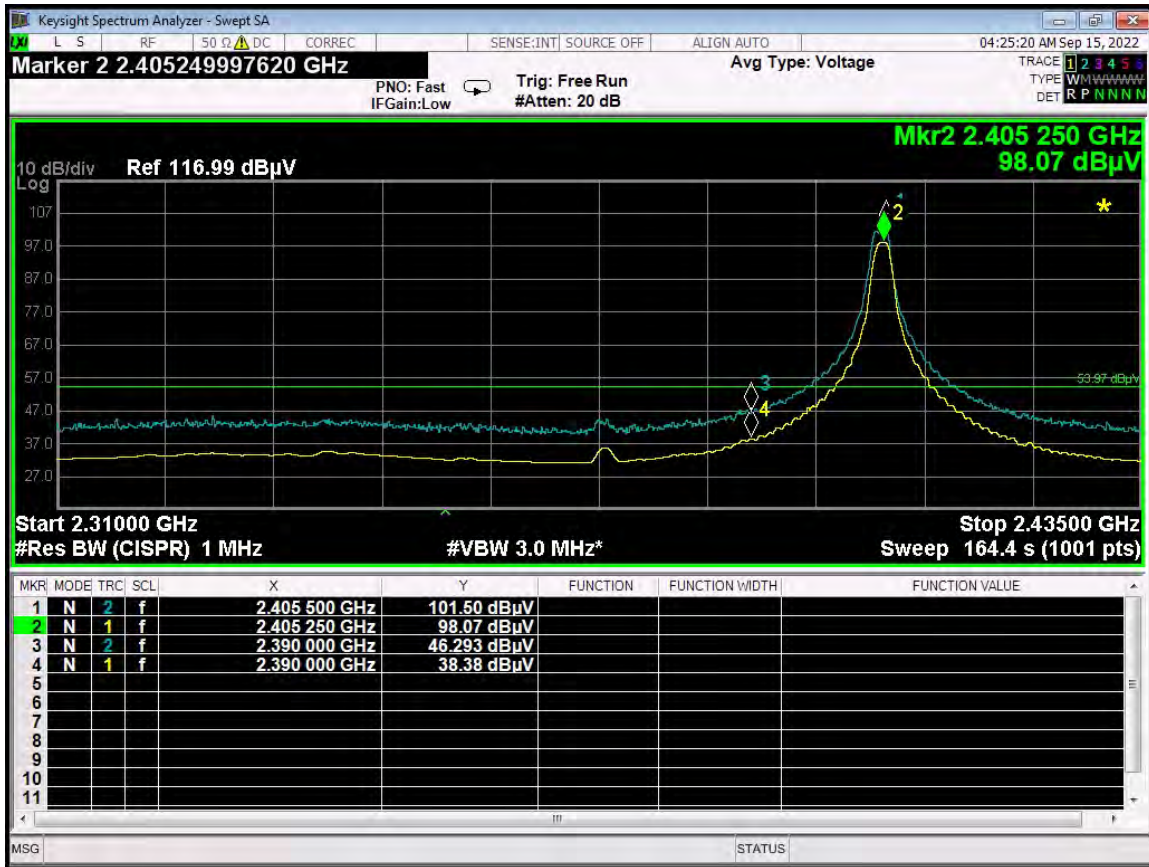

Brea Division
 114 Olinda Drive
 Brea, CA 92823
 (714) 579-0500

Lake Forest Division
 20621 Pascal Way
 Lake Forest, CA 92630
 (949) 587-0400

Newbury Park Division
 1050 Lawrence Drive
 Newbury Park, CA 91320
 (805) 480-4044



FCC Part 15 Subpart B and C; FCC Section 15.247; RSS-247; and RSS-GEN Test Report

Vivint ZigBee Bridge

Model: BB03

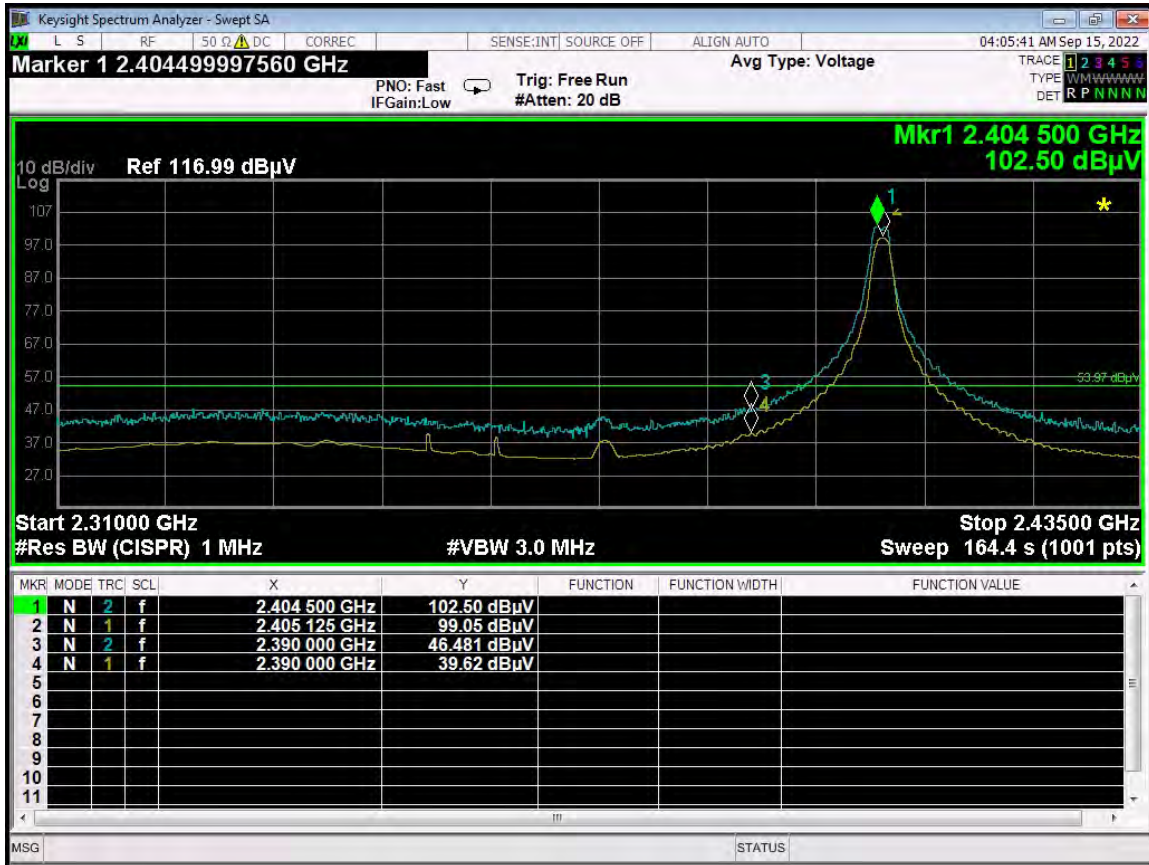

Brea Division
114 Olinda Drive
Brea, CA 92823
(714) 579-0500

Lake Forest Division
20621 Pascal Way
Lake Forest, CA 92630
(949) 587-0400

Newbury Park Division
1050 Lawrence Drive
Newbury Park, CA 91320
(805) 480-4044

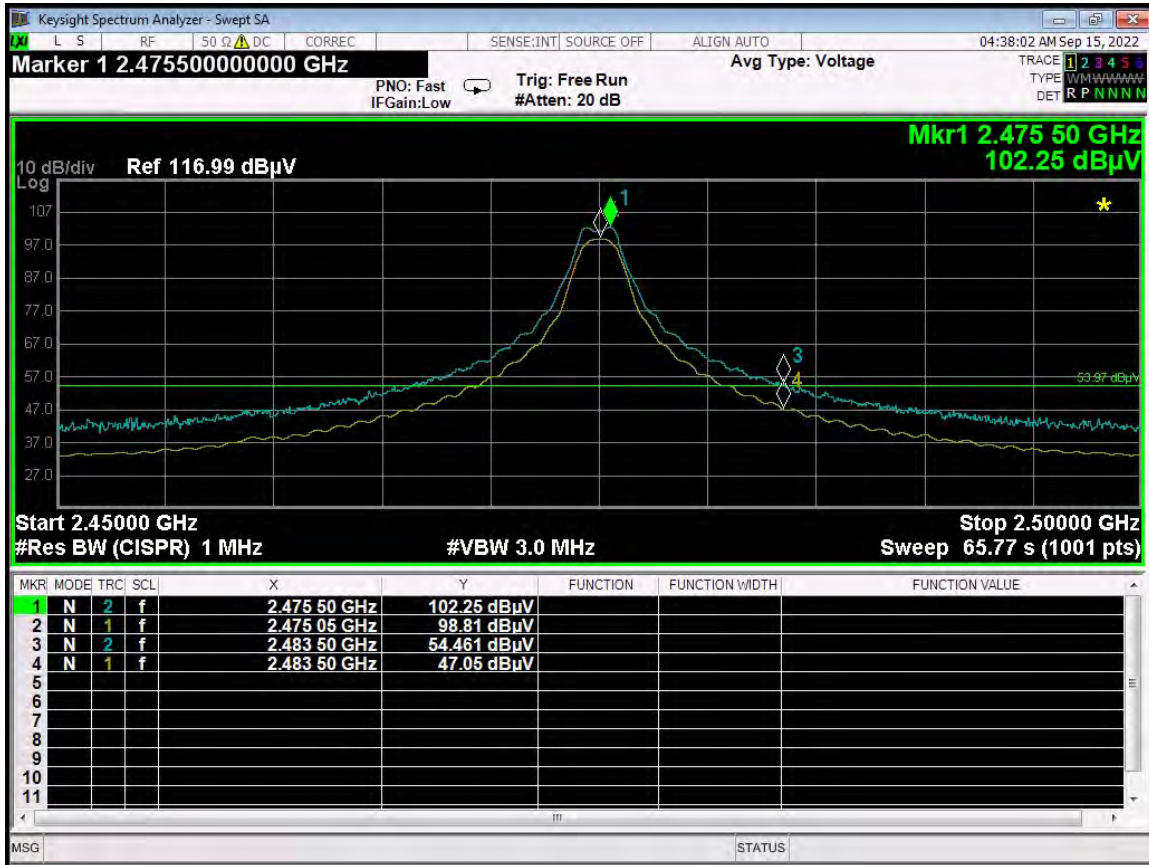

Brea Division
114 Olinda Drive
Brea, CA 92823
(714) 579-0500

Lake Forest Division
20621 Pascal Way
Lake Forest, CA 92630
(949) 587-0400

Newbury Park Division
1050 Lawrence Drive
Newbury Park, CA 91320
(805) 480-4044

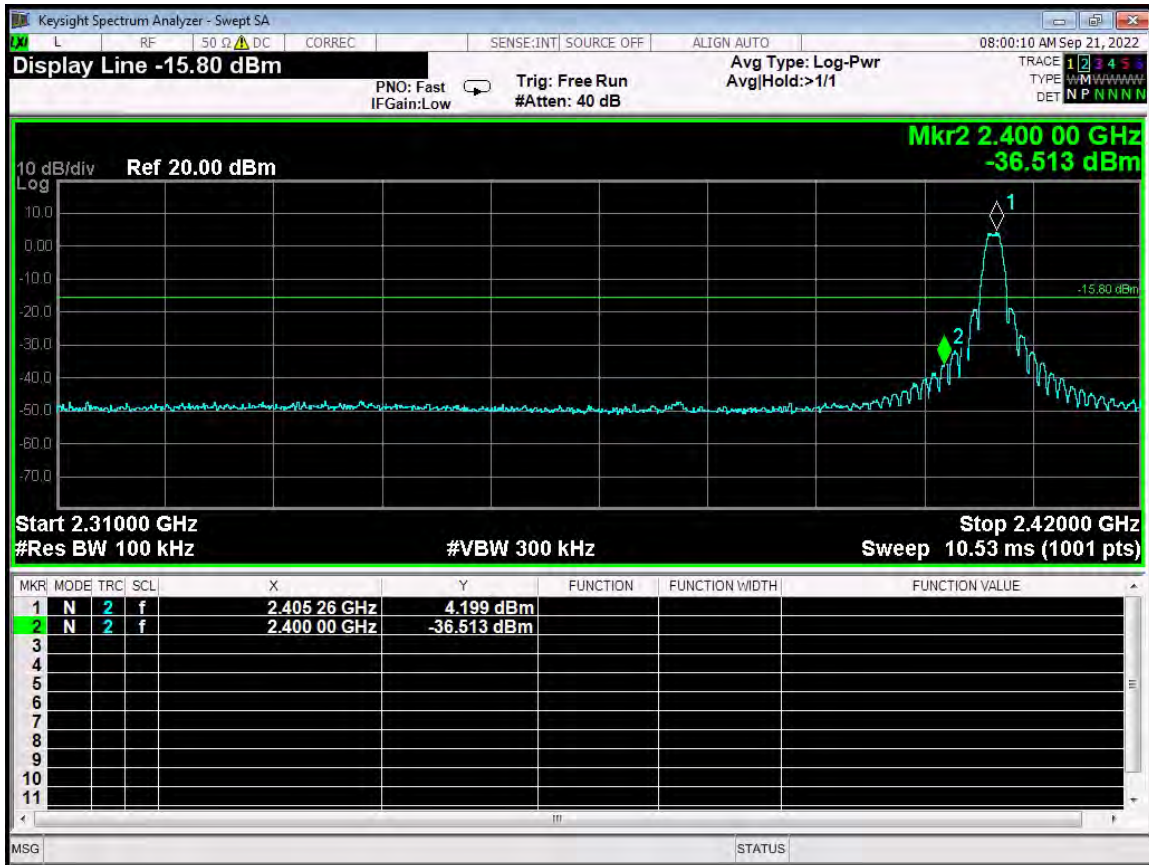

Brea Division
 114 Olinda Drive
 Brea, CA 92823
 (714) 579-0500

Lake Forest Division
 20621 Pascal Way
 Lake Forest, CA 92630
 (949) 587-0400

Newbury Park Division
 1050 Lawrence Drive
 Newbury Park, CA 91320
 (805) 480-4044

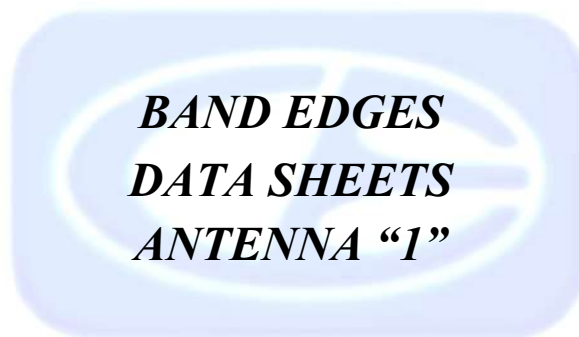



FCC Part 15 Subpart B and C; FCC Section 15.247; RSS-247; and RSS-GEN Test Report
 Vivint ZigBee Bridge
 Model: BB03

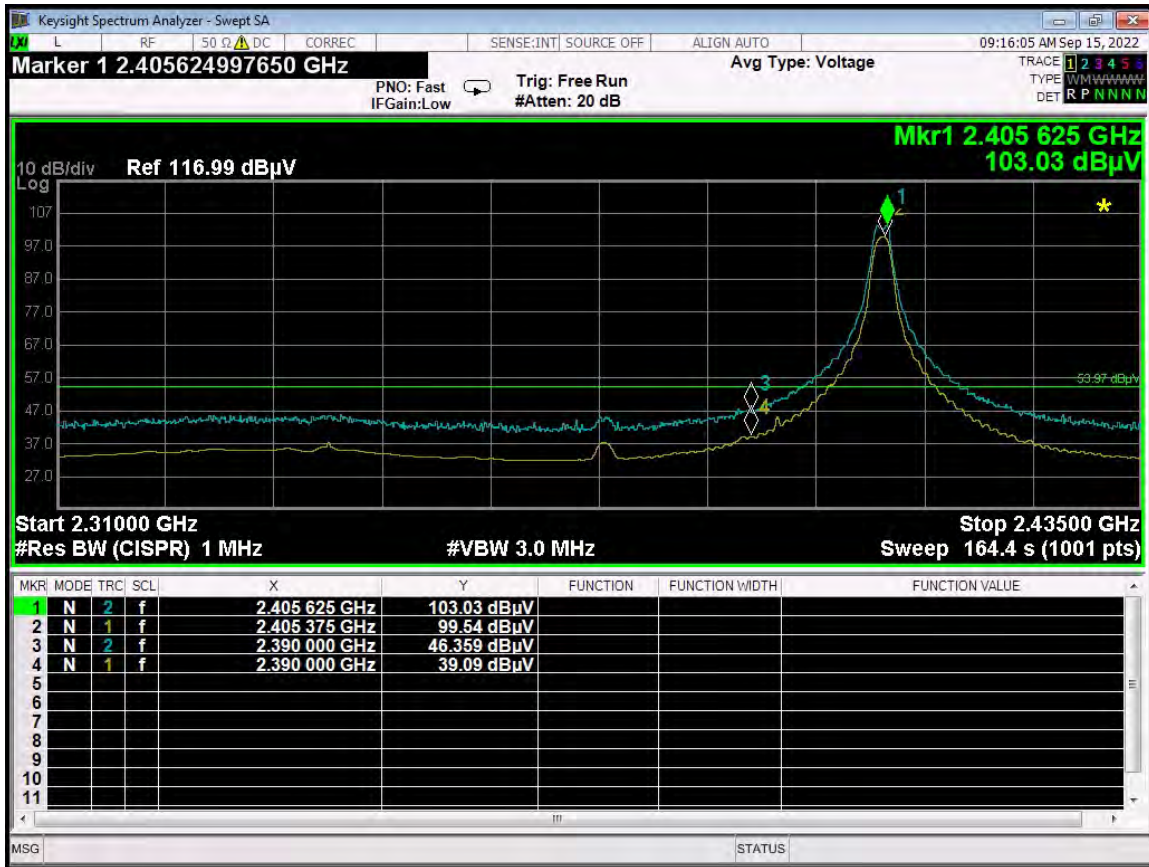

Brea Division
 114 Olinda Drive
 Brea, CA 92823
 (714) 579-0500

Lake Forest Division
 20621 Pascal Way
 Lake Forest, CA 92630
 (949) 587-0400

Newbury Park Division
 1050 Lawrence Drive
 Newbury Park, CA 91320
 (805) 480-4044



FCC Part 15 Subpart B and C; FCC Section 15.247; RSS-247; and RSS-GEN Test Report
 Vivint ZigBee Bridge
 Model: BB03

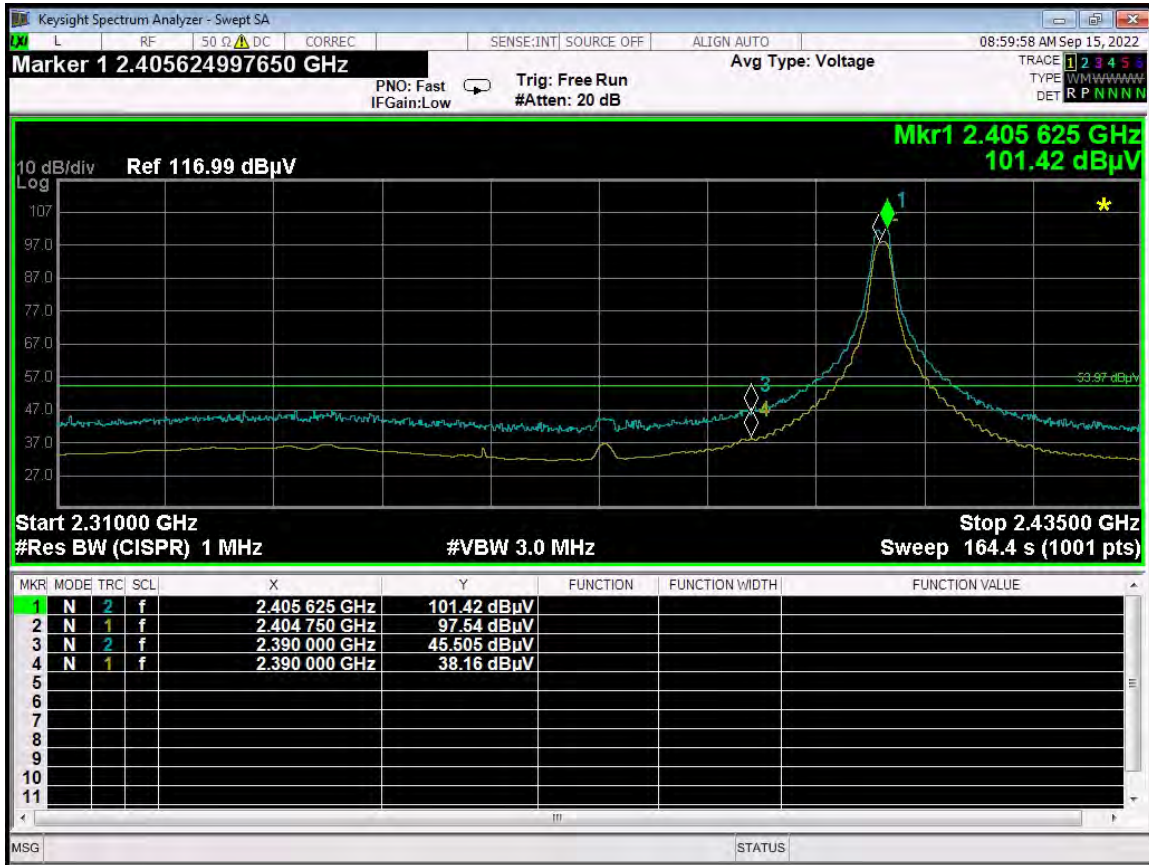

Brea Division
 114 Olinda Drive
 Brea, CA 92823
 (714) 579-0500

Lake Forest Division
 20621 Pascal Way
 Lake Forest, CA 92630
 (949) 587-0400

Newbury Park Division
 1050 Lawrence Drive
 Newbury Park, CA 91320
 (805) 480-4044

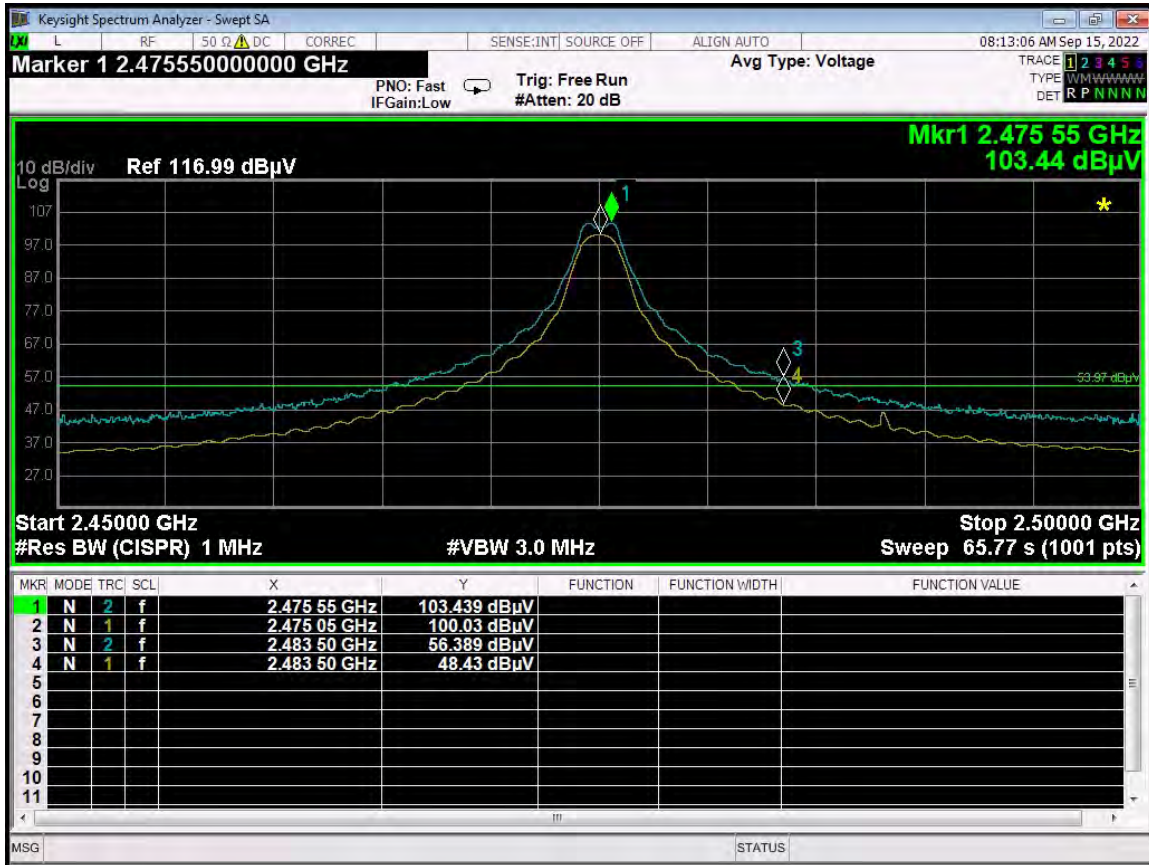

Brea Division
 114 Olinda Drive
 Brea, CA 92823
 (714) 579-0500

Lake Forest Division
 20621 Pascal Way
 Lake Forest, CA 92630
 (949) 587-0400

Newbury Park Division
 1050 Lawrence Drive
 Newbury Park, CA 91320
 (805) 480-4044



FCC Part 15 Subpart B and C; FCC Section 15.247; RSS-247; and RSS-GEN Test Report

Vivint ZigBee Bridge

Model: BB03

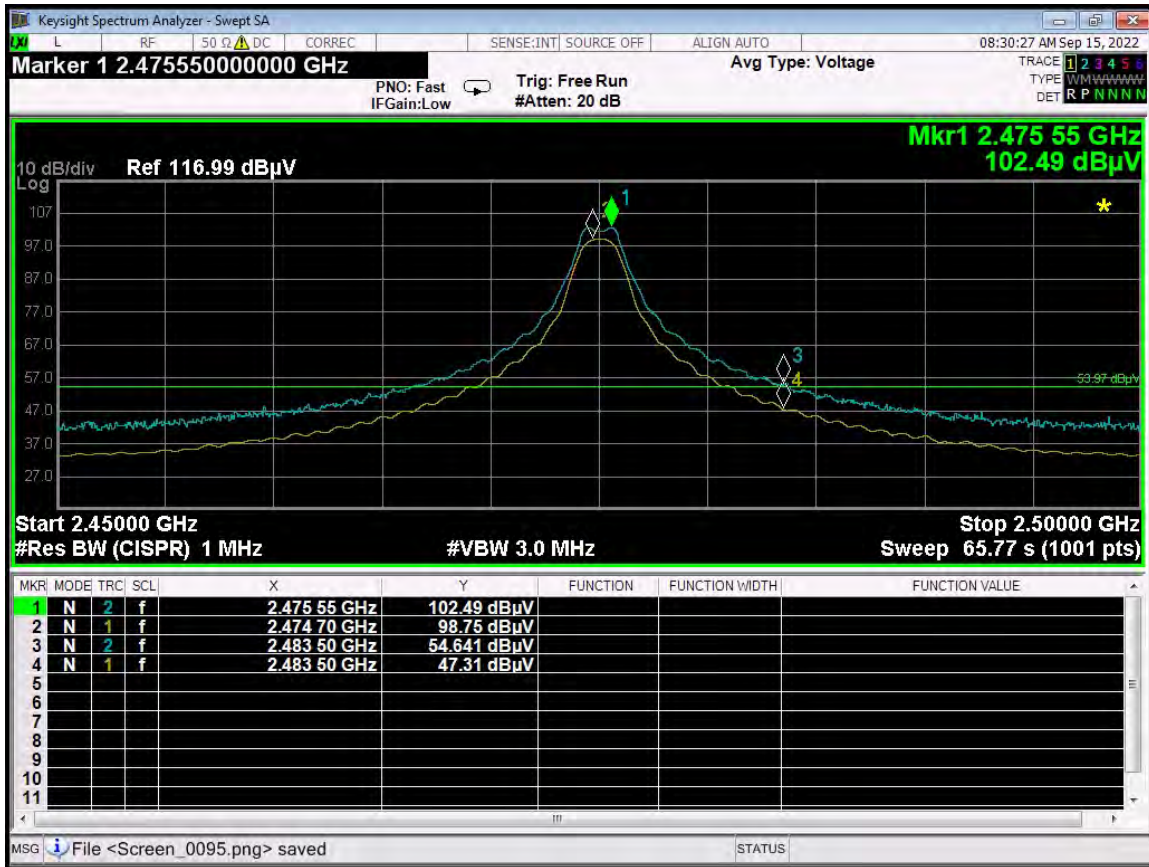

Brea Division
 114 Olinda Drive
 Brea, CA 92823
 (714) 579-0500

Lake Forest Division
 20621 Pascal Way
 Lake Forest, CA 92630
 (949) 587-0400

Newbury Park Division
 1050 Lawrence Drive
 Newbury Park, CA 91320
 (805) 480-4044



***DTS BANDWIDTH
DATA SHEETS
ANTENNA "0"***

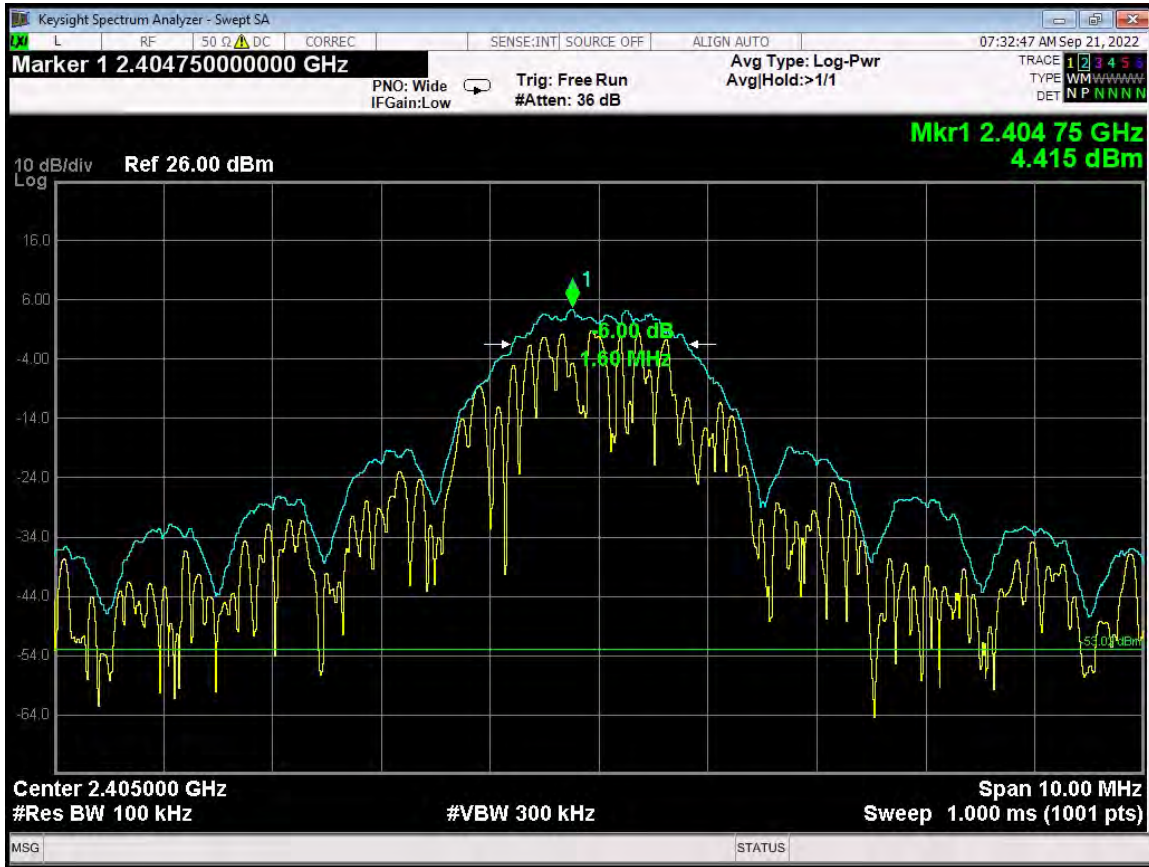

Bandwidth 6 dB - ANT 0 - 2405 MHz

Brea Division
 114 Olinda Drive
 Brea, CA 92823
 (714) 579-0500

Lake Forest Division
 20621 Pascal Way
 Lake Forest, CA 92630
 (949) 587-0400

Newbury Park Division
 1050 Lawrence Drive
 Newbury Park, CA 91320
 (805) 480-4044



Bandwidth 6 dB - ANT 0 - 2440 MHz

Brea Division
 114 Olinda Drive
 Brea, CA 92823
 (714) 579-0500

Lake Forest Division
 20621 Pascal Way
 Lake Forest, CA 92630
 (949) 587-0400

Newbury Park Division
 1050 Lawrence Drive
 Newbury Park, CA 91320
 (805) 480-4044



Bandwidth 6 dB - ANT 0 - 2475 MHz

Brea Division
 114 Olinda Drive
 Brea, CA 92823
 (714) 579-0500

Lake Forest Division
 20621 Pascal Way
 Lake Forest, CA 92630
 (949) 587-0400

Newbury Park Division
 1050 Lawrence Drive
 Newbury Park, CA 91320
 (805) 480-4044



***DTS BANDWIDTH
DATA SHEETS
ANTENNA "1"***



Bandwidth 6 dB - ANT 1 - 2405 MHz

Brea Division
114 Olinda Drive
Brea, CA 92823
(714) 579-0500

Lake Forest Division
20621 Pascal Way
Lake Forest, CA 92630
(949) 587-0400

Newbury Park Division
1050 Lawrence Drive
Newbury Park, CA 91320
(805) 480-4044



Bandwidth 6 dB - ANT 1 - 2440 MHz

Brea Division
 114 Olinda Drive
 Brea, CA 92823
 (714) 579-0500

Lake Forest Division
 20621 Pascal Way
 Lake Forest, CA 92630
 (949) 587-0400

Newbury Park Division
 1050 Lawrence Drive
 Newbury Park, CA 91320
 (805) 480-4044



Bandwidth 6 dB - ANT 1 - 2475 MHz

Brea Division
114 Olinda Drive
Brea, CA 92823
(714) 579-0500

Lake Forest Division
20621 Pascal Way
Lake Forest, CA 92630
(949) 587-0400

Newbury Park Division
1050 Lawrence Drive
Newbury Park, CA 91320
(805) 480-4044



***PEAK OUTPUT POWER
DATA SHEETS
ANTENNA "0"***

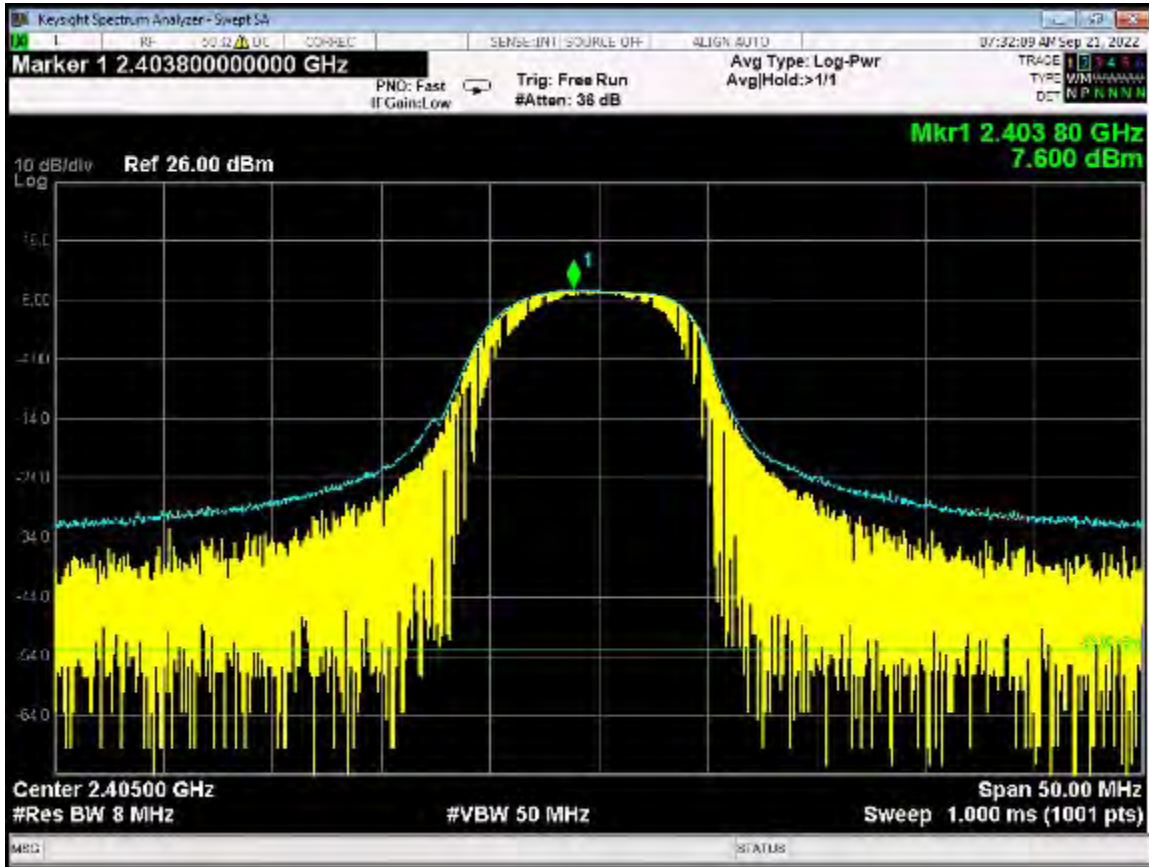

Peak Power Output – ANT 0 – 2405 MHz

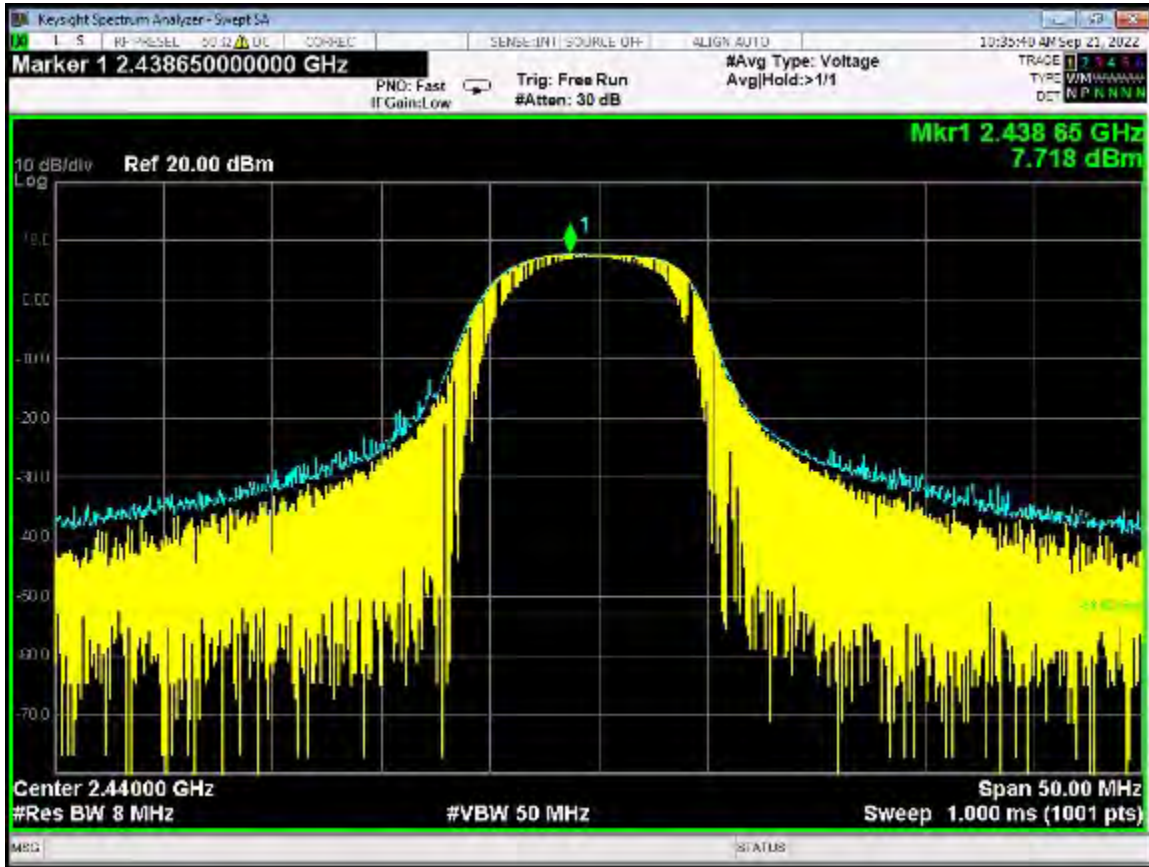

Peak Power Output – ANT 0 – 2440 MHz

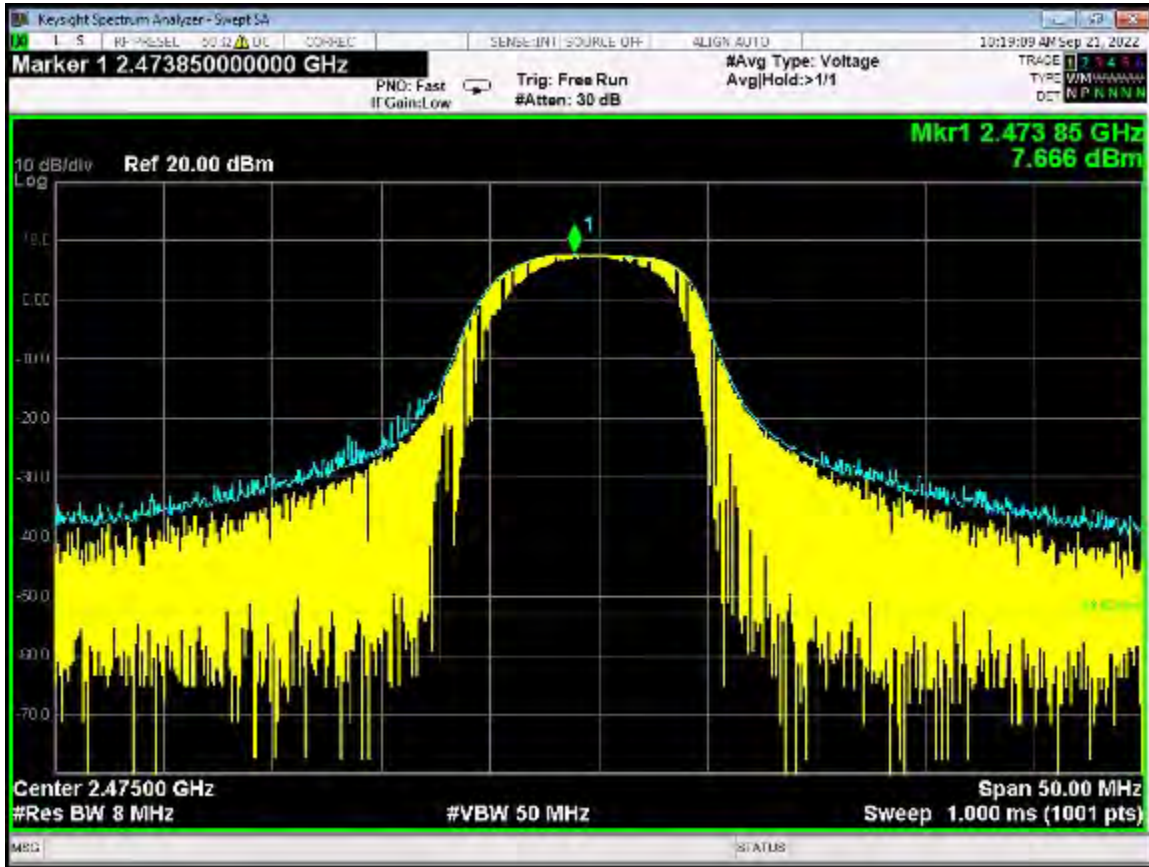

Peak Power Output – ANT 0 – 2475 MHz



***PEAK OUTPUT POWER
DATA SHEETS
ANTENNA "1"***

Brea Division
114 Olinda Drive
Brea, CA 92823
(714) 579-0500

Lake Forest Division
20621 Pascal Way
Lake Forest, CA 92630
(949) 587-0400

Newbury Park Division
1050 Lawrence Drive
Newbury Park, CA 91320
(805) 480-4044

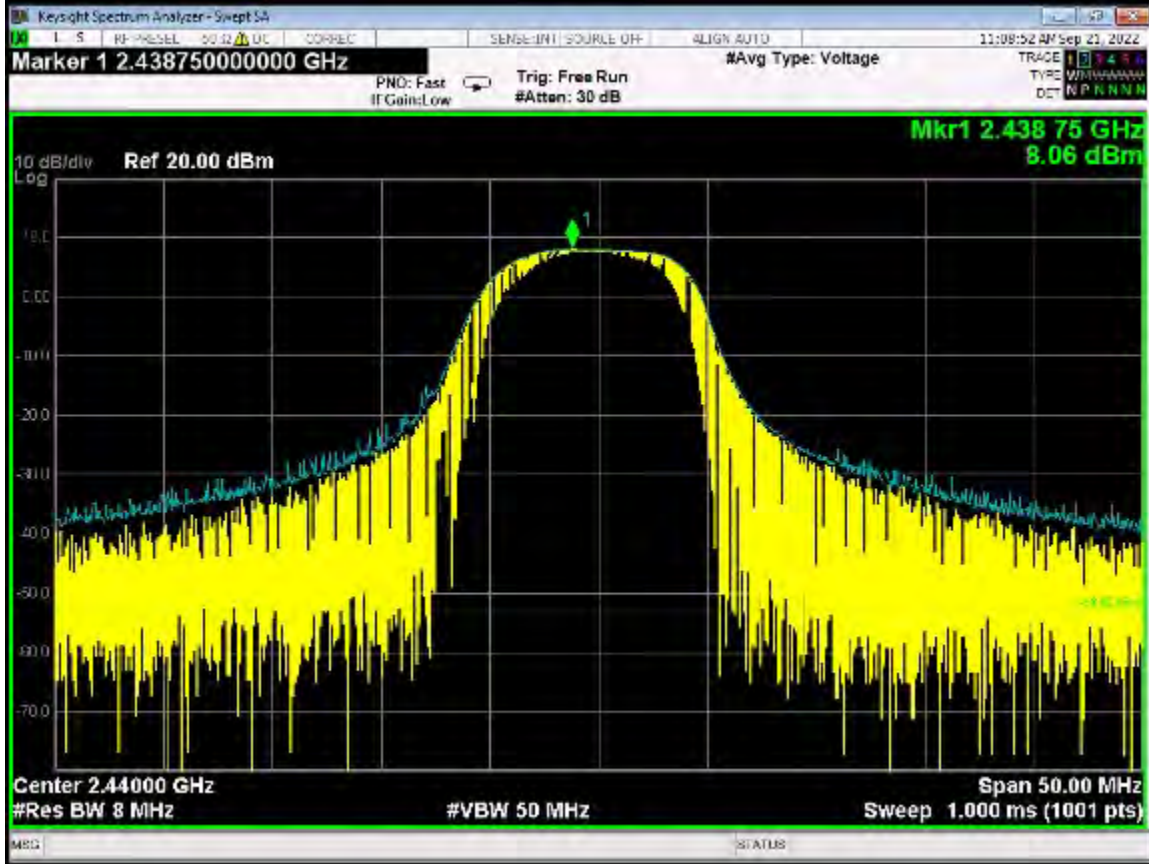

Peak Power Output – ANT 1 – 2440 MHz

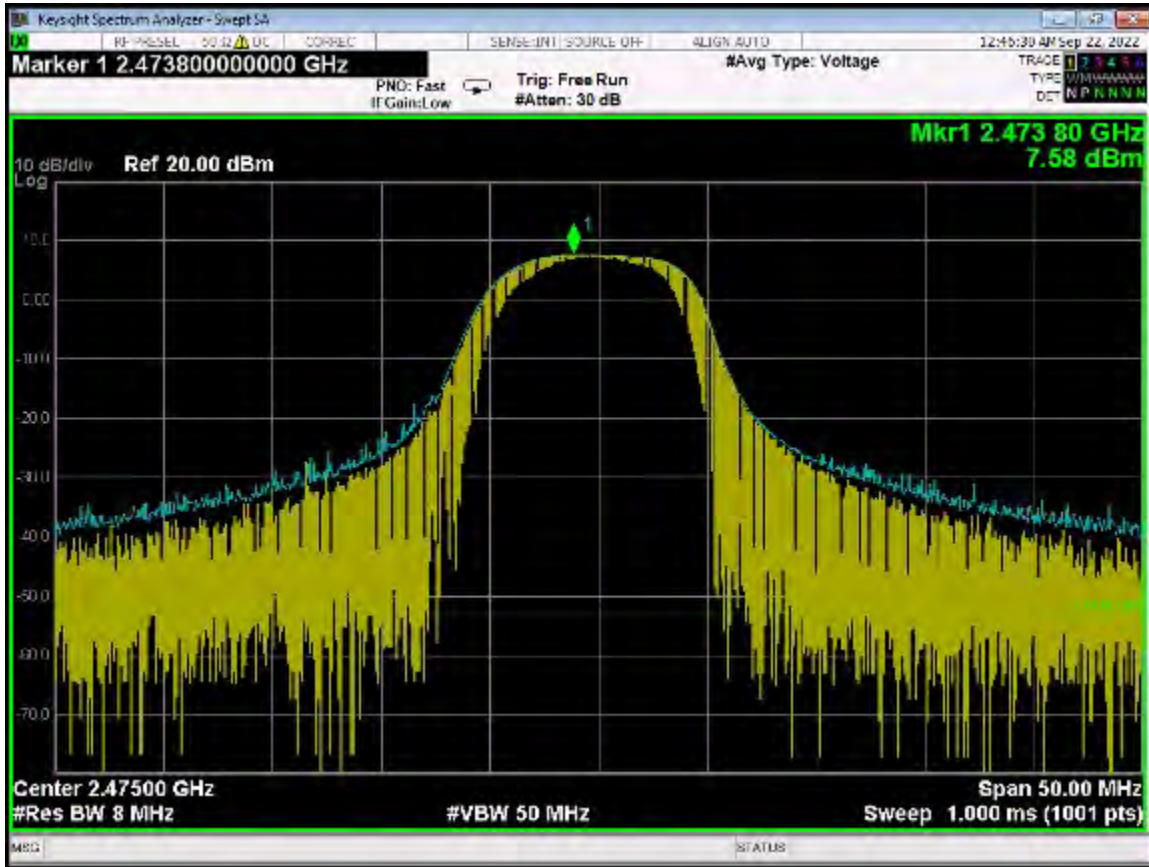

Peak Power Output – ANT 1 – 2475 MHz



***SPECTRAL DENSITY OUTPUT
DATA SHEETS
ANTENNA "0"***

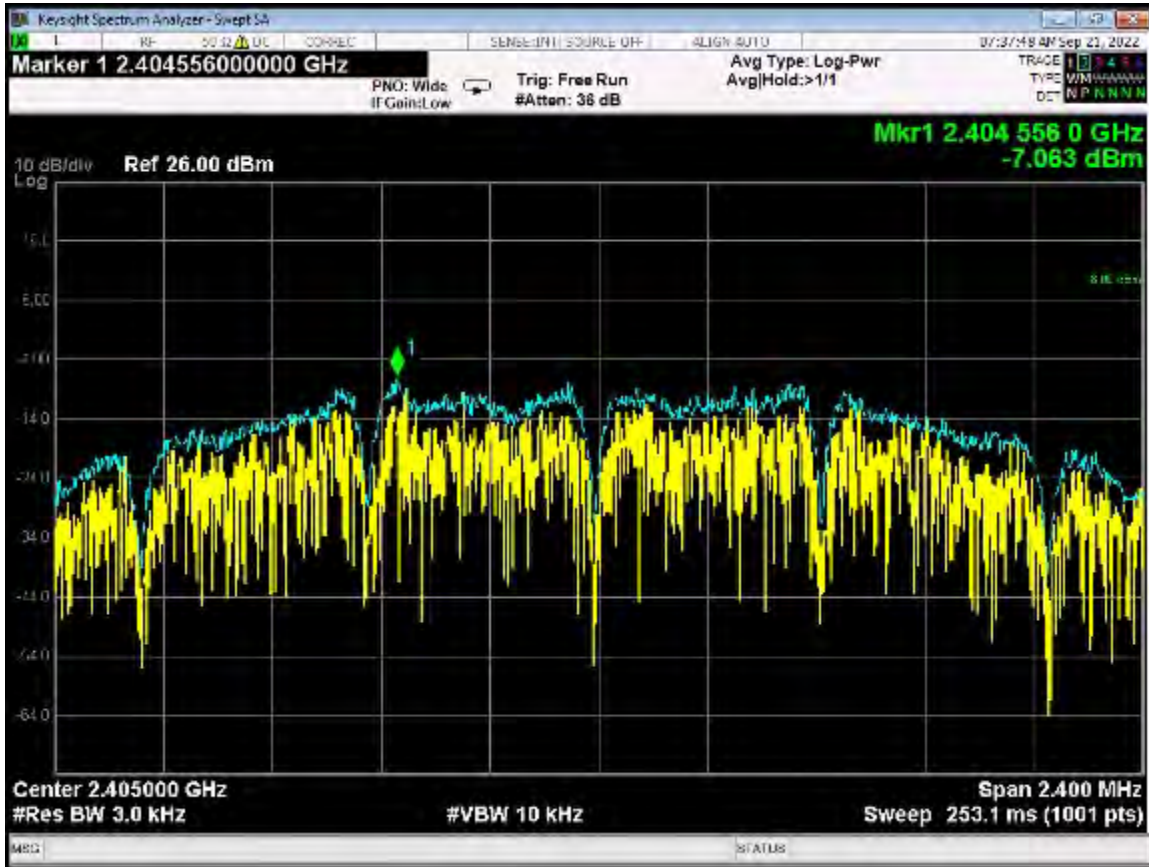

Special Density Output - ANT 0 - 2405 MHz

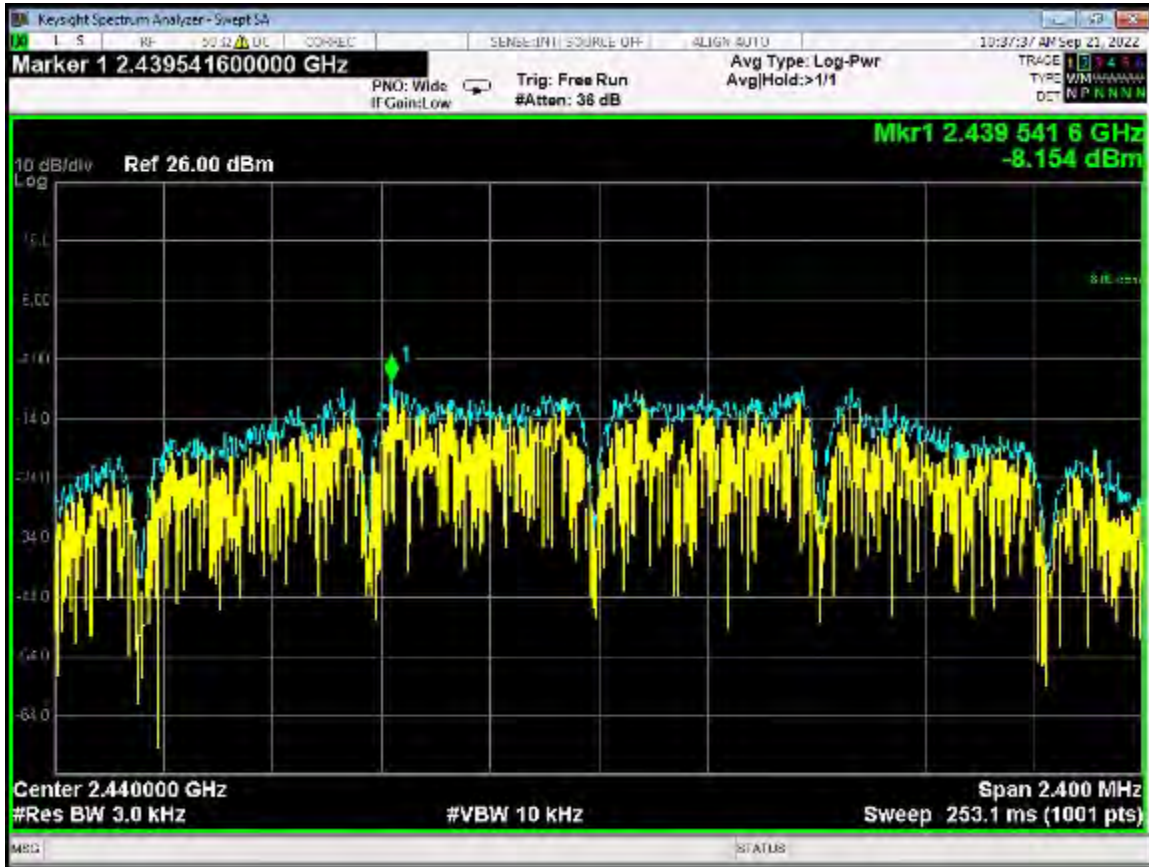

Special Density Output - ANT 0 - 2440 MHz

Brea Division
 114 Olinda Drive
 Brea, CA 92823
 (714) 579-0500

Lake Forest Division
 20621 Pascal Way
 Lake Forest, CA 92630
 (949) 587-0400

Newbury Park Division
 1050 Lawrence Drive
 Newbury Park, CA 91320
 (805) 480-4044

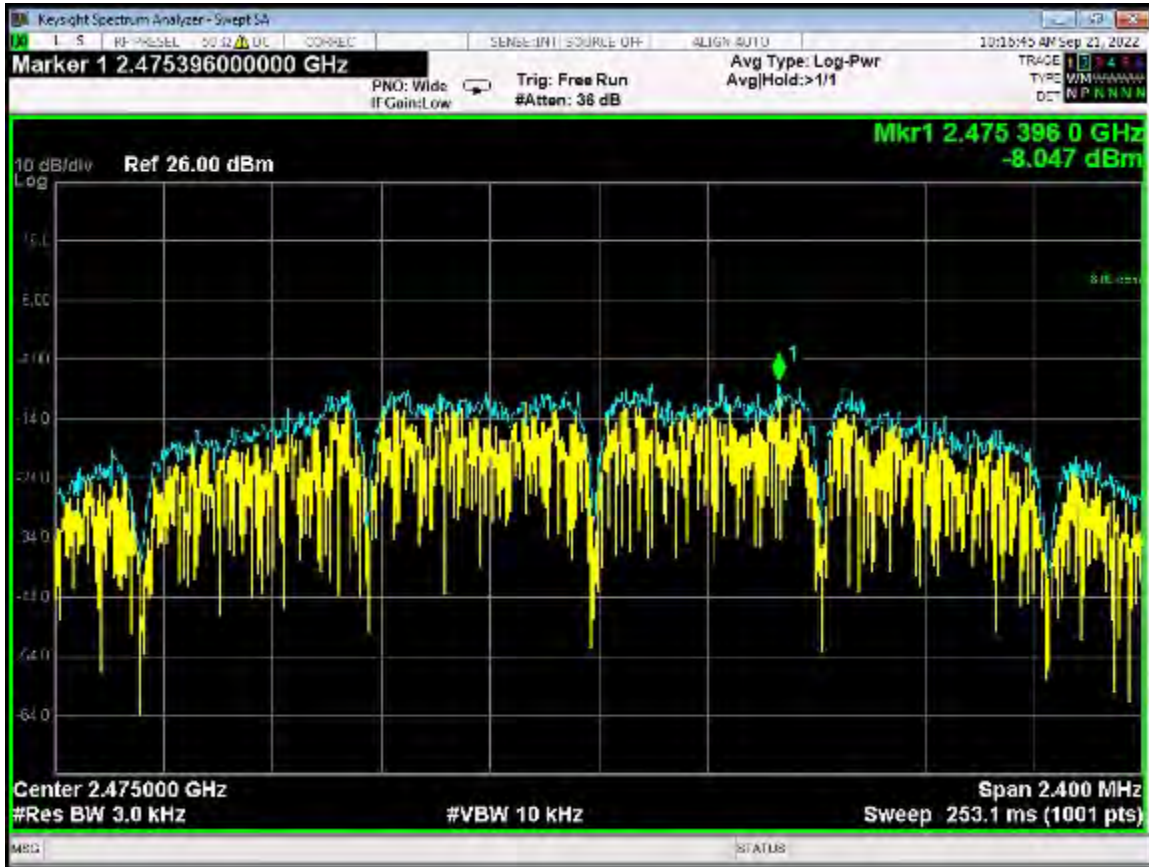

Special Density Output - ANT 0 - 2475 MHz



***SPECTRAL DENSITY OUTPUT
DATA SHEETS
ANTENNA "1"***

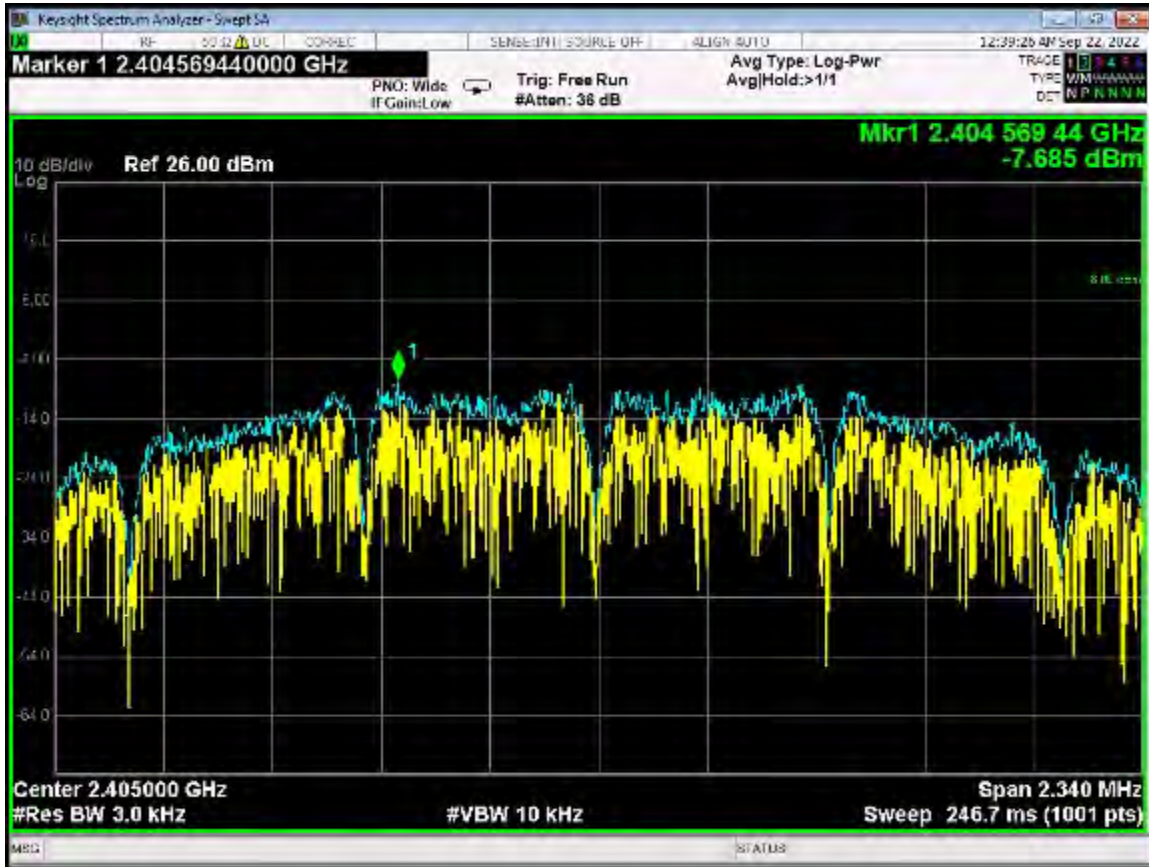

Special Density Output - ANT 1 - 2405 MHz

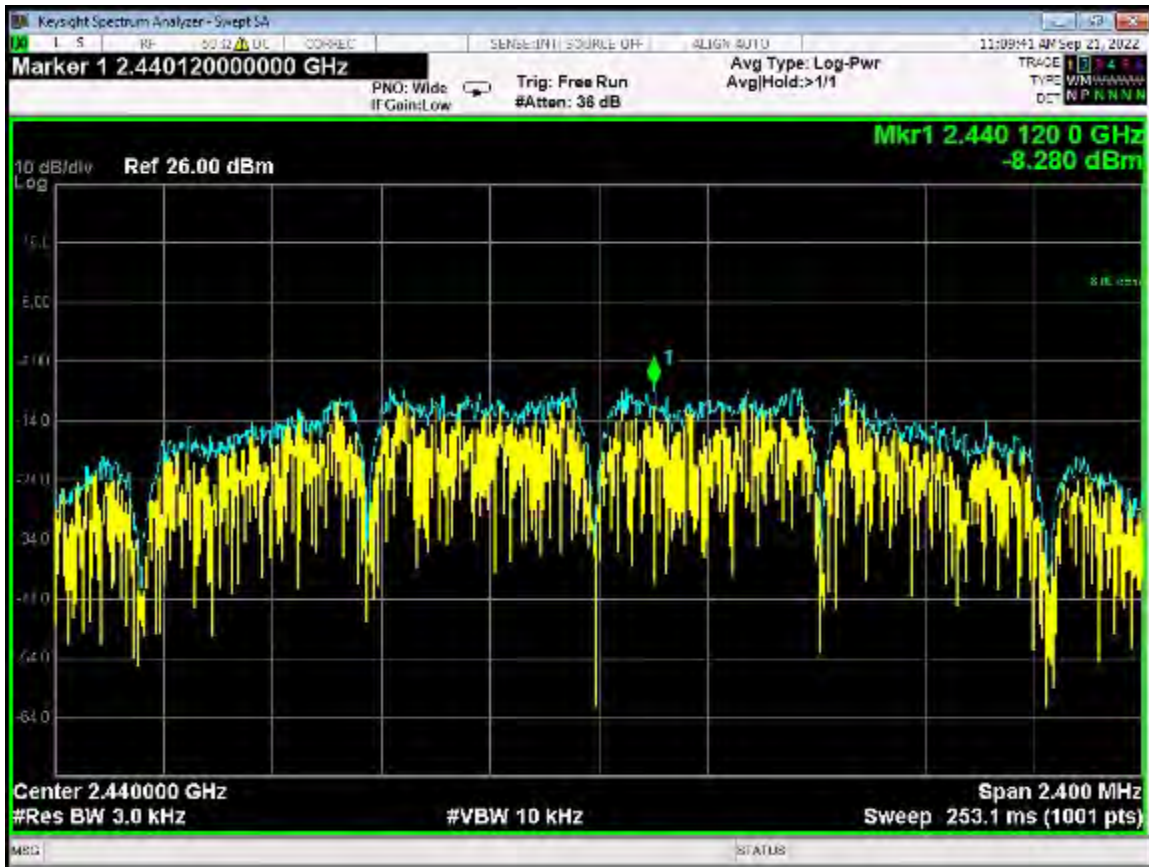

Special Density Output - ANT 1 - 2440 MHz

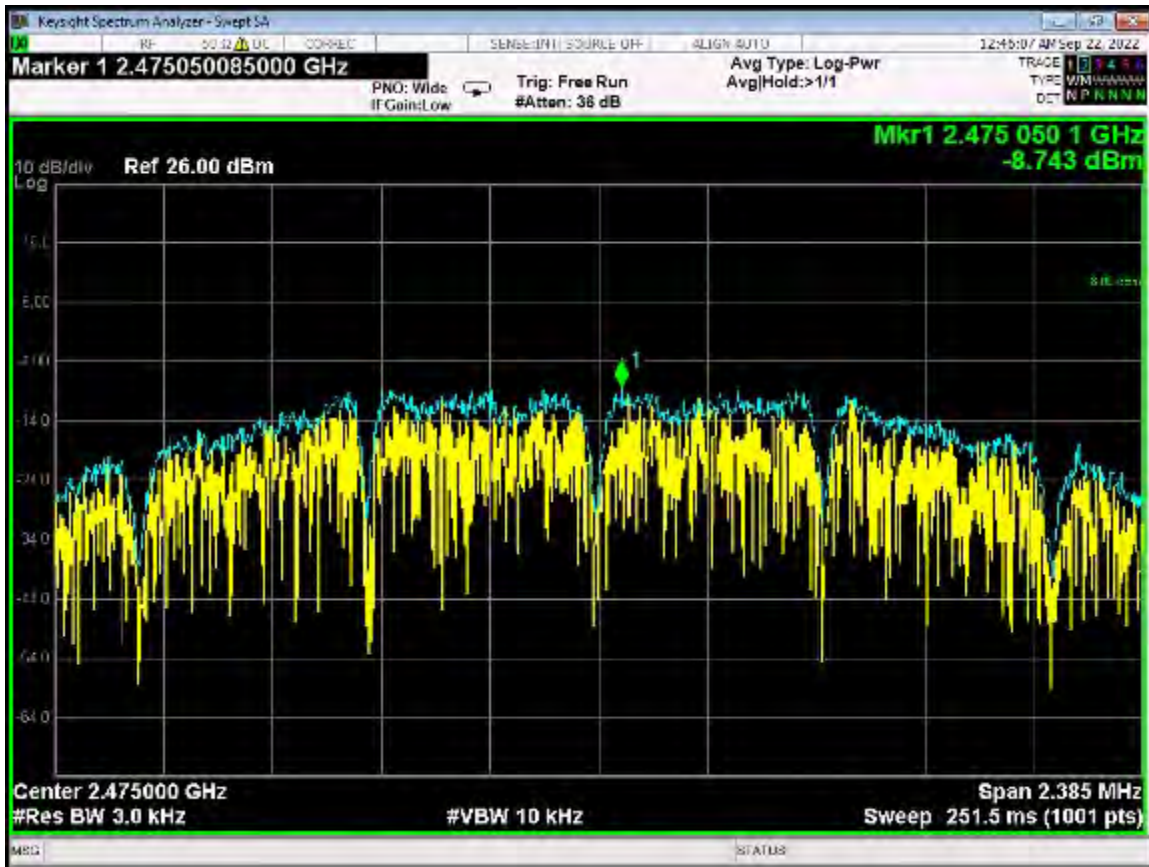

Special Density Output - ANT 1 - 2475 MHz



***99% BANDWIDTH
DATA SHEETS
ANTENNA "0"***

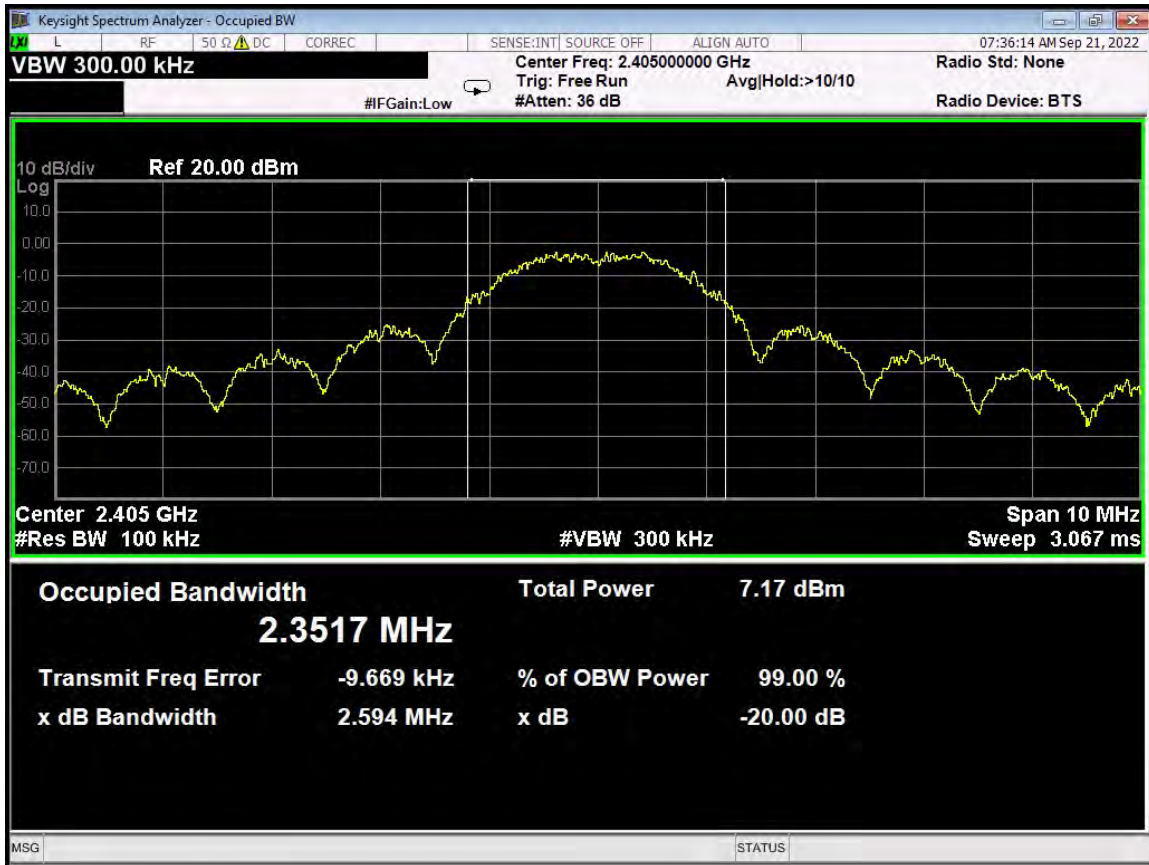

99% Bandwidth - ANT 0- 2405 MHz

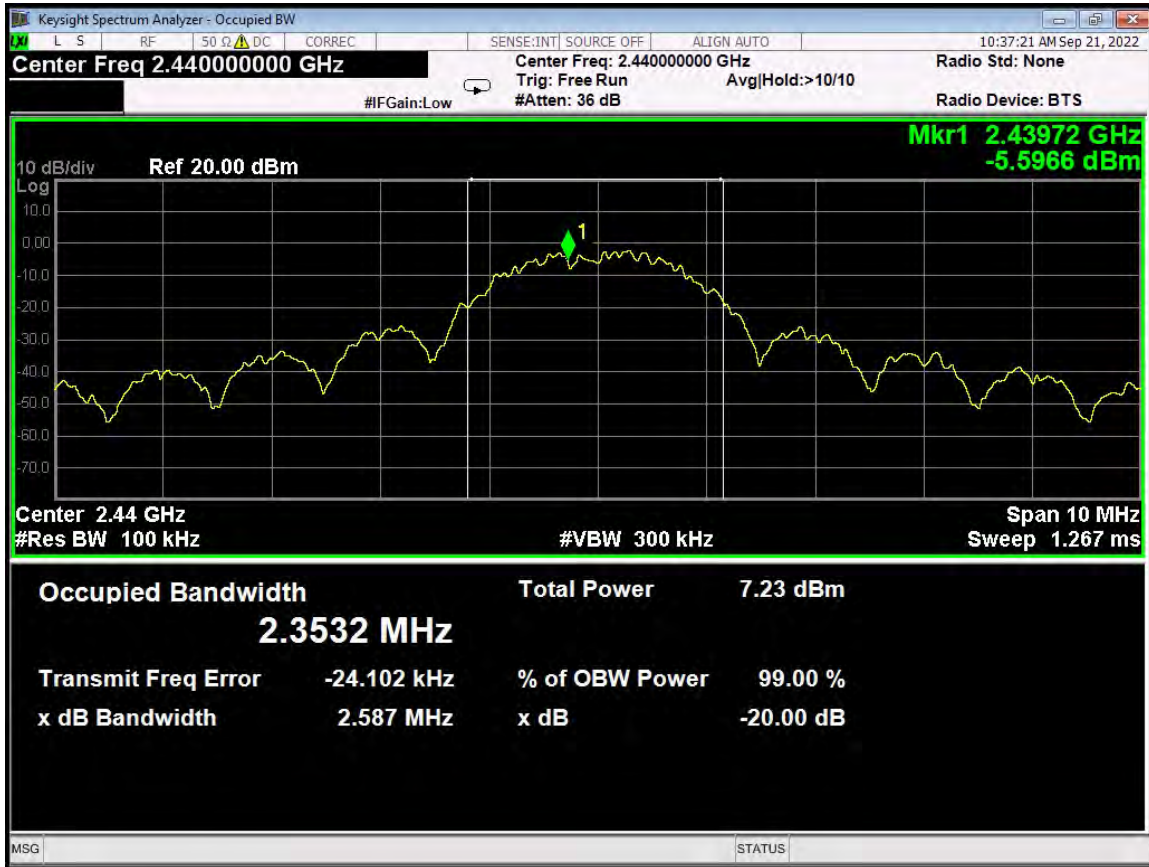

99% Bandwidth - ANT 0 - 2440 MHz

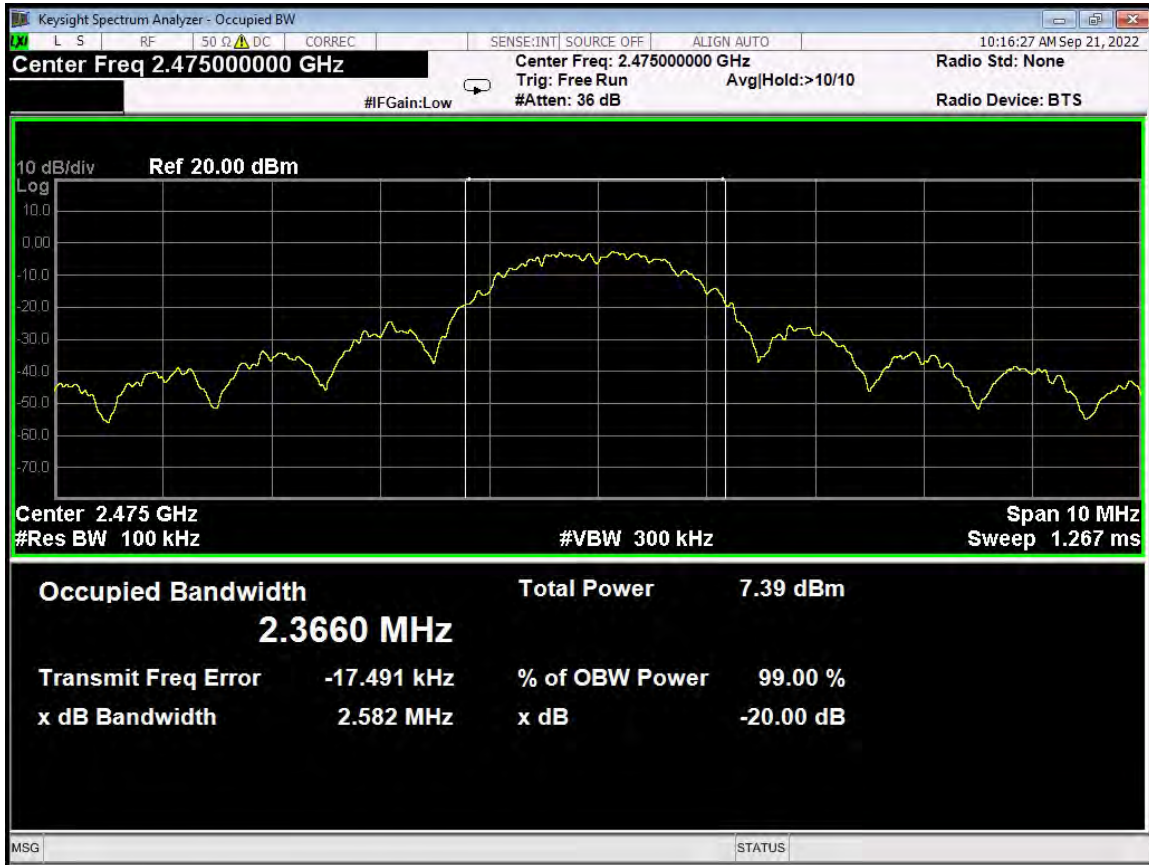

99% Bandwidth - ANT 0 - 2475 MHz



***99% BANDWIDTH
DATA SHEETS
ANTENNA "1"***

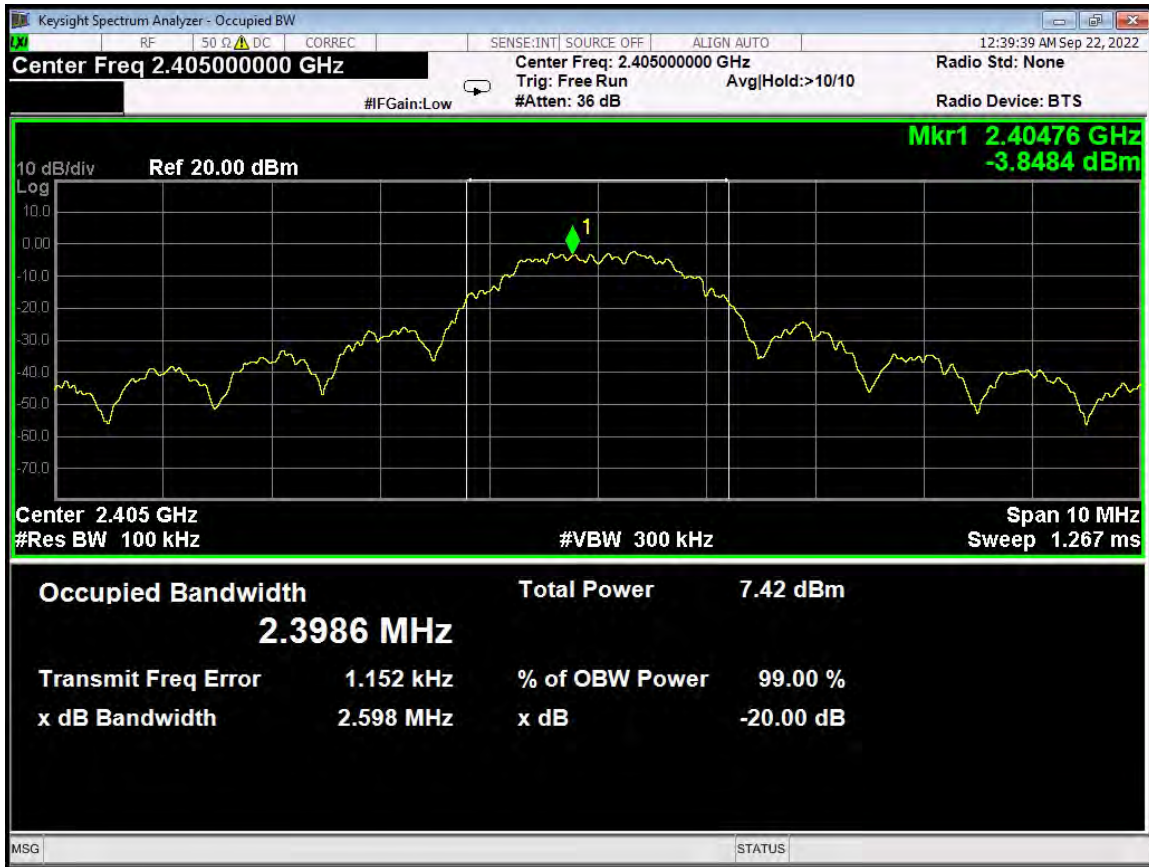

99% Bandwidth - ANT 1- 2405 MHz

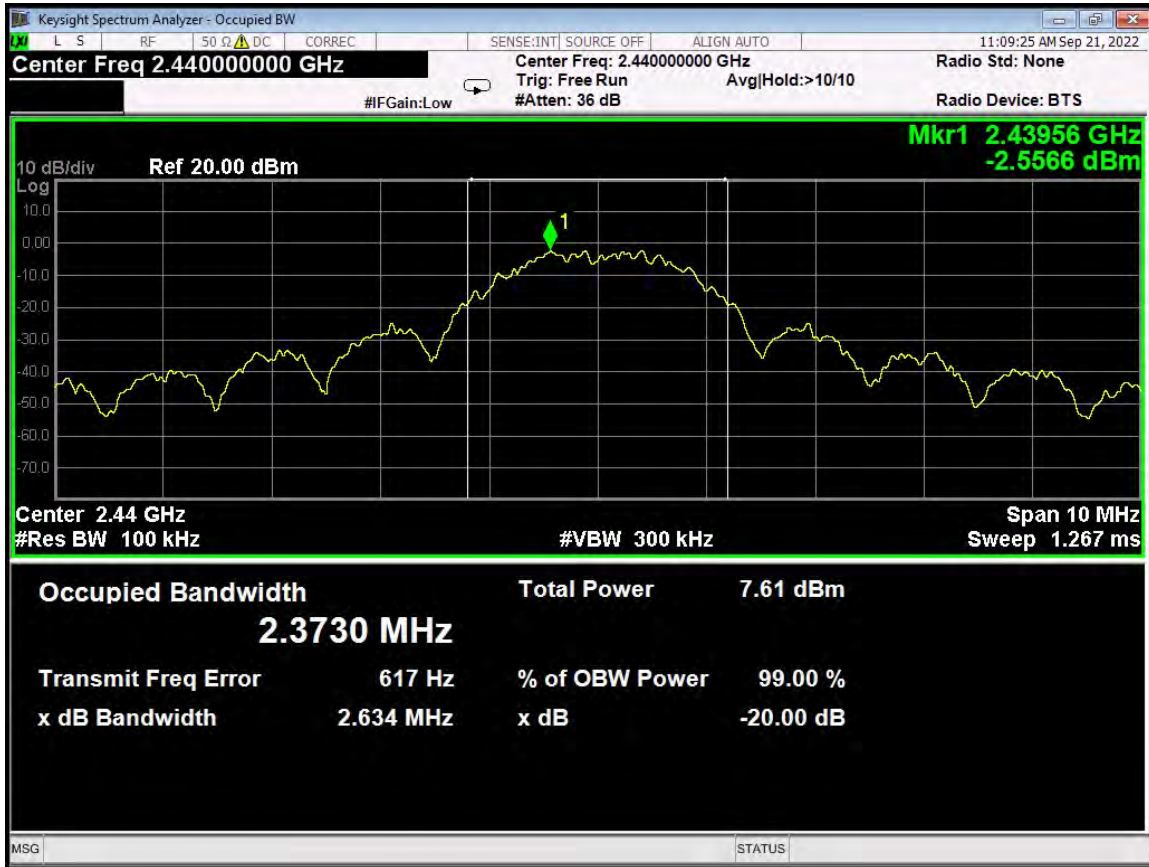

99% Bandwidth - ANT 1 - 2440 MHz

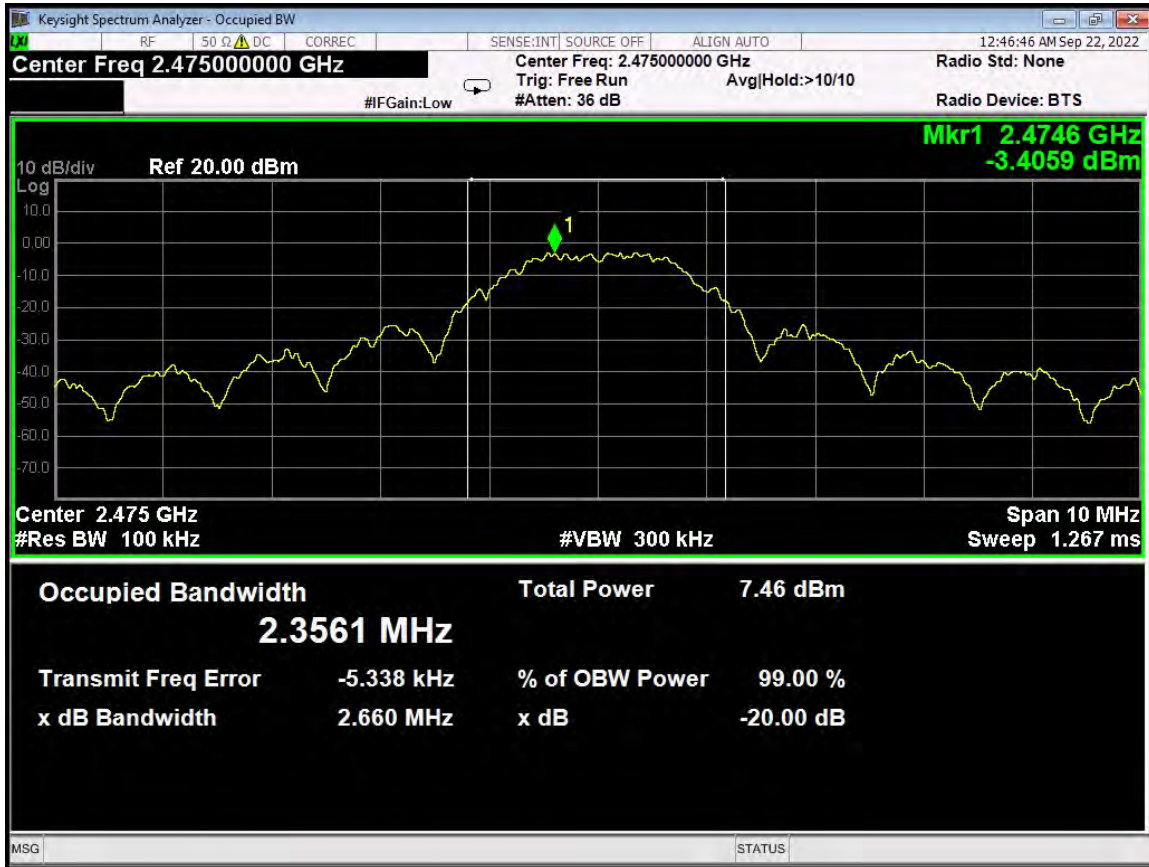

99% Bandwidth - ANT 1 - 2475 MHz



***RF ANTENNA CONDUCTED
DATA SHEETS
ANTENNA "0"***

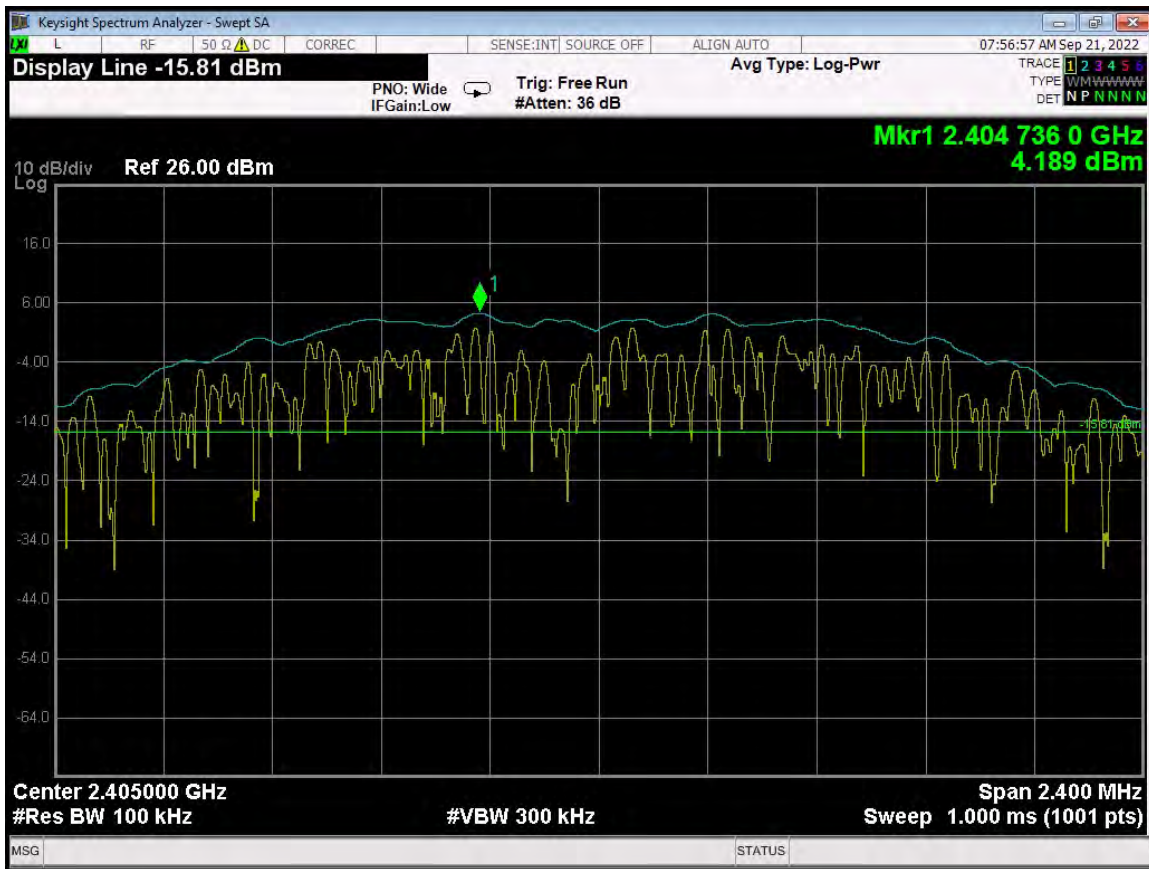

RF Antenna Conducted Test – ANT 0 – Low Channel – Reference Level

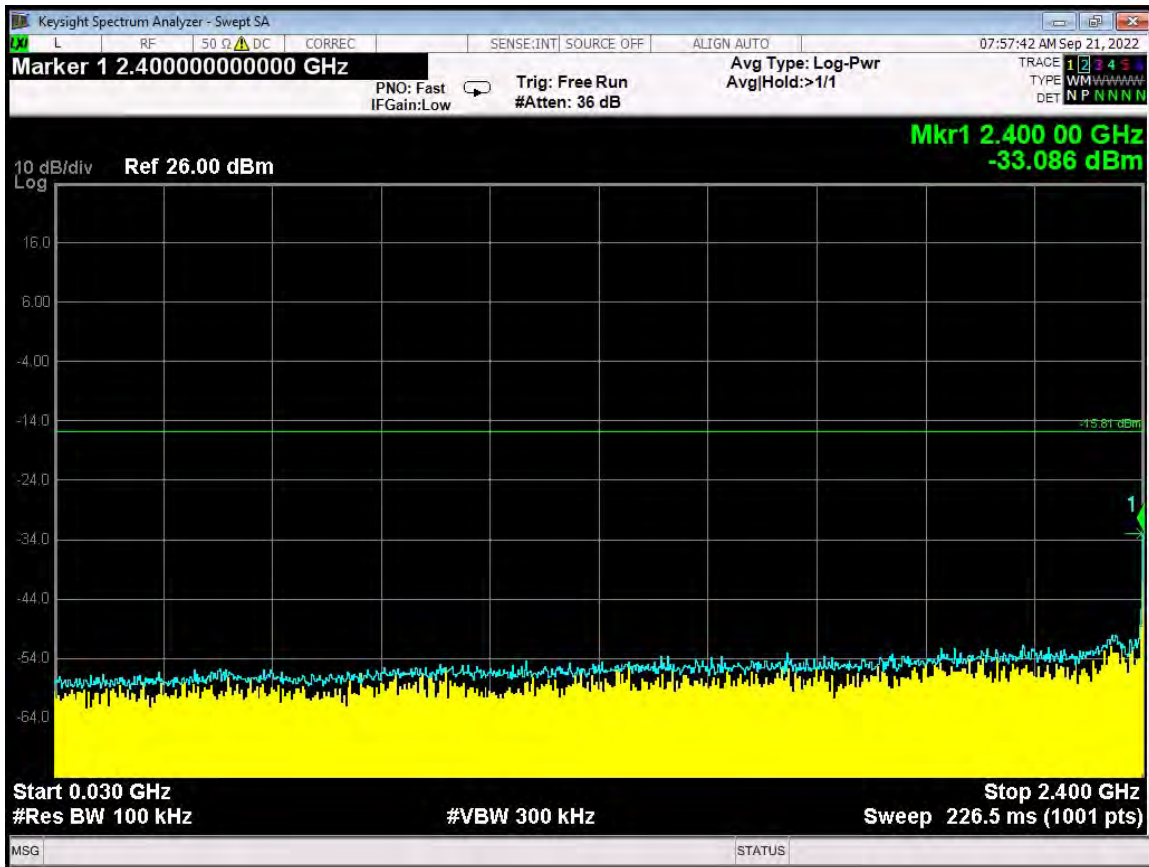

RF Antenna Conducted Test – ANT 0 – Low Channel – 30 MHz to 2.4 GHz

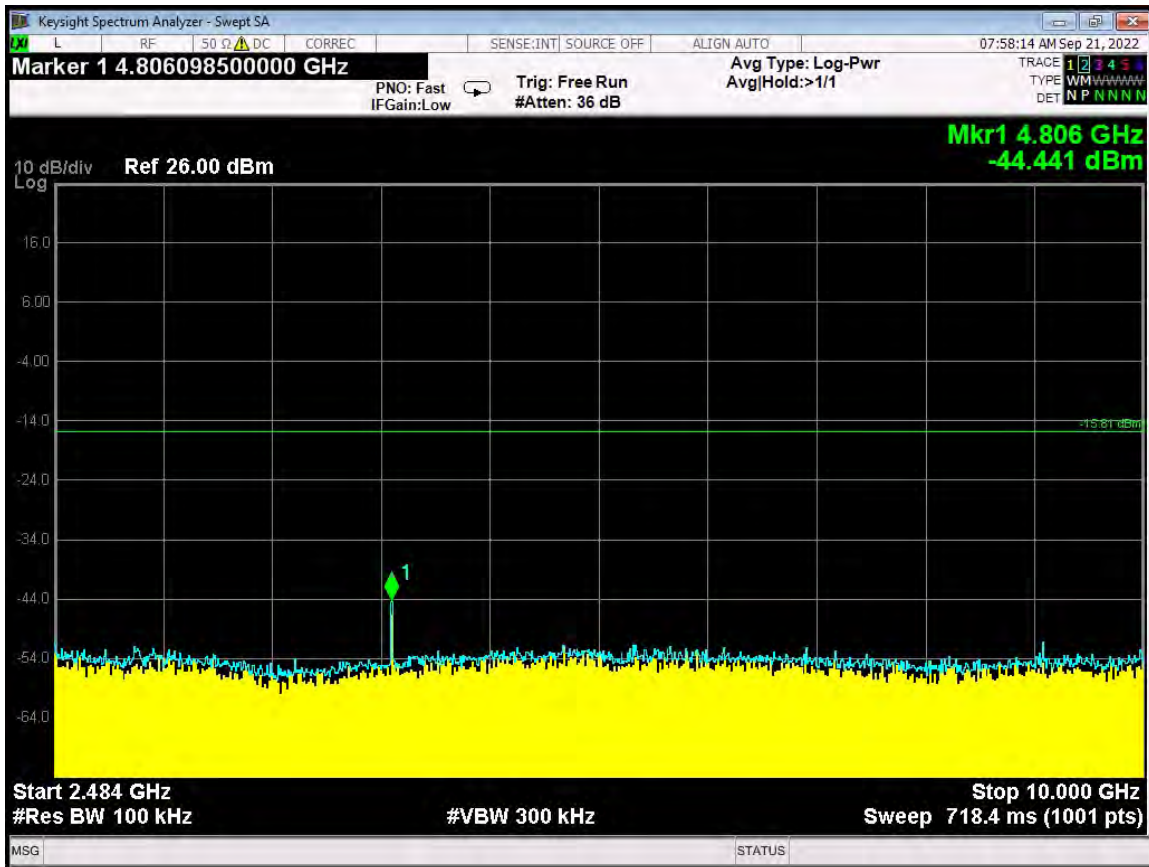

RF Antenna Conducted Test – ANT 0 – Low Channel – 2483.5 MHz to 10 GHz

Brea Division
 114 Olinda Drive
 Brea, CA 92823
 (714) 579-0500

Lake Forest Division
 20621 Pascal Way
 Lake Forest, CA 92630
 (949) 587-0400

Newbury Park Division
 1050 Lawrence Drive
 Newbury Park, CA 91320
 (805) 480-4044

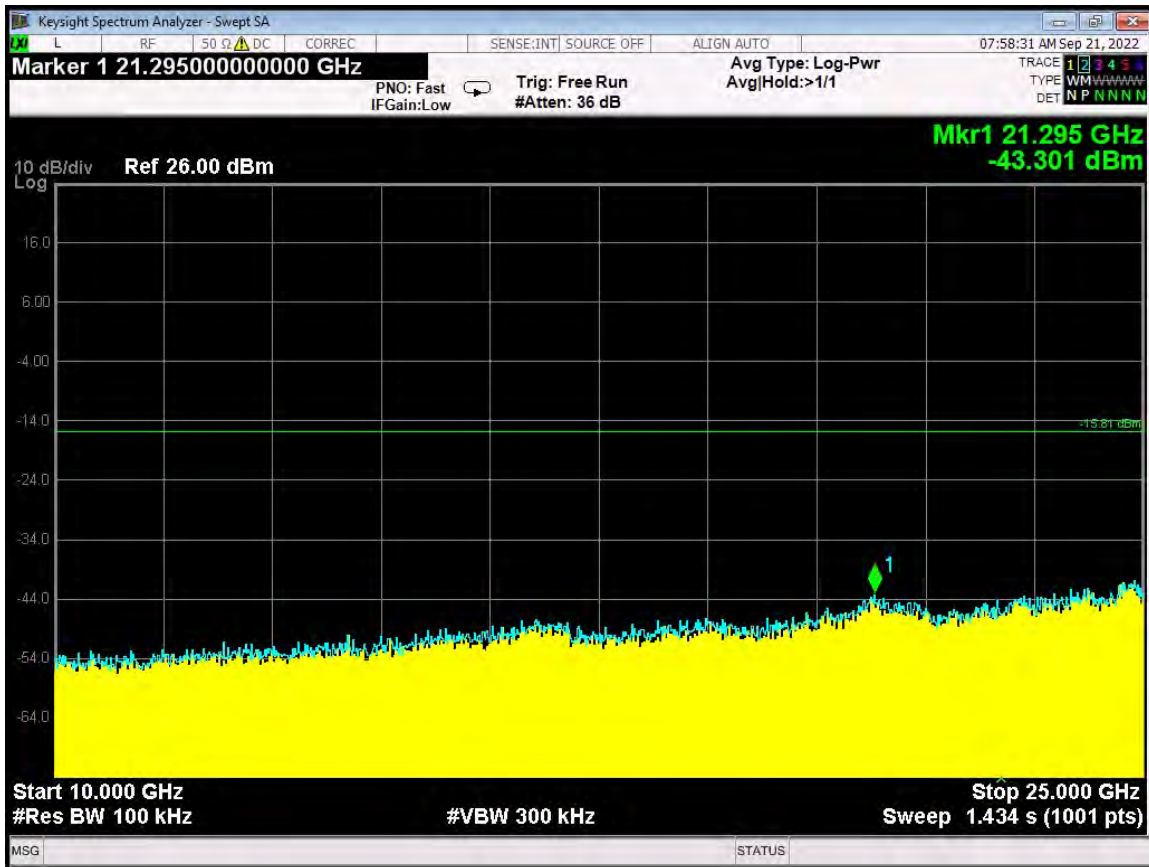

RF Antenna Conducted Test – ANT 0 – Low Channel – 10 GHz to 25 GHz

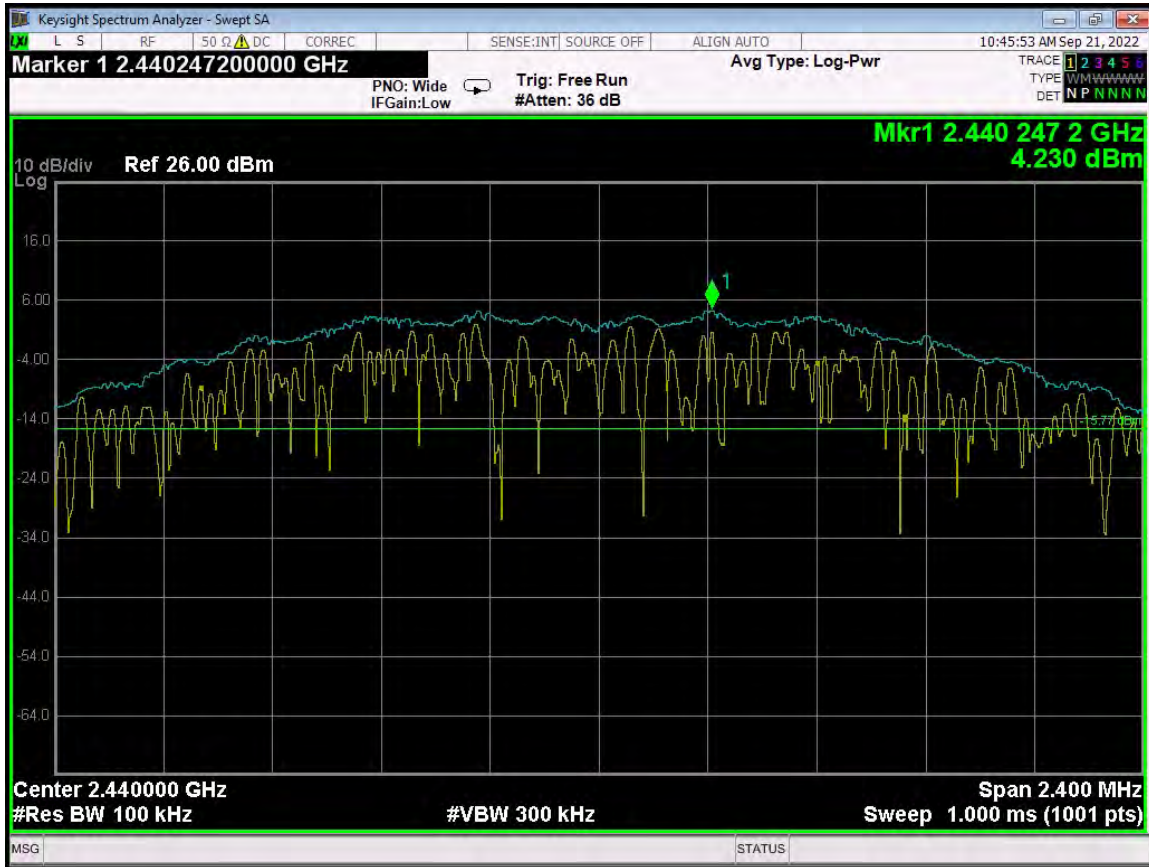

RF Antenna Conducted Test – ANT 0 – Mid Channel – Reference Level

Brea Division
 114 Olinda Drive
 Brea, CA 92823
 (714) 579-0500

Lake Forest Division
 20621 Pascal Way
 Lake Forest, CA 92630
 (949) 587-0400

Newbury Park Division
 1050 Lawrence Drive
 Newbury Park, CA 91320
 (805) 480-4044

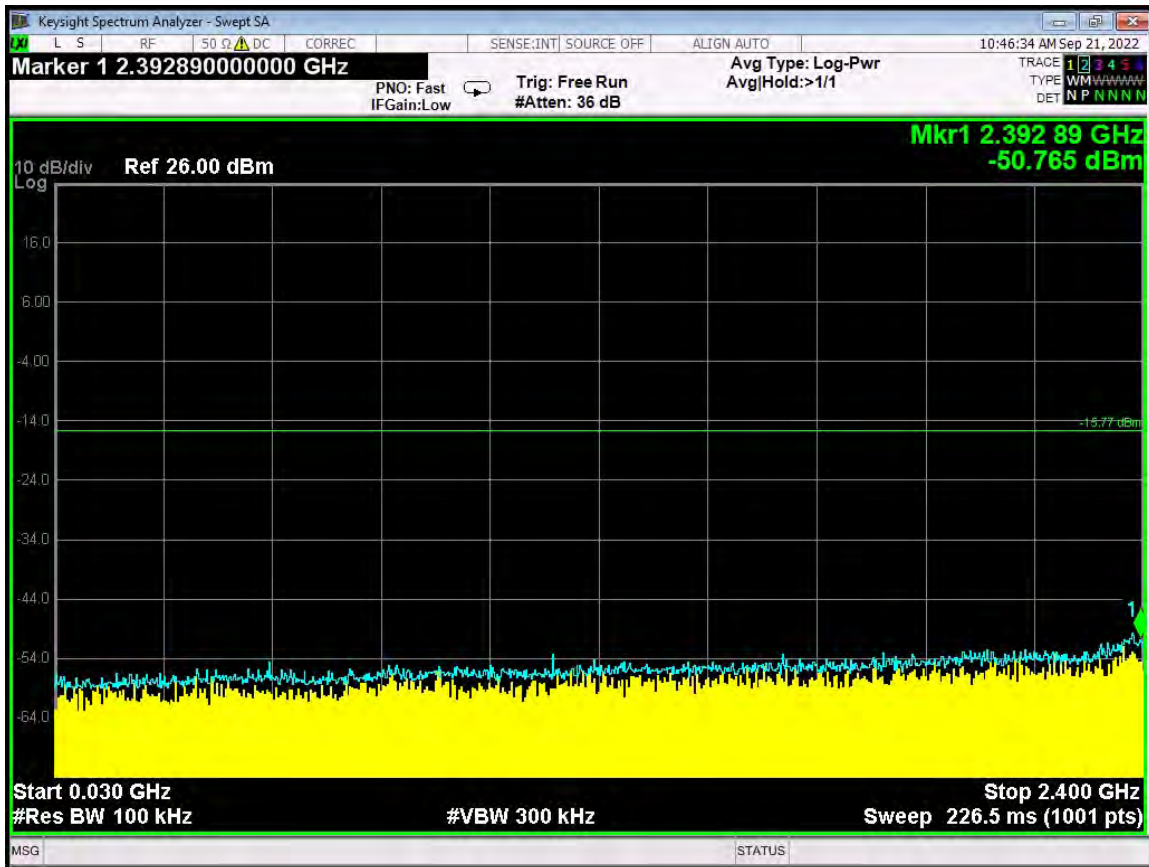

RF Antenna Conducted Test – ANT 0 – Mid Channel – 30 MHz to 2.4 GHz

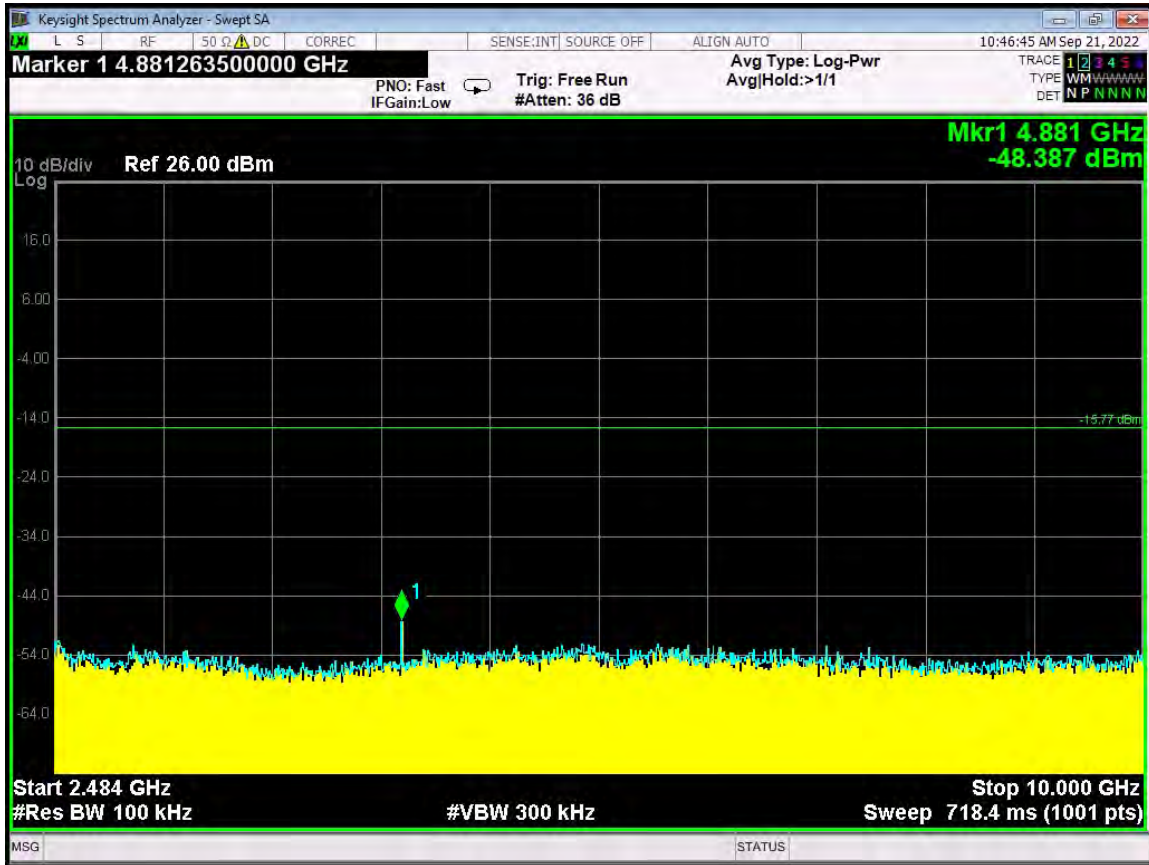

RF Antenna Conducted Test – ANT 0 – Mid Channel – 2483.5 MHz to 10 GHz

Brea Division
 114 Olinda Drive
 Brea, CA 92823
 (714) 579-0500

Lake Forest Division
 20621 Pascal Way
 Lake Forest, CA 92630
 (949) 587-0400

Newbury Park Division
 1050 Lawrence Drive
 Newbury Park, CA 91320
 (805) 480-4044

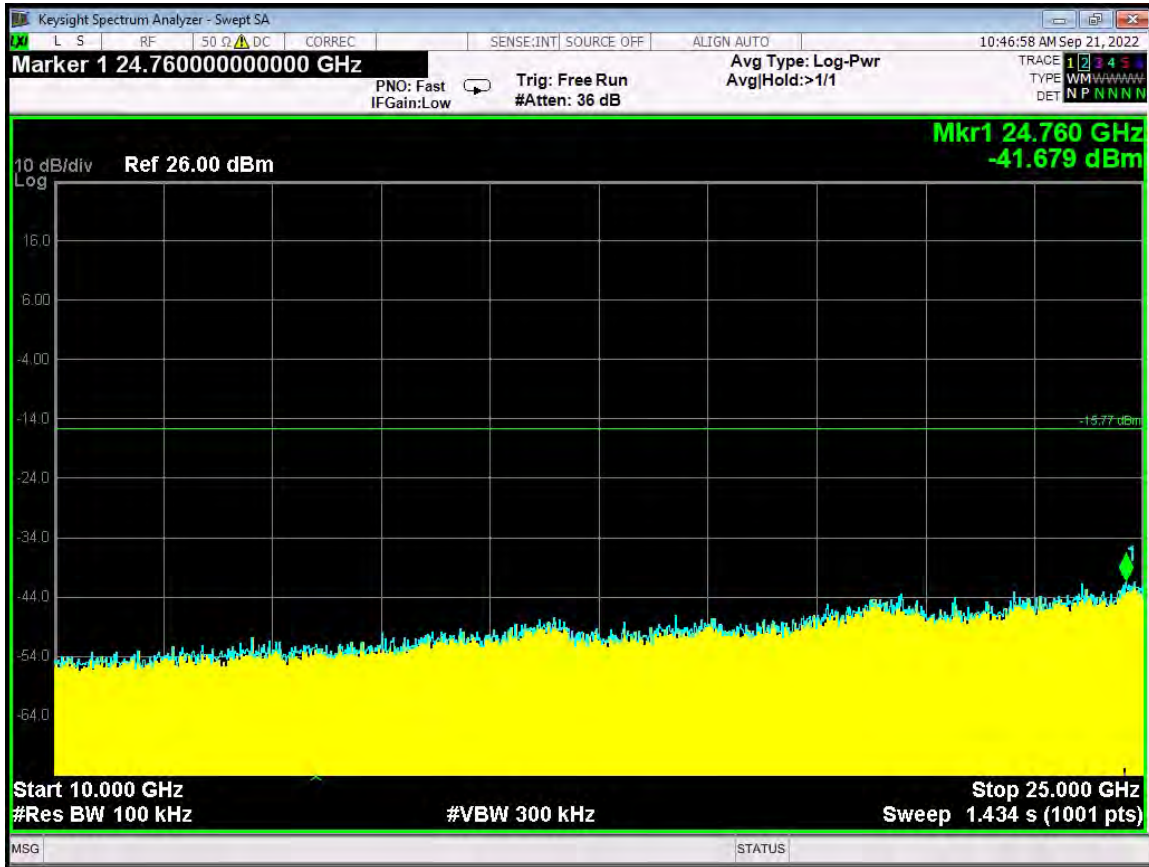

RF Antenna Conducted Test – ANT 0 – Mid Channel – 10 GHz to 25 GHz

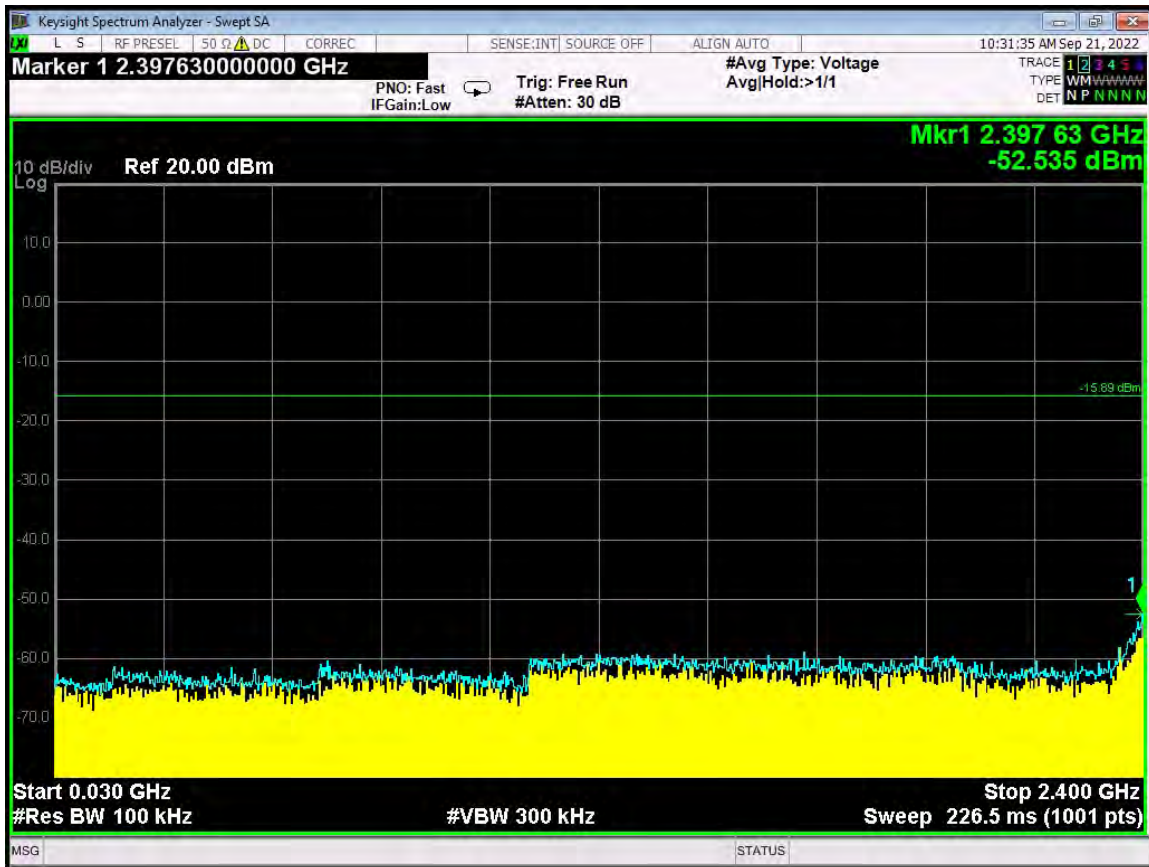

RF Antenna Conducted Test – ANT 0 – High Channel – 30 MHz to 2.4 GHz

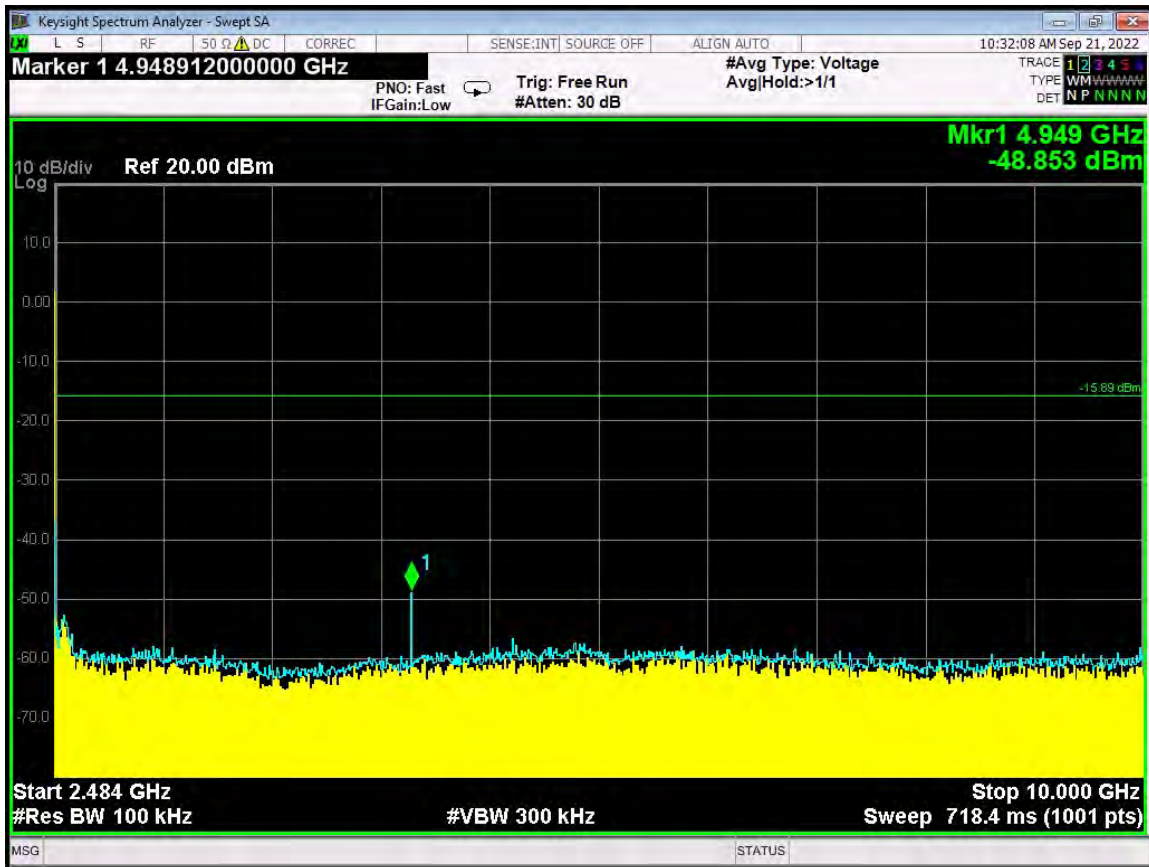

RF Antenna Conducted Test – ANT 0 – High Channel – 2483.5 MHz to 10 GHz

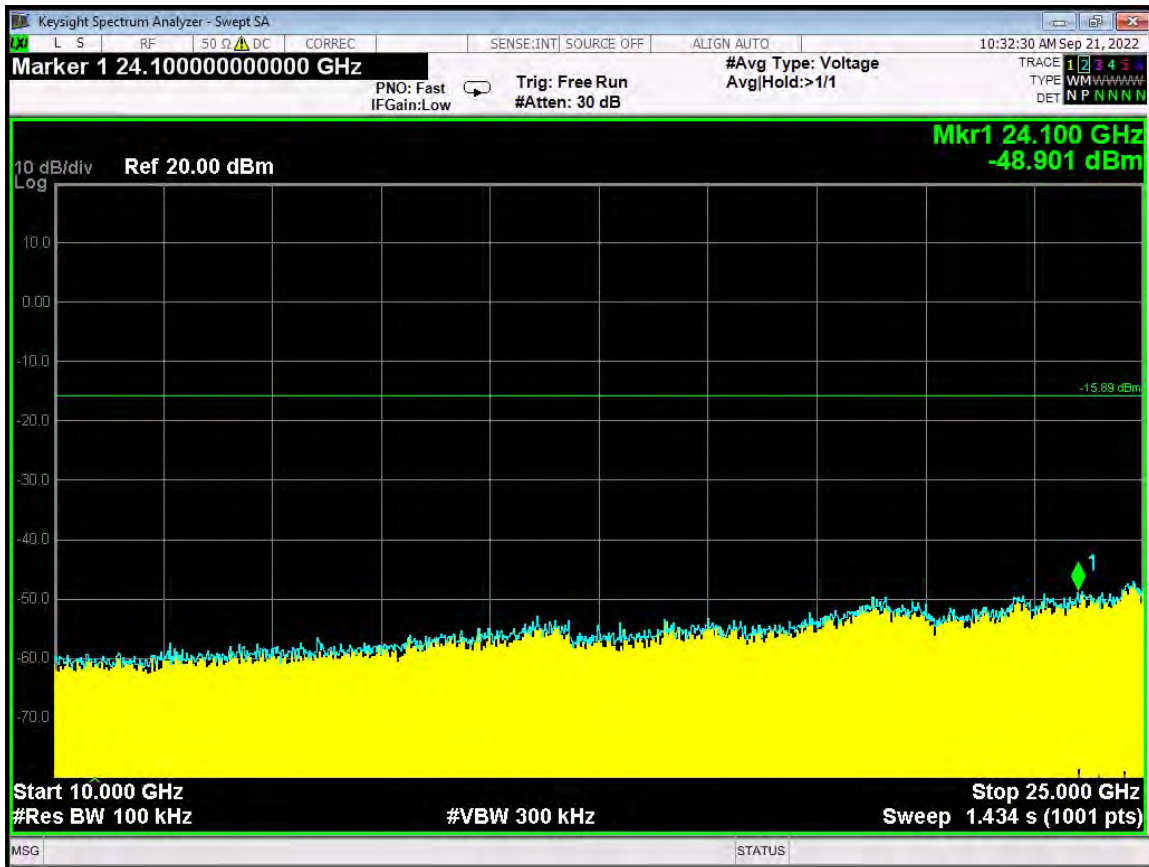

RF Antenna Conducted Test – ANT 0 – High Channel – 10 GHz to 25 GHz



***RF ANTENNA CONDUCTED
DATA SHEETS
ANTENNA "1"***



RF Antenna Conducted Test – ANT 1 – Low Channel – Reference Level

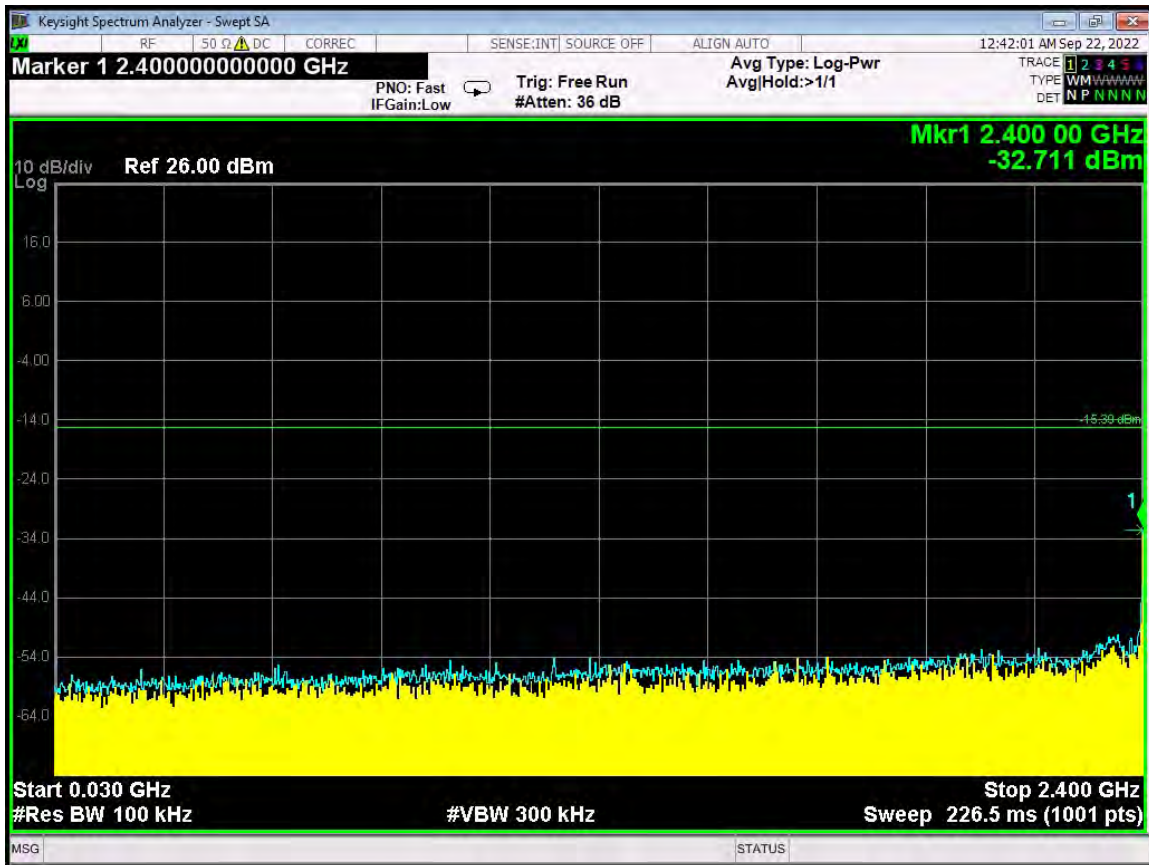

RF Antenna Conducted Test – ANT 1 – Low Channel – 30 MHz to 2.4 GHz

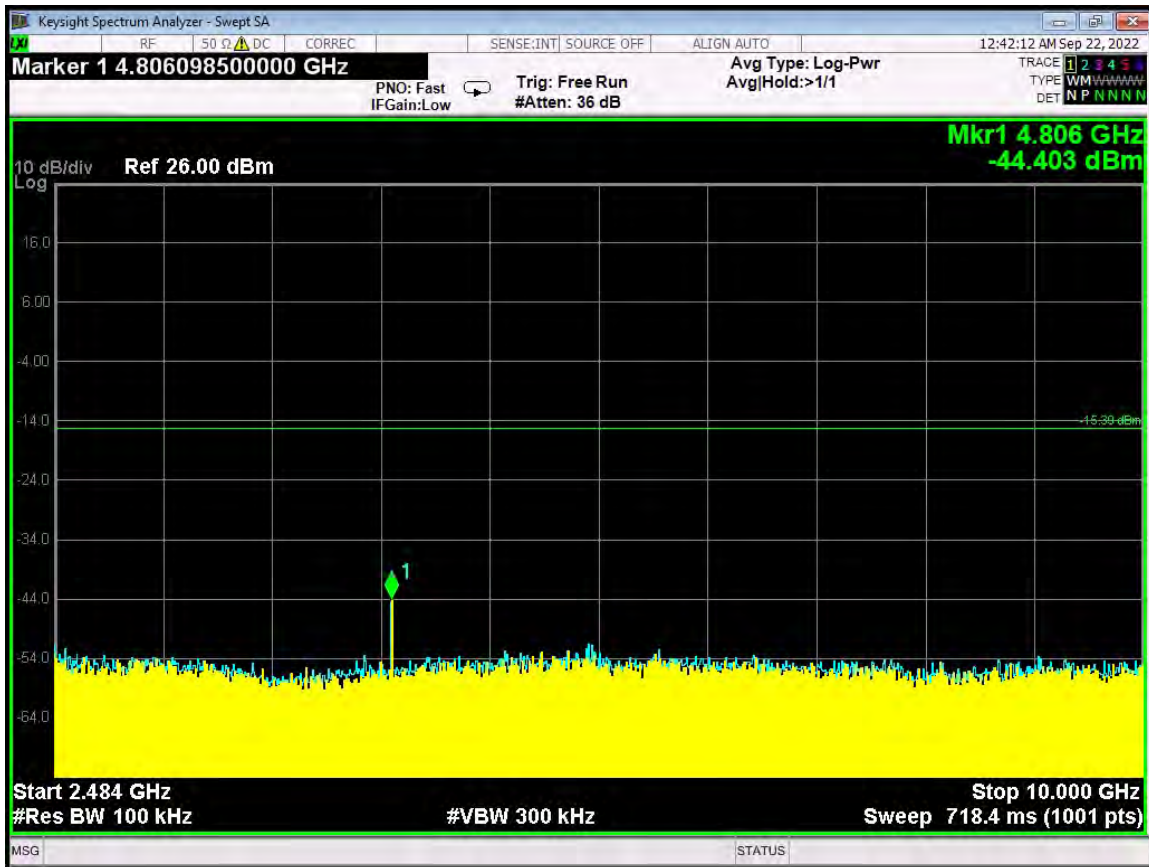

RF Antenna Conducted Test – ANT 1 – Low Channel – 2483.5 MHz to 10 GHz

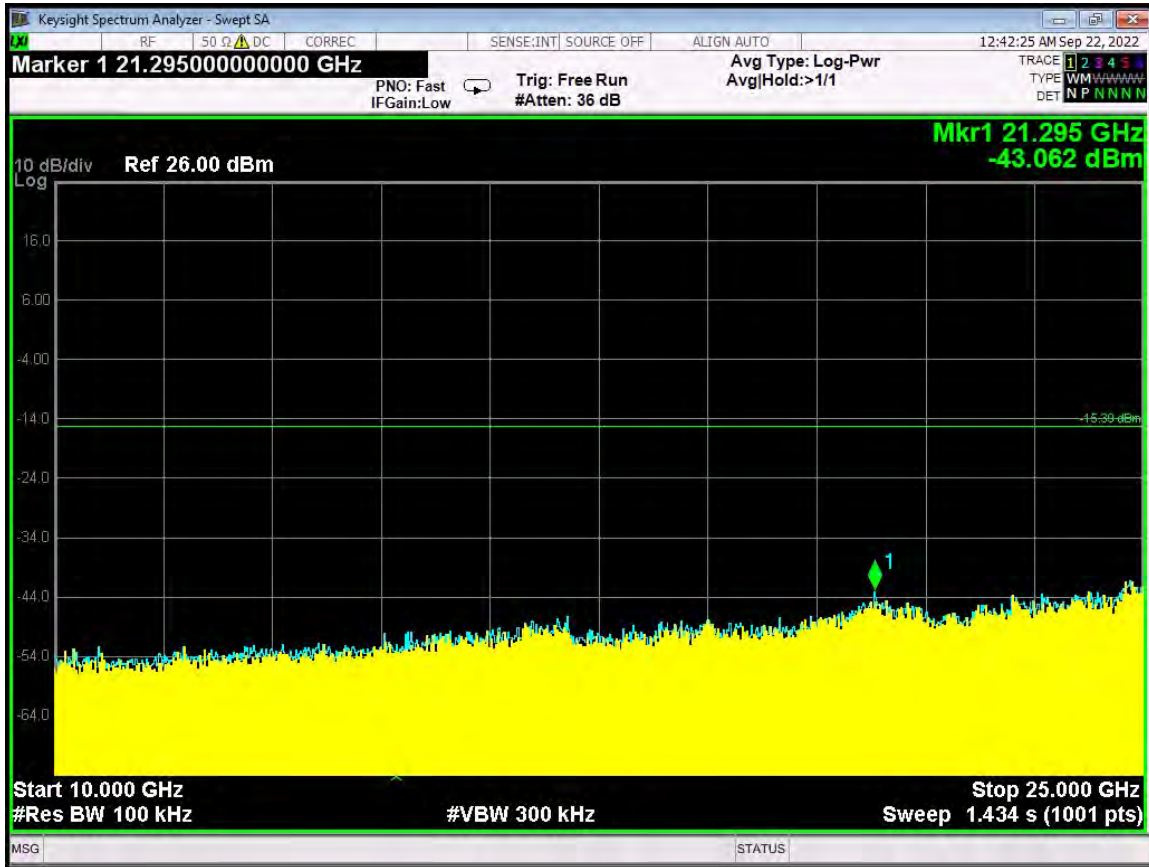

RF Antenna Conducted Test – ANT 1 – Low Channel – 10 GHz to 25 GHz

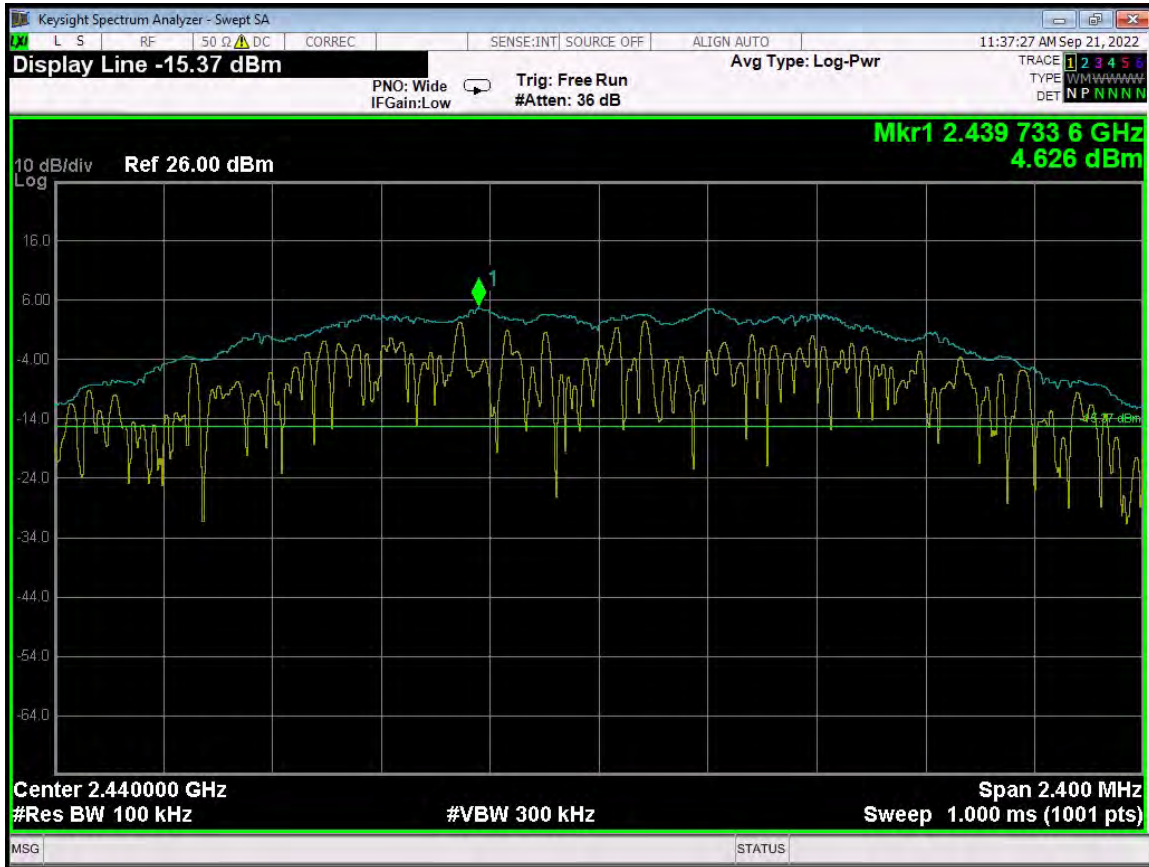

RF Antenna Conducted Test – ANT 1 – Mid Channel – Reference Level

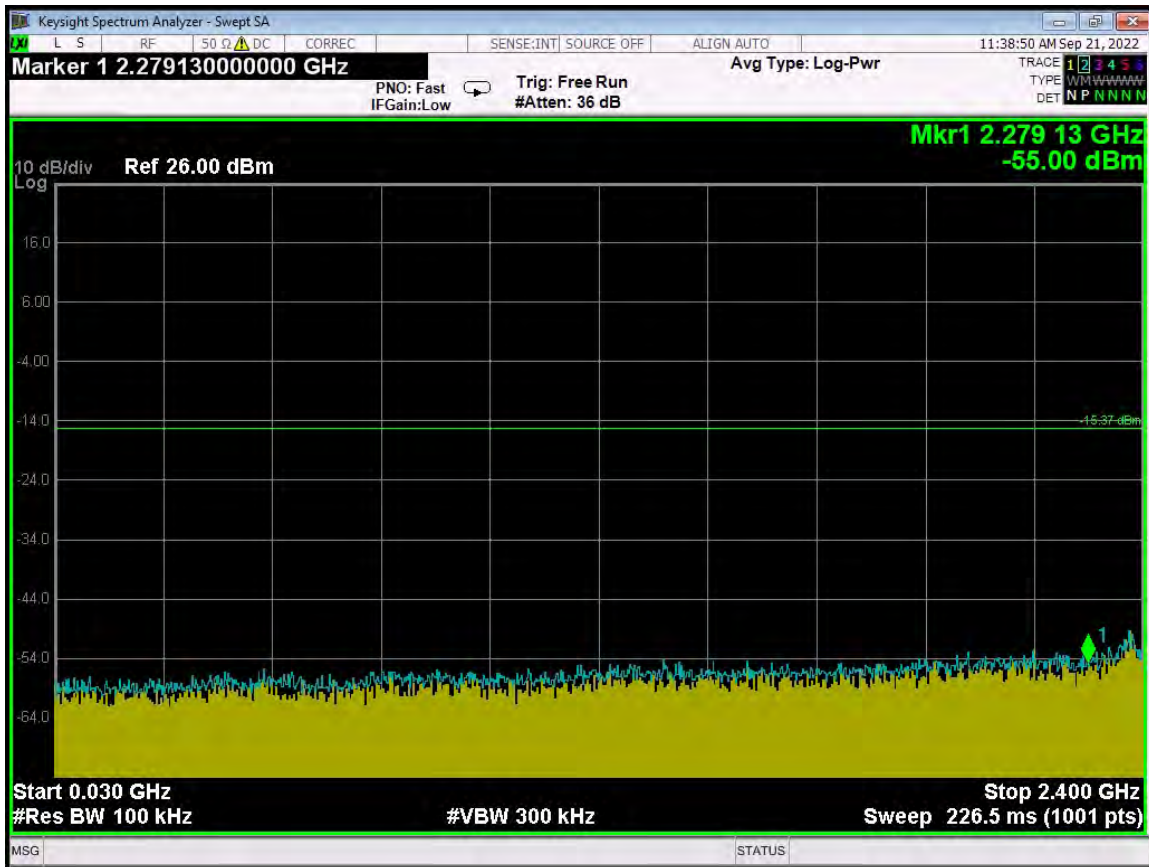

RF Antenna Conducted Test – ANT 1 – Mid Channel – 30 MHz to 2.4 GHz

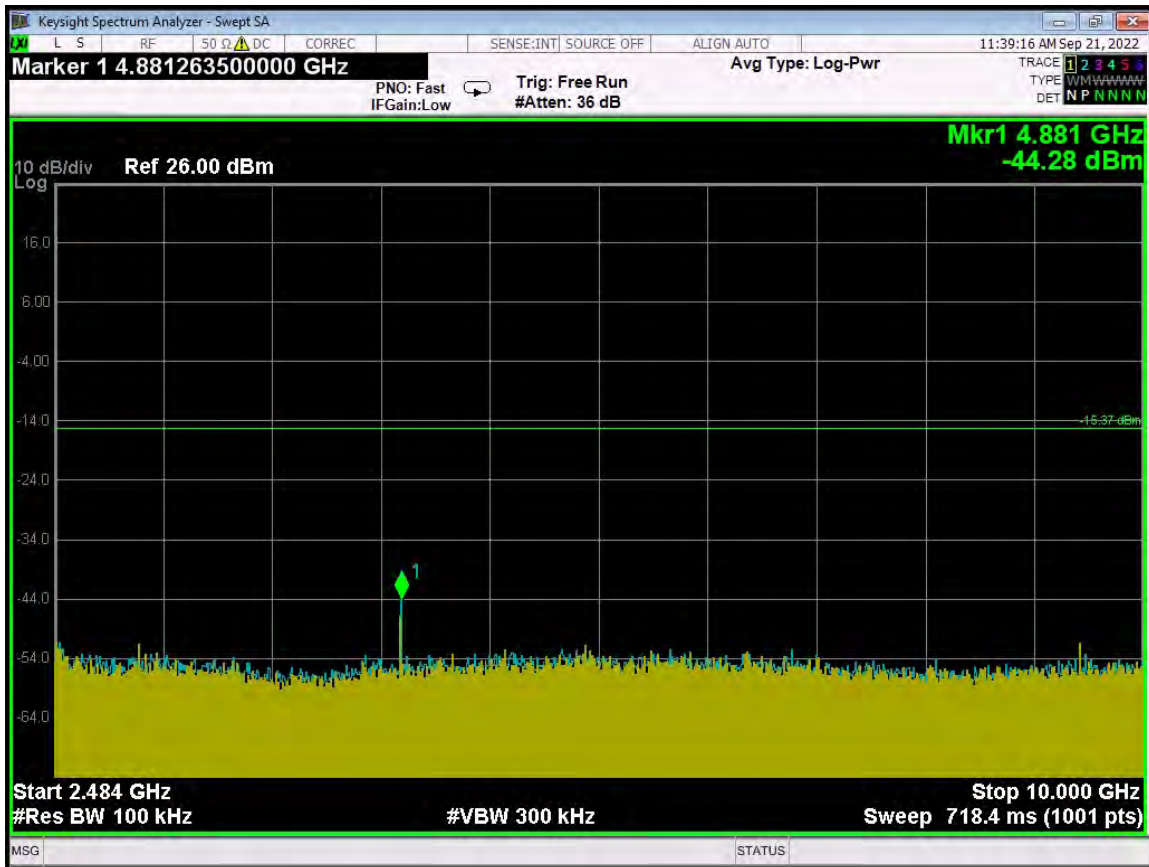

RF Antenna Conducted Test – ANT 1 – Mid Channel – 2483.5 MHz to 10 GHz

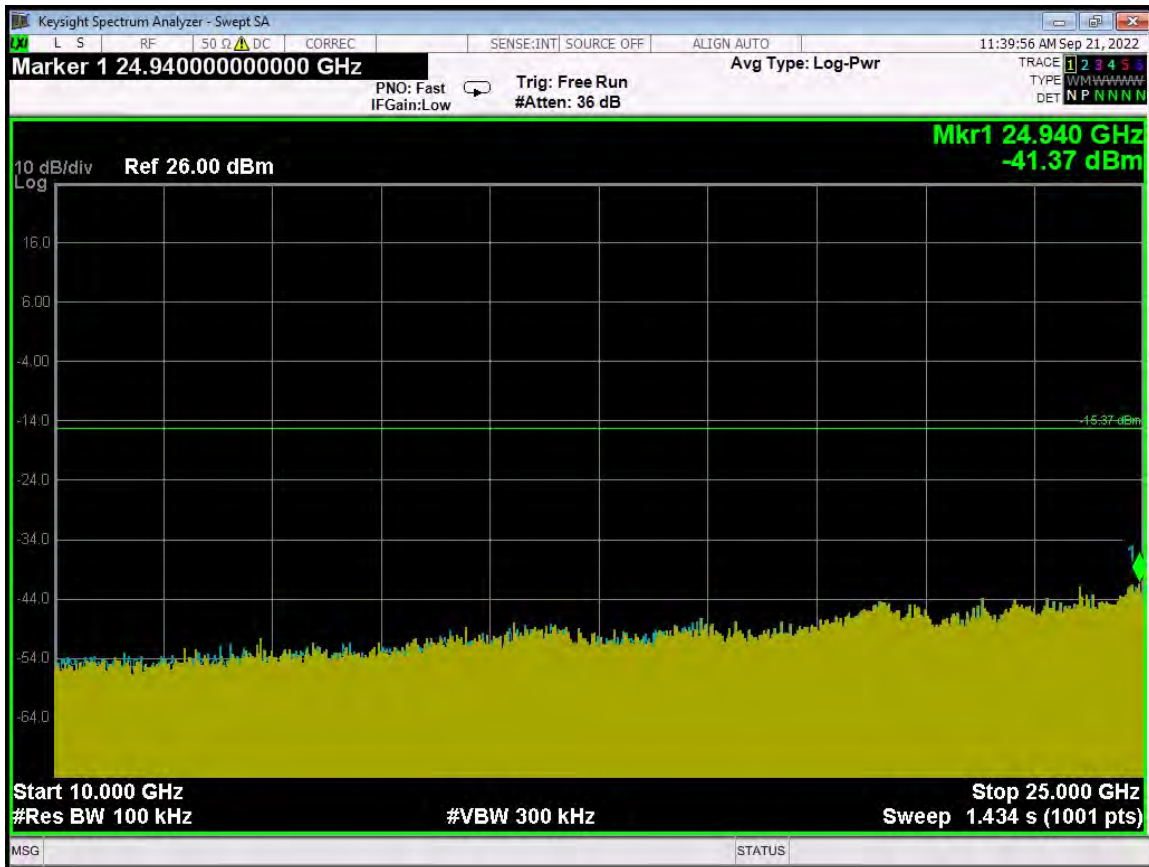

RF Antenna Conducted Test – ANT 1 – Mid Channel – 10 GHz to 25 GHz



RF Antenna Conducted Test – ANT 1 – High Channel – Reference Level

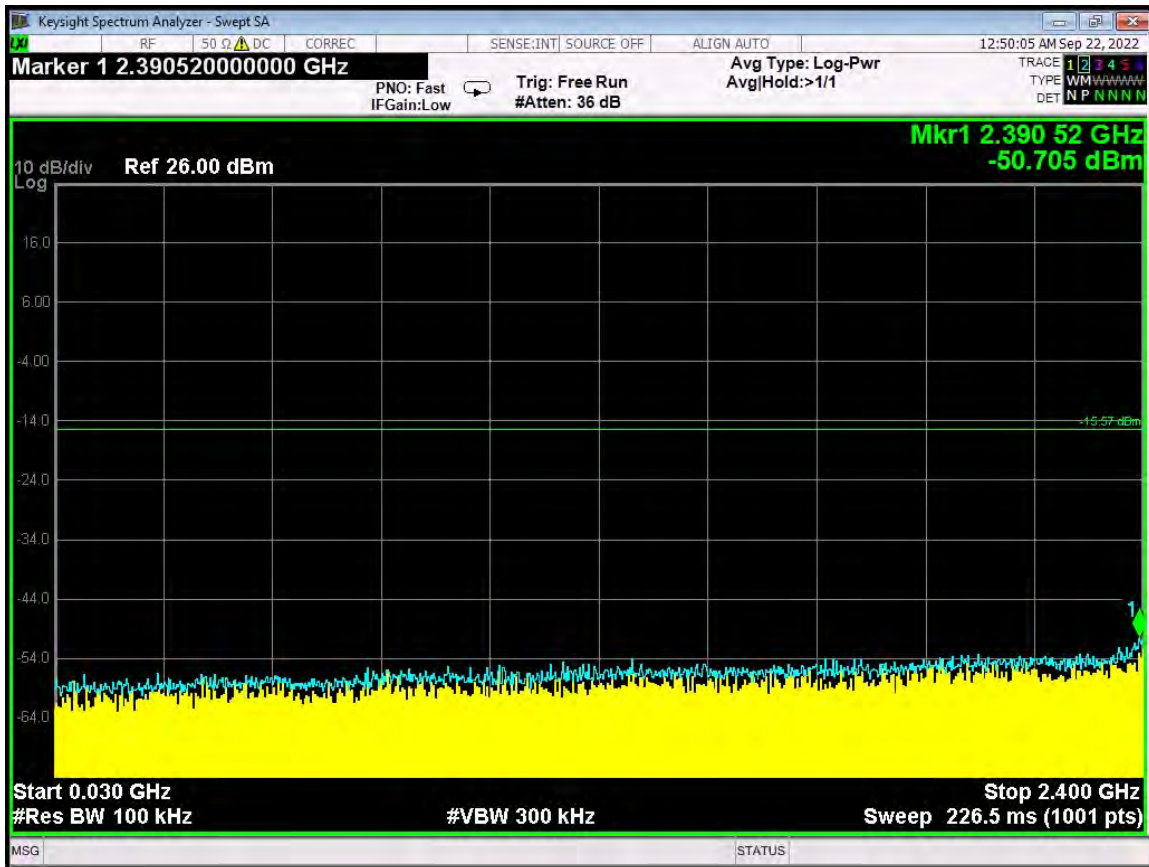

RF Antenna Conducted Test – ANT 1 – High Channel – 30 MHz to 2.4 GHz

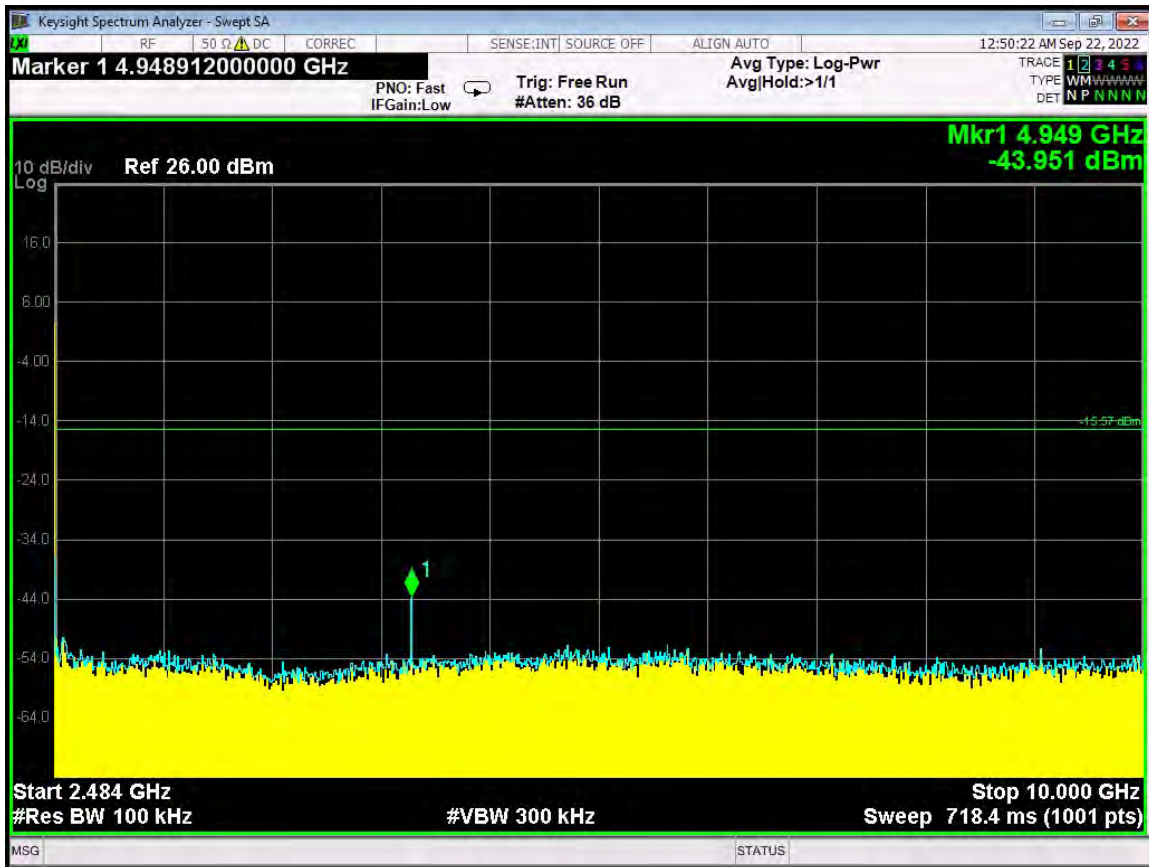

RF Antenna Conducted Test – ANT 1 – High Channel – 2483.5 MHz to 10 GHz

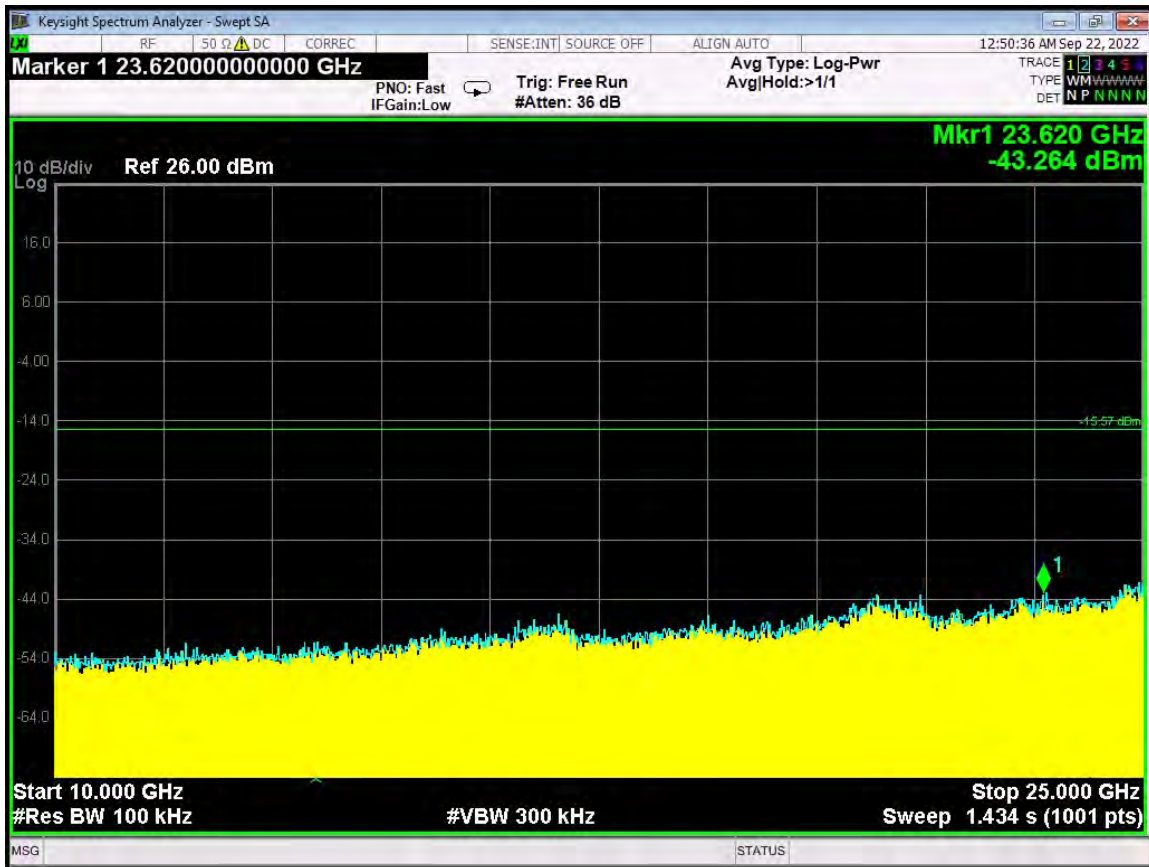

RF Antenna Conducted Test – ANT 1 – High Channel – 10 GHz to 25 GHz



VIVINT, INC.

VIVINT ZIGBEE BRIDGE

MODEL: BB03

EMISSIONS IN NON-RESTRICTED BANDS

ANTENNA "0" AND ANTENNA "1"

FREQUENCY (MHz)	LEVEL (dBm)	Limit* (dBm)	Margin (dB)
2400.00	-33.086	-15.81	-17.276
2400.00	-32.711	-15.39	-17.321
24760.00	-41.679	-15.77	-25.909

Note: The three highest non-restricted emissions are reported.

*The Limit is based on 20 dB below the highest reference level obtained on the previous pages.

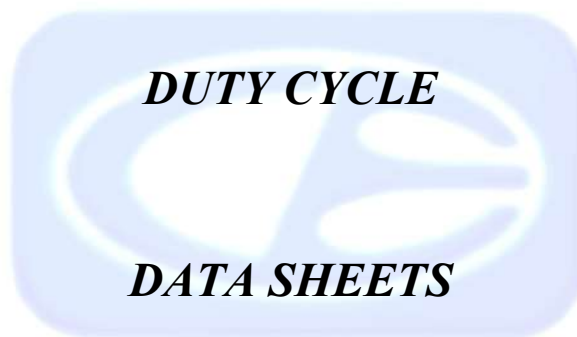

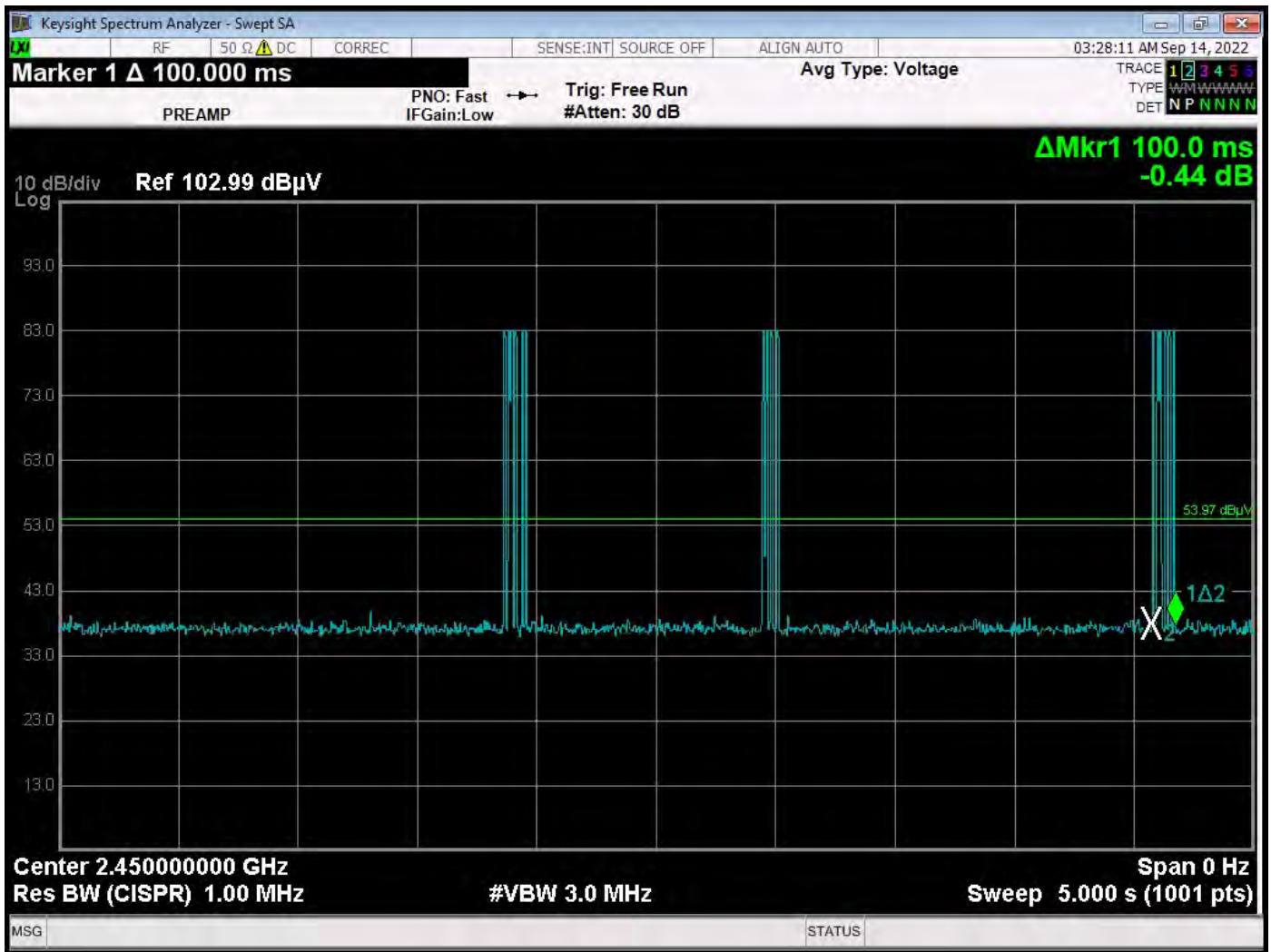

The pulse train only once per 100 ms – Light off Mode Worst Case

Brea Division
114 Olinda Drive
Brea, CA 92823
(714) 579-0500

Lake Forest Division
20621 Pascal Way
Lake Forest, CA 92630
(949) 587-0400

Newbury Park Division
1050 Lawrence Drive
Newbury Park, CA 91320
(805) 480-4044

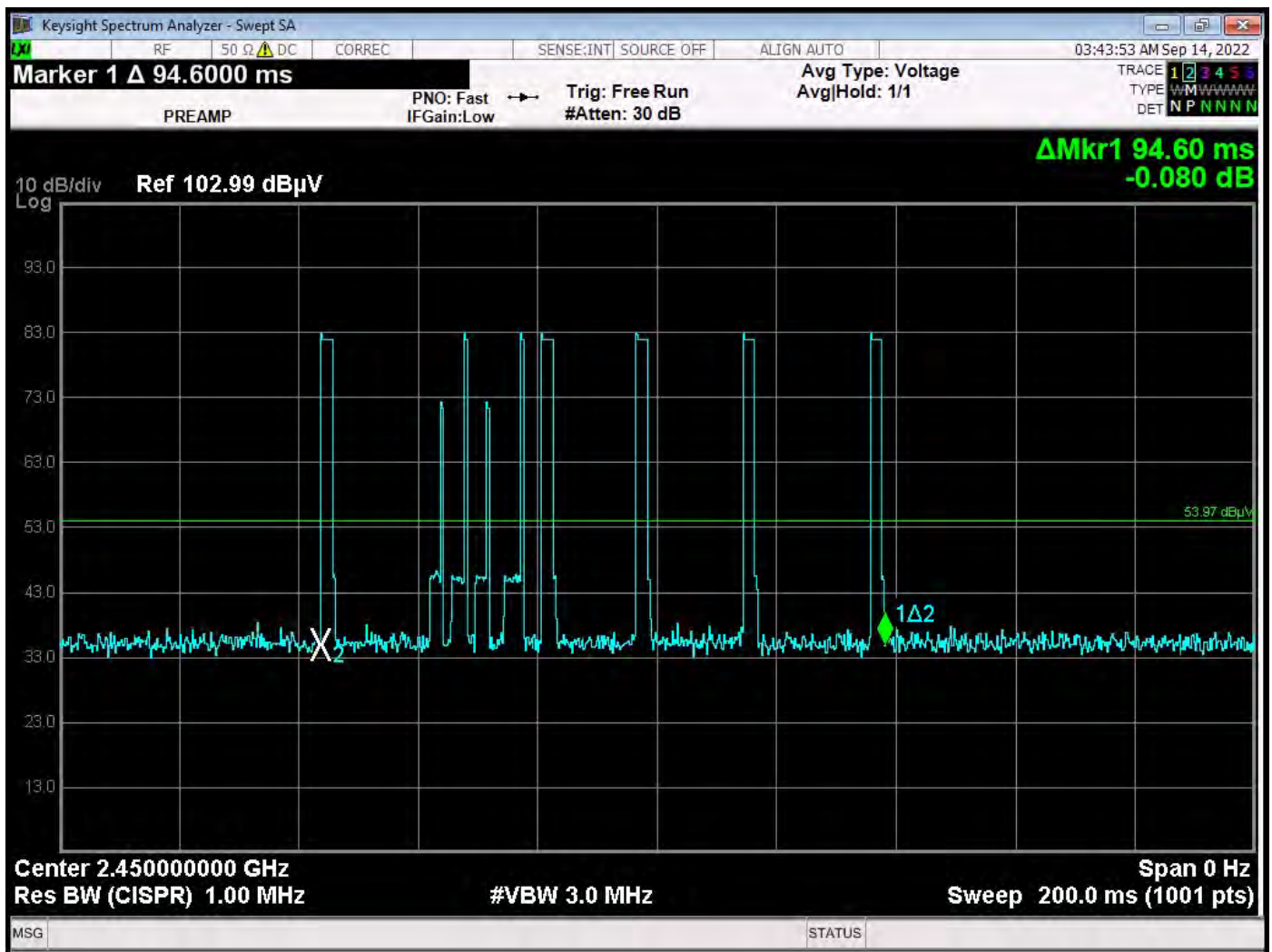

Number of Pulses = 9 – Light off Mode Worst Case

Brea Division
 114 Olinda Drive
 Brea, CA 92823
 (714) 579-0500

Lake Forest Division
 20621 Pascal Way
 Lake Forest, CA 92630
 (949) 587-0400

Newbury Park Division
 1050 Lawrence Drive
 Newbury Park, CA 91320
 (805) 480-4044

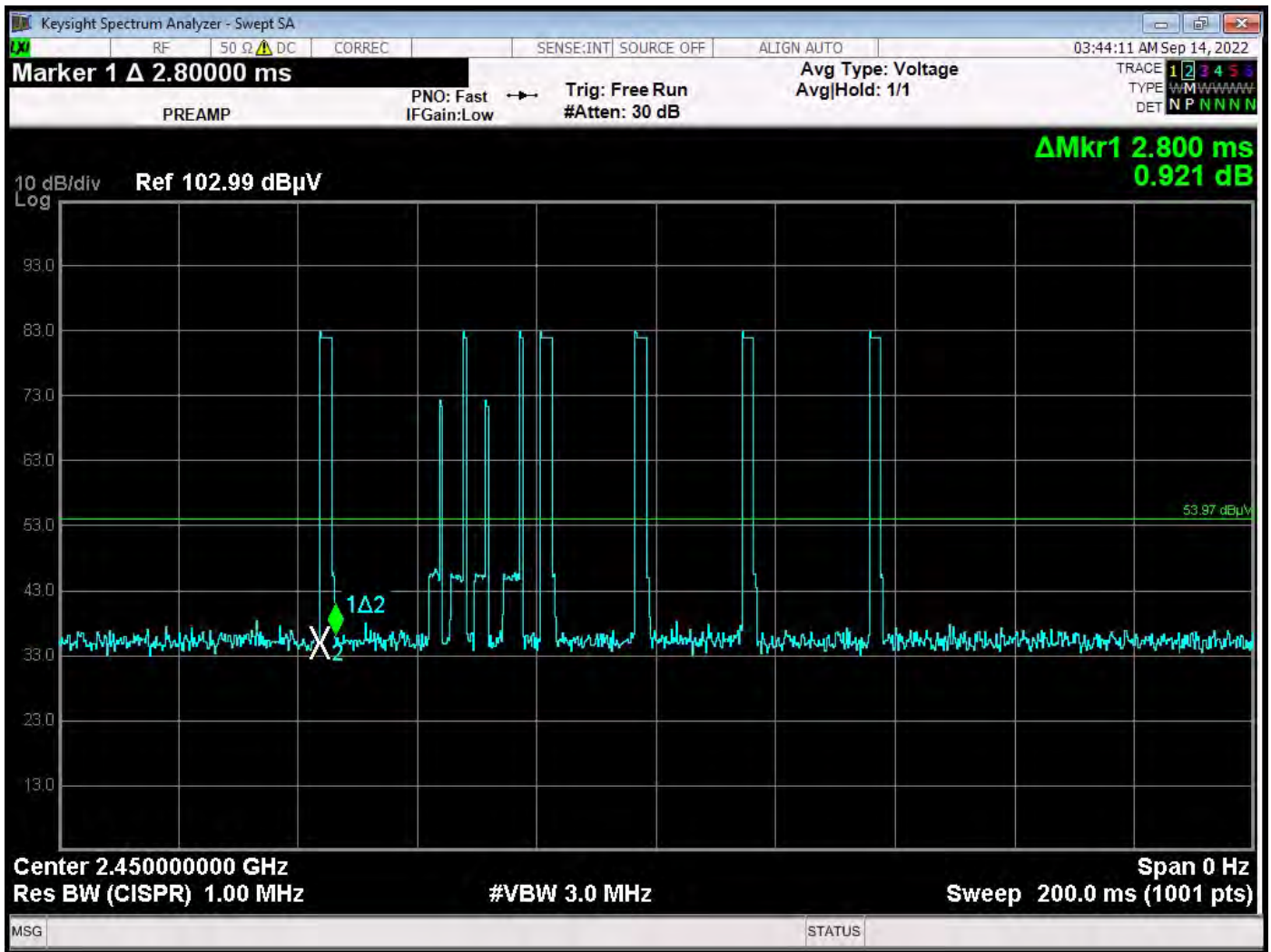

Time of First Pulse = 2.8 ms – Light off Mode Worst Case

Brea Division
 114 Olinda Drive
 Brea, CA 92823
 (714) 579-0500

Lake Forest Division
 20621 Pascal Way
 Lake Forest, CA 92630
 (949) 587-0400

Newbury Park Division
 1050 Lawrence Drive
 Newbury Park, CA 91320
 (805) 480-4044

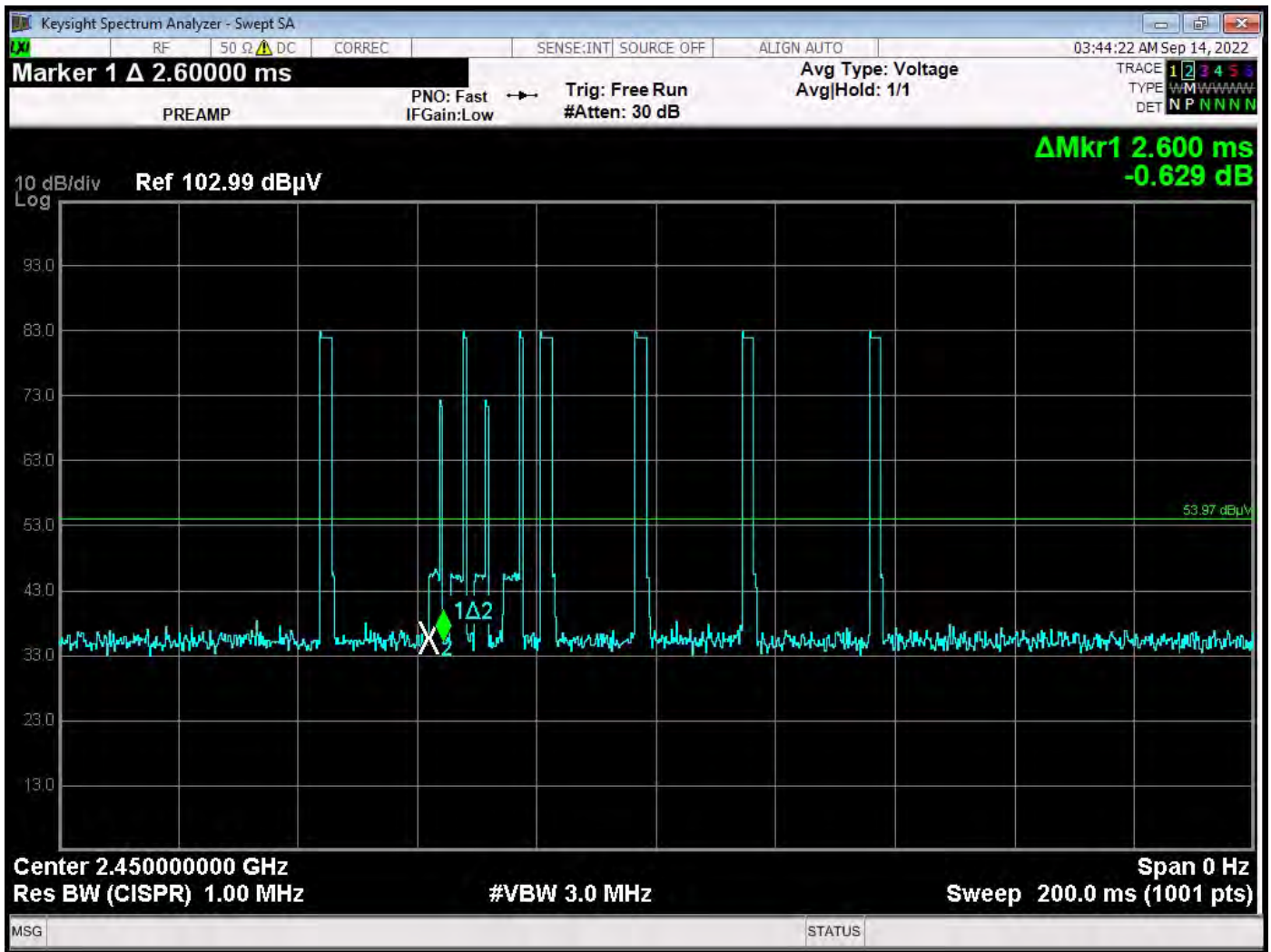

Time of Second Pulse = 2.6 ms – Light off Mode Worst Case

Brea Division
 114 Olinda Drive
 Brea, CA 92823
 (714) 579-0500

Lake Forest Division
 20621 Pascal Way
 Lake Forest, CA 92630
 (949) 587-0400

Newbury Park Division
 1050 Lawrence Drive
 Newbury Park, CA 91320
 (805) 480-4044

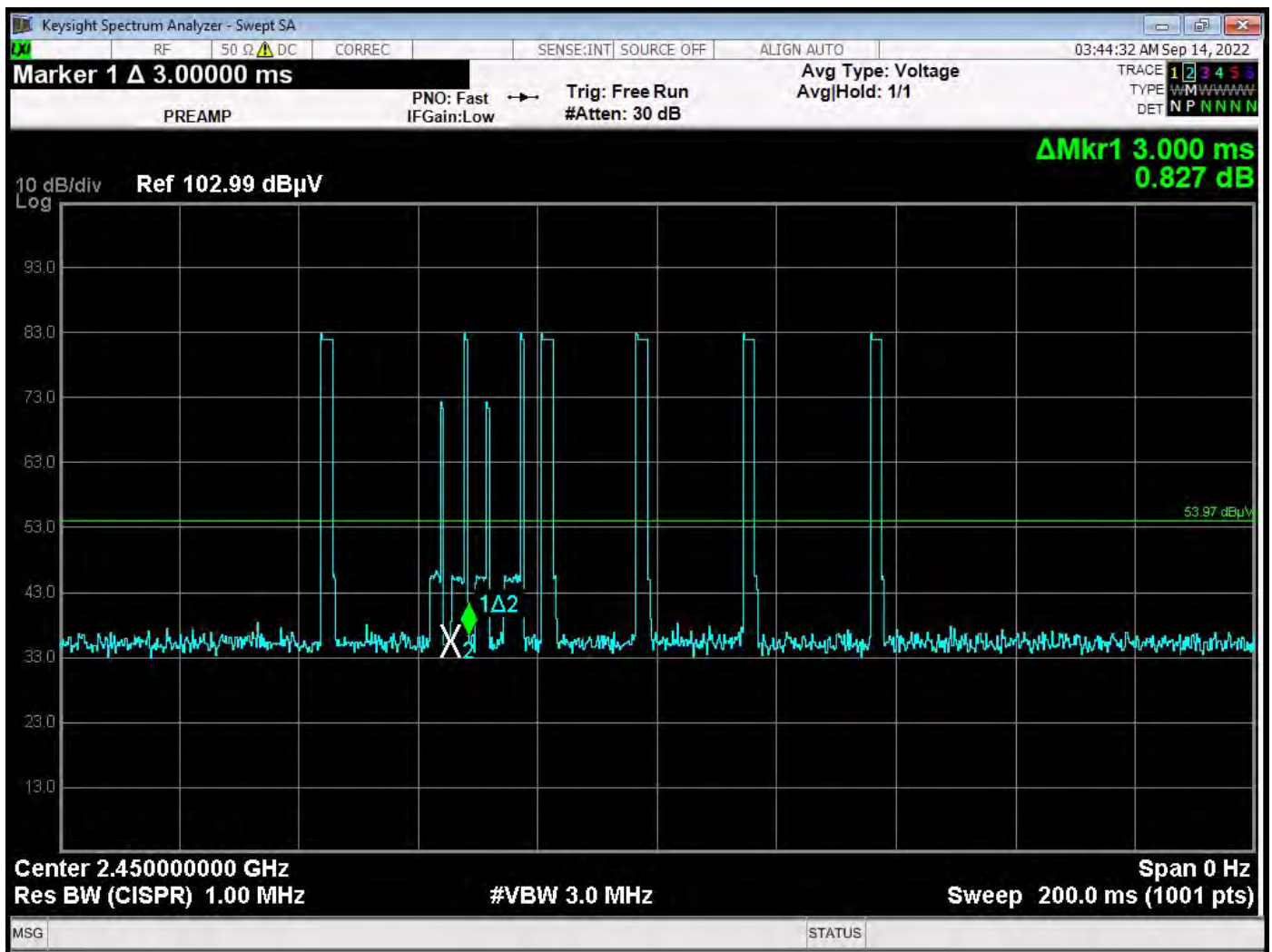

Time of Third Pulse = 3.0 ms – Light off Mode Worst Case

Brea Division
 114 Olinda Drive
 Brea, CA 92823
 (714) 579-0500

Lake Forest Division
 20621 Pascal Way
 Lake Forest, CA 92630
 (949) 587-0400

Newbury Park Division
 1050 Lawrence Drive
 Newbury Park, CA 91320
 (805) 480-4044

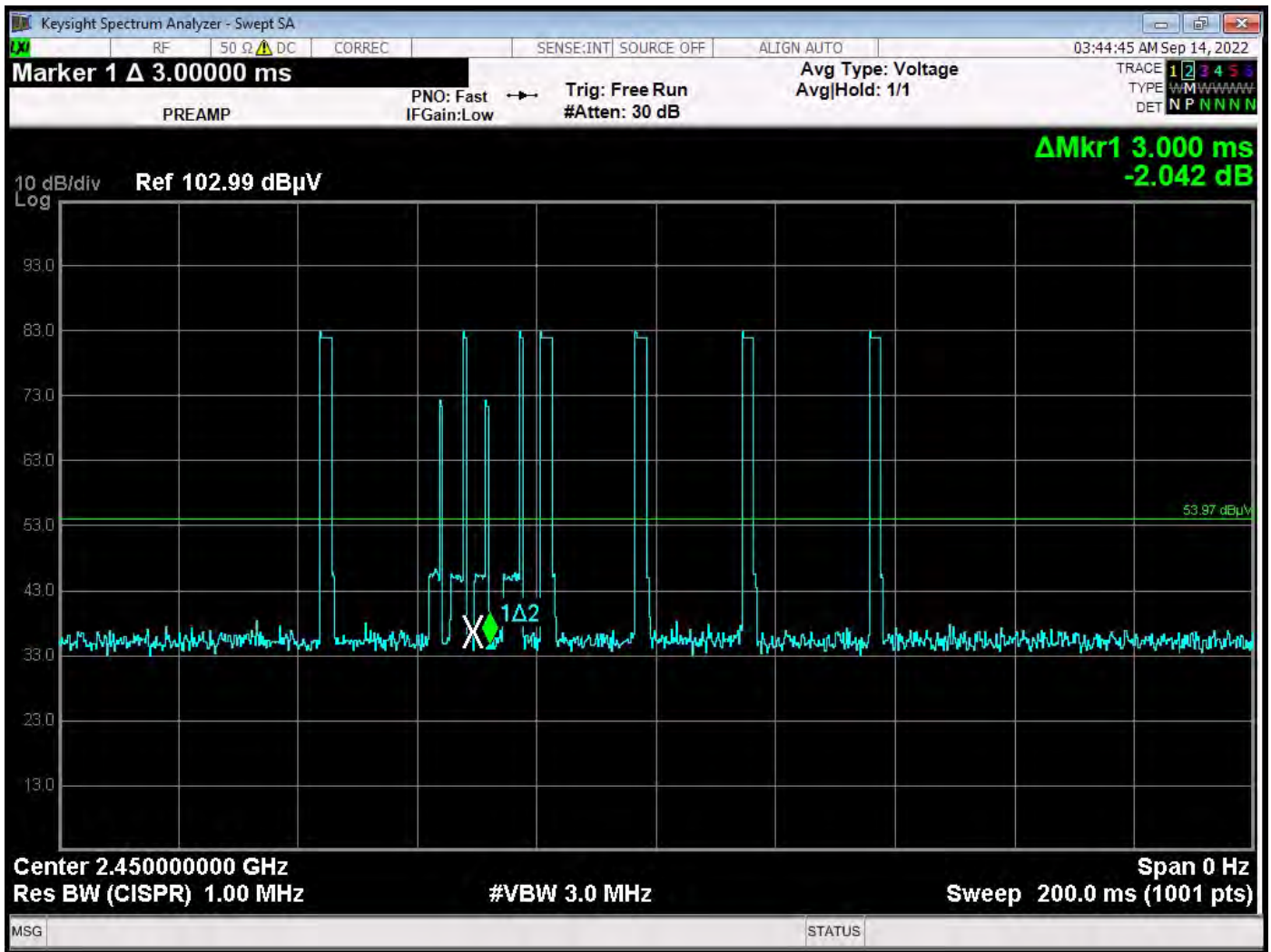

Time of Fourth Pulse = 3.0 ms – Light off Mode Worst Case

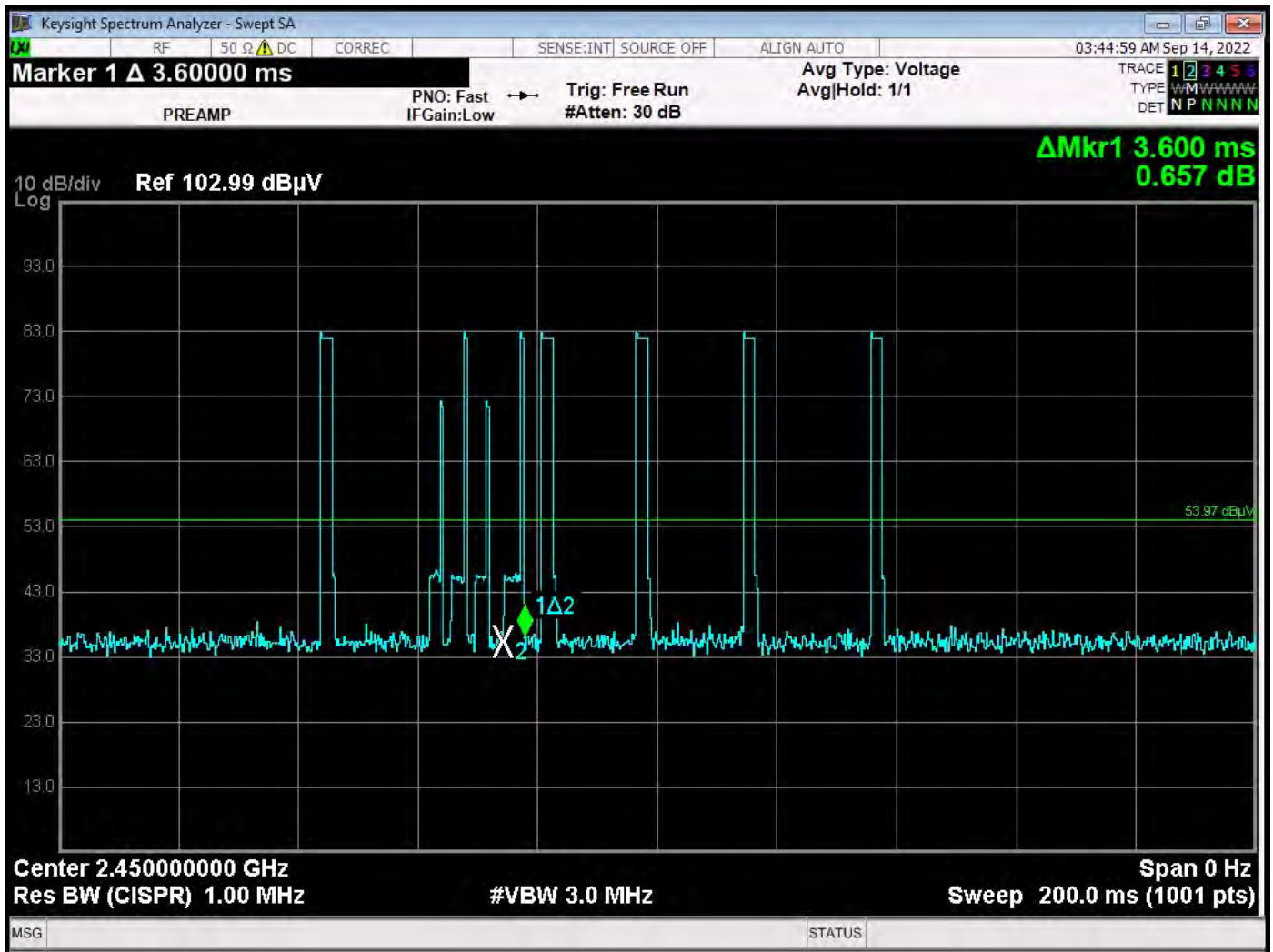

Time of Fifth Pulse = 3.6 ms – Light off Mode Worst Case

Brea Division
 114 Olinda Drive
 Brea, CA 92823
 (714) 579-0500

Lake Forest Division
 20621 Pascal Way
 Lake Forest, CA 92630
 (949) 587-0400

Newbury Park Division
 1050 Lawrence Drive
 Newbury Park, CA 91320
 (805) 480-4044

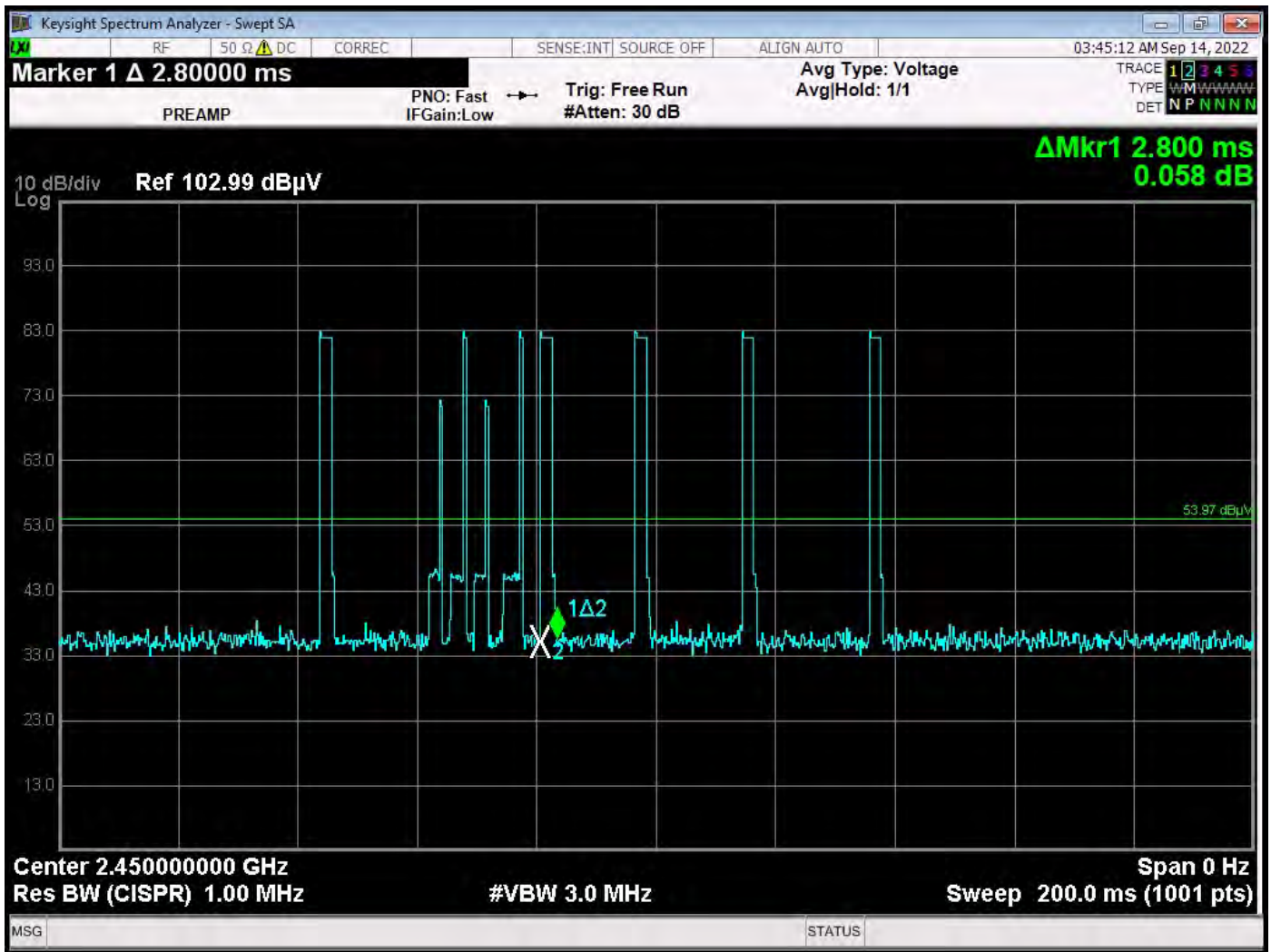

Time of Sixth Pulse = 2.8 ms – Light off Mode Worst Case

Brea Division
 114 Olinda Drive
 Brea, CA 92823
 (714) 579-0500

Lake Forest Division
 20621 Pascal Way
 Lake Forest, CA 92630
 (949) 587-0400

Newbury Park Division
 1050 Lawrence Drive
 Newbury Park, CA 91320
 (805) 480-4044

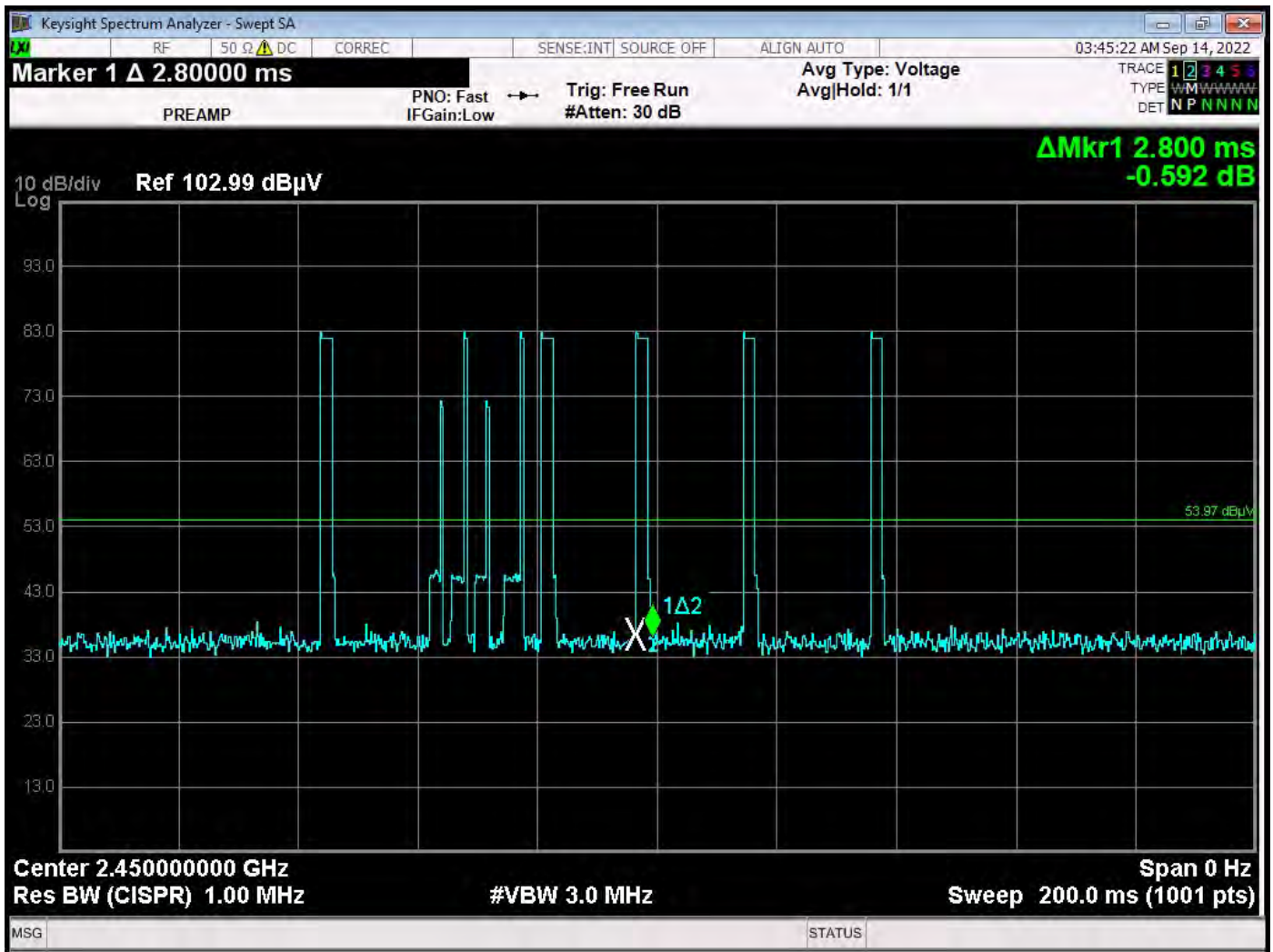

Time of Seventh Pulse = 2.8 ms – Light off Mode Worst Case

Brea Division
114 Olinda Drive
Brea, CA 92823
(714) 579-0500

Lake Forest Division
20621 Pascal Way
Lake Forest, CA 92630
(949) 587-0400

Newbury Park Division
1050 Lawrence Drive
Newbury Park, CA 91320
(805) 480-4044

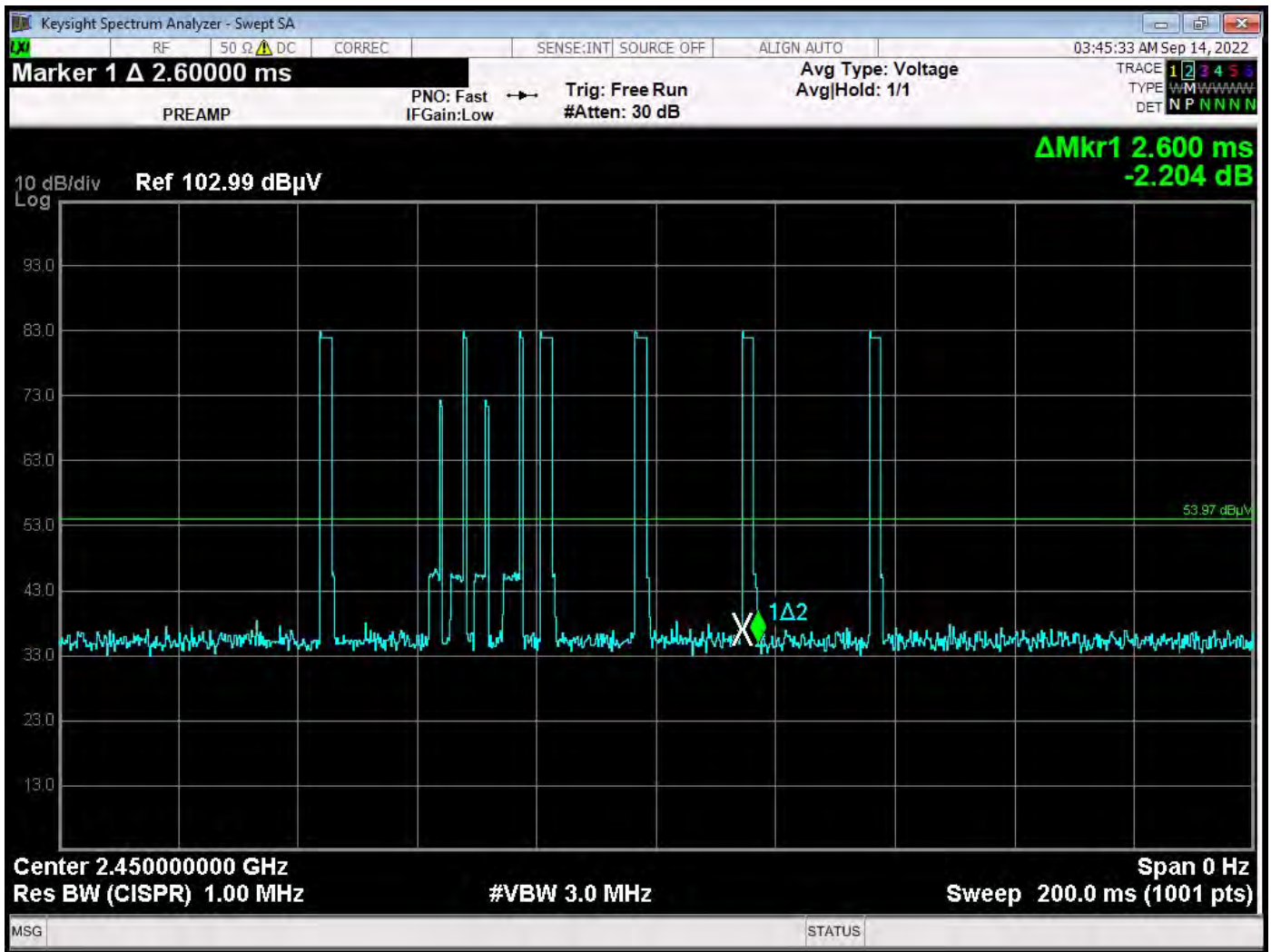

Time on Eighth Pulse = 2.6 ms – Light off Mode Worst Case

Brea Division
 114 Olinda Drive
 Brea, CA 92823
 (714) 579-0500

Lake Forest Division
 20621 Pascal Way
 Lake Forest, CA 92630
 (949) 587-0400

Newbury Park Division
 1050 Lawrence Drive
 Newbury Park, CA 91320
 (805) 480-4044

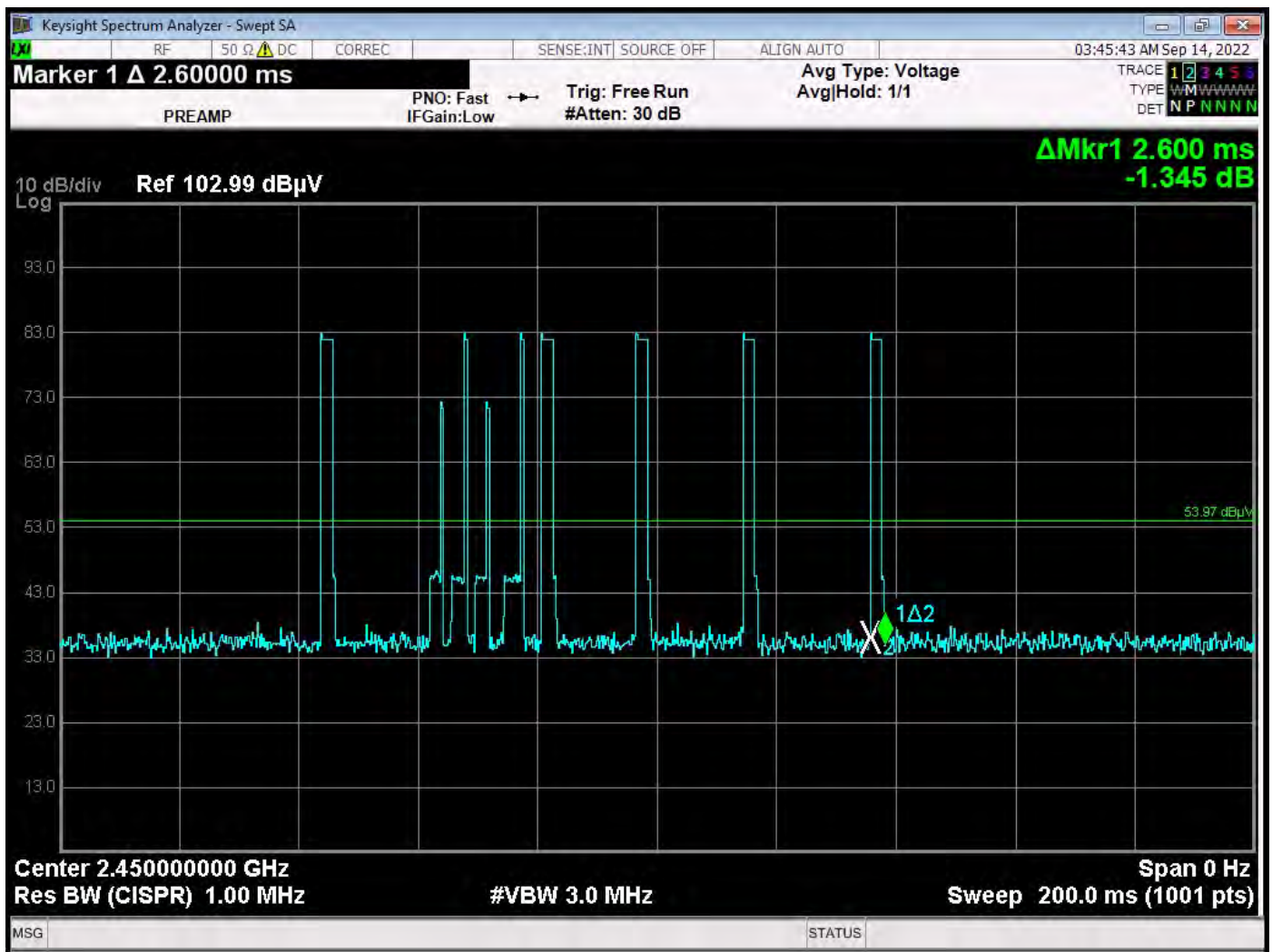

Time of Ninth Pulse = 2.6 ms – Light Off Mode Worst Case

Total On Time = 25.8 ms

Duty Cycle = 25.8 ms / 100 ms = 0.258 = 25.8 %

The peak to average ratio is -11.76 dB