



TEST REPORT

For SAR



Report No. : **CHTEW23040048** Report verification:

Project No...... : **SHT2301025101EW**

FCC ID..... : **2AAAM-DXR8PPZ-BPU**

Applicant's name..... : **STANDARD MERIT INDUSTRIAL LIMITED**

Address..... : **604 Kalok Building, 720 Nathan Road, Kowloon, Hong Kong**

Test item description : **Wireless Digital Video Monitoring System**

Trade Mark : -

Model/Type reference..... : **DXR-8 PRO**

Listed Model(s) : **DXR8PPZ-B, DXR8PPZ-BPU**

Standard : **FCC 47 CFR Part2.1093**
IEEE Std C95.1: 1999 Edition
IEEE Std 1528: 2013

Date of receipt of test sample..... : **Apr. 11, 2023**

Date of testing..... : **Apr. 12, 2023- Apr. 13, 2023**

Date of issue..... : **Apr. 13, 2023**

Result..... : **PASS**

Compiled by
 (position+printedname+signature)....: File administrators: Silvia Li

Silvia Li

Supervised by
 (position+printedname+signature)....: Test Engineer: Weiyang Xiang

Weiyang Xiang

Approved by
 (position+printedname+signature)....: Manager: Hans Hu

Hans Hu

Testing Laboratory Name : **Shenzhen Huatongwei International Inspection Co., Ltd**

Address..... : **1/F, Bldg 3, Hongfa Hi-tech Industrial Park, Genyu Road, Tianliao, Gongming, Shenzhen, China**

Shenzhen Huatongwei International Inspection Co., Ltd. All rights reserved.

This publication may be reproduced in whole or in part for non-commercial purposes as long as the Shenzhen Huatongwei International Inspection Co., Ltd is acknowledged as copyright owner and source of the material. Shenzhen Huatongwei International Inspection Co., Ltd takes no responsibility for and will not assume liability for damages resulting from the reader's interpretation of the reproduced material due to its placement and context.

The test report merely correspond to the test sample.

Contents

<u>1.</u>	<u>Statement of Compliance</u>	<u>3</u>
<u>2.</u>	<u>Test Standards and Report version</u>	<u>4</u>
2.1.	Test Standards	4
2.2.	Report version	4
<u>3.</u>	<u>Summary</u>	<u>5</u>
3.1.	Client Information	5
3.2.	Product Description	5
3.3.	Testing Laboratory Information	6
3.4.	Environmental conditions	6
<u>4.</u>	<u>Equipments Used during the Test</u>	<u>7</u>
<u>5.</u>	<u>Measurement Uncertainty</u>	<u>8</u>
<u>6.</u>	<u>SAR Measurement System Configuration</u>	<u>9</u>
6.1.	SAR Measurement Set-up	9
6.2.	DASY5 E-field Probe System	10
6.3.	Phantoms	11
6.4.	Device Holder	11
<u>7.</u>	<u>SAR Test Procedure</u>	<u>12</u>
7.1.	Scanning Procedure	12
7.2.	Data Storage and Evaluation	14
<u>8.</u>	<u>Position of the wireless device in relation to the phantom</u>	<u>16</u>
8.1.	Body Position	16
<u>9.</u>	<u>Dielectric Property Measurements & System Check</u>	<u>17</u>
9.1.	Tissue Dielectric Parameters	17
9.2.	System Check	18
<u>10.</u>	<u>SAR Exposure Limits</u>	<u>21</u>
<u>11.</u>	<u>Conducted Power Measurement Results and Tune-up</u>	<u>21</u>
<u>12.</u>	<u>Antenna Location</u>	<u>22</u>
<u>13.</u>	<u>Measured and Reported SAR Results</u>	<u>23</u>
<u>14.</u>	<u>Test Setup Photos</u>	<u>23</u>
<u>15.</u>	<u>External and Internal Photos of the EUT</u>	<u>23</u>

1. Statement of Compliance

Maximum Reported SAR (W/kg @1g)		
Type	Test setting	TFT
Body	Dist.= 0mm	0.619

Note:

1. This device is in compliance with Specific Absorption Rate (SAR) for general population/uncontrolled exposure limits (1.6 W/kg@1g) specified in FCC 47 CFR part 2 (2.1093) and IEEE Std C95.1,
2. This device had been tested in accordance with the measurement methods and procedures specified in IEEE 1528 and FCC KDB publications.

2. Test Standards and Report version

2.1. Test Standards

The tests were performed according to following standards:

[FCC 47 Part 2.1093](#): Radiofrequency radiation exposure evaluation: portable devices.

[IEEE Std C95.1, 1999 Edition](#): IEEE Standard for Safety Levels with Respect to Human Exposure to Radio Frequency Electromagnetic Fields, 3 kHz to 300 GHz

[IEEE Std 1528™-2013](#): IEEE Recommended Practice for Determining the Peak Spatial-Average Specific Absorption Rate (SAR) in the Human Head from Wireless Communications Devices: Measurement Techniques.

FCC published RF exposure KDB procedures:

[865664 D01 SAR Measurement 100 MHz to 6 GHz v01r04](#): SAR Measurement Requirements for 100 MHz to 6 GHz

[865664 D02 RF Exposure Reporting v01r02](#): RF Exposure Compliance Reporting and Documentation Considerations

[447498 D04 Interim General RF Exposure Guidance v01](#): Mobile and Portable Device RF Exposure Procedures and Equipment Authorization Policies

[TCB workshop](#) April, 2019; Page 19, Tissue Simulating Liquids (TSL)

2.2. Report version

Revision No.	Date of issue	Description
N/A	2023-04-13	Original

3. Summary

3.1. Client Information

Applicant:	STANDARD MERIT INDUSTRIAL LIMITED
Address:	604 Kalok Building, 720 Nathan Road, Kowloon, Hong Kong
Manufacturer:	STANDARD MERIT INDUSTRIAL LIMITED
Address:	604 Kalok Building, 720 Nathan Road, Kowloon, Hong Kong

3.2. Product Description

Main unit	
Name of EUT:	Wireless Digital Video Monitoring System
Trade Mark:	-
Model No.:	DXR-8 PRO
Listed Model(s):	DXR8PPZ-B, DXR8PPZ-BPU
Power supply:	3.85VDC, 2800mAh (Supplied by Rechargeable Li-ion Battery) or 5VDC, 1500mA (Supplied by external adapter for Charging rechargeable battery)
Device Dimension:	Length x Width x Thickness (mm): 165 x 80 x 20
Device Category:	Portable
Product stage:	Production unit
RF Exposure Environment:	General Population/Uncontrolled
HTW test sample No.:	YPHT23010251001
Adapter Information:	Adapter 1 Model: BLJ05K050150P-U Input: 100-240VAC 50/60Hz, 0.2A, Output: 5VDC, 1500mA Manufacturer: Zhongshan Baolijin Electronic Co., Ltd. Adapter 2 Model: HP07Z-0501500-CU Input: 100-240VAC 50/60Hz, 0.3A, Output: 5VDC, 1500mA Manufacturer: DONGGUAN HP-POWER TECHNOLOGY., LIMITED

Remark: Only the model DXR-8 PRO was tested, DXR-8 PRO is the system model of the product that of which consist of one camera unit and one monitor unit with the model DXRBPPZ-B. The model DXR-8 PRO is represented the coverage of one Camera unit and one Monitor with the Model DXR8PPZ-B. For DXR8PPZ-B is the model represent the individual Camera/Monitor unit only. For DXR8PPZ-BPU is the model represent the individual Monitor unit only.

3.3. Testing Laboratory Information

Laboratory Name	Shenzhen Huatongwei International Inspection Co., Ltd.	
Laboratory Location	1/F, Bldg 3, Hongfa Hi-tech Industrial Park, Genyu Road, Tianliao, Gongming, Shenzhen, China	
Connect information:	Tel: 86-755-26715499 E-mail: cs@szhtw.com.cn http://www.szhtw.com.cn	
Qualifications	Type	Accreditation Number
	FCC	762235

3.4. Environmental conditions

During the measurement the environmental conditions were within the listed ranges:

Ambient temperature	18 °C to 25 °C
Ambient humidity	30%RH to 70%RH
Air Pressure	950-1050mbar

4. Equipments Used during the Test

Used	Test Equipment	Manufacturer	Equipment No.	Model No.	Serial No.	Cal. date (YY-MM-DD)	Due date (YY-MM-DD)
●	Data Acquisition Electronics DAEx	SPEAG	HTWE0313-05	DAE4	1549	2023/03/27	2024/03/26
●	E-field Probe	SPEAG	HTWE0313-06	EX3DV4	7494	2022/05/16	2023/05/15
●	Universal Radio Communication Tester	R&S	HTWE0323	CMW500	137681	2022/05/12	2023/05/11
Tissue-equivalent liquids Validation							
●	Dielectric Assessment Kit	SPEAG	HTWE0315-02	DAK-3.5	1267	N/A	N/A
○	Dielectric Assessment Kit	SPEAG	HTWE0315-01	DAK-12	1130	N/A	N/A
●	Network analyzer	Keysight	HTWE0331	E5071C	MY46733048	2022/08/29	2023/08/28
System Validation							
○	System Validation Antenna	SPEAG	HTWE0314-01	CLA-150	4024	2021/01/25	2024/01/24
○	System Validation Dipole	SPEAG	HTWE0314-02	D450V3	1102	2021/01/20	2024/01/19
○	System Validation Dipole	SPEAG	HTWE0314-03	D750V3	1180	2021/01/22	2024/01/21
○	System Validation Dipole	SPEAG	HTWE0314-04	D835V2	4d238	2021/01/22	2024/01/21
○	System Validation Dipole	SPEAG	HTWE0314-05	D1750V2	1164	2021/01/22	2024/01/21
○	System Validation Dipole	SPEAG	HTWE0314-06	D1900V2	5d226	2021/01/22	2024/01/21
●	System Validation Dipole	SPEAG	HTWE0314-07	D2450V2	1009	2021/01/25	2024/01/24
○	System Validation Dipole	SPEAG	HTWE0314-08	D2600V2	1150	2021/01/25	2024/01/24
○	System Validation Dipole	SPEAG	HTWE0314-09	D5GHzV2	1273	2021/01/26	2024/01/25
●	Signal Generator	R&S	HTWE0276	SMB100A	114360	2022/05/25	2023/05/24
●	Power Viewer for Windows	R&S		N/A	N/A	N/A	N/A
●	Power sensor	R&S	HTWE0278	NRP18A	101010	2022/05/25	2023/05/24
●	Power sensor	R&S	HTWE0389	NRP18A	101386	2022/05/12	2023/05/11
●	Power Amplifier	BONN	HTWE0336	BLWA 0160-2M	1811887	2022/11/10	2023/11/09
●	Dual Directional Coupler	Mini-Circuits	HTWE0335	ZHDC-10-62-S+	F975001814	2022/11/10	2023/11/09
●	Attenuator	Mini-Circuits	HTWE0333	VAT-3W2+	1819	2022/11/10	2023/11/09
●	Attenuator	Mini-Circuits	HTWE0334	VAT-10W2+	1741	2022/11/10	2023/11/09

Note:

1. The Probe, Dipole and DAE calibration reference to the Appendix E and F.
2. Referring to KDB865664 D01, the dipole calibration interval can be extended to 3 years with justification. The dipole are also not physically damaged or repaired during the interval.

5. Measurement Uncertainty

Per KDB 865664 D01 SAR Measurement 100 MHz to 6 GHz, when the highest measured 1-g SAR within a frequency band is < 1.5 W/kg and the measured 10-g SAR within a frequency band is < 3.75 W/kg. The expanded SAR measurement uncertainty must be $\leq 30\%$, for a confidence interval of $k = 2$. If these conditions are met, extensive SAR measurement uncertainty analysis described in IEEE Std 1528 is not required in SAR reports submitted for equipment approval.

Therefore, the measurement uncertainty is not required.

6. SAR Measurement System Configuration

6.1. SAR Measurement Set-up

The DASY5 system for performing compliance tests consists of the following items:

A standard high precision 6-axis robot (Stäubli RX family) with controller and software. An arm extension for accommodating the data acquisition electronics (DAE).

A dosimetric probe, i.e. an isotropic E-field probe optimized and calibrated for usage in tissue simulating liquid. The probe is equipped with an optical surface detector system.

A data acquisition electronic (DAE) which performs the signal amplification, signal multiplexing, AD-conversion, offset measurements, mechanical surface detection, collision detection, etc. The unit is battery powered with standard or rechargeable batteries. The signal is optically transmitted to the EOC.

A unit to operate the optical surface detector which is connected to the EOC.

The Electro-Optical Coupler (EOC) performs the conversion from the optical into a digital electric signal of the DAE. The EOC is connected to the DASY5 measurement server.

The DASY5 measurement server, which performs all real-time data evaluation for field measurements and surface detection, controls robot movements and handles safety operation. A computer operating Windows 2003.

DASY5 software and SEMCAD data evaluation software.

Remote control with teach panel and additional circuitry for robot safety such as warning lamps, etc.

The generic twin phantom enabling the testing of left-hand and right-hand usage.

The device holder for handheld Mobile Phones.

Tissue simulating liquid mixed according to the given recipes.

System validation dipoles allowing to validate the proper functioning of the system.

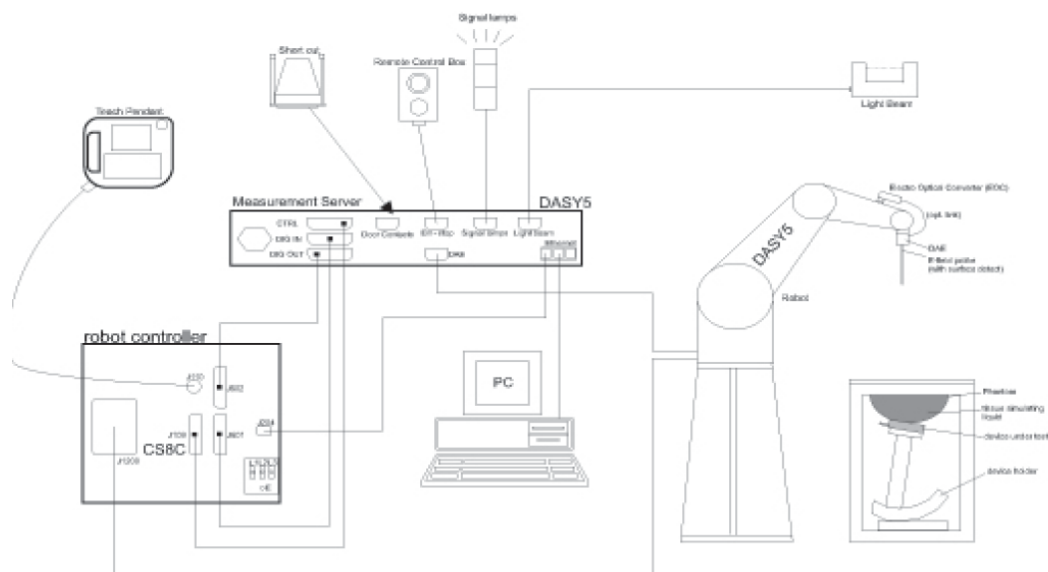

6.2. DASY5 E-field Probe System

The SAR measurements were conducted with the dosimetric probe EX3DV4 (manufactured by SPEAG), designed in the classical triangular configuration and optimized for dosimetric evaluation.

● Probe Specification

Construction	Symmetrical design with triangular core Interleaved sensors Built-in shielding against static charges PEEK enclosure material (resistant to organic solvents, e.g., DGBE)
Calibration	ISO/IEC 17025 calibration service available.
Frequency	4 MHz to 10 GHz; Linearity: ± 0.2 dB (30 MHz to 6 GHz)
Directivity	± 0.3 dB in HSL (rotation around probe axis) ± 0.5 dB in tissue material (rotation normal to probe axis)
Dynamic Range	10 μ W/g to > 100 W/kg; Linearity: ± 0.2 dB
Dimensions	Overall length: 337 mm (Tip: 20 mm) Tip diameter: 2.5 mm (Body: 12 mm) Distance from probe tip to dipole centers: 1.0 mm
Application	General dosimetry up to 6 GHz Dosimetry in strong gradient fields Compliance tests of Mobile Phones
Compatibility	DASY3, DASY4, DASY52 SAR and higher, EASY4/MRI

◆ Isotropic E-Field Probe

The isotropic E-Field probe has been fully calibrated and assessed for isotropicity, and boundary effect within a controlled environment. Depending on the frequency for which the probe is calibrated the method utilized for calibration will change.

The E-Field probe utilizes a triangular sensor arrangement as detailed in the diagram below:

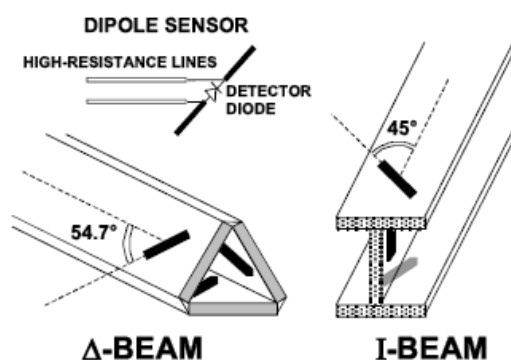

6.3. Phantoms

The phantom used for all tests i.e. for both system checks and device testing, was the twin-headed "SAM Phantom", manufactured by SPEAG. The SAM twin phantom is a fiberglass shell phantom with 2mm shell thickness (except the ear region, where shell thickness increases to 6mm).

System checking was performed using the flat section, whilst Head SAR tests used the left and right head profile sections. Body SAR testing also used the flat section between the head profiles.



SAM-Twin Phantom

6.4. Device Holder

The device was placed in the device holder (illustrated below) that is supplied by SPEAG as an integral part of the DASY system.

The DASY device holder is designed to cope with the different positions given in the standard. It has two scales for device rotation (with respect to the body axis) and device inclination (with respect to the line between the ear reference points). The rotation centers for both scales is the ear reference point (ERP). Thus the device needs no repositioning when changing the angles.



Device holder supplied by SPEAG

7. SAR Test Procedure

7.1. Scanning Procedure

Step 1: Power Reference Measurement

The Power Reference Measurement and Power Drift Measurements are for monitoring the power drift of the device under test in the batch process. Measure the local SAR at a test point within 8 mm of the phantom inner surface that is closest to the DUT. This distance cannot be smaller than the distance of sensor calibration points to probe tip as defined in the probe properties.

Step 2: Area Scan

The Area Scan is used as a fast scan in two dimensions to find the area of high field values, before doing a fine measurement around the hot spot. The sophisticated interpolation routines implemented in DASYS software can find the maximum locations even in relatively coarse grids. When an Area Scan has measured all reachable points, it computes the field maximal found in the scanned area, within a range of the global maximum. The range (in dB) is specified in the standards for compliance testing. For example, a 2 dB range is required in IEEE Standard 1528 and IEC 62209 standards, whereby 3 dB is a requirement when compliance is assessed in accordance with the ARIB standard (Japan). If only one Zoom Scan follows the Area Scan, then only the absolute maximum will be taken as reference. For cases where multiple maximums are detected, the number of Zoom Scans has to be increased accordingly.

Area Scan Resolutions per FCC KDB Publication 865664 D01v04

	≤ 3 GHz	> 3 GHz
Maximum distance from closest measurement point (geometric center of probe sensors) to phantom surface	5 mm ± 1 mm	$\frac{1}{2} \cdot \delta \cdot \ln(2)$ mm ± 0.5 mm
Maximum probe angle from probe axis to phantom surface normal at the measurement location	30° ± 1°	20° ± 1°
Maximum area scan spatial resolution: Δx_{Area} , Δy_{Area}	≤ 2 GHz: ≤ 15 mm 2 – 3 GHz: ≤ 12 mm	3 – 4 GHz: ≤ 12 mm 4 – 6 GHz: ≤ 10 mm
	When the x or y dimension of the test device, in the measurement plane orientation, is smaller than the above, the measurement resolution must be ≤ the corresponding x or y dimension of the test device with at least one measurement point on the test device.	

Step 3: Zoom Scan

Zoom Scans are used to assess the peak spatial SAR values within a cubic averaging volume containing 1g and 10g of simulated tissue. The Zoom Scan measures points (refer to table below) within a cube whose base faces are centered on the maxima found in a preceding area scan job within the same procedure. When the measurement is done, the Zoom Scan evaluates the averaged SAR for 1 g and 10 g and displays these values next to the job's label.

Zoom Scan Resolutions per FCC KDB Publication 865664 D01v04

Maximum zoom scan spatial resolution: Δx_{Zoom} , Δy_{Zoom}		≤ 2 GHz: ≤ 8 mm 2 – 3 GHz: ≤ 5 mm*	3 – 4 GHz: ≤ 5 mm* 4 – 6 GHz: ≤ 4 mm*
Maximum zoom scan spatial resolution, normal to phantom surface	uniform grid: $\Delta z_{Zoom}(n)$	≤ 5 mm	3 – 4 GHz: ≤ 4 mm 4 – 5 GHz: ≤ 3 mm 5 – 6 GHz: ≤ 2 mm
	graded grid	$\Delta z_{Zoom}(1)$: between 1 st two points closest to phantom surface	≤ 4 mm
		$\Delta z_{Zoom}(n>1)$: between subsequent points	$\leq 1.5 \cdot \Delta z_{Zoom}(n-1)$ mm
Minimum zoom scan volume	x, y, z	≥ 30 mm	3 – 4 GHz: ≥ 28 mm 4 – 5 GHz: ≥ 25 mm 5 – 6 GHz: ≥ 22 mm
Note: δ is the penetration depth of a plane-wave at normal incidence to the tissue medium; see IEEE Std 1528-2013 for details. * When zoom scan is required and the <i>reported</i> SAR from the <i>area scan based 1-g SAR estimation</i> procedures of KDB Publication 447498 is ≤ 1.4 W/kg, ≤ 8 mm, ≤ 7 mm and ≤ 5 mm zoom scan resolution may be applied, respectively, for 2 GHz to 3 GHz, 3 GHz to 4 GHz and 4 GHz to 6 GHz.			

Step 4: Power drift measurement

The Power Drift Measurement measures the field at the same location as the most recent power reference measurement within the same procedure, and with the same settings. The Power Drift Measurement gives the field difference in dB from the reading conducted within the last Power Reference Measurement. This allows a user to monitor the power drift of the device under test within a batch process. The measurement procedure is the same as Step 1. The SAR drift shall be kept within ± 5 %.

7.2. Data Storage and Evaluation

Data Storage

The DASY5 software stores the acquired data from the data acquisition electronics as raw data (in microvolt readings from the probe sensors),s together with all necessary software parameters for the data evaluation (probe calibration data, liquid parameters and device frequency and modulation data) in measurement files with the extension “.DA4”. The software evaluates the desired unit and format for output each time the data is visualized or exported. This allows verification of the complete software setup even after the measurement and allows correction of incorrect parameter settings. For example, if a measurement has been performed with a wrong crest factor parameter in the device setup, the parameter can be corrected afterwards and the data can be re-evaluated.

The measured data can be visualized or exported in different units or formats, depending on the selected probe type ([V/m], [A/m], [°C], [W/kg], [mW/cm²], [dBrel], etc.). Some of these units are not available in certain situations or show meaningless results, e.g., a SAR output in a lossless media will always be zero. Raw data can also be exported to perform the evaluation with other software packages.

Data Evaluation

The SEMCAD software automatically executes the following procedures to calculate the field units from the microvolt readings at the probe connector. The parameters used in the evaluation are stored in the configuration modules of the software:

Probe parameters:	Sensitivity:	Normi, ai0, ai1, ai2
	Conversion factor:	ConvFi
	Diode compression point:	Dcpi
Device parameters:	Frequency:	f
	Crest factor:	cf
Media parameters:	Conductivity:	σ
	Density:	ρ

These parameters must be set correctly in the software. They can be found in the component documents or they can be imported into the software from the configuration files issued for the DASY5 components. In the direct measuring mode of the multimeter option, the parameters of the actual system setup are used. In the scan visualization and export modes, the parameters stored in the corresponding document files are used.

The first step of the evaluation is a linearization of the filtered input signal to account for the compression characteristics of the detector diode. The compensation depends on the input signal, the diode type and the DC-transmission factor from the diode to the evaluation electronics. If the exciting field is pulsed, the crest factor of the signal must be known to correctly compensate for peak power. The formula for each channel can be given as:

$$V_i = U_i + U_i^2 \cdot \frac{cf}{dcp_i}$$

Vi:	compensated signal of channel (i = x, y, z)
Ui:	input signal of channel (i = x, y, z)
cf:	crest factor of exciting field (DASY parameter)
dcp _i :	diode compression point (DASY parameter)

From the compensated input signals the primary field data for each channel can be evaluated:

$$E - \text{fieldprobes} : \quad E_i = \sqrt{\frac{V_i}{Norm_i \cdot ConvF}}$$

$$H - \text{fieldprobes} : \quad H_i = \sqrt{V_i} \cdot \frac{a_{i0} + a_{i1}f + a_{i2}f^2}{f}$$

Vi:	compensated signal of channel (i = x, y, z)
Norm _i :	sensor sensitivity of channel (i = x, y, z), [mV/(V/m) ²] for E-field Probes
ConvF:	sensitivity enhancement in solution
a _{ij} :	sensor sensitivity factors for H-field probes
f:	carrier frequency [GHz]
E _i :	electric field strength of channel i in V/m
H _i :	magnetic field strength of channel i in A/m

The RSS value of the field components gives the total field strength (Hermitian magnitude):

$$E_{tot} = \sqrt{E_x^2 + E_y^2 + E_z^2}$$

The primary field data are used to calculate the derived field units.

$$SAR = E_{tot}^2 \cdot \frac{\sigma}{\rho \cdot 1'000}$$

SAR: local specific absorption rate in W/kg
Etot: total field strength in V/m
 σ : conductivity in [mho/m] or [Siemens/m]
 ρ : equivalent tissue density in g/cm³

Note that the density is normally set to 1 (or 1.06), to account for actual brain density rather than the density of the simulation liquid.

8. Position of the wireless device in relation to the phantom

8.1. Body Position

Devices that support transmission while used with body-worn accessories must be tested for body-worn accessory SAR compliance, typically according to the smallest test separation distance required for the group of body-worn accessories with similar operating and exposure characteristics.

Devices that are designed to operate on the body of users using lanyards and straps or without requiring additional body-worn accessories must be tested for SAR compliance using a conservative minimum test separation distance $\leq 5\text{mm}$ to support compliance.

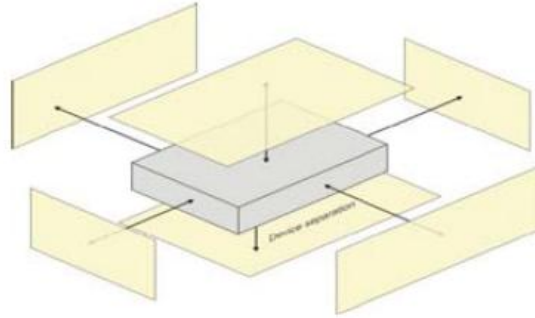

Picture 4 Test positions

9. Dielectric Property Measurements & System Check

9.1. Tissue Dielectric Parameters

The temperature of the tissue-equivalent medium used during measurement must also be within 18°C to 25°C and within $\pm 2^\circ\text{C}$ of the temperature when the tissue parameters are characterized.

The dielectric parameters must be measured before the tissue-equivalent medium is used in a series of SAR measurements. The parameters should be re-measured after each 3-4 days of use; or earlier if the dielectric parameters can become out of tolerance; for example, when the parameters are marginal at the beginning of the measurement series.

The dielectric constant (ϵ_r) and conductivity (σ) of typical tissue-equivalent media recipes are expected to be within $\pm 5\%$ of the required target values; but for SAR measurement systems that have implemented the SAR error compensation algorithms documented in IEEE Std 1528, to automatically compensate the measured SAR results for deviations between the measured and required tissue dielectric parameters, the tolerance for ϵ_r and σ may be relaxed to $\pm 10\%$. This is limited to frequencies ≤ 3 GHz.

Tissue Dielectric Parameters

FCC KDB 865664 D01 SAR Measurement 100 MHz to 6 GHz

Tissue dielectric parameters for Head		
Target Frequency (MHz)	Head	
	ϵ_r	$\sigma(\text{S/m})$
750	41.9	0.89
835	41.5	0.90
1750	40.1	1.37
1800-2000	40.0	1.40
2450	39.2	1.80
2600	39.0	1.96
5200	36.0	4.66
5300	35.9	4.76
5500	35.6	4.96
5600	35.5	5.07
5800	35.3	5.27

Measurement Results:

Dielectric performance of Head tissue simulating liquid									
Frequency (MHz)	ϵ_r		$\sigma(\text{S/m})$		Delta (ϵ_r)	Delta (σ)	Limit	Temp ($^\circ\text{C}$)	Date
	Target	Measured	Target	Measured					
2450	39.20	38.23	1.800	1.816	-2.47%	0.89%	$\pm 5\%$	22.2	2023/4/12

9.2. System Check

SAR system verification is required to confirm measurement accuracy, according to the tissue dielectric media, probe calibration points and other system operating parameters required for measuring the SAR of a test device. The system verification must be performed for each frequency band and within the valid range of each probe calibration point required for testing the device. The same SAR probe(s) and tissue-equivalent media combinations used with each specific SAR system for system verification must be used for device testing. When multiple probe calibration points are required to cover substantially large transmission bands, independent system verifications are required for each probe calibration point. A system verification must be performed before each series of SAR measurements using the same probe calibration point and tissue-equivalent medium. Additional system verification should be considered according to the conditions of the tissue-equivalent medium and measured tissue dielectric parameters, typically every three to four days when the liquid parameters are re-measured or sooner when marginal liquid parameters are used at the beginning of a series of measurements.

System Performance Check Measurement Conditions:

- The measurements were performed in the flat section of the TWIN SAM or ELI phantom, shell thickness: 2.0 ± 0.2 mm (bottom plate) filled with Body or Head simulating liquid of the following parameters.
- The depth of tissue-equivalent liquid in a phantom must be ≥ 15.0 cm for SAR measurements ≤ 3 GHz and ≥ 10.0 cm for measurements > 3 GHz.
- The DASY system with an E-Field Probe was used for the measurements.
- The dipole was mounted on the small tripod so that the dipole feed point was positioned below the center marking of the flat phantom section and the dipole was oriented parallel to the body axis (the long side of the phantom). The standard measuring distance was 10 mm (above 1 GHz) and 15 mm (below 1 GHz) from dipole center to the simulating liquid surface.
- The coarse grid with a grid spacing of 15 mm was aligned with the dipole.
For 5 GHz band - The coarse grid with a grid spacing of 10 mm was aligned with the dipole.
- Special 7x7x7 (below 3 GHz) and/or 8x8x7 (above 3 GHz) fine cube was chosen for the cube.
- The results are normalized to 1 W input power.

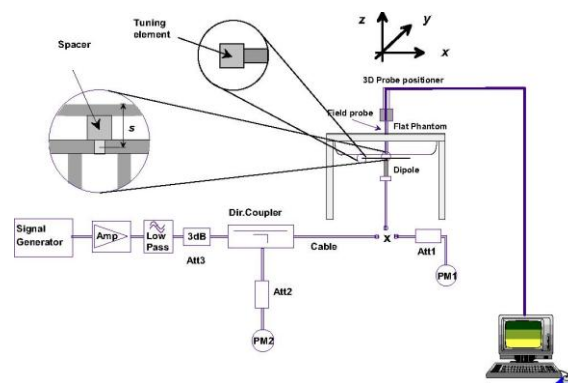

System Performance Check Setup

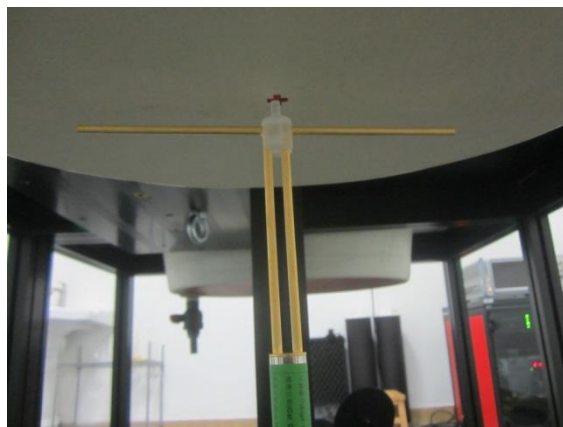

Photo of Dipole Setup

Measurement Results:

Head											
Frequency (MHz)	1g SAR			10g SAR			Delta (1g)	Delta (10g)	Limit	Temp (°C)	Date
	Target 1W	Normalize to 1W	Measured 250mW	Target 1W	Normalize to 1W	Measured 250mW					
2450	52.00	55.60	13.90	23.90	25.40	6.35	6.92%	6.28%	±10%	22.4	2023/4/12

Note:

The 1-g and 10-g SAR measured with a reference dipole, using the required tissue-equivalent medium at the test frequency, must be within ±10% of the manufacturer calibrated dipole SAR target.

Plots of System Performance Check**SystemPerformanceCheck-Head 2450MHz**

Communication System: UID 0, CW (0); Frequency: 2450 MHz; Duty Cycle: 1:1

Medium parameters used (interpolated): $f = 2450$ MHz; $\sigma = 1.816$ S/m; $\epsilon_r = 38.229$; $\rho = 1000$ kg/m³

Phantom section: Flat Section

Ambient Temperature: 22.4°C; Liquid Temperature: 22.2°C;

DASY Configuration:

- Probe: EX3DV4 - SN7494; ConvF(7.9, 7.9, 7.9) @ 2450 MHz; Calibrated: 5/16/2022
- Sensor-Surface: 1.4mm (Mechanical Surface Detection)
- Electronics: DAE4 Sn1549; Calibrated: 3/27/2023
- Phantom: Twin-SAM V8.0 ; Type: QD 000 P41 AA; Serial: 1974
- DASY52 52.10.2(1495); SEMCAD X 14.6.12(7450)

Head/d=10mm, Pin=250mW/Area Scan (41x61x1): Interpolated grid: dx=1.200 mm, dy=1.200 mm

Maximum value of SAR (interpolated) = 18.9 W/kg

Head/d=10mm, Pin=250mW/Zoom Scan (7x7x7)/Cube 0: Measurement grid: dx=5mm, dy=5mm, dz=5mm

Reference Value = 91.91 V/m; Power Drift = 0.02 dB

Peak SAR (extrapolated) = 27.9 W/kg

SAR(1 g) = 13.9 W/kg; SAR(10 g) = 6.35 W/kg

Maximum value of SAR (measured) = 18.2 W/kg

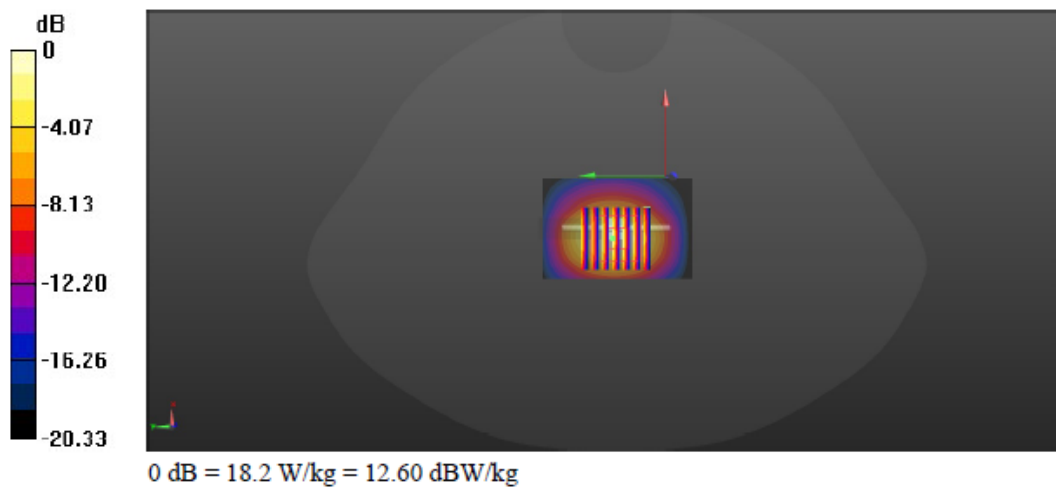

10. SAR Exposure Limits

SAR assessments have been made in line with the requirements of FCC 47 CFR § 2.1093.

Type Exposure	Limit (W/kg)	
	General Population/ Uncontrolled Exposure Environment	Occupational/ Controlled Exposure Environment
Spatial Average SAR (whole body)	0.08	0.4
Spatial Peak SAR (1g cube tissue for head and trunk)	1.6	8.0
Spatial Peak SAR (10g for limb)	4.0	20.0

Note:

- 1. Population/Uncontrolled Environments: are defined as locations where there is the exposure of individual who have no knowledge or control of their exposure.*
- 2. Occupational/Controlled Environments: are defined as locations where there is exposure that may be incurred by people who are aware of the potential for exposure (i.e. as a result of employment or occupation).*

11. Conducted Power Measurement Results and Tune-up

Please refer to appendix report

12. Antenna Location

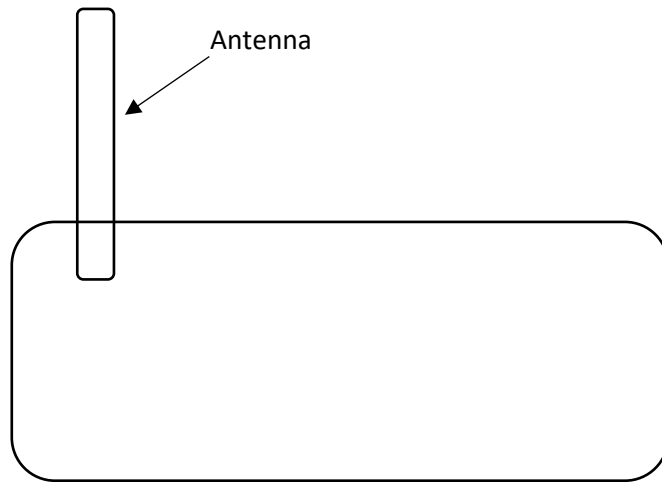

13. Measured and Reported SAR Results

Measurement Results:

Please refer to appendix report

Measurement data plots:

Please refer to appendix D

Note:

SAR Test Reduction criteria are as follows:

- Reported SAR(W/kg) for WWAN = Measured SAR * Tune-up Scaling Factor
- Reported SAR(W/kg) for Wi-Fi and Bluetooth = Measured SAR * Tune-up scaling factor * Duty Cycle scaling factor
- Duty Cycle scaling factor = 1 / Duty cycle (%)

KDB 447498 D04 Interim General RF Exposure Guidance v01:

Testing of other required channels within the operating mode of a frequency band is not required when the reported 1-g or 10-g SAR for the mid-band or highest output power channel is:

- ≤ 0.8 W/kg or 2.0 W/kg, for 1-g or 10-g respectively, when the transmission band is ≤ 100 MHz
- ≤ 0.6 W/kg or 1.5 W/kg, for 1-g or 10-g respectively, when the transmission band is between 100 MHz and 200 MHz
- ≤ 0.4 W/kg or 1.0 W/kg, for 1-g or 10-g respectively, when the transmission band is ≥ 200 MHz

KDB 648474 D04 Handset SAR:

With headset attached, when the reported SAR for body-worn accessory, measured without a headset connected to the handset, is > 1.2 W/kg, the highest reported SAR configuration for that wireless mode and frequency band should be repeated for that body-worn accessory with a headset attached to the handset. Additional 1-g SAR testing at 5 mm is not required when hotspot mode 10-g extremity SAR is not required for the surfaces and edges; since all 1-g reported SAR < 1.2 W/kg.

To determine the initial test position, Area Scans were performed to determine the position with the Maximum Value of SAR (measured). The position that produced the highest Maximum Value of SAR is considered the worst case position; thus used as the initial test position.

14. Test Setup Photos

Please refer to appendix Test Setup Photos

15. External and Internal Photos of the EUT

Please refer to appendix report External and Internal Photos of the EUT

-----End of Report-----

Project No.	SHT2301025101EW		
Test sample No.	YPHT23010251001	Model No.	DXR-8 PRO
Start test date	2023/4/11	Finish date	2023/4/12
Temperature	22.6°C	Humidity	42%%
Test Engineer	<i>Weyang Xiang</i>	Auditor	<i>Xiaodong Zhu</i>

Appendix clause	Test Item	Result
A	Conducted Power Measurement Results	PASS
B	SAR Measurement Results	PASS

Appendix A:Conducted Power Measurement Results

TFT			
Channel	Frequency (MHz)	Average Power (dBm)	Tune-up limit (dBm)
1	2410.00	10.21	10.50
10	2441.50	9.28	9.50
19	2473.00	8.72	9.00

Appendix B:SAR Measurement Results

TFT											
Test Position	Frequency		Conducted Power (dBm)	Tune-up limit (dBm)	Tune-up scaling factor	Duty Cycle	Duty Cycle Scaling Factor	Power Drift(dB)	Measured SAR(1g)	Report SAR(1g)	Plot No.
	CH	MHz							(W/kg)	(W/kg)	
Front with ant 90°	1	2410.00	10.21	10.50	1.069	80.00%	1.250	0.13	0.364	0.486	-
	10	2441.50	9.28	9.50	1.052	80.00%	1.250	-	-	-	-
	19	2473.00	8.72	9.00	1.067	80.00%	1.250	-	-	-	-
Rear with ant 90°	1	2410.00	10.21	10.50	1.069	80.00%	1.250	-0.06	0.448	0.599	-
	10	2441.50	9.28	9.50	1.052	80.00%	1.250	-	-	-	-
	19	2473.00	8.72	9.00	1.067	80.00%	1.250	-	-	-	-
Rear with ant 0°	1	2410.00	10.21	10.50	1.069	80.00%	1.250	-0.15	0.463	0.619	1
	10	2441.50	9.28	9.50	1.052	80.00%	1.250	-	-	-	-
	19	2473.00	8.72	9.00	1.067	80.00%	1.250	-	-	-	-
Top with ant 90°	1	2410.00	10.21	10.50	1.069	80.00%	1.250	0.04	0.251	0.335	-
	10	2441.50	9.28	9.50	1.052	80.00%	1.250	-	-	-	-
	19	2473.00	8.72	9.00	1.067	80.00%	1.250	-	-	-	-

TFT-L-Body

Communication System: UID 0, Generic WIFI (0); Frequency: 2410 MHz; Duty Cycle: 1:1
 Medium parameters used (interpolated): $f = 2410$ MHz; $\sigma = 1.792$ S/m; $\epsilon_r = 38.295$; $\rho = 1000$ kg/m³

Phantom section: Flat Section

Ambient Temperature: 22.6°C; Liquid Temperature: 22.4°C;

DASY Configuration:

- Probe: EX3DV4 - SN7494; ConvF(7.9, 7.9, 7.9) @ 2410 MHz; Calibrated: 5/16/2022
- Sensor-Surface: 1.4mm (Mechanical Surface Detection)
- Electronics: DAE4 Sn1549; Calibrated: 3/27/2023
- Phantom: Twin-SAM V8.0 ; Type: QD 000 P41 AA; Serial: 1974
- DASY52 52.10.2(1495); SEMCAD X 14.6.12(7450)

Rear/CH 1/Area Scan (91x151x1): Interpolated grid: dx=1.200 mm, dy=1.200 mm
 Maximum value of SAR (interpolated) = 0.718 W/kg

Rear/CH 1/Zoom Scan (7x7x7)/Cube 0: Measurement grid: dx=5mm, dy=5mm, dz=5mm

Reference Value = 2.062 V/m; Power Drift = -0.15 dB

Peak SAR (extrapolated) = 1.21 W/kg

SAR(1 g) = 0.463 W/kg; SAR(10 g) = 0.174 W/kg

Maximum value of SAR (measured) = 0.671 W/kg

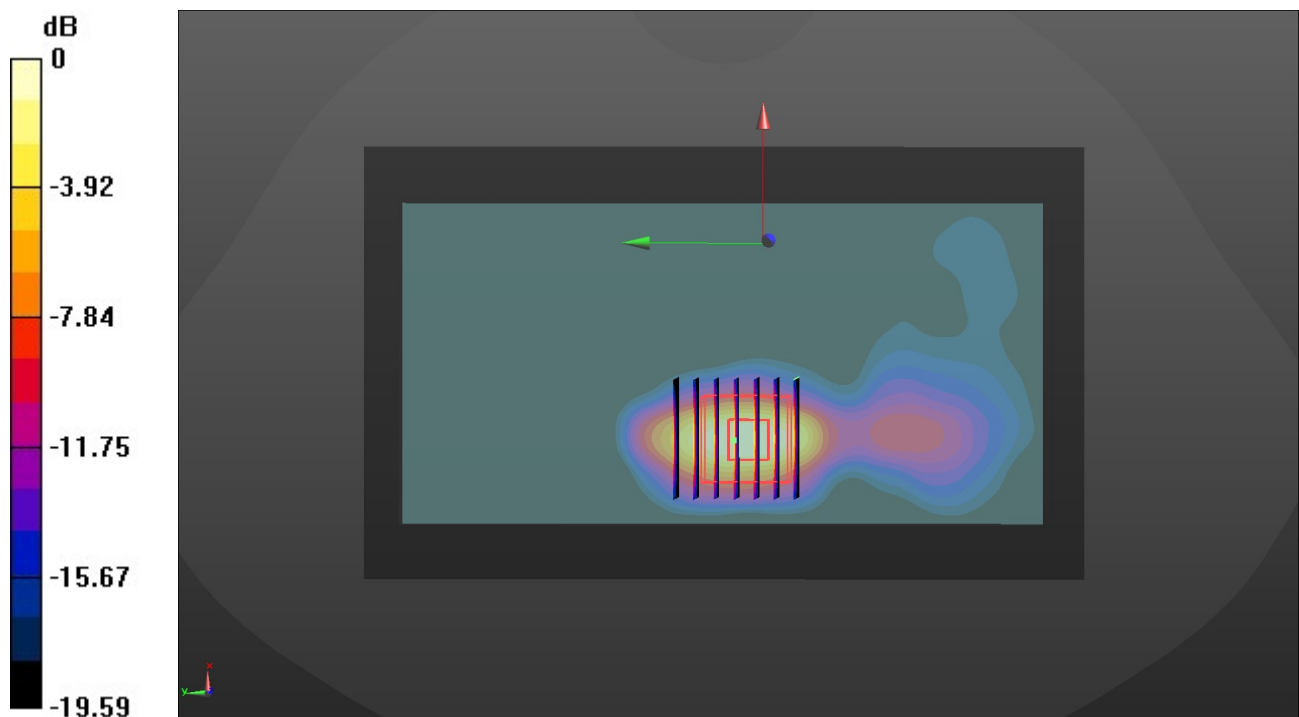



0 dB = 0.671 W/kg = -1.73 dBW/kg

1. DAE4 Calibration Certificate



In Collaboration with
speag
CALIBRATION LABORATORY

Add: No.52 HuaYuanBei Road, Haidian District, Beijing, 100191, China
Tel: +86-10-62304633-2117
E-mail: emf@caict.ac.cn <http://www.caict.ac.cn>

中国认可
国际互认
校准
CALIBRATION
CNAS L0570

Client : **HTW** Certificate No: **J23Z60202**

CALIBRATION CERTIFICATE																	
Object	DAE4 - SN: 1549																
Calibration Procedure(s)	FF-Z11-002-01 Calibration Procedure for the Data Acquisition Electronics (DAEx)																
Calibration date:	March 27, 2023																
<p>This calibration Certificate documents the traceability to national standards, which realize the physical units of measurements(SI). The measurements and the uncertainties with confidence probability are given on the following pages and are part of the certificate.</p> <p>All calibrations have been conducted in the closed laboratory facility: environment temperature(22±3)°C and humidity<70%.</p> <p>Calibration Equipment used (M&TE critical for calibration)</p> <table border="1" style="width: 100%; border-collapse: collapse; margin-top: 5px;"> <thead> <tr> <th style="width: 30%;">Primary Standards</th> <th style="width: 15%;">ID #</th> <th style="width: 40%;">Cal Date(Calibrated by, Certificate No.)</th> <th style="width: 15%;">Scheduled Calibration</th> </tr> </thead> <tbody> <tr> <td>Process Calibrator 753</td> <td>1971018</td> <td>14-Jun-22 (CTTL, No.J22X04180)</td> <td>Jun-23</td> </tr> </tbody> </table>		Primary Standards	ID #	Cal Date(Calibrated by, Certificate No.)	Scheduled Calibration	Process Calibrator 753	1971018	14-Jun-22 (CTTL, No.J22X04180)	Jun-23								
Primary Standards	ID #	Cal Date(Calibrated by, Certificate No.)	Scheduled Calibration														
Process Calibrator 753	1971018	14-Jun-22 (CTTL, No.J22X04180)	Jun-23														
<table style="width: 100%; border-collapse: collapse;"> <thead> <tr> <th style="width: 30%;"></th> <th style="width: 20%;">Name</th> <th style="width: 30%;">Function</th> <th style="width: 20%;">Signature</th> </tr> </thead> <tbody> <tr> <td style="padding: 5px;">Calibrated by:</td> <td style="padding: 5px;">Yu Zongying</td> <td style="padding: 5px;">SAR Test Engineer</td> <td style="padding: 5px;"></td> </tr> <tr> <td style="padding: 5px;">Reviewed by:</td> <td style="padding: 5px;">Lin Hao</td> <td style="padding: 5px;">SAR Test Engineer</td> <td style="padding: 5px;"></td> </tr> <tr> <td style="padding: 5px;">Approved by:</td> <td style="padding: 5px;">Qi Dianyuan</td> <td style="padding: 5px;">SAR Project Leader</td> <td style="padding: 5px;"></td> </tr> </tbody> </table>		Name	Function	Signature	Calibrated by:	Yu Zongying	SAR Test Engineer		Reviewed by:	Lin Hao	SAR Test Engineer		Approved by:	Qi Dianyuan	SAR Project Leader		<p style="text-align: right;">Issued: March 28, 2023</p> <p style="text-align: center;">This calibration certificate shall not be reproduced except in full without written approval of the laboratory.</p>
	Name	Function	Signature														
Calibrated by:	Yu Zongying	SAR Test Engineer															
Reviewed by:	Lin Hao	SAR Test Engineer															
Approved by:	Qi Dianyuan	SAR Project Leader															

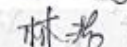
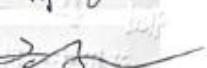
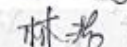
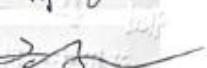
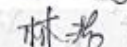
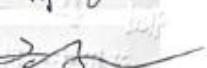

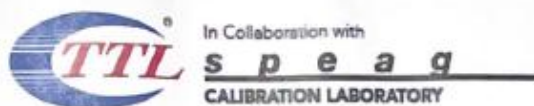
Add: No.52 HuaYuanBei Road, Haidian District, Beijing, 100191, China
Tel: +86-10-62304633-2117
E-mail: emf@caict.ac.cn <http://www.caict.ac.cn>

Glossary:

DAE data acquisition electronics
Connector angle information used in DASY system to align probe sensor X to the robot coordinate system.

Methods Applied and Interpretation of Parameters:

- *DC Voltage Measurement:* Calibration Factor assessed for use in DASY system by comparison with a calibrated instrument traceable to national standards. The figure given corresponds to the full scale range of the voltmeter in the respective range.
- *Connector angle:* The angle of the connector is assessed measuring the angle mechanically by a tool inserted. Uncertainty is not required.
- The report provide only calibration results for DAE, it does not contain other performance test results.



In Collaboration with
s p e a g
 CALIBRATION LABORATORY



Add: No.52 HuaYuanBei Road, Haidian District, Beijing, 100191, China
 Tel: +86-10-62304633-2117
 E-mail: emf@caict.ac.cn <http://www.caict.ac.cn>

DC Voltage Measurement

A/D - Converter Resolution nominal

High Range: 1LSB = 6.1μV, full range = -100...+300 mV

Low Range: 1LSB = 61nV, full range = -1.....+3mV



DASY measurement parameters: Auto Zero Time: 3 sec; Measuring time: 3 sec

Calibration Factors	X	Y	Z
High Range	406.340 ± 0.15% (k=2)	406.011 ± 0.15% (k=2)	406.173 ± 0.15% (k=2)
Low Range	3.98404 ± 0.7% (k=2)	3.99064 ± 0.7% (k=2)	3.99140 ± 0.7% (k=2)

Connector Angle

Connector Angle to be used in DASY system	18.5° ± 1°
---	------------

2. Probe Calibration Certificate

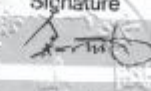
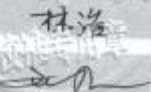
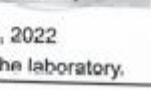
 In Collaboration with TTL s p e a g CALIBRATION LABORATORY		  中国认可 国际互认 校准 CALIBRATION CNAS L0570																																	
Add: No.52 HuaYuanBei Road, Haidian District, Beijing, 100191, China Tel: +86-10-62304633-2117 E-mail: ctli@chinattl.com http://www.caict.ac.cn																																			
Client		HTW																																	
		Certificate No: Z22-60102																																	
CALIBRATION CERTIFICATE																																			
Object	EX3DV4 - SN : 7494																																		
Calibration Procedure(s)	FF-Z11-004-02 Calibration Procedures for Dosimetric E-field Probes																																		
Calibration date:	May 16, 2022																																		
<p>This calibration Certificate documents the traceability to national standards, which realize the physical units of measurements(SI). The measurements and the uncertainties with confidence probability are given on the following pages and are part of the certificate.</p> <p>All calibrations have been conducted in the closed laboratory facility: environment temperature(22±3)°C and humidity<70%.</p>																																			
Calibration Equipment used (M&TE critical for calibration)																																			
<table border="1"> <thead> <tr> <th>Primary Standards</th> <th>ID #</th> <th>Cal Date(Calibrated by, Certificate No.)</th> <th>Scheduled Calibration</th> </tr> </thead> <tbody> <tr> <td>Power Meter NRP2</td> <td>101919</td> <td>15-Jun-21(CTTL, No.J21X04466)</td> <td>Jun-22</td> </tr> <tr> <td>Power sensor NRP-Z91</td> <td>101547</td> <td>15-Jun-21(CTTL, No.J21X04466)</td> <td>Jun-22</td> </tr> <tr> <td>Power sensor NRP-Z91</td> <td>101548</td> <td>15-Jun-21(CTTL, No.J21X04466)</td> <td>Jun-22</td> </tr> <tr> <td>Reference 10dBAttenuator</td> <td>18N50W-10dB</td> <td>20-Jan-21(CTTL, No.J21X00486)</td> <td>Jan-23</td> </tr> <tr> <td>Reference 20dBAttenuator</td> <td>18N50W-20dB</td> <td>20-Jan-21(CTTL, No.J21X00485)</td> <td>Jan-23</td> </tr> <tr> <td>Reference Probe EX3DV4</td> <td>SN 7464</td> <td>26-Jan-22(SPEAG, No.EX3-7464_Jan22)</td> <td>Jan-23</td> </tr> <tr> <td>DAE4</td> <td>SN 1555</td> <td>20-Aug-21(SPEAG, No.DAE4-1555_Aug21/2)</td> <td>Aug-22</td> </tr> </tbody> </table>				Primary Standards	ID #	Cal Date(Calibrated by, Certificate No.)	Scheduled Calibration	Power Meter NRP2	101919	15-Jun-21(CTTL, No.J21X04466)	Jun-22	Power sensor NRP-Z91	101547	15-Jun-21(CTTL, No.J21X04466)	Jun-22	Power sensor NRP-Z91	101548	15-Jun-21(CTTL, No.J21X04466)	Jun-22	Reference 10dBAttenuator	18N50W-10dB	20-Jan-21(CTTL, No.J21X00486)	Jan-23	Reference 20dBAttenuator	18N50W-20dB	20-Jan-21(CTTL, No.J21X00485)	Jan-23	Reference Probe EX3DV4	SN 7464	26-Jan-22(SPEAG, No.EX3-7464_Jan22)	Jan-23	DAE4	SN 1555	20-Aug-21(SPEAG, No.DAE4-1555_Aug21/2)	Aug-22
Primary Standards	ID #	Cal Date(Calibrated by, Certificate No.)	Scheduled Calibration																																
Power Meter NRP2	101919	15-Jun-21(CTTL, No.J21X04466)	Jun-22																																
Power sensor NRP-Z91	101547	15-Jun-21(CTTL, No.J21X04466)	Jun-22																																
Power sensor NRP-Z91	101548	15-Jun-21(CTTL, No.J21X04466)	Jun-22																																
Reference 10dBAttenuator	18N50W-10dB	20-Jan-21(CTTL, No.J21X00486)	Jan-23																																
Reference 20dBAttenuator	18N50W-20dB	20-Jan-21(CTTL, No.J21X00485)	Jan-23																																
Reference Probe EX3DV4	SN 7464	26-Jan-22(SPEAG, No.EX3-7464_Jan22)	Jan-23																																
DAE4	SN 1555	20-Aug-21(SPEAG, No.DAE4-1555_Aug21/2)	Aug-22																																
<table border="1"> <thead> <tr> <th>Secondary Standards</th> <th>ID #</th> <th>Cal Date(Calibrated by, Certificate No.)</th> <th>Scheduled Calibration</th> </tr> </thead> <tbody> <tr> <td>SignalGenerator MG3700A</td> <td>6201052605</td> <td>16-Jun-21(CTTL, No.J21X04467)</td> <td>Jun-22</td> </tr> <tr> <td>Network Analyzer E5071C</td> <td>MY46110673</td> <td>14-Jan-22(CTTL, No.J22X00406)</td> <td>Jan-23</td> </tr> </tbody> </table>				Secondary Standards	ID #	Cal Date(Calibrated by, Certificate No.)	Scheduled Calibration	SignalGenerator MG3700A	6201052605	16-Jun-21(CTTL, No.J21X04467)	Jun-22	Network Analyzer E5071C	MY46110673	14-Jan-22(CTTL, No.J22X00406)	Jan-23																				
Secondary Standards	ID #	Cal Date(Calibrated by, Certificate No.)	Scheduled Calibration																																
SignalGenerator MG3700A	6201052605	16-Jun-21(CTTL, No.J21X04467)	Jun-22																																
Network Analyzer E5071C	MY46110673	14-Jan-22(CTTL, No.J22X00406)	Jan-23																																
Calibrated by:	Name	Function	Signature																																
	Yu Zongying	SAR Test Engineer																																	
Reviewed by:	Lin Hao	SAR Test Engineer																																	
Approved by:	Qi Dianyuan	SAR Project Leader																																	
Issued: May 23, 2022																																			
This calibration certificate shall not be reproduced except in full without written approval of the laboratory.																																			



In Collaboration with
s p e a g
 CALIBRATION LABORATORY



Add: No.52 HuaYuanBei Road, Haidian District, Beijing, 100191, China
 Tel: +86-10-62304633-2117
 E-mail: cttl@chinattl.com <http://www.caict.ac.cn>

Glossary:

TSL	tissue simulating liquid
NORM _{x,y,z}	sensitivity in free space
ConvF	sensitivity in TSL / NORM _{x,y,z}
DCP	diode compression point
CF	crest factor (1/duty_cycle) of the RF signal
A,B,C,D	modulation dependent linearization parameters
Polarization Φ	Φ rotation around probe axis
Polarization θ	θ rotation around an axis that is in the plane normal to probe axis (at measurement center) $\theta=0$ is normal to probe axis
Connector Angle	information used in DASY system to align probe sensor X to the robot coordinate system

Calibration is Performed According to the Following Standards:

- IEEE Std 1528-2013, "IEEE Recommended Practice for Determining the Peak Spatial-Averaged Specific Absorption Rate (SAR) in the Human Head from Wireless Communications Devices: Measurement Techniques", June 2013
- IEC 62209-1, "Measurement procedure for the assessment of Specific Absorption Rate (SAR) from hand-held and body-mounted devices used next to the ear (frequency range of 300 MHz to 6 GHz)", July 2016
- IEC 62209-2, "Procedure to determine the Specific Absorption Rate (SAR) for wireless communication devices used in close proximity to the human body (frequency range of 30 MHz to 6 GHz)", March 2010
- KDB 865664, "SAR Measurement Requirements for 100 MHz to 6 GHz"

Methods Applied and Interpretation of Parameters:

- NORM_{x,y,z}**: Assessed for E-field polarization $\theta=0$ ($f \leq 900$ MHz in TEM-cell; $f > 1800$ MHz: waveguide). NORM_{x,y,z} are only intermediate values, i.e., the uncertainties of NORM_{x,y,z} does not effect the E^2 -field uncertainty inside TSL (see below ConvF).
- NORM(f)_{x,y,z}** = NORM_{x,y,z} * frequency_response (see Frequency Response Chart). This linearization is implemented in DASY4 software versions later than 4.2. The uncertainty of the frequency response is included in the stated uncertainty of ConvF.
- DCP_{x,y,z}**: DCP are numerical linearization parameters assessed based on the data of power sweep (no uncertainty required). DCP does not depend on frequency nor media.
- PAR**: PAR is the Peak to Average Ratio that is not calibrated but determined based on the signal characteristics.
- A_{x,y,z}; B_{x,y,z}; C_{x,y,z}; VR_{x,y,z}; A,B,C** are numerical linearization parameters assessed based on the data of power sweep for specific modulation signal. The parameters do not depend on frequency nor media. VR is the maximum calibration range expressed in RMS voltage across the diode.
- ConvF and Boundary Effect Parameters**: Assessed in flat phantom using E-field (or Temperature Transfer Standard for $f \leq 800$ MHz) and inside waveguide using analytical field distributions based on power measurements for $f > 800$ MHz. The same setups are used for assessment of the parameters applied for boundary compensation (alpha, depth) of which typical uncertainty valued are given. These parameters are used in DASY4 software to improve probe accuracy close to the boundary. The sensitivity in TSL corresponds to NORM_{x,y,z} * ConvF whereby the uncertainty corresponds to that given for ConvF. A frequency dependent ConvF is used in DASY version 4.4 and higher which allows extending the validity from ± 50 MHz to ± 100 MHz.
- Spherical isotropy (3D deviation from isotropy)**: in a field of low gradients realized using a flat phantom exposed by a patch antenna.
- Sensor Offset**: The sensor offset corresponds to the offset of virtual measurement center from the probe tip (on probe axis). No tolerance required.
- Connector Angle**: The angle is assessed using the information gained by determining the NORM_x (no uncertainty required).

Certificate No: Z22-60102

Page 2 of 9



Add: No.52 HuaYuanBei Road, Haidian District, Beijing, 100191, China
 Tel: +86-10-62304633-2117
 E-mail: cttl@chinattl.com http://www.caiet.ac.cn

DASY/EASY – Parameters of Probe: EX3DV4 – SN:7494

Basic Calibration Parameters

	Sensor X	Sensor Y	Sensor Z	Unc (k=2)
Norm($\mu\text{V}/(\text{V}/\text{m})^2$) ^A	0.41	0.48	0.42	$\pm 10.0\%$
DGP(mV) ^B	99.2	100.0	100.2	

Modulation Calibration Parameters

UID	Communication System Name		A dB	B dB $\cdot\mu\text{V}$	C	D dB	VR mV	Unc ^E (k=2)
0	CW	X	0.0	0.0	1.0	0.00	145.6	$\pm 1.9\%$
		Y	0.0	0.0	1.0		160.4	
		Z	0.0	0.0	1.0		149.0	

The reported uncertainty of measurement is stated as the standard uncertainty of Measurement multiplied by the coverage factor $k=2$, which for a normal distribution Corresponds to a coverage probability of approximately 95%.

^A The uncertainties of Norm X, Y, Z do not affect the E^2 -field uncertainty inside TSL (see Page 4).

^B Numerical linearization parameter: uncertainty not required.

^E Uncertainty is determined using the max. deviation from linear response applying rectangular distribution and is expressed for the square of the field value.



Add: No.52 HuaYuanBei Road, Haidian District, Beijing, 100191, China
Tel: +86-10-62304633-2117
E-mail: cttl@chinattl.com http://www.caict.ac.cn

DASY/EASY – Parameters of Probe: EX3DV4 – SN:7494

Calibration Parameter Determined in Head Tissue Simulating Media

f [MHz] ^C	Relative Permittivity ^F	Conductivity (S/m) ^F	ConvF X	ConvF Y	ConvF Z	Alpha ^G	Depth ^G (mm)	Unct. (k=2)
750	41.9	0.89	10.60	10.60	10.60	0.12	1.43	± 12.1%
835	41.5	0.90	10.30	10.30	10.30	0.12	1.48	± 12.1%
1750	40.1	1.37	8.81	8.81	8.81	0.25	0.92	± 12.1%
1900	40.0	1.40	8.45	8.45	8.45	0.25	1.04	± 12.1%
2000	40.0	1.40	8.42	8.42	8.42	0.26	1.04	± 12.1%
2300	39.5	1.67	8.25	8.25	8.25	0.62	0.63	± 12.1%
2450	39.2	1.80	7.90	7.90	7.90	0.41	0.84	± 12.1%
2600	39.0	1.96	7.65	7.65	7.65	0.49	0.74	± 12.1%
5250	35.9	4.71	5.61	5.61	5.61	0.50	1.20	± 13.3%
5600	35.5	5.07	5.01	5.01	5.01	0.45	1.38	± 13.3%
5750	35.4	5.22	4.97	4.97	4.97	0.50	1.30	± 13.3%

^C Frequency validity above 300 MHz of ±100MHz only applies for DASY v4.4 and higher (Page 2), else it is restricted to ±50MHz. The uncertainty is the RSS of ConvF uncertainty at calibration frequency and the uncertainty for the indicated frequency band. Frequency validity below 300 MHz is ± 10, 25, 40, 50 and 70 MHz for ConvF assessments at 30, 64, 128, 150 and 220 MHz respectively. Above 5 GHz frequency validity can be extended to ± 110 MHz.

^F At frequency below 3 GHz, the validity of tissue parameters (ϵ and σ) can be relaxed to ±10% if liquid compensation formula is applied to measured SAR values. At frequencies above 3 GHz, the validity of tissue parameters (ϵ and σ) is restricted to ±5%. The uncertainty is the RSS of the ConvF uncertainty for indicated target tissue parameters.

^G Alpha/Depth are determined during calibration. SPEAG warrants that the remaining deviation due to the boundary effect after compensation is always less than ± 1% for frequencies below 3 GHz and below ± 2% for the frequencies between 3-6 GHz at any distance larger than half the probe tip diameter from the boundary.



Add: No.52 HuaYuanBei Road, Haidian District, Beijing, 100191, China
Tel: +86-10-62304633-2117
E-mail: ctl@chinattl.com <http://www.caict.ac.cn>

Frequency Response of E-Field (TEM-Cell: ifi110 EXX, Waveguide: R22)

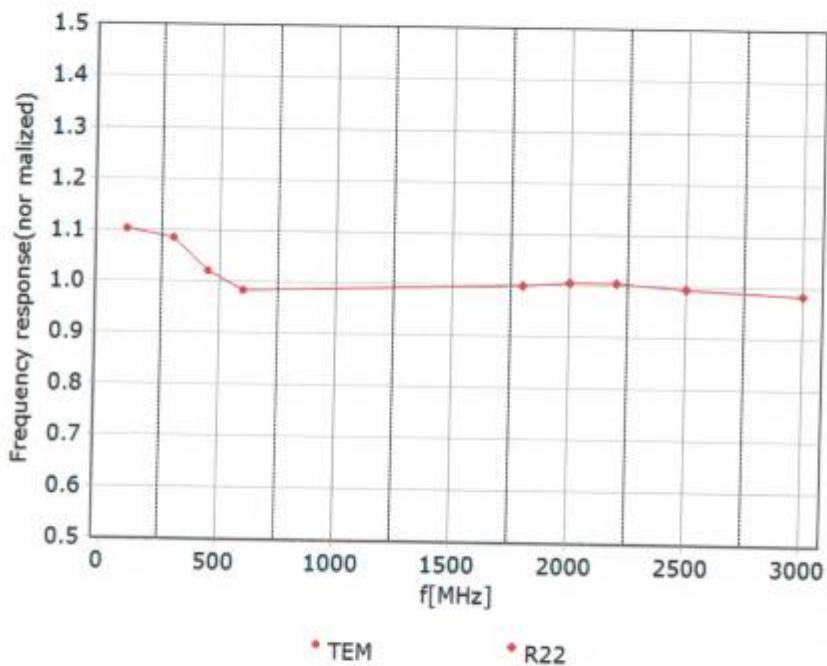

Uncertainty of Frequency Response of E-field: $\pm 7.4\%$ ($k=2$)



In Collaboration with
s p e a g
 CALIBRATION LABORATORY



Add: No.52 HuaYuanBei Road, Haidian District, Beijing, 100191, China
 Tel: +86-10-62304633-2117
 E-mail: cttl@chinattl.com http://www.caict.ac.cn

Receiving Pattern (Φ), $\theta=0^\circ$

f=600 MHz, TEM

f=1800 MHz, R22

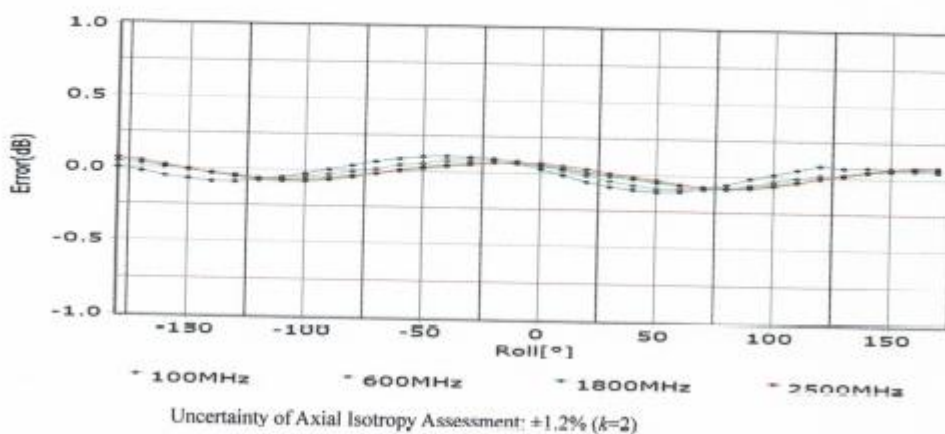
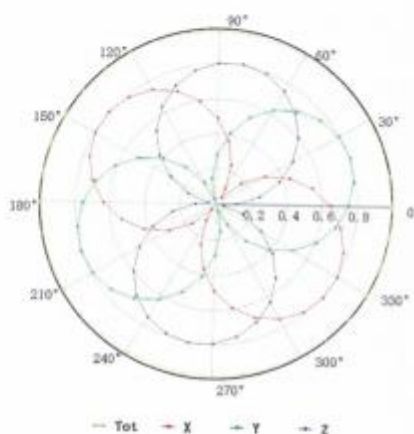
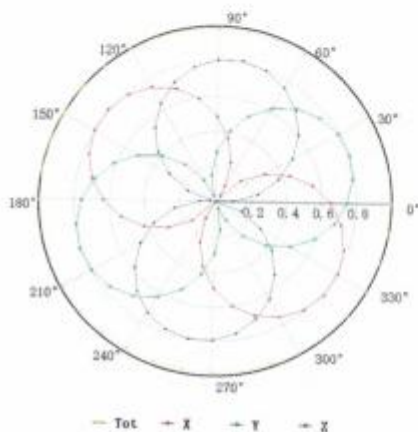



Add: No.52 HuaYuanBei Road, Haidian District, Beijing, 100191, China
 Tel: +86-10-62304633-2117
 E-mail: cttl@chinattl.com http://www.caict.ac.cn

Dynamic Range $f(SAR_{head})$ (TEM cell, $f = 900$ MHz)

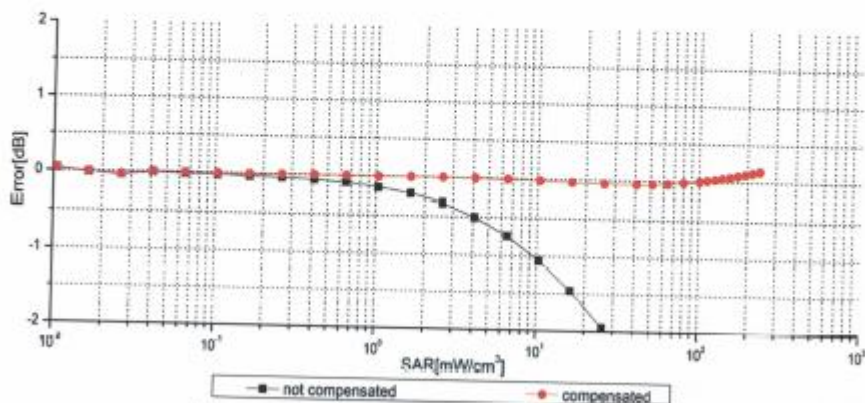
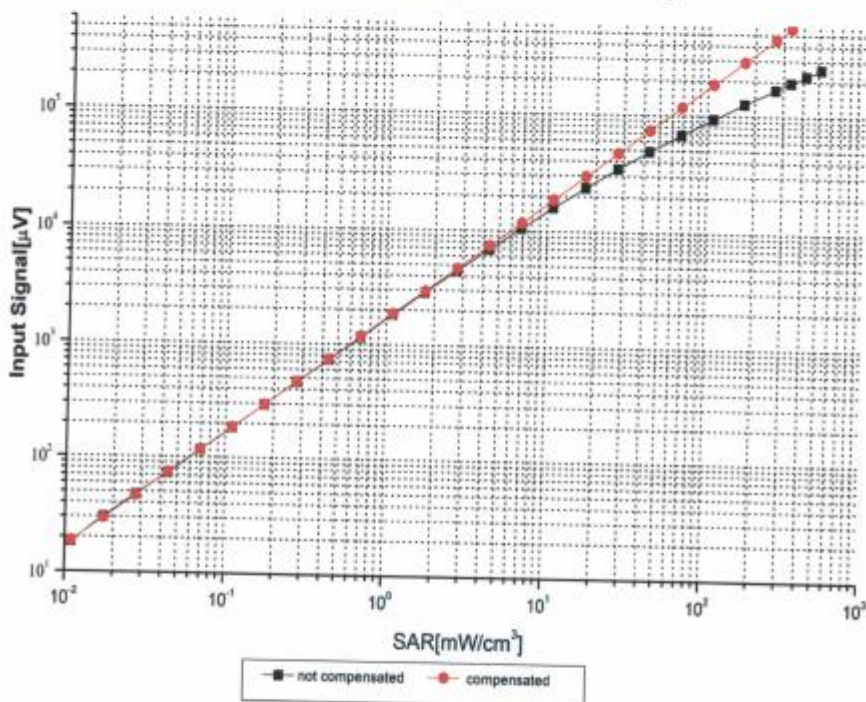

Uncertainty of Linearity Assessment: $\pm 0.9\%$ ($k=2$)



Add: No.52 HunYuanBei Road, Haidian District, Beijing, 100191, China
 Tel: +86-10-62304633-2117
 E-mail: cttl@chinattl.com http://www.caict.ac.cn

Conversion Factor Assessment

f=750 MHz,WGLS R9(H_convF)

f=1750 MHz,WGLS R22(H_convF)

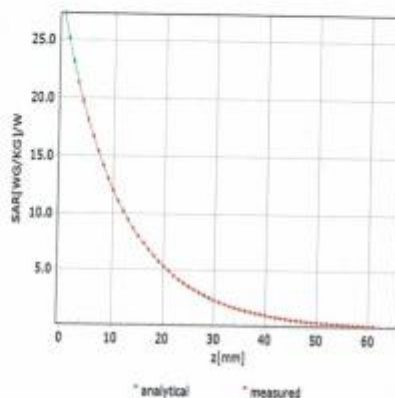
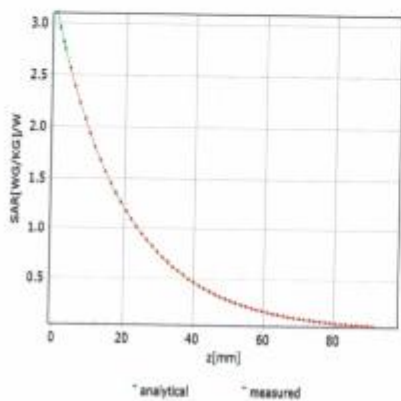

Deviation from Isotropy in Liquid

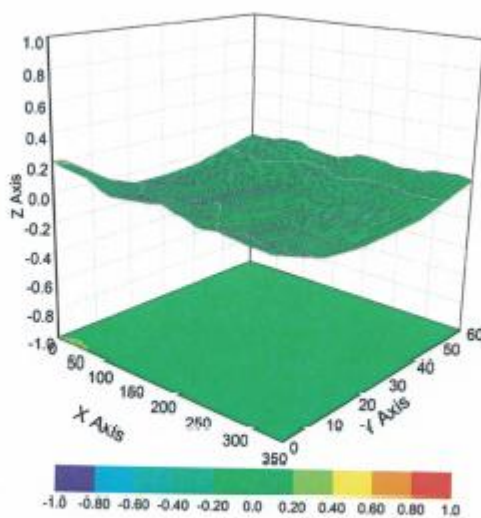

Uncertainty of Spherical Isotropy Assessment: $\pm 3.2\%$ ($k=2$)



In Collaboration with
s p e a g
 CALIBRATION LABORATORY



Add: No.52 HuaYuanBei Road, Haidian District, Beijing, 100191, China
 Tel: +86-10-62304633-2117
 E-mail: cttl@chinattl.com http://www.caiet.ac.cn

DASY/EASY – Parameters of Probe: EX3DV4 – SN:7494

Other Probe Parameters

Sensor Arrangement	Triangular
Connector Angle (°)	22.4
Mechanical Surface Detection Mode	enabled
Optical Surface Detection Mode	disable
Probe Overall Length	337mm
Probe Body Diameter	10mm
Tip Length	9mm
Tip Diameter	2.5mm
Probe Tip to Sensor X Calibration Point	1mm
Probe Tip to Sensor Y Calibration Point	1mm
Probe Tip to Sensor Z Calibration Point	1mm
Recommended Measurement Distance from Surface	1.4mm

1.1. D2450V2 Dipole Calibration Certificate

Client **HTW** Certificate No: **Z21-60020**

CALIBRATION CERTIFICATE

Object **D2450V2 - SN: 1009**

Calibration Procedure(s) **FF-Z11-003-01**
Calibration Procedures for dipole validation kits

Calibration date: **January 25, 2021**

This calibration Certificate documents the traceability to national standards, which realize the physical units of measurements(SI). The measurements and the uncertainties with confidence probability are given on the following pages and are part of the certificate.

All calibrations have been conducted in the closed laboratory facility: environment temperature(22±3)°C and humidity<70%.

Calibration Equipment used (M&TE critical for calibration)

Primary Standards	ID #	Cal Date(Calibrated by, Certificate No.)	Scheduled Calibration
Power Meter NRP2	106276	12-May-20 (CTTL, No.J20X02965)	May-21
Power sensor NRP6A	101369	12-May-20 (CTTL, No.J20X02965)	May-21
ReferenceProbe EX3DV4	SN 7600	30-Nov-20(CTTL-SPEAG,No.Z20-60421)	Nov-21
DAE4	SN 771	10-Feb-20(CTTL-SPEAG,No.Z20-60017)	Feb-21
Secondary Standards	ID #	Cal Date(Calibrated by, Certificate No.)	Scheduled Calibration
Signal Generator E4438C	MY49071430	25-Feb-20 (CTTL, No.J20X00516)	Feb-21
NetworkAnalyzer E5071C	MY46110673	10-Feb-20 (CTTL, No.J20X00515)	Feb-21

	Name	Function	Signature
Calibrated by:	Zhao Jing	SAR Test Engineer	
Reviewed by:	Lin Hao	SAR Test Engineer	
Approved by:	Qi Dianyuan	SAR Project Leader	

Issued: January 29, 2021

This calibration certificate shall not be reproduced except in full without written approval of the laboratory.



In Collaboration with
s p e a g
CALIBRATION LABORATORY

Add: No.51 Xueyuan Road, Haidian District, Beijing, 100191, China
 Tel: +86-10-62304633-2079 Fax: +86-10-62304633-2504
 E-mail: cttl@chinattl.com http://www.chinattl.cn

Glossary:

TSL	tissue simulating liquid
ConvF	sensitivity in TSL / NORM _{x,y,z}
N/A	not applicable or not measured

Calibration is Performed According to the Following Standards:

- a) IEEE Std 1528-2013, "IEEE Recommended Practice for Determining the Peak Spatial-Averaged Specific Absorption Rate (SAR) in the Human Head from Wireless Communications Devices: Measurement Techniques", June 2013
- b) IEC 62209-1, "Measurement procedure for assessment of specific absorption rate of human exposure to radio frequency fields from hand-held and body-mounted wireless communication devices- Part 1: Device used next to the ear (Frequency range of 300MHz to 6GHz)", July 2016
- c) IEC 62209-2, "Procedure to measure the Specific Absorption Rate (SAR) For wireless communication devices used in close proximity to the human body (frequency range of 30MHz to 6GHz)", March 2010
- d) KDB865664, SAR Measurement Requirements for 100 MHz to 6 GHz

Additional Documentation:

- e) DASY4/5 System Handbook

Methods Applied and Interpretation of Parameters:

- *Measurement Conditions:* Further details are available from the Validation Report at the end of the certificate. All figures stated in the certificate are valid at the frequency indicated.
- *Antenna Parameters with TSL:* The dipole is mounted with the spacer to position its feed point exactly below the center marking of the flat phantom section, with the arms oriented parallel to the body axis.
- *Feed Point Impedance and Return Loss:* These parameters are measured with the dipole positioned under the liquid filled phantom. The impedance stated is transformed from the measurement at the SMA connector to the feed point. The Return Loss ensures low reflected power. No uncertainty required.
- *Electrical Delay:* One-way delay between the SMA connector and the antenna feed point. No uncertainty required.
- *SAR measured:* SAR measured at the stated antenna input power.
- *SAR normalized:* SAR as measured, normalized to an input power of 1 W at the antenna connector.
- *SAR for nominal TSL parameters:* The measured TSL parameters are used to calculate the nominal SAR result.

The reported uncertainty of measurement is stated as the standard uncertainty of Measurement multiplied by the coverage factor $k=2$, which for a normal distribution Corresponds to a coverage probability of approximately 95%.



In Collaboration with
s p e a g
 CALIBRATION LABORATORY

Add: No.51 Xueyuan Road, Haidian District, Beijing, 100191, China
 Tel: +86-10-62304633-2079 Fax: +86-10-62304633-2504
 E-mail: cttl@chinattl.com http://www.chinattl.cn

Measurement Conditions

DASY system configuration, as far as not given on page 1.

DASY Version	DASY52	V52.10.4
Extrapolation	Advanced Extrapolation	
Phantom	Triple Flat Phantom 5.1C	
Distance Dipole Center - TSL	10 mm	with Spacer
Zoom Scan Resolution	dx, dy, dz = 5 mm	
Frequency	2450 MHz \pm 1 MHz	

Head TSL parameters

The following parameters and calculations were applied.

	Temperature	Permittivity	Conductivity
Nominal Head TSL parameters	22.0 °C	39.2	1.80 mho/m
Measured Head TSL parameters	(22.0 \pm 0.2) °C	39.5 \pm 6 %	1.81 mho/m \pm 6 %
Head TSL temperature change during test	<1.0 °C	----	----

SAR result with Head TSL

SAR averaged over 1 cm^3 (1 g) of Head TSL	Condition	
SAR measured	250 mW input power	13.0 W/kg
SAR for nominal Head TSL parameters	normalized to 1W	52.0 W/kg \pm 18.8 % ($k=2$)
SAR averaged over 10 cm^3 (10 g) of Head TSL	Condition	
SAR measured	250 mW input power	5.97 W/kg
SAR for nominal Head TSL parameters	normalized to 1W	23.9 W/kg \pm 18.7 % ($k=2$)



In Collaboration with
s p e a g
 CALIBRATION LABORATORY

Add: No.51 Xueyuan Road, Haidian District, Beijing, 100191, China
 Tel: +86-10-62304633-2079 Fax: +86-10-62304633-2504
 E-mail: cttl@chinattl.com http://www.chinattl.cn

Appendix (Additional assessments outside the scope of CNAS L0570)

Antenna Parameters with Head TSL

Impedance, transformed to feed point	53.9Ω+ 2.04jΩ
Return Loss	- 27.4dB

General Antenna Parameters and Design

Electrical Delay (one direction)	1.064 ns
----------------------------------	----------

After long term use with 100W radiated power, only a slight warming of the dipole near the feedpoint can be measured.

The dipole is made of standard semirigid coaxial cable. The center conductor of the feeding line is directly connected to the second arm of the dipole. The antenna is therefore short-circuited for DC-signals. On some of the dipoles, small end caps are added to the dipole arms in order to improve matching when loaded according to the position as explained in the "Measurement Conditions" paragraph. The SAR data are not affected by this change. The overall dipole length is still according to the Standard. No excessive force must be applied to the dipole arms, because they might bend or the soldered connections near the feedpoint may be damaged.

Additional EUT Data

Manufactured by	SPEAG
-----------------	-------



In Collaboration with
s p e a g
CALIBRATION LABORATORY

Add: No.51 Xueyuan Road, Haidian District, Beijing, 100191, China
Tel: +86-10-62304633-2079 Fax: +86-10-62304633-2504
E-mail: cttl@chinattl.com http://www.chinattl.cn

DASY5 Validation Report for Head TSL

Date: 01.25.2021

Test Laboratory: CTTL, Beijing, China

DUT: Dipole 2450 MHz; Type: D2450V2; Serial: D2450V2 - SN: 1009

Communication System: UID 0, CW; Frequency: 2450 MHz; Duty Cycle: 1:1

Medium parameters used: $f = 2450$ MHz; $\sigma = 1.81$ S/m; $\epsilon_r = 39.52$; $\rho = 1000$ kg/m³

Phantom section: Center Section

DASY5 Configuration:

- Probe: EX3DV4 - SN7600; ConvF(7.79, 7.79, 7.79) @ 2450 MHz; Calibrated: 2020-11-30
- Sensor-Surface: 1.4mm (Mechanical Surface Detection)
- Electronics: DAE4 Sn771; Calibrated: 2020-02-10
- Phantom: MFP_V5.1C (20deg probe tilt); Type: QD 000 P51 Cx; Serial: 1062
- Measurement SW: DASY52, Version 52.10 (4); SEMCAD X Version 14.6.14 (7483)

Dipole Calibration/Zoom Scan (7x7x7) (7x7x7)/Cube 0: Measurement grid: dx=5mm, dy=5mm, dz=5mm

Reference Value = 102.7 V/m; Power Drift = -0.06 dB

Peak SAR (extrapolated) = 27.2 W/kg

SAR(1 g) = 13 W/kg; SAR(10 g) = 5.97 W/kg

Smallest distance from peaks to all points 3 dB below = 9.5 mm

Ratio of SAR at M2 to SAR at M1 = 47.2%

Maximum value of SAR (measured) = 22.0 W/kg

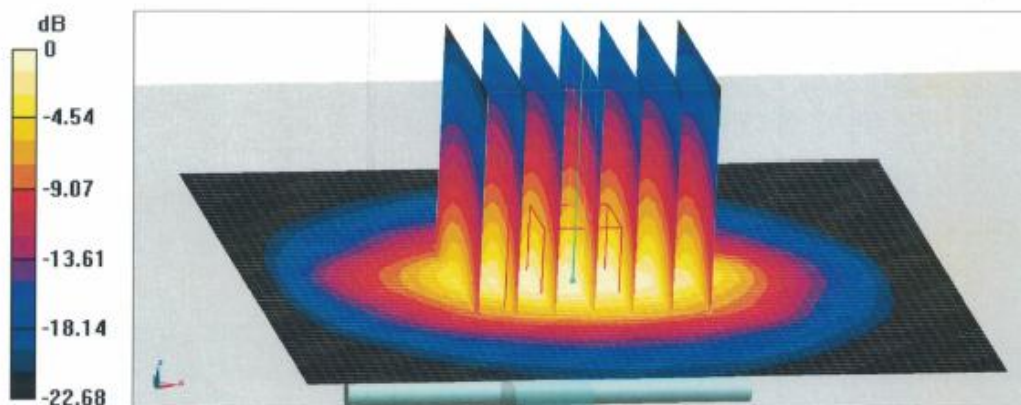

0 dB = 22.0 W/kg = 13.42 dBW/kg



In Collaboration with
s p e a g
CALIBRATION LABORATORY

Add: No.51 Xueyuan Road, Haidian District, Beijing, 100191, China
Tel: +86-10-62304633-2079 Fax: +86-10-62304633-2504
E-mail: cttl@chinattl.com http://www.chinattl.cn

Impedance Measurement Plot for Head TSL

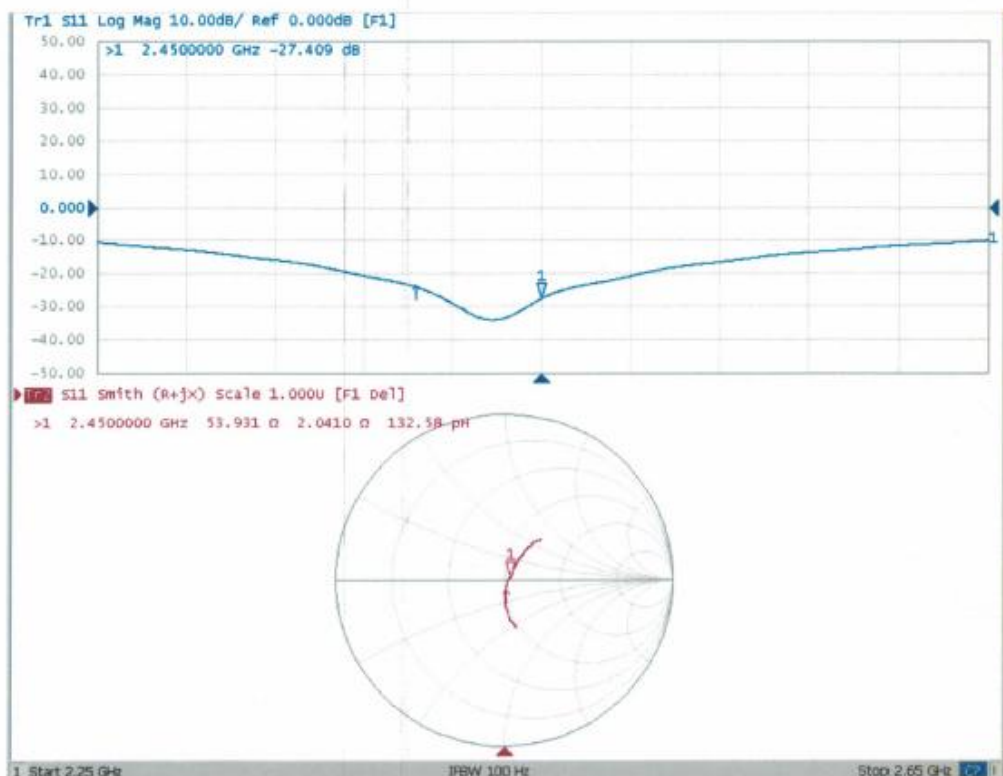

Extended Dipole Calibrations

Referring to KDB865664 D01, if dipoles are verified in return loss (<-20dB, within 20% of prior calibration), and in impedance (within 5 ohm of prior calibration), the annual calibration is not necessary and the calibration interval can be extended.

Head-2450						
Date of measurement	Return-loss (dB)	Delta (%)	Real Impedance (ohm)	Delta (ohm)	Imaginary impedance (ohm)	Delta (ohm)
2021-01-25	-27.4		53.9		2.04	
2022-01-17	-27.9	1.82	53.5	0.4	2.34	0.3
2023-01-15	-27.3	-0.36	53.7	0.2	2.16	0.12

The return loss is <-20dB, within 20% of prior calibration; the impedance is within 5ohm of prior calibration. Therefore the verification result should support extended calibration.

