



# TEST REPORT

**Report Reference No.**..... : **TRE14120180** R/C.....:10258  
**FCC ID**..... : **2AAAL-T041-315-FR01**  
**Applicant's name**..... : **Dalian Seaside Door Controlling System Co. Ltd.**  
 Address.....: No.23-7,Yaobei Road,Ganjingzi District,Dalian,Liaoning,China.  
 Manufacturer.....: **Dalian Seaside Door Controlling System Co. Ltd.**  
 Address.....: No.23-7,Yaobei Road,Ganjingzi District,Dalian,Liaoning,China.  
**Test item description** ..... : Remote Control  
 Trade Mark ..... : /  
 Model/Type reference.....: T041-315-FR01  
 Listed Model(s)..... : /  
**Standard** ..... : **FCC CFR Title 47 Part 15 Subpart C Section 15.231**  
 Date of receipt of test sample.....: Dec 31, 2014  
 Date of testing.....: Dec 31, 2014- Mar 13, 2015  
 Date of issue.....: Mar 13, 2015  
**Result**.....: **PASS**

Compiled by  
 ( position+printed name+signature)...: File administrators Yingchun Shan

*Yingchun Shan*

Supervised by  
 ( position+printed name+signature)...: Project Engineer Yingchun Shan

*Yingchun Shan*

Approved by  
 ( position+printed name+signature)...: RF Manager Hans Hu

*Hans Hu*

**Testing Laboratory Name** ..... : **Shenzhen Huatongwei International Inspection Co., Ltd**  
 Address.....: Keji Nan No.12 Road, Hi-tech Park, Shenzhen, China

**Shenzhen Huatongwei International Inspection Co., Ltd. All rights reserved.**

This publication may be reproduced in whole or in part for non-commercial purposes as long as the Shenzhen Huatongwei International Inspection Co., Ltd is acknowledged as copyright owner and source of the material. Shenzhen Huatongwei International Inspection Co., Ltd takes no responsibility for and will not assume liability for damages resulting from the reader's interpretation of the reproduced material due to its placement and context.

## Contents

<b>1.</b>	<b><u>TEST STANDARDS AND TEST DESCRIPTION</u></b>	<b>3</b>
1.1.	Test Standards	3
1.2.	Test Description	3
<b>2.</b>	<b><u>SUMMARY</u></b>	<b>4</b>
2.1.	Client Information	4
2.2.	Product Description	4
2.3.	EUT operation mode	4
2.4.	EUT configuration	4
2.5.	Modifications	4
<b>3.</b>	<b><u>TEST ENVIRONMENT</u></b>	<b>5</b>
3.1.	Address of the test laboratory	5
3.2.	Test Facility	5
3.3.	Environmental conditions	6
3.4.	Statement of the measurement uncertainty	6
3.5.	Equipments Used during the Test	7
<b>4.</b>	<b><u>TEST CONDITIONS AND RESULTS</u></b>	<b>8</b>
4.1.	Antenna requirement	8
4.2.	AC Power Conducted Emission(Not Applicable)	9
4.3.	Radiated Emission	9
4.4.	Occpied Bandwidth	15
4.5.	Deactivation Time	16
<b>5.</b>	<b><u>TEST SETUP PHOTOS OF THE EUT</u></b>	<b>17</b>
<b>6.</b>	<b><u>EXTERNAL AND INTERNAL PHOTOS OF THE EUT</u></b>	<b>18</b>

# 1. TEST STANDARDS AND TEST DESCRIPTION

## 1.1. Test Standards

The tests were performed according to following standards:

[FCC Rules Part 15.231](#): Periodic operation in the band 40.66–40.70 MHz and above 70 MHz.

[ANSI C63.10-2009](#): American National Standard for Testing Unlicensed Wireless Devices.

## 1.2. Test Description

Test Item	Section in CFR 47	Result
Conducted Emissions	15.207	N/A
Unintentional Radiated Emissions	15.109	PASS
Radiated & Spurious Emissions	15.205/15.209(a)/15.231(b)/15.35(c)	PASS
Deactivation Time	15.231(a)(1)	PASS
Duty Cycle	15.231	PASS
Occupied Bandwidth	15.231(c)	PASS

Remark: The measurement uncertainty is not included in the test result.

## 2. SUMMARY

### 2.1. Client Information

Applicant:	Dalian Seaside Door Controlling System Co. Ltd.
Address:	No.23-7,Yaobei Road,Ganjingzi District,Dalian,Liaoning,China.
Manufacturer:	Dalian Seaside Door Controlling System Co. Ltd.
Address:	No.23-7,Yaobei Road,Ganjingzi District,Dalian,Liaoning,China.

### 2.2. Product Description

Name of EUT	Remote Control
Trade Mark:	/
Model No.:	T041-315-FR01
Listed Model(s):	/
Power supply:	DC12.0V from battery
Adapter information:	/
Operation frequency:	315.0MHz
Channel number:	1
Antenna type:	Intergral Antenna
Antenna gain:	0dBi

### 2.3. EUT operation mode

The EUT has been tested under typical operating condition. The Applicant provides software to control the EUT for staying in continous transmitting mode for testing.

### 2.4. EUT configuration

**The following peripheral devices and interface cables were connected during the measurement:**

- - supplied by the manufacturer
- - supplied by the lab

<input type="radio"/>	Power Cable	Length (m) :	/
		Shield :	/
		Detachable :	/
<input type="radio"/>	Multimeter	Manufacturer :	/
		Model No. :	/

### 2.5. Modifications

No modifications were implemented to meet testing criteria.

### **3. TEST ENVIRONMENT**

#### **3.1. Address of the test laboratory**

Shenzhen Huatongwei International Inspection Co., Ltd.  
Keji Nan No.12 Road, Hi-tech Park, Shenzhen, China  
Phone: 86-755-26748019 Fax: 86-755-26748089

#### **3.2. Test Facility**

The test facility is recognized, certified, or accredited by the following organizations:

##### **CNAS-Lab Code: L1225**

Shenzhen Huatongwei International Inspection Co., Ltd. has been assessed and proved to be in compliance with CNAS-CL01 Accreditation Criteria for Testing and Calibration Laboratories (identical to ISO/IEC 17025: 2005 General Requirements) for the Competence of Testing and Calibration Laboratories, Date of Registration: February 28, 2015. Valid time is until February 27, 2018.

##### **A2LA-Lab Cert. No. 2243.01**

Shenzhen Huatongwei International Inspection Co., Ltd. EMC Laboratory has been accredited by A2LA for technical competence in the field of electrical testing, and proved to be in compliance with ISO/IEC 17025: 2005 General Requirements for the Competence of Testing and Calibration Laboratories and any additional program requirements in the identified field of testing. Valid time is until Sept 30, 2015.

##### **FCC-Registration No.: 662850**

Shenzhen Huatongwei International Inspection Co., Ltd. EMC Laboratory has been registered and fully described in a report filed with the FCC (Federal Communications Commission). The acceptance letter from the FCC is maintained in our files. Registration 662850, Renewal date Jul. 01, 2012, valid time is until Jun. 01, 2015.

##### **IC-Registration No.: 5377A**

The 3m Alternate Test Site of Shenzhen Huatongwei International Inspection Co., Ltd. has been registered by Certification and Engineering Bureau of Industry Canada for the performance of radiated measurements with Registration No. 5377A on Dec. 31, 2013, valid time is until Dec. 31, 2016.

##### **ACA**

Shenzhen Huatongwei International Inspection Co., Ltd. EMC Laboratory can also perform testing for the Australian C-Tick mark as a result of our A2LA accreditation.

##### **VCCI**

The 3m Semi-anechoic chamber (12.2m×7.95m×6.7m) of Shenzhen Huatongwei International Inspection Co., Ltd. has been registered in accordance with the Regulations for Voluntary Control Measures with Registration No.:R-2484. Date of Registration: Dec. 20, 2012. Valid time is until Dec. 29, 2015.

Radiated disturbance above 1GHz measurement of Shenzhen Huatongwei International Inspection Co., Ltd. has been registered in accordance with the Regulations for Voluntary Control Measures with Registration No.: G-292. Date of Registration: Dec. 24, 2013. Valid time is until Dec. 23, 2016.

Main Ports Conducted Interference Measurement of Shenzhen Huatongwei International Inspection Co., Ltd. has been registered in accordance with the Regulations for Voluntary Control Measures with Registration No.: C-2726. Date of Registration: Dec. 20, 2012. Valid time is until Dec. 19, 2015.

Telecommunication Ports Conducted Interference Measurement of Shenzhen Huatongwei International Inspection Co., Ltd. has been registered in accordance with the Regulations for Voluntary Control Measures with Registration No.: T-1837. Date of Registration: May 07, 2013. Valid time is until May 06, 2016.

##### **DNV**

Shenzhen Huatongwei International Inspection Co., Ltd. has been found to comply with the requirements of DNV towards subcontractor of EMC and safety testing services in conjunction with the EMC and Low voltage Directives and in the voluntary field. The acceptance is based on a formal quality Audit and follow-ups according to relevant parts of ISO/IEC Guide 17025 (2005), in accordance with the requirements of the DNV Laboratory Quality Manual towards subcontractors. Valid time is until Aug. 24, 2016.

### 3.3. Environmental conditions

During the measurement the environmental conditions were within the listed ranges:

Temperature:	15~35°C
Relative Humidity:	30~60 %
Air Pressure:	950~1050mba

### 3.4. Statement of the measurement uncertainty

The data and results referenced in this document are true and accurate. The reader is cautioned that there may be errors within the calibration limits of the equipment and facilities. The measurement uncertainty was calculated for all measurements listed in this test report according to TR-100028-01 "Electromagnetic compatibility and Radio spectrum Matters (ERM); Uncertainties in the measurement of mobile radio equipment characteristics; Part 1" and TR-100028-02 "Electromagnetic compatibility and Radio spectrum Matters (ERM); Uncertainties in the measurement of mobile radio equipment characteristics; Part 2" and is documented in the Shenzhen Huatongwei International Inspection Co., Ltd quality system according to DIN EN ISO/IEC 17025. Furthermore, component and process variability of devices similar to that tested may result in additional deviation. The manufacturer has the sole responsibility of continued compliance of the device.

Hereafter the best measurement capability for Shenzhen Huatongwei laboratory is reported:

Test Items	Measurement Uncertainty	Notes
Transmitter power conducted	0.57 dB	(1)
Transmitter power Radiated	2.20 dB	(1)
Conducted spurious emission 9KHz-40 GHz	1.60 dB	(1)
Radiated spurious emission 9KHz-40 GHz	2.20 dB	(1)
Conducted Emission 9KHz-30MHz	3.39 dB	(1)
Radiated Emission 30~1000MHz	4.24 dB	(1)
Radiated Emission 1~18GHz	5.16 dB	(1)
Radiated Emission 18-40GHz	5.54 dB	(1)
Occupied Bandwidth	-----	(1)

(1) This uncertainty represents an expanded uncertainty expressed at approximately the 95% confidence level using a coverage factor of  $k=1.96$ .

**3.5. Equipments Used during the Test**

Maximum transmit power & Frequency range & Frequency hopping requirements					
Item	Test Equipment	Manufacturer	Model No.	Serial No.	Last Cal.
1	Spectrum Analyzer	AGILENT	E4407B	MY44210775	2014/11/01
2	Climate Chamber	ESPEC	EL-10KA	05107008	2014/11/01
3	Spectrum Analyzer	Rohde&Schwarz	FSP40	1164.4391.40	2014/11/01

Transmitter spurious emissions & Receiver spurious emissions					
Item	Test Equipment	Manufacturer	Model No.	Serial No.	Last Cal.
1	EMI TEST RECEIVER	Rohde&Schwarz	ESI 26	100009	2014/11/01
2	RF TEST PANEL	Rohde&Schwarz	TS / RSP	335015/ 0017	N/A
3	EMI TEST SOFTWARE	Rohde&Schwarz	ESK1	N/A	N/A
4	High pass filter	Compliance Direction systems	BSU-6	34202	2014/11/01
5	Ultra-Broadband Antenna	ShwarzBeck	VULB9163	538	2014/11/01
6	Ultra-Broadband Antenna	ShwarzBeck	VULB9163	539	2014/11/01
7	HORN ANTENNA	ShwarzBeck	9120D	1011	2014/11/01
8	HORN ANTENNA	ShwarzBeck	9120D	1012	2014/11/01
9	TURNTABLE	MATURO	TT2.0	----	N/A
10	ANTENNA MAST	MATURO	TAM-4.0-P	----	N/A
11	EMI TEST SOFTWARE	Audix	E3	N/A	N/A

The Cal.Interval was one year

## 4. TEST CONDITIONS AND RESULTS

### 4.1. Antenna requirement

#### Requirement

##### **FCC CFR Title 47 Part 15 Subpart C Section 15.203:**

An intentional radiator shall be designed to ensure that no antenna other than that furnished by the responsible party shall be used with the device. The use of a permanently attached antenna or of an antenna that uses a unique coupling to the intentional radiator, the manufacturer may design the unit so that a broken antenna can be replaced by the user, but the use of a standard antenna jack or electrical connector is prohibited.

#### **Refer to statement below for compliance.**

The manufacturer may design the unit so that the user can replace a broken antenna, but the use of a standard antenna jack or electrical connector is prohibited. Further, this requirement does not apply to intentional radiators that must be professionally installed.

#### Test Result:

The antenna is integral antenna, the best case gain of the antenna is 0dBi

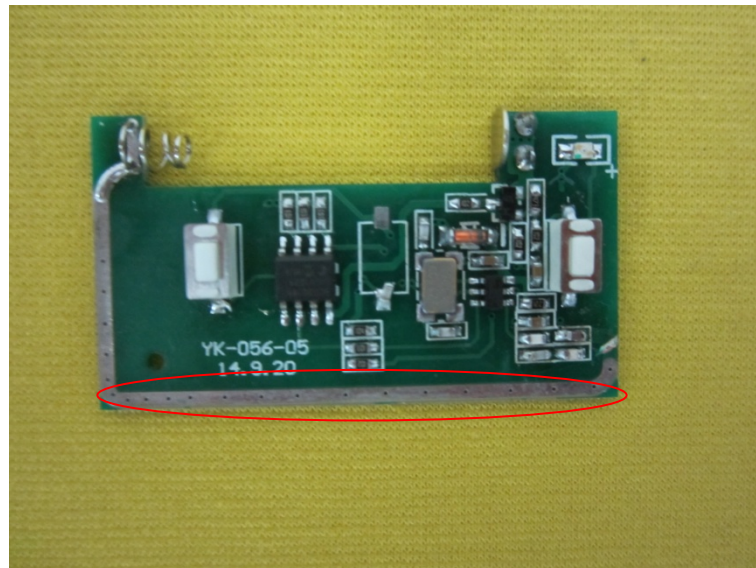



## 4.2. AC Power Conducted Emission(Not Applicable)

### TEST CONFIGURATION

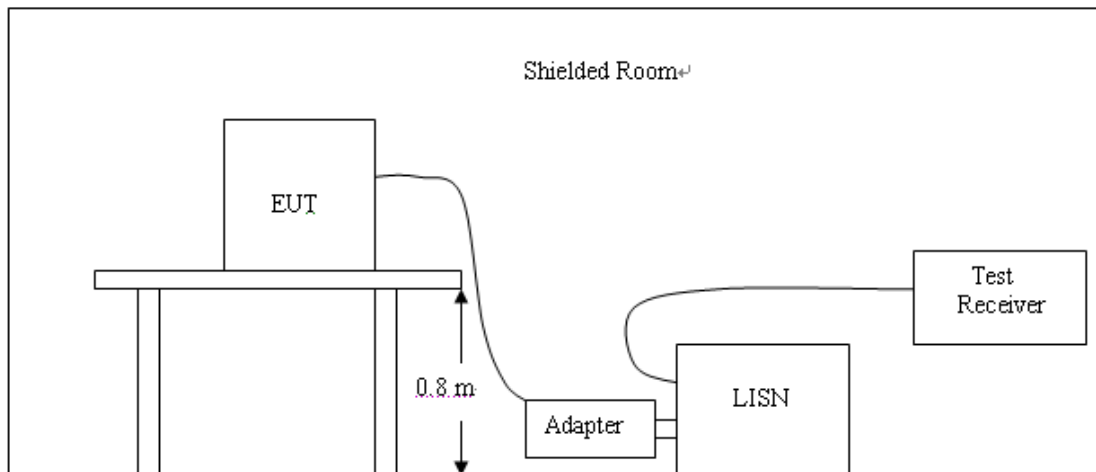

### TEST PROCEDURE

- 1 The equipment was set up as per the test configuration to simulate typical actual usage per the user's manual. The EUT is a tabletop system, a wooden table with a height of 0.8 meters is used and is placed on the ground plane as per ANSI C63.10-2009.
- 2 Support equipment, if needed, was placed as per ANSI C63.10-2009
- 3 All I/O cables were positioned to simulate typical actual usage as per ANSI C63.10-2009
- 4 The EUT received DC5V power from the adapter, the adapter received AC120V/60Hz power through a Line Impedance Stabilization Network (LISN) which supplied power source and was grounded to the ground plane.
- 5 All support equipments received AC power from a second LISN, if any.
- 6 The EUT test program was started. Emissions were measured on each current carrying line of the EUT using a spectrum Analyzer / Receiver connected to the LISN powering the EUT. The LISN has two monitoring points: Line 1 (Hot Side) and Line 2 (Neutral Side). Two scans were taken: one with Line 1 connected to Analyzer / Receiver and Line 2 connected to a 50 ohm load; the second scan had Line 1 connected to a 50 ohm load and Line 2 connected to the Analyzer / Receiver.
- 7 Analyzer / Receiver scanned from 150 KHz to 30MHz for emissions in each of the test modes.
- 8 During the above scans, the emissions were maximized by cable manipulation.

### AC Power Conducted Emission Limit

For intentional device, according to § 15.207(a) AC Power Conducted Emission Limits is as following :

Frequency (MHz)	Maximum RF Line Voltage (dBµV)	
	Q.P.	Ave.
0.15 - 0.50	66-56*	56-46*
0.50 - 5.00	56	46
5.00 - 30.0	60	50

\* Decreasing linearly with the logarithm of the frequency

### TEST RESULTS

Not applicable to this device.

## 4.3. Radiated Emission

**TEST CONFIGURATION**

Radiated Emission Test Set-Up

Frequency range 9KHz – 30MHz

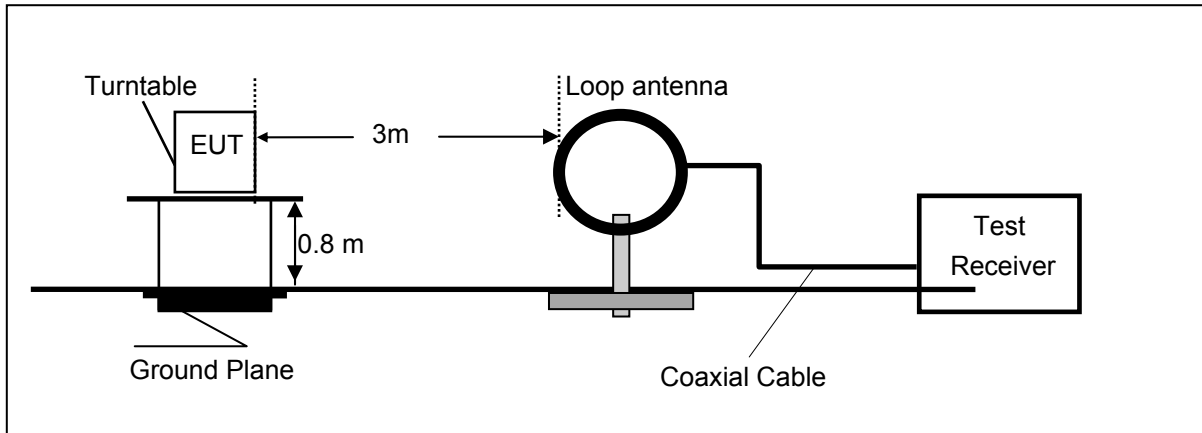

Frequency range 30MHz – 1000MHz

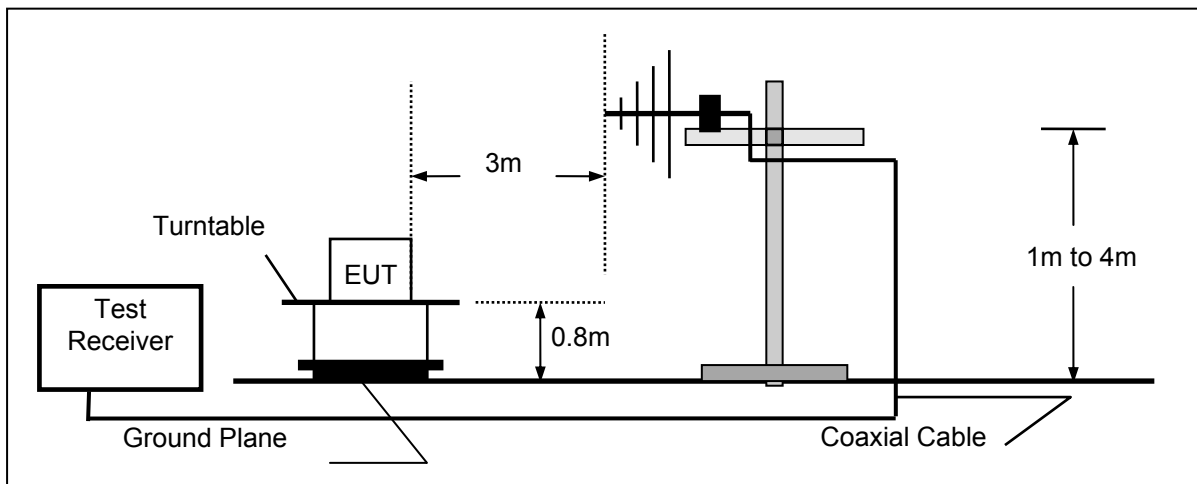

Frequency range above 1GHz-25GHz

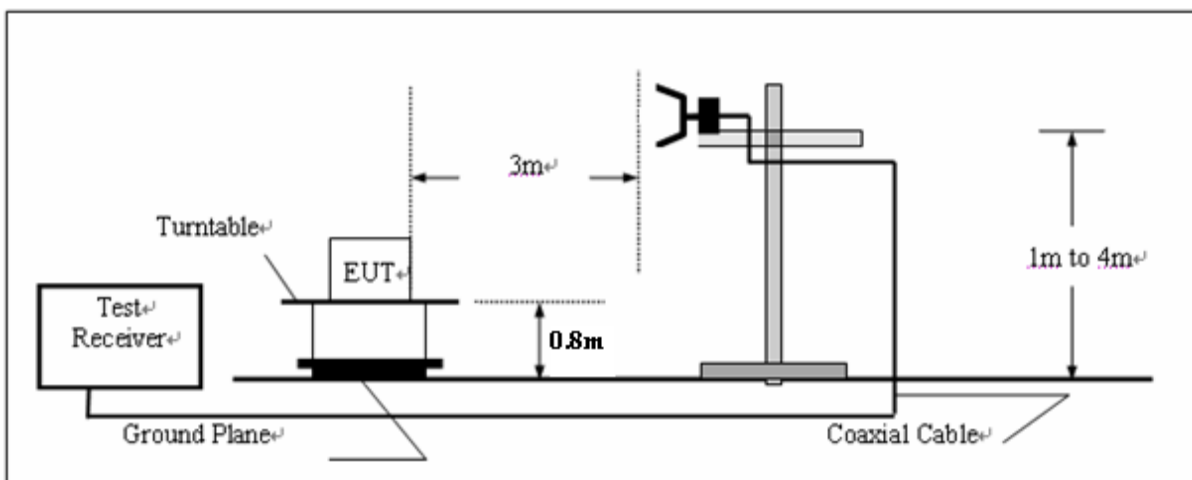

**TEST PROCEDURE**

- 1 The EUT was placed on a turn table which is 0.8m above ground plane.
- 2 Maximum procedure was performed by raising the receiving antenna from 1m to 4m and rotating the turn table from 0°C to 360°C to acquire the highest emissions from EUT
3. And also, each emission was to be maximized by changing the polarization of receiving antenna both horizontal and vertical.
4. Repeat above procedures until all frequency measurements have been completed.
5. the fundamental frequency is 315.0MHz, So the radiation emissions frequency range were tested from 30MHz to 4GHz.

**RADIATION LIMIT**

For intentional device, according to § 15.209(a), the general requirement of field strength of radiated emission from intentional radiators at a distance of 3 meters shall not exceed the following table:

Frequency (MHz)	Distance (Meters)	Radiated (dBµV/m)	Radiated (µV/m)
0.009 - 0.490	300	20*log(2400/F(kHz))	2400/F(kHz)
0.490 - 1.705	30	20*log(24000/F(kHz))	24000/F(kHz)
1.705 - 30.0	30	29.54	30
30-88	3	40.0	100
88-216	3	43.5	150
216-960	3	46.0	200
Above 960	3	54.0	500

In addition to the provisions of §15.205, the field strength of emissions from intentional radiators operated under this section shall not exceed the following:

Funda- mental fre- quency (MHz)	Field strength of funda- mental (microvolts/ meter)	Field strength of spurious emissions (microvolts/meter)
40.66– 40.70.	2,250 .....	225
70–130 .....	1,250 .....	125
130–174 ....	<sup>1</sup> 1,250 to 3,750 .....	<sup>1</sup> 125 to 375
174–260 ....	3,750 .....	375
260–470 ....	<sup>1</sup> 3,750 to 12,500 .....	<sup>1</sup> 375 to 1,250
Above 470	12,500 .....	1,250

<sup>1</sup> Linear interpolations.

**TEST RESULTS**

The emissions from 9kHz to 4GHz are measured peak and average level, below 1GHz measured QP level,detailed test data please see below.Besides,we tested 3 direction and recorded the worst data from 30MHz to 4GHz.

The frequency spectrum above 1 GHz for Transmitter was investigated. All emission not reported are much lower than the prescribed limits. Set the RBW=1MHz,VBW=3MHz for Peak Detector while the RBW=1MHz,VBW=10Hz for Average Detector,Readings are both peak and average values. The pre-test have done for the EUT in three axes and found the worst emission at position shown in test setup photos.

***Radiated emission of fundamental emission***

Frequency (MHz)	Corrected Reading (dB $\mu$ V/m)@3m	FCC Limit (dB $\mu$ V/m) @3m	Margin (dB)	Detector	Polarization
315.0	72.80	95.62	22.82	PK	Horizontal
315.0	65.27	75.62	10.35	AV	Horizontal
315.0	63.60	95.62	32.02	PK	Vertical
315.0	56.07	75.62	19.55	AV	Vertical

***Spurious radiated emission***

Frequency (MHz)	Corrected Reading (dB $\mu$ V/m)@3m	FCC Limit (dB $\mu$ V/m) @3m	Margin (dB)	Detector	Polarization
209.45	16.70	40.00	23.30	QP	Horizontal
630.43	36.20	55.62	19.42	QP	Horizontal
945.68	39.70	55.62	15.92	QP	Horizontal
1889.05	55.50	75.62	20.12	PK	Horizontal
1889.05	47.97	55.62	7.65	AV	Horizontal
2520.73	58.45	75.62	17.17	PK	Horizontal
2520.73	50.92	55.62	4.70	AV	Horizontal
182.29	21.20	40.00	18.80	QP	Vertical
630.43	49.30	55.62	6.32	QP	Vertical
945.68	39.60	55.62	16.02	QP	Vertical
1889.05	55.50	75.62	20.12	PK	Vertical
1889.05	47.97	55.62	7.65	AV	Vertical
2520.73	59.16	75.62	16.46	PK	Vertical
2520.73	51.63	55.62	3.99	AV	Vertical

**Note 1:**

1. Below 30MHz, found the radiated emission level is very low, so don't show on the report.
2. According to section 15.35(b), when average radiated emission measurements are specified, including emission measurement below 1000MHz, there also is limit on the radio frequency emissions, as measured using instrumentation with a peak detector function, corresponding to 20dB above the maximum permitted average limit for the frequency being investigated.

**Note 2:** Average Result =Peak Field Strength+Duty Cycle Correction Factor.

**Note 3:** Duty Cycle Correction Factor value refers to below.

Duty Cycle Correction Factor

Duty Cycle = TX on/(TX on +TX off) x100% = [(1.60-1.22) ms X (12+38)+(3.13-2.36) ms X 31]/102.0ms X 100% =42.03%

TX on= TX on(narrower pulses)+ TX on(winder pulses)=Time of one narrower pulse X Number of narrower pulses + Time of one winder pulse X Number of winder pulses = (Marker 2-Marker1)X Number of narrower pulses+ (Marker 4-Marker1)X Number of winder pulses

Duty Cycle Correction Factor = 20log (Duty Cycle) = -7.53

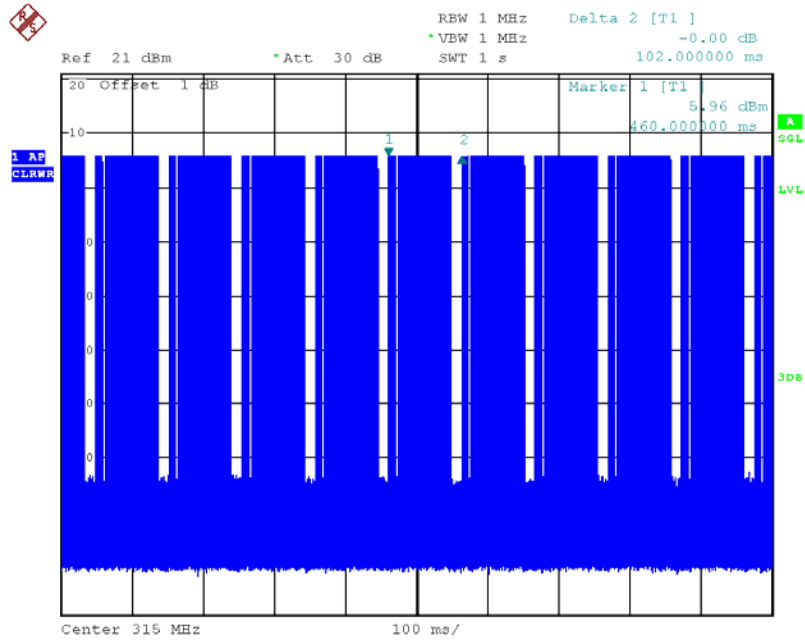

Date: 27.JAN.2015 14:40:22

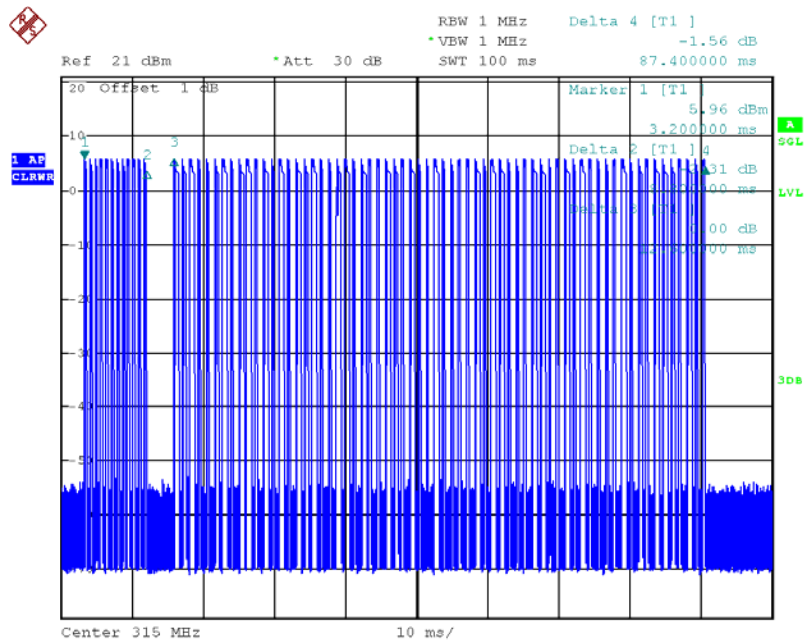

Date: 27.JAN.2015 14:45:17

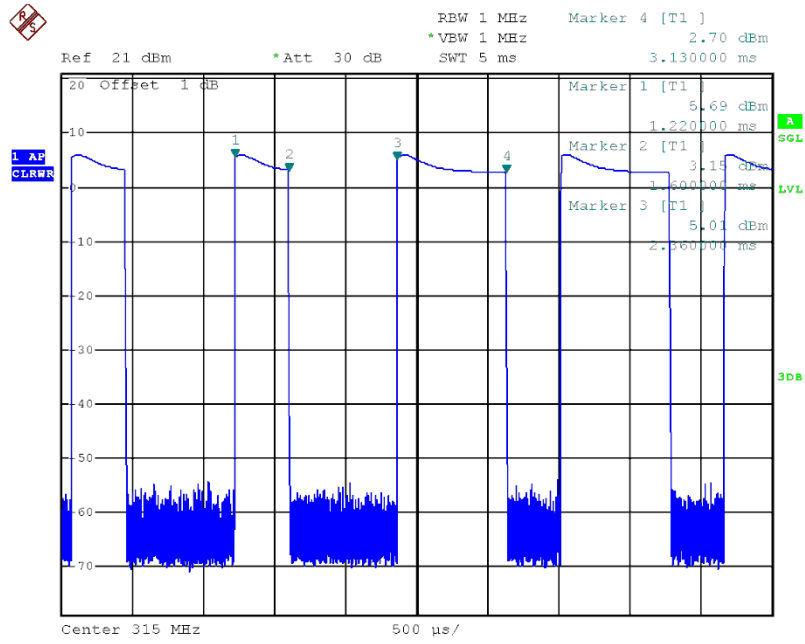

Date: 27.JAN.2015 14:49:01

### 4.4. Occpied Bandwidth

#### TEST CONFIGURATION

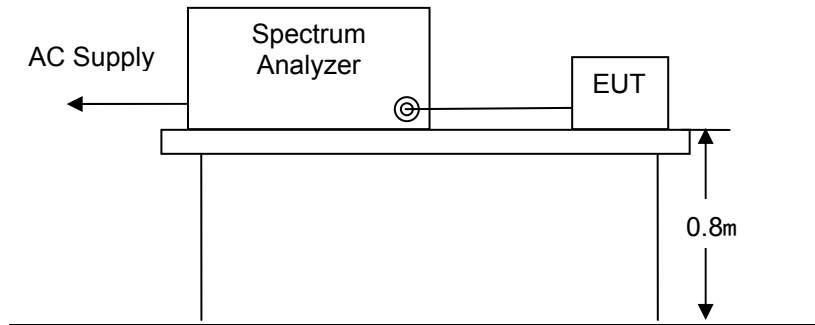

#### TEST PROCEDURE

- 1.As required by 47 CFR 15.231(c):The bandwidth of the emission shall be no wider than 0.25% of the center frequency for devices operating above 70MHz and below 900MHz.Bandwidth is determined at the points 20dB down from the modulated carrier.
- 2.Customer provided a test mode internal to the EUT to control the RF modulation.The EUT antenna was attached and the waveform was receiver by the test antenna which was connected to the spectrum analyzer was operated in linear scale and zero span mode after tuning to the transmitter carrier frequency.

#### Limit

The bandwidth of the emission shall be no wider than 0.25% of the center frequency for devices operating above 70MHz and below 900MHz

#### TEST RESULTS

Channel Frequency (MHz)	20dB Bandwidth (MHz)	Limit (MHz)	Result
315.0	0.0131	0.25%*315=0.7875	PASS

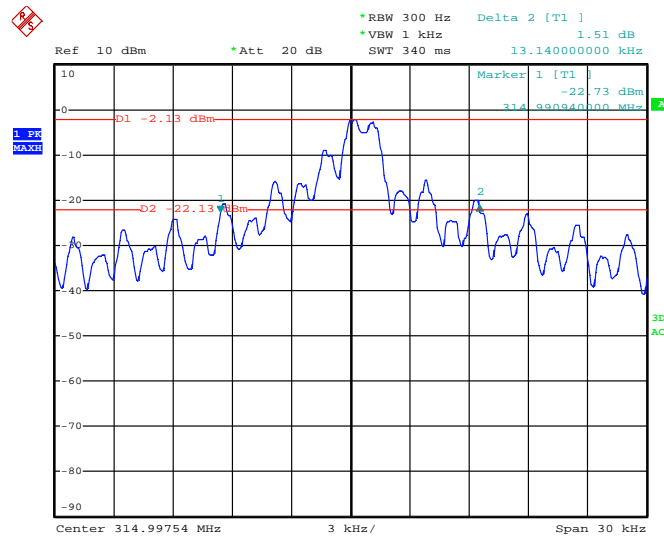

Date: 12.MAR.2015 15:51:15

### 4.5. Deactivation Time

#### TEST CONFIGURATION

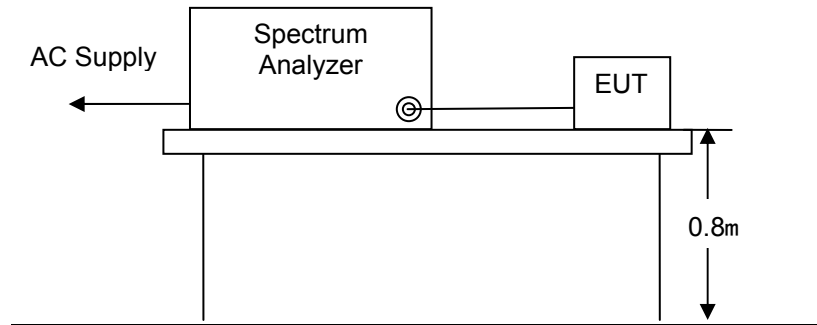

#### TEST PROCEDURE

- 1 The EUT was placed on a wooded table which is 0.8m height and close to receiver antenna of spectrum analyzer.
- 2 The spectrum analyzer resolution bandwidth was set to 1 MHz and video bandwidth was set to 1 MHz to encompass all significant spectral components during the test. The spectrum analyzer was operated in linear scale and zero span mode after tuning to the transmitter carrier frequency.

#### LIMIT

A manually operated transmitter shall employ a switch that will auto-matically deactivate the transmitter within not more than 5 seconds of being released.

#### TEST RESULTS

Note: The transmitter was manually activated, and the carrier frequency 315.0MHz:

Frequency (MHz)	One transmission time (s)	Limit (s)	Result
315.0MHz	4.52	5	Pass

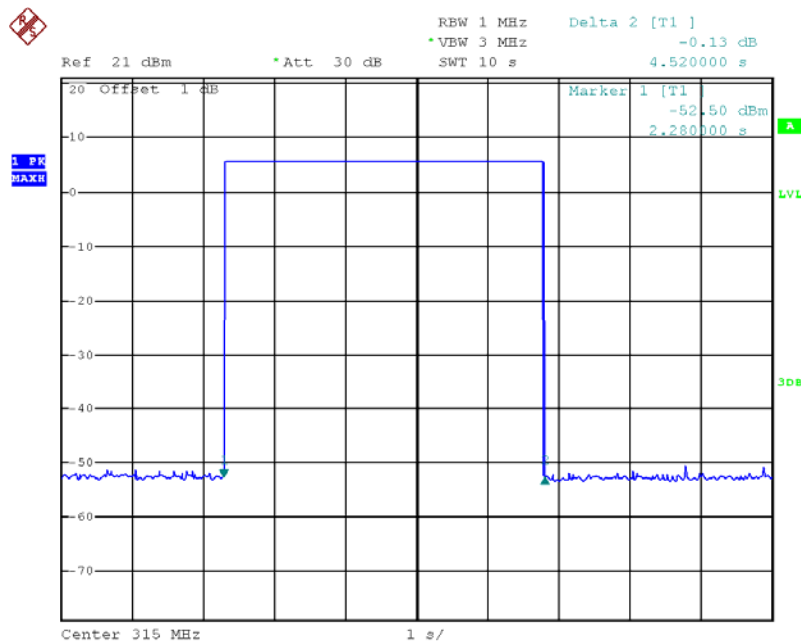



## 5. Test Setup Photos of the EUT

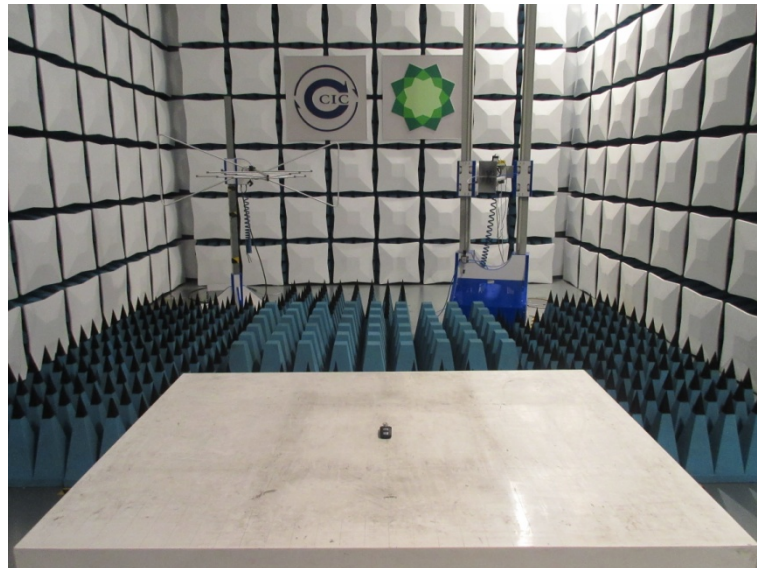
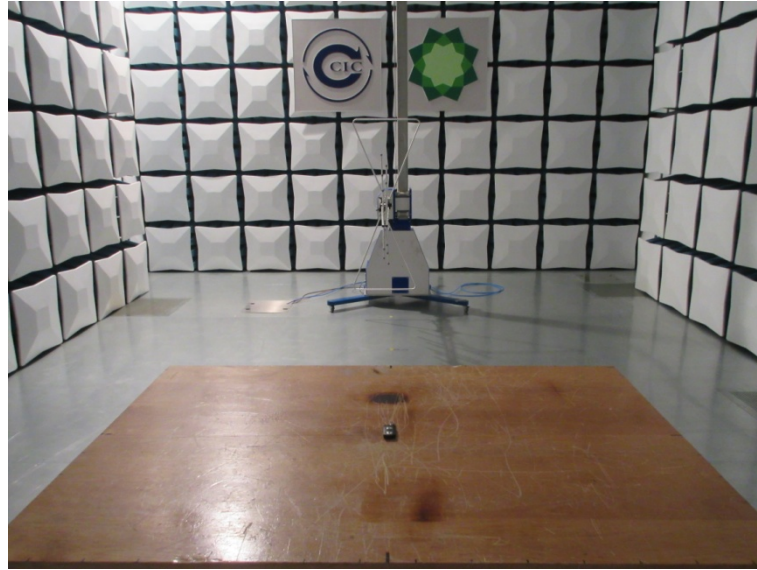

## 6. External and Internal Photos of the EUT

### External Photos

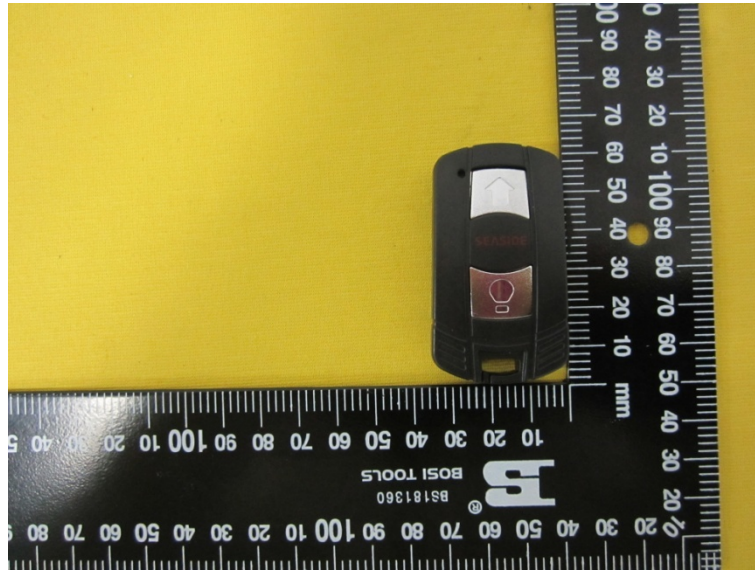



Internal Photos

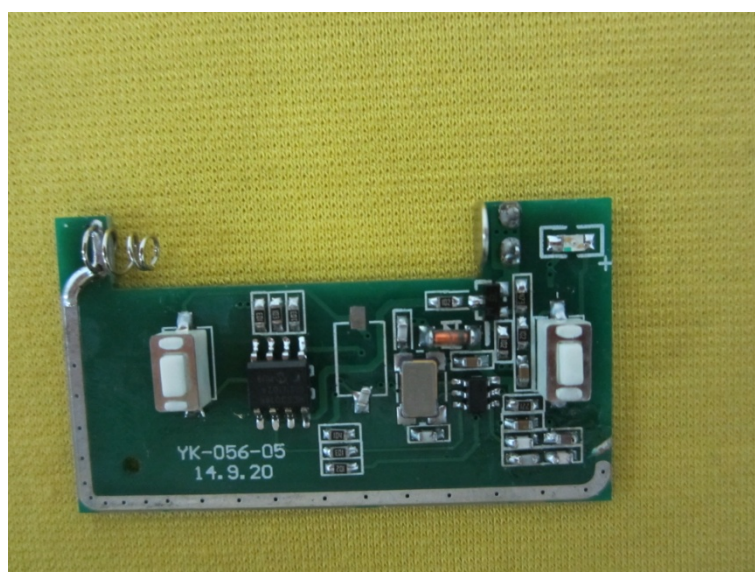
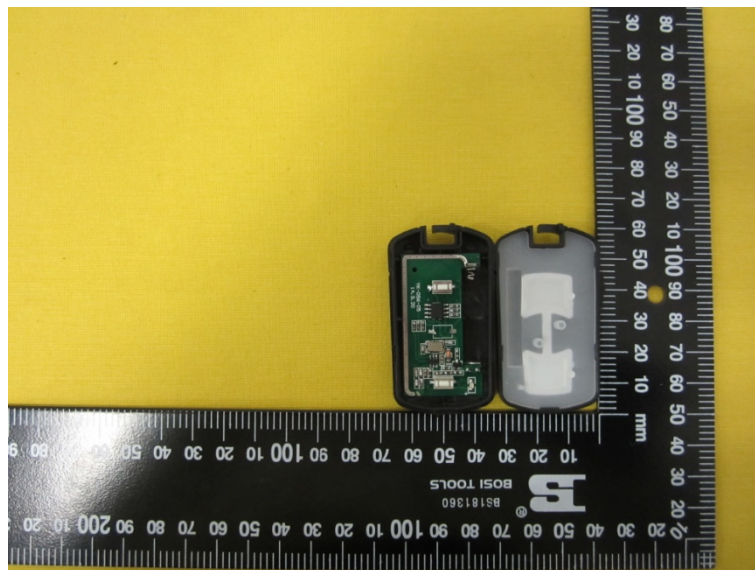

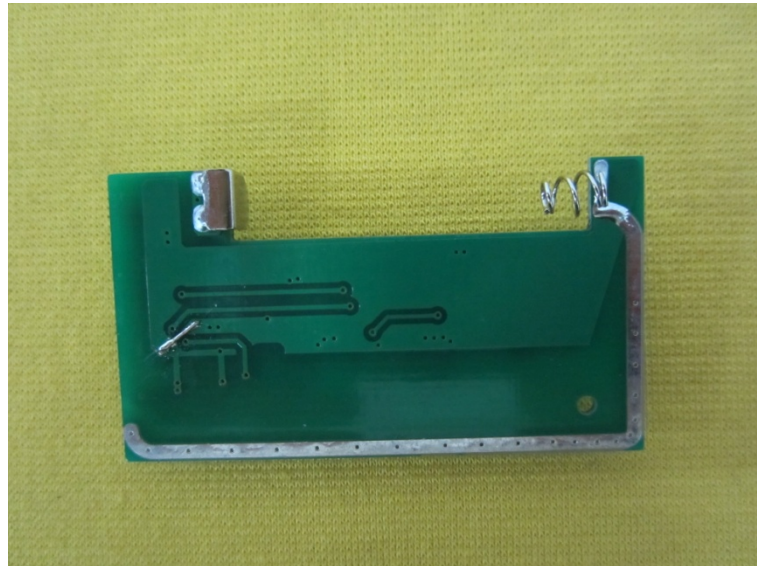

.....End of Report.....