



Test Report No.: RF2404WDG0026



TEST REPORT



Applicant	JCW Investments Inc. DBA Tekky Toys
Address	11415 W. 183rd Place, Suite E, Orland Park, Illinois 60467, USA

Manufacturer or Supplier	Xinming Handcraft Production Manufactory
Address	No 3 XiHeng 3 Lane ZhenHua Road QiShi Town DongGuan China
Product	Bluetooth Nutcracker
Brand Name	6.5-ft Animated Bluetooth Nutcracker
Model	5968040
Additional Model & Model Difference	5968039, 93116, 93118; see items 3.1
Date of tests	Apr. 07, 2024 ~ Apr. 30, 2024

the tests have been carried out according to the requirements of the following standards:

FCC Part 15, Subpart C, Section 15.247

CONCLUSION: The submitted sample was found to COMPLY with the test requirement

Tested by Eric Fang Project Engineer / EMC Department	Approved by Glyn He Assistant Manager / EMC Department
	 Date: May 10, 2024

This report is governed by, and incorporates by reference, the Conditions of Testing as posted at the date of issuance of this report at <http://www.bureauveritas.com/home/about-us/our-business/cps/about-us/terms-conditions/> and is intended for your exclusive use. Any copying or replication of this report to or for any other person or entity, or use of our name or trademark, is permitted only with our prior written permission. This report sets forth our findings solely with respect to the test samples identified herein. The results set forth in this report are not indicative or representative of the quality or characteristics of the lot from which a test sample was taken or any similar or identical product unless specifically and expressly noted. Our report includes all of the tests requested by you and the results thereof based upon the information that you provided to us. Measurement uncertainty is only provided upon request for accredited tests. Statements of conformity are based on simple acceptance criteria without taking measurement uncertainty into account, unless otherwise requested in writing. You have 60 days from date of issuance of this report to notify us of any material error or omission caused by our negligence or if you require measurement uncertainty; provided, however, that such notice shall be in writing and shall specifically address the issue you wish to raise. A failure to raise such issue within the prescribed time shall constitute your unqualified acceptance of the completeness of this report, the tests conducted and the correctness of the report contents.



TABLE OF CONTENTS

RELEASE CONTROL RECORD	5
1 SUMMARY OF TEST RESULTS.....	6
2 MEASUREMENT UNCERTAINTY	6
3 GENERAL INFORMATION	7
3.1 GENERAL DESCRIPTION OF EUT	7
3.2 DESCRIPTION OF TEST MODES	9
3.2.1 CONFIGURATION OF SYSTEM UNDER TEST	10
3.2.2 TEST MODE APPLICABILITY AND TESTED CHANNEL DETAIL.....	10
3.3 GENERAL DESCRIPTION OF APPLIED STANDARDS	12
3.4 DESCRIPTION OF SUPPORT UNITS.....	12
3.5 CONFIGURATION OF SYSTEM UNDER TEST	12
3.6 DUTY CYCLE OF TEST SIGNAL.....	13
4 TEST TYPES AND RESULTS.....	14
4.1. CONDUCTED EMISSION MEASUREMENT.....	14
4.1.1 LIMITS OF CONDUCTED EMISSION MEASUREMENT.....	14
4.1.2 TEST INSTRUMENTS	14
4.1.3 TEST PROCEDURES.....	15
4.1.4 DEVIATION FROM TEST STANDARD.....	15
4.1.5 TEST SETUP	16
4.1.6 EUT OPERATING CONDITIONS	16
4.1.7 TEST RESULTS.....	17
4.2. RADIATED EMISSION AND BANDEDGE MEASUREMENT	19
4.2.1 LIMITS OF RADIATED EMISSION AND BANDEDGE MEASUREMENT	19
4.2.2 TEST INSTRUMENTS	20
4.2.3 TEST PROCEDURES.....	21
4.2.4 DEVIATION FROM TEST STANDARD.....	22
4.2.5 TEST SETUP	22
4.2.6 EUT OPERATING CONDITIONS	23
4.2.7 TEST RESULTS.....	24
4.3 NUMBER OF HOPPING FREQUENCY USED	32
4.3.1 LIMIT OF HOPPING FREQUENCY USED	32
4.3.2 TEST SETUP	32
4.3.3 TEST INSTRUMENTS	32
4.3.4 TEST PROCEDURES.....	33



Test Report No.: RF2404WDG0026

4.3.5	DEVIATION FROM TEST STANDARD.....	33
4.3.6	TEST RESULTS.....	33
4.4	DWELL TIME ON EACH CHANNEL.....	36
4.4.1	LIMIT OF DWELL TIME USED.....	36
4.4.2	TEST SETUP.....	36
4.4.3	TEST INSTRUMENTS.....	36
4.4.4	TEST PROCEDURES.....	36
4.4.5	DEVIATION FROM TEST STANDARD.....	37
4.4.6	TEST RESULTS.....	37
4.5	CHANNEL BANDWIDTH.....	40
4.5.1	LIMITS OF CHANNEL BANDWIDTH.....	40
4.5.2	TEST SETUP.....	40
4.5.3	TEST INSTRUMENTS.....	40
4.5.4	TEST PROCEDURE.....	40
4.5.5	DEVIATION FROM TEST STANDARD.....	40
4.5.6	EUT OPERATING CONDITION.....	40
4.5.7	TEST RESULTS.....	41
4.6	HOPPING CHANNEL SEPARATION.....	45
4.6.1	LIMIT OF HOPPING CHANNEL SEPARATION.....	45
4.6.2	TEST SETUP.....	45
4.6.3	TEST INSTRUMENTS.....	45
4.6.4	TEST PROCEDURES.....	45
4.6.5	DEVIATION FROM TEST STANDARD.....	45
4.6.6	TEST RESULTS.....	46
4.7	CONDUCTED OUTPUT POWER.....	50
4.7.1	LIMITS OF CONDUCTED OUTPUT POWER MEASUREMENT.....	50
4.7.2	TEST SETUP.....	50
4.7.3	TEST INSTRUMENTS.....	50
4.7.4	TEST PROCEDURES.....	50
4.7.5	DEVIATION FROM TEST STANDARD.....	50
4.7.6	EUT OPERATING CONDITION.....	51
4.7.7	TEST RESULTS.....	51
4.8	OUT OF BAND EMISSION MEASUREMENT.....	53
4.8.1	LIMITS OF OUT OF BAND EMISSION MEASUREMENT.....	53
4.8.2	TEST INSTRUMENTS.....	53
4.8.3	TEST PROCEDURE.....	53
4.8.4	DEVIATION FROM TEST STANDARD.....	53



**BUREAU
VERITAS**

Test Report No.: RF2404WDG0026

4.8.5 EUT OPERATING CONDITION.....	53
4.8.6 TEST RESULTS.....	53
5 PHOTOGRAPHS OF THE TEST CONFIGURATION.....	58
6 APPENDIX A - MODIFICATIONS RECORDERS FOR ENGINEERING CHANGES TO THE EUT BY THE LAB.....	59



Test Report No.: RF2404WDG0026

RELEASE CONTROL RECORD

ISSUE NO.	REASON FOR CHANGE	DATE ISSUED
RF2404WDG0026	Original release	May 10, 2024

1 SUMMARY OF TEST RESULTS

The EUT has been tested according to the following specifications:

APPLIED STANDARD: FCC Part 15, Subpart C			
STANDARD SECTION	TEST TYPE AND LIMIT	RESULT	REMARK
15.207	AC Power Conducted Emission	PASS	Meet the requirement of limit.
15.247(a)(1)(iii)	Number of Hopping Frequency Used	PASS	Meet the requirement of limit.
15.247(a)(1)(iii)	Dwell Time on Each Channel	PASS	Meet the requirement of limit.
15.247(a)(1)	1. Hopping Channel Separation 2. Spectrum Bandwidth of a Frequency Hopping Sequence Spread Spectrum System	PASS	Meet the requirement of limit.
15.247(b)	Conducted Output Power	PASS	Meet the requirement of limit.
15.247(d)&15.209	Transmitter Radiated Emission	PASS	Meet the requirement of limit.
15.247(d)	Out of band Emission Measurement	PASS	Meet the requirement of limit.
15.203	Antenna Requirement	PASS	No antenna connector is used.

2 MEASUREMENT UNCERTAINTY

Where relevant, the following measurement uncertainty levels have been estimated for tests performed on the EUT as specified in CISPR 16-4-2:

MEASUREMENT	FREQUENCY	UNCERTAINTY
Radiated emissions	9KHz ~ 30MHz	2.80dB
	30MHz ~ 1GMHz	4.65dB
	1GHz ~ 18GHz	5.01dB
	18GHz ~ 40GHz	4.10dB
Conducted emissions	9KHz ~ 30MHz	3.36dB

This uncertainty represents an expanded uncertainty expressed at approximately the 95% confidence level using a coverage factor of k=2.

3 GENERAL INFORMATION

3.1 GENERAL DESCRIPTION OF EUT

PRODUCT	Bluetooth Nutcracker
MODEL NO.	5968040
ADDITIONAL MODEL	5968039, 93116, 93118
FCC ID	2AAAI-TEKKY-BT
POWER SUPPLY	DC 9V from Adapter
MODULATION TECHNOLOGY	FHSS
MODULATION TYPE	GFSK, $\pi/4$ DQPSK, 8DPSK
OPERATING FREQUENCY	2402MHz~2480MHz
NUMBER OF CHANNEL	79
PEAK OUTPUT POWER	0.9705 mW (Max. Measured)
ANTENNA TYPE	PCB Antenna, -0.63dBi Gain
I/O PORTS	Refer to user's manual
CABLE SUPPLIED	See note 6

NOTES:

- For a more detailed features description, please refer to the manufacturer's specifications or the user's manual.
- For the test results, the EUT had been tested with all conditions. But only the worst case was shown in test report.
- Please refer to the EUT photo document (Reference No.: 2404WDG0026) for detailed product photo.
- The additional models (see table above) are identical with the test model 5968040 except the model no. and Skin tone outer appearance for trading purposes.

Production name	Trading	Model no.
Bluetooth Nutcracker	Retailer	5968040
		5968039
	Manufacturer	93116
		93118



Test Report No.: RF2404WDG0026

5. The EUT was powered by the following switching power supply:

AC/DC Adapter	
MODEL NO.:	AED09-00901000GQIP44
BRAND NAME:	N/A
INPUT:	100-240V~50/60Hz 0.25A
OUTPUT:	DC 9V/Max. 1A
DC LINE:	1.5m, Unshielded, Non-detachable, 0 Core

6. Product cable information as follows:

ID	Descriptions	Qty.	Length (m)	Shielding (Y/N)	Cores (Qty.)	Remark
1	Demo cable	1	1.2	N	0	N/A

3.2 DESCRIPTION OF TEST MODES

79 channels are provided to this EUT:

CHANNEL	FREQ. (MHz)	CHANNEL	FREQ. (MHz)	CHANNEL	FREQ. (MHz)	CHANNEL	FREQ. (MHz)
0	2402	20	2422	40	2442	60	2462
1	2403	21	2423	41	2443	61	2463
2	2404	22	2424	42	2444	62	2464
3	2405	23	2425	43	2445	63	2465
4	2406	24	2426	44	2446	64	2466
5	2407	25	2427	45	2447	65	2467
6	2408	26	2428	46	2448	66	2468
7	2409	27	2429	47	2449	67	2469
8	2410	28	2430	48	2450	68	2470
9	2411	29	2431	49	2451	69	2471
10	2412	30	2432	50	2452	70	2472
11	2413	31	2433	51	2453	71	2473
12	2414	32	2434	52	2454	72	2474
13	2415	33	2435	53	2455	73	2475
14	2416	34	2436	54	2456	74	2476
15	2417	35	2437	55	2457	75	2477
16	2418	36	2438	56	2458	76	2478
17	2419	37	2439	57	2459	77	2479
18	2420	38	2440	58	2460	78	2480
19	2421	39	2441	59	2461		

3.2.1. CONFIGURATION OF SYSTEM UNDER TEST

Please see section 5 photograph of the test configuration for reference.

3.2.2. TEST MODE APPLICABILITY AND TESTED CHANNEL DETAIL

Pre-Scan has been conducted to determine the worst-case mode from all possible combinations between available modulations, data rates, XYZ axis, power supply voltage range and antenna ports. The worst case was found when positioned on X axis for radiated emission. Following channel(s) was (were) selected for the final test as listed below:

EUT CONFIGURE MODE	APPLICABLE TO				DESCRIPTION
	RE<1G	RE≥1G	PLC	APCM	
A	√	√	√	√	AC 120V/60Hz with BT link

Where **RE<1G**: Radiated Emission below 1GHz
PLC: Power Line Conducted Emission

RE≥1G: Radiated Emission above 1GHz
APCM: Antenna Port Conducted Measurement

RADIATED EMISSION TEST (BELOW 1 GHz):

- Pre-Scan has been conducted to determine the worst-case mode from all possible combinations between available modulations, XYZ axis, antenna ports (if EUT with antenna diversity architecture) and packet type.
- Following channel(s) was (were) selected for the final test as listed below.

EUT CONFIGURE MODE	AVAILABLE CHANNEL	TESTED CHANNEL	MODULATION TECHNOLOGY	MODULATION TYPE	PACKET TYPE
A	0 to 78	39	FHSS	GFSK	DH5

For the test results, only the worst case was shown in test report.

RADIATED EMISSION TEST (ABOVE 1 GHz):

- Pre-Scan has been conducted to determine the worst-case mode from all possible combinations between available modulations, XYZ axis, antenna ports (if EUT with antenna diversity architecture) and packet type.
- Following channel(s) was (were) selected for the final test as listed below.

EUT CONFIGURE MODE	AVAILABLE CHANNEL	TESTED CHANNEL	MODULATION TECHNOLOGY	MODULATION TYPE	PACKET TYPE
A	0 to 78	0, 39, 78	FHSS	GFSK	DH5
A	0 to 78	0, 39, 78	FHSS	8DPSK	3DH5



POWER LINE CONDUCTED EMISSION TEST:

- Pre-Scan has been conducted to determine the worst-case mode from all possible combinations between available modulations, antenna ports (if EUT with antenna diversity architecture), and packet types.
- Following channel(s) was (were) selected for the final test as listed below.

EUT CONFIGURE MODE	AVAILABLE CHANNEL	TESTED CHANNEL	MODULATION TECHNOLOGY	MODULATION TYPE	PACKET TYPE
A	0 to 78	Hopping	FHSS	GFSK	DH5

ANTENNA PORT CONDUCTED MEASUREMENT:

- This item includes all test value of each mode, but only includes spectrum plot of worst value of each mode.
- Pre-Scan has been conducted to determine the worst-case mode from all possible combinations between available modulations, antenna ports (if EUT with antenna diversity architecture), and packet types.
- Following channel(s) was (were) selected for the final test as listed below.

EUT CONFIGURE MODE	AVAILABLE CHANNEL	TESTED CHANNEL	MODULATION TECHNOLOGY	MODULATION TYPE	PACKET TYPE
A	0 to 78	0, 39, 78	FHSS	GFSK	DH5
A	0 to 78	0, 39, 78	FHSS	8DPSK	3DH5

TEST CONDITION:

APPLICABLE TO	ENVIRONMENTAL CONDITIONS	TEST VOLTAGE (Adapter)	TESTED BY
RE<1G	25deg. C, 55%RH	AC 120V 60Hz	Ludius
RE≥1G	25deg. C, 55%RH	AC 120V 60Hz	Ludius
PLC	25deg. C, 55%RH	AC 120V 60Hz	Vincent
APCM	25deg. C, 60%RH	AC 120V 60Hz	Vincent

3.3 GENERAL DESCRIPTION OF APPLIED STANDARDS

The EUT is a RF Product. According to the specifications of the manufacturer, it must comply with the requirements of the following standards:

- FCC Part 15, Subpart C, Section 15.247**
- KDB 558074 D01 15.247 Meas Guidance v05r02**
- ANSI C63.10-2013**

All test items have been performed and recorded as per the above standards.

3.4 DESCRIPTION OF SUPPORT UNITS

The EUT has been tested as an independent unit together with other necessary accessories or support units. The following support units or accessories were used to form a representative test configuration during the tests.

NO.	PRODUCT	BRAND	MODEL NO.	SERIAL NO.	FCC ID	REMARKS
A	Mobile Phone	Samsung	(S23) SM-S9110ZKDCHC	RFCW203Y82P	N/A	BV Lab.

NO.	DESCRIPTION OF THE ABOVE SUPPORT UNITS
1	N/A

3.5 CONFIGURATION OF SYSTEM UNDER TEST

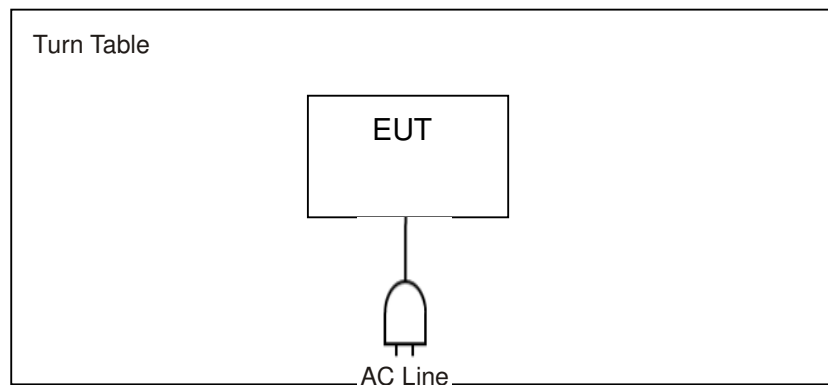

3.6 DUTY CYCLE OF TESET SIGNAL

Test Mode	Packet Type	On Time (ms)	Period (ms)	Duty Cycle (%)	1/T Min. VBW (KHz)	VBW Setting (Hz)
BDR(GFSK)	DH5	2.875	3.750	76.7	0.348	500
EDR(8DPSK)	3DH5	2.885	3.751	76.9	0.347	500

GFSK: Duty Cycle= On Time/ Period=2.875/3.75=0.767

8-DPSK: Duty Cycle= On Time/ Period=2.885/3.751=0.769

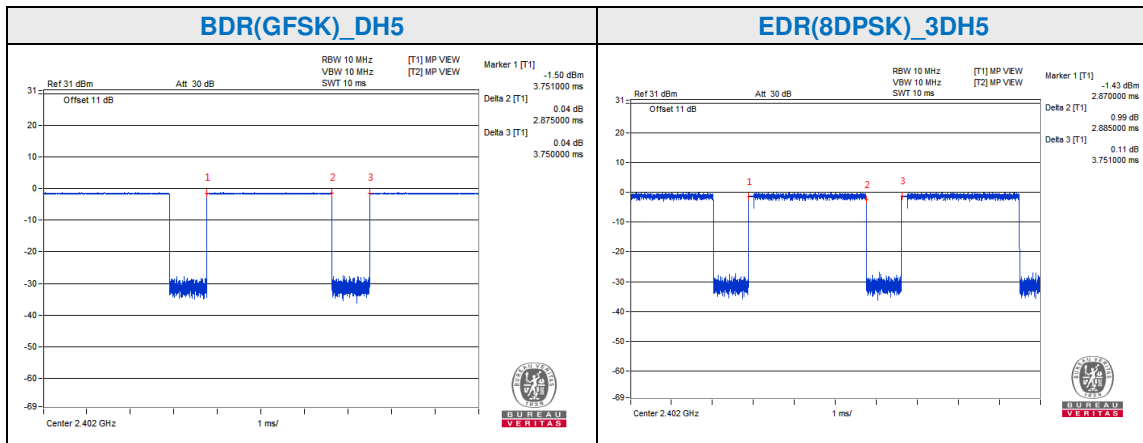

4 TEST TYPES AND RESULTS

4.1. CONDUCTED EMISSION MEASUREMENT

4.1.1 LIMITS OF CONDUCTED EMISSION MEASUREMENT

FREQUENCY OF EMISSION (MHz)	CONDUCTED LIMIT (dB μ V)	
	Quasi-peak	Average
0.15 ~ 0.5	66 to 56	56 to 46
0.5 ~ 5	56	46
5 ~ 30	60	50

- NOTES:**
1. The lower limit shall apply at the transition frequencies.
 2. The limit decreases in line with the logarithm of the frequency in the range of 0.15 to 0.50MHz.
 3. All emanations from a class A/B digital device or system, including any network of conductors and apparatus connected thereto, shall not exceed the level of field strengths specified above.

4.1.2 TEST INSTRUMENTS

Equipment	Manufacturer	Model No.	Serial No.	Next Cal.
EMI Test Receiver	Rohde&Schwarz	ESR7	101494	Jan. 02, 25
Artificial Mains Network	Rohde&Schwarz	ENV216	101173	Jan. 03, 25
Artificial Mains Network	Rohde&Schwarz	ESH3-Z5	100317	Jan. 02, 25
Artificial Mains Network	SCHWARZBECK	NSLK 8122	8122-05001	Jun. 14, 24
V-LISN (CISPR 25)	SCHWARZBECK	NNBM 8124-200	8124-200 05857	Apr. 05, 25
V-LISN (CISPR 25)	SCHWARZBECK	NNBM 8124-200	8124-200 05858	Apr. 05, 25
Voltage probe	SCHWARZBECK	TK 9421	TK 9421-176	Jul. 16, 24
Coaxial RF Cable	SUHNER	RG 223/U-CE	C2310066DG	Jul. 19, 24
Test software	ADT	ADT_Cond_V7.3.7	N/A	N/A

- NOTES:**
1. The test was performed in shielded room 553.
 2. Equipment are calibrated by calibration laboratory accredited to ISO/IEC 17025 by a mutually recognized Accreditation.



Test Report No.: RF2404WDG0026

4.1.3 TEST PROCEDURES

- a. The EUT was placed 0.4 meters from the conducting wall of the shielded room with EUT being connected to the power mains through a line impedance stabilization network (LISN). Other support units were connected to the power mains through another LISN. The two LISNs provide 50 ohm/ 50uH of coupling impedance for the measuring instrument.
- b. Both lines of the power mains connected to the EUT were checked for maximum conducted interference.
- c. The frequency range from 150kHz to 30MHz was searched. Emission levels under (Limit - 20dB) was not recorded.

NOTE: All modes of operation were investigated and the worst-case emissions are reported.

4.1.4 DEVIATION FROM TEST STANDARD

No deviation.

4.1.5 TEST SETUP

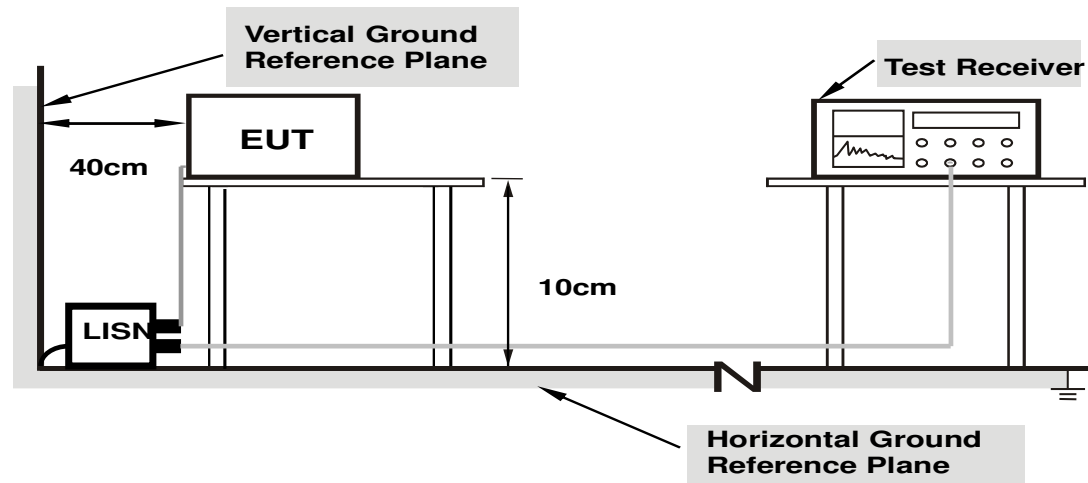

- Notes:**
1. Support units were connected to second LISN.
 2. Both of LISNs (AMN) are 10cm from EUT and at least 10cm from other units and other metal planes support units.

For the actual test configuration, please refer to the attached file (Test Setup Photo).

4.1.6 EUT OPERATING CONDITIONS

- a. Turned on the power and connected of all equipment.
- b. EUT was operated according to the type used was description in manufacturer's specifications or the User's Manual.

4.1.7 TEST RESULTS

CONDUCTED WORST-CASE DATA:

PHASE	Line	6dB BANDWIDTH	9kHz
--------------	------	----------------------	------

No	Freq. [MHz]	Corr. Factor (dB)	Reading Value [dB (uV)]		Emission Level [dB (uV)]		Limit [dB (uV)]		Margin (dB)	
			Q.P.	AV.	Q.P.	AV.	Q.P.	AV.	Q.P.	AV.
1	0.15900	9.65	38.95	21.46	48.60	31.11	65.52	55.52	-16.92	-24.41
2	0.17466	9.68	36.41	20.10	46.09	29.78	64.74	54.74	-18.65	-24.96
3	0.21573	9.74	33.43	14.75	43.17	24.49	62.98	52.98	-19.81	-28.49
4	0.23290	9.75	30.26	13.60	40.01	23.35	62.35	52.35	-22.34	-29.00
5	0.27216	9.76	26.29	11.29	36.05	21.05	61.05	51.05	-25.00	-30.00
6	0.39077	9.78	31.24	19.18	41.02	28.96	58.05	48.05	-17.03	-19.09

- REMARKS:**
1. Q.P. and AV. are abbreviations of quasi-peak and average individually.
 2. "-": The Quasi-peak reading value also meets average limit and measurement with the average detector is unnecessary.
 3. The emission levels of other frequencies were very low against the limit.
 4. Margin value = Emission level - Limit value
 5. Correction factor = Insertion loss + Cable loss
 6. Emission Level = Correction Factor + Reading Value.

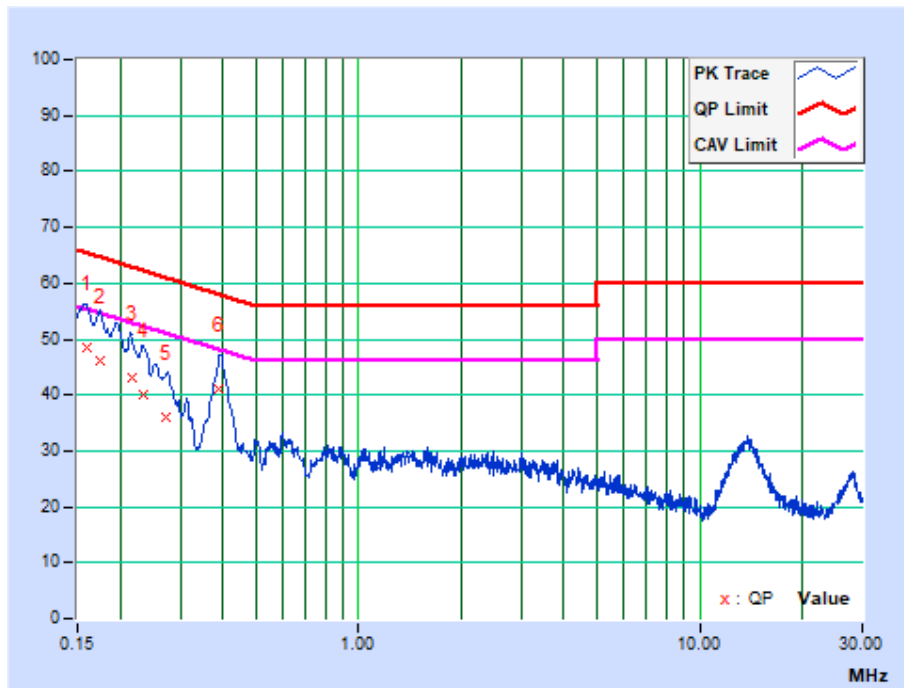

PHASE	Neutral	6dB BANDWIDTH	9kHz
--------------	---------	----------------------	------

No	Freq. [MHz]	Corr. Factor (dB)	Reading Value [dB (uV)]		Emission Level [dB (uV)]		Limit [dB (uV)]		Margin (dB)	
			Q.P.	AV.	Q.P.	AV.	Q.P.	AV.	Q.P.	AV.
1	0.15632	9.43	37.82	21.09	47.25	30.52	65.66	55.66	-18.40	-25.13
2	0.19931	9.39	33.13	16.73	42.52	26.12	63.64	53.64	-21.12	-27.52
3	0.21300	9.39	32.61	14.97	42.00	24.36	63.09	53.09	-21.08	-28.72
4	0.36101	9.39	29.70	21.69	39.09	31.08	58.71	48.71	-19.61	-17.62
5	0.39750	9.40	35.59	25.94	44.99	35.34	57.91	47.91	-12.92	-12.57
6	1.31295	9.49	19.10	8.16	28.59	17.65	56.00	46.00	-27.41	-28.35

- REMARKS:**
1. Q.P. and AV. are abbreviations of quasi-peak and average individually.
 2. "-": The Quasi-peak reading value also meets average limit and measurement with the average detector is unnecessary.
 3. The emission levels of other frequencies were very low against the limit.
 4. Margin value = Emission level - Limit value
 5. Correction factor = Insertion loss + Cable loss
 6. Emission Level = Correction Factor + Reading Value.

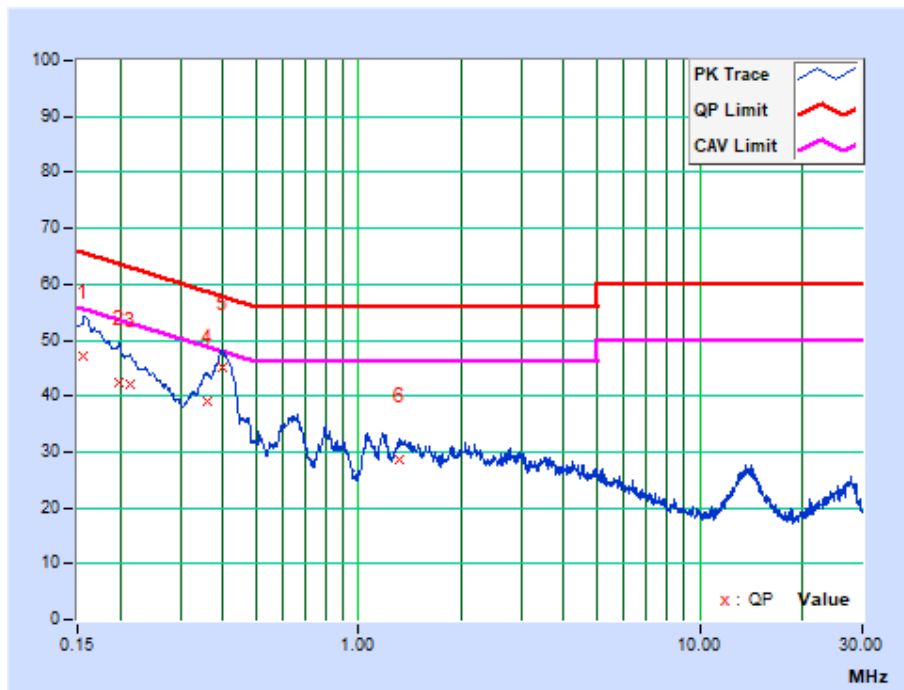

4.2. RADIATED EMISSION AND BANDEDGE MEASUREMENT

4.2.1 LIMITS OF RADIATED EMISSION AND BANDEDGE MEASUREMENT

Radiated emissions which fall in the restricted bands, as defined in Section 15.205(a), must also comply with the radiated emission limits specified in Section 15.209(a). Other emissions shall be at least 20dB below the highest level of the desired power.

FREQUENCIES (MHz)	FIELD STRENGTH (microvolts/meter)	MEASUREMENT DISTANCE (meters)
0.009 ~ 0.490	2400/F(kHz)	300
0.490 ~ 1.705	24000/F(kHz)	30
1.705 ~ 30.0	30	30
30 ~ 88	100	3
88 ~ 216	150	3
216 ~ 960	200	3
Above 960	500	3

NOTE:

1. The lower limit shall apply at the transition frequencies.
2. Emission level (dBuV/m) = 20 log Emission level (uV/m).
3. As shown in 15.35(b), for frequencies above 1000MHz, the field strength limits are based on average detector, however, the peak field strength of any emission shall not exceed the maximum permitted average limits, specified above by more than 20dB under any condition of modulation.



Test Report No.: RF2404WDG0026

4.2.2 TEST INSTRUMENTS

Equipment	Manufacturer	Model No.	Serial No.	Next Cal.
EMI Test Receiver	Rohde&Schwarz	ESU40	100449	Jan. 02, 25
Signal and Spectrum Analyzer	Rohde&Schwarz	FSV7	102331	Apr. 05, 25
Active Loop Antenna (9KHz -30MHz)	SCHWARZBECK	FMZB 1519B	1519B-045	May 09, 24
Amplifier (9KHz -1GHz)	Burgeon	BPA-530	100210	Mar. 06, 25
Trilog-Broadband Antenna	SCHWARZBECK	VULB 9168	9168-554	Jan. 08, 25
Horn Antenna (1GHz -18GHz)	ETS -Lindgren	3117	00062558	Apr. 01, 25
Horn Antenna (18GHz -40GHz)	SCHWARZBECK	BBHA 9170	BBHA9170147	Apr. 01, 25
3m Semi-anechoic Chamber	ETS-LINDGREN	9m*6m*6m	NSEMC003	May 20, 24
Test Software	ADT	ADT_Radiated_V7.6.15.9.2	N/A	N/A
Broadband Preamplifier (1GHz~18GHz)	SCHWARZBECK	BBV9718	305	Apr. 24, 25
Pre-Amplifier (18GHz-40GHz)	EMCI	EMC 184045	980102	Jan. 02, 25
BLUETOOTH TESTER	Rohde&Schwarz	CBT32	100811	N/A

NOTES:

1. The test was performed in 966 Chamber.
2. Equipment are calibrated by calibration laboratory accredited to ISO/IEC 17025 by a mutually recognized Accreditation.
3. The horn antenna is used only for the measurement of emission frequency above 1GHz if tested.
4. The FCC Site Registration No. is 749762.



4.2.3 TEST PROCEDURES

- a. The EUT was placed on the top of a rotating table 1.5 meters (above 1GHz) and 0.8 meters (below 1GHz) above the ground at a 3 meters semi-anechoic chamber. The table was rotated 360 degrees to determine the position of the highest radiation.
- b. The EUT was set 3 meters away from the interference-receiving antenna, which was mounted on the top of a variable-height antenna tower.
- c. For below 1GHz was used bilog antenna, and above 1GHz was used horn antenna, and its height is varied from one meter to four meters above the ground to determine the maximum value of the field strength. Both horizontal and vertical polarizations of the antenna are set to make the measurement.
- d. For each suspected emission, the EUT was arranged to its worst case and then the antenna was tuned to heights from 1 meter to 4 meters and the rotatable table was turned from 0 degrees to 360 degrees to find the maximum reading.
- e. The test-receiver system was set to Peak Detect Function and Specified Bandwidth with Maximum Hold Mode.
- f. For below 30MHz, a loop antenna with its vertical plane is placed 3m from the EUT and rotated about its vertical axis for maximum response at each azimuth about the EUT. And the centre of the loop shall be 1.3m above the ground.
- g. During the test, each emission was maximized by: having the EUT continuously working, investigated all operating modes, rotated about all 3 axis (X, Y & Z) and considered typical configuration to obtain worst position, manipulating interconnecting cables, For battery operated equipment, the equipment tests shall be performed using fresh batteries. The turntable was rotated to maximize the emission level.

NOTES:

1. The resolution bandwidth and video bandwidth of test receiver/spectrum analyzer is 120kHz for Quasi-peak detection at frequency below 1GHz.
2. The resolution bandwidth of test receiver/spectrum analyzer is 1 MHz and video bandwidth is 3MHz for Peak detection at frequency above 1GHz.
3. The resolution bandwidth of test receiver/spectrum analyzer is 1MHz and the video bandwidth is $\geq 1/T$ (Duty cycle < 98%) for Average detection (AV) at frequency above 1GHz.
4. All modes of operation were investigated and the worst-case emissions are reported.
5. The testing of the EUT was performed on all 3 orthogonal axes; the worst-case test configuration was reported on the file test setup photo.

4.2.4 DEVIATION FROM TEST STANDARD

No deviation.

4.2.5 TEST SETUP

Below 30MHz test setup

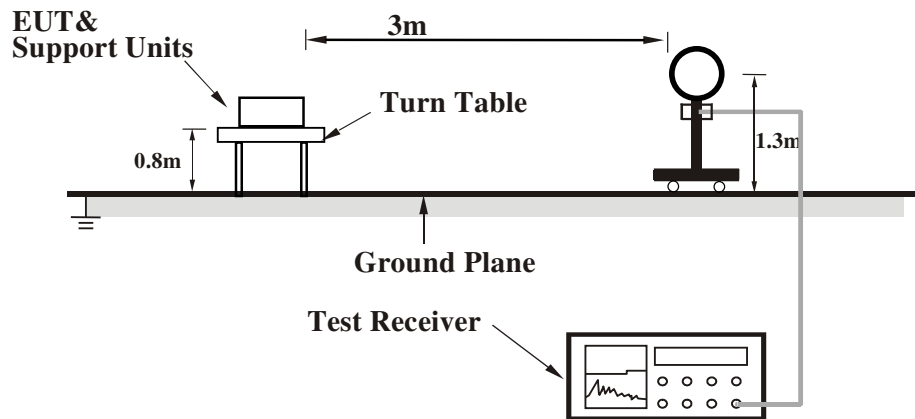

Below 1GHz test setup

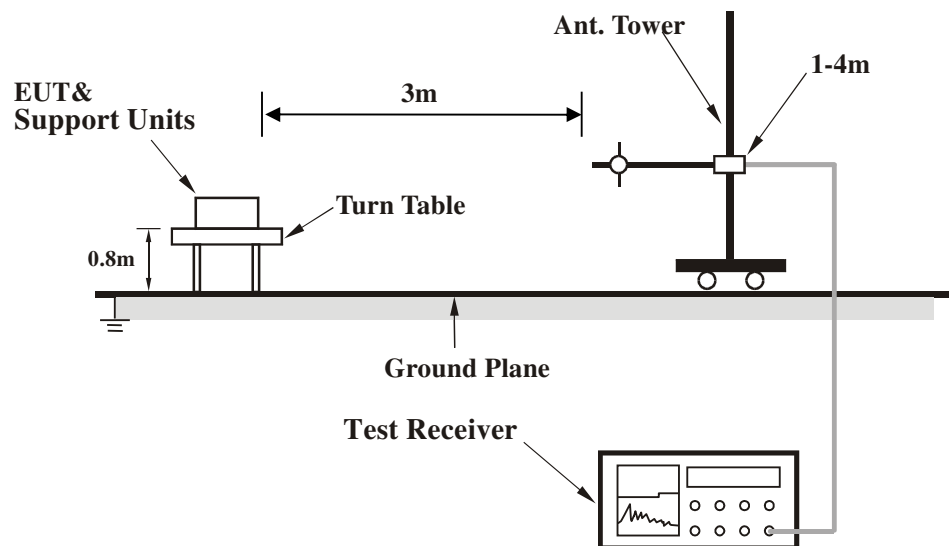

Note: For the actual test configuration, please refer to the attached file (Test Setup Photo).

Above 1GHz test setup

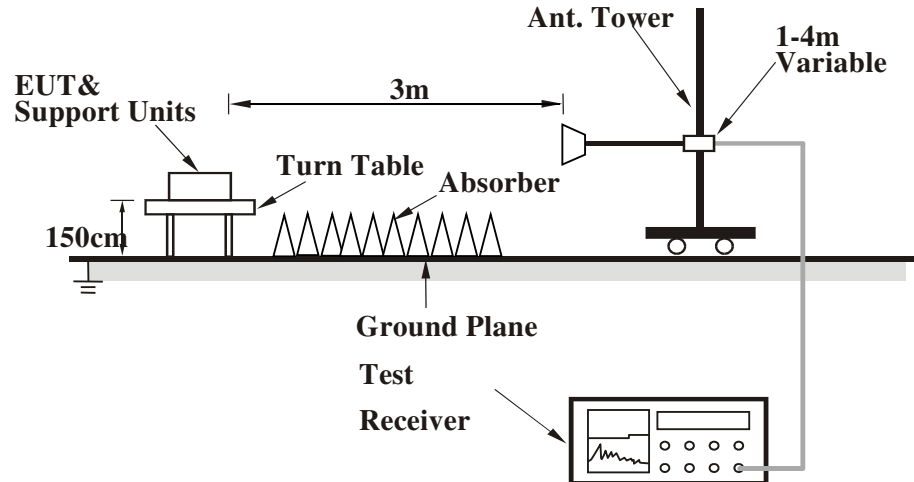

Note: For the actual test configuration, please refer to the attached file (Test Setup Photo).

4.2.6 EUT OPERATING CONDITIONS

- a. Set the EUT under full load condition and placed them on a testing table.
- b. Set the transmitter part of EUT under transmission condition continuously at specific channel frequency.
- c. The necessary accessories enable the EUT in full functions.

4.2.7 TEST RESULTS

BELOW 1GHz WORST-CASE DATA:

GFSK DH5

CHANNEL	Channel 39	DETECTOR FUNCTION	Quasi-Peak (QP)
FREQUENCY RANGE	9KHz ~ 1GHz		

ANTENNA POLARITY & TEST DISTANCE: HORIZONTAL AT 3 M								
NO.	FREQ. (MHz)	EMISSION LEVEL (dBuV/m)	LIMIT (dBuV/m)	MARGIN (dB)	ANTENNA HEIGHT (m)	TABLE ANGLE (Degree)	RAW VALUE (dBuV)	CORRECTIO N FACTOR (dB/m)
1	61.09	7.31 QP	40.00	-32.69	1.99 H	271	25.44	-18.13
2	176.12	8.94 QP	43.50	-34.56	1.38 H	331	27.28	-18.34
3	263.17	9.09 QP	46.00	-36.91	2.20 H	251	26.25	-17.16
4	336.23	11.68 QP	46.00	-34.32	1.79 H	291	26.71	-15.03
5	465.26	16.60 QP	46.00	-29.40	1.64 H	306	27.84	-11.24
6	510.34	15.99 QP	46.00	-30.01	2.41 H	230	26.48	-10.49

REMARKS:

1. Emission level (dBuV/m) = Raw Value (dBuV) + Correction Factor (dB/m).
2. Correction Factor (dB/m) = Antenna Factor (dB/m) + Cable Factor (dB).
3. The emission levels of other frequencies were greater than 20dB margin.
4. 9KHz~30MHz have been test and test data more than 20dB margin.
5. Margin value = Emission level – Limit value

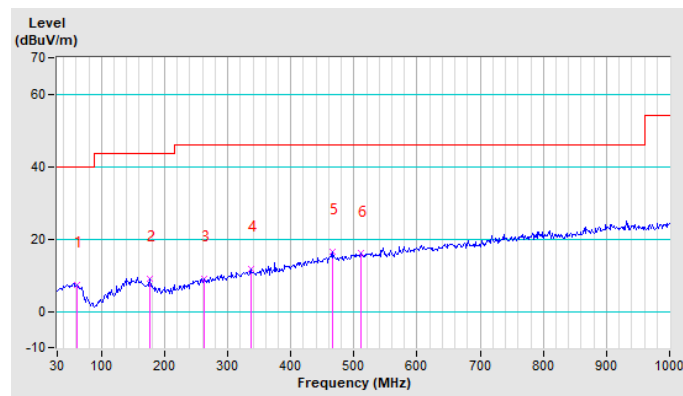

CHANNEL	Channel 39	DETECTOR FUNCTION	Quasi-Peak (QP)
FREQUENCY RANGE	9KHz ~ 1GHz		

ANTENNA POLARITY & TEST DISTANCE: VERTICAL AT 3 M								
NO.	FREQ. (MHz)	EMISSION LEVEL (dBuV/m)	LIMIT (dBuV/m)	MARGIN (dB)	ANTENNA HEIGHT (m)	TABLE ANGLE (Degree)	RAW VALUE (dBuV)	CORRECTIO N FACTOR (dB/m)
1	59.54	7.03 QP	40.00	-32.97	1.00 V	294	25.03	-18.00
2	155.91	9.17 QP	43.50	-34.33	1.00 V	219	26.16	-16.99
3	330.02	11.19 QP	46.00	-34.81	1.00 V	200	26.35	-15.16
4	474.58	16.66 QP	46.00	-29.34	1.00 V	238	27.74	-11.08
5	588.06	17.04 QP	46.00	-28.96	1.00 V	256	25.96	-8.92
6	668.89	18.50 QP	46.00	-27.50	1.00 V	156	25.88	-7.38

REMARKS:

1. Emission level (dBuV/m) = Raw Value (dBuV) + Correction Factor (dB/m).
2. Correction Factor (dB/m) = Antenna Factor (dB/m) + Cable Factor (dB).
3. The emission levels of other frequencies were greater than 20dB margin.
4. 9KHz~30MHz have been test and test data more than 20dB margin.
5. Margin value = Emission level – Limit value

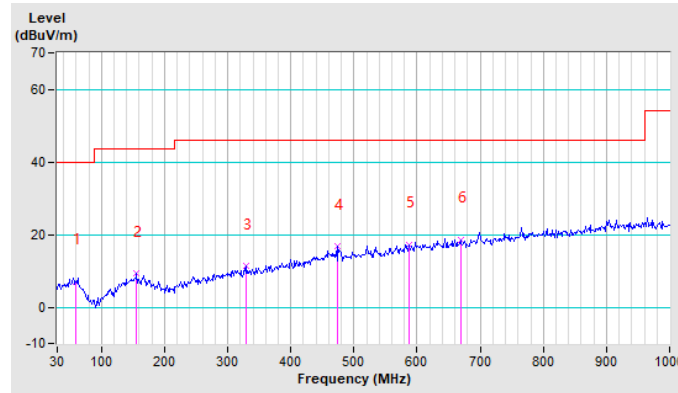



Test Report No.: RF2404WDG0026

ABOVE 1GHz DATA

BT_GFSK

CHANNEL	TX Channel 0	DETECTOR FUNCTION	Peak (PK)
FREQUENCY RANGE	1GHz ~ 25GHz		Average (AV)

ANTENNA POLARITY & TEST DISTANCE : HORIZONTAL AT 3 M

NO.	FREQ. (MHz)	EMISSION LEVEL (dBuV/m)	LIMIT (dBuV/m)	MARGIN (dB)	ANTENNA HEIGHT (m)	TABLE ANGLE (Degree)	RAW VALUE (dBuV)	CORRECTION FACTOR (dB/m)
1	2390.00	45.17 PK	74.00	-28.83	1.50 H	321	42.13	3.04
2	2390.00	33.05 AV	54.00	-20.95	1.50 H	321	30.01	3.04
3	*2402.00	87.16 PK			1.50 H	321	84.12	3.04
4	*2402.00	86.67 AV			1.50 H	321	83.63	3.04
5	4804.00	40.65 PK	74.00	-33.35	3.21 H	150	33.73	6.92
6	4804.00	28.60 AV	54.00	-25.40	3.21 H	150	21.68	6.92
7	#7206.00	40.46 PK	74.00	-33.54	1.22 H	321	29.89	10.57
8	#7206.00	27.55 AV	54.00	-26.45	1.22 H	321	16.98	10.57

ANTENNA POLARITY & TEST DISTANCE : VERTICAL AT 3 M

NO.	FREQ. (MHz)	EMISSION LEVEL (dBuV/m)	LIMIT (dBuV/m)	MARGIN (dB)	ANTENNA HEIGHT (m)	TABLE ANGLE (Degree)	RAW VALUE (dBuV)	CORRECTION FACTOR (dB/m)
1	2390.00	49.33 PK	74.00	-24.67	1.23 V	213	46.29	3.04
2	2390.00	33.25 AV	54.00	-20.75	1.23 V	213	30.21	3.04
3	*2402.00	86.05 PK			1.23 V	213	83.01	3.04
4	*2402.00	85.68 AV			1.23 V	213	82.64	3.04
5	4804.00	46.56 PK	74.00	-27.44	1.28 V	222	39.64	6.92
6	4804.00	33.42 AV	54.00	-20.58	1.28 V	222	26.50	6.92
7	#7206.00	40.31 PK	74.00	-33.69	2.50 V	333	29.74	10.57
8	#7206.00	30.23 AV	54.00	-23.77	2.50 V	333	19.66	10.57

REMARKS:

1. Emission level (dBuV/m) = Raw Value (dBuV) + Correction Factor (dB/m).
2. Correction Factor (dB/m) = Antenna Factor (dB/m) + Cable Factor (dB).
3. The emission levels of other frequencies were greater than 20dB margin.
4. Margin value = Emission level – Limit value.
5. " * ": Fundamental frequency.
6. " # ": The radiated frequency is out of the restricted band.

Bureau Veritas Shenzhen Co., Ltd.
Dongguan Branch

No. 96, Guantai Road (Houjie Section), Houjie Town, Dongguan City, Guangdong Province. 523942. People's Republic of China.

Tel: +86 769 8998 2098
Fax: +86 769 8593 1080
Email: customerservice.dg@bureauveritas.com



Test Report No.: RF2404WDG0026

CHANNEL	TX Channel 39	DETECTOR FUNCTION	Peak (PK)
FREQUENCY RANGE	1GHz ~ 25GHz		Average (AV)

ANTENNA POLARITY & TEST DISTANCE : HORIZONTAL AT 3 M

NO.	FREQ. (MHz)	EMISSION LEVEL (dBuV/m)	LIMIT (dBuV/m)	MARGIN (dB)	ANTENNA HEIGHT (m)	TABLE ANGLE (Degree)	RAW VALUE (dBuV)	CORRECTION FACTOR (dB/m)
1	*2441.00	88.37 PK			1.23 H	251	85.31	3.06
2	*2441.00	84.89 AV			1.23 H	251	81.83	3.06
3	4882.00	41.82 PK	74.00	-32.18	1.54 H	115	34.60	7.22
4	4882.00	28.70 AV	54.00	-25.30	1.54 H	115	21.48	7.22
5	7323.00	42.33 PK	74.00	-31.67	3.12 H	151	31.43	10.90
6	7323.00	30.72 AV	54.00	-23.28	3.12 H	151	19.82	10.90

ANTENNA POLARITY & TEST DISTANCE : VERTICAL AT 3 M

NO.	FREQ. (MHz)	EMISSION LEVEL (dBuV/m)	LIMIT (dBuV/m)	MARGIN (dB)	ANTENNA HEIGHT (m)	TABLE ANGLE (Degree)	RAW VALUE (dBuV)	CORRECTION FACTOR (dB/m)
1	*2441.00	86.92 PK			1.20 V	212	83.86	3.06
2	*2441.00	85.13 AV			1.20 V	212	82.07	3.06
3	4882.00	43.51 PK	74.00	-30.49	2.22 V	44	36.29	7.22
4	4882.00	29.54 AV	54.00	-24.46	2.22 V	44	22.32	7.22
5	7323.00	42.63 PK	74.00	-31.37	1.50 V	131	31.73	10.90
6	7323.00	29.65 AV	54.00	-24.35	1.50 V	131	18.75	10.90

REMARKS:

1. Emission level (dBuV/m) = Raw Value (dBuV) + Correction Factor (dB/m).
2. Correction Factor (dB/m) = Antenna Factor (dB/m) + Cable Factor (dB).
3. The emission levels of other frequencies were greater than 20dB margin.
4. Margin value = Emission level – Limit value.
5. " * " : Fundamental frequency.

CHANNEL	TX Channel 78	DETECTOR FUNCTION	Peak (PK)
FREQUENCY RANGE	1GHz ~ 25GHz		Average (AV)

ANTENNA POLARITY & TEST DISTANCE : HORIZONTAL AT 3 M								
NO.	FREQ. (MHz)	EMISSION LEVEL (dBuV/m)	LIMIT (dBuV/m)	MARGIN (dB)	ANTENNA HEIGHT (m)	TABLE ANGLE (Degree)	RAW VALUE (dBuV)	CORRECTION FACTOR (dB/m)
1	*2480.00	86.29 PK			2.22 H	159	83.23	3.06
2	*2480.00	85.31 AV			2.22 H	159	82.25	3.06
3	2483.50	47.28 PK	74.00	-26.72	2.22 H	159	44.21	3.07
4	2483.50	32.56 AV	54.00	-21.44	2.22 H	159	29.49	3.07
5	4960.00	42.68 PK	74.00	-31.32	1.68 H	32	35.17	7.51
6	4960.00	32.59 AV	54.00	-21.41	1.68 H	32	25.08	7.51
7	7440.00	43.68 PK	74.00	-30.32	1.00 H	151	32.45	11.23
8	7440.00	34.58 AV	54.00	-19.42	1.00 H	151	23.35	11.23
ANTENNA POLARITY & TEST DISTANCE : VERTICAL AT 3 M								
NO.	FREQ. (MHz)	EMISSION LEVEL (dBuV/m)	LIMIT (dBuV/m)	MARGIN (dB)	ANTENNA HEIGHT (m)	TABLE ANGLE (Degree)	RAW VALUE (dBuV)	CORRECTION FACTOR (dB/m)
1	*2480.00	88.21 PK			1.20 V	215	85.15	3.06
2	*2480.00	87.59 AV			1.20 V	215	84.53	3.06
3	2483.50	46.19 PK	74.00	-27.81	1.20 V	215	43.12	3.07
4	2483.50	31.25 AV	54.00	-22.75	1.20 V	215	28.18	3.07
5	4960.00	42.92 PK	74.00	-31.08	1.84 V	357	35.41	7.51
6	4960.00	30.25 AV	54.00	-23.75	1.84 V	357	22.74	7.51
7	7440.00	41.56 PK	74.00	-32.44	1.38 V	95	30.33	11.23
8	7440.00	33.51 AV	54.00	-20.49	1.38 V	95	22.28	11.23

REMARKS:

1. Emission level (dBuV/m) = Raw Value (dBuV) + Correction Factor (dB/m).
2. Correction Factor (dB/m) = Antenna Factor (dB/m) + Cable Factor (dB).
3. The emission levels of other frequencies were greater than 20dB margin.
4. Margin value = Emission level – Limit value.
5. " * " : Fundamental frequency.



Test Report No.: RF2404WDG0026

BT_8DPSK

CHANNEL	TX Channel 0	DETECTOR FUNCTION	Peak (PK)
FREQUENCY RANGE	1GHz ~ 25GHz		Average (AV)

ANTENNA POLARITY & TEST DISTANCE : HORIZONTAL AT 3 M

NO.	FREQ. (MHz)	EMISSION LEVEL (dBuV/m)	LIMIT (dBuV/m)	MARGIN (dB)	ANTENNA HEIGHT (m)	TABLE ANGLE (Degree)	RAW VALUE (dBuV)	CORRECTION FACTOR (dB/m)
1	2390.00	46.71 PK	74.00	-27.29	1.51 H	11	43.67	3.04
2	2390.00	32.93 AV	54.00	-21.07	1.51 H	11	29.89	3.04
3	*2402.00	87.82 PK			1.51 H	11	84.78	3.04
4	*2402.00	83.74 AV			1.51 H	11	80.70	3.04
5	4804.00	41.71 PK	74.00	-32.29	2.11 H	325	34.79	6.92
6	4804.00	31.81 AV	54.00	-22.19	2.11 H	325	24.89	6.92
7	#7206.00	40.19 PK	74.00	-33.81	3.22 H	211	29.62	10.57
8	#7206.00	28.33 AV	54.00	-25.67	3.22 H	211	17.76	10.57

ANTENNA POLARITY & TEST DISTANCE : VERTICAL AT 3 M

NO.	FREQ. (MHz)	EMISSION LEVEL (dBuV/m)	LIMIT (dBuV/m)	MARGIN (dB)	ANTENNA HEIGHT (m)	TABLE ANGLE (Degree)	RAW VALUE (dBuV)	CORRECTION FACTOR (dB/m)
1	2390.00	45.29 PK	74.00	-28.71	1.23 V	360	42.25	3.04
2	2390.00	31.82 AV	54.00	-22.18	1.23 V	360	28.78	3.04
3	*2402.00	86.88 PK			1.23 V	360	83.84	3.04
4	*2402.00	80.39 AV			1.23 V	360	77.35	3.04
5	4804.00	40.52 PK	74.00	-33.48	1.50 V	32	33.60	6.92
6	4804.00	32.89 AV	54.00	-21.11	1.50 V	32	25.97	6.92
7	#7206.00	41.08 PK	74.00	-32.92	1.00 V	52	30.51	10.57
8	#7206.00	31.98 AV	54.00	-22.02	1.00 V	52	21.41	10.57

REMARKS:

1. Emission level (dBuV/m) = Raw Value (dBuV) + Correction Factor (dB/m).
2. Correction Factor (dB/m) = Antenna Factor (dB/m) + Cable Factor (dB).
3. The emission levels of other frequencies were greater than 20dB margin.
4. Margin value = Emission level – Limit value.
5. " * ": Fundamental frequency.
6. " # ": The radiated frequency is out of the restricted band.

Bureau Veritas Shenzhen Co., Ltd.
Dongguan Branch

No. 96, Guantai Road (Houjie Section), Houjie
Town, Dongguan City, Guangdong Province.
523942. People's Republic of China.

Tel: +86 769 8998 2098
Fax: +86 769 8593 1080
Email: customerservice.dg@bureauveritas.com



Test Report No.: RF2404WDG0026

CHANNEL	TX Channel 39	DETECTOR FUNCTION	Peak (PK)
FREQUENCY RANGE	1GHz ~ 25GHz		Average (AV)

ANTENNA POLARITY & TEST DISTANCE : HORIZONTAL AT 3 M

NO.	FREQ. (MHz)	EMISSION LEVEL (dBuV/m)	LIMIT (dBuV/m)	MARGIN (dB)	ANTENNA HEIGHT (m)	TABLE ANGLE (Degree)	RAW VALUE (dBuV)	CORRECTION FACTOR (dB/m)
1	*2441.00	85.21 PK			3.11 H	251	82.15	3.06
2	*2441.00	84.92 AV			3.11 H	251	81.86	3.06
3	4882.00	46.92 PK	74.00	-27.08	2.51 H	32	39.70	7.22
4	4882.00	35.37 AV	54.00	-18.63	2.51 H	32	28.15	7.22
5	7323.00	44.32 PK	74.00	-29.68	2.51 H	11	33.42	10.90
6	7323.00	36.91 AV	54.00	-17.09	2.51 H	11	26.01	10.90

ANTENNA POLARITY & TEST DISTANCE : VERTICAL AT 3 M

NO.	FREQ. (MHz)	EMISSION LEVEL (dBuV/m)	LIMIT (dBuV/m)	MARGIN (dB)	ANTENNA HEIGHT (m)	TABLE ANGLE (Degree)	RAW VALUE (dBuV)	CORRECTION FACTOR (dB/m)
1	*2441.00	88.92 PK			1.58 V	15	85.86	3.06
2	*2441.00	83.41 AV			1.58 V	15	80.35	3.06
3	4882.00	48.39 PK	74.00	-25.61	1.00 V	151	41.17	7.22
4	4882.00	32.86 AV	54.00	-21.14	1.00 V	151	25.64	7.22
5	7323.00	45.62 PK	74.00	-28.38	1.00 V	151	34.72	10.90
6	7323.00	36.91 AV	54.00	-17.09	1.00 V	151	26.01	10.90

REMARKS:

1. Emission level (dBuV/m) = Raw Value (dBuV) + Correction Factor (dB/m).
2. Correction Factor (dB/m) = Antenna Factor (dB/m) + Cable Factor (dB).
3. The emission levels of other frequencies were greater than 20dB margin.
4. Margin value = Emission level – Limit value.
5. " * ": Fundamental frequency.



Test Report No.: RF2404WDG0026

CHANNEL	TX Channel 78	DETECTOR FUNCTION	Peak (PK)
FREQUENCY RANGE	1GHz ~ 25GHz		Average (AV)

ANTENNA POLARITY & TEST DISTANCE : HORIZONTAL AT 3 M

NO.	FREQ. (MHz)	EMISSION LEVEL (dBuV/m)	LIMIT (dBuV/m)	MARGIN (dB)	ANTENNA HEIGHT (m)	TABLE ANGLE (Degree)	RAW VALUE (dBuV)	CORRECTION FACTOR (dB/m)
1	*2480.00	86.99 PK			1.23 H	345	83.93	3.06
2	*2480.00	85.32 AV			1.23 H	345	82.26	3.06
3	2483.50	46.35 PK	74.00	-27.65	1.23 H	345	43.28	3.07
4	2483.50	33.67 AV	54.00	-20.33	1.23 H	345	30.60	3.07
5	4960.00	43.61 PK	74.00	-30.39	3.25 H	11	36.10	7.51
6	4960.00	36.90 AV	54.00	-17.10	3.25 H	11	29.39	7.51
7	7440.00	43.60 PK	74.00	-30.40	1.00 H	12	32.37	11.23
8	7440.00	34.20 AV	54.00	-19.80	1.00 H	12	22.97	11.23

ANTENNA POLARITY & TEST DISTANCE : VERTICAL AT 3 M

NO.	FREQ. (MHz)	EMISSION LEVEL (dBuV/m)	LIMIT (dBuV/m)	MARGIN (dB)	ANTENNA HEIGHT (m)	TABLE ANGLE (Degree)	RAW VALUE (dBuV)	CORRECTION FACTOR (dB/m)
1	*2480.00	87.96 PK			2.34 V	360	84.90	3.06
2	*2480.00	82.31 AV			2.34 V	360	79.25	3.06
3	2483.50	43.92 PK	74.00	-30.08	2.34 V	360	40.85	3.07
4	2483.50	36.90 AV	54.00	-17.10	2.34 V	360	33.83	3.07
5	4960.00	42.90 PK	74.00	-31.10	1.00 V	251	35.39	7.51
6	4960.00	36.90 AV	54.00	-17.10	1.00 V	251	29.39	7.51
7	7440.00	43.90 PK	74.00	-30.10	1.51 V	32	32.67	11.23
8	7440.00	35.60 AV	54.00	-18.40	1.51 V	32	24.37	11.23

REMARKS:

1. Emission level (dBuV/m) = Raw Value (dBuV) + Correction Factor (dB/m).
2. Correction Factor (dB/m) = Antenna Factor (dB/m) + Cable Factor (dB).
3. The emission levels of other frequencies were greater than 20dB margin.
4. Margin value = Emission level – Limit value.
5. " * ": Fundamental frequency.

4.3 NUMBER OF HOPPING FREQUENCY USED

4.3.1 LIMIT OF HOPPING FREQUENCY USED

At least 15 channels frequencies, and should be equally spaced.

4.3.2 TEST SETUP

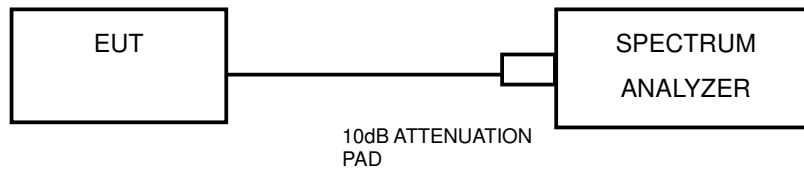

4.3.3 TEST INSTRUMENTS

Equipment	Manufacturer	Model No.	Serial No.	Next Cal.
Power Sensor	Keysight	U2021XA	MY57320002	May 11, 24
Power Meter	Anritsu	ML2495A	1139001	Jul. 11, 24
Power Sensor	Anritsu	MA2411B	1531155	Jul. 11, 24
Digital Multimeter	FLUKE	15B	A1220010DG	N/A
Humid & Temp Programmable Tester	Haida	HD-225T	110807201	Oct. 15, 24
Oscilloscope	Agilent	DSO9254A	MY51260160	Jul. 11, 24
Signal and Spectrum Analyzer	Rohde&Schwarz	FSV40	101094	Jan. 01, 25
Signal Generator	Agilent	N5183A	MY50140980	Jul. 23, 24
MXG-B RF Vector Signal Generator	Keysight	N5182B	MY56200288	Jul. 11, 24
BLUETOOTH TESTER	Rohde&Schwarz	CBT32	100811	N/A
Attenuator	MINI	BW-S10W2+	S130129FGE2	N/A
DC Source	Keysight	E3642A	MY56146098	N/A
Test software	ADT	ADT_RF Test Software V6.6.5.3	N/A	N/A

NOTES:

1. The test was performed in RF Oven room.
2. Equipment are calibrated by calibration laboratory accredited to ISO/IEC 17025 by a mutually recognized Accreditation.



4.3.4 TEST PROCEDURES

- a. Check the calibration of the measuring instrument (SA) using either an internal calibrator or a known signal from an external generator.
- b. Turn on the EUT and connect its antenna terminal to measurement via a low loss cable. Then set it to any one measured frequency within its operating range and make sure the instrument is operated in its linear range.
- c. Set the SA on MaxHold Mode, and then keep the EUT in hopping mode. Record all the signals from each channel until each one has been recorded.
- d. Set the SA on View mode and then plot the result on SA screen.
- e. Repeat above procedures until all frequencies measured were completed.

4.3.5 DEVIATION FROM TEST STANDARD

No deviation.

4.3.6 TEST RESULTS

There are 79 hopping frequencies in the hopping mode. Please refer to next two pages for the test result. On the plots, it shows that the hopping frequencies are equally spaced.



Test Report No.: RF2404WDG0026

GFSK

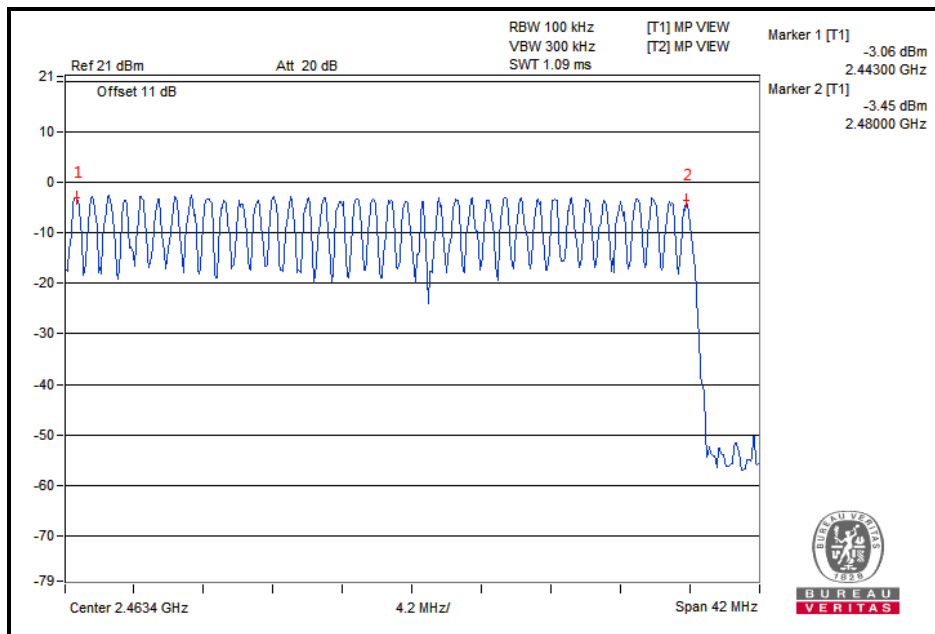
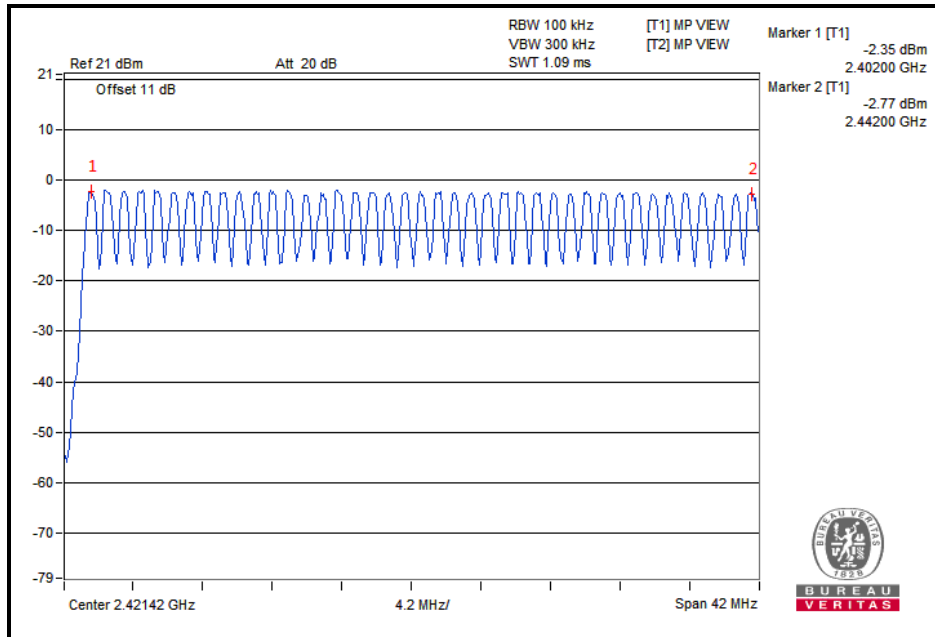

Bureau Veritas Shenzhen Co., Ltd.
Dongguan Branch

No. 96, Guantai Road (Houjie Section), Houjie
Town, Dongguan City, Guangdong Province.
523942. People's Republic of China.

Tel: +86 769 8998 2098
Fax: +86 769 8593 1080
Email: customerservice.dg@bureauveritas.com



Test Report No.: RF2404WDG0026

8DPSK

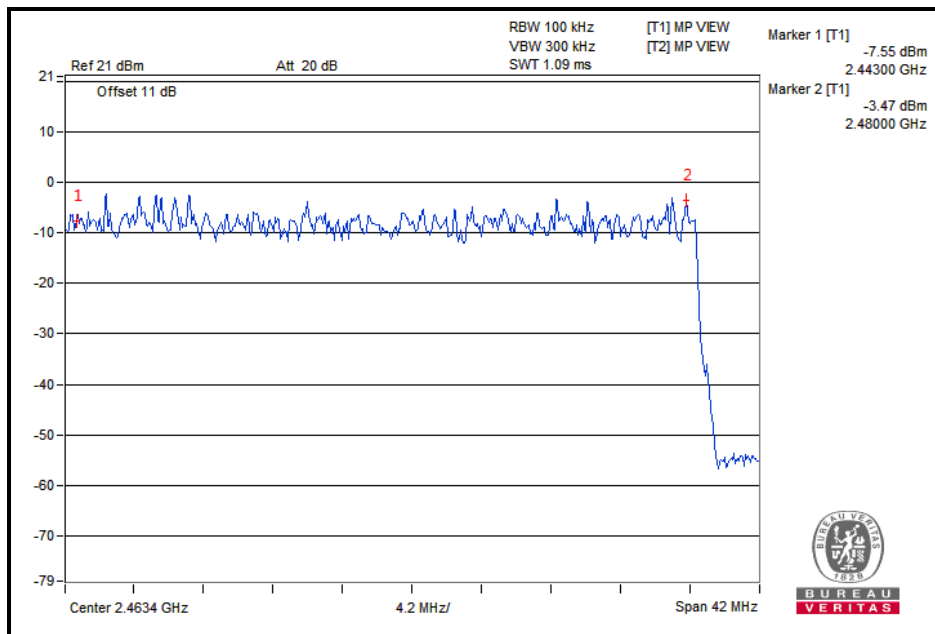
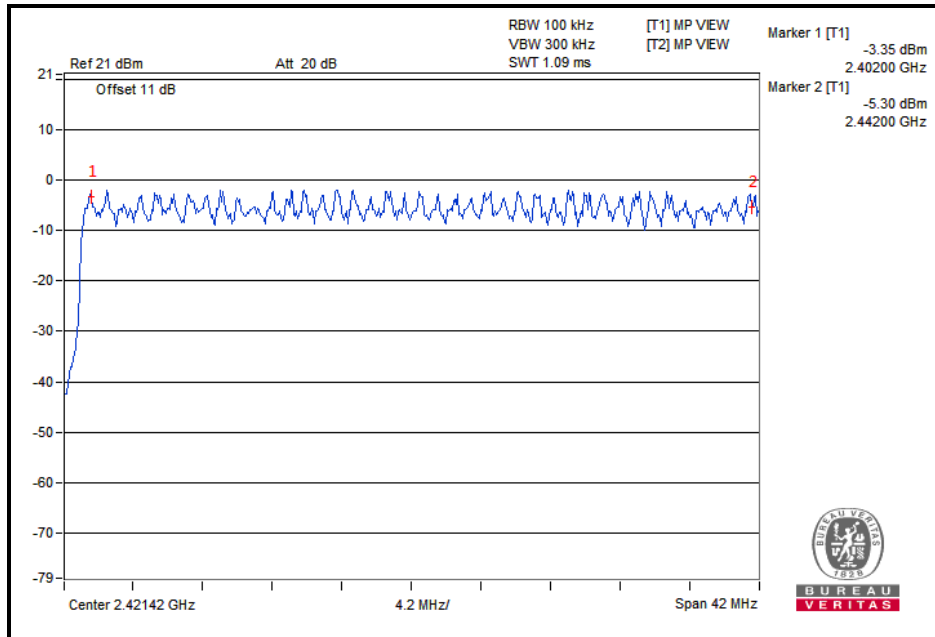

Bureau Veritas Shenzhen Co., Ltd.
Dongguan Branch

No. 96, Guantai Road (Houjie Section), Houjie
Town, Dongguan City, Guangdong Province.
523942. People's Republic of China.

Tel: +86 769 8998 2098
Fax: +86 769 8593 1080
Email: customerservice.dg@bureauveritas.com

4.4 DWELL TIME ON EACH CHANNEL

4.4.1 LIMIT OF DWELL TIME USED

The average time of occupancy on any channel shall not be greater than 0.4 seconds within a period of 0.4 seconds multiplied by the number of hopping channels employed.

4.4.2 TEST SETUP

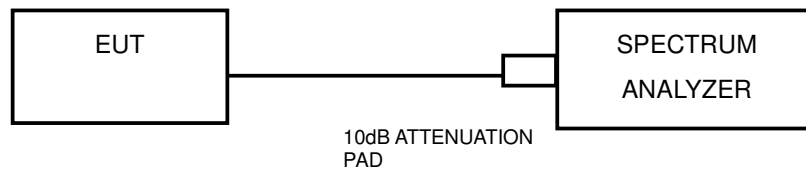

4.4.3 TEST INSTRUMENTS

Refer to section 4.3.3 to get information of above instrument.

4.4.4 TEST PROCEDURES

- a. Check the calibration of the measuring instrument (SA) using either an internal calibrator or a known signal from an external generator.
- b. Turn on the EUT and connect its antenna terminal to measurement via a low loss cable. Then set it to any one measured frequency within its operating range and make sure the instrument is operated in its linear range.
- c. Adjust the center frequency of SA on any frequency be measured and set SA to zero span mode. And then, set RBW and VBW of spectrum analyzer to proper value.
- d. Measure the time duration of one transmission on the measured frequency. And then plot the result with time difference of this time duration.
- e. Repeat above procedures until all different time-slot modes have been completed.

4.4.5 DEVIATION FROM TEST STANDARD

No deviation.

4.4.6 TEST RESULTS

GFSK

Mode	Number of Hopping Channel	Number of transmission in a period(channel number*0.4 sec)				Length of transmission time (msec)	Result (msec)	Limit (msec)	PASS / FAIL
		period (sec)	sweep time (sec)	times in a sweep	times in a period				
DH1	79	31.6	5	50	316	0.408	128.93	400	PASS
DH3	79	31.6	5	26	164.32	1.67	274.41	400	PASS
DH5	79	31.6	5	17	107.44	2.992	321.46	400	PASS

8DPSK

Mode	Number of Hopping Channel	Number of transmission in a period(channel number*0.4 sec)				Length of transmission time (msec)	Result (msec)	Limit (msec)	PASS / FAIL
		period (sec)	sweep time (sec)	times in a sweep	times in a period				
3DH1	79	31.6	5	50	316	0.456	144.1	400	PASS
3DH3	79	31.6	5	25	158	1.68	265.44	400	PASS
3DH5	79	31.6	5	17	107.44	2.96	318.02	400	PASS

NOTE: Test plots of the transmitting time slot are shown on next page.



BUREAU VERITAS

Test Report No.: RF2404WDG0026

GFSK



Bureau Veritas Shenzhen Co., Ltd.
Dongguan Branch

No. 96, Guantai Road (Houjie Section), Houjie
Town, Dongguan City, Guangdong Province.
523942, People's Republic of China.

Tel: +86 769 8998 2098
Fax: +86 769 8593 1080
Email: customerservice.dg@bureauveritas.com

8DPSK

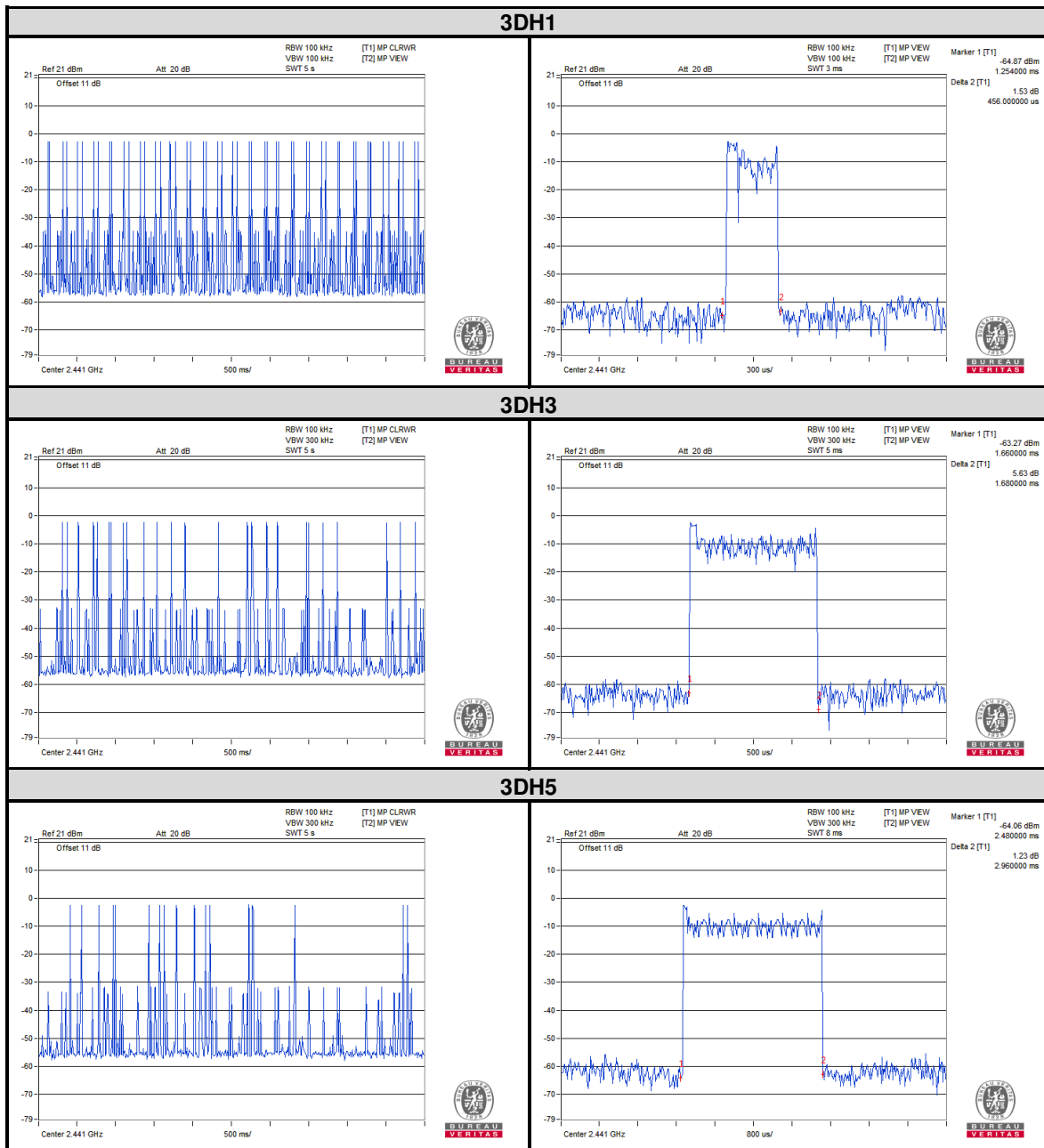

4.5 CHANNEL BANDWIDTH

4.5.1 LIMITS OF CHANNEL BANDWIDTH

For frequency hopping system operating in the 2400-2483.5MHz, If the 20dB bandwidth of hopping channel is greater than 25kHz, two-thirds 20dB bandwidth of hopping channel shall be a minimum limit for the hopping channel separation.

4.5.2 TEST SETUP

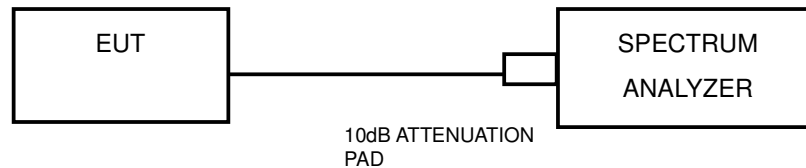

4.5.3 TEST INSTRUMENTS

Refer to section 4.3.3 to get information of above instrument.

4.5.4 TEST PROCEDURE

- a. Check the calibration of the measuring instrument using either an internal calibrator or a known signal from an external generator.
- b. Turn on the EUT and connect it to measurement instrument. Then set it to any one convenient frequency within its operating range. Set a reference level on the measuring instrument equal to the highest peak value.
- c. Measure the frequency difference of two frequencies that were attenuated 20dB from the reference level. Record the frequency difference as the emission bandwidth.
- d. Repeat above procedures until all frequencies measured were complete.

4.5.5 DEVIATION FROM TEST STANDARD

No deviation.

4.5.6 EUT OPERATING CONDITION

The software provided by client to enable the EUT under transmission condition continuously at lowest, middle and highest channel frequencies individually.

4.5.7 TEST RESULTS

GFSK

CHANNEL	CHANNEL FREQUENCY (MHz)	20dB BANDWIDTH (MHz)
0	2402	1.04
39	2441	1.05
78	2480	1.07

CH 0

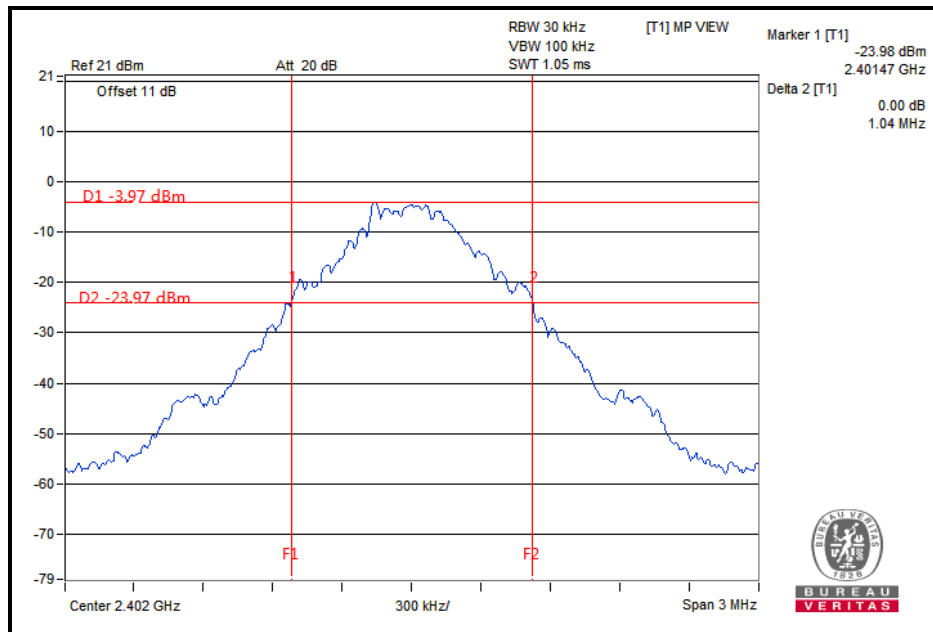

CH 39

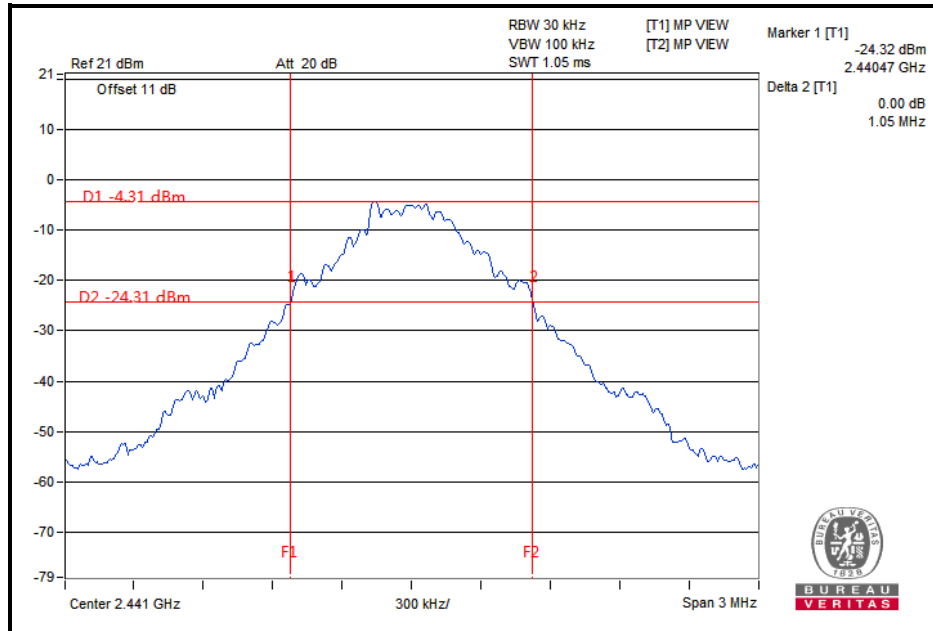

CH 78

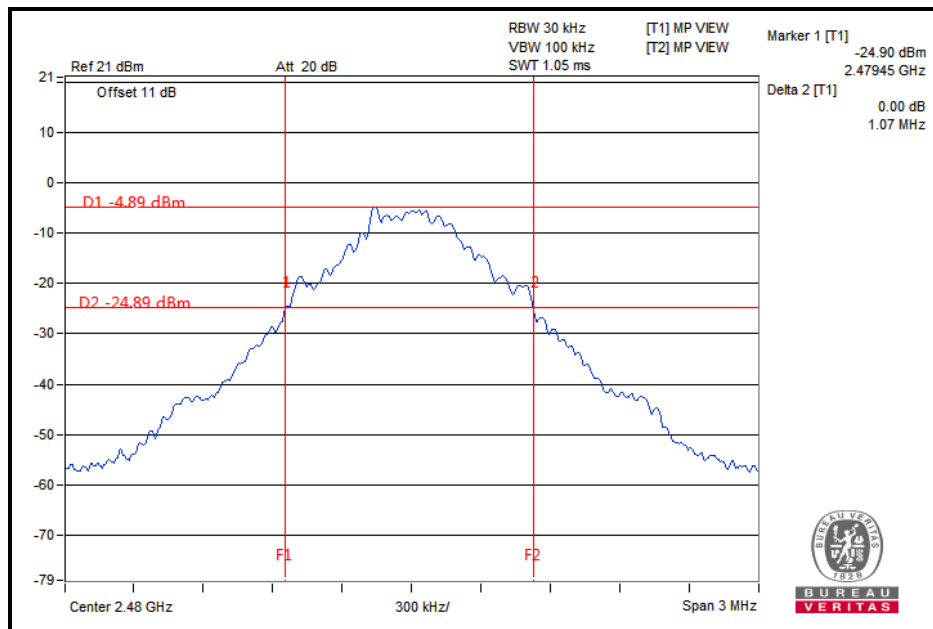

8DPSK

CHANNEL	CHANNEL FREQUENCY (MHz)	20dB BANDWIDTH (MHz)
0	2402	1.30
39	2441	1.30
78	2480	1.29

CH 0

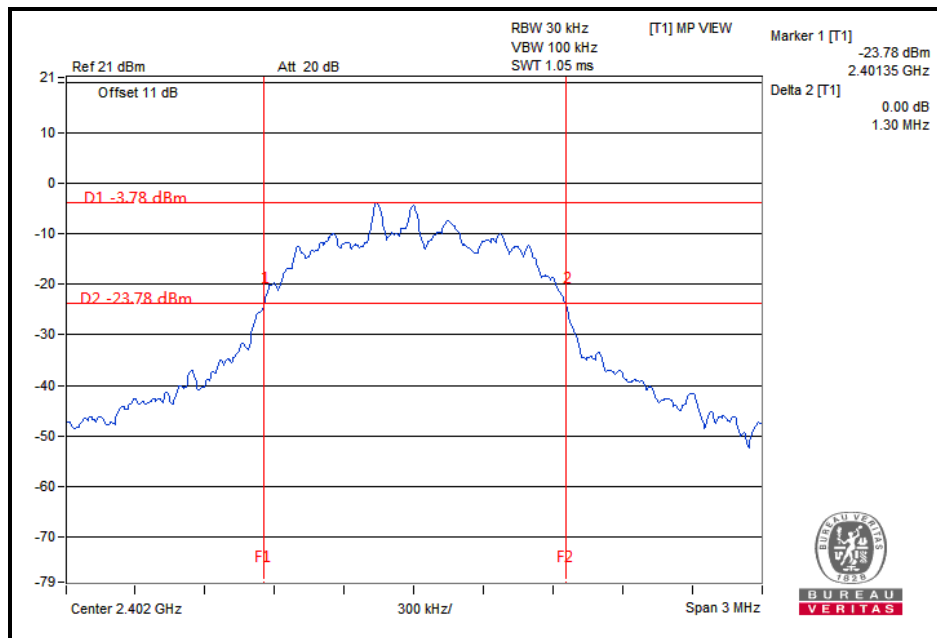

CH 39

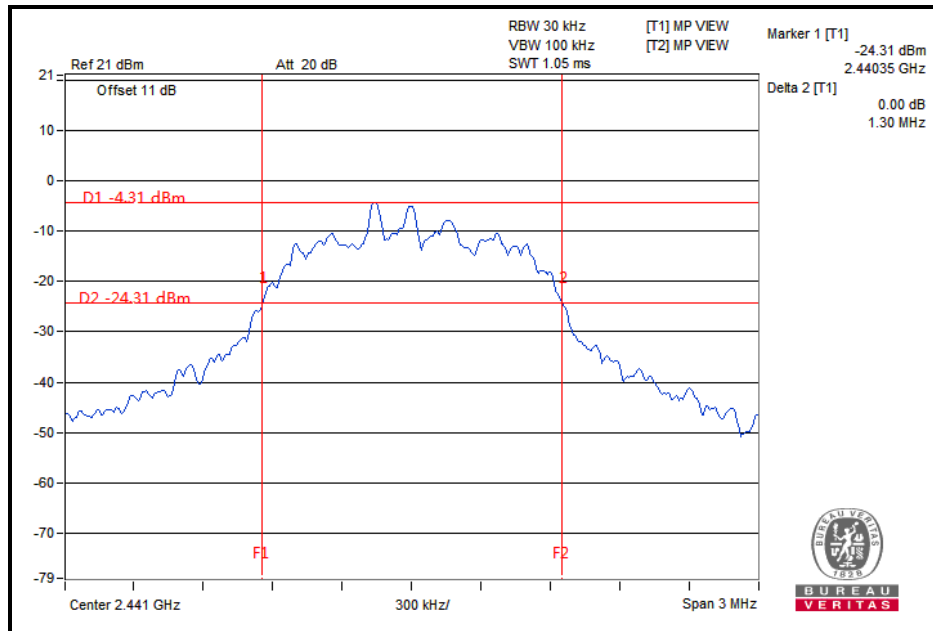

CH 78

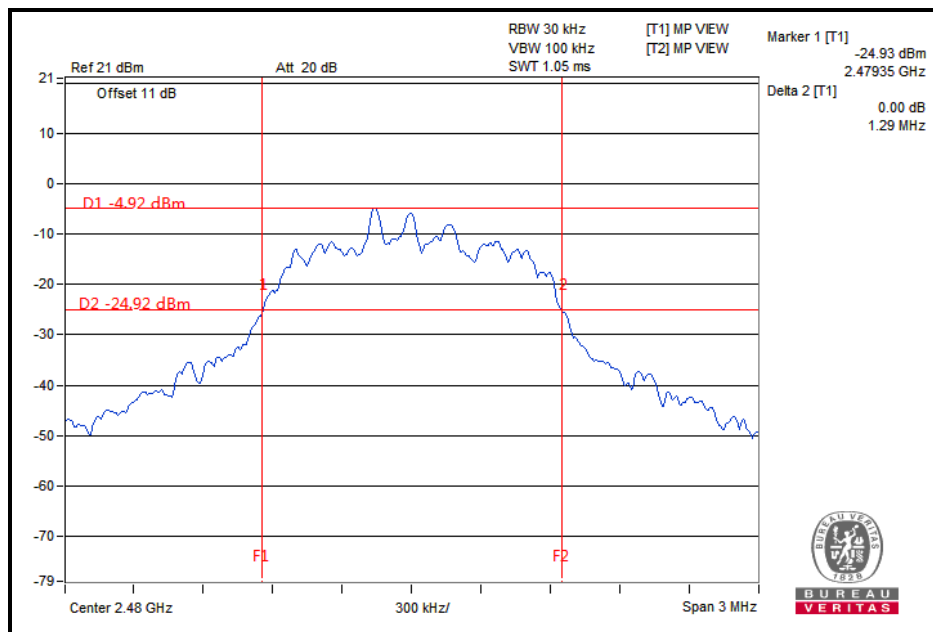

4.6 HOPPING CHANNEL SEPARATION

4.6.1 LIMIT OF HOPPING CHANNEL SEPARATION

At least 25kHz or two-third of 20dB hopping channel bandwidth (whichever is greater).

4.6.2 TEST SETUP

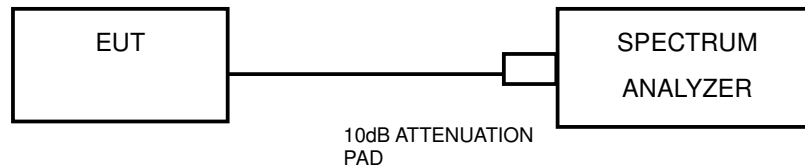

4.6.3 TEST INSTRUMENTS

Refer to section 4.3.3 to get information of above instrument.

4.6.4 TEST PROCEDURES

1. Check the calibration of the measuring instrument using either an internal calibrator or a known signal from an external generator.
2. Turn on the EUT and connect it to measurement instrument. Then set it to any one convenient frequency within its operating range.
3. By using the MaxHold function record the separation of two adjacent channels.
4. Measure the frequency difference of these two adjacent channels by SA MARK function. And then plot the result on SA screen.
5. Repeat above procedures until all frequencies measured were complete.

4.6.5 DEVIATION FROM TEST STANDARD

No deviation.

4.6.6 TEST RESULTS

GFSK

CHANNEL	FREQUENCY (MHz)	ADJACENT CHANNEL SEPARATION (MHz)	20dB BANDWIDTH (MHz)	MINIMUM LIMIT (MHz)	PASS / FAIL
0	2402	1.00	1.04	0.69	PASS
39	2441	1.00	1.05	0.70	PASS
78	2480	1.00	1.07	0.71	PASS

NOTE: The minimum limit is two-third 20dB bandwidth.

CH 0

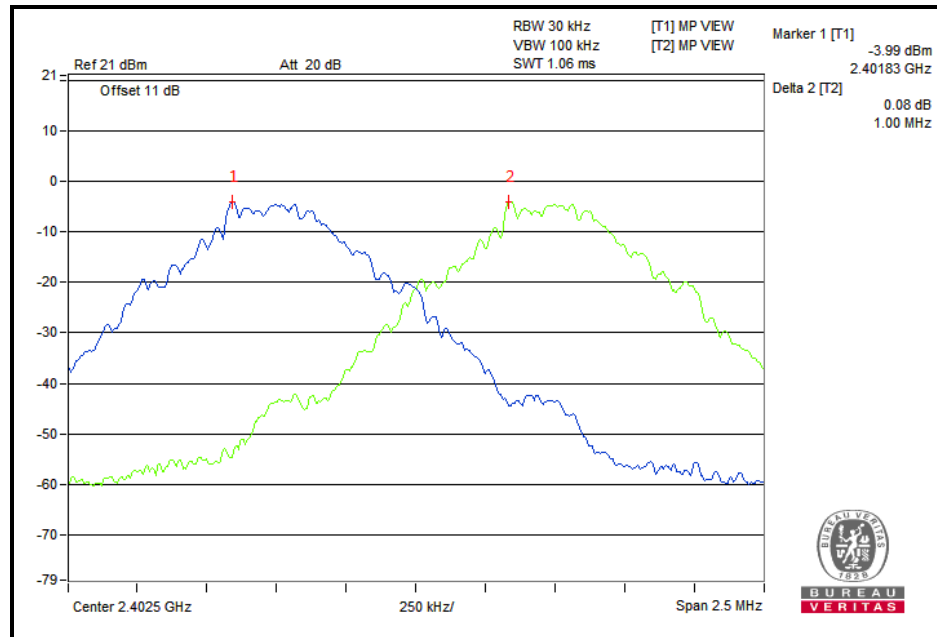

CH 39

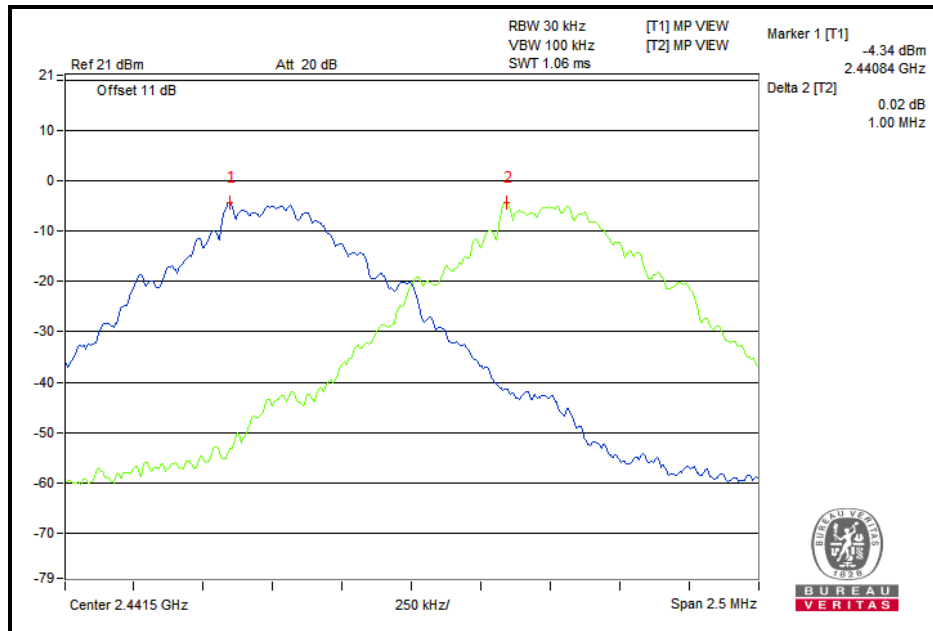

CH 78

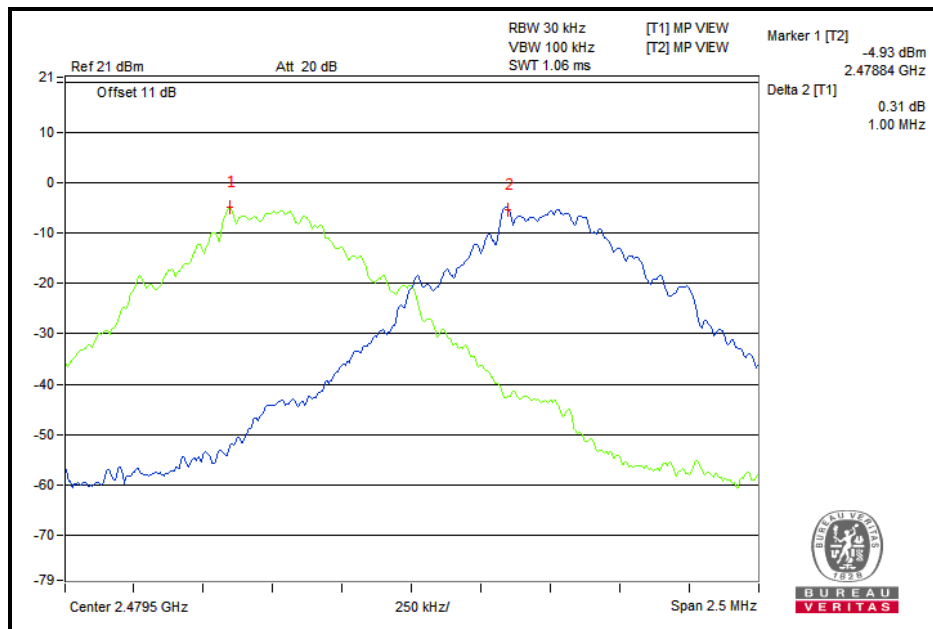

8DPSK

CHANNEL	FREQUENCY (MHz)	ADJACENT CHANNEL SEPARATION (MHz)	20dB BANDWIDTH (MHz)	MINIMUM LIMIT (MHz)	PASS / FAIL
0	2402	1.00	1.30	0.87	PASS
39	2441	1.00	1.30	0.87	PASS
78	2480	1.00	1.29	0.86	PASS

NOTE: The minimum limit is two-third 20dB bandwidth.

CH 0

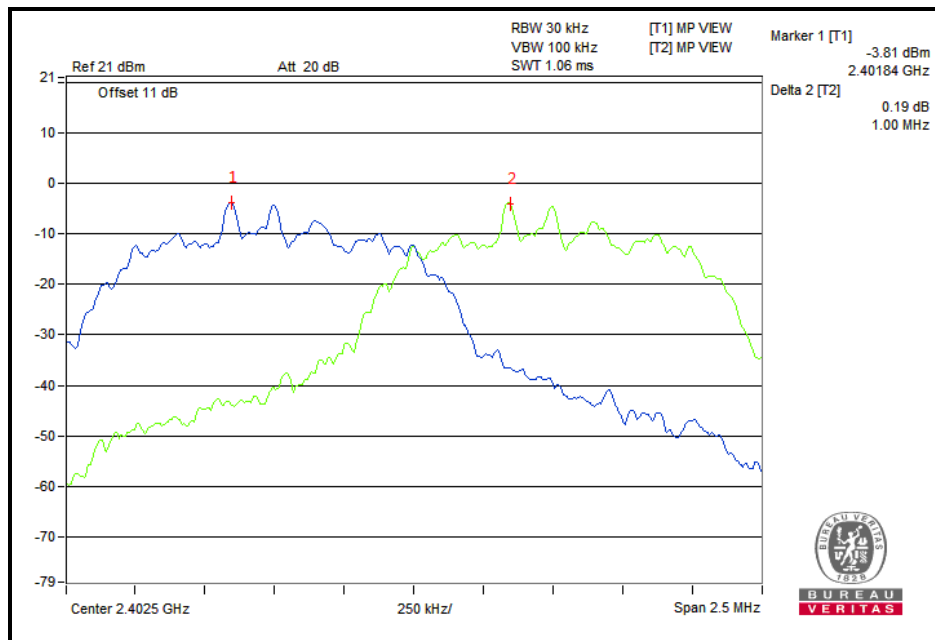

CH 39

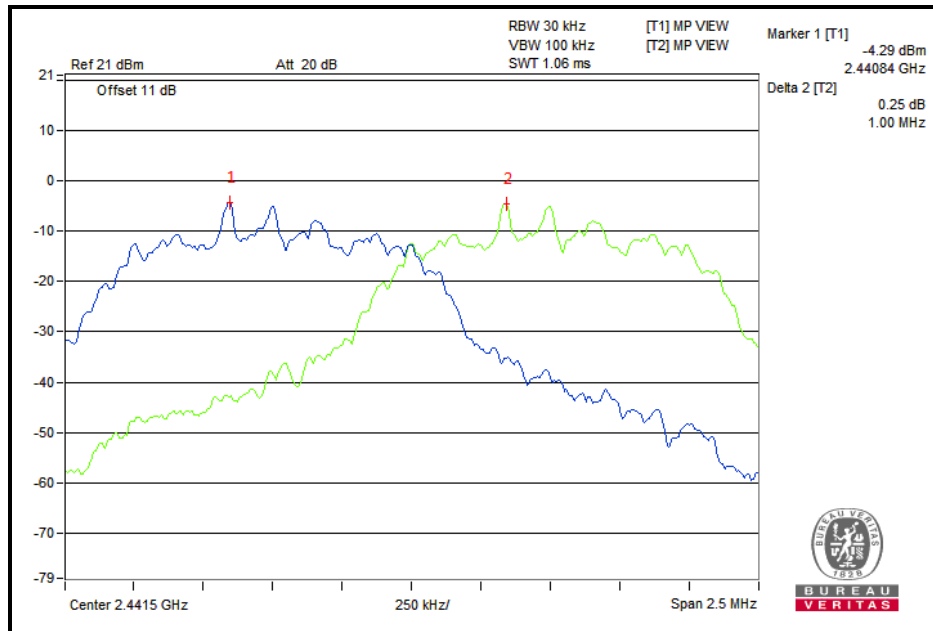

CH 78

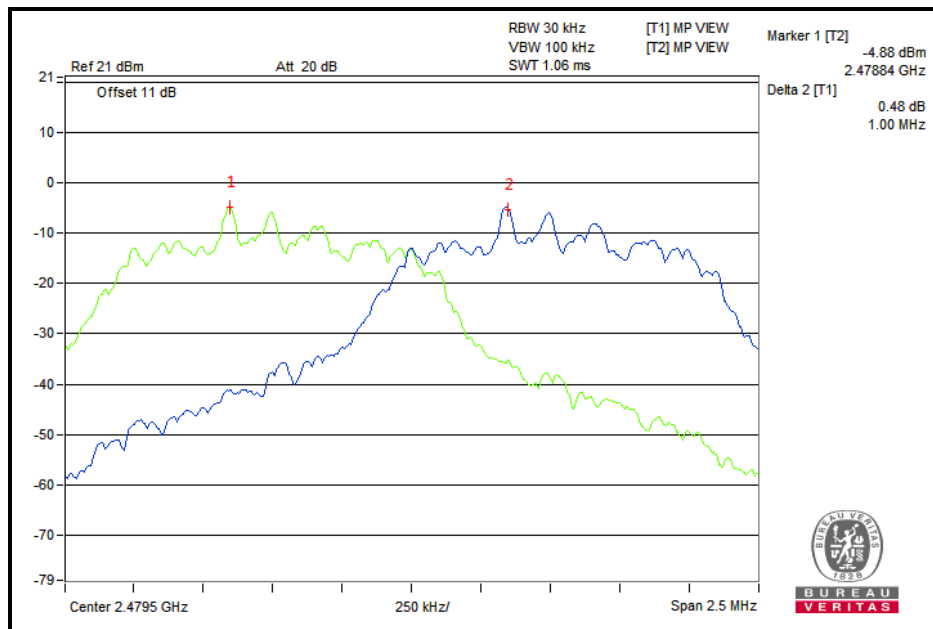

4.7 CONDUCTED OUTPUT POWER

4.7.1 LIMITS OF CONDUCTED OUTPUT POWER MEASUREMENT

The Maximum Output Power Measurement is 0.125W.

4.7.2 TEST SETUP

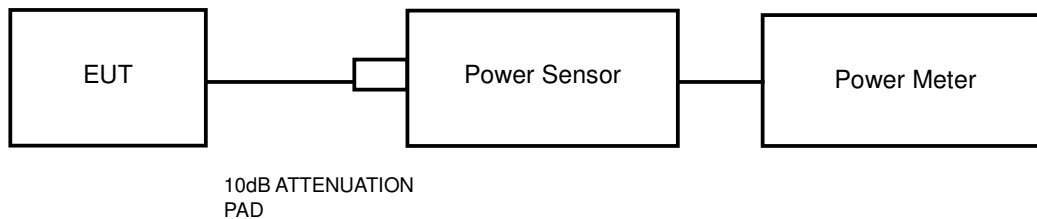

4.7.3 TEST INSTRUMENTS

Refer to section 4.3.3 to get information of above instrument.

4.7.4 TEST PROCEDURES

A peak power sensor was used on the output port of the EUT. A power meter was used to read the response of the peak power sensor and set the detector to PEAK. Record the power level.

An average power sensor was used on the output port of the EUT. A power meter was used to read the response of the average power sensor and set the detector to AVERAGE. Record the power level.

4.7.5 DEVIATION FROM TEST STANDARD

No deviation.

4.7.6 EUT OPERATING CONDITION

The software provided by client to enable the EUT under transmission condition continuously at lowest, middle and highest channel frequencies individually.

4.7.7 TEST RESULTS

MAXIMUM PEAK OUTPUT POWER

GFSK

CHANNEL	CHANNEL FREQUENCY (MHz)	PEAK POWER (dBm)	PEAK POWER (mW)	PEAK POWER LIMIT (W)	PASS/FAIL
0	2402	-1.30	0.7413	0.125	PASS
39	2441	-1.93	0.6412	0.125	PASS
78	2480	-2.42	0.5728	0.125	PASS

8DPSK

CHANNEL	CHANNEL FREQUENCY (MHz)	PEAK POWER (dBm)	PEAK POWER (mW)	PEAK POWER LIMIT (W)	PASS/FAIL
0	2402	-0.13	0.9705	0.125	PASS
39	2441	-0.62	0.867	0.125	PASS
78	2480	-1.20	0.7586	0.125	PASS

AVERAGE OUTPUT POWER(FOR REFERENCE)

GFSK

CHANNEL	CHANNEL FREQUENCY (MHz)	AVERAGE POWER (dBm)	AVERAGE POWER (mW)
0	2402	-1.35	0.7328
39	2441	-2.09	0.618
78	2480	-2.92	0.5105

8DPSK

CHANNEL	CHANNEL FREQUENCY (MHz)	AVERAGE POWER (dBm)	AVERAGE POWER (mW)
0	2402	-1.21	0.7568
39	2441	-1.71	0.6745
78	2480	-2.38	0.5781



4.8 OUT OF BAND EMISSION MEASUREMENT

4.8.1 LIMITS OF OUT OF BAND EMISSION MEASUREMENT

Below -20dB of the highest emission level of operating band (in 100KHz RBW).

4.8.2 TEST INSTRUMENTS

Refer to section 4.2.3 to get information of above instrument.

4.8.3 TEST PROCEDURE

The transmitter output was connected to the spectrum analyzer via a low loss cable. of Spectrum Analyzer was set RBW to 100 kHz and VBW to 300 kHz with suitable frequency span including 100 MHz bandwidth from band edge. Detector = PEAK and Trace mode = Max Hold. The band edges was measured and recorded.

4.8.4 DEVIATION FROM TEST STANDARD

No deviation.

4.8.5 EUT OPERATING CONDITION

The software provided by client to enable the EUT under transmission condition continuously at lowest, middle and highest channel frequencies individually.

4.8.6 TEST RESULTS

The spectrum plots are attached on the following images. D1 line indicates the highest level. D2 line indicates the 20dB offset below D1. It shows compliance to the requirement.



GFSK

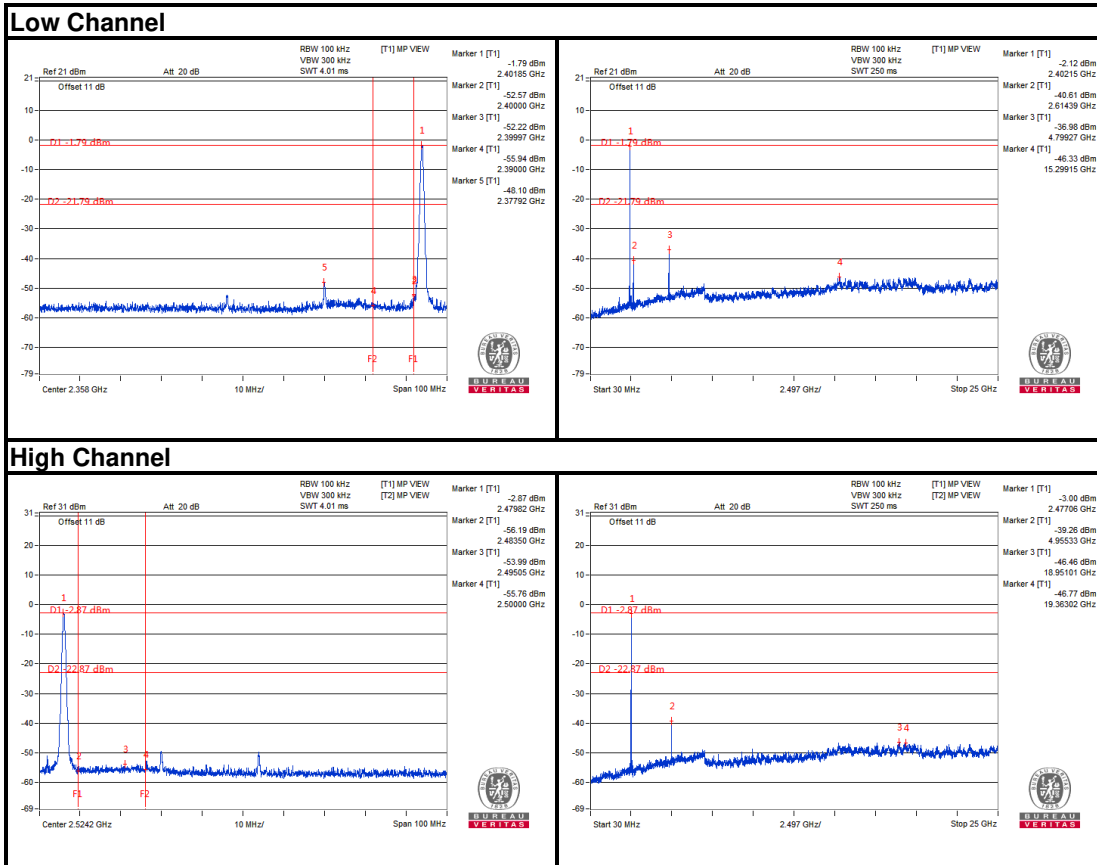

8DPSK

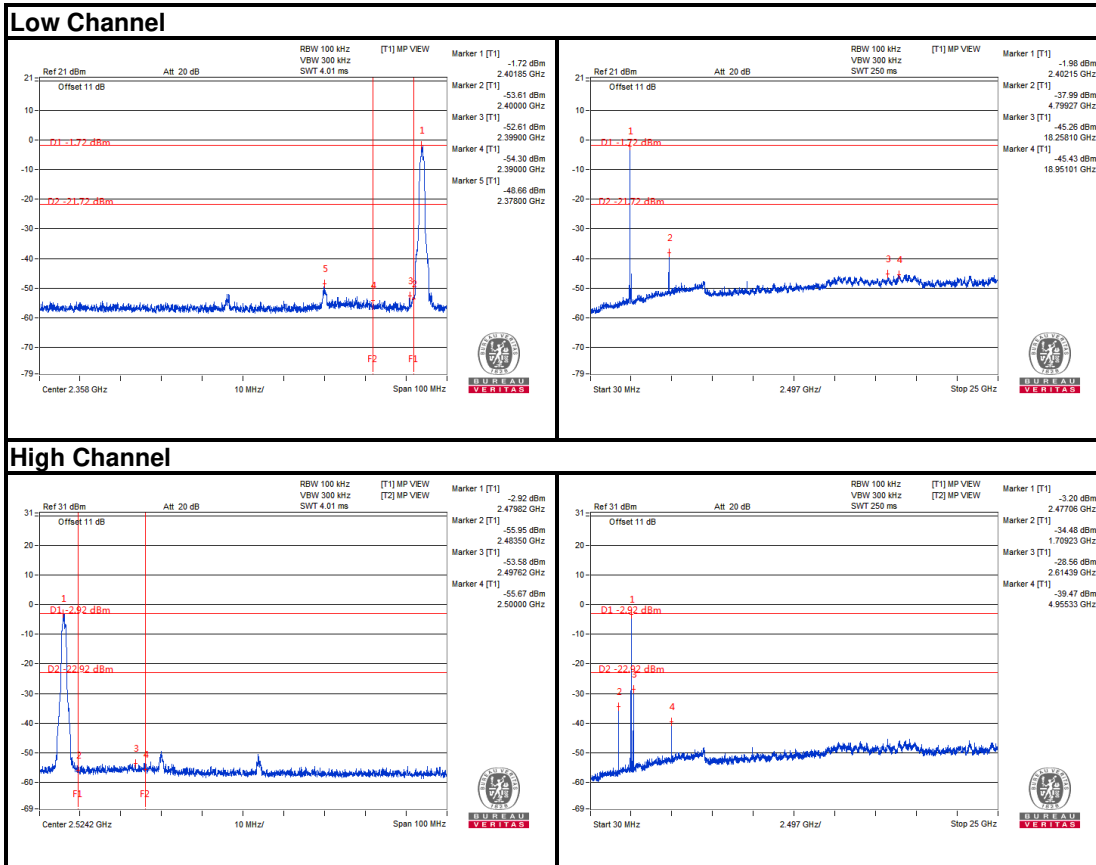



GFSK

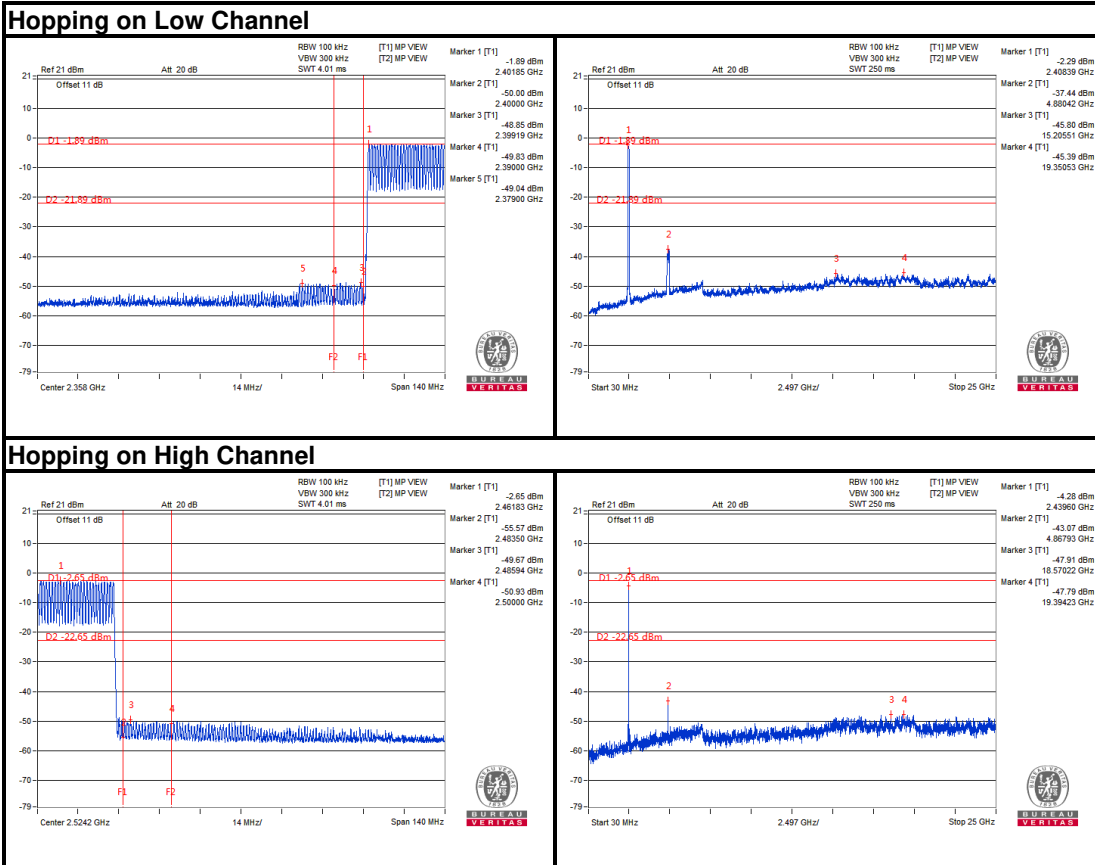



BUREAU VERITAS

Test Report No.: RF2404WDG0026

8DPSK

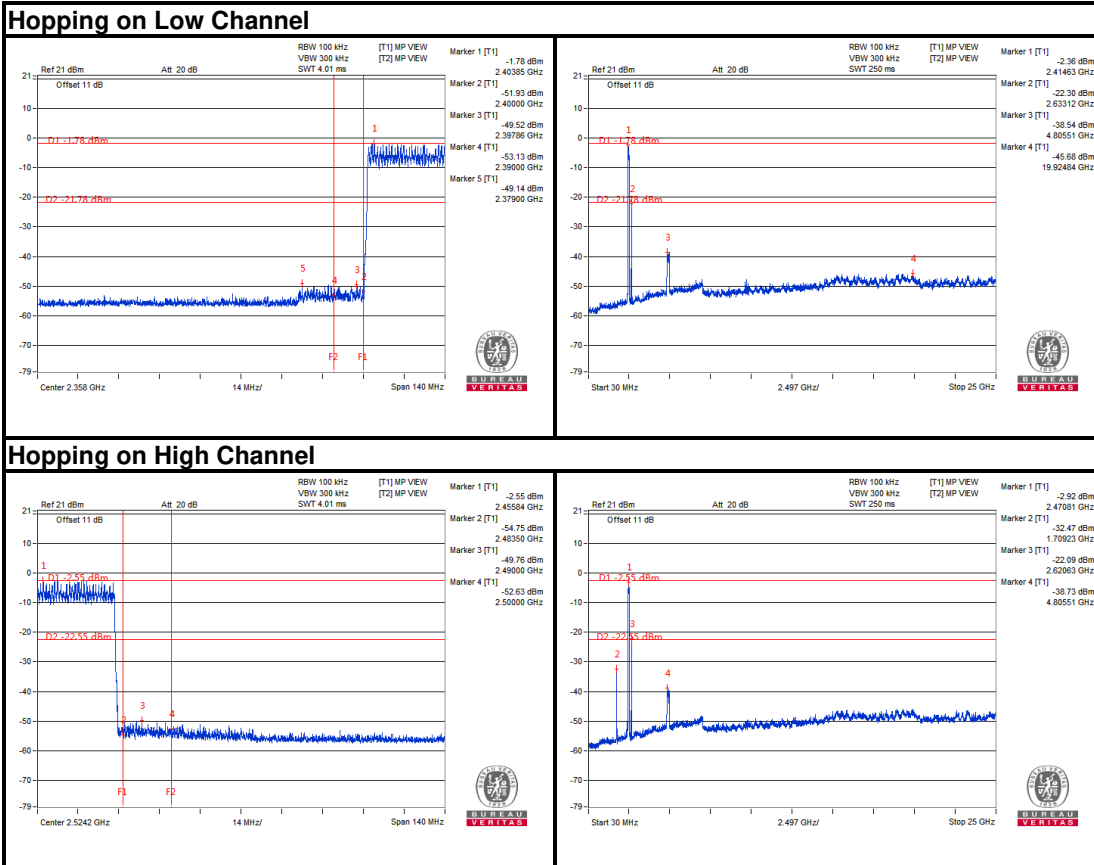

Bureau Veritas Shenzhen Co., Ltd.
Dongguan Branch

No. 96, Guantai Road (Houjie Section), Houjie
Town, Dongguan City, Guangdong Province.
523942, People's Republic of China.

Tel: +86 769 8998 2098
Fax: +86 769 8593 1080
Email: customerservice.dg@bureauveritas.com



Test Report No.: RF2404WDG0026

5 PHOTOGRAPHS OF THE TEST CONFIGURATION

Please refer to the attached file (Test Setup Photo).



Test Report No.: RF2404WDG0026

6 APPENDIX A - MODIFICATIONS RECORDERS FOR ENGINEERING CHANGES TO THE EUT BY THE LAB

No any modifications are made to the EUT by the lab during the test.

---END---