



# MEASUREMENT REPORT

## FCC PART 15.247 WLAN 802.11b/g/n

---

**FCC ID:** 2AAA6-S950

**APPLICANT:** SENWA MEXICO,S.A.DE C.V

**Application Type:** Certification

**Product:** Smart Phone

**Model No.:** S950

**Brand Name:** SENWA

**FCC Classification:** Digital Transmission System (DTS)

**FCC Rule Part(s):** Part 15.247

**Test Procedure(s):** ANSI C63.10-2009, KDB 558074 D01v03r01

**Test Date:** March 27 ~ April 05, 2014

Reviewed By : Robin Wu  
( Robin Wu )

Approved By : Marlin Chen  
( Marlin Chen )

The test results relate only to the samples tested.

This equipment has been shown to be capable of compliance with the applicable technical standards as indicated in the measurement report and was tested in accordance with the measurement procedures specified in KDB 558074 D01v03r01. Test results reported herein relate only to the item(s) tested.

The test report shall not be reproduced except in full without the written approval of MRT Technology (Suzhou) Co., Ltd.

## Revision History

Report No.	Version	Description	Issue Date
1403RSU01202	Rev. 01	Initial report	04-11-2014

# CONTENTS

Description	Page
<b>§2.1033 General Information .....</b>	<b>5</b>
<b>1. INTRODUCTION .....</b>	<b>6</b>
1.1. Scope .....	6
1.2. MRT Test Location .....	6
<b>2. PRODUCT INFORMATION .....</b>	<b>7</b>
2.1. Equipment Description.....	7
2.2. Device Capabilities .....	8
2.3. Test Configuration .....	8
2.4. EMI Suppression Device(s)/Modifications.....	8
2.5. Labeling Requirements.....	8
2.6. Test Software .....	8
<b>3. DESCRIPTION OF TEST .....</b>	<b>9</b>
3.1. Evaluation Procedure .....	9
3.2. AC Line Conducted Emissions .....	9
3.3. Radiated Emissions.....	10
<b>4. ANTENNA REQUIREMENTS.....</b>	<b>11</b>
<b>5. TEST EQUIPMENT CALIBRATION DATA .....</b>	<b>12</b>
<b>6. MEASUREMENT UNCERTAINTY.....</b>	<b>13</b>
<b>7. TEST RESULT .....</b>	<b>14</b>
7.1. Summary .....	14
7.2. 6dB Bandwidth Measurement.....	15
7.2.1. Test Limit .....	15
7.2.2. Test Procedure used.....	15
7.2.3. Test Setting.....	15
7.2.4. Test Setup.....	15
7.2.5. Test Result.....	16
7.3. Output Power Measurement.....	20
7.3.1. Test Limit .....	20
7.3.2. Test Procedure Used .....	20
7.3.3. Test Setting.....	20
7.3.4. Test Setup.....	20
7.3.5. Test Result of Output Power .....	21
7.4. Power Spectral Density Measurement .....	23

---

7.4.1.	Test Limit .....	23
7.4.2.	Test Procedure Used .....	23
7.4.3.	Test Setting.....	23
7.4.4.	Test Setup.....	23
7.4.5.	Test Result.....	24
7.5.	Conducted Band Edge and Out-of-Band Emissions.....	28
7.5.1.	Test Limit .....	28
7.5.2.	Test Procedure Used .....	28
7.5.3.	Test Setting.....	28
7.5.4.	Test Setup.....	28
7.5.5.	Test Result.....	29
7.6.	Radiated Spurious Emission Measurement .....	38
7.6.1.	Test Limit .....	38
7.6.2.	Test Procedure Used .....	38
7.6.3.	Test Setting.....	38
7.6.4.	Test Setup.....	39
7.6.5.	Test Result.....	41
7.7.	Radiated Restricted Band Edge Measurement .....	48
7.7.1.	Test Result.....	48
7.8.	AC Conducted Emissions Measurement.....	56
7.8.1.	Test Limit .....	56
7.8.2.	Test Setup.....	56
7.8.3.	Test Result.....	57
<b>8.</b>	<b>CONCLUSION.....</b>	<b>59</b>

## §2.1033 General Information

<b>Applicant:</b>	SENAWA MEXICO,S.A.DE C.V
<b>Applicant Address:</b>	Av. Javier Barros Sierra 540,Torre I, Planta 5; COL. LOMAS DE SANTA FE DELEGACION ALVARO OBREGON C.P. 01210 MEXICO, DISTRITO FEDERAL
<b>Manufacturer:</b>	SHEN ZHEN IMO ELECTRONIC TECHENLOGY CO., LTD
<b>Manufacturer Address:</b>	A807 Haisong Building, 9 Tairan Road, Che Kung Temple, Futian District, Shenzhen
<b>Test Site:</b>	MRT Technology (Suzhou) Co., Ltd
<b>Test Site Address:</b>	D8 Building, Youxin Industrial Park, No.2 Tian'edang Rd., Wuzhong Economic Development Zone, Suzhou, China
<b>MRT Registration No.:</b>	809388
<b>FCC Rule Part(s):</b>	Part 15.247
<b>Model No.:</b>	S950
<b>FCC ID:</b>	2AAA6-S950
<b>Test Device Serial No.:</b>	N/A <input type="checkbox"/> Production <input checked="" type="checkbox"/> Pre-Production <input type="checkbox"/> Engineering
<b>FCC Classification:</b>	Digital Transmission System (DTS)
<b>Date(s) of Test:</b>	March 27 ~ April 05, 2014
<b>Test Report S/N:</b>	1403RSU01202

## 1. INTRODUCTION

### 1.1. Scope

Measurement and determination of electromagnetic emissions (EMC) of radio frequency devices including intentional and/or unintentional radiators for compliance with the technical rules and regulations of the Federal Communications Commission and the Industry Canada Certification and Engineering Bureau.

### 1.2. MRT Test Location

The map below shows the location of the MRT LABORATORY, its proximity to the Taihu Lake. These measurement tests were conducted at the MRT Technology (Suzhou) Co., Ltd. Facility located at D8 Building, Youxin Industrial Park, No.2 Tian'edang Rd., Wuzhong Economic Development Zone, Suzhou, China. The detailed description of the measurement facility was found to be in compliance with the requirements of § 2.948 according to ANSI C63.4-2009 on September 30, 2013.



## 2. PRODUCT INFORMATION

### 2.1. Equipment Description

Product Name	Smart Phone
Model No.	S950
Brand Name	SENA
<b>Wi-Fi</b>	
Frequency Range	802.11b/g/n-HT20: 2412 ~ 2462 MHz 802.11n-HT40: 2422 ~ 2452 MHz
Maximum Output Power	802.11b: 20.65dBm 802.11g: 23.61dBm; 802.11n-HT20: 23.37dBm 802.11n-HT40: 22.63dBm
Type of Modulation	802.11b: DSSS 802.11g/n: OFDM
Data Rate	802.11b: 1/2/5.5/11 Mbps 802.11g: 6/9/12/18/24/36/48/54 Mbps 802.11n: up to 135 Mbps
Antenna Type	Internal
Antenna Gain	-1.53dBi

#### Channel List for 802.11b/g/n-HT20

Channel	Frequency	Channel	Frequency	Channel	Frequency
01	2412 MHz	02	2417 MHz	03	2422 MHz
04	2427 MHz	05	2432 MHz	06	2437 MHz
07	2442 MHz	08	2447 MHz	09	2452 MHz
10	2457 MHz	11	2462 MHz	N/A	N/A

#### Channel List for 802.11n-HT40

Channel	Frequency	Channel	Frequency	Channel	Frequency
03	2422 MHz	04	2427 MHz	05	2432 MHz
06	2437 MHz	07	2442 MHz	08	2447 MHz
09	2452 MHz	N/A	N/A	N/A	N/A

## 2.2. Device Capabilities

This device contains the following capabilities:

850/1900 GSM/GPRS/EDGE, 850/1900 WCDMA/HSDPA/HSUPA/HSPA+, 802.11b/g/n WLAN (DTS), Bluetooth (1x, EDR, BLE)

**Note:** 2.4GHz WLAN (DTS) operation is possible in 20MHz, and 40MHz channel bandwidths. The maximum achievable duty cycles for all modes were determined based on measurements performed on a spectrum analyzer in zero-span mode with RBW = 8MHz, VBW = 50MHz, and detector = peak per the guidance of Section 6.0 b) of KDB 558074 D01v03r01. The RBW and VBW were both greater than  $50/T$ , where T is the minimum transmission duration, and the number of sweep points across T was greater than 100. The duty cycles are as follows:

- 802.11b - 100.0%
- 802.11g/n-HT20MHz Bandwidth -100.0%
- 802.11n-HT40MHz Bandwidth -100.0%

## 2.3. Test Configuration

The Smart Phone FCC ID: 2AAA6-S950 was tested per the guidance of KDB 558074 D01v03r01. ANSI C63.10-2009 was used to reference the appropriate EUT setup for radiated spurious emissions testing and AC line conducted testing.

## 2.4. EMI Suppression Device(s)/Modifications

No EMI suppression device(s) were added and/or no modifications were made during testing.

## 2.5. Labeling Requirements

Per 2.1074 & 15.19; Docket 95-19

The label shall be permanently affixed at a conspicuous location on the device; instruction manual or pamphlet supplied to the user and be readily visible to the purchaser at the time of purchase.

However, when the device is so small wherein placement of the label with specified statement is not practical, only the trade name and FCC ID must be displayed on the device per Section 15.19(a)(5).

Please see attachment for FCC ID label and label location.

## 2.6. Test Software

The test utility software used during testing was engineering order by mobile phone.



### 3. DESCRIPTION OF TEST

#### 3.1. Evaluation Procedure

The measurement procedures described in the American National Standard for Testing Unlicensed Wireless Devices (ANSI C63.10-2009), and the guidance provided in KDB 558074 D01v03r01 were used in the measurement of the **Smart Phone FCC ID: 2AAA6-S950**.

**Deviation from measurement procedure.....None**

#### 3.2. AC Line Conducted Emissions

The line-conducted facility is located inside an 8'x4'x4' shielded enclosure. The shielding effectiveness of the shielded room is in accordance with MIL-Std-285. A 1m x 2m wooden table 80cm high is placed 40cm away from the vertical wall and 80cm away from the sidewall of the shielded room. Two 10kHz-30MHz, 50Ω/50uH Line-Impedance Stabilization Networks (LISNs) are bonded to the shielded room floor. Power to the LISNs is filtered by external high-current high-insertion loss power line filters. These filters attenuate ambient signal noise from entering the measurement lines. These filters are also bonded to the shielded enclosure.

The EUT is powered from one LISN and the support equipment is powered from the second LISN. If the EUT is a DC-powered device, power will be derived from the source power supply it normally will be powered from and this supply line(s) will be connected to the second LISN. All interconnecting cables more than 1 meter were shortened to a 1 meter length by non-inductive bundling (serpentine fashion) and draped over the back edge of the test table. All cables were at least 40cm above the horizontal reference ground-plane. Power cables for support equipment were routed down to the second LISN while ensuring that that cables were not draped over the second LISN.

Sufficient time for the EUT, support equipment, and test equipment was allowed in order for them to warm up to their normal operating condition. The RF output of the LISN was connected to the spectrum analyzer and exploratory measurements were made to determine the frequencies producing the maximum emission from the EUT. The spectrum was scanned from 150kHz to 30MHz with a spectrum analyzer. The detector function was set to peak mode for exploratory measurements while the bandwidth of the analyzer was set to 10kHz. The EUT, support equipment, and interconnecting cables were arranged and manipulated to maximize each emission. Each emission was also maximized by varying: power lines, the mode of operation or resolution, clock or data exchange speed, scrolling H pattern to the EUT and/or support equipment whichever determined the worst-case emission. Once the worst case emissions have been identified, the one EUT cable configuration/arrangement and mode of operation that produced these emissions is used for final measurements on the same test site. The analyzer is set to CISPR quasi-peak and average detectors with a 9kHz resolution bandwidth for final measurements.

Line conducted emissions test results are shown in Section 7.8.

### 3.3. Radiated Emissions

The radiated test facilities consisted of an indoor 3 meter semi-anechoic chamber used for final measurements and exploratory measurements, when necessary. The measurement area is contained within the semi-anechoic chamber which is shielded from any ambient interference. For measurements above 1GHz absorbers are arranged on the floor between the turn table and the antenna mast in such a way so as to maximize the reduction of reflections. For measurements below 1GHz, the absorbers are removed. A MF Model 210SS turntable is used for radiated measurement. It is a continuously rotatable, remote controlled, metallic turntable and 2 meters (6.56 ft.) in diameter. The turn table is flush with the raised floor of the chamber in order to maintain its function as a ground plane. An 80cm high PVC support structure is placed on top of the turntable.

For all measurements, the spectrum was scanned through all EUT azimuths and from 1 to 4 meter receive antenna height using a broadband antenna from 30MHz up to the upper frequency shown in 15.33(b)(1) depending on the highest frequency generated or used in the device or on which the device operates or tunes. For frequencies above 1GHz, linearly polarized double ridge horn antennas were used. For frequencies below 30MHz, a calibrated loop antenna was used. When exploratory measurements were necessary, they were performed at 1 meter test distance inside the semi-anechoic chamber using broadband antennas, broadband amplifiers, and spectrum analyzers to determine the frequencies and modes producing the maximum emissions. Sufficient time for the EUT, support equipment, and test equipment was allowed in order for them to warm up to their normal operating condition. The test set-up was placed on top of the 0.8 meter high, 1 x 1.5 meter table. The EUT, support equipment, and interconnecting cables were arranged and manipulated to maximize each emission. Appropriate precaution was taken to ensure that all emissions from the EUT were maximized and investigated. The system configuration, clock speed, mode of operation or video resolution, if applicable, turntable azimuth, and receive antenna height was noted for each frequency found.

Final measurements were made in the semi-anechoic chamber using calibrated, linearly polarized broadband and horn antennas. The test setup was configured to the setup that produced the worst case emissions. The spectrum analyzer was set to investigate all frequencies required for testing to compare the highest radiated disturbances with respect to the specified limits. The turntable containing the EUT was rotated through 360 degrees and the height of the receive antenna was varied 1 to 4 meters and stopped at the azimuth and height producing the maximum emission. Each emission was maximized by changing the orientation of the EUT through three orthogonal planes and changing the polarity of the receive antenna, whichever produced the worst-case emissions. According to 3dB BeamWidth of horn antenna, the horn antenna should be always directed to the EUT when rising height.

#### 4. ANTENNA REQUIREMENTS

**Excerpt from §15.203 of the FCC Rules/Regulations:**

“An intentional radiator antenna shall be designed to ensure that no antenna other than that furnished by the responsible party can be used with the device. The use of a permanently attached antenna or of an antenna that uses a unique coupling to the intentional radiator shall be considered sufficient to comply with the provisions of this section.”

- The antenna of the Smart Phone is **permanently attached**.
- There are no provisions for connection to an external antenna.

**Conclusion:**

The **Smart Phone FCC ID: 2AAA6-S950** unit complies with the requirement of §15.203.

## 5. TEST EQUIPMENT CALIBRATION DATA

### Conducted Emissions

Instrument	Manufacturer	Type No.	Serial No.	Cali. Interval	Cali. Due Date
EMI Test Receiver	R&S	ESR7	101209	1 year	2014/11/08
Two-Line V-Network	R&S	ENV216	101683	1 year	2014/11/08
Two-Line V-Network	R&S	ENV216	101684	1 year	2014/11/08
Temperature/ Meter Humidity	Anymetre	TH101B	SR2-01	1 year	2014/11/15

### Radiated Emission

Instrument	Manufacturer	Type No.	Serial No.	Cali. Interval	Cali. Due Date
Spectrum Analyzer	Agilent	E4447A	MY45300136	1 year	2014/11/08
Preamplifier	MRT	AP01G18	1310002	1 year	2014/10/07
Preamplifier	MRT	AP18G40	1310003	1 year	2014/10/07
Loop Antenna	Schwarzbeck	FMZB1519	1519-041	1 year	2014/11/24
TRILOG Antenna	Schwarzbeck	VULB9162	9162-047	1 year	2014/11/24
Broad-Band Horn Antenna	Schwarzbeck	BBHA9120D	9120D-1167	1 year	2014/11/24
Broadband Horn Antenna	Schwarzbeck	BBHA9170	9170-549	1 year	2014/12/11
Temperature/Humidity Meter	Anymetre	TH101B	AC1-01	1 year	2014/11/15

### Conducted Test Equipment

Instrument	Manufacturer	Type No.	Serial No.	Cali. Interval	Cali. Due Date
Spectrum Analyzer	Agilent	N9010A	MY5144016A	1 year	2015/01/04
Power Sensor	Agilent	U2021XA	MY52450003	1 year	2014/12/14
Temperature/Humidity Meter	Anymetre	TH101B	TR3-01	1 year	2014/11/15

## 6. MEASUREMENT UNCERTAINTY

Where relevant, the following test uncertainty levels have been estimated for tests performed on the EUT as specified in CISPR 16-4-2. This uncertainty represents an expanded uncertainty expressed at approximately the 95% confidence level using a coverage factor of  $k = 2$ .

AC Conducted Emission Measurement
Measuring Uncertainty for a Level of Confidence of 95% ( $U=2Uc(y)$ ): 150kHz~30MHz: $\pm 3.46\text{dB}$
Radiated Emission Measurement
Measuring Uncertainty for a Level of Confidence of 95% ( $U=2Uc(y)$ ): 9kHz ~ 1GHz: $\pm 4.18\text{dB}$ 1GHz ~ 40GHz: $\pm 4.76\text{dB}$

## 7. TEST RESULT

### 7.1. Summary

**Company Name:** SENWA MEXICO,S.A.DE C.V  
**FCC ID:** 2AAA6-S950  
**FCC Classification:** Digital Transmission System (DTS)  
**Data Rate(s) Tested:** 1Mbps ~ 11Mbps (b); 6Mbps ~ 54Mbps (g);  
6.5/7.2Mbps ~ 65/72.2Mbps (n - HT20);  
13.5/15Mbps ~ 135/150Mbps (n - HT40)

FCC Part Section(s)	Test Description	Test Limit	Test Condition	Test Result	Reference
15.247(a)(2)	6dB Bandwidth	$\geq 500\text{kHz}$	Conducted	Pass	Section 7.2
15.247(b)(3)	Output Power	$\leq 1\text{Watt}$		Pass	Section 7.3
15.247(e)	Power Spectral Density	$\leq 8\text{dBm} / 3\text{kHz Band}$		Pass	Section 7.4
15.247(d)	Band Edge / Out-of-Band Emissions	$\geq 20\text{dBc(Peak)}$		Pass	Section 7.5
15.205 15.209	General Field Strength Limits (Restricted Bands and Radiated Emission Limits)	Emissions in restricted bands must meet the radiated limits detailed in 15.209	Radiated	Pass	Section 7.6 & 7.7
15.207	AC Conducted Emissions 150kHz - 30MHz	$< \text{FCC 15.207 limits}$	Line Conducted	Pass	Section 7.8

#### Notes:

- 1) All modes of operation and data rates were investigated. The test results shown in the following sections represent the worst case emissions.
- 2) The analyzer plots shown in this section were all taken with a correction table loaded into the analyzer. The correction table was used to account for the losses of the cables and attenuators used as part of the system to connect the EUT to the analyzer at all frequencies of interest.
- 3) All antenna port conducted emissions testing was performed on a test bench with the antenna port of the EUT connected to the spectrum analyzer through calibrated cables and attenuators.

## 7.2. 6dB Bandwidth Measurement

### 7.2.1. Test Limit

The minimum 6dB bandwidth shall be at least 500 kHz.

### 7.2.2. Test Procedure used

KDB 558074 D01v03r01 – Section 8.2 Option 2

### 7.2.3. Test Setting

1. The Spectrum's automatic bandwidth measurement capability was used to perform the 6dB bandwidth measurement. The "X" dB bandwidth parameter was set to  $X = 6$ . The bandwidth measurement was not influenced by any intermediate power nulls in the fundamental emission.
2. Set RBW = 100 kHz
3. VBW  $\geq 3 \times$  RBW
4. Detector = Peak
5. Trace mode = max hold
6. Sweep = auto couple
7. Allow the trace was allowed to stabilize

### 7.2.4. Test Setup

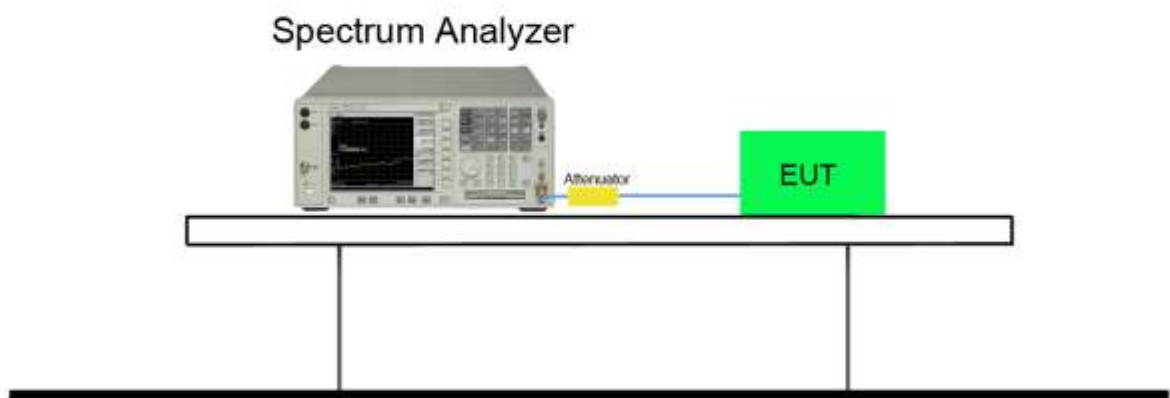

**7.2.5. Test Result**

Test Mode	Data Rate (Mbps)	Channel No.	Frequency (MHz)	6dB Bandwidth (MHz)	Limit (MHz)	Result
802.11b	1	01	2412	9.15	≥0.5	Pass
802.11b	1	06	2437	9.15	≥0.5	Pass
802.11b	1	11	2462	9.14	≥0.5	Pass
802.11g	6	01	2412	16.40	≥0.5	Pass
802.11g	6	06	2437	16.38	≥0.5	Pass
802.11g	6	11	2462	16.39	≥0.5	Pass
802.11n-HT20	6.5/7.2	01	2412	17.63	≥0.5	Pass
802.11n-HT20	6.5/7.2	06	2437	17.61	≥0.5	Pass
802.11n-HT20	6.5/7.2	11	2462	17.61	≥0.5	Pass
802.11n-HT40	13.5/15	03	2422	36.37	≥0.5	Pass
802.11n-HT40	13.5/15	06	2437	36.36	≥0.5	Pass
802.11n-HT40	13.5/15	09	2452	36.36	≥0.5	Pass

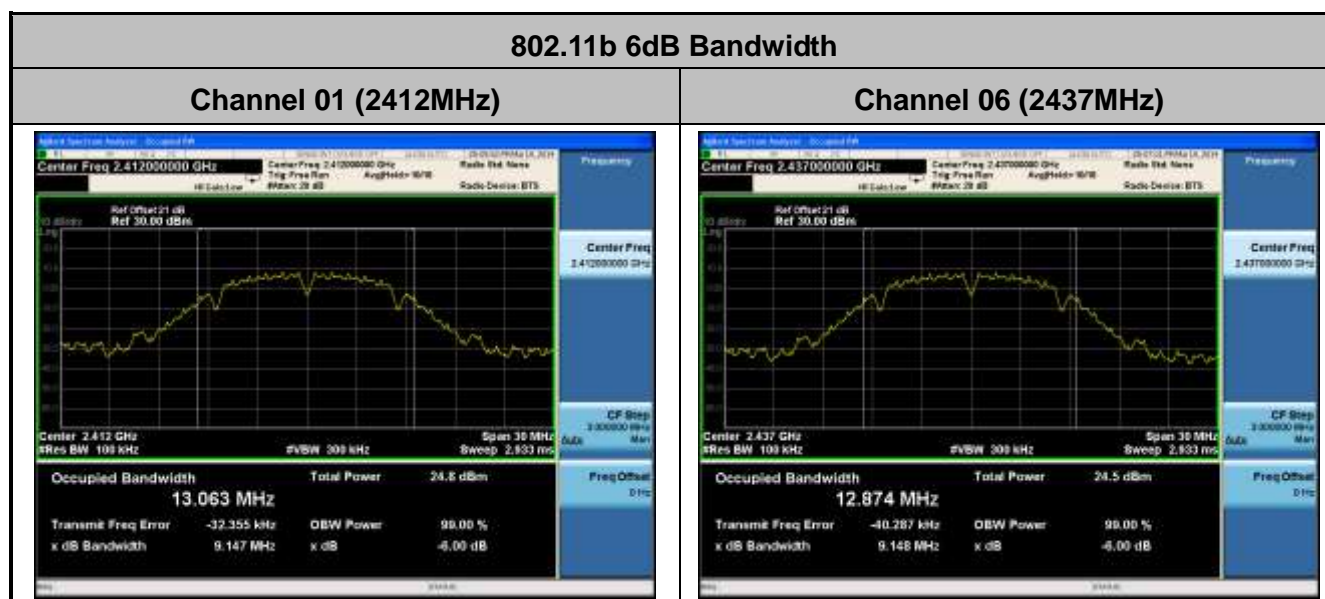



**Channel 11 (2462MHz)**



**802.11g 6dB Bandwidth**

**Channel 01 (2412MHz)**



**Channel 06 (2437MHz)**

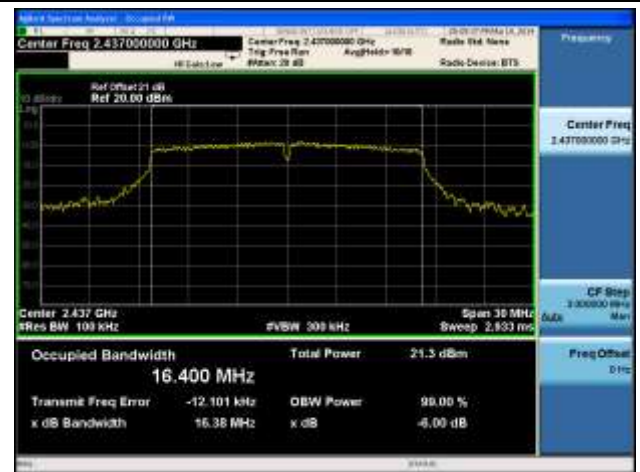

**Channel 11 (2462MHz)**

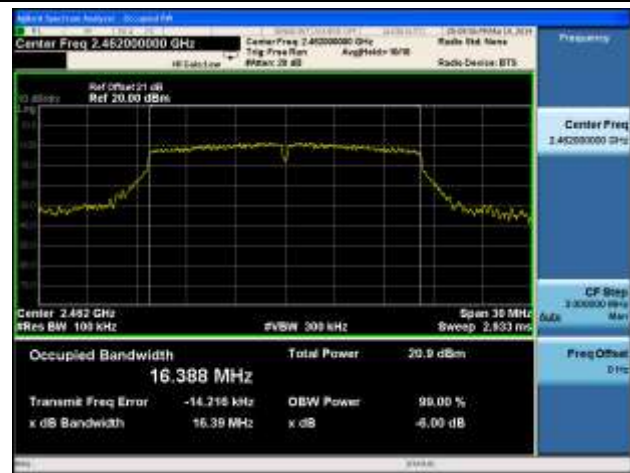

**802.11n-HT20 6dB Bandwidth**

**Channel 01 (2412MHz)**

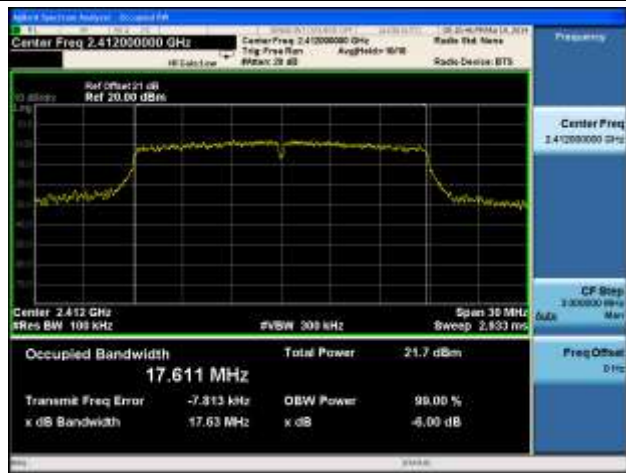

**Channel 06 (2437MHz)**



**Channel 11 (2462MHz)**

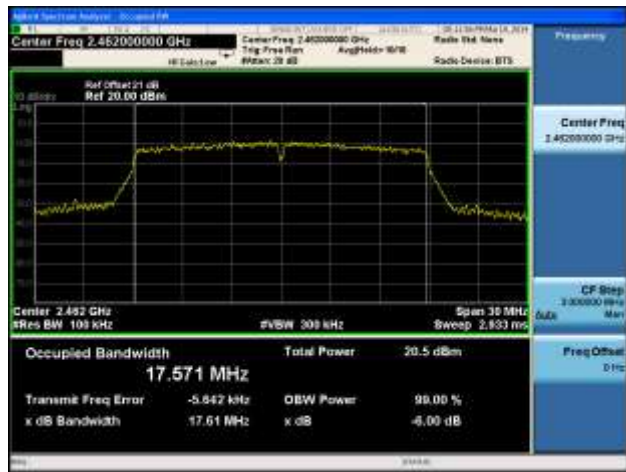

**802.11n-HT40 6dB Bandwidth**

**Channel 03 (2422MHz)**

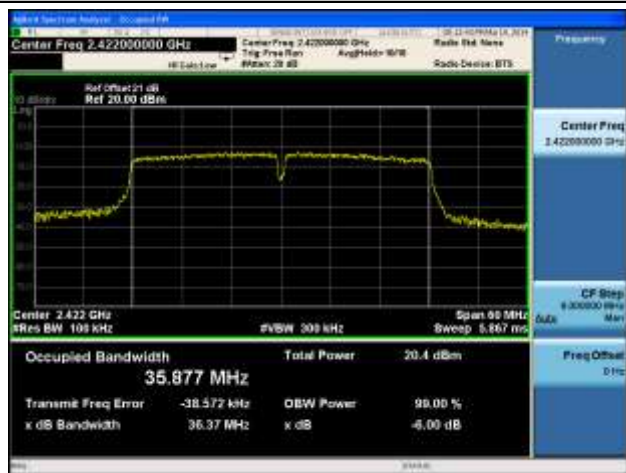

**Channel 06 (2437MHz)**

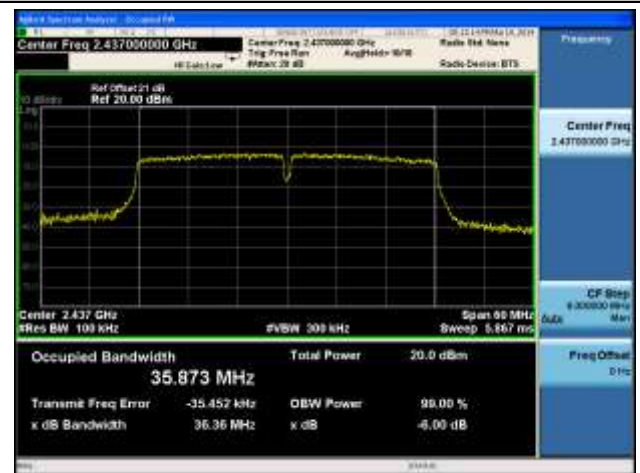

**Channel 09 (2452MHz)**

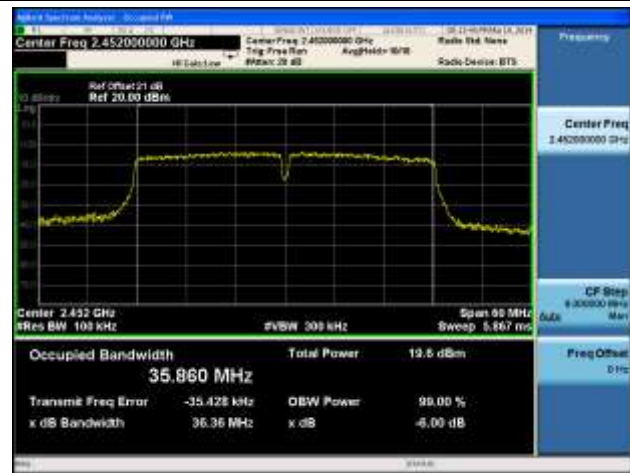

### 7.3. Output Power Measurement

#### 7.3.1. Test Limit

The maximum out power shall be less 1 Watt (30dBm).

#### 7.3.2. Test Procedure Used

KDB 558074 D01v03r01 - Section 9.1.3 PKPM1 Peak Power Method (for signals with BW  $\leq$  50MHz)

#### 7.3.3. Test Setting

##### Method PKPM1 (Peak Power Measurement of Signals with DTS BW $\leq$ 50MHz)

Peak power measurements were performed only when the EUT was transmitting at its maximum power control level using a broadband power meter with a pulse sensor. The pulse sensor employs a VBW = 50MHz so this method was only used for signals whose DTS bandwidth was less than or equal to 50MHz.

#### 7.3.4. Test Setup

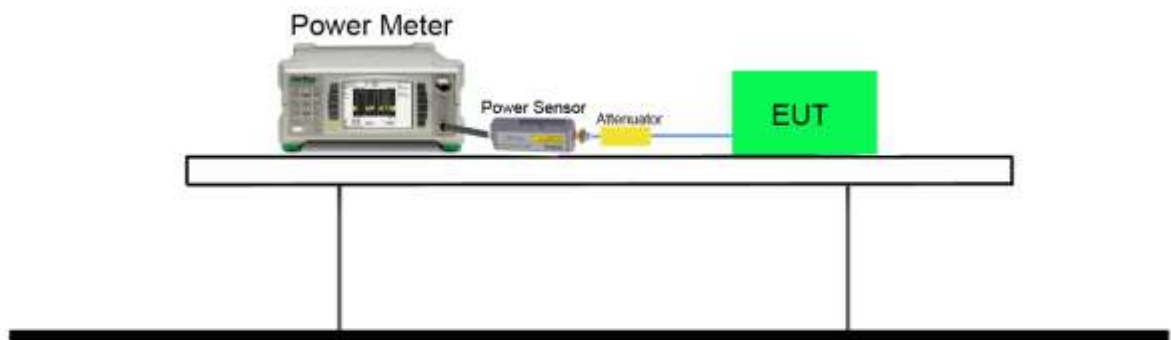

### 7.3.5. Test Result of Output Power

Output power at various data rates:

Test Mode	Bandwidth (MHz)	Channel No.	Frequency (MHz)	Data Rate (Mbps)	Peak Power (dBm)
802.11b	20	6	2437	1	20.37
				5.5	20.28
				11	20.11
802.11g	20	6	2437	6	23.41
				24	23.20
				54	23.05
802.11n	20	6	2437	6.5/7.2(MCS0)	23.37
				39/43.3(MCS4)	23.30
				65/72.2(MCS7)	22.24
802.11n	40	6	2437	13.5/15(MCS0)	22.63
				81/90(MCS4)	22.57
				135/150(MCS7)	22.48

### Test Result of Peak Output Power

Test Mode	Data Rate (Mbps)	Channel No.	Frequency (MHz)	Peak Power (dBm)	Limit (dBm)	Result
11b	1	1	2412	20.65	≤30	Pass
11b	1	6	2437	20.37	≤30	Pass
11b	1	11	2462	19.95	≤30	Pass
11g	6	1	2412	23.29	≤30	Pass
11g	6	6	2437	23.41	≤30	Pass
11g	6	11	2462	23.61	≤30	Pass
11n-HT20	6.5/7.2	1	2412	23.17	≤30	Pass
11n-HT20	6.5/7.2	6	2437	23.37	≤30	Pass
11n-HT20	6.5/7.2	11	2462	23.07	≤30	Pass
11n-HT40	13.5/15	3	2422	22.60	≤30	Pass
11n-HT40	13.5/15	6	2437	22.63	≤30	Pass
11n-HT40	13.5/15	9	2452	22.22	≤30	Pass

**Test Result of Average Output Power (Reporting Only)**

Test Mode	Data Rate (Mbps)	Channel No.	Frequency (MHz)	Average Power (dBm)	Limit (dBm)	Result
11b	1	1	2412	17.93	≤30	Pass
11b	1	6	2437	17.54	≤30	Pass
11b	1	11	2462	16.94	≤30	Pass
11g	6	1	2412	15.84	≤30	Pass
11g	6	6	2437	15.54	≤30	Pass
11g	6	11	2462	14.84	≤30	Pass
11n-HT20	6.5/7.2	1	2412	15.60	≤30	Pass
11n-HT20	6.5/7.2	6	2437	15.05	≤30	Pass
11n-HT20	6.5/7.2	11	2462	14.58	≤30	Pass
11n-HT40	13.5/15	3	2422	14.12	≤30	Pass
11n-HT40	13.5/15	6	2437	13.77	≤30	Pass
11n-HT40	13.5/15	9	2452	13.58	≤30	Pass

## 7.4. Power Spectral Density Measurement

### 7.4.1. Test Limit

The maximum permissible power spectral density is 8 dBm in any 3 kHz band.

### 7.4.2. Test Procedure Used

KDB 558074 D01v03r01 - Section 10.2 Method PKPSD

### 7.4.3. Test Setting

1. Analyzer was set to the center frequency of the DTS channel under investigation
2. Span = 1.5 times the DTS channel bandwidth
3. RBW = 3kHz
4. VBW = 10kHz
5. Detector = peak
6. Sweep time = auto couple
7. Trace mode = max hold
8. Trace was allowed to stabilize

### 7.4.4. Test Setup

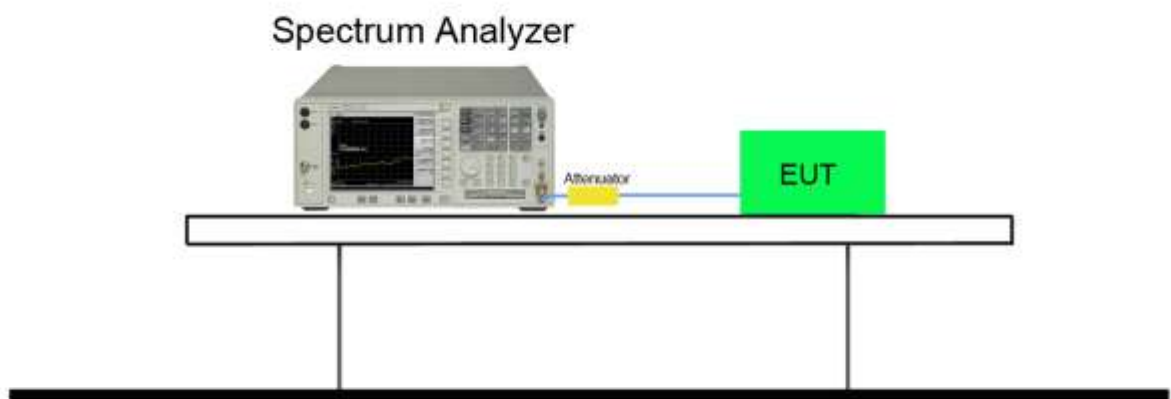

**7.4.5. Test Result**

Test Mode	Data Rate (Mbps)	Channel No.	Frequency (MHz)	PSD Result (dBm)	Limit (dBm / 3kHz)	Result
11b	1	1	2412	-11.01	≤8	Pass
11b	1	6	2437	-11.30	≤8	Pass
11b	1	11	2462	-11.49	≤8	Pass
11g	6	1	2412	-11.26	≤8	Pass
11g	6	6	2437	-11.87	≤8	Pass
11g	6	11	2462	-12.54	≤8	Pass
11n-HT20	6.5/7.2	1	2412	-11.85	≤8	Pass
11n-HT20	6.5/7.2	6	2437	-12.43	≤8	Pass
11n-HT20	6.5/7.2	11	2462	-12.59	≤8	Pass
11n-HT40	13.5/15	3	2422	-14.07	≤8	Pass
11n-HT40	13.5/15	6	2437	-15.19	≤8	Pass
11n-HT40	13.5/15	9	2452	-15.23	≤8	Pass

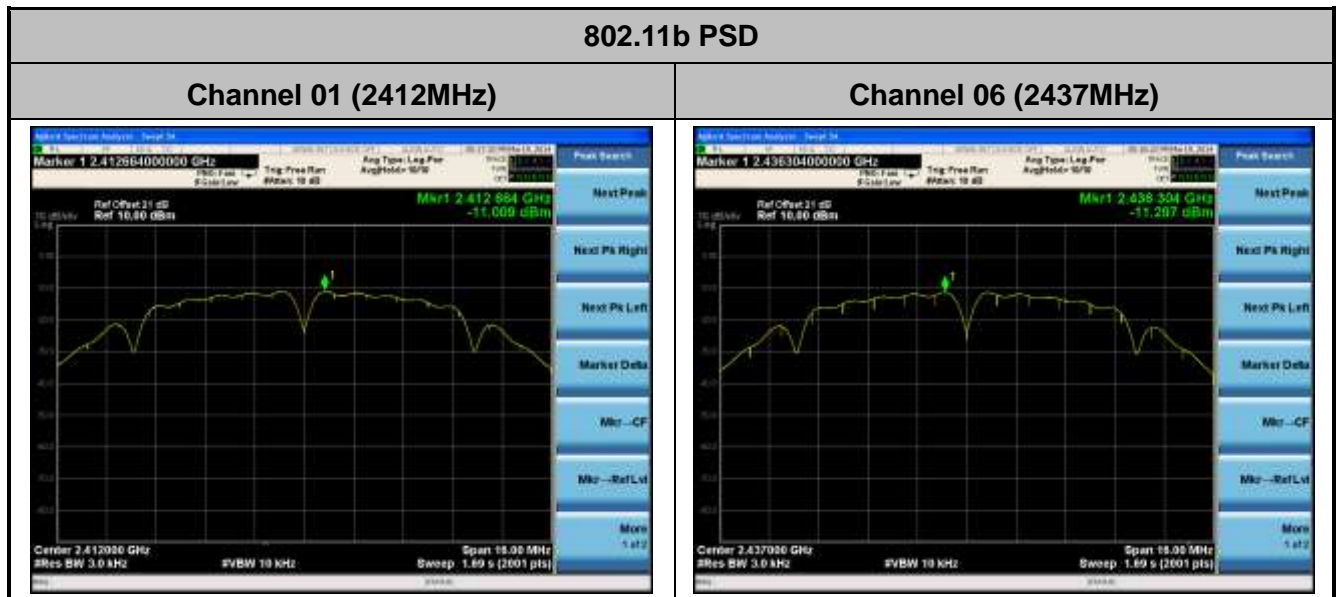



**Channel 11 (2462MHz)**



**802.11g PSD**

**Channel 01 (2412MHz)**

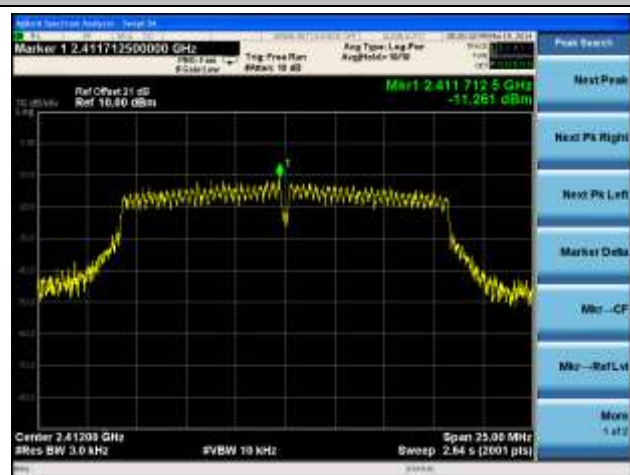

**Channel 06 (2437MHz)**

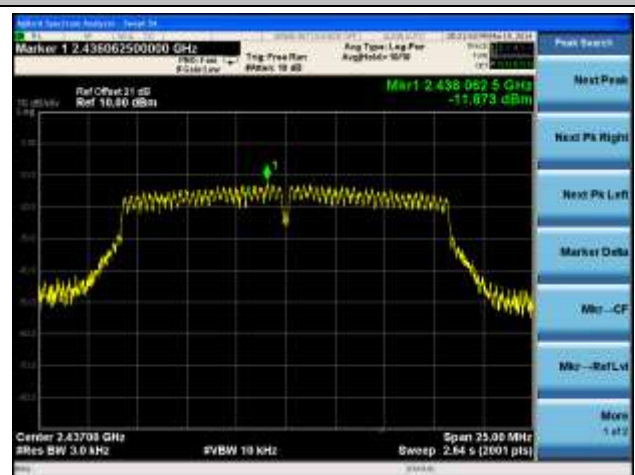

**Channel 11 (2462MHz)**

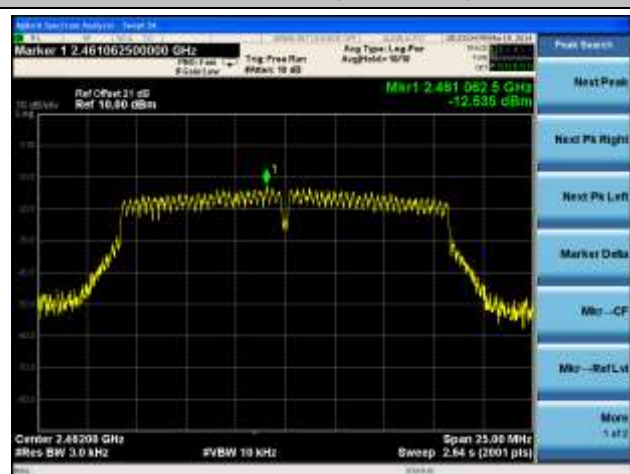

802.11n-HT20 PSD

Channel 01 (2412MHz)

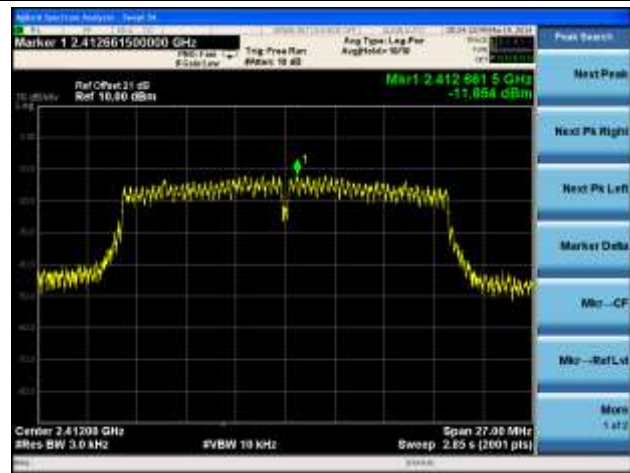

Channel 06 (2437MHz)

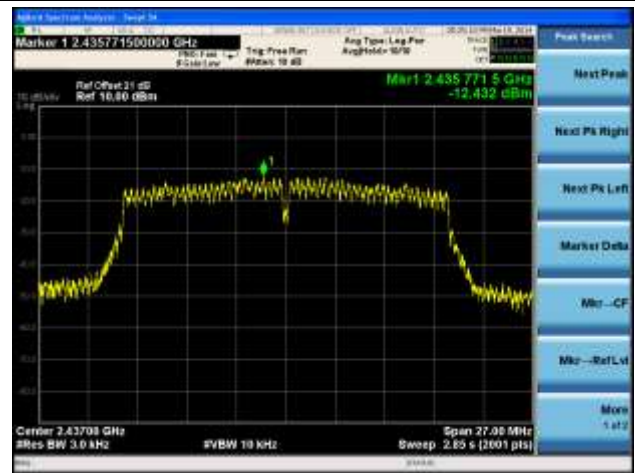

Channel 11 (2462MHz)

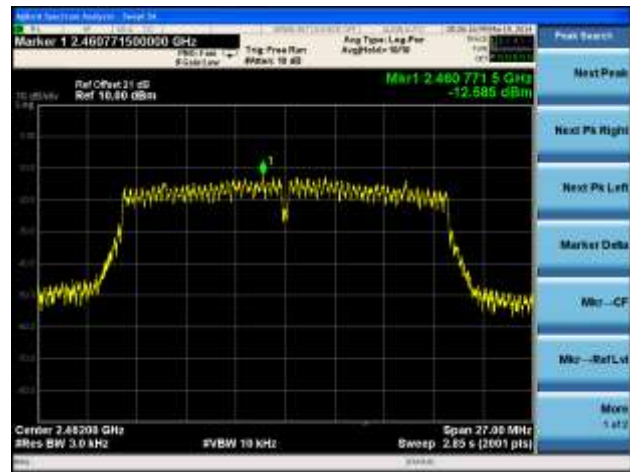

802.11n-HT40 PSD

Channel 03 (2422MHz)

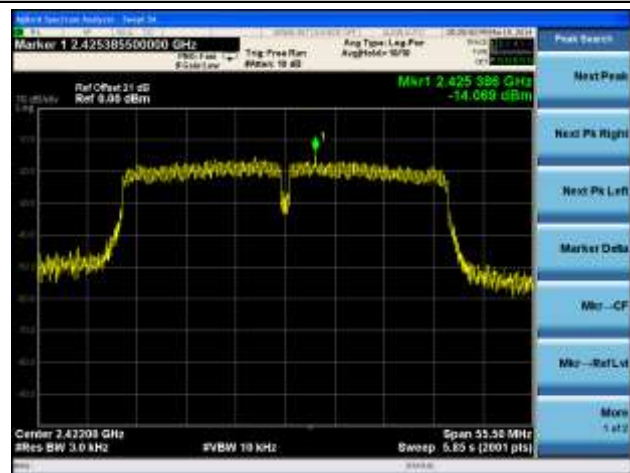

Channel 06 (2437MHz)

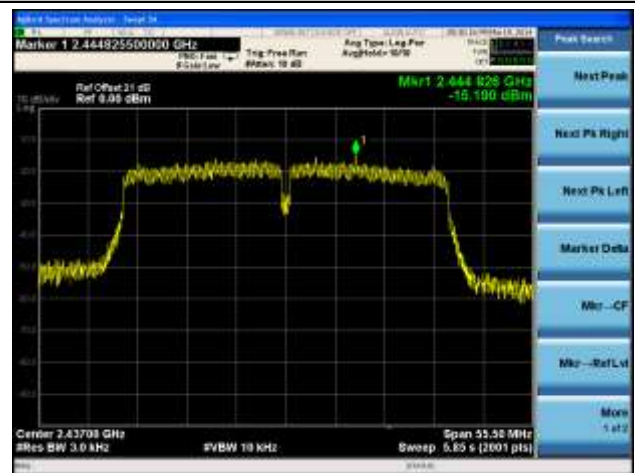

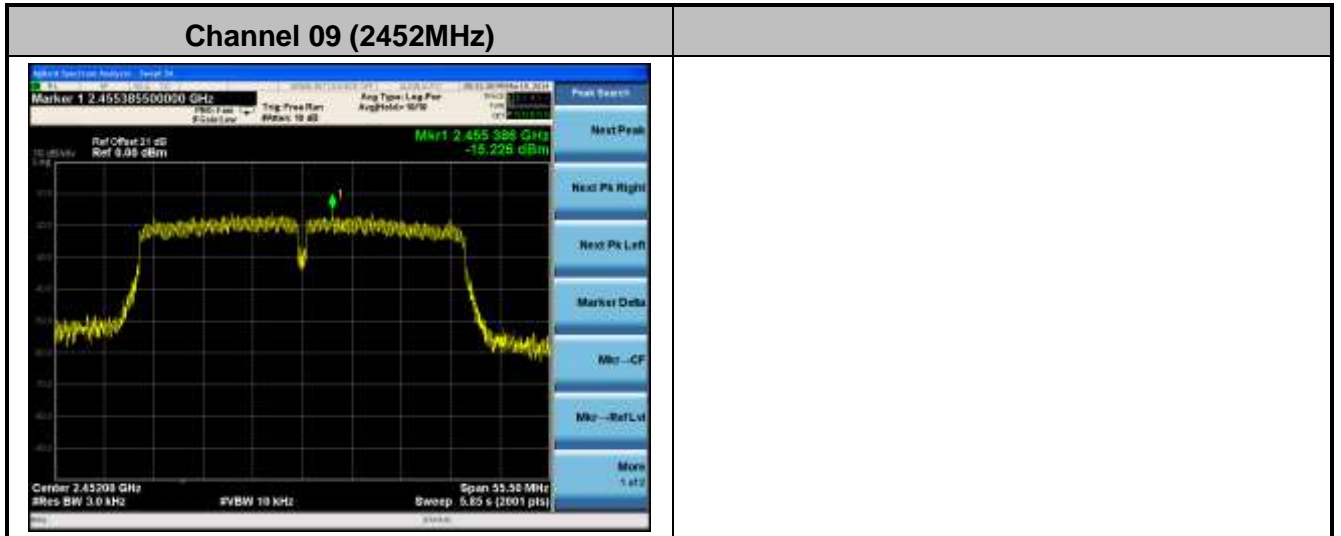

## 7.5. Conducted Band Edge and Out-of-Band Emissions

### 7.5.1. Test Limit

The limit for out-of-band spurious emissions at the band edge is 20dB below the fundamental emission level, as determined from the in-band power measurement of the DTS channel performed in a 100kHz bandwidth per the PSD procedure (Section 9.1).

### 7.5.2. Test Procedure Used

KDB 558074 D01v03r01 – Section 11.3

### 7.5.3. Test Setting

1. Set the center frequency and span to encompass frequency range to be measured
2. RBW = 100kHz
3. VBW = 300kHz
4. Detector = Peak
5. Number of sweep points  $\geq 2 \times \text{Span}/\text{RBW}$
6. Trace mode = max hold
7. Sweep time = auto couple
8. The trace was allowed to stabilize

### 7.5.4. Test Setup

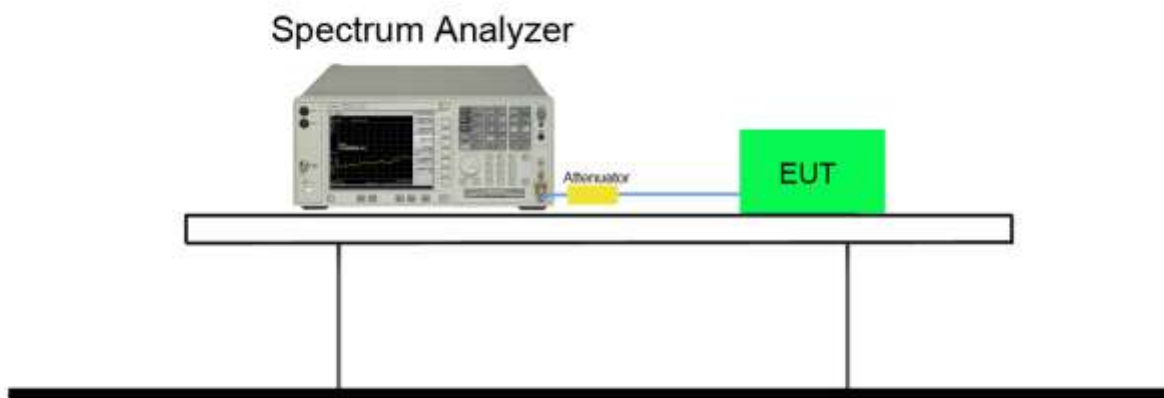

### 7.5.5. Test Result

Test Mode	Data Rate	Channel No.	Frequency (MHz)	Limit	Result
802.11b	1Mbps	01	2412	20dBc	Pass
802.11b	1Mbps	06	2437	20dBc	Pass
802.11b	1Mbps	11	2462	20dBc	Pass
802.11g	6Mbps	01	2412	20dBc	Pass
802.11g	6Mbps	06	2437	20dBc	Pass
802.11g	6Mbps	11	2462	20dBc	Pass
802.11n-HT20	6.5/7.2Mbps	01	2412	20dBc	Pass
802.11n-HT20	6.5/7.2Mbps	06	2437	20dBc	Pass
802.11n-HT20	6.5/7.2Mbps	11	2462	20dBc	Pass
802.11n-HT40	13.5/15Mbps	03	2422	20dBc	Pass
802.11n-HT40	13.5/15Mbps	06	2437	20dBc	Pass
802.11n-HT40	13.5/15Mbps	09	2452	20dBc	Pass

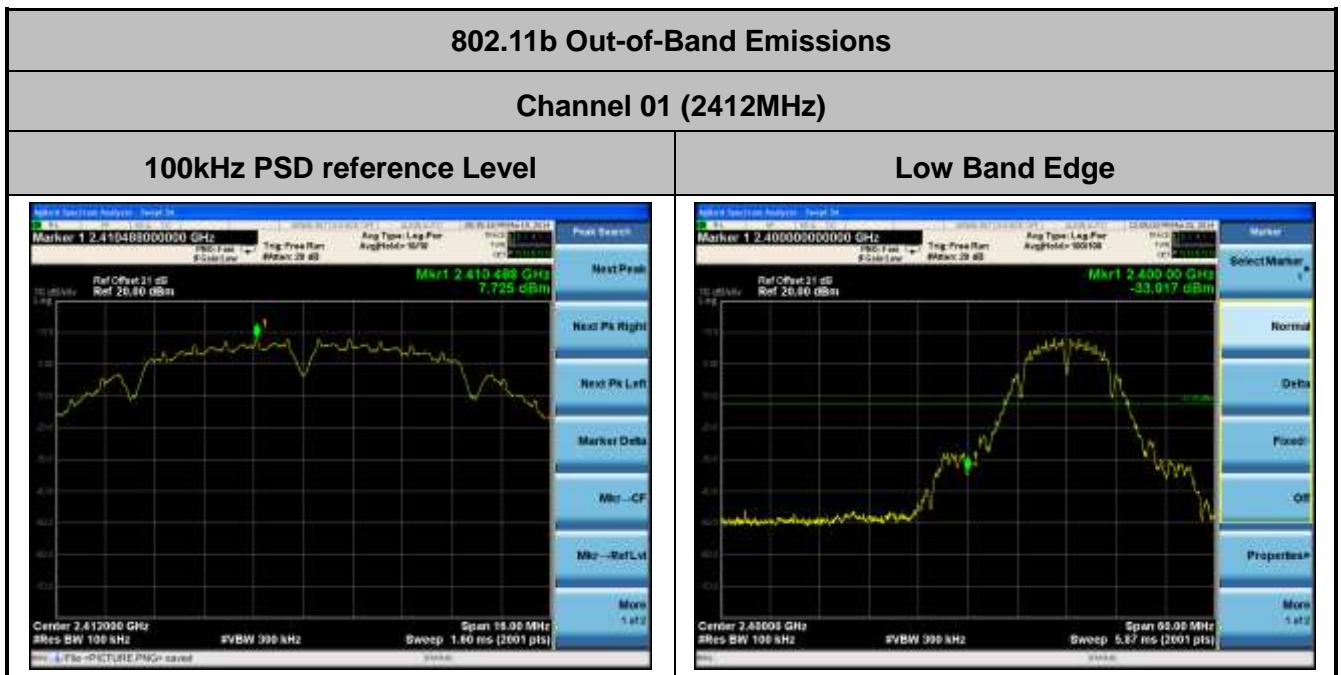

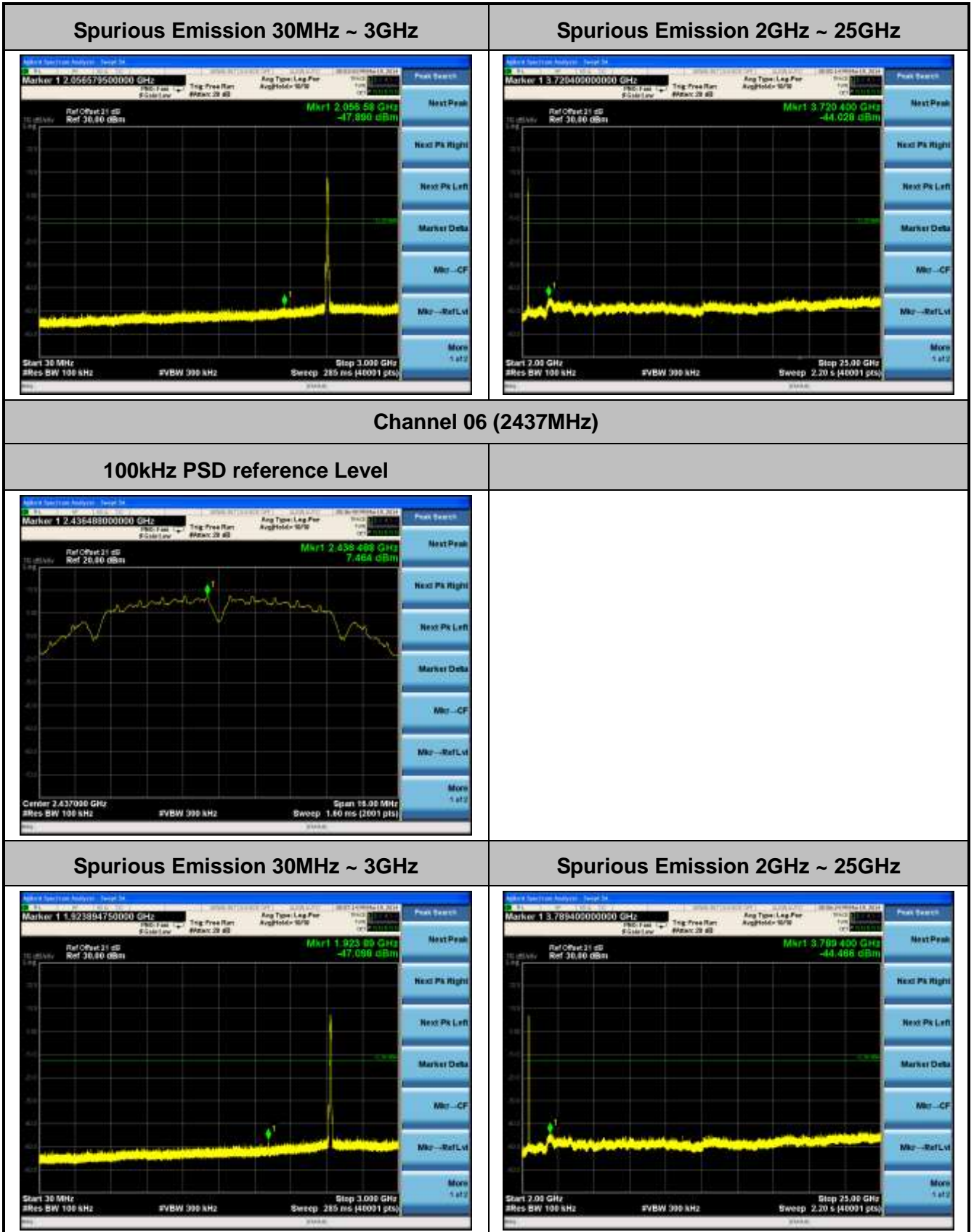

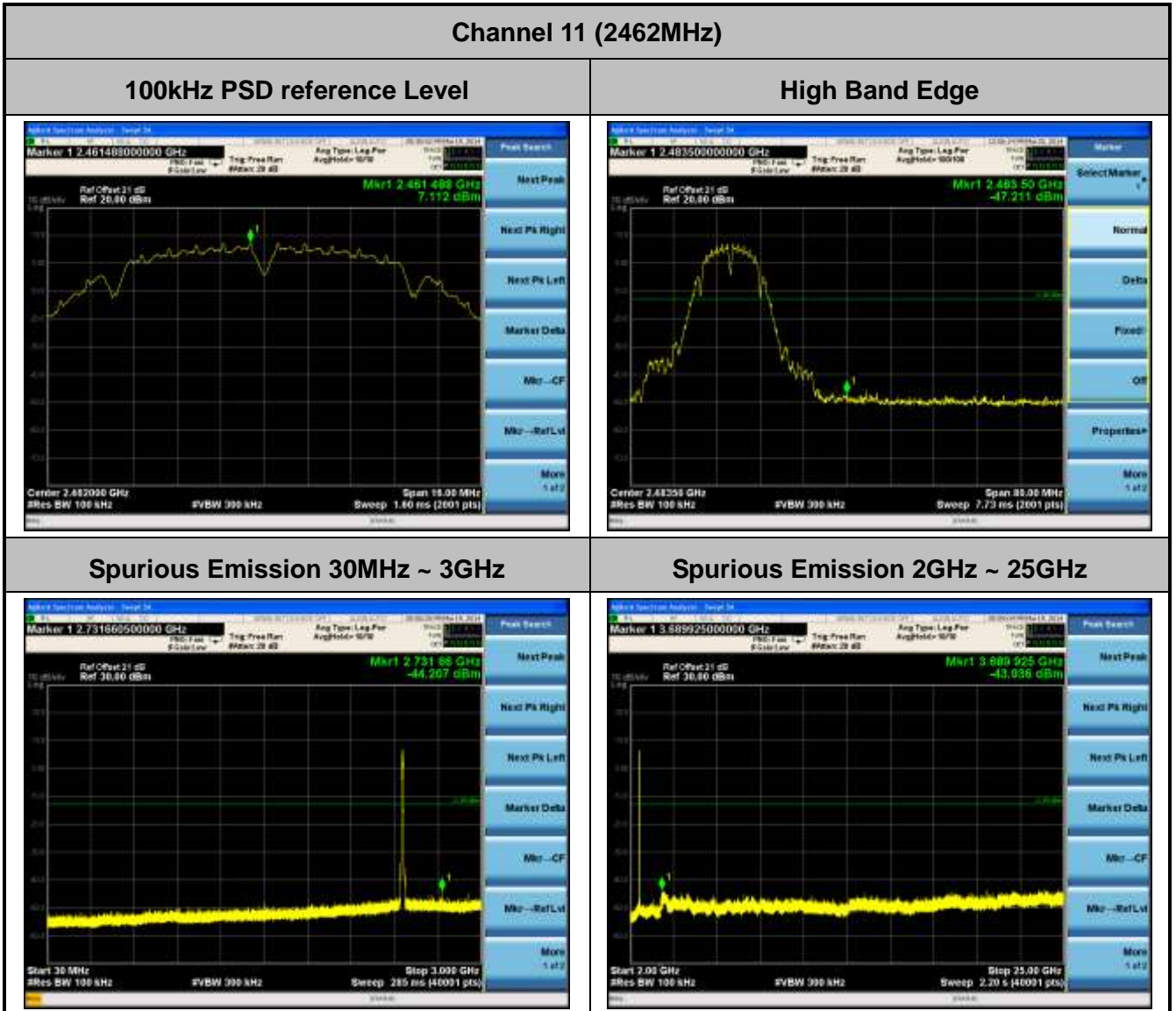

### 802.11g Out-of-Band Emissions

#### Channel 01 (2412MHz)

##### 100kHz PSD reference Level

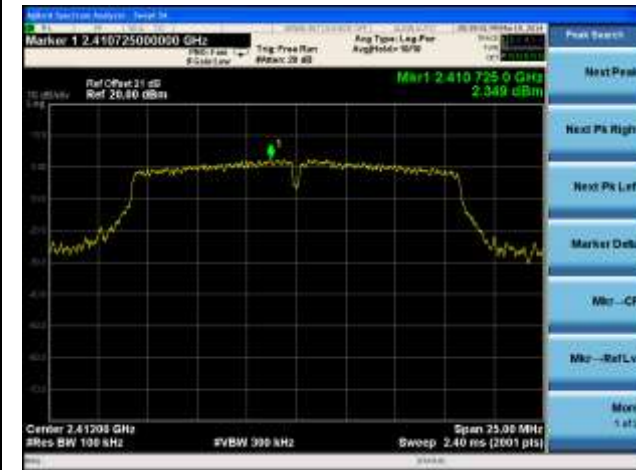

##### Low Band Edge



##### Spurious Emission 30MHz ~ 3GHz

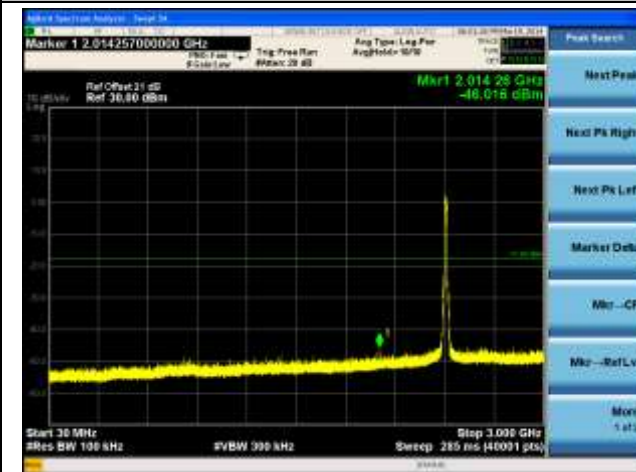

##### Spurious Emission 2GHz ~ 25GHz

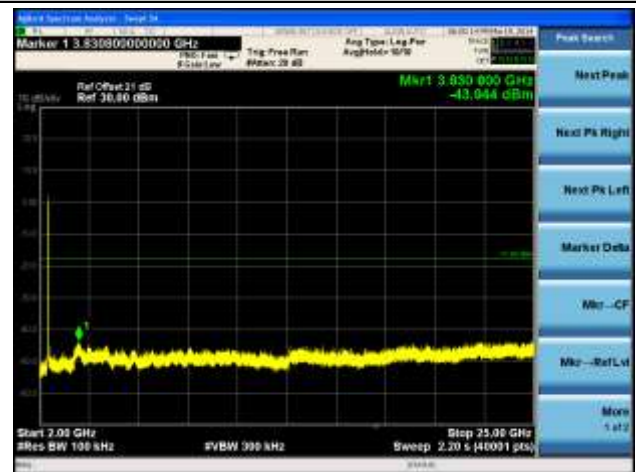

#### Channel 06 (2437MHz)

##### 100kHz PSD reference Level





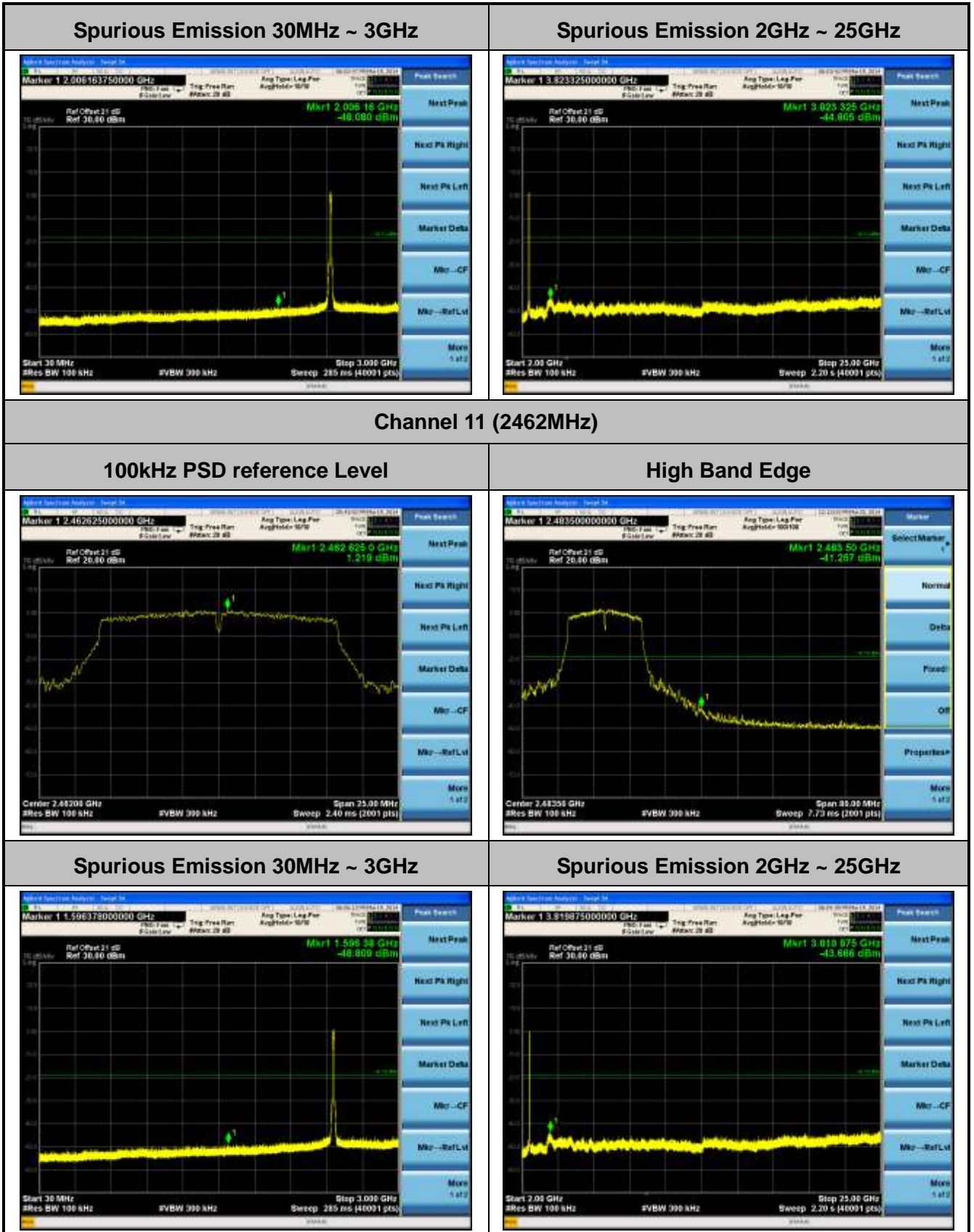

### 802.11n-HT20 Out-of-Band Emissions

#### Channel 01 (2412MHz)

##### 100kHz PSD reference Level



##### Low Band Edge



##### Spurious Emission 30MHz ~ 3GHz

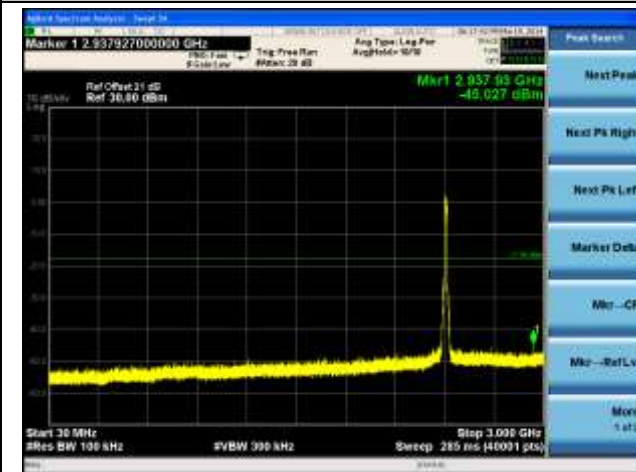

##### Spurious Emission 2GHz ~ 25GHz

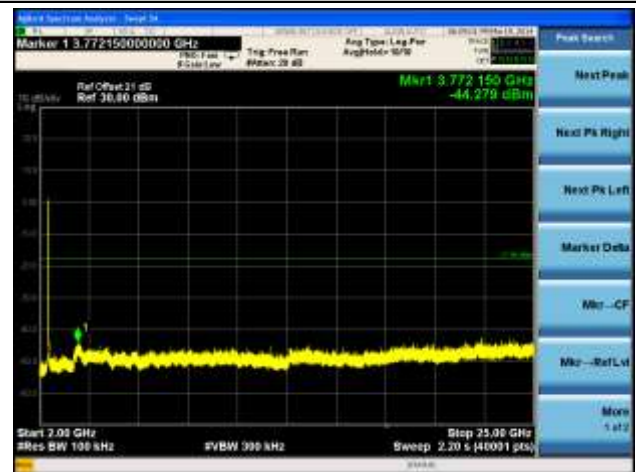

#### Channel 06 (2437MHz)

##### 100kHz PSD reference Level

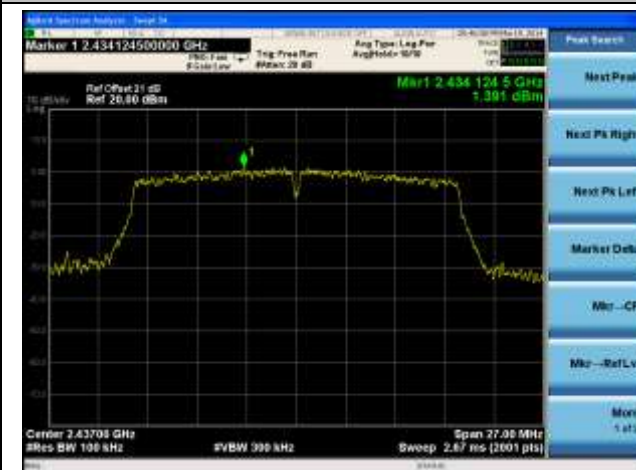

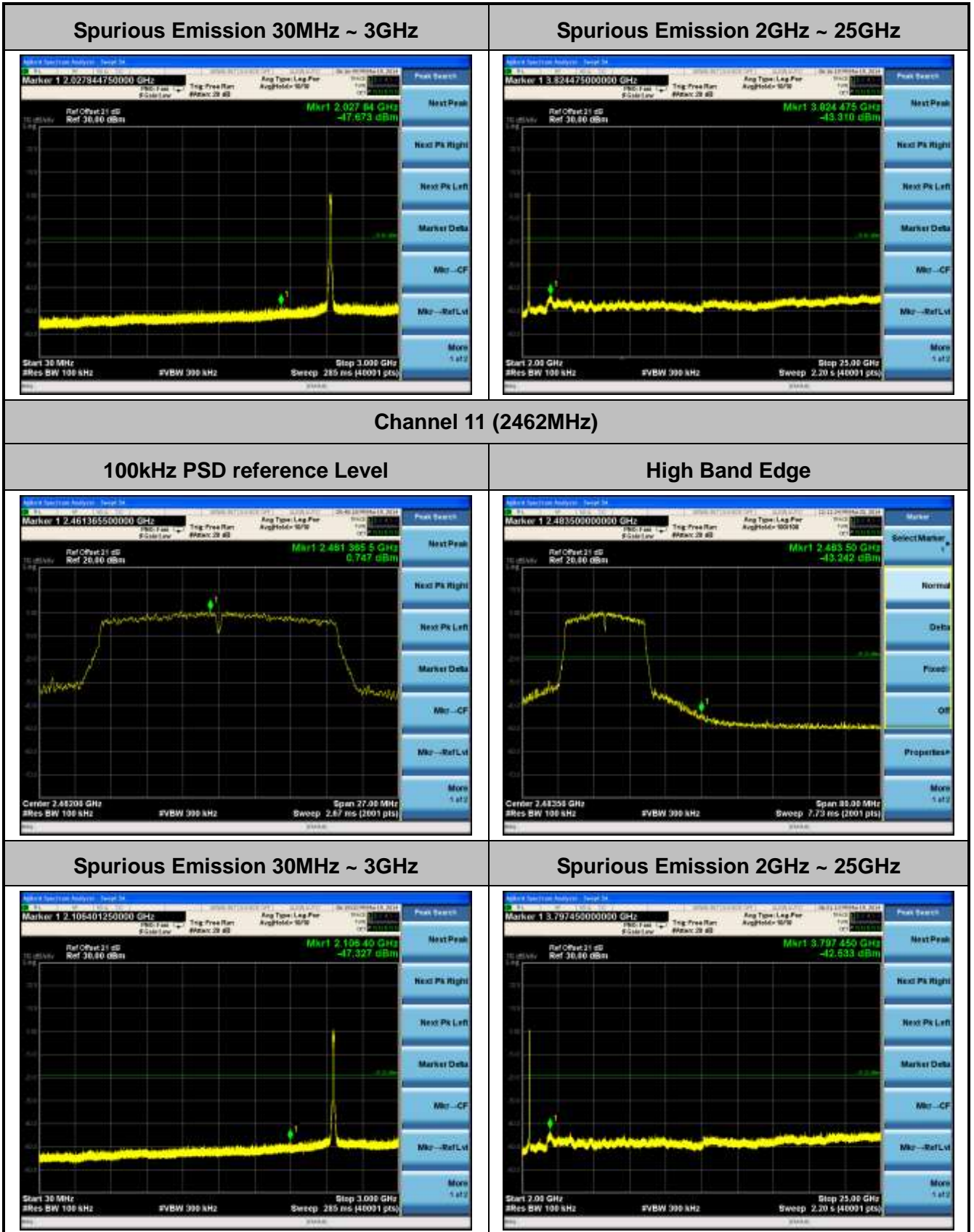

### 802.11n-HT40 Out-of-Band Emissions

#### Channel 03 (2422MHz)

##### 100kHz PSD reference Level

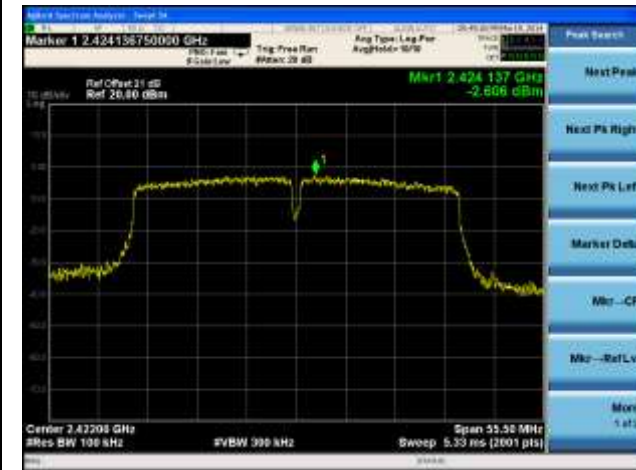

##### Low Band Edge



##### Spurious Emission 30MHz ~ 3GHz

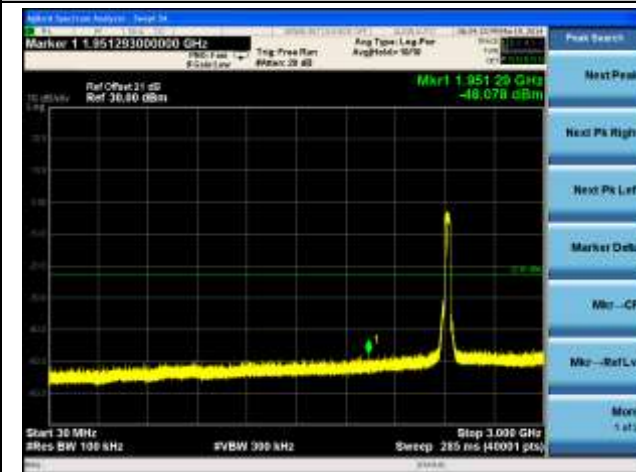

##### Spurious Emission 2GHz ~ 25GHz

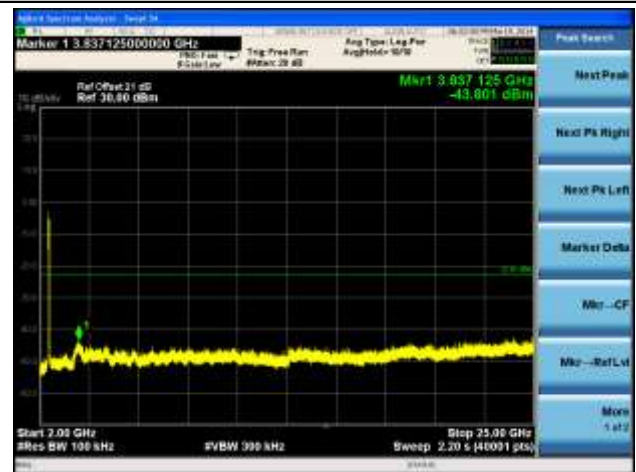

#### Channel 06 (2437MHz)

##### 100kHz PSD reference Level

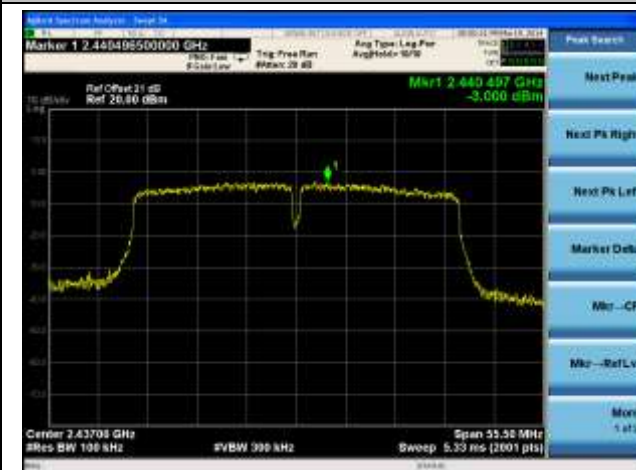

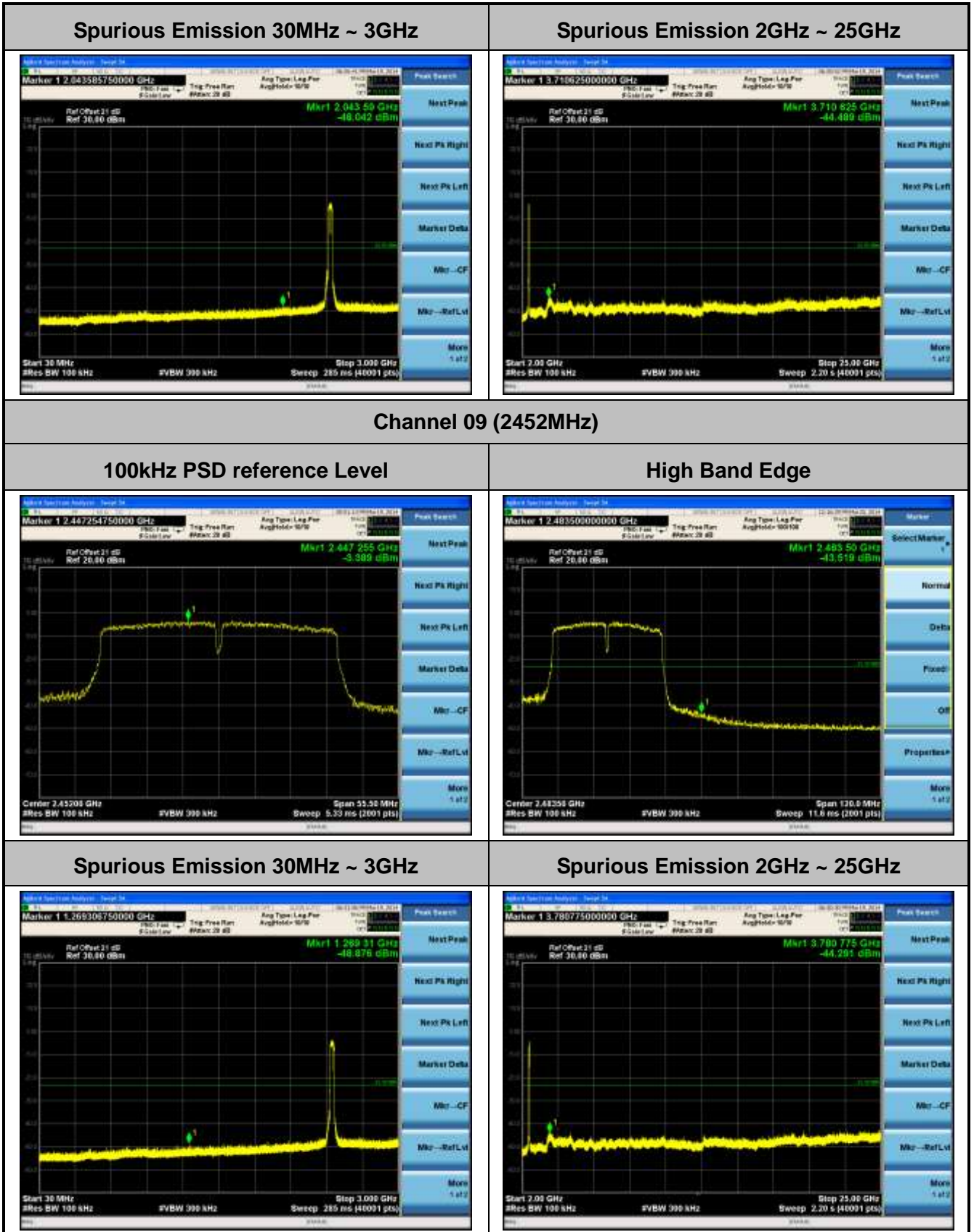

## 7.6. Radiated Spurious Emission Measurement

### 7.6.1. Test Limit

All out of band emissions appearing in a restricted band as specified in Section 15.205 of the Title 47 CFR must not exceed the limits shown in Table per Section 15.209.

FCC Part 15 Subpart C Paragraph 15.209		
Frequency [MHz]	Field Strength [V/m]	Measured Distance [Meters]
0.009 – 0.490	2400/F (kHz)	300
0.490 – 1.705	24000/F (kHz)	30
1.705 - 30	30	30
30 - 88	100	3
88 - 216	150	3
216 - 960	200	3
Above 960	500	3

### 7.6.2. Test Procedure Used

KDB 558074 D01v03r01 – Section 12.2.3 (quasi-peak measurements)

KDB 558074 D01v03r01 – Section 12.2.4 (peak power measurements)

KDB 558074 D01v03r01 – Section 12.2.5 (average power measurements)

### 7.6.3. Test Setting

#### Peak Field Strength Measurements per Section 12.2.4 of KDB 558074 D01v03r01

1. Analyzer center frequency was set to the frequency of the radiated spurious emission of interest
2. RBW = 1MHz
3. VBW = 3MHz
4. Detector = peak
5. Sweep time = auto couple
6. Trace mode = max hold
7. Trace was allowed to stabilize

**Average Field Strength Measurements per Section 12.2.5.1 of KDB 558074 D01v03r01**

1. Analyzer center frequency was set to the frequency of the radiated spurious emission of interest
2. RBW = 1MHz
3. VBW = 3MHz
4. Detector = power average (RMS)
5. Number of measurement points = 1001 (Number of points must be  $> 2 \times \text{span}/\text{RBW}$ )
6. Sweep time = auto
7. Trace (RMS) averaging was performed over at least 100 traces

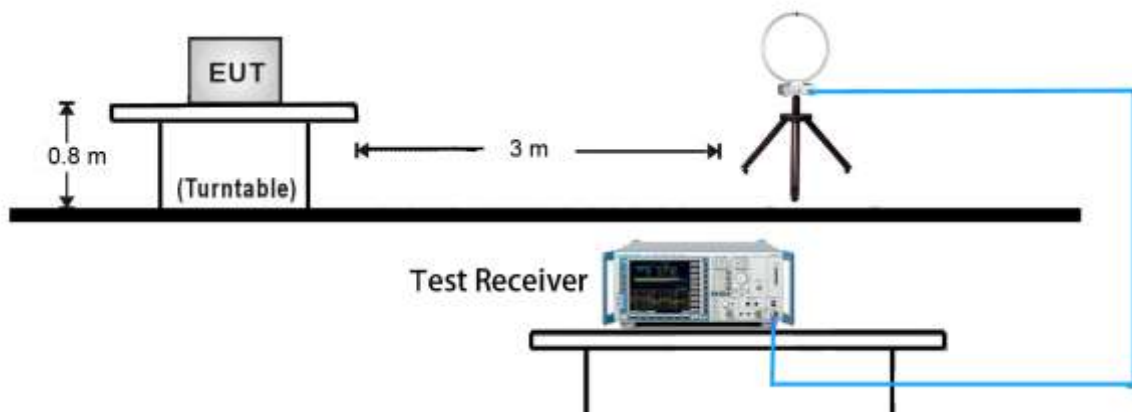
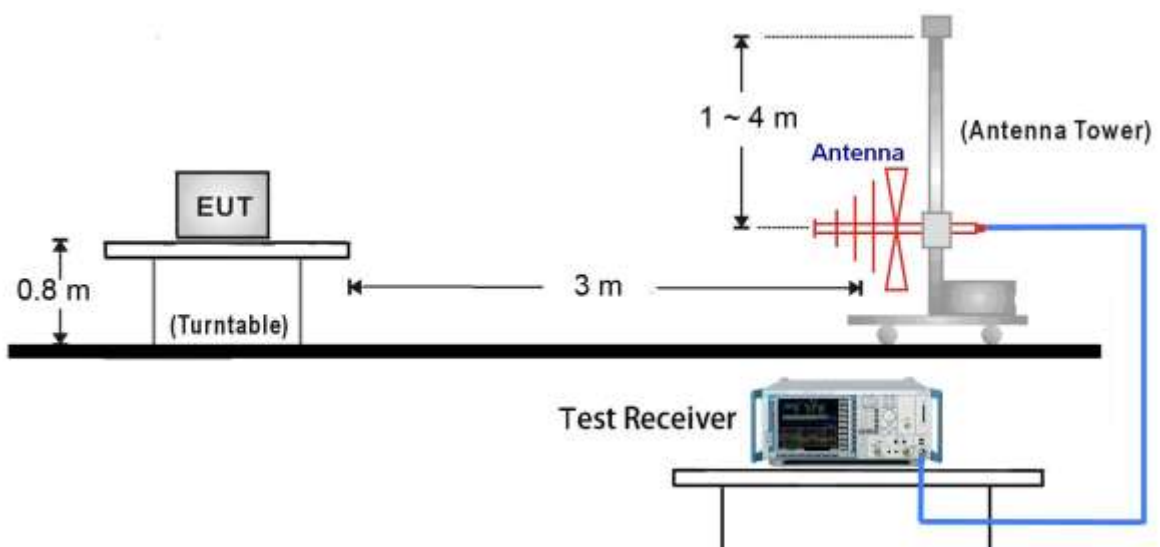
**7.6.4. Test Setup**9kHz ~ 30MHz Test Setup:30MHz ~ 1GHz Test Setup:

1GHz ~ 18GHz Test Setup:

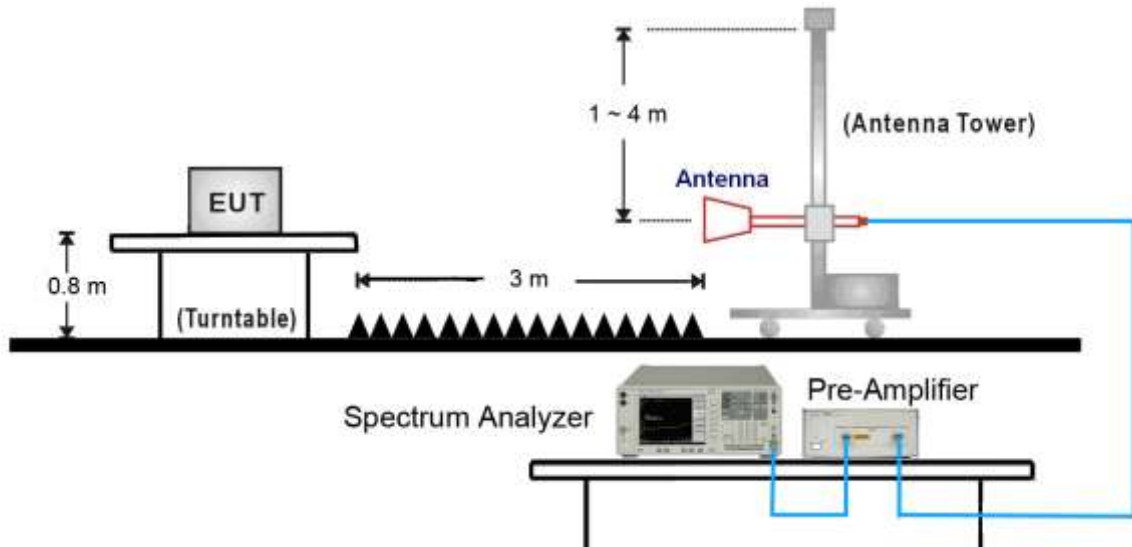



### 7.6.5. Test Result

Test Mode:	802.11g	Test Site:	AC1
Test Channel:	11	Test Engineer:	Roy Cheng
Remark:	1. Average measurement was not performed if peak level lower than average limit. 2. <b>The worst case of Radiated Spurious Emission.</b> 3. Other frequency was 20dB below limit line within 1-18GHz, there is not show in the report.		

Mark	Frequency (MHz)	Reading Level (dB $\mu$ V/m)	Factor (dB)	Measure Level (dB $\mu$ V/m)	Limit (dB $\mu$ V/m)	Margin (dB)	Detector	Polarization
*	4924.0	35.20	6.72	41.92	82.5	-40.58	Peak	Horizontal
*	5292.5	36.40	6.63	43.03	82.5	-39.47	Peak	Horizontal
	7386.0	34.26	14.10	48.36	74.0	-25.64	Peak	Horizontal
	7953.0	36.38	15.07	51.45	74.0	-22.55	Peak	Horizontal
*	4924.0	35.86	6.72	42.58	82.5	-39.92	Peak	Vertical
*	5309.5	35.45	6.68	42.13	82.5	-40.37	Peak	Vertical
	7386.0	34.28	14.10	48.38	74.0	-25.62	Peak	Vertical
	7944.5	35.97	15.07	51.04	74.0	-22.96	Peak	Vertical

Note: "\*" is not in restricted band, its limit is 20dBc of the fundamental emission level (102.5dB $\mu$ V/m).

**The worst case of Radiated Emission below 1GHz:**

Engineer: Roy Cheng	
Site: AC1	Time: 2014/03/29 - 19:42
Limit: FCC_Part15.209_RE(3m)	Margin: 0
Probe: VULB9162_0.03-8GHz	Polarity: Horizontal
EUT: Smart Phone	Power: AC 120V/60Hz
<b>Worst Case Mode: 802.11g Channel 2462MHz</b>	

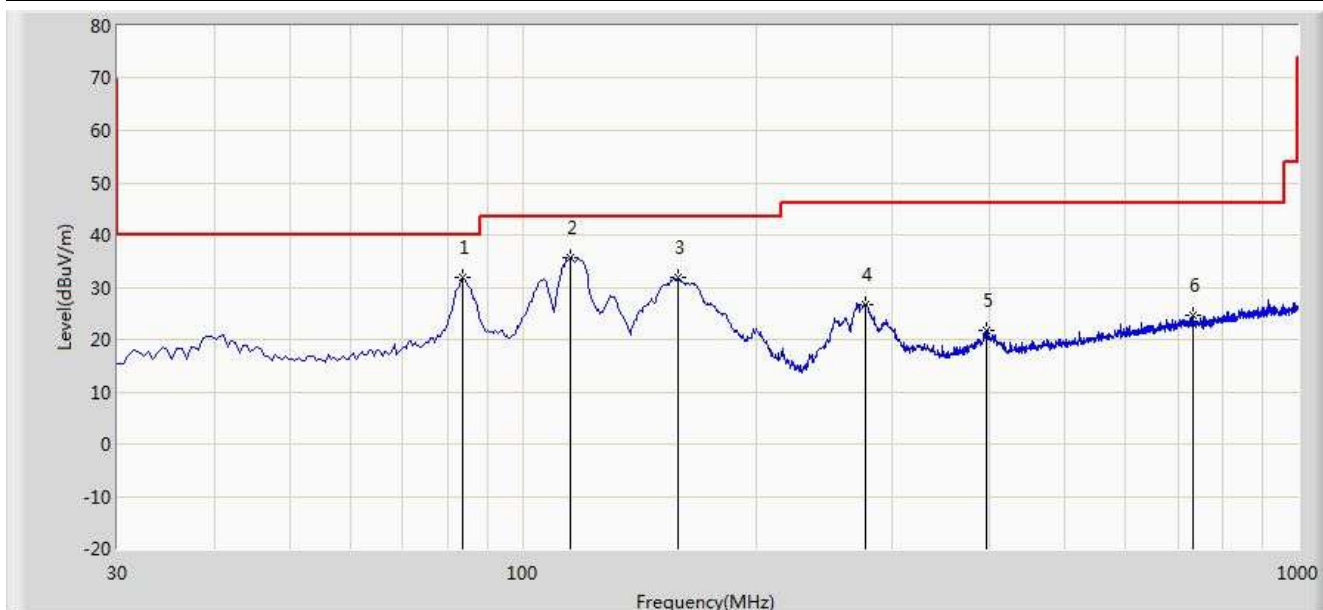

No	Flag	Mark	Frequency (MHz)	Measure Level (dBuV/m)	Reading Level (dBuV)	Over Limit (dB)	Limit (dBuV/m)	Factor	Type
1			83.835	31.804	22.107	-8.196	40.000	9.697	PK
2		*	115.360	35.767	24.012	-7.733	43.500	11.755	PK
3			158.525	31.765	22.302	-11.735	43.500	9.463	PK
4			277.350	26.757	13.006	-19.243	46.000	13.751	PK
5			396.660	21.635	5.486	-24.365	46.000	16.149	PK
6			732.280	24.688	3.372	-21.312	46.000	21.316	PK

Engineer: Roy Cheng	
Site: AC1	Time: 2014/03/29 - 19:44
Limit: FCC_Part15.209_RE(3m)	Margin: 0
Probe: VULB9162_0.03-8GHz	Polarity: Vertical
EUT: Smart Phone	Power: AC 120V/60Hz
<b>Worst Case Mode: 802.11g Channel 2462MHz</b>	

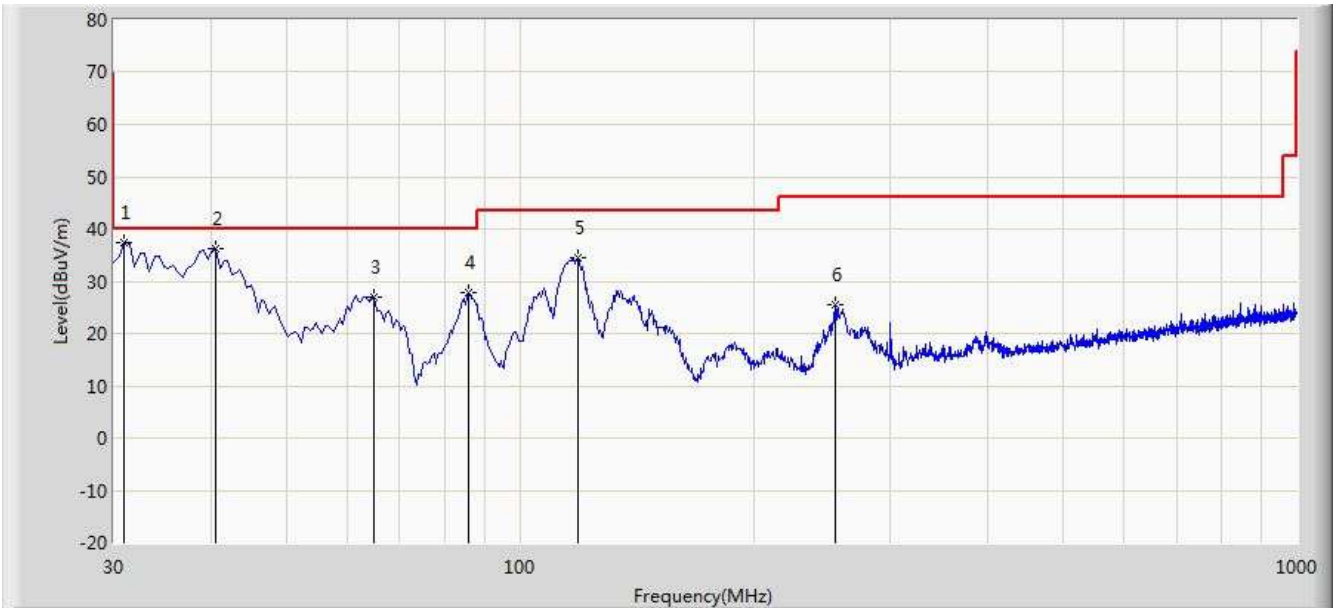

No	Flag	Mark	Frequency (MHz)	Measure Level (dBuV/m)	Reading Level (dBuV)	Over Limit (dB)	Limit (dBuV/m)	Factor	Type
1		*	30.970	37.526	25.448	-2.474	40.000	12.078	PK
2			40.670	36.198	22.357	-3.802	40.000	13.841	PK
3			64.920	26.944	14.578	-13.056	40.000	12.366	PK
4			85.775	27.791	17.832	-12.209	40.000	9.959	PK
5			118.755	34.393	23.198	-9.107	43.500	11.195	PK
6			255.040	25.454	12.069	-20.546	46.000	13.385	PK

Engineer: Roy Cheng	
Site: AC1	Time: 2014/03/29 - 16:39
Limit: FCC_Part15.209_RE(3m)	Margin: 0
Probe: FMZB1519_0.009-30MHz	Polarity: Face On
EUT: Smart Phone	Power: AC 120V/60Hz
<b>Note: There is the ambient noise within frequency range 9kHz~30MHz.</b>	

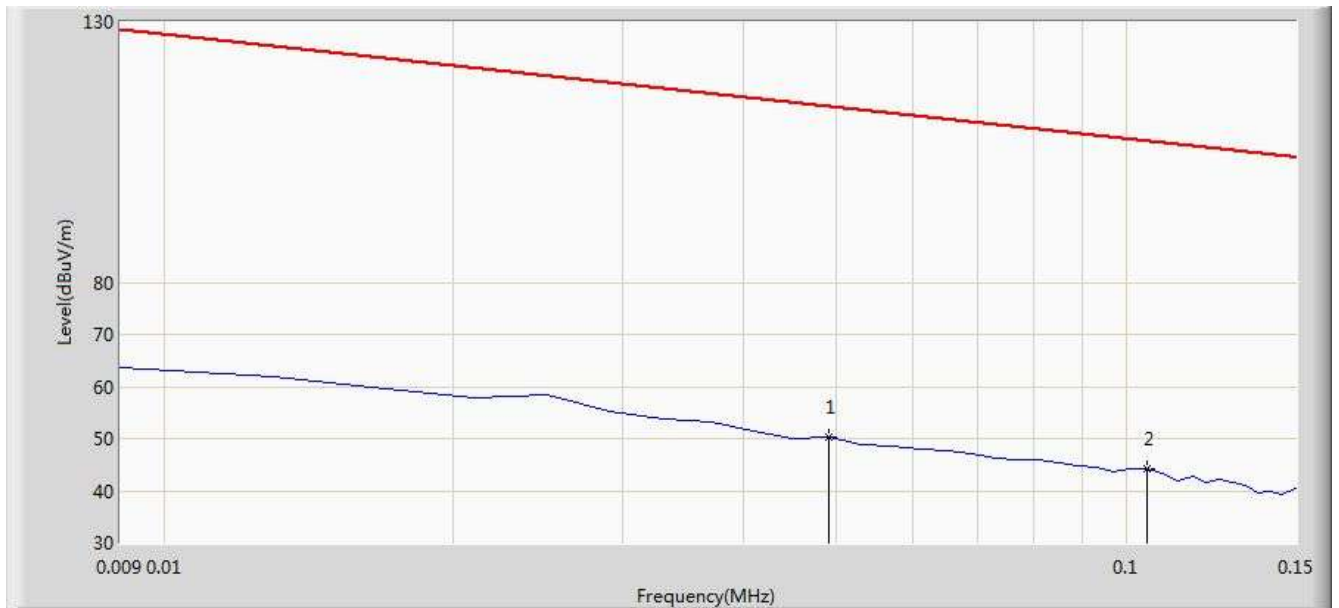

No	Flag	Mark	Frequency (MHz)	Measure Level (dBuV/m)	Reading Level (dBuV)	Over Limit (dB)	Limit (dBuV/m)	Factor	Type
1			0.049	50.367	29.861	-63.422	113.789	20.505	PK
2		*	0.105	44.143	23.996	-63.029	107.173	20.147	PK

Engineer: Roy Cheng	
Site: AC1	Time: 2014/03/29 - 16:41
Limit: FCC_Part15.209_RE(3m)	Margin: 0
Probe: FMZB1519_0.009-30MHz	Polarity: Face On
EUT: Smart Phone	Power: AC 120V/60Hz
<b>Note: There is the ambient noise within frequency range 9kHz~30MHz.</b>	

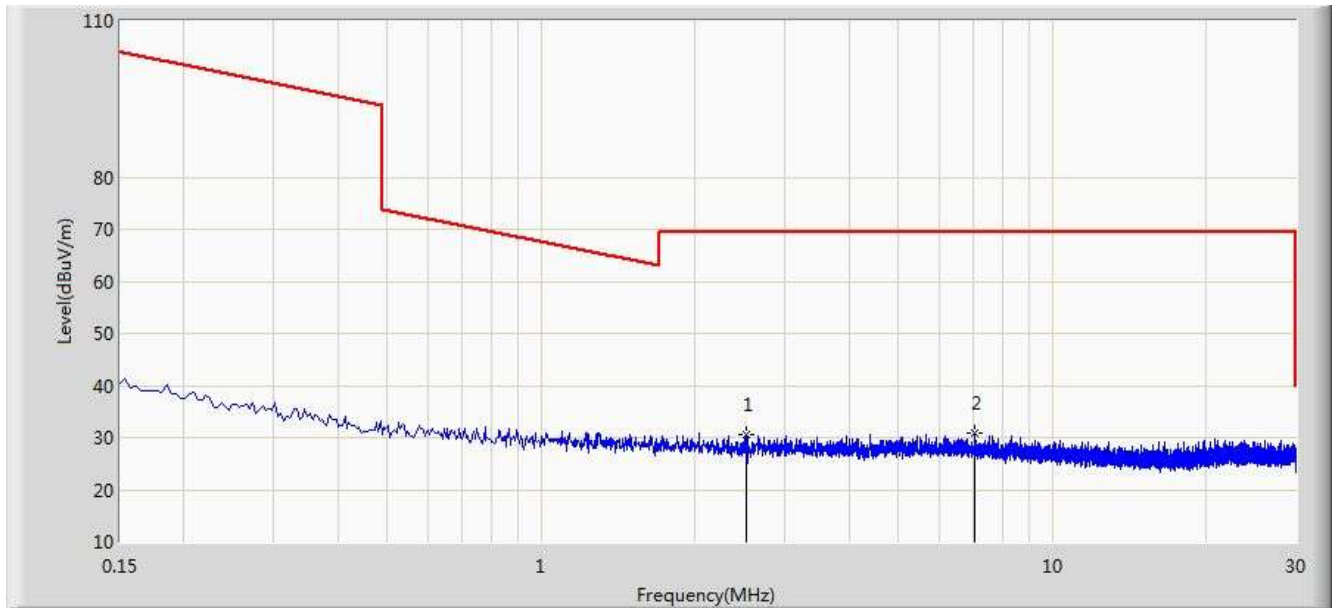

No	Flag	Mark	Frequency (MHz)	Measure Level (dBuV/m)	Reading Level (dBuV)	Over Limit (dB)	Limit (dBuV/m)	Factor	Type
1			2.513	30.495	10.336	-39.005	69.500	20.159	PK
2		*	7.041	30.974	10.579	-38.526	69.500	20.395	PK

Engineer: Roy Cheng	
Site: AC1	Time: 2014/03/29 - 17:39
Limit: FCC_Part15.209_RE(3m)	Margin: 0
Probe: BBHA9170_18-40GHz	Polarity: Horizontal
EUT: Smart Phone	Power: AC 120V/60Hz
<b>Note: There is the ambient noise within frequency range 18 ~ 25GHz.</b>	

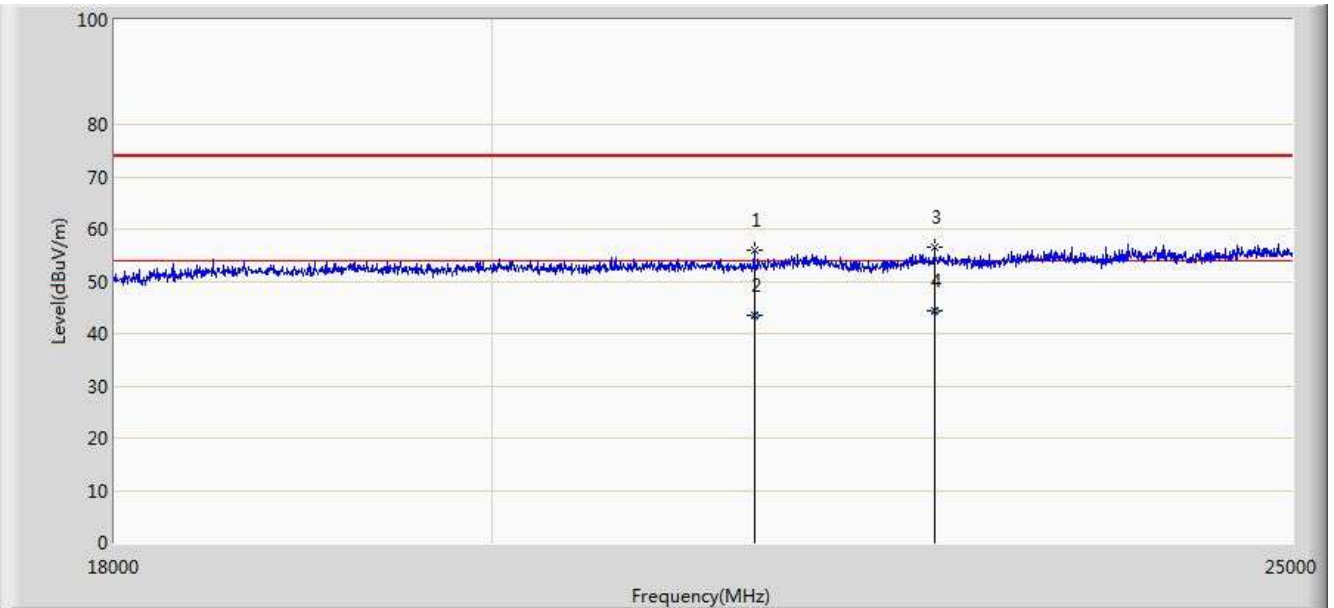

No	Flag	Mark	Frequency (MHz)	Measure Level (dBuV/m)	Reading Level (dBuV)	Over Limit (dB)	Limit (dBuV/m)	Factor	Type
1			21517.500	55.869	17.883	-18.131	74.000	37.986	PK
2			21517.650	43.351	5.365	-10.649	54.000	37.986	AV
3			22630.500	56.509	18.223	-17.491	74.000	38.286	PK
4		*	22630.540	44.310	6.024	-9.690	54.000	38.286	AV

Engineer: Roy Cheng	
Site: AC1	Time: 2014/03/29 - 17:43
Limit: FCC_Part15.209_RE(3m)	Margin: 0
Probe: BBHA9170_18-40GHz	Polarity: Vertical
EUT: Smart Phone	Power: AC 120V/60Hz
<b>Note: There is the ambient noise within frequency range 18 ~ 25GHz.</b>	

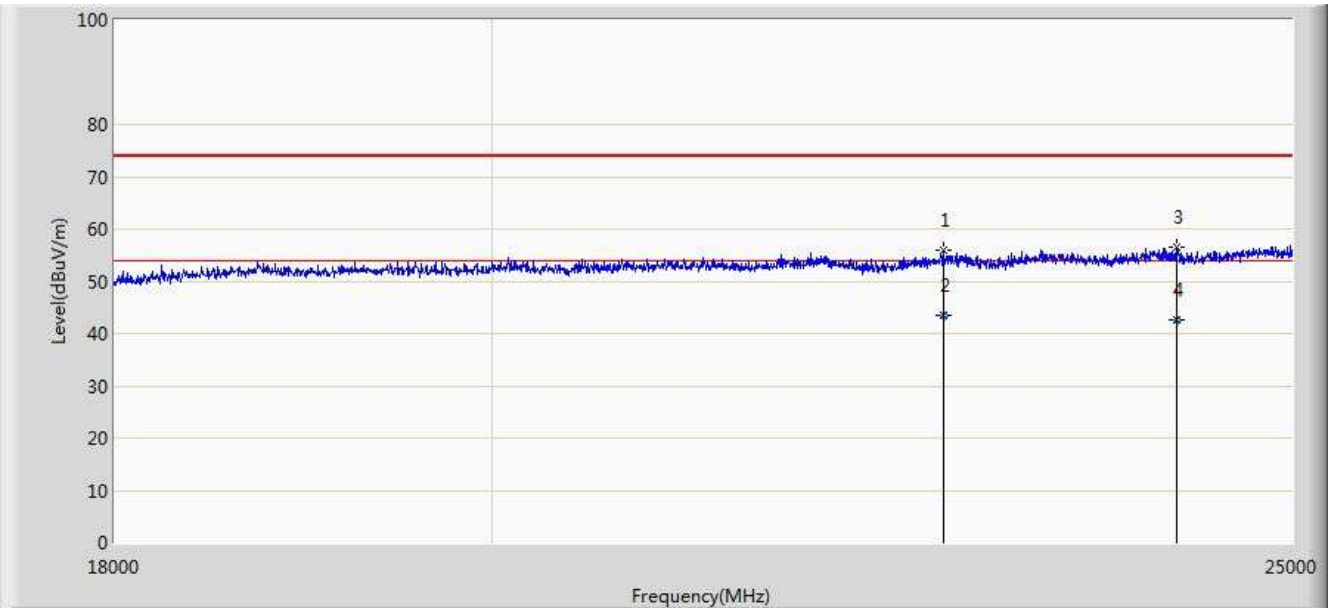

No	Flag	Mark	Frequency (MHz)	Measure Level (dBuV/m)	Reading Level (dBuV)	Over Limit (dB)	Limit (dBuV/m)	Factor	Type
1			22686.500	55.811	17.457	-18.189	74.000	38.354	PK
2		*	22686.540	43.598	5.244	-10.402	54.000	38.354	AV
3			24205.500	56.430	17.607	-17.570	74.000	38.823	PK
4			24205.658	42.518	3.695	-11.482	54.000	38.823	AV

## 7.7. Radiated Restricted Band Edge Measurement

### 7.7.1. Test Result

Engineer: Roy Cheng	
Site: AC1	Time: 2014/04/04 - 13:52
Limit: FCC_Part15.209_RE(3m)	Margin: 0
Probe: BBHA9120D_1-18GHz	Polarity: Horizontal
EUT: Smart Phone	Power: AC 120V/60Hz
<b>Worst Case Mode:</b> 802.11g channel 2412MHz	



No	Flag	Mark	Frequency (MHz)	Measure Level (dBuV/m)	Reading Level (dBuV)	Over Limit (dB)	Limit (dBuV/m)	Factor	Type
1			2390.000	64.177	33.493	-9.823	74.000	30.684	PK
2		*	2413.208	102.520	71.877	N/A	N/A	30.643	PK



Engineer: Roy Cheng	
Site: AC1	Time: 2014/04/04 - 13:57
Limit: FCC_Part15.209_RE(3m)	Margin: 0
Probe: BBHA9120D_1-18GHz	Polarity: Horizontal
EUT: Smart Phone	Power: AC 120V/60Hz
<b>Worst Case Mode: 802.11g channel 2412MHz</b>	

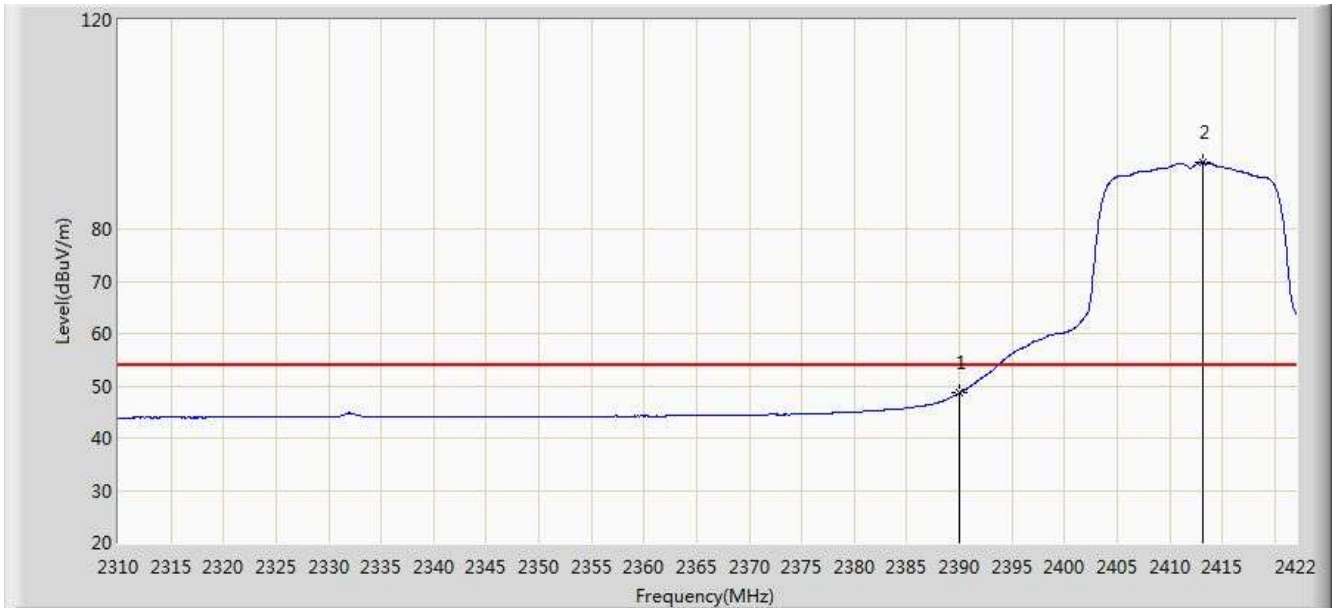

No	Flag	Mark	Frequency (MHz)	Measure Level (dBuV/m)	Reading Level (dBuV)	Over Limit (dB)	Limit (dBuV/m)	Factor	Type
1			2390.000	48.619	17.935	-5.381	54.000	30.684	AV
2		*	2413.208	92.644	62.001	N/A	N/A	30.643	AV

Engineer: Roy Cheng	
Site: AC1	Time: 2014/04/04 - 13:58
Limit: FCC_Part15.209_RE(3m)	Margin: 0
Probe: BBHA9120D_1-18GHz	Polarity: Vertical
EUT: Smart Phone	Power: AC 120V/60Hz
<b>Worst Case Mode: 802.11g channel 2412MHz</b>	



No	Flag	Mark	Frequency (MHz)	Measure Level (dBuV/m)	Reading Level (dBuV)	Over Limit (dB)	Limit (dBuV/m)	Factor	Type
1			2390.000	63.834	33.150	-10.166	74.000	30.684	PK
2		*	2413.152	101.855	71.212	N/A	N/A	30.643	PK

Engineer: Roy Cheng	
Site: AC1	Time: 2014/04/04 - 14:01
Limit: FCC_Part15.209_RE(3m)	Margin: 0
Probe: BBHA9120D_1-18GHz	Polarity: Vertical
EUT: Smart Phone	Power: AC 120V/60Hz
<b>Worst Case Mode: 802.11g channel 2412MHz</b>	

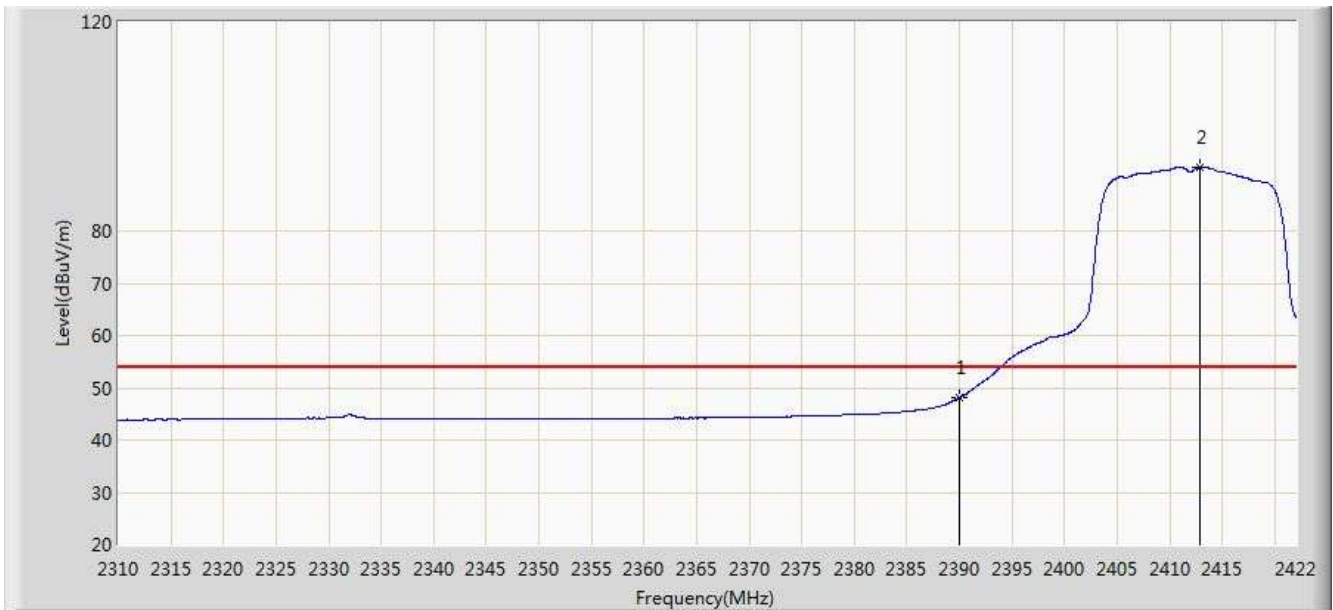

No	Flag	Mark	Frequency (MHz)	Measure Level (dBuV/m)	Reading Level (dBuV)	Over Limit (dB)	Limit (dBuV/m)	Factor	Type
1			2390.000	48.078	17.394	-5.922	54.000	30.684	AV
2		*	2412.872	92.183	61.540	N/A	N/A	30.644	AV

Engineer: Roy Cheng	
Site: AC1	Time: 2014/04/04 - 14:02
Limit: FCC_Part15.209_RE(3m)	Margin: 0
Probe: BBHA9120D_1-18GHz	Polarity: Horizontal
EUT: Smart Phone	Power: AC 120V/60Hz
<b>Worst Case Mode: 802.11g channel 2462MHz</b>	



No	Flag	Mark	Frequency (MHz)	Measure Level (dBuV/m)	Reading Level (dBuV)	Over Limit (dB)	Limit (dBuV/m)	Factor	Type
1		*	2460.784	100.956	70.346	N/A	N/A	30.609	PK
2			2483.500	58.157	27.484	-15.843	74.000	30.673	PK

Engineer: Roy Cheng	
Site: AC1	Time: 2014/04/04 - 14:05
Limit: FCC_Part15.209_RE(3m)	Margin: 0
Probe: BBHA9120D_1-18GHz	Polarity: Horizontal
EUT: Smart Phone	Power: AC 120V/60Hz
<b>Worst Case Mode: 802.11g channel 2462MHz</b>	



No	Flag	Mark	Frequency (MHz)	Measure Level (dBuV/m)	Reading Level (dBuV)	Over Limit (dB)	Limit (dBuV/m)	Factor	Type
1		*	2461.240	91.179	60.569	N/A	N/A	30.611	AV
2			2483.500	45.243	14.570	-8.757	54.000	30.673	AV

Engineer: Roy Cheng	
Site: AC1	Time: 2014/04/04 - 14:07
Limit: FCC_Part15.209_RE(3m)	Margin: 0
Probe: BBHA9120D_1-18GHz	Polarity: Vertical
EUT: Smart Phone	Power: AC 120V/60Hz
<b>Worst Case Mode: 802.11g channel 2462MHz</b>	



No	Flag	Mark	Frequency (MHz)	Measure Level (dBuV/m)	Reading Level (dBuV)	Over Limit (dB)	Limit (dBuV/m)	Factor	Type
1		*	2460.640	100.415	69.806	N/A	N/A	30.609	PK
2			2483.500	58.788	28.115	-15.212	74.000	30.673	PK

Engineer: Roy Cheng	
Site: AC1	Time: 2014/04/04 - 14:16
Limit: FCC_Part15.209_RE(3m)	Margin: 0
Probe: BBHA9120D_1-18GHz	Polarity: Vertical
EUT: Smart Phone	Power: AC 120V/60Hz
<b>Worst Case Mode: 802.11g channel 2462MHz</b>	



No	Flag	Mark	Frequency (MHz)	Measure Level (dBuV/m)	Reading Level (dBuV)	Over Limit (dB)	Limit (dBuV/m)	Factor	Type
1		*	2461.240	90.495	59.885	N/A	N/A	30.611	AV
2			2483.500	45.158	14.485	-8.842	54.000	30.673	AV

## 7.8. AC Conducted Emissions Measurement

### 7.8.1. Test Limit

FCC Part 15 Subpart C Paragraph 15.207 Limits		
Frequency (MHz)	QP (dBuV)	AV (dBuV)
0.15 - 0.50	66 - 56	56 – 46
0.50 - 5.0	56	46
5.0 - 30	60	50

Note 1: The lower limit shall apply at the transition frequencies.

Note 2: The limit decreases linearly with the logarithm of the frequency in the range 0.15MHz to 0.5MHz.

### 7.8.2. Test Setup

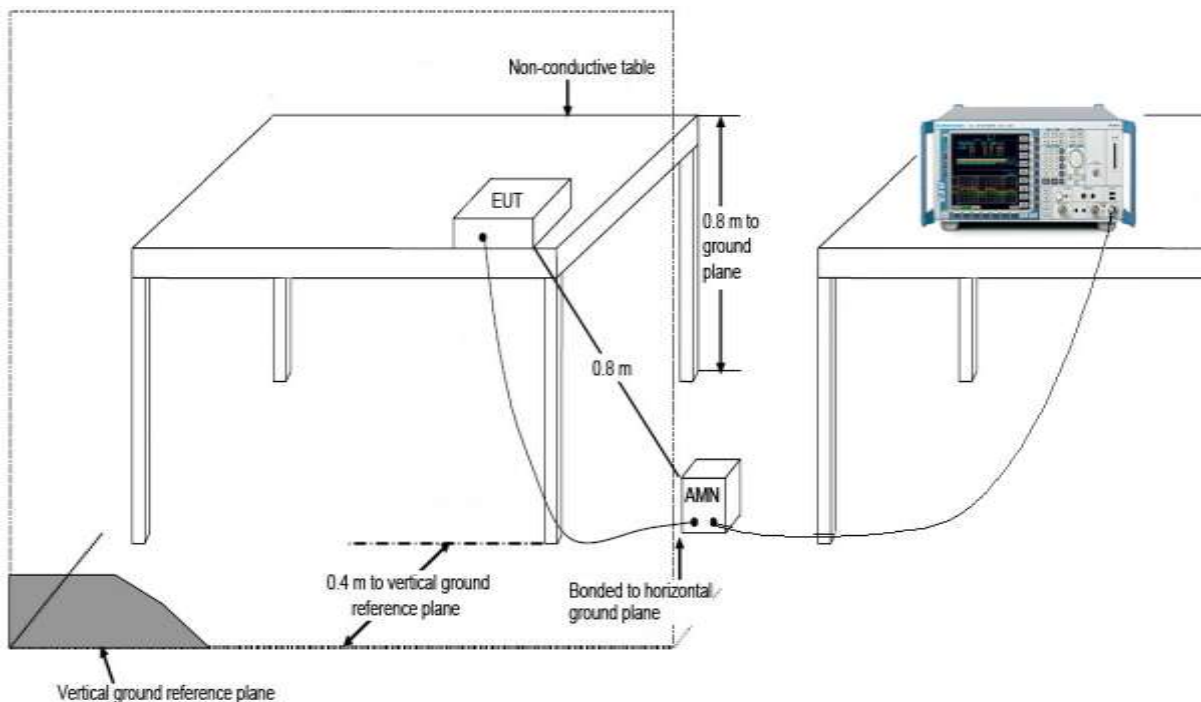



### 7.8.3. Test Result

Engineer: Milo Li	
Site: SR2	Time: 2014/03/29 - 17:30
Limit: FCC_Part15.207_CE_AC Power	Margin: 0
Probe: ENV216_101683_Filter On	Polarity: Line
EUT: Smart Phone	Power: AC 120V/60Hz
Note: Normal Operation	

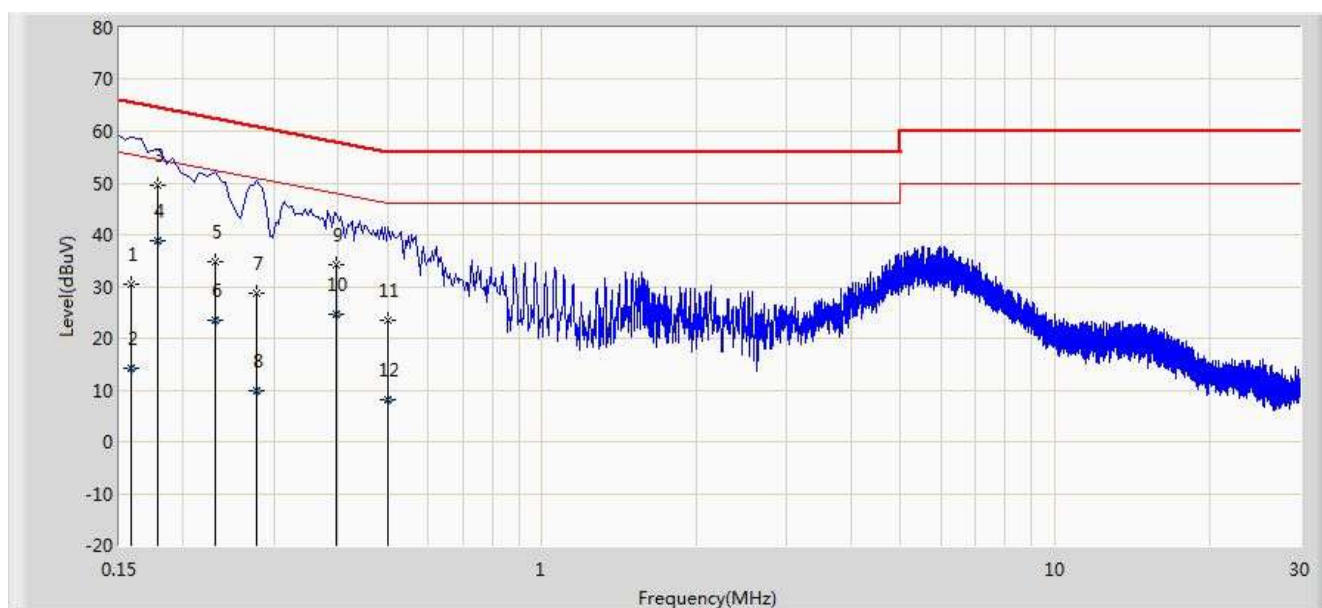

No	Flag	Mark	Frequency (MHz)	Measure Level (dBuV)	Reading Level (dBuV)	Over Limit (dB)	Limit (dBuV)	Factor	Type
1			0.158	30.387	20.076	-35.181	65.568	10.311	QP
2			0.158	14.218	3.907	-41.350	55.568	10.311	AV
3		*	0.178	49.601	39.543	-14.978	64.578	10.058	QP
4			0.178	38.703	28.645	-15.875	54.578	10.058	AV
5			0.230	34.735	24.788	-27.714	62.450	9.947	QP
6			0.230	23.525	13.577	-28.925	52.450	9.947	AV
7			0.278	28.753	18.766	-32.123	60.875	9.986	QP
8			0.278	9.776	-0.210	-41.099	50.875	9.986	AV
9			0.398	34.085	24.001	-23.810	57.895	10.084	QP
10			0.398	24.750	14.666	-23.145	47.895	10.084	AV
11			0.502	23.378	13.221	-32.622	56.000	10.157	QP
12			0.502	8.077	-2.080	-37.923	46.000	10.157	AV

Engineer: Milo Li	
Site: SR2	Time: 2014/03/29 - 17:39
Limit: FCC_Part15.207_CE_AC Power	Margin: 0
Probe: ENV216_101683_Filter On	Polarity: Neutral
EUT: Smart Phone	Power: AC 120V/60Hz
Note: Normal Operation	

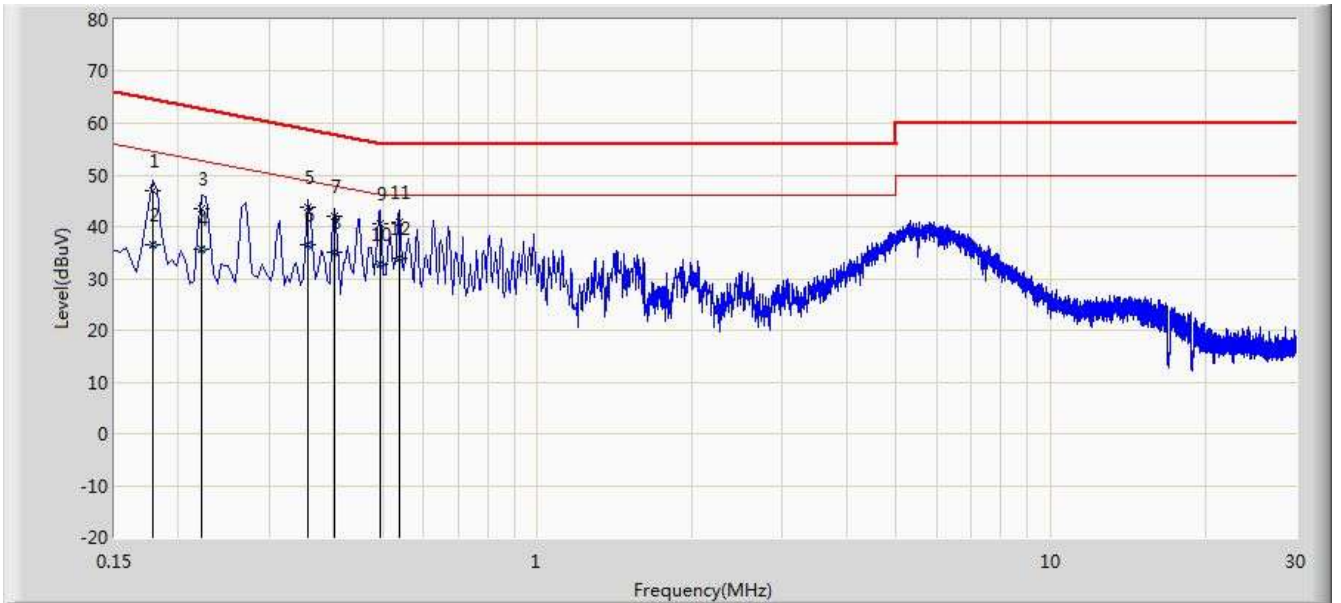

No	Flag	Mark	Frequency (MHz)	Measure Level (dBuV)	Reading Level (dBuV)	Over Limit (dB)	Limit (dBuV)	Factor	Type
1			0.178	47.030	36.981	-17.548	64.578	10.049	QP
2			0.178	36.591	26.541	-17.988	54.578	10.049	AV
3			0.222	43.558	33.578	-19.186	62.744	9.980	QP
4			0.222	35.626	25.646	-17.118	52.744	9.980	AV
5			0.358	43.723	33.642	-15.051	58.775	10.081	QP
6			0.358	36.646	26.565	-12.128	48.775	10.081	AV
7			0.402	41.986	31.872	-15.826	57.812	10.114	QP
8			0.402	35.080	24.967	-12.732	47.812	10.114	AV
9			0.494	40.590	30.411	-15.510	56.100	10.178	QP
10			0.494	32.638	22.460	-13.462	46.100	10.178	AV
11			0.538	40.842	30.677	-15.158	56.000	10.166	QP
12		*	0.538	33.894	23.729	-12.106	46.000	10.166	AV

## 8. CONCLUSION

The data collected relate only the item(s) tested and show that the **Smart Phone FCC ID:**

**2AAA6-S950** is in compliance with Part 15C of the FCC Rules.

---

The End