



MEASUREMENT REPORT

FCC PART 15.247 Bluetooth

FCC ID: 2AAA6-S950

APPLICANT: SENWA MEXICO,S.A.DE C.V

Application Type: Certification

Product: Smart Phone

Model No.: S950

Brand Name: SENWA

FCC Classification: FCC Part 15 Spread Spectrum Transmitter(DSS)

FCC Rule Part(s): Part 15.247

Test Procedure(s): ANSI C63.10-2009, DA 00-705

Test Date: March 27 ~ April 05, 2014

Reviewed By : Robin Wu
(Robin Wu)

Approved By : Marlin Chen
(Marlin Chen)

The test results relate only to the samples tested.

This equipment has been shown to be capable of compliance with the applicable technical standards as indicated in the measurement report and was tested in accordance with the measurement procedures specified in ANSI C63.10-2009 and DA 00-705. Test results reported herein relate only to the item(s) tested.

The test report shall not be reproduced except in full without the written approval of MRT Technology (Suzhou) Co., Ltd.

Revision History

Report No.	Version	Description	Issue Date
1403RSU01201	Rev. 01	Initial report	04-11-2014
1403RSU01201	Rev. 02	Modify 2DH5, 3DH5 Power	04-15-2014
1403RSU01201	Rev. 03	Modify 2DH5 High channel Power	04-16-2014

CONTENTS

Description	Page
§2.1033 General Information	6
1. INTRODUCTION	7
1.1. Scope	7
1.2. MRT Test Location	7
2. PRODUCT INFORMATION	8
2.1. Equipment Description.....	8
2.2. Frequency / Channel Operation.....	9
2.3. Pseudorandom Frequency Hopping Sequence.....	10
2.4. Device Capabilities	10
2.5. Test Configuration	10
2.6. Test Software	10
2.7. EMI Suppression Device(s)/Modifications.....	11
2.8. Labeling Requirements.....	11
3. DESCRIPTION OF TEST	12
3.1. Evaluation Procedure	12
3.2. AC Line Conducted Emissions	12
3.3. Radiated Emissions.....	13
4. ANTENNA REQUIREMENTS	14
5. TEST EQUIPMENT CALIBRATION DATA	15
6. MEASUREMENT UNCERTAINTY	16
7. TEST RESULT	17
7.1. Summary	17
7.2. 20dB Bandwidth Measurement.....	18
7.2.1. Test Limit	18
7.2.2. Test Procedure used.....	18
7.2.3. Test Setting.....	18
7.2.4. Test Setup.....	19
7.2.5. Test Result.....	20
7.3. Output Power Measurement.....	23
7.3.1. Test Limit	23
7.3.2. Test Procedure Used	23
7.3.3. Test Setting.....	23
7.3.4. Test Setup.....	23

7.3.5.	Test Result.....	24
7.4.	Carrier Frequency Separation Measurement	27
7.4.1.	Test Limit	27
7.4.2.	Test Procedure Used	27
7.4.3.	Test Setting.....	27
7.4.4.	Test Setup.....	27
7.4.5.	Test Result.....	28
7.5.	Number of Hopping Channels Measurement	31
7.5.1.	Test Limit	31
7.5.2.	Test Procedure Used	31
7.5.3.	Test Setting.....	31
7.5.4.	Test Setup.....	31
7.5.5.	Test Result.....	32
7.6.	Time of Occupancy Measurement	35
7.6.1.	Test Limit	35
7.6.2.	Test Procedure Used	35
7.6.3.	Test Setting.....	35
7.6.4.	Test Setup.....	36
7.6.5.	Test Result.....	37
7.7.	Band-edge Compliance Measurement.....	39
7.7.1.	Test Limit	39
7.7.2.	Test Procedure Used	39
7.7.3.	Test Setting.....	39
7.7.4.	Test Setup.....	40
7.7.5.	Test Result.....	41
7.8.	Conducted Spurious Emissions Measurement.....	43
7.8.1.	Test Limit	43
7.8.2.	Test Procedure Used	43
7.8.3.	Test Setting.....	43
7.8.4.	Test Setup.....	44
7.8.5.	Test Result.....	45
7.9.	Radiated Spurious Emission Measurement	48
7.9.1.	Test Limit	48
7.9.2.	Test Procedure Used	48
7.9.3.	Test Setting.....	48
7.9.4.	Test Setup.....	49
7.9.5.	Test Result.....	51
7.10.	Radiated Restricted Band Edge Measurement	58

7.10.1. Test Result.....	58
7.11. AC Conducted Emissions Measurement.....	66
7.11.1. Test Limit	66
7.11.2. Test Setup.....	66
7.11.3. Test Result.....	67
8. CONCLUSION.....	69

§2.1033 General Information

Applicant:	SENA MEXICO,S.A.DE C.V
Applicant Address:	Av. Javier Barros Sierra 540,Torre I, Planta 5; COL. LOMAS DE SANTA FE DELEGACION ALVARO OBREGON C.P. 01210 MEXICO, DISTRITO FEDERAL
Manufacturer:	SHEN ZHEN IMO ELECTRONIC TECHENLOGY CO., LTD
Manufacturer Address:	A807 Haisong Building, 9 Tairan Road, Che Kung Temple, Futian District, Shenzhen
Test Site:	MRT Technology (Suzhou) Co., Ltd
Test Site Address:	D8 Building, Youxin Industrial Park, No.2 Tian'edang Rd., Wuzhong Economic Development Zone, Suzhou, China
MRT Registration No.:	809388
FCC Rule Part(s):	Part 15.247
Model No.	S950
FCC ID:	2AAA6-S950
Test Device Serial No.:	N/A <input type="checkbox"/> Production <input checked="" type="checkbox"/> Pre-Production <input type="checkbox"/> Engineering
FCC Classification:	FCC Part 15 Spread Spectrum Transmitter (DSS)
Method/System:	Frequency Hopping Spread Spectrum (FHSS)
Date(s) of Test:	March 27 ~ April 05, 2014
Test Report S/N:	1403RSU01201

1. INTRODUCTION

1.1. Scope

Measurement and determination of electromagnetic emissions (EMC) of radio frequency devices including intentional and/or unintentional radiators for compliance with the technical rules and regulations of the Federal Communications Commission and the Industry Canada Certification and Engineering Bureau.

1.2. MRT Test Location

The map below shows the location of the MRT LABORATORY, its proximity to the Taihu Lake. These measurement tests were conducted at the MRT Technology (Suzhou) Co., Ltd. Facility located at D8 Building, Youxin Industrial Park, No.2 Tian'edang Rd., Wuzhong Economic Development Zone, Suzhou, China. The detailed description of the measurement facility was found to be in compliance with the requirements of § 2.948 according to ANSI C63.4-2009 on September 30, 2013.



2. PRODUCT INFORMATION

2.1. Equipment Description

Product Name	Smart Phone
Model No.	S950
Brand Name	SENA
Bluetooth (1x, EDR)	
Bluetooth Frequency	2402~2480MHz
Bluetooth Version	V4.0
Type of modulation	FHSS
Data Rate	1Mbps(GFSK), 2Mbps(Pi/4 DQPSK), 3Mbps (8DPSK)
Antenna Type	Internal
Antenna Gain	-1.53dBi

The equipment under test (EUT) is the **Smart Phone FCC ID: 2AAA6-S950**. The test data contained in this report pertains only to the emissions due to the EUT's Bluetooth transmitter.

- 15.247(g): In accordance with the Bluetooth Industry Standard, the system is designed to comply with all of the regulations in Section 15.247 when the transmitter is presented with a continuous data (or information) system.
- 15.247(h): In accordance with the Bluetooth Industry Standard, the system does not coordinate its channels selection/ hopping sequence with other frequency hopping systems for the express purpose of avoiding the simultaneous occupancy of individual hopping frequencies by multiple transmitters.
- 15.247(h): The EUT employs Adaptive Frequency Hopping (AFH) which identifies sources of interference namely devices operating in 802.11 WLAN and excludes them from the list of available channels. The process of re-mapping reduces the number of test channels from 79 channels to a minimum number of 20 channels.

2.2. Frequency / Channel Operation

Channel	Frequency	Channel	Frequency	Channel	Frequency
00	2402 MHz	01	2403 MHz	02	2404 MHz
03	2405 MHz	04	2406 MHz	05	2407 MHz
06	2408 MHz	07	2409 MHz	08	2410 MHz
09	2411 MHz	10	2412 MHz	11	2413 MHz
12	2414 MHz	13	2415 MHz	14	2416 MHz
15	2417 MHz	16	2418 MHz	17	2419 MHz
18	2420 MHz	19	2421 MHz	20	2422 MHz
21	2423 MHz	22	2424 MHz	23	2425 MHz
24	2426 MHz	25	2427 MHz	26	2428 MHz
27	2429 MHz	28	2430 MHz	29	2431 MHz
30	2432 MHz	31	2433 MHz	32	2434 MHz
33	2435 MHz	34	2436 MHz	35	2437 MHz
36	2438 MHz	37	2439 MHz	38	2440 MHz
39	2441 MHz	40	2442 MHz	41	2443 MHz
42	2444 MHz	43	2445 MHz	44	2446 MHz
45	2447 MHz	46	2448 MHz	47	2449 MHz
48	2450 MHz	49	2451 MHz	50	2452 MHz
51	2453 MHz	52	2454 MHz	53	2455 MHz
54	2456 MHz	55	2457 MHz	56	2458 MHz
57	2459 MHz	58	2460 MHz	59	2461 MHz
60	2462 MHz	61	2463 MHz	62	2464 MHz
63	2465 MHz	64	2466 MHz	65	2467 MHz
66	2468 MHz	67	2469 MHz	68	2470 MHz
69	2471 MHz	70	2472 MHz	71	2473 MHz
72	2474 MHz	73	2475 MHz	74	2476 MHz
75	2477 MHz	76	2478 MHz	77	2479 MHz
78	2480 MHz	N/A	N/A	N/A	N/A

2.3. Pseudorandom Frequency Hopping Sequence

The pseudorandom sequence may be generated in a nine-stage shift register whose 5th and 9th stage outputs are added in a modulo-two addition stage. And the result is fed back to the input of the first stage. The sequence begins with the first ONE of 9 consecutive ONES; i.e. the shift register is initialized with nine ones.

- Number of shift register stages: 9
- Length of pseudo-random sequence: $2^9 - 1 = 511$ bits
- Longest sequence of zeros: 8 (non-inverted signal)

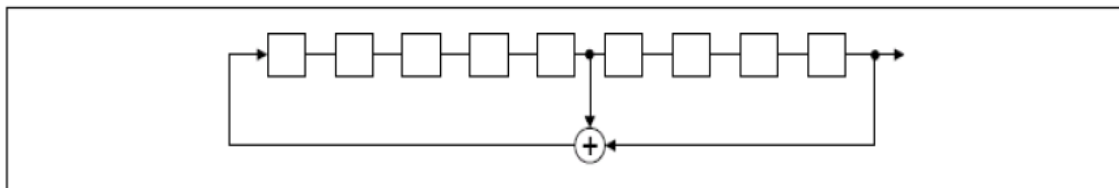

Linear Feedback Shift Register for Generation of the PRBS sequence

An example of Pseudorandom Frequency Hopping Sequence as follow:

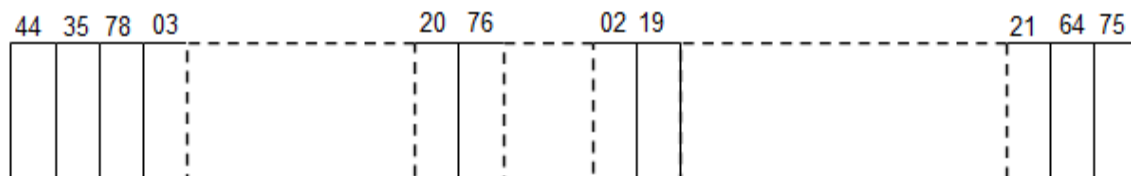

Each frequency used equally on the average by each transmitter.

The system receivers have input bandwidths that match the hopping channel bandwidths of their Corresponding transmitters and shift frequencies in synchronization with the transmitted signals.

2.4. Device Capabilities

This device contains the following capabilities:

850/1900 GSM/GPRS/EDGE, 850/1900 WCDMA/HSDPA/HSUPA/HSPA+, 802.11b/g/n WLAN (DTS), Bluetooth (1x, EDR, BLE)

2.5. Test Configuration

The Smart Phone FCC ID: 2AAA6-S950 was tested per the guidance of ANSI C63.10-2009 and DA 00-705. ANSI C63.10-2009 was used to reference the appropriate EUT setup for radiated spurious emissions testing and AC line conducted testing.

2.6. Test Software

The test utility software used during testing was engineering order by mobile phone.

2.7. EMI Suppression Device(s)/Modifications

No EMI suppression device(s) were added and/or no modifications were made during testing.

2.8. Labeling Requirements

Per 2.1074 & 15.19; Docket 95-19

The label shall be permanently affixed at a conspicuous location on the device; instruction manual or pamphlet supplied to the user and be readily visible to the purchaser at the time of purchase.

However, when the device is so small wherein placement of the label with specified statement is not practical, only the trade name and FCC ID must be displayed on the device per Section 15.19(a)(5).

Please see attachment for FCC ID label and label location.

3. DESCRIPTION OF TEST

3.1. Evaluation Procedure

The measurement procedures described in the American National Standard for Testing Unlicensed Wireless Devices (ANSI C63.10-2009), and the “Filing and Measurement Guidelines for Frequency Hopping Spread Spectrum Systems” (DA 00-705) were used in the measurement of the **Smart Phone FCC ID: 2AAA6-S950**.

Deviation from measurement procedure.....None

3.2. AC Line Conducted Emissions

The line-conducted facility is located inside an 8'x4'x4' shielded enclosure. The shielding effectiveness of the shielded room is in accordance with MIL-Std-285. A 1m x 2m wooden table 80cm high is placed 40cm away from the vertical wall and 80cm away from the sidewall of the shielded room. Two 10kHz-30MHz, 50Ω/50uH Line-Impedance Stabilization Networks (LISNs) are bonded to the shielded room floor. Power to the LISNs is filtered by external high-current high-insertion loss power line filters. These filters attenuate ambient signal noise from entering the measurement lines. These filters are also bonded to the shielded enclosure.

The EUT is powered from one LISN and the support equipment is powered from the second LISN. If the EUT is a DC-powered device, power will be derived from the source power supply it normally will be powered from and this supply line(s) will be connected to the second LISN. All interconnecting cables more than 1 meter were shortened to a 1 meter length by non-inductive bundling (serpentine fashion) and draped over the back edge of the test table. All cables were at least 40cm above the horizontal reference ground-plane. Power cables for support equipment were routed down to the second LISN while ensuring that that cables were not draped over the second LISN.

Sufficient time for the EUT, support equipment, and test equipment was allowed in order for them to warm up to their normal operating condition. The RF output of the LISN was connected to the spectrum analyzer and exploratory measurements were made to determine the frequencies producing the maximum emission from the EUT. The spectrum was scanned from 150kHz to 30MHz with a spectrum analyzer. The detector function was set to peak mode for exploratory measurements while the bandwidth of the analyzer was set to 10kHz. The EUT, support equipment, and interconnecting cables were arranged and manipulated to maximize each emission. Each emission was also maximized by varying: power lines, the mode of operation or resolution, clock or data exchange speed, scrolling H pattern to the EUT and/or support equipment whichever determined the worst-case emission. Once the worst case emissions have been identified, the one EUT cable configuration/arrangement and mode of operation that produced these emissions is used for final measurements on the same test site. The analyzer is set to CISPR quasi-peak and average detectors with a 9kHz resolution bandwidth for final measurements.

Line conducted emissions test results are shown in Section 7.11.

3.3. Radiated Emissions

The radiated test facilities consisted of an indoor 3 meter semi-anechoic chamber used for final measurements and exploratory measurements, when necessary. The measurement area is contained within the semi-anechoic chamber which is shielded from any ambient interference. For measurements above 1GH absorbers are arranged on the floor between the turn table and the antenna mast in such a way so as to maximize the reduction of reflections. For measurements below 1GHz, the absorbers are removed. An MF Model 210SS turntable is used for radiated measurement. It is a continuously rotatable, remote controlled, metallic turntable and 2 meters (6.56 ft.) in diameter. The turn table is flush with the raised floor of the chamber in order to maintain its function as a ground plane. An 80cm high PVC support structure is placed on top of the turntable.

For all measurements, the spectrum was scanned through all EUT azimuths and from 1 to 4 meter receive antenna height using a broadband antenna from 30MHz up to the upper frequency shown in 15.33(b)(1) depending on the highest frequency generated or used in the device or on which the device operates or tunes. For frequencies above 1GHz, linearly polarized double ridge horn antennas were used. For frequencies below 30MHz, a calibrated loop antenna was used. When exploratory measurements were necessary, they were performed at 1 meter test distance inside the semi-anechoic chamber using broadband antennas, broadband amplifiers, and spectrum analyzers to determine the frequencies and modes producing the maximum emissions. Sufficient time for the EUT, support equipment, and test equipment was allowed in order for them to warm up to their normal operating condition. The test set-up was placed on top of the 0.8 meter high, 1 x 1.5 meter table. The EUT, support equipment, and interconnecting cables were arranged and manipulated to maximize each emission. Appropriate precaution was taken to ensure that all emissions from the EUT were maximized and investigated. The system configuration, clock speed, mode of operation or video resolution, if applicable, turntable azimuth, and receive antenna height was noted for each frequency found.

Final measurements were made in the semi-anechoic chamber using calibrated, linearly polarized broadband and horn antennas. The test setup was configured to the setup that produced the worst case emissions. The spectrum analyzer was set to investigate all frequencies required for testing to compare the highest radiated disturbances with respect to the specified limits. The turntable containing the EUT was rotated through 360 degrees and the height of the receive antenna was varied 1 to 4 meters and stopped at the azimuth and height producing the maximum emission. Each emission was maximized by changing the orientation of the EUT through three orthogonal planes and changing the polarity of the receive antenna, whichever produced the worst-case emissions. According to 3dB Beamwidth of horn antenna, the horn antenna should be always directed to the EUT when rising height.

4. ANTENNA REQUIREMENTS

Excerpt from §15.203 of the FCC Rules/Regulations:

“An intentional radiator antenna shall be designed to ensure that no antenna other than that furnished by the responsible party can be used with the device. The use of a permanently attached antenna or of an antenna that uses a unique coupling to the intentional radiator shall be considered sufficient to comply with the provisions of this section.”

- The antenna of the Smart Phone is **permanently attached**.
- There are no provisions for connection to an external antenna.

Conclusion:

The **Smart Phone FCC ID: 2AAA6-S950** unit complies with the requirement of §15.203.

5. TEST EQUIPMENT CALIBRATION DATA

Conducted Emissions

Instrument	Manufacturer	Type No.	Serial No.	Cali. Interval	Cali. Due Date
EMI Test Receiver	R&S	ESR7	101209	1 year	2014/11/08
Two-Line V-Network	R&S	ENV216	101683	1 year	2014/11/08
Two-Line V-Network	R&S	ENV216	101684	1 year	2014/11/08
Temperature/ Meter Humidity	Anymetre	TH101B	SR2-01	1 year	2014/11/15

Radiated Emission

Instrument	Manufacturer	Type No.	Serial No.	Cali. Interval	Cali. Due Date
Spectrum Analyzer	Agilent	E4447A	MY45300136	1 year	2014/11/08
Preamplifier	MRT	AP01G18	1310002	1 year	2014/10/07
Preamplifier	MRT	AP18G40	1310003	1 year	2014/10/07
Loop Antenna	Schwarzbeck	FMZB1519	1519-041	1 year	2014/11/24
TRILOG Antenna	Schwarzbeck	VULB9162	9162-047	1 year	2014/11/24
Broad-Band Horn Antenna	Schwarzbeck	BBHA9120D	9120D-1167	1 year	2014/11/24
Broadband Horn Antenna	Schwarzbeck	BBHA9170	9170-549	1 year	2014/12/11
Temperature/Humidity Meter	Anymetre	TH101B	AC1-01	1 year	2014/11/15

Conducted Test Equipment

Instrument	Manufacturer	Type No.	Serial No.	Cali. Interval	Cali. Due Date
Spectrum Analyzer	Agilent	N9010A	MY5144016A	1 year	2015/01/04
Power Sensor	Agilent	U2021XA	MY52450003	1 year	2014/12/14
Temperature/Humidity Meter	Anymetre	TH101B	TR3-01	1 year	2014/11/15

6. MEASUREMENT UNCERTAINTY

Where relevant, the following test uncertainty levels have been estimated for tests performed on the EUT as specified in CISPR 16-4-2. This uncertainty represents an expanded uncertainty expressed at approximately the 95% confidence level using a coverage factor of $k = 2$.

AC Conducted Emission Measurement
Measuring Uncertainty for a Level of Confidence of 95% ($U=2Uc(y)$): 150kHz~30MHz: $\pm 3.46\text{dB}$
Radiated Emission Measurement
Measuring Uncertainty for a Level of Confidence of 95% ($U=2Uc(y)$): 9kHz ~ 1GHz: $\pm 4.18\text{dB}$ 1GHz ~ 40GHz: $\pm 4.76\text{dB}$

7. TEST RESULT

7.1. Summary

Company Name: **SENWA MEXICO,S.A.DE C.V**
 FCC ID: **2AAA6-S950**
 Method/System: **Frequency Hopping Spread Spectrum (FHSS)**
 Number of Channels: **79**

FCC Part Section(s)	Test Description	Test Limit	Test Condition	Test Result	Reference
15.247(a)(1)(iii)	20dB Bandwidth	< 1 MHz only if using less than 15 non- overlapping channels	Conducted	PASS	Section 7.2
15.247(b)(1)	Peak Transmitter Output Power	<1 Watt if > 75 non- overlapping channels used		PASS	Section 7.3
15.247(a)(1)	Channel Separation	> 2/3 of 20 dB BW for systems with Output Power < 125mW		PASS	Section 7.4
15.247(a)(1)(iii)	Number of Channels	> 15 Channels		PASS	Section 7.5
15.247(a)(1)(iii)	Time of Occupancy	< 0.4 sec in 31.6 sec period		PASS	Section 7.6
15.247(d)	Band Edge / out- of-Band Emissions	Conducted \geq 20dBc		PASS	Section 7.7, Section 7.8
15.205 15.209	General Field Strength Limits (Restricted Bands and Radiated Emission Limits)	Emissions in restricted bands must meet the radiated limits detailed in 15.209	Radiated	PASS	Section 7.9, Section 7.10
15.207	AC Conducted Emissions 150kHz – 30MHz	< FCC 15.207 limits	Line Conducted	Pass	Section 7.11

Notes:

- 1) All modes of operation and data rates were investigated. The test results shown in the following sections represent the worst case emissions.
- 2) The analyzer plots shown in this section were all taken with a correction table loaded into the analyzer. The correction table was used to account for the losses of the cables and attenuators used as part of the system to connect the EUT to the analyzer at all frequencies of interest.
- 3) All antenna port conducted emissions testing was performed on a test bench with the antenna port of the EUT connected to the spectrum analyzer through calibrated cables and attenuators.

7.2. 20dB Bandwidth Measurement

7.2.1. Test Limit

The maximum permissible 20dB bandwidth is 1 MHz, unless more than 15 non-overlapping channels are employed.

7.2.2. Test Procedure used

ANSI C63.10-2009 – Section 6.9.1

7.2.3. Test Setting

1. Set RBW \geq 1% of the 20dB bandwidth
2. VBW \geq 3 \times RBW
3. Span = approximately 2 to 3 times the 20dB bandwidth, centered on a hopping channel
4. Detector = Peak
5. Trace mode = max hold
6. Sweep = auto couple
7. Allow the trace to stabilize
8. Measure the maximum width of the emission that is constrained by the frequencies associated with the two outermost amplitude points (upper and lower frequencies) that are attenuated by 20 dB relative to the maximum level measured in the fundamental emission.

7.2.4. Test Setup

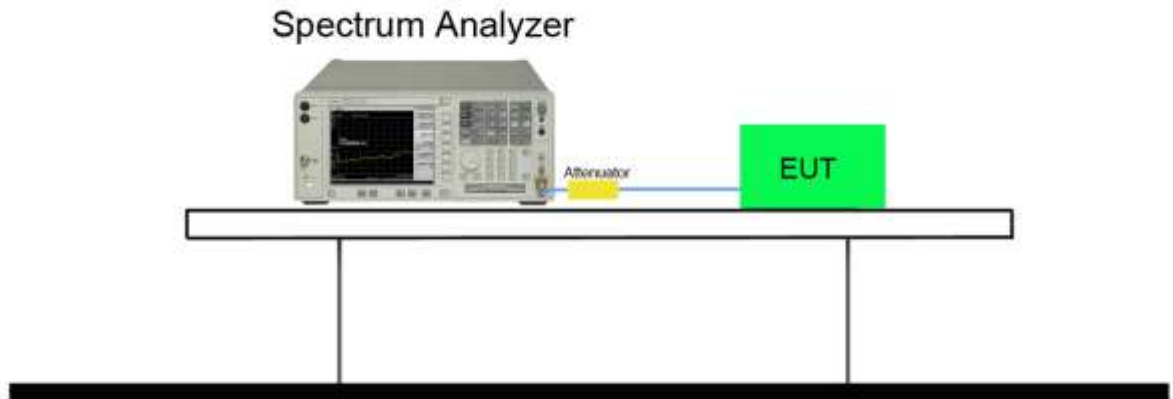

7.2.5. Test Result

Test Mode	Channel No.	Frequency (MHz)	20dB Bandwidth (KHz)	Result
DH5	00	2402	927.5	Pass
DH5	39	2441	929.1	Pass
DH5	78	2480	928.6	Pass
2DH5	00	2402	1265.0	Pass
2DH5	39	2441	1264.0	Pass
2DH5	78	2480	1264.0	Pass
3DH5	00	2402	1270.0	Pass
3DH5	39	2441	1271.0	Pass
3DH5	78	2480	1269.0	Pass

DH5 20dB Bandwidth

Channel 00 (2402MHz)

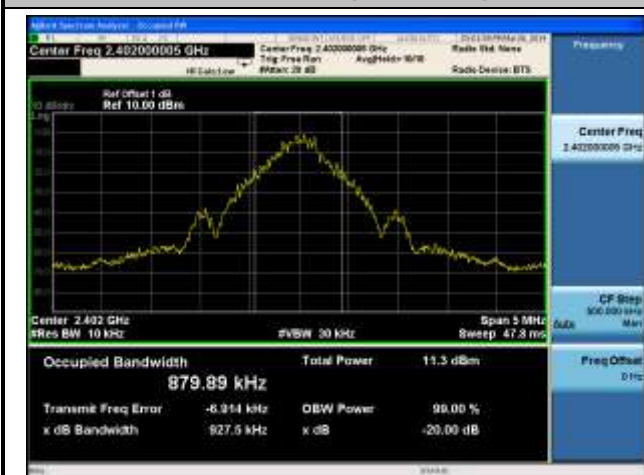

Channel 39 (2441MHz)

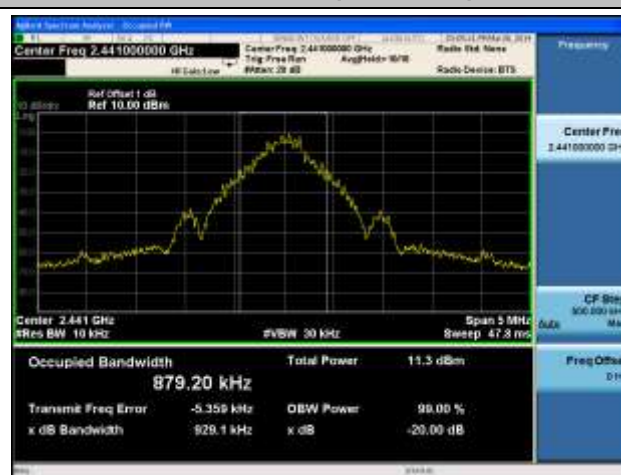

Channel 78 (2480MHz)

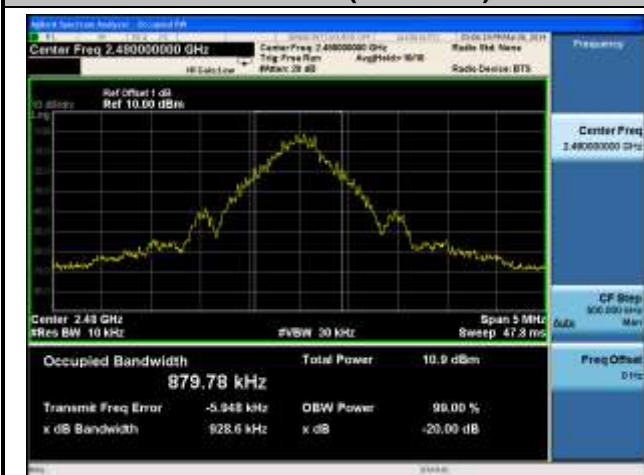

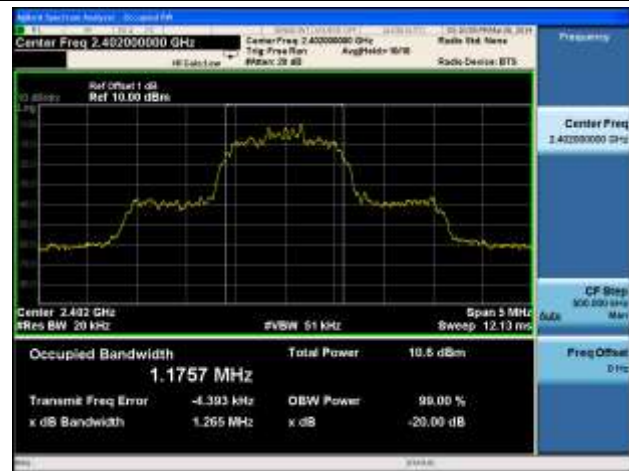
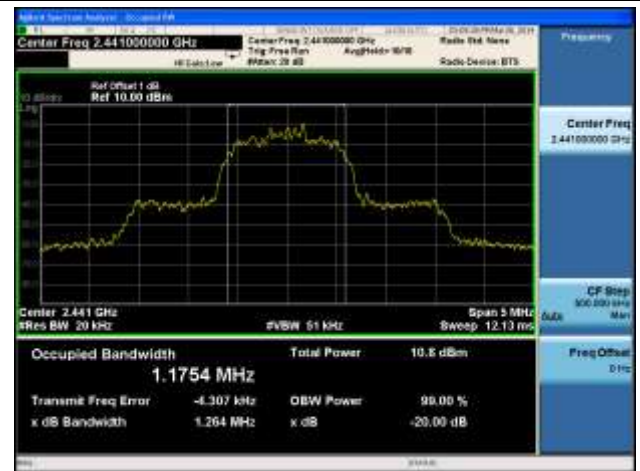
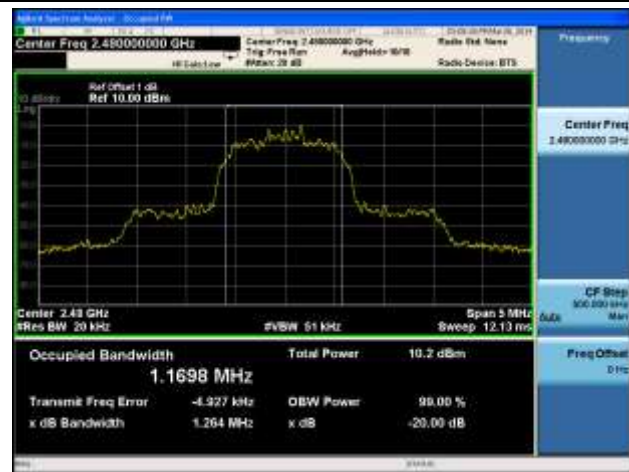
2DH5 20dB Bandwidth
Channel 00 (2402MHz)

Channel 39 (2441MHz)

Channel 78 (2480MHz)

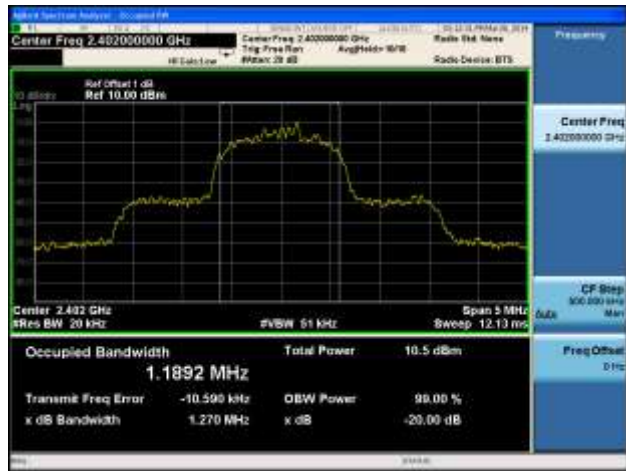
3DH5 20dB Bandwidth

Channel 00 (2402MHz)



Channel 39 (2441MHz)



Channel 78 (2480MHz)



7.3. Output Power Measurement

7.3.1. Test Limit

The maximum out power permissible output power is 1 Watt for frequency hopping systems operating in the 2400-2483.5 MHz band employing at least 75 non-overlapping hopping channels.

7.3.2. Test Procedure Used

ANSI C63.10-2009 – Section 6.10.1

7.3.3. Test Setting

1. Set RBW \geq the 20 dB bandwidth of the emission being measured.
2. VBW $\geq 3 \times$ RBW
3. Span = approximately 2 to 3 times the 20dB bandwidth, centered on a hopping channel
4. Detector = Peak
5. Trace mode = max hold
6. Sweep = auto couple
7. Allow the trace to stabilize, Use the marker-to-peak function to set the marker to the peak of the emission. The indicated level is the peak output power (don't forget added the external attenuation and cable loss)

7.3.4. Test Setup

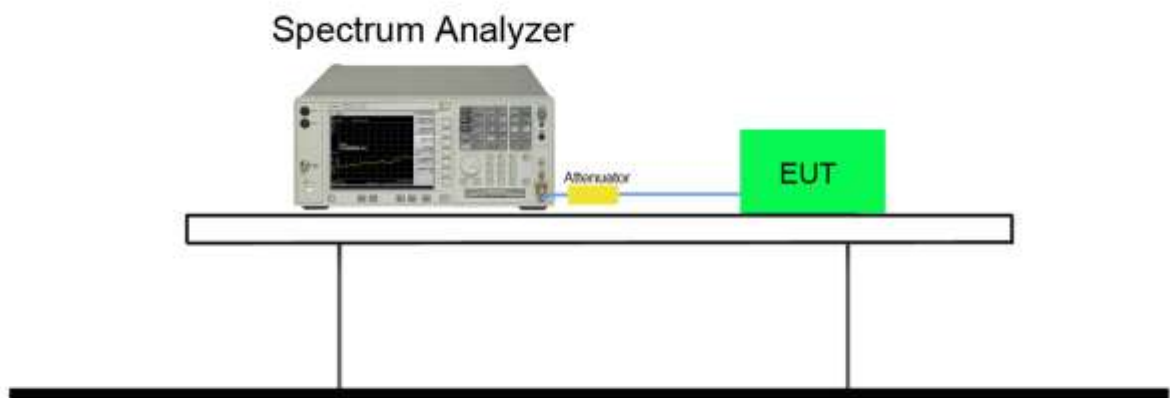

7.3.5. Test Result

Test Mode	Channel No.	Frequency (MHz)	Peak Power	
			(dBm)	(mW)
DH5	00	2402	4.521	2.832
DH5	39	2441	4.754	2.988
DH5	78	2480	4.610	2.891
2DH5	00	2402	3.806	2.402
2DH5	39	2441	4.117	2.580
2DH5	78	2480	3.867	2.436
3DH5	00	2402	3.889	2.448
3DH5	39	2441	4.203	2.632
3DH5	78	2480	3.867	2.436

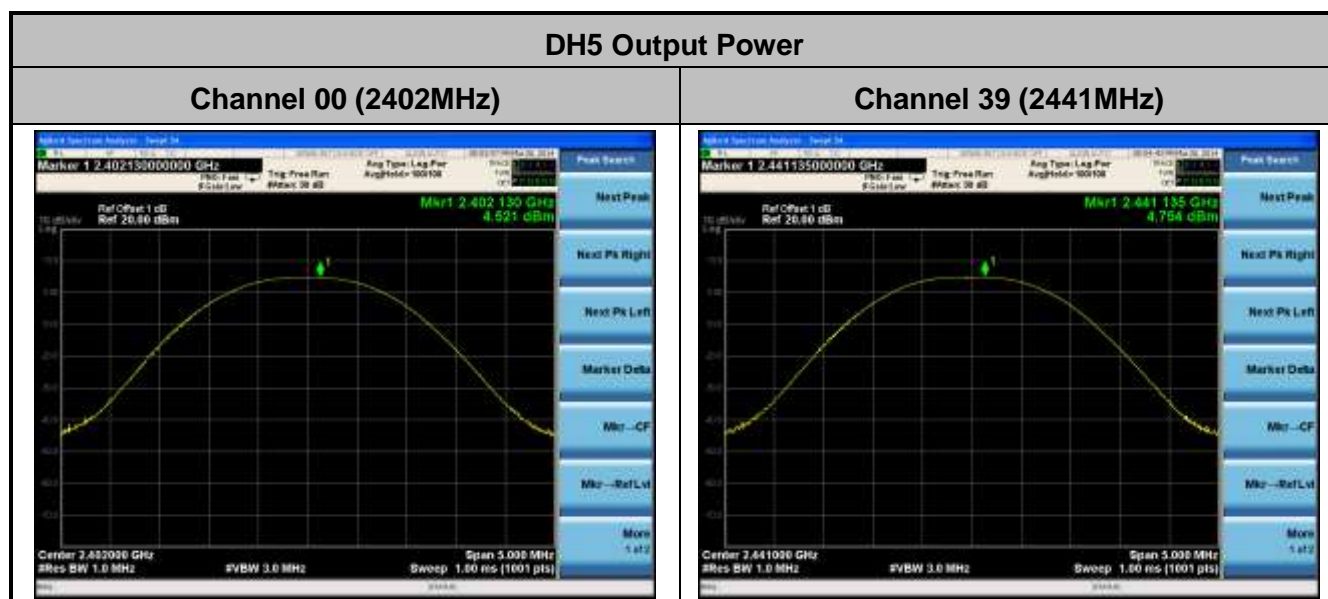

Channel 78 (2480MHz)



2DH5 Output Power

Channel 00 (2402MHz)

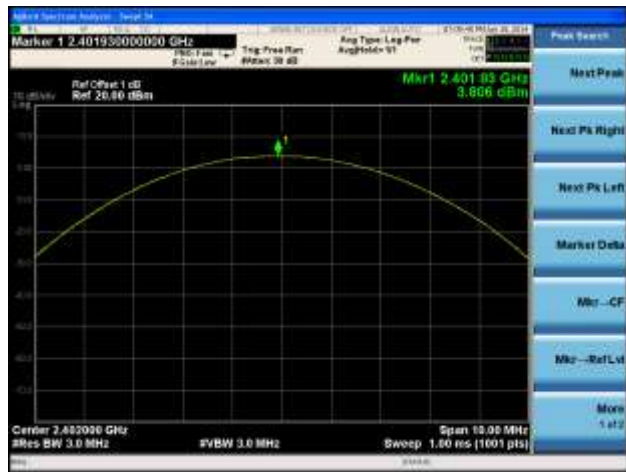

Channel 39 (2441MHz)



Channel 78 (2480MHz)



3DH5 Output Power

Channel 00 (2402MHz)



Channel 39 (2441MHz)

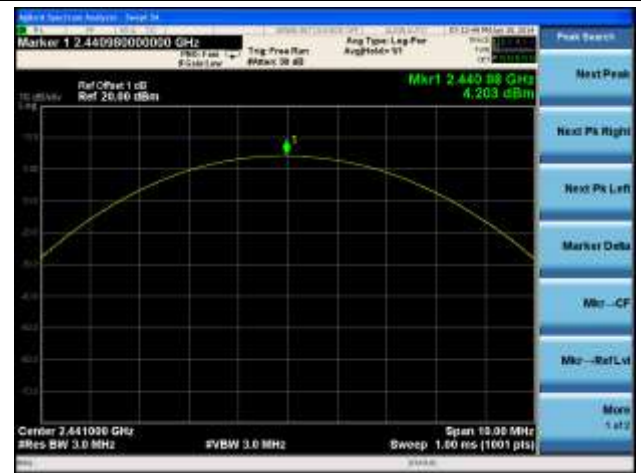

Channel 78 (2480MHz)

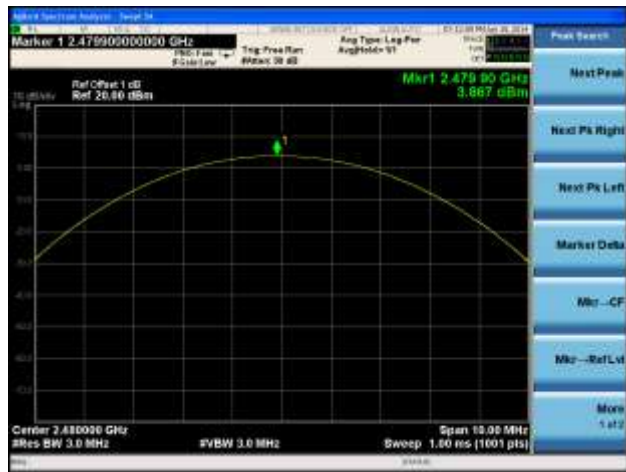

7.4. Carrier Frequency Separation Measurement

7.4.1. Test Limit

The minimum permissible channel separation for this system is 2/3 the value of the 20dB BW.

7.4.2. Test Procedure Used

ANSI C63.10-2009 – Section 7.7.2

7.4.3. Test Setting

1. Span = wide enough to capture the peaks of two adjacent channels.
2. RBW \geq 1 % of the span
3. VBW \geq RBW
4. Detector = peak
5. Sweep time = auto couple
6. Trace mode = max hold
7. Trace was allowed to stabilize

7.4.4. Test Setup

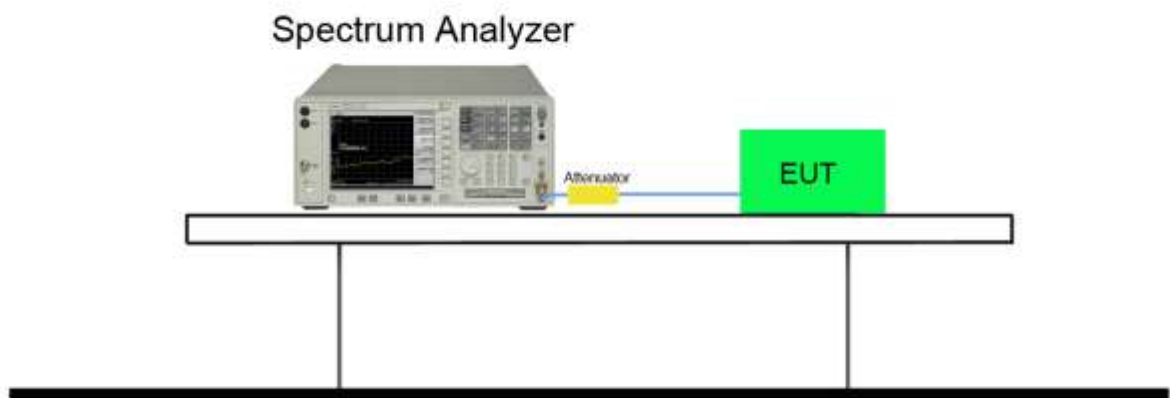

7.4.5. Test Result

Test Mode	Channel No.	Frequency (MHz)	Limit (KHz)	Result
DH5	00	2402	≥618.3	Pass
DH5	39	2441	≥619.4	Pass
DH5	78	2480	≥619.1	Pass
2DH5	00	2402	≥843.3	Pass
2DH5	39	2441	≥842.7	Pass
2DH5	78	2480	≥842.7	Pass
3DH5	00	2402	≥846.7	Pass
3DH5	39	2441	≥847.3	Pass
3DH5	78	2480	≥846.0	Pass

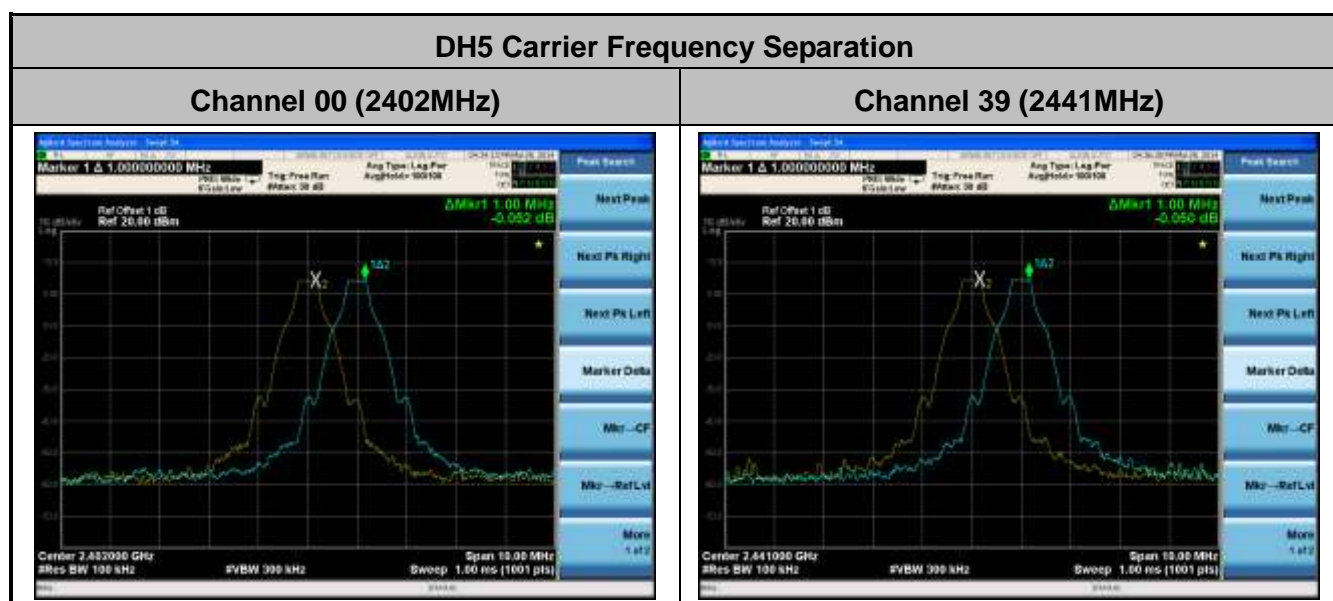

Channel 78 (2480MHz)



2DH5 Carrier Frequency Separation

Channel 00 (2402MHz)



Channel 39 (2441MHz)

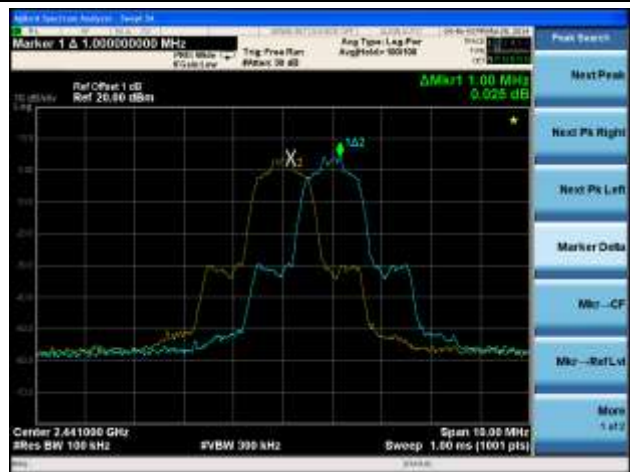

Channel 78 (2480MHz)



3DH5 Carrier Frequency Separation

Channel 00 (2402MHz)



Channel 39 (2441MHz)



Channel 78 (2480MHz)



7.5. Number of Hopping Channels Measurement

7.5.1. Test Limit

This frequency hopping system must employ a minimum of 15 hopping channels.

7.5.2. Test Procedure Used

ANSI C63.10-2009 – Section 7.7.3

7.5.3. Test Setting

1. Span = the frequency band of operation.
2. RBW \geq 1 % of the span
3. VBW \geq RBW
4. Detector = Peak
5. Trace mode = max hold
6. Sweep time = auto couple
7. The trace was allowed to stabilize

7.5.4. Test Setup

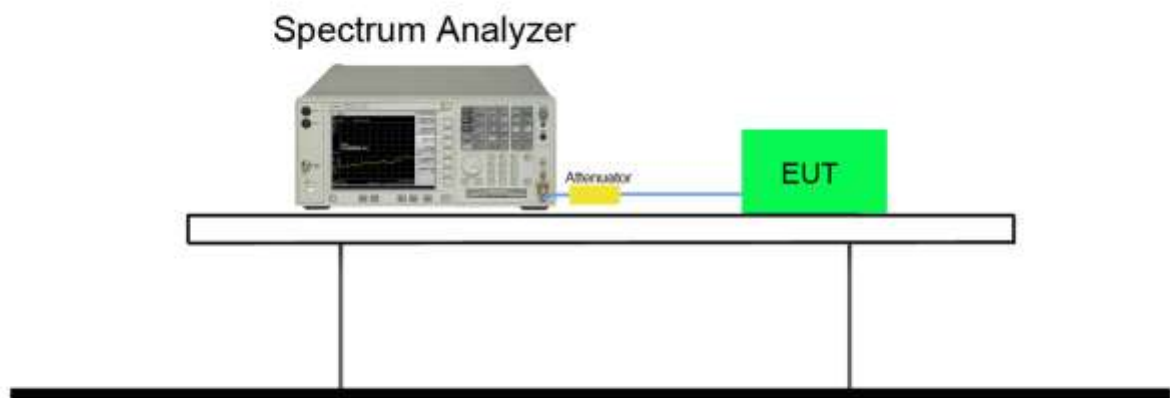

7.5.5. Test Result

Test Mode (Hopping)	Channel Numbers	Frequency (MHz)	Limit (Hopping Channels)	Result
DH5	79	2402~2480	≥ 15	Pass
2DH5	79	2402~2480	≥ 15	Pass
3DH5	79	2402~2480	≥ 15	Pass

DH5 Number of Hopping Channels

2402 ~ 2421MHz

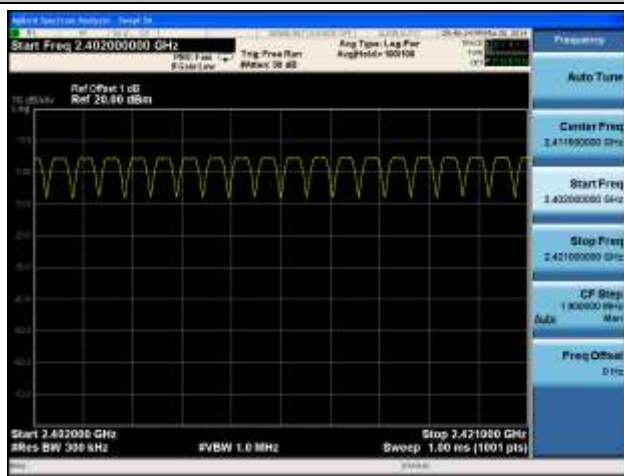

2422 ~ 2441MHz

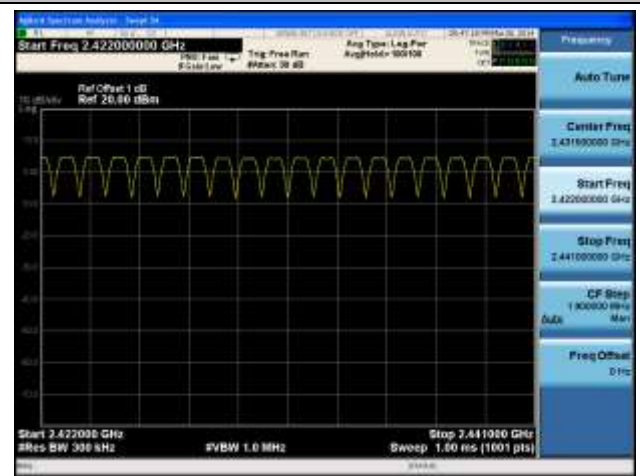

2442 ~ 2461MHz

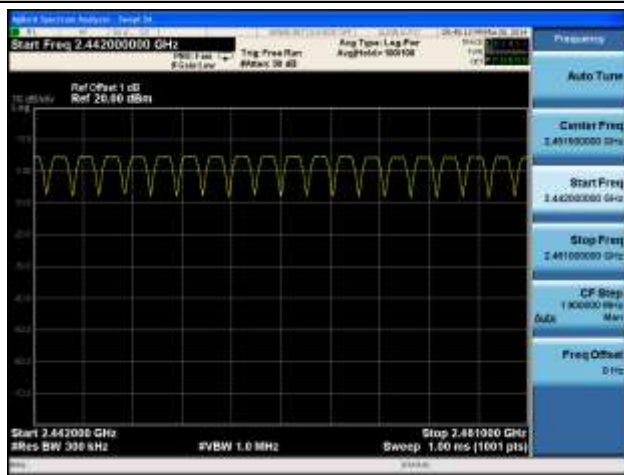

2462 ~ 2480MHz

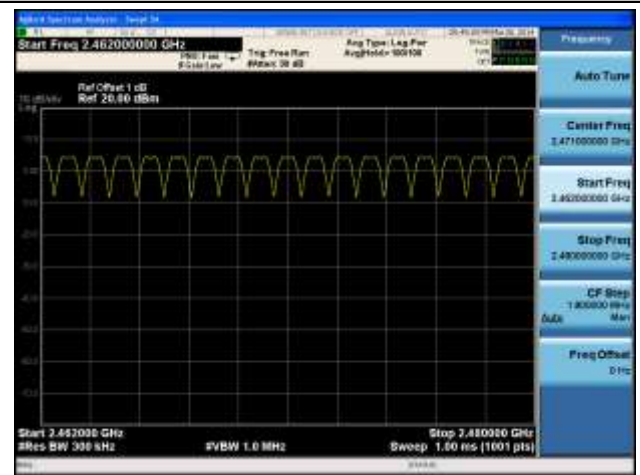

2DH5 Number of Hopping Channels

2402 ~ 2421MHz

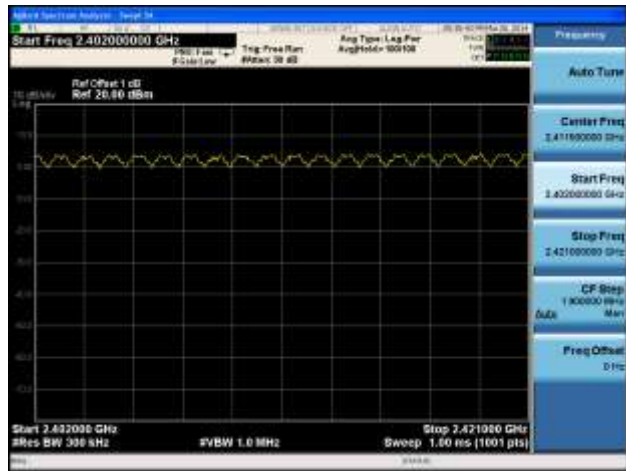

2422 ~ 2441MHz

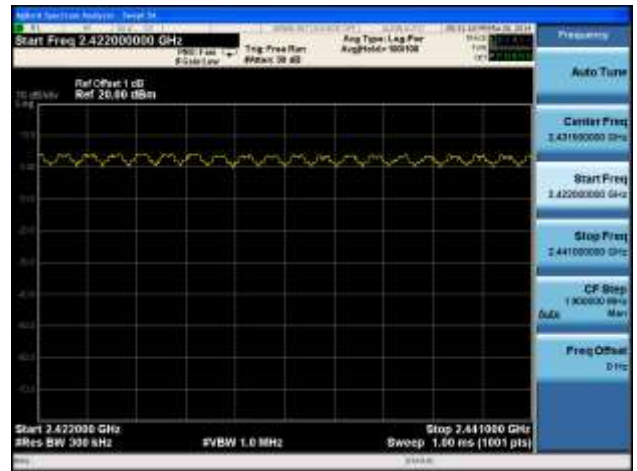

2442 ~ 2461MHz

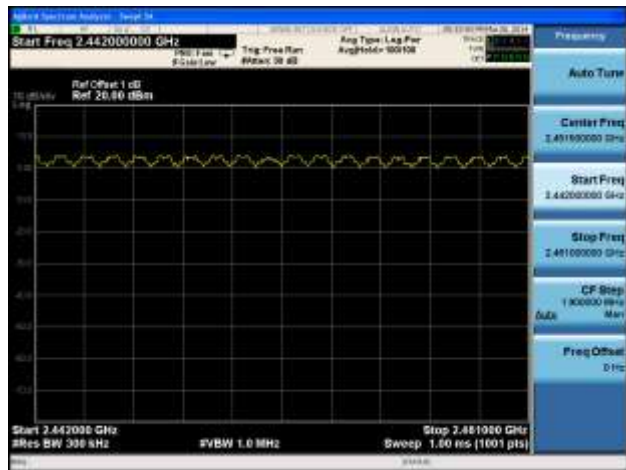

2462 ~ 2480MHz

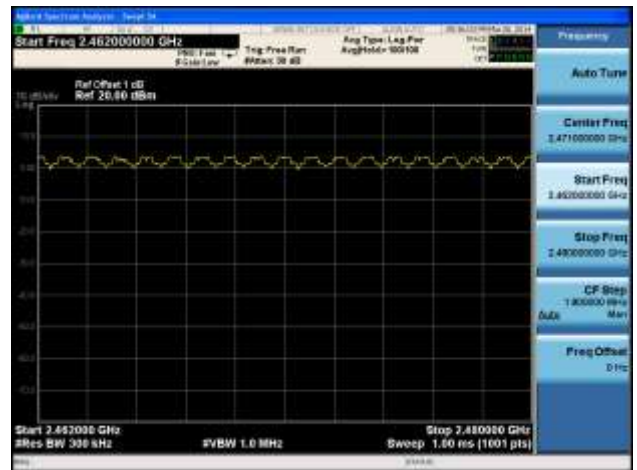

3DH5 Number of Hopping Channels

2402 ~ 2421MHz

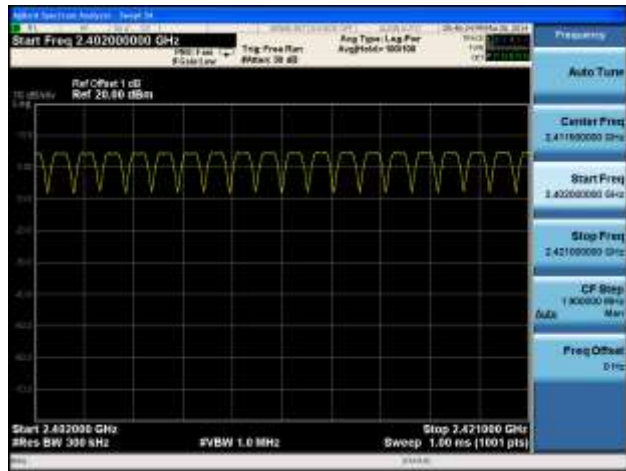

2422 ~ 2441MHz

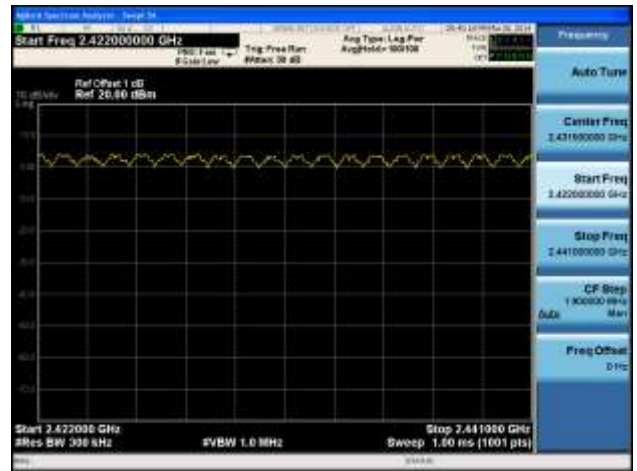

2442 ~ 2461MHz

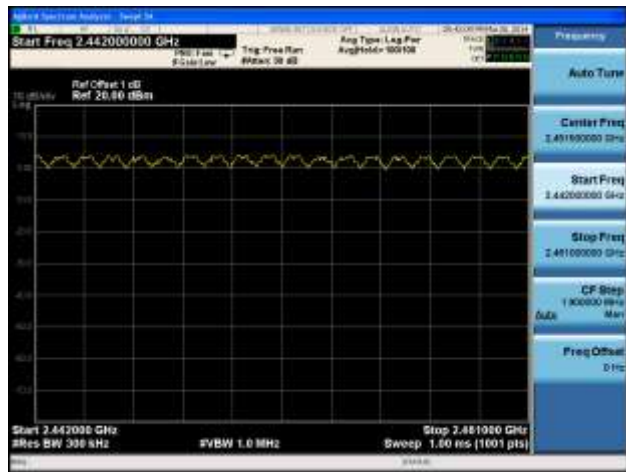

2462 ~ 2480MHz

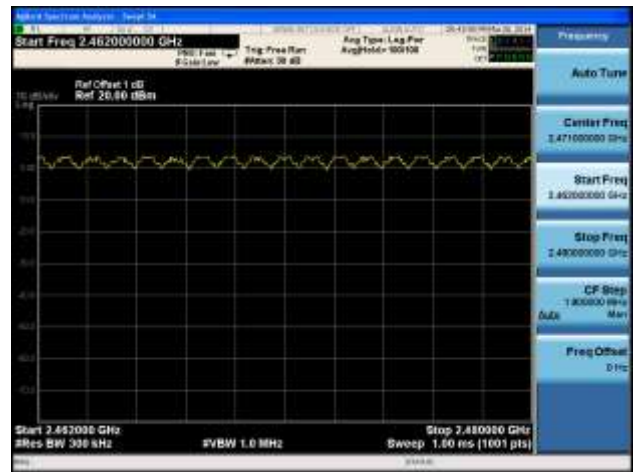

7.6. Time of Occupancy Measurement

7.6.1. Test Limit

The maximum permissible time of occupancy is 400ms within a period of 400ms multiplied by the number of hopping channels employed.

7.6.2. Test Procedure Used

ANSI C63.10-2009 – Section 7.7.4

7.6.3. Test Setting

1. Span = zero span, centered on a hopping channel.
2. RBW = 1MHz
3. VBW \geq RBW
4. Sweep time = as necessary to capture the entire dwell time per hopping channel
5. Detector = Peak
6. Trace mode = max hold

If possible, use the marker-delta function to determine the dwell time. If this value varies with different modes of operation (data rate, modulation format, etc.), repeat this test for each variation.

An oscilloscope may be used instead of a spectrum analyzer. The EUT shall show compliance with the appropriate regulatory limit for the number of hopping channels. A plot of the data shall be included in the test report.

7.6.4. Test Setup

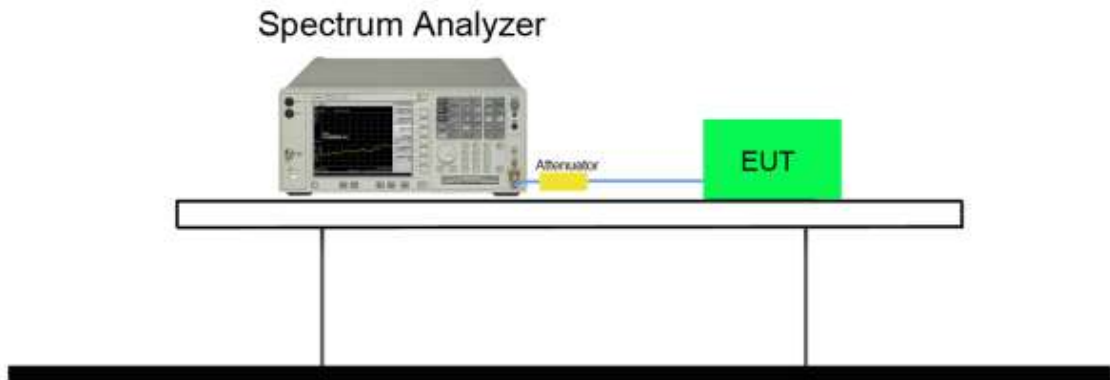

7.6.5. Test Result

Test Mode	Channel No.	Frequency (MHz)	Time of Occupancy (ms)	Limit (ms)	Result
3DH1	39	2441	115.20	< 400	Pass
3DH3	39	2441	257.60	< 400	Pass
3DH5	39	2441	318.08	< 400	Pass

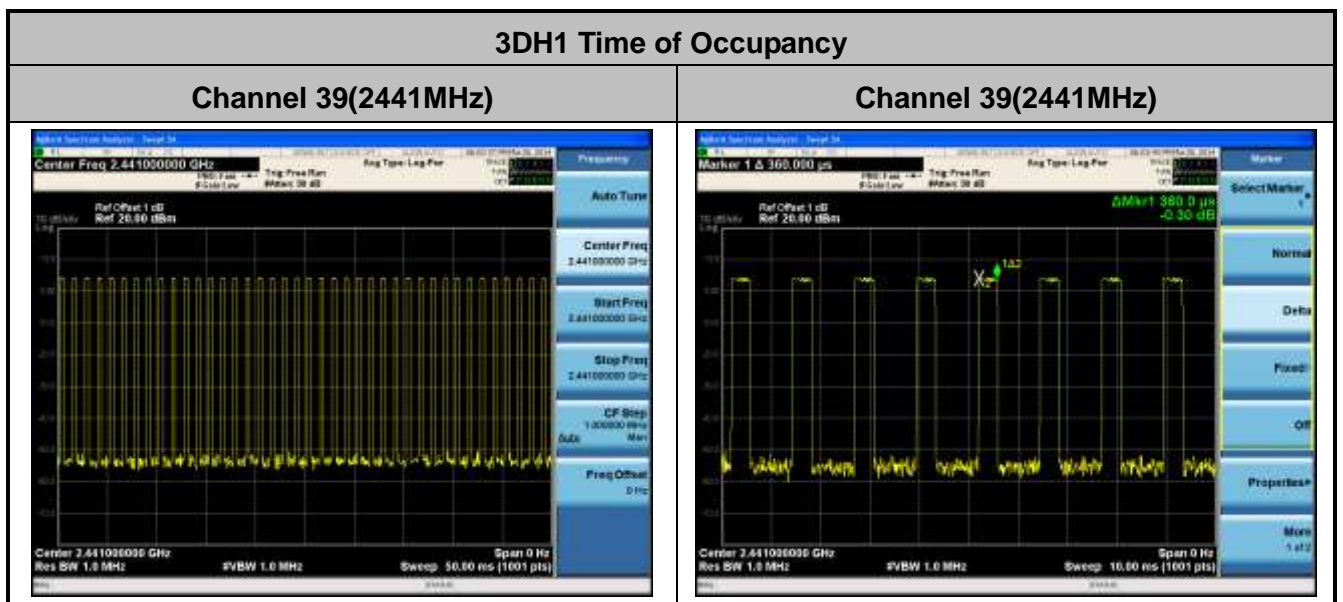

Note: Test Time Period: $0.4 \times 79 = 31.6$ sec, Hopping Times Within 1sec: $40/50$ msec= 800 hops/sec.
 The Maximum Occupancy Lag Time within 31.6sec: $[(0.360\text{ms} \times 800)/79] \times 31.6 = 115.20$ msec.

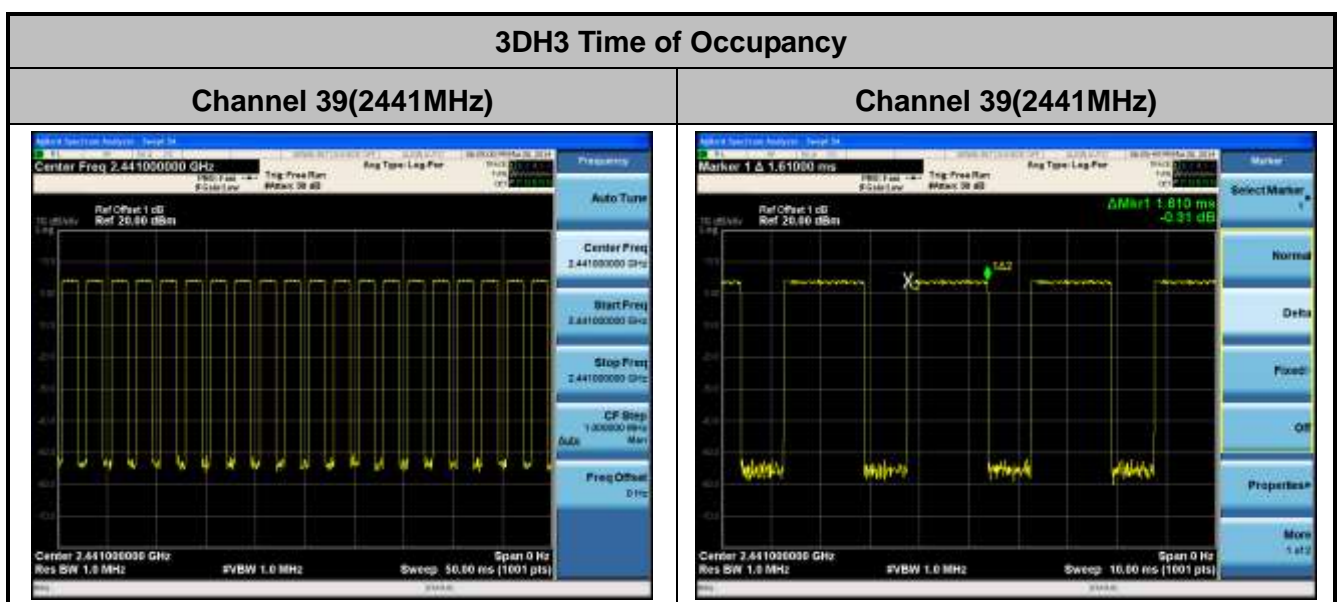

Note: Test Time Period: $0.4 \times 79 = 31.6$ sec, Hopping Times Within 1sec: $20/50$ msec= 400 hops/sec.
 The Maximum Occupancy Lag Time within 31.6sec: $[(1.61\text{ms} \times 400)/79] \times 31.6 = 257.60$ msec.

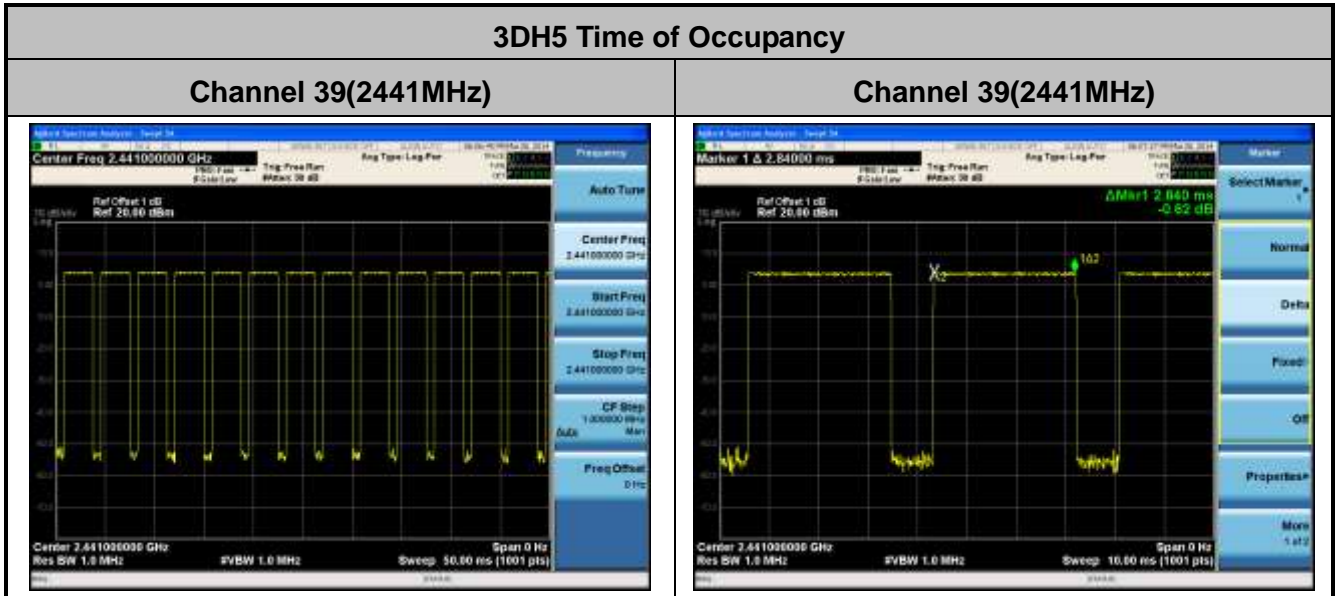

Note: Test Time Period: $0.4 \times 79 = 31.6$ sec, Hopping Times Within 1sec: $14/50$ msec=280 hops/sec.

The Maximum Occupancy Time within 31.6sec: $[(2.840\text{ms} \times 280)/79] \times 31.6 = 318.08$ msec.

7.7. Band-edge Compliance Measurement

7.7.1. Test Limit

The maximum permissible emission level is 20 dBc. Any emission lying outside of the emission bandwidth and in a restricted band is subject to a field strength limit specified in Section 15.209 of the Title 47 CFR.

7.7.2. Test Procedure Used

ANSI C63.10-2009 – Section 7.7.9

7.7.3. Test Setting

1. Span = wide enough to capture the peak level of the emission operating on the channel closest to the band edge, as well as any modulation products which fall outside of the authorized band of operation.
2. RBW \geq 1% of spectrum analyzer display span
3. VBW \geq RBW
4. Detector = peak
5. Sweep time = auto couple
6. Trace mode = max hold
7. Trace was allowed to stabilize

Allow the trace to stabilize. Set the marker on the emission at the band edge, or on the highest modulation product outside of the band, if this level is greater than that at the band edge. Enable the marker-delta function, then use the marker-to-peak function to move the marker to the peak of the in-band emission.

7.7.4. Test Setup

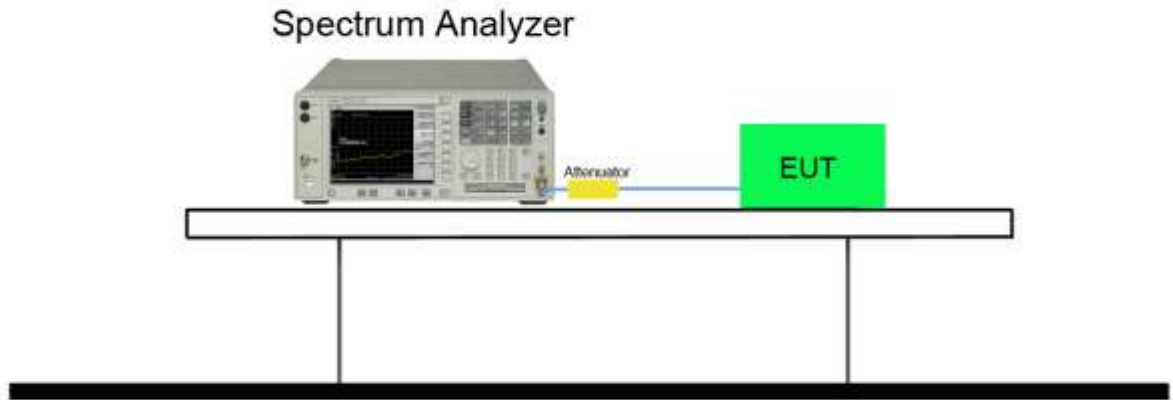

7.7.5. Test Result

Test Mode	Channel No.	Frequency (MHz)	Limit	Result
DH5	00	2402	20dBc	Pass
DH5	78	2480	20dBc	Pass
2DH5	00	2402	20dBc	Pass
2DH5	78	2480	20dBc	Pass
3DH5	00	2402	20dBc	Pass
3DH5	78	2480	20dBc	Pass

DH5 Band-edge Compliance
Channel 00 (2402MHz)

Channel 78 (2480MHz)

2DH5 Band-edge Compliance
Channel 00 (2402MHz)

Channel 78 (2480MHz)

3DH5 Band-edge Compliance

Channel 00 (2402MHz)



Channel 78 (2480MHz)



DH5 Band-edge Compliance within Hopping Mode

Channel 00 (2402MHz)



Channel 78 (2480MHz)

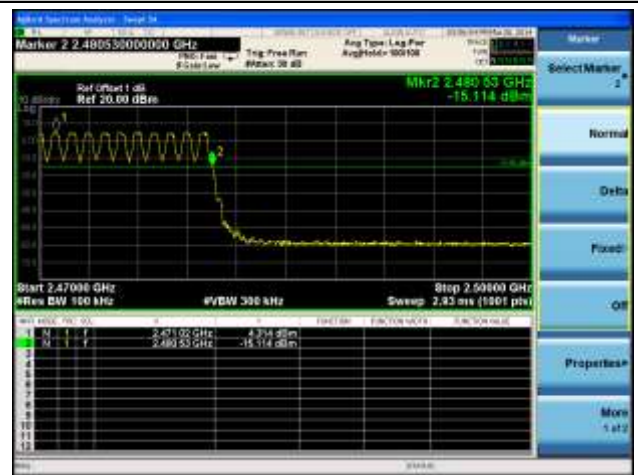

7.8. Conducted Spurious Emissions Measurement

7.8.1. Test Limit

In any 100 kHz bandwidth outside the frequency band in which the spread spectrum or digitally modulated intentional radiator is operating, the radio frequency power that is produced by the intentional radiator shall be at least 20 dB below that in the 100 kHz bandwidth within the band that contains the highest level of the desired power, based on either an RF conducted or a radiated measurement, provided the transmitter demonstrates compliance with the peak conducted or a radiated measurement, provided the transmitter demonstrates compliance with the peak conducted power limits. If the transmitter complies with the conducted power limits based on the use of RMS averaging over a time interval, the attenuation required under this paragraph shall be 30 dB instead of 20 dB.

7.8.2. Test Procedure Used

ANSI C63.10-2009 – Section 7.7.10

7.8.3. Test Setting

1. Span = wide enough to capture the peak level of the in-band emission and all spurious emissions (e.g., harmonics) from the lowest frequency generated in the EUT up through the 10th harmonic. Typically, several plots are required to cover this entire span.
2. RBW = 100 KHz
3. VBW \geq RBW
4. Detector = peak
5. Sweep time = auto couple
6. Trace mode = max hold
7. Trace was allowed to stabilize

Set the marker on the peak of any spurious emission recorded. The level displayed must comply with the limit specified in this section.

7.8.4. Test Setup

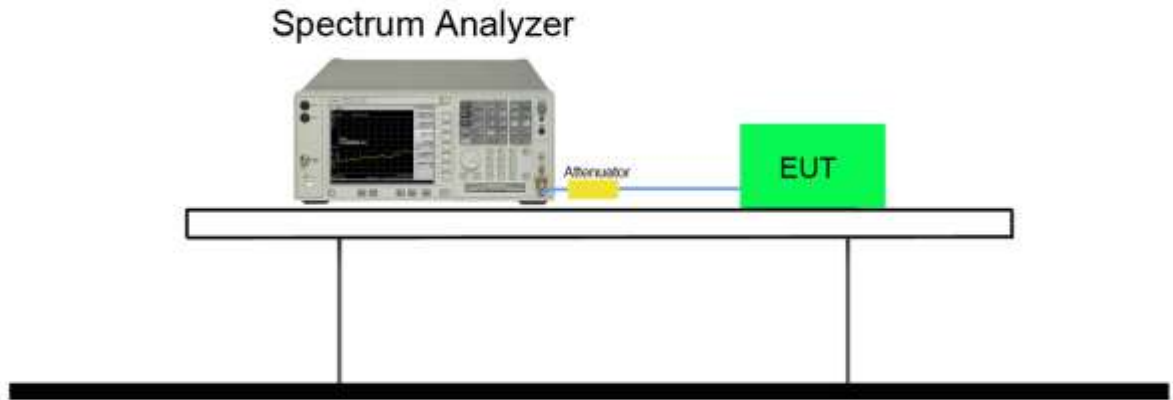

7.8.5. Test Result

Test Mode	Channel No.	Frequency (MHz)	Limit (MHz)	Result
DH5	00	2402	20dBc	Pass
DH5	39	2441	20dBc	Pass
DH5	78	2480	20dBc	Pass
2DH5	00	2402	20dBc	Pass
2DH5	39	2441	20dBc	Pass
2DH5	78	2480	20dBc	Pass
3DH5	00	2402	20dBc	Pass
3DH5	39	2441	20dBc	Pass
3DH5	78	2480	20dBc	Pass

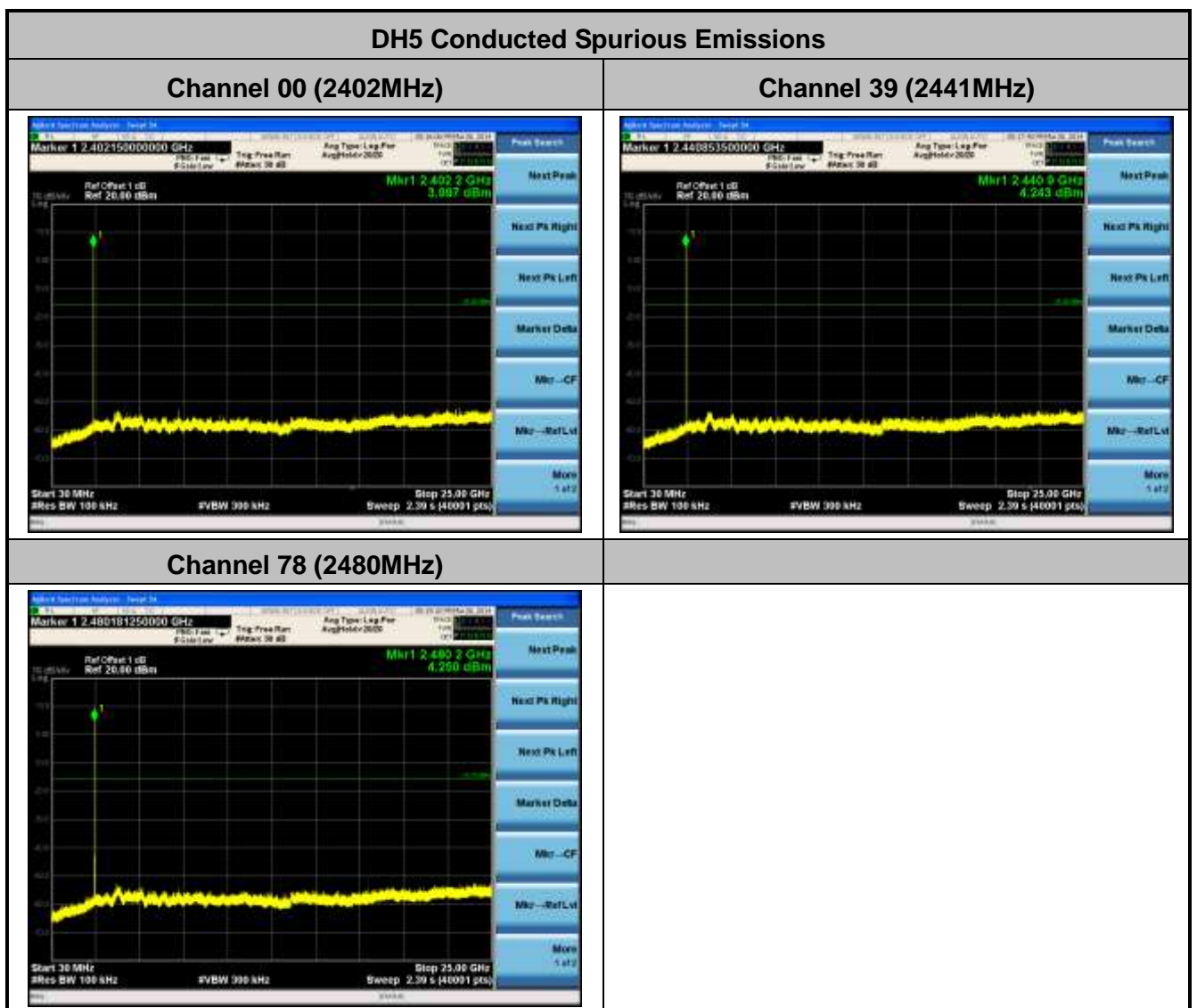

2DH5 Conducted Spurious Emissions

Channel 00 (2402MHz)

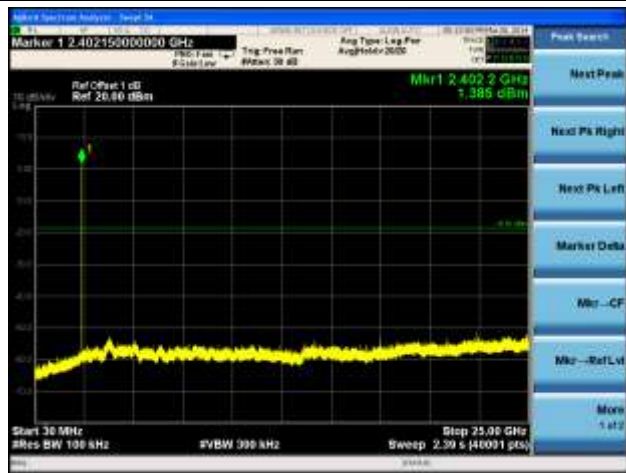

Channel 39 (2441MHz)

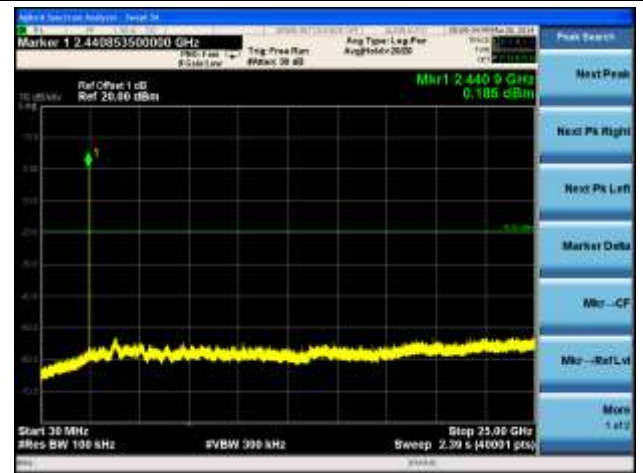

Channel 78 (2480MHz)

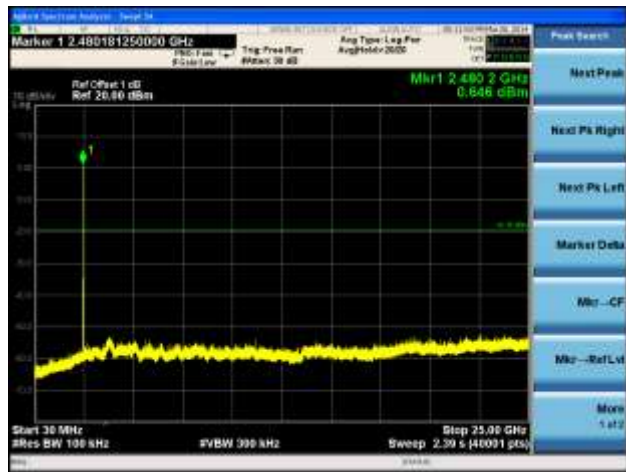

3DH5 Conducted Spurious Emissions

Channel 00 (2402MHz)

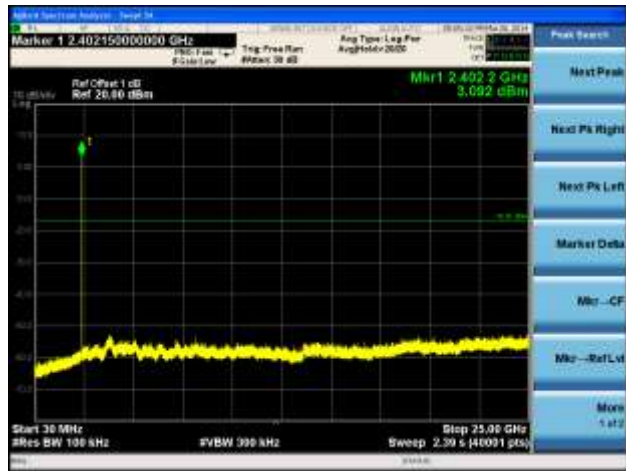

Channel 39 (2441MHz)



Channel 78 (2480MHz)

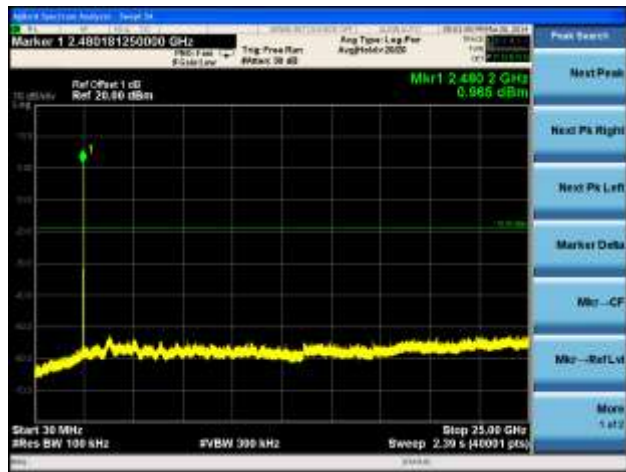

7.9. Radiated Spurious Emission Measurement

7.9.1. Test Limit

All out of band emissions appearing in a restricted band as specified in Section 15.205 of the Title 47 CFR must not exceed the limits shown in Table per Section 15.209.

FCC Part 15 Subpart C Paragraph 15.209		
Frequency [MHz]	Field Strength [V/m]	Measured Distance [Meters]
0.009 – 0.490	2400/F (kHz)	300
0.490 – 1.705	24000/F (kHz)	30
1.705 - 30	30	30
30 - 88	100	3
88 - 216	150	3
216 - 960	200	3
Above 960	500	3

7.9.2. Test Procedure Used

ANSI C63.10-2009 – Section 7.10.1 & Section 7.10.2

7.9.3. Test Setting

Peak Field Strength Measurements

1. Analyzer center frequency was set to the frequency of the radiated spurious emission of interest
2. RBW = 1MHz
3. VBW = 3MHz
4. Detector = peak
5. Sweep time = auto couple
6. Trace mode = max hold
7. Trace was allowed to stabilize

Average Field Strength Measurements

1. Analyzer center frequency was set to the frequency of the radiated spurious emission of interest
2. RBW = 1MHz
3. VBW = 3MHz
4. Detector = power average (RMS)
5. Number of measurement points = 1001 (Number of points must be $> 2 \times \text{span}/\text{RBW}$)
6. Sweep time = auto
7. Trace (RMS) averaging was performed over at least 100 traces

7.9.4. Test Setup

9kHz ~ 30MHz Test Setup:

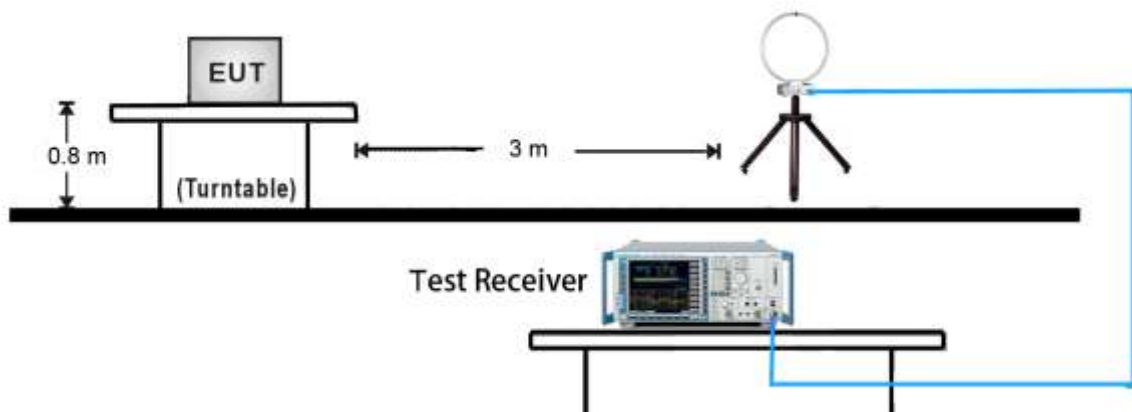

30MHz ~ 1GHz Test Setup:

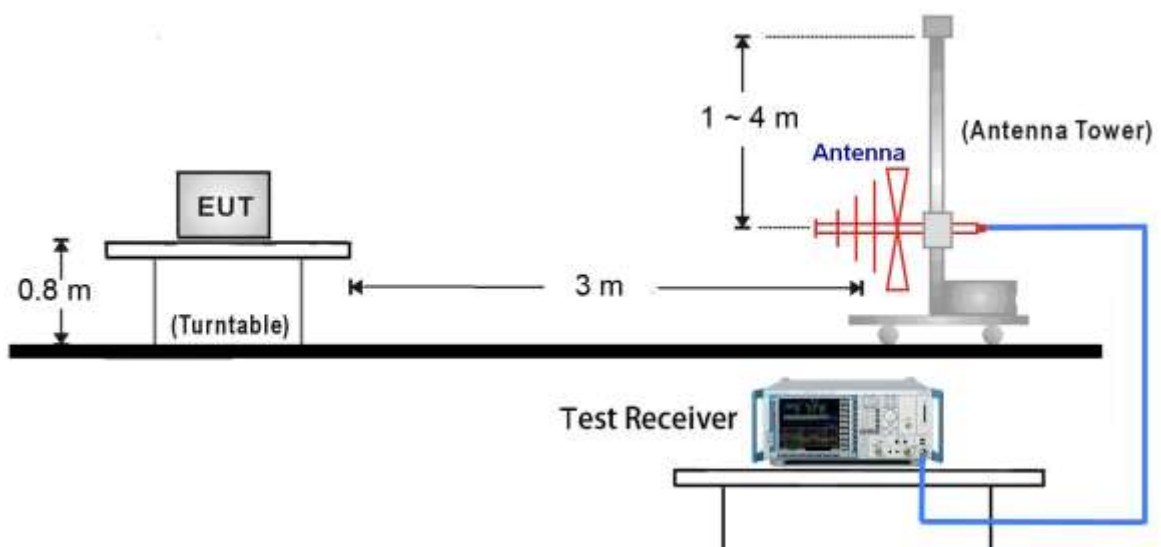

1GHz ~ 25GHz Test Setup:

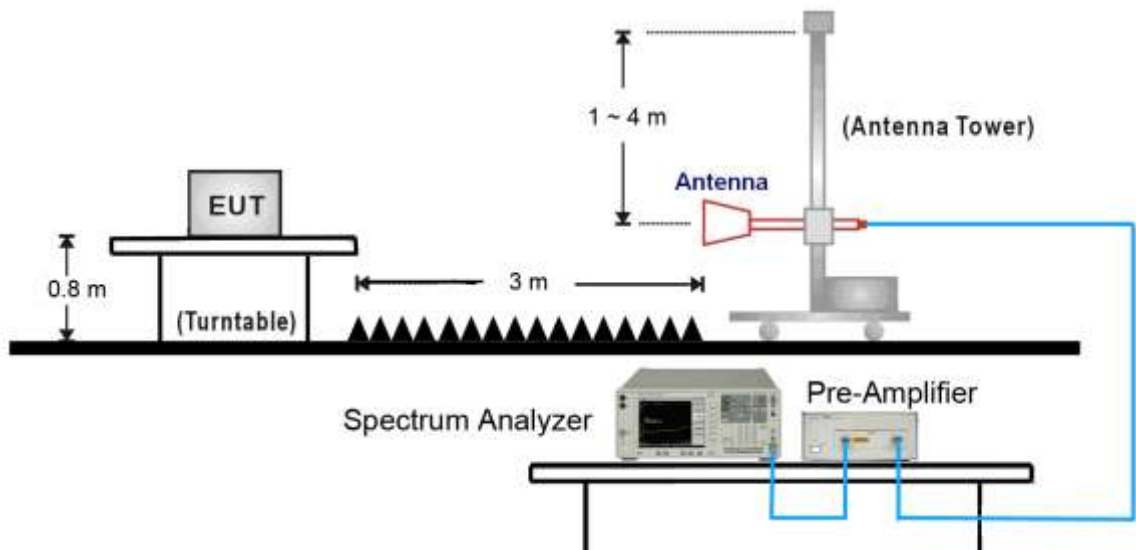

7.9.5. Test Result

Test Mode:	DH5	Test Site:	AC1
Test Channel:	78	Test Engineer:	Roy Cheng
Remark:	1. Average measurement was not performed if peak level lower than average limit. 2. The worst case of Radiated Spurious Emission. 3. Other frequency was 20dB below limit line within 1-18GHz, there is not show in the report.		

Mark	Frequency (MHz)	Reading Level (dB μ V/m)	Factor (dB)	Measure Level (dB μ V/m)	Limit (dB μ V/m)	Margin (dB)	Detector	Polarization
*	4960.0	35.7	6.8	42.5	75.4	-32.9	Peak	Horizontal
*	5292.5	36.4	6.6	43.0	75.4	-32.4	Peak	Horizontal
	7440.0	34.7	14.2	48.9	74.0	-25.1	Peak	Horizontal
	7825.5	34.6	15.1	49.7	74.0	-24.3	Peak	Horizontal
*	4960.0	35.1	6.8	41.9	75.4	-33.5	Peak	Vertical
*	5267.0	35.9	6.6	42.5	75.4	-32.9	Peak	Vertical
	7440.0	34.5	14.2	48.7	74.0	-25.3	Peak	Vertical
	7876.5	34.5	15.0	49.5	74.0	-24.5	Peak	Vertical

Note: "*" is not in restricted band, its limit is 20dBc of the fundamental emission level (95.4dB μ V/m).

The worst case of Radiated Emission 9KHz ~ 1GHz and 18GHz ~ 25GHz:

Engineer: Roy Cheng	
Site: AC1	Time: 2014/04/02 - 19:24
Limit: FCC_Part15.209_RE(3m)	Margin: 0
Probe: VULB9162_0.03-8GHz	Polarity: Horizontal
EUT: Smart Phone	Power: AC 120V/60Hz
Worst Case Mode: DH5 Channel 2480MHz	

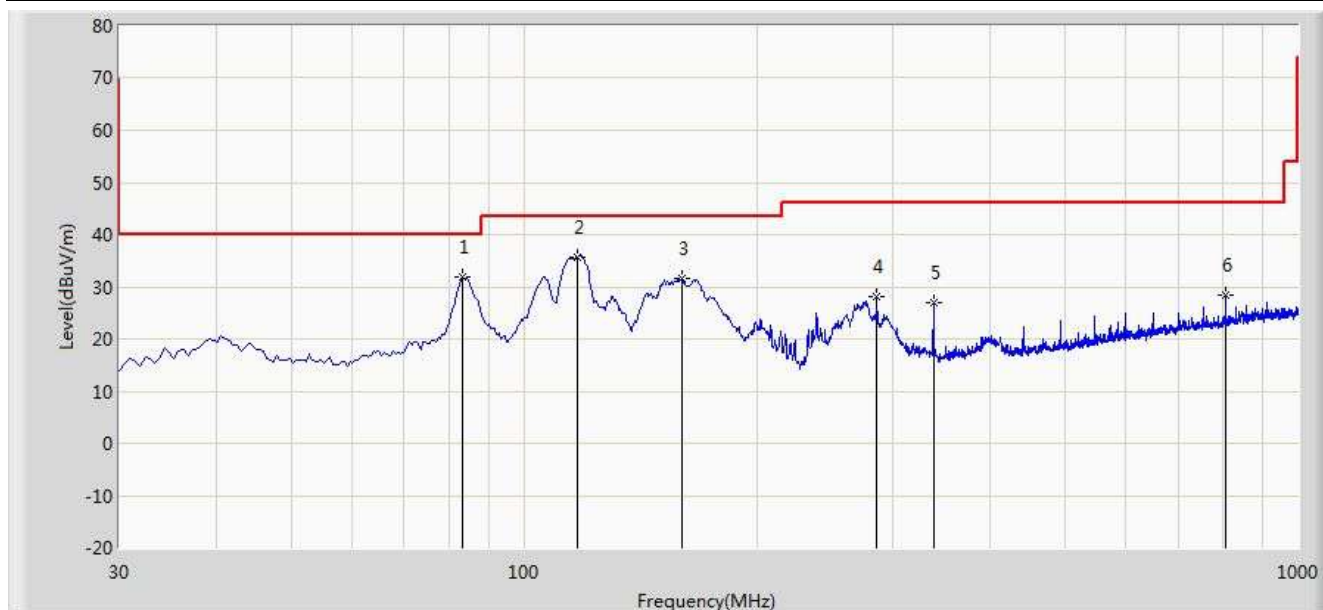

No	Flag	Mark	Frequency (MHz)	Measure Level (dBuV/m)	Reading Level (dBuV)	Over Limit (dB)	Limit (dBuV/m)	Factor	Type
1			83.350	31.825	22.193	-8.175	40.000	9.632	PK
2		*	117.300	35.787	24.363	-7.713	43.500	11.424	PK
3			159.980	31.633	22.111	-11.867	43.500	9.522	PK
4			286.080	27.983	14.110	-18.017	46.000	13.873	PK
5			337.975	26.859	11.709	-19.141	46.000	15.150	PK
6			806.000	28.502	6.307	-17.498	46.000	22.195	PK

Engineer: Roy Cheng	
Site: AC1	Time: 2014/04/02 - 19:28
Limit: FCC_Part15.209_RE(3m)	Margin: 0
Probe: VULB9162_0.03-8GHz	Polarity: Vertical
EUT: Smart Phone	Power: AC 120V/60Hz
Worst Case Mode: DH5 Channel 2480MHz	

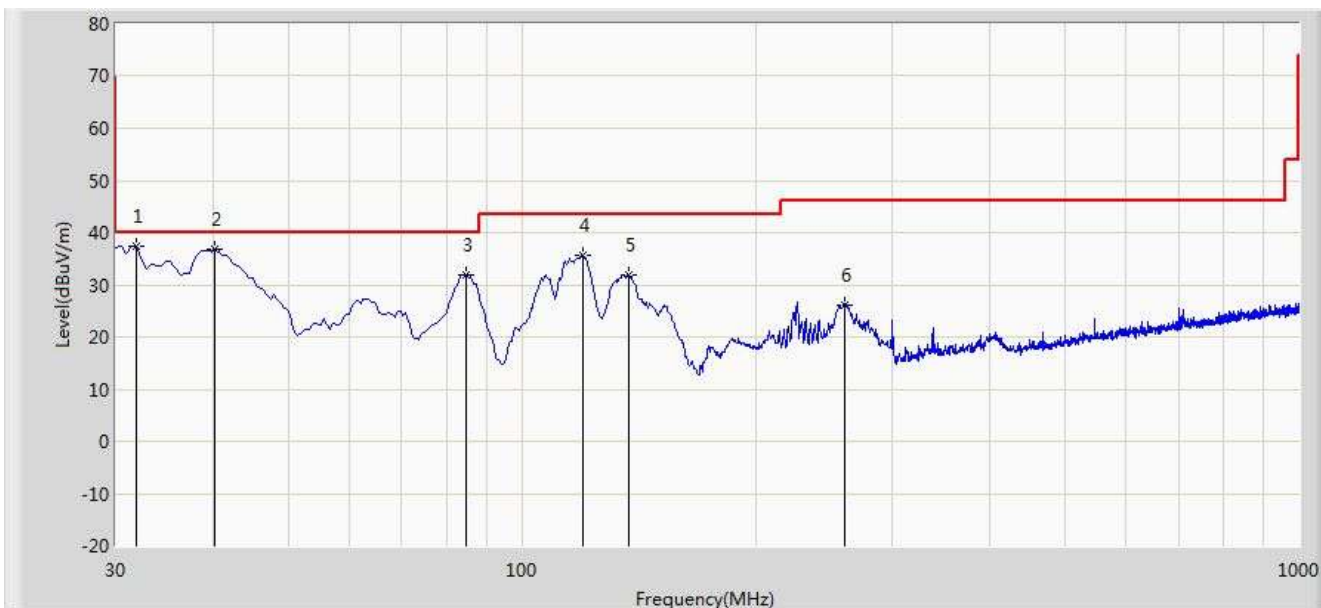

No	Flag	Mark	Frequency (MHz)	Measure Level (dBuV/m)	Reading Level (dBuV)	Over Limit (dB)	Limit (dBuV/m)	Factor	Type
1		*	31.940	37.305	25.049	-2.695	40.000	12.256	PK
2			40.185	36.797	23.047	-3.203	40.000	13.750	PK
3			84.805	31.881	22.053	-8.119	40.000	9.828	PK
4			119.725	35.710	24.661	-7.790	43.500	11.049	PK
5			137.185	31.953	22.613	-11.547	43.500	9.340	PK
6			260.860	26.203	12.701	-19.797	46.000	13.502	PK

Engineer: Roy Cheng	
Site: AC1	Time: 2014/04/02 - 16:39
Limit: FCC_Part15.209_RE(3m)	Margin: 0
Probe: FMZB1519_0.009-30MHz	Polarity: Face On
EUT: Smart Phone	Power: AC 120V/60Hz
Note: There is the ambient noise within frequency range 9kHz~30MHz.	

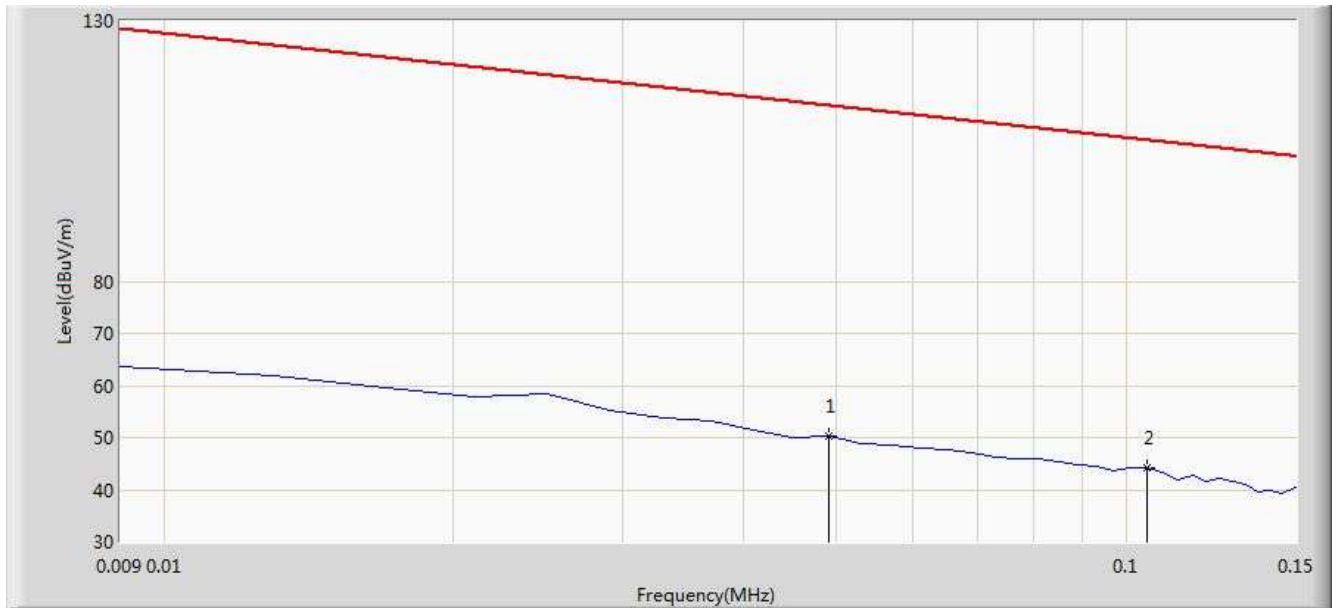

No	Flag	Mark	Frequency (MHz)	Measure Level (dBuV/m)	Reading Level (dBuV)	Over Limit (dB)	Limit (dBuV/m)	Factor	Type
1			0.049	50.367	29.861	-63.422	113.789	20.505	PK
2		*	0.105	44.143	23.996	-63.029	107.173	20.147	PK

Engineer: Roy Cheng	
Site: AC1	Time: 2014/04/02 - 16:41
Limit: FCC_Part15.209_RE(3m)	Margin: 0
Probe: FMZB1519_0.009-30MHz	Polarity: Face On
EUT: Smart Phone	Power: AC 120V/60Hz
Note: There is the ambient noise within frequency range 9kHz~30MHz.	

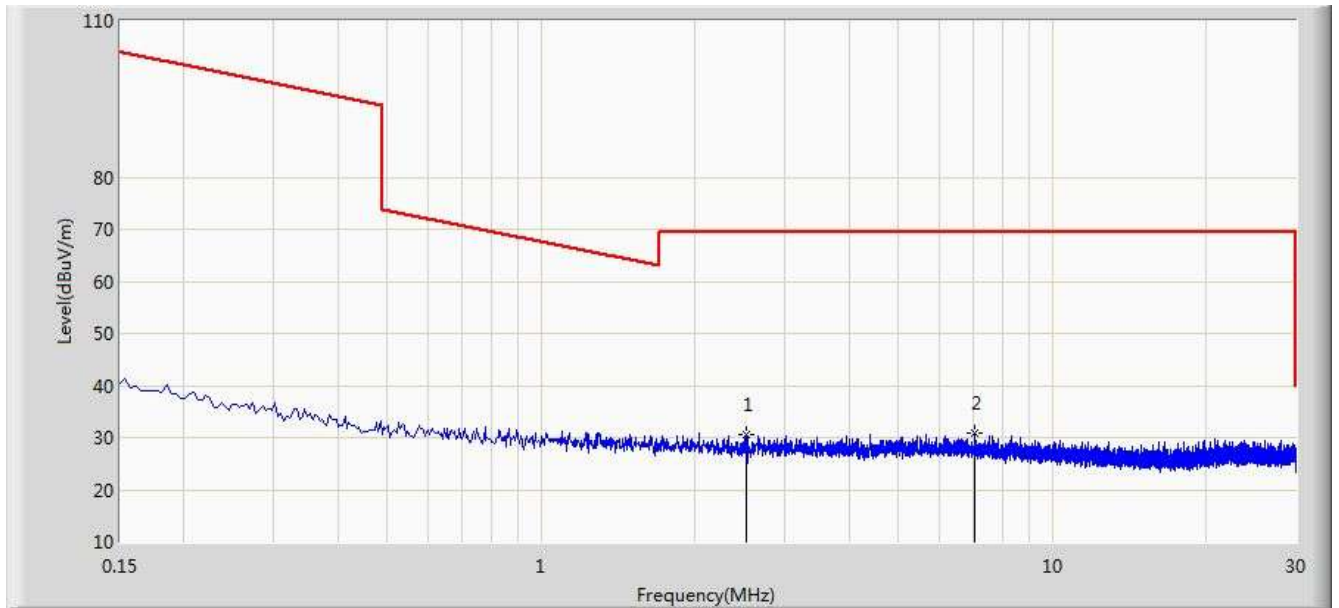

No	Flag	Mark	Frequency (MHz)	Measure Level (dBuV/m)	Reading Level (dBuV)	Over Limit (dB)	Limit (dBuV/m)	Factor	Type
1			2.513	30.495	10.336	-39.005	69.500	20.159	PK
2		*	7.041	30.974	10.579	-38.526	69.500	20.395	PK

Engineer: Roy Cheng	
Site: AC1	Time: 2014/04/02 - 15:33
Limit: FCC_Part15.209_RE(3m)	Margin: 0
Probe: BBHA9170_18-40GHz	Polarity: Horizontal
EUT: Smart Phone	Power: AC 120V/60Hz
Note: There is the ambient noise within frequency range 18GHz~25GHz.	

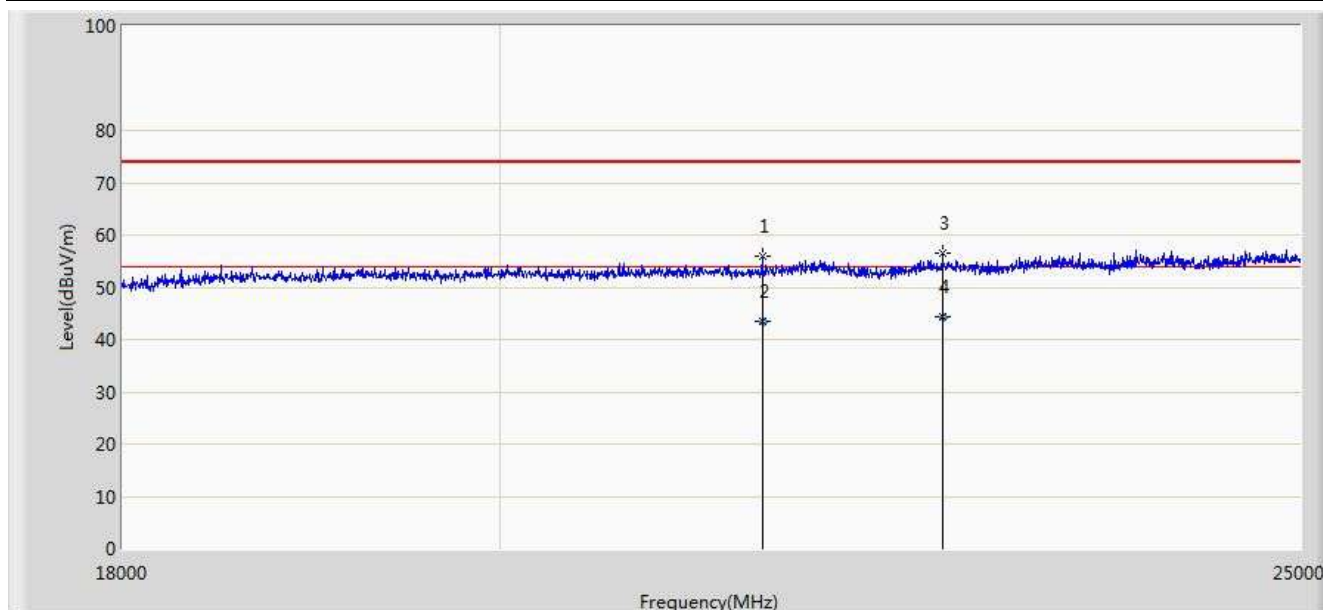

No	Flag	Mark	Frequency (MHz)	Measure Level (dBuV/m)	Reading Level (dBuV)	Over Limit (dB)	Limit (dBuV/m)	Factor	Type
1			21517.500	55.869	17.883	-18.131	74.000	37.986	PK
2			21517.650	43.351	5.365	-10.649	54.000	37.986	AV
3			22630.500	56.509	18.223	-17.491	74.000	38.286	PK
4		*	22630.540	44.310	6.024	-9.690	54.000	38.286	AV

Engineer: Roy Cheng	
Site: AC1	Time: 2014/04/02 - 16:44
Limit: FCC_Part15.209_RE(3m)	Margin: 0
Probe: BBHA9170_18-40GHz	Polarity: Vertical
EUT: Smart Phone	Power: AC 120V/60Hz
Note: There is the ambient noise within frequency range 18GHz~25GHz.	

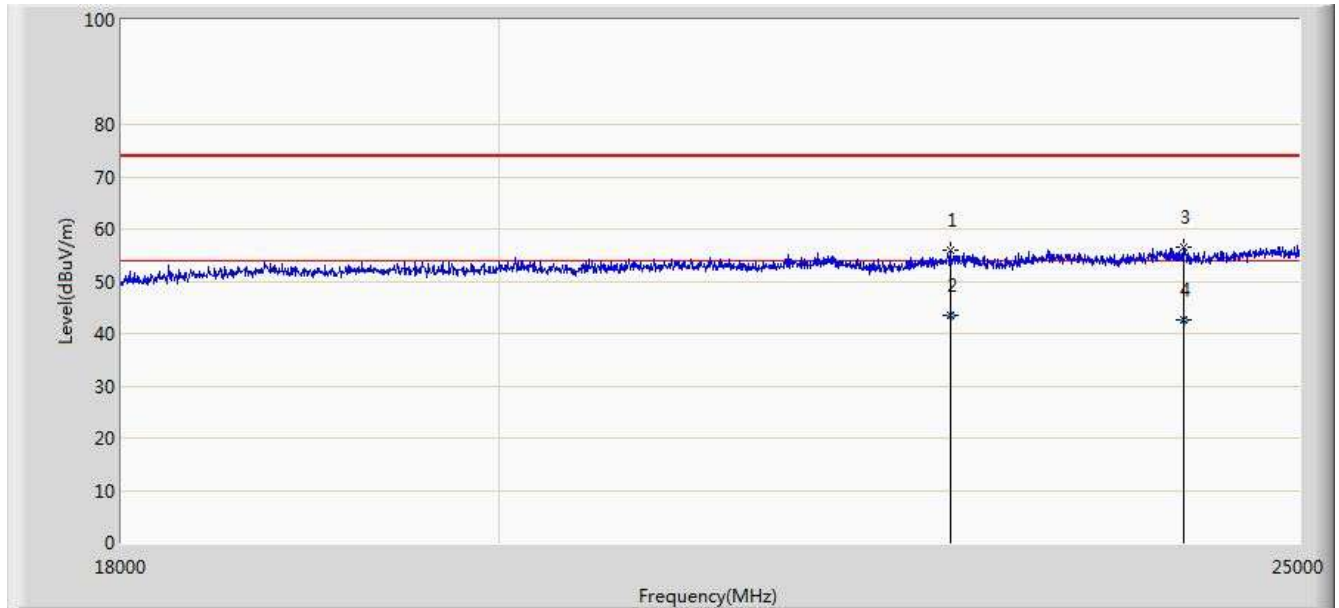

No	Flag	Mark	Frequency (MHz)	Measure Level (dBuV/m)	Reading Level (dBuV)	Over Limit (dB)	Limit (dBuV/m)	Factor	Type
1			22686.500	55.811	17.457	-18.189	74.000	38.354	PK
2			22686.540	43.598	5.244	-10.402	54.000	38.354	AV
3			24205.500	56.430	17.607	-17.570	74.000	38.823	PK
4		*	24205.658	42.518	3.695	-11.482	54.000	38.823	AV

7.10. Radiated Restricted Band Edge Measurement

7.10.1. Test Result

Engineer: Roy Cheng	
Site: AC1	Time: 2014/04/03 - 16:49
Limit: FCC_Part15.209_RE(3m)	Margin: 0
Probe: BBHA9120D_1-18GHz	Polarity: Horizontal
EUT: Smart Phone	Power: AC 120V/60Hz
Worst Case Mode: DH5 Channel 2402MHz	

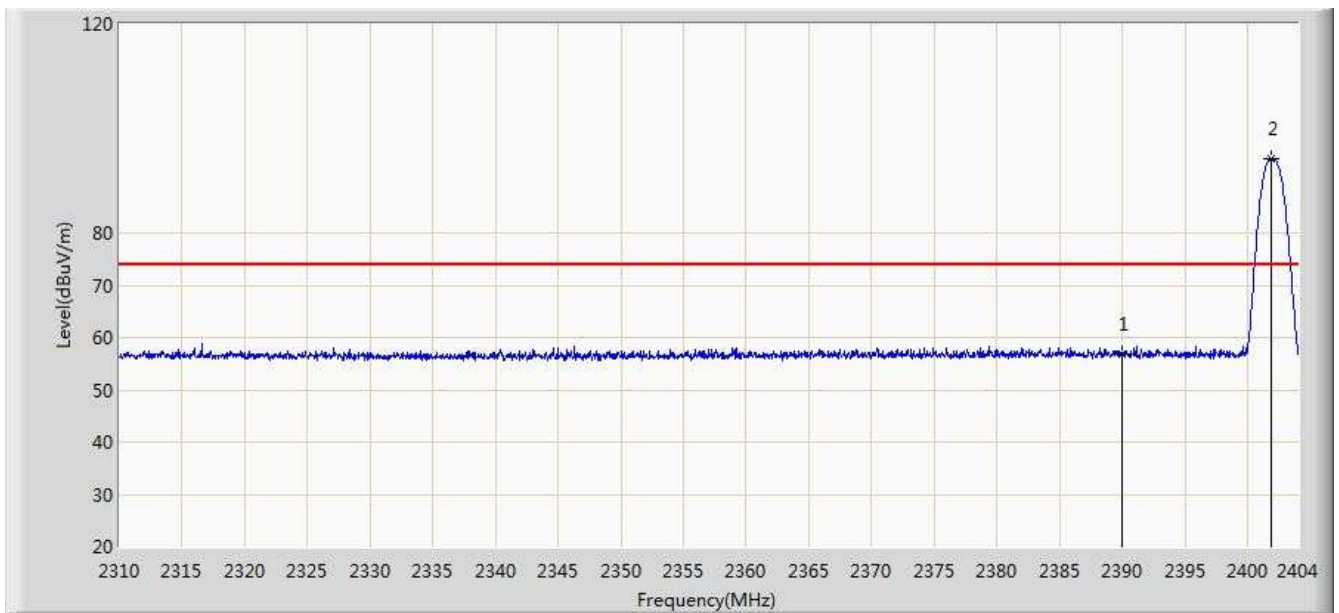

No	Flag	Mark	Frequency (MHz)	Measure Level (dBuV/m)	Reading Level (dBuV)	Over Limit (dB)	Limit (dBuV/m)	Factor	Type
1			2390.000	56.676	25.992	-17.324	74.000	30.684	PK
2		*	2401.885	94.240	63.579	N/A	N/A	30.661	PK

Engineer: Roy Cheng	
Site: AC1	Time: 2014/04/03 - 16:56
Limit: FCC_Part15.209_RE(3m)	Margin: 0
Probe: BBHA9120D_1-18GHz	Polarity: Horizontal
EUT: Smart Phone	Power: AC 120V/60Hz
Worst Case Mode: DH5 Channel 2402MHz	

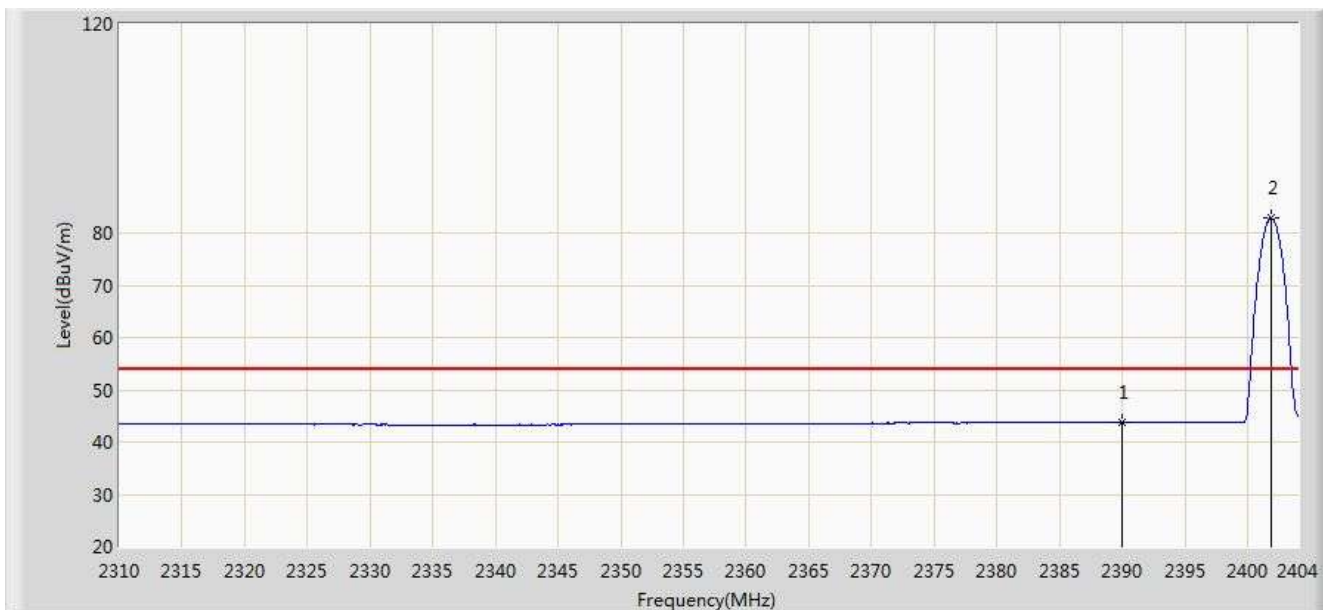

No	Flag	Mark	Frequency (MHz)	Measure Level (dBuV/m)	Reading Level (dBuV)	Over Limit (dB)	Limit (dBuV/m)	Factor	Type
1			2390.000	43.751	13.067	-10.249	54.000	30.684	AV
2		*	2401.885	82.838	52.177	N/A	N/A	30.661	AV

Engineer: Roy Cheng	
Site: AC1	Time: 2014/04/03 - 16:56
Limit: FCC_Part15.209_RE(3m)	Margin: 0
Probe: BBHA9120D_1-18GHz	Polarity: Vertical
EUT: Smart Phone	Power: AC 120V/60Hz
Worst Case Mode: DH5 Channel 2402MHz	

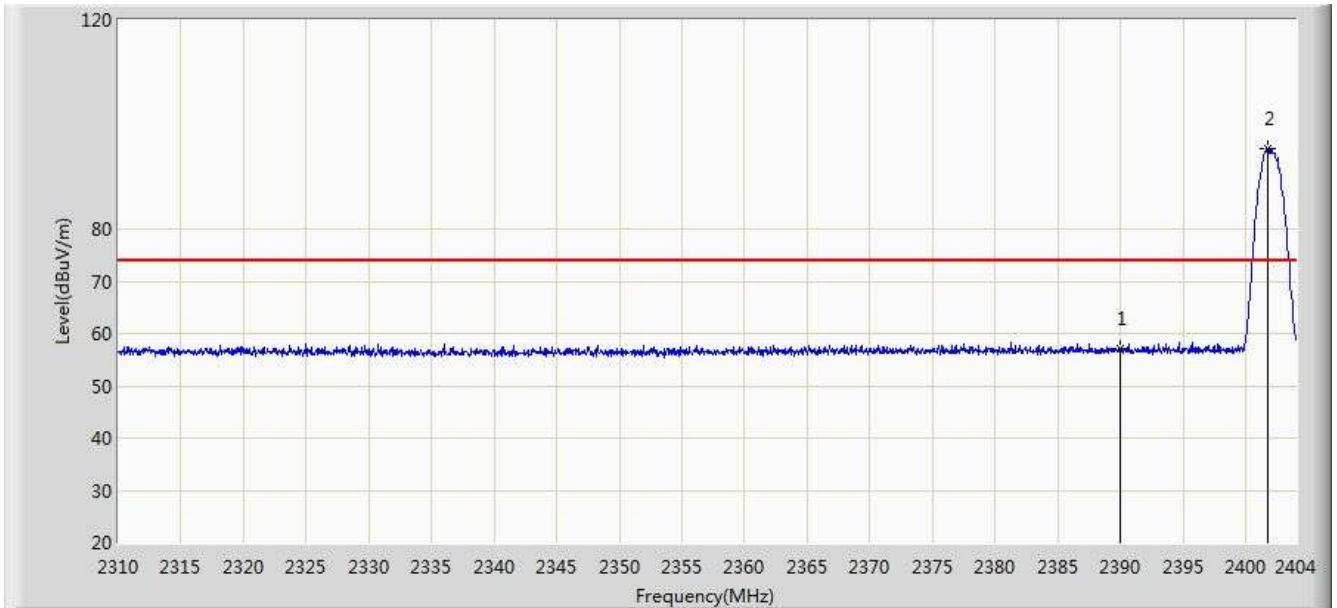

No	Flag	Mark	Frequency (MHz)	Measure Level (dBuV/m)	Reading Level (dBuV)	Over Limit (dB)	Limit (dBuV/m)	Factor	Type
1			2390.000	57.007	26.323	-16.993	74.000	30.684	PK
2		*	2401.744	95.424	64.762	N/A	N/A	30.661	PK

Engineer: Roy Cheng	
Site: AC1	Time: 2014/04/03 - 17:00
Limit: FCC_Part15.209_RE(3m)	Margin: 0
Probe: BBHA9120D_1-18GHz	Polarity: Vertical
EUT: Smart Phone	Power: AC 120V/60Hz
Worst Case Mode: DH5 Channel 2402MHz	

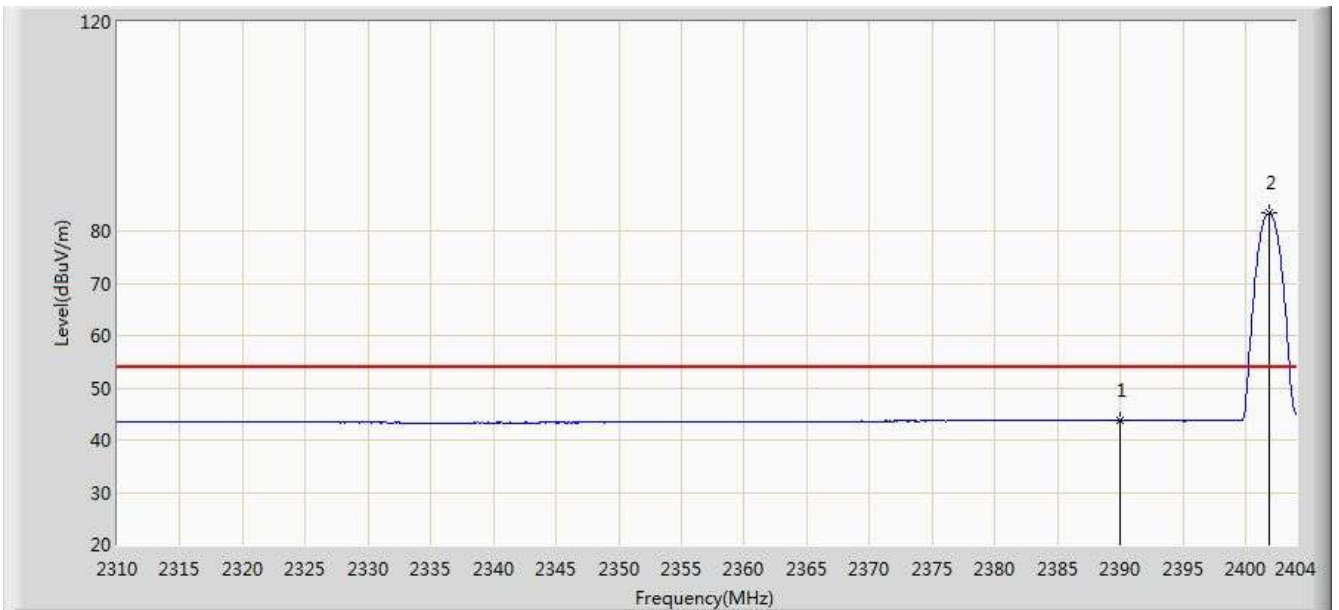

No	Flag	Mark	Frequency (MHz)	Measure Level (dBuV/m)	Reading Level (dBuV)	Over Limit (dB)	Limit (dBuV/m)	Factor	Type
1			2390.000	43.795	13.111	-10.205	54.000	30.684	AV
2		*	2401.885	83.418	52.757	N/A	N/A	30.661	AV

Engineer: Roy Cheng	
Site: AC1	Time: 2014/04/03 - 17:01
Limit: FCC_Part15.209_RE(3m)	Margin: 0
Probe: BBHA9120D_1-18GHz	Polarity: Horizontal
EUT: Smart Phone	Power: AC 120V/60Hz
Worst Case Mode: DH5 Channel 2480MHz	

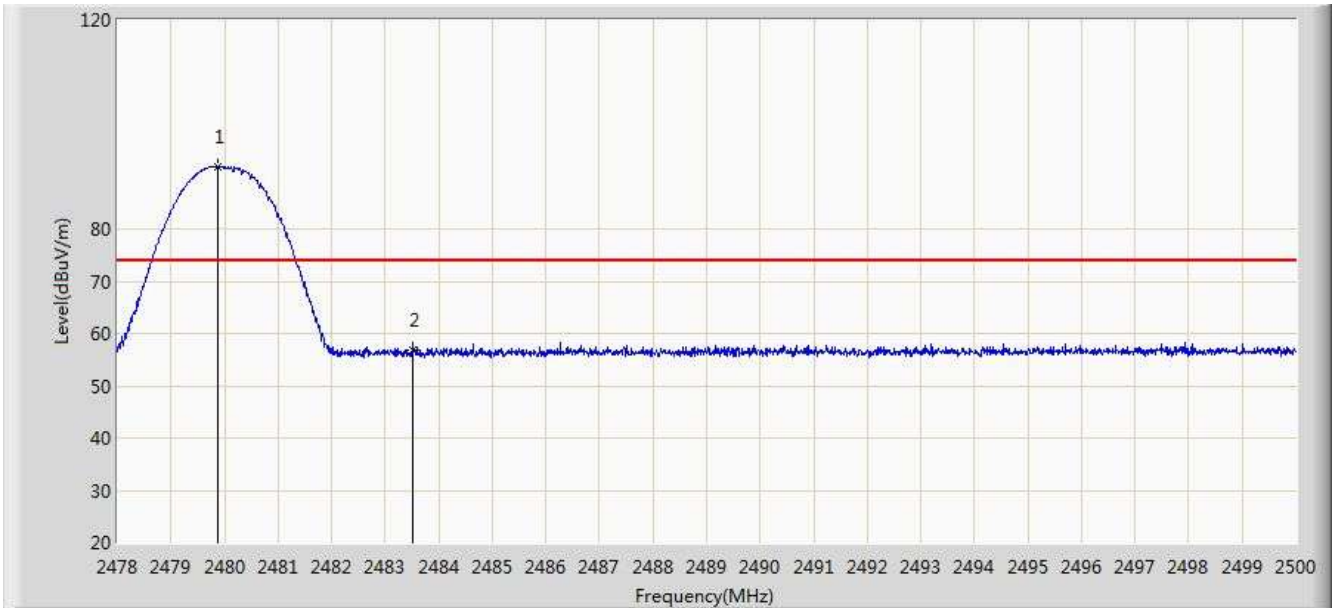

No	Flag	Mark	Frequency (MHz)	Measure Level (dBuV/m)	Reading Level (dBuV)	Over Limit (dB)	Limit (dBuV/m)	Factor	Type
1		*	2479.870	91.937	61.275	N/A	N/A	30.662	PK
2			2483.500	56.713	26.040	-17.287	74.000	30.673	PK

Engineer: Roy Cheng	
Site: AC1	Time: 2014/04/03 - 17:04
Limit: FCC_Part15.209_RE(3m)	Margin: 0
Probe: BBHA9120D_1-18GHz	Polarity: Horizontal
EUT: Smart Phone	Power: AC 120V/60Hz
Worst Case Mode: DH5 Channel 2480MHz	

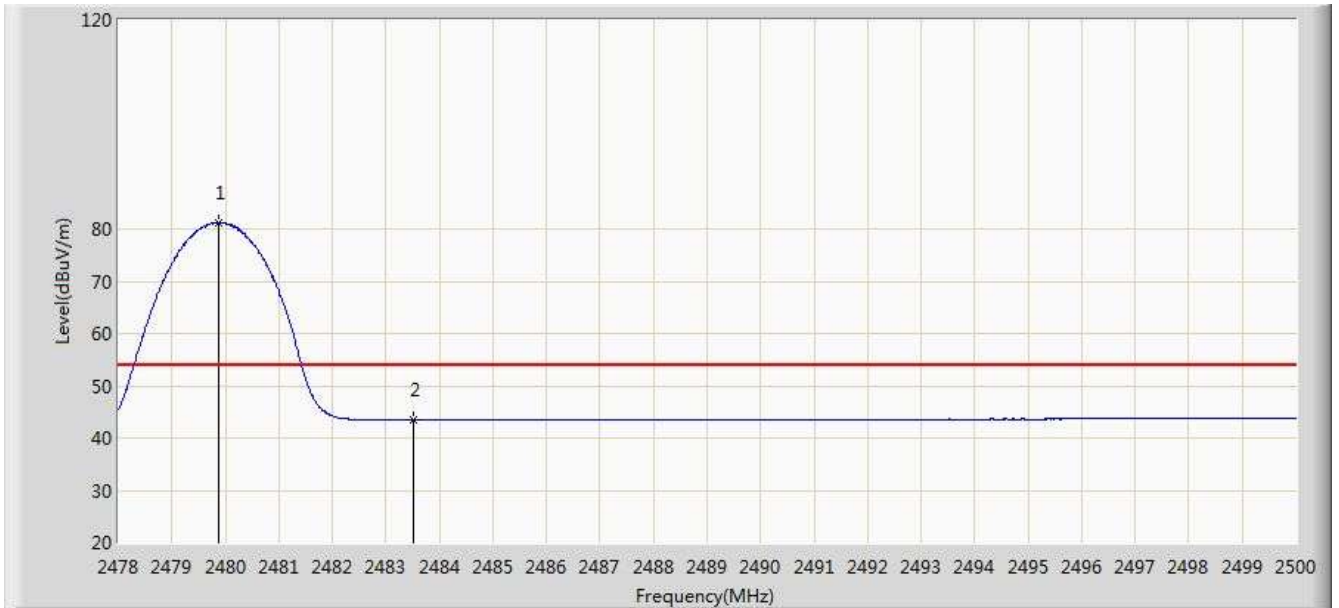

No	Flag	Mark	Frequency (MHz)	Measure Level (dBuV/m)	Reading Level (dBuV)	Over Limit (dB)	Limit (dBuV/m)	Factor	Type
1		*	2479.870	81.266	50.604	N/A	N/A	30.662	AV
2			2483.500	43.430	12.757	-10.570	54.000	30.673	AV

Engineer: Roy Cheng	
Site: AC1	Time: 2014/04/03 - 17:05
Limit: FCC_Part15.209_RE(3m)	Margin: 0
Probe: BBHA9120D_1-18GHz	Polarity: Vertical
EUT: Smart Phone	Power: AC 120V/60Hz
Worst Case Mode: DH5 Channel 2480MHz	

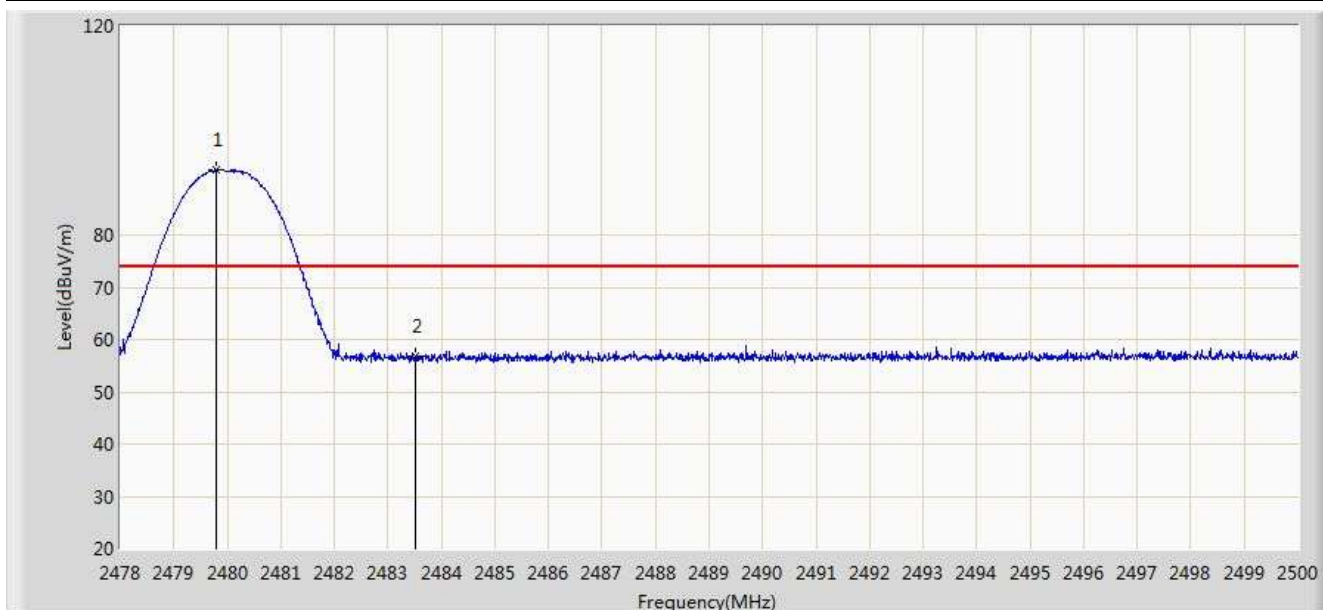

No	Flag	Mark	Frequency (MHz)	Measure Level (dBuV/m)	Reading Level (dBuV)	Over Limit (dB)	Limit (dBuV/m)	Factor	Type
1		*	2479.804	92.424	61.762	N/A	N/A	30.662	PK
2			2483.500	56.720	26.047	-17.280	74.000	30.673	PK

Engineer: Roy Cheng	
Site: AC1	Time: 2014/04/03 - 17:08
Limit: FCC_Part15.209_RE(3m)	Margin: 0
Probe: BBHA9120D_1-18GHz	Polarity: Vertical
EUT: Smart Phone	Power: AC 120V/60Hz
Worst Case Mode: DH5 Channel 2480MHz	

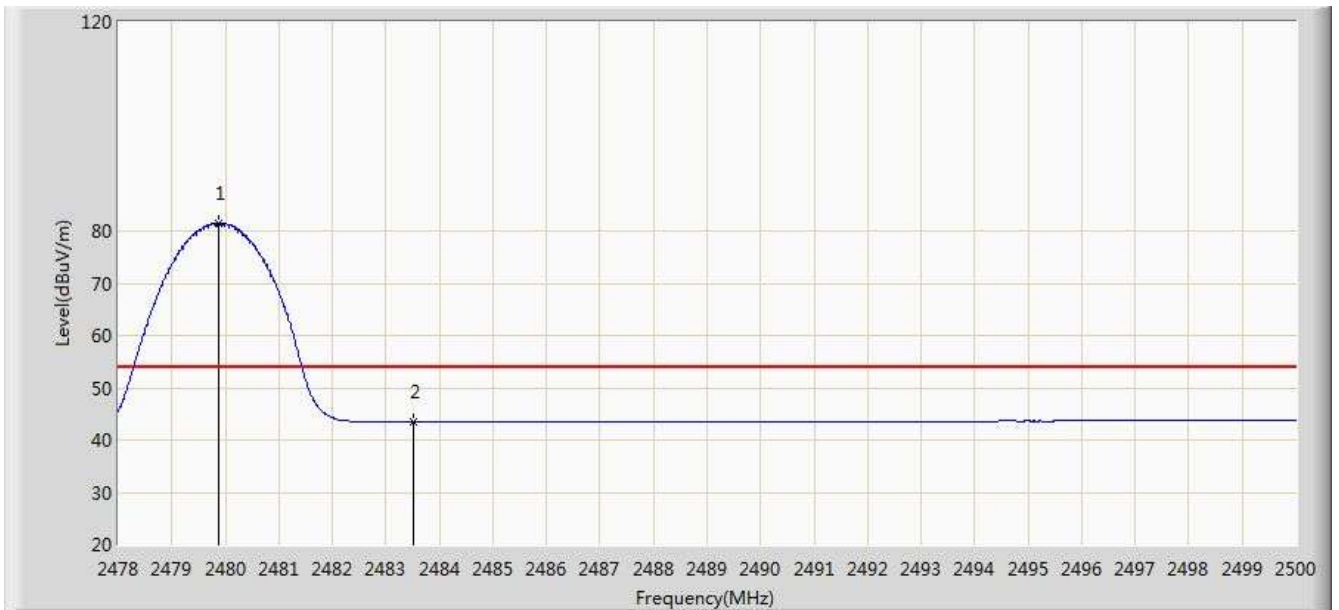

No	Flag	Mark	Frequency (MHz)	Measure Level (dBuV/m)	Reading Level (dBuV)	Over Limit (dB)	Limit (dBuV/m)	Factor	Type
1		*	2479.870	81.545	50.883	N/A	N/A	30.662	AV
2			2483.500	43.400	12.727	-10.600	54.000	30.673	AV

7.11. AC Conducted Emissions Measurement

7.11.1. Test Limit

FCC Part 15 Subpart C Paragraph 15.207 Limits		
Frequency (MHz)	QP (dB μ V)	Average (dB μ V)
0.15 - 0.50	66 - 56	56 - 46
0.50 - 5.0	56	46
5.0 - 30	60	50

Note 1: The lower limit shall apply at the transition frequencies.

Note 2: The limit decreases linearly with the logarithm of the frequency in the range 0.15MHz to 0.5MHz.

7.11.2. Test Setup

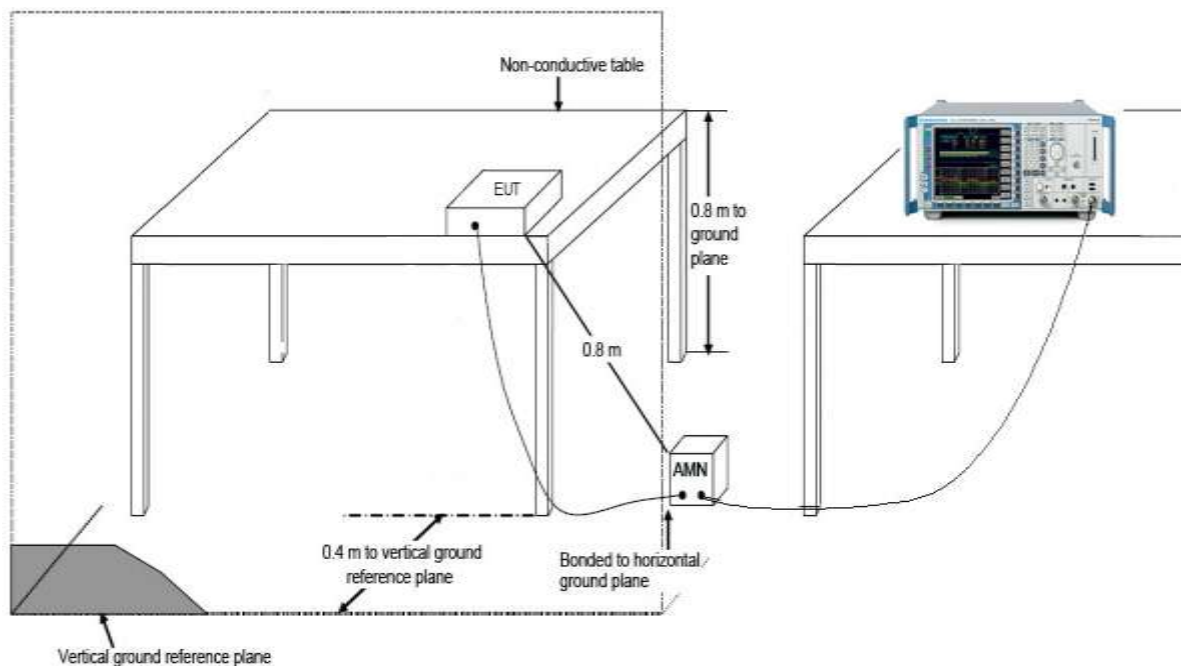

7.11.3. Test Result

Engineer: Milo Li	
Site: SR2	Time: 2014/03/29 - 17:30
Limit: FCC_Part15.207_CE_AC Power	Margin: 0
Probe: ENV216_101683_Filter On	Polarity: Line
EUT: Smart Phone	Power: AC 120V/60Hz
Note: Normal Operation	

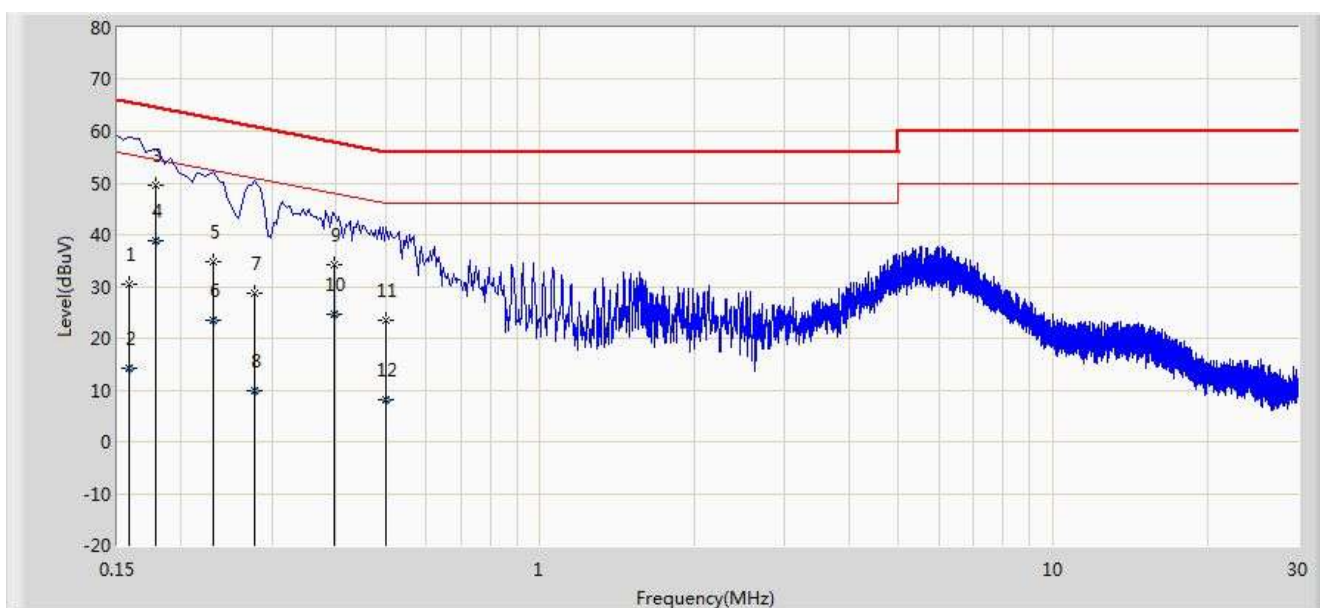

No	Flag	Mark	Frequency (MHz)	Measure Level (dBuV)	Reading Level (dBuV)	Over Limit (dB)	Limit (dBuV)	Factor	Type
1			0.158	30.387	20.076	-35.181	65.568	10.311	QP
2			0.158	14.218	3.907	-41.350	55.568	10.311	AV
3		*	0.178	49.601	39.543	-14.978	64.578	10.058	QP
4			0.178	38.703	28.645	-15.875	54.578	10.058	AV
5			0.230	34.735	24.788	-27.714	62.450	9.947	QP
6			0.230	23.525	13.577	-28.925	52.450	9.947	AV
7			0.278	28.753	18.766	-32.123	60.875	9.986	QP
8			0.278	9.776	-0.210	-41.099	50.875	9.986	AV
9			0.398	34.085	24.001	-23.810	57.895	10.084	QP
10			0.398	24.750	14.666	-23.145	47.895	10.084	AV
11			0.502	23.378	13.221	-32.622	56.000	10.157	QP
12			0.502	8.077	-2.080	-37.923	46.000	10.157	AV

Engineer: Milo Li	
Site: SR2	Time: 2014/03/29 - 17:39
Limit: FCC_Part15.207_CE_AC Power	Margin: 0
Probe: ENV216_101683_Filter On	Polarity: Neutral
EUT: Smart Phone	Power: AC 120V/60Hz
Note: Normal Operation	

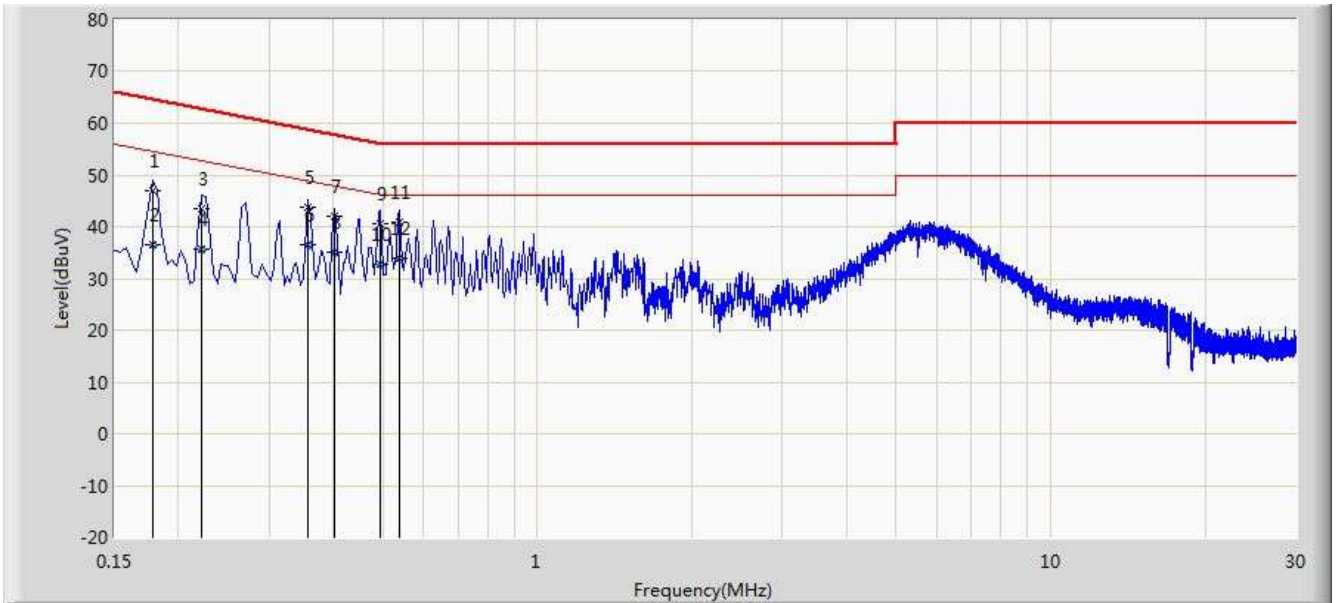

No	Flag	Mark	Frequency (MHz)	Measure Level (dBuV)	Reading Level (dBuV)	Over Limit (dB)	Limit (dBuV)	Factor	Type
1			0.178	47.030	36.981	-17.548	64.578	10.049	QP
2			0.178	36.591	26.541	-17.988	54.578	10.049	AV
3			0.222	43.558	33.578	-19.186	62.744	9.980	QP
4			0.222	35.626	25.646	-17.118	52.744	9.980	AV
5			0.358	43.723	33.642	-15.051	58.775	10.081	QP
6			0.358	36.646	26.565	-12.128	48.775	10.081	AV
7			0.402	41.986	31.872	-15.826	57.812	10.114	QP
8			0.402	35.080	24.967	-12.732	47.812	10.114	AV
9			0.494	40.590	30.411	-15.510	56.100	10.178	QP
10			0.494	32.638	22.460	-13.462	46.100	10.178	AV
11			0.538	40.842	30.677	-15.158	56.000	10.166	QP
12		*	0.538	33.894	23.729	-12.106	46.000	10.166	AV

8. CONCLUSION

The data collected relate only the item(s) tested and show that the **Smart Phone FCC ID:**

2AAA6-S950 is in compliance with Part 15C of the FCC Rules.

The End