



MEASUREMENT REPORT

FCC PART 22&24 Portable Handset

FCC ID: 2AAA6-S950

APPLICANT: SENWA MEXICO,S.A.DE C.V

Application Type: Certification

Product: Smart Phone

Model No.: S950

Brand Name: SENWA

FCC Classification: PCS Licensed Transmitter Held to Ear (PCE)

FCC Rule Part(s): Part2, Part22 Subpart H, Part24 Subpart E

Test Procedure(s): ANSI/TIA-603-C-2004, KDB 971168 D01v02r01

Test Date: March 27 ~ April 07, 2014

Reviewed By : Robin Wu
(Robin Wu)

Approved By : Marlin Chen
(Marlin Chen)

The test results relate only to the samples tested.

This equipment has been shown to be capable of compliance with the applicable technical standards as indicated in the measurement report and was tested in accordance with the measurement procedures specified in §2.947. Test results reported herein relate only to the item(s) tested.

The test report shall not be reproduced except in full without the written approval of MRT Technology (Suzhou) Co., Ltd.

Revision History

Report No.	Version	Description	Issue Date
1403RSU01204	Rev. 01	Initial report	04-11-2014

CONTENTS

Description	Page
§2.1033 General Information	5
1. INTRODUCTION	6
1.1. Scope	6
1.2. MRT Test Location	6
2. PRODUCT INFORMATION	7
2.1. Equipment Description.....	7
2.2. Device Capabilities	7
2.3. Test Configuration	7
2.4. EMI Suppression Device(s)/Modifications.....	7
3. DESCRIPTION OF TEST	8
3.1. Evaluation Procedure	8
3.2. Cellular – Base Frequency Blocks	8
3.3. Cellular – Mobile Frequency Blocks.....	8
3.4. PCS – Base Frequency Blocks.....	8
3.5. PCS – Mobile Frequency Blocks.....	9
3.6. Occupied Bandwidth.....	9
3.7. Spurious and Harmonic Emissions at Antenna Terminal.....	9
3.8. Radiated Power and Radiated Spurious Emissions	9
3.9. Peak-Average Ratio.....	11
3.10. Frequency Stability / Temperature Variation	11
4. TEST EQUIPMENT CALIBRATION DATA	12
5. SAMPLE CALCULATIONS	13
6. MEASUREMENT UNCERTAINTY	14
7. TEST RESULT	15
7.1. Summary	15
7.2. Occupied Bandwidth.....	16
7.2.1. Test Limit	16
7.2.2. Test Procedure used.....	16
7.2.3. Test Setting.....	16
7.2.4. Test Setup.....	16
7.2.5. Test Result.....	17
7.3. Spurious and Harmonic Emissions at Antenna Terminal.....	22
7.3.1. Test Limit	22

7.3.2.	Test Procedure Used	22
7.3.3.	Test Setting.....	22
7.3.4.	Test Setup.....	22
7.3.5.	Test Result.....	23
7.4.	Radiated Power and Radiated Spurious Emissions	35
7.4.1.	Test Limit	35
7.4.2.	Test Procedure Used	35
7.4.3.	Test Setting.....	35
7.4.4.	Test Setup.....	37
7.4.5.	Test Result.....	38
7.5.	Peak-Average Ratio.....	48
7.5.1.	Test Limit	48
7.5.2.	Test Procedure	48
7.5.3.	Test Setup.....	48
7.5.4.	Test Result.....	49
7.6.	Frequency Stability Under Temperature & Voltage Variations.....	52
7.6.1.	Test Limit	52
7.6.2.	Test Procedure	52
7.6.3.	Test Setup.....	52
7.6.4.	Test Result.....	53
8.	CONCLUSION.....	59

§2.1033 General Information

Applicant:	SENWA MEXICO,S.A.DE C.V
Applicant Address:	Av. Javier Barros Sierra 540,Torre I, Planta 5; COL. LOMAS DE SANTA FE DELEGACION ALVARO OBREGON C.P. 01210 MEXICO, DISTRITO FEDERAL
Manufacturer:	SHEN ZHEN IMO ELECTRONIC TECHENLOGY CO., LTD
Manufacturer Address:	A807 Haisong Building, 9 Tairan Road, Che Kung Temple, Futian District, Shenzhen
Test Site:	MRT Technology (Suzhou) Co., Ltd
Test Site Address:	D8 Building, Youxin Industrial Park, No.2 Tian'edang Rd., Wuzhong Economic Development Zone, Suzhou, China
MRT Registration No.:	809388
FCC Rule Part(s):	Part22 Subpart H, Part24 Subpart E
Model No.:	S950
FCC ID:	2AAA6-S950
Test Device Serial No.:	N/A <input type="checkbox"/> Production <input checked="" type="checkbox"/> Pre-Production <input type="checkbox"/> Engineering
FCC Classification:	PCS Licensed Transmitter Held to Ear (PCE)
Date(s) of Test:	March 27 ~ April 06, 2014
Test Report S/N:	1403RSU01204

1. INTRODUCTION

1.1. Scope

Measurement and determination of electromagnetic emissions (EMC) of radio frequency devices including intentional and/or unintentional radiators for compliance with the technical rules and regulations of the Federal Communications Commission and the Industry Canada Certification and Engineering Bureau.

1.2. MRT Test Location

The map below shows the location of the MRT LABORATORY, its proximity to the Taihu Lake. These measurement tests were conducted at the MRT Technology (Suzhou) Co., Ltd. Facility located at D8 Building, Youxin Industrial Park, No.2 Tian'edang Rd., Wuzhong Economic Development Zone, Suzhou, China. The detailed description of the measurement facility was found to be in compliance with the requirements of § 2.948 according to ANSI C63.4-2009 on September 30, 2013.



2. PRODUCT INFORMATION

2.1. Equipment Description

Product Name	Smart Phone
Model No.	S950
Antenna Type	Internal
Antenna Gain	GSM850: 2.5dBi PCS1900: 2.5dBi WCDMA BAND II: 2.5dBi WCDMA BAND V: 2.5dBi
Type of Modulation	GSM: GMSK GPRS: GMSK EDGE: 8PSK WCDMA: QPSK (Uplink) HSDPA: QPSK (Uplink) HSUPA: QPSK (Uplink) HSPA+: QPSK (Uplink)

Note: The test data contained in this report only to the emissions due to the EUT's 2G/3G licensed transmitters. The test report has showed the worst test mode.

2.2. Device Capabilities

This device contains the following capabilities:

850/1900 GSM/GPRS/EDGE, 1900 WCDMA/HSDPA/HSUPA, 802.11b/g/n WLAN (DTS),
Bluetooth (1x, EDR, BLE)

2.3. Test Configuration

The **Smart Phone FCC ID: 2AAA6-S950** was tested per the guidance of ANSI/TIA-603-C-2004 and KDB 971168 D01v02r01. See section 3.0 of this report for a description of the radiated and antenna port conducted emissions tests.

2.4. EMI Suppression Device(s)/Modifications

No EMI suppression device(s) were added and no modifications were made during testing.

3. DESCRIPTION OF TEST

3.1. Evaluation Procedure

The measurement procedures described in the “Land Mobile FM or PM – Communications Equipment – Measurements and Performance Standards” (ANSI/TIA-603-C-2004) and “Procedures for Compliance Measurement of the Fundamental Emission Power of Licensed Wideband (> 1 MHz) Digital Transmission Systems” (KDB 971168) were used in the measurement of the **Smart Phone FCC ID: 2AAA6-S950**

Deviation from measurement procedure.....None

3.2. Cellular – Base Frequency Blocks

§22.905

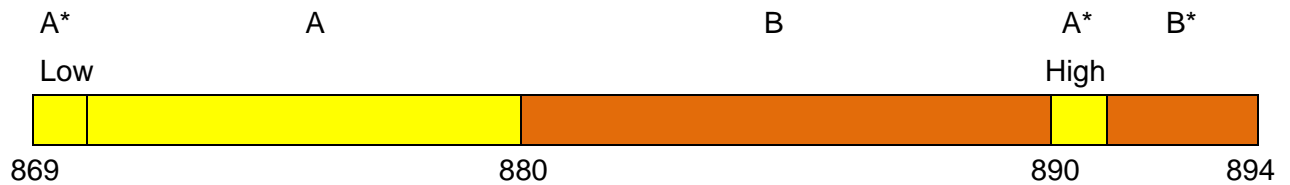

Block 1: 869 – 880 MHz (A* Low + A)

Block 3: 890 – 891.5 MHz (A* High)

Block 2: 880 – 890 MHz (B)

Block 4: 891.5 – 894 MHz (B*)

3.3. Cellular – Mobile Frequency Blocks

§22.905

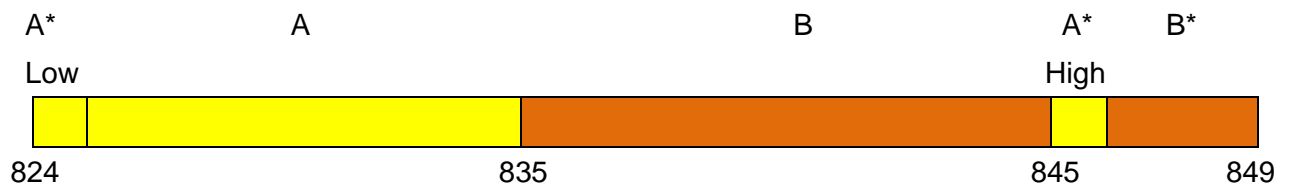

Block 1: 824 – 835 MHz (A* Low + A)

Block 3: 845 – 846.5 MHz (A* High)

Block 2: 835 – 845 MHz (B)

Block 4: 846.5 – 849 MHz (B*)

3.4. PCS – Base Frequency Blocks

§24.229

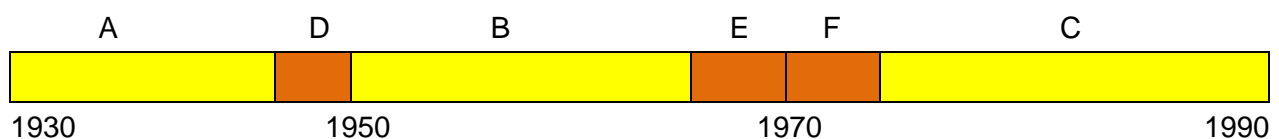

Block 1: 1930 – 1945 MHz (A)

Block 4: 1965 – 1970 MHz (E)

Block 2: 1945 – 1950 MHz (D)

Block 5: 1970 – 1975 MHz (F)

Block 3: 1950 – 1965 MHz (B)

Block 6: 1975 – 1990 MHz (C)

3.5. PCS – Mobile Frequency Blocks

§24.229

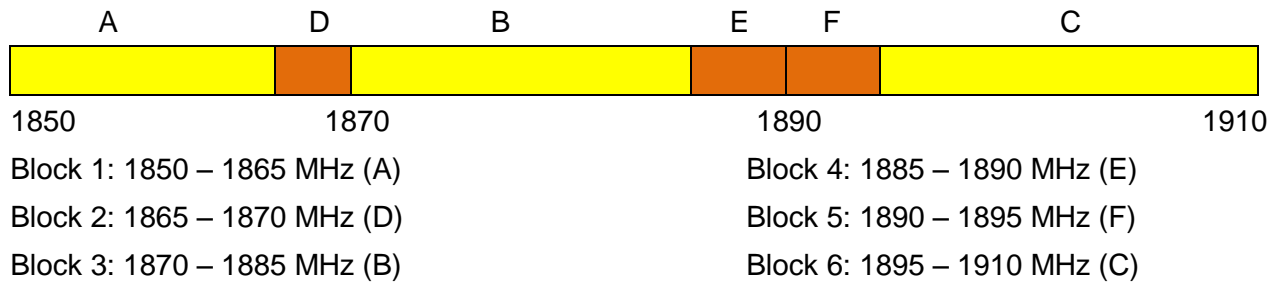

3.6. Occupied Bandwidth

§2.1049

The occupied bandwidth, that is the frequency bandwidth such that, below its lower and above its upper frequency limits, the mean powers radiated are each equal to 0.5 percent of the total mean power radiated by a given emission shall be measured. The spectrum analyzers' "occupied bandwidth" measurement function was used to record the occupied bandwidth in accordance with KDB 971168.

3.7. Spurious and Harmonic Emissions at Antenna Terminal

§2.1051 §22.917(a) §24.238(a)

The level of the carrier and the various conducted spurious and harmonic frequencies is measured by means of a calibrated spectrum analyzer. The spectrum is scanned from the lowest frequency generated in the equipment up to a frequency including its 10th harmonic. On any frequency outside a licensee's frequency block, the power of any emission shall be attenuated below the transmitter power (P) by at least $43 + 10 \log(P)$ dB. Compliance with these provisions is based on the use of measurement instrumentation employing a resolution bandwidth of 100 kHz or greater for Part 22 and 1 MHz or greater for Part 24. However, in the 1 MHz bands immediately outside and adjacent to the frequency block a resolution bandwidth of at least one percent of the emission bandwidth of the fundamental emission of the transmitter may be employed. The emission bandwidth is defined as the width of the signal between two points, one below the carrier center frequency and one above the carrier center frequency, outside of which all emission are attenuated at least 26 dB below the transmitter power.

3.8. Radiated Power and Radiated Spurious Emissions

§2.1053 §22.913(a.2) §22.917(a) §24.232(c) §24.238(a)

The radiated test facilities consisted of an indoor 3 meter semi-anechoic chamber used for final measurement and exploratory measurements, when necessary. The measurement area is

contained within the semi-anechoic chamber which is shielded from any ambient interference. For measurements above 1GHz absorbers are arranged on the floor between the turn table and the antenna mast in such a way so as to maximize the reduction of reflections. For measurements below 1GHz, the absorbers are removed. A MF Model 210SS turntable is used for radiated measurement. It is a continuously rotatable, remote-controlled, metallic turntable and 2 meters (6.56 ft.) in diameter. The turn table is flush with the raised floor of the chamber in order to maintain its function as a ground plane. A 80cm high PVC support structure is placed on top of the turntable.

The equipment under test was transmitting while connected to its integral antenna and is placed on a wooden turntable 80cm above the ground plane and 3 meters from the receive antenna. The receive antenna height is adjusted between 1 and 4 meter height, the turntable is rotated through 360 degrees, and the EUT is manipulated through all orthogonal planes representative of its typical use to achieve the highest reading on the receive spectrum analyzer. Radiated power levels are also investigated with the receive antenna horizontally and vertically polarized. The maximized power level is recorded using the spectrum analyzer "Channel Power" function with the integration band set to the emissions' occupied bandwidth, a RMS detector, RBW = 100kHz, VBW = 300kHz, and a 1 second sweep time over a minimum of 10 sweeps, per the guidelines of KDB 971168.

Per the guidance of ANSI/TIA-603-C-2004, a half-wave dipole is then substituted in place of the EUT. For emissions above 1GHz, a horn antenna is substituted in place of the EUT. The substitute antenna is driven by a signal generator with the level of the signal generator being adjusted to obtain the same receive spectrum analyzer level previously recorded from the spurious emission from the EUT. The power of the emission is calculated using the following formula:

$$P_d \text{ [dBm]} = P_g \text{ [dBm]} - \text{cable loss [dB]} + \text{antenna gain [dBd/dBi]}$$

Where, P_d is the dipole equivalent power, P_g is the generator output into the substitution antenna, and the antenna gain is the gain of the substitute antenna used relative to either a half-wave dipole (dBd) or an isotropic source (dBi). The substitute level is equal to $P_g \text{ [dBm]} - \text{cable loss [dB]}$.

The calculated P_d levels are then compared to the absolute spurious emission limit of -13dBm which is equivalent to the required minimum attenuation of $43 + 10 \cdot \log_{10}(\text{Power [Watts]})$ specified in 22.917(a) and 24.238(a).

3.9. Peak-Average Ratio

§24.232(d)

A peak to average ratio measurement is performed at the conducted port of the EUT. The spectrum analyzers Complementary Cumulative Distribution Function (CCDF) measurement profile is used to determine the largest deviation between the average and the peak power of the EUT in a given bandwidth. The CCDF curve shows how much time the peak waveform spends at or above a given average power level. The percent of time the signal spends at or above the level defines the probability for that particular power level.

For pulsed signals, the spectrum analyzer is set to use an internal “RF Burst” trigger that is synced with an incoming pulse and the measurement interval is set to less than the duration of the “on time” of one burst to ensure that energy is only captured during a time in which the transmitter is operating at maximum power. For continuous signals, the trigger is set to “free run” in the CCDF measurement mode.

3.10. Frequency Stability / Temperature Variation

§2.1055 §22.355 §22.863 §22.905 §24.229 §24.235

Frequency stability testing is performed in accordance with the guidelines of ANSI/TIA-603-C-2004. The frequency stability of the transmitter is measured by:

- a.) Temperature: The temperature is varied from -30°C to +50°C in 10°C increments using an environmental chamber.
- b.) Primary Supply Voltage: The primary supply voltage is varied from 85% to 115% of the nominal value for non hand-carried battery and AC powered equipment. For hand-carried, battery-powered equipment, primary supply voltage is reduced to the battery operating end point which shall be specified by the manufacturer.

Specification – For Part 22, the frequency stability of the transmitter shall be maintained within $\pm 0.00025\%$ (± 2.5 ppm) of the center frequency. For Part 24, the frequency stability shall be sufficient to ensure that the fundamental emission stays within the authorized frequency block.

Time Period and Procedure:

1. The carrier frequency of the transmitter is measured at room temperature (20°C to provide a reference).
2. The equipment is turned on in a “standby” condition for fifteen minutes before applying power to the transmitter. Measurement of the carrier frequency of the transmitter is made within one minute after applying power to the transmitter.
3. Frequency measurements are made at 10°C intervals ranging from -30°C to +50°C. A period of at least one half-hour is provided to allow stabilization of the equipment at each temperature level.

4. TEST EQUIPMENT CALIBRATION DATA

Radiated Emission

Instrument	Manufacturer	Type No.	Serial No.	Cali. Interval	Cal. Date
Spectrum Analyzer	Agilent	E4447A	MY45300136	1 year	2014/11/08
Radio Communication Tester	R&S	CMU 200	117129	1 year	2014/12/14
Preamplifier	MRT	AP01G18	1310002	1 year	2014/12/14
Preamplifier	MRT	AP18G40	1310003	1 year	2014/10/07
Loop Antenna	Schwarzbeck	FMZB1519	1519-041	1 year	2014/11/24
TRILOG Antenna	Schwarzbeck	VULB9162	9162-047	1 year	2014/11/24
Broad-Band Horn Antenna	Schwarzbeck	BBHA9120D	9120D-1167	1 year	2014/11/24
Broadband Horn Antenna	Schwarzbeck	BBHA9170	9170-549	1 year	2014/12/11
Temperature/Humidity Meter	Anymetre	TH101B	AC1-01	1 year	2014/11/15

Conducted Test Equipment

Instrument	Manufacturer	Type No.	Serial No.	Cali. Interval	Cali. Due Date
Spectrum Analyzer	Agilent	E4447A	MY45300136	1 year	2014/11/08
Radio Communication Tester	R&S	CMU 200	117129	1 year	2014/12/14
DC Power Supply	GWINSTEK	GPS-3030D	EM861052	1 year	2014/11/14
Programmable Temperature & Humidity Chamber	BAOYT	BYH-1500L	1309W043	1 year	2014/11/20
Temperature/Humidity Meter	Anymetre	TH101B	TR3-01	1 year	2014/11/15

5. SAMPLE CALCULATIONS

GSM Emission Designator

Emission Designator = 250KGXW

GSM BW = 250 kHz

G = Phase Modulation

X = Cases not otherwise covered

W = Combination (Audio/Data)

EDGE Emission Designator

Emission Designator = 250KG7W

GSM BW = 250 kHz

G = Phase Modulation

7 = Quantized/Digital Info

W = Combination (Audio/Data)

WCDMA Emission Designator

Emission Designator = 4M16F9W

WCDMA BW = 4.16 MHz

F = Frequency Modulation

9 = Composite Digital Info

W = Combination (Audio/Data) (Measured at the 99.75% power bandwidth)

Spurious Radiated Emission

Example: Spurious emission at 3700.40 MHz

The receive spectrum analyzer reading at 3 meters with the EUT on the turntable was -81.0dBm .

The gain of the substituted antenna is 8.1dBi . The signal generator connected to the substituted antenna terminals is adjusted to produce a reading of -81.0dBm on the spectrum analyzer. The loss of the cable between the signal generator and the terminals of the substituted antenna is 2.0dB at 3700.40MHz . So 6.1dB is added to the signal generator reading of -30.9dBm yielding -24.80dBm . The fundamental EIRP was 25.50dBm so this harmonic was $25.50\text{dBm} - (-24.80) = 50.3\text{dBc}$.

6. MEASUREMENT UNCERTAINTY

Where relevant, the following test uncertainty levels have been estimated for tests performed on the EUT as specified in CISPR 16-4-2. This uncertainty represents an expanded uncertainty expressed at approximately the 95% confidence level using a coverage factor of $k = 2$.

Radiated Emission Measurement
Measuring Uncertainty for a Level of Confidence of 95% ($U=2Uc(y)$):
9kHz ~ 1GHz: $\pm 4.18\text{dB}$
1GHz ~ 40GHz: $\pm 4.76\text{dB}$

7. TEST RESULT

7.1. Summary

Company Name: SENWA MEXICO,S.A.DE C.V
FCC ID: 2AAA6-S950
FCC Classification: PCS Licensed Transmitter Held to Ear (PCE)
Mode(s): GSM / WCDMA

FCC Part Section(s)	Test Description	Test Limit	Test Condition	Test Result	Reference
<u>Transmitter Mode(TX)</u>					
2.1049	Occupied bandwidth	N/A	Conducted	Pass	Section 7.2
2.1051 22.917(a) 24.238(a)	Band Edge / Conducted Spurious Emissions	> 43 + log ₁₀ (P[Watts]) at Band Edge and for all out-of-band emissions		Pass	Section 7.3
24.232(d)	Peak-Average Ratio	< 13 dB		Pass	Section 7.5
2.1046	Transmitter Conducted Output Power	N/A		Pass	RF Exposure Report
22.913(a.2)	Effective Radiated Power	< 7 Watts max. ERP	Radiated	Pass	Section 7.4
24.232(c)	Equivalent Isotropic Radiated Power	< 2 Watts max. EIRP		Pass	Section 7.4
2.1053 22.917(a) 24.238(a)	Undesirable Emissions	> 43 + log ₁₀ (P[Watts]) for all out-of-band emissions		Pass	Section 7.4
2.1055 22.355 24.235	Frequency Stability	< 2.5 ppm (Part 22) Emission must remain in band (Part 24)		Pass	Section 7.6

Notes:

- 1) All modes of operation and data rates were investigated. The test results shown in the following sections represent the worst case emissions.
- 2) The analyzer plots shown in Section 4.0 were all taken with a correction table loaded into the analyzer. The correction table was used to account for the losses of the cables, directional couplers, and attenuators used as part of the system to maintain a link between the call box and the EUT at all frequencies of interest.
- 3) All antenna port conducted emissions testing was performed on a test bench with the antenna port of the EUT connected to the spectrum analyzer through calibrated cables, attenuators, and couplers.

7.2. Occupied Bandwidth

7.2.1. Test Limit

N/A

7.2.2. Test Procedure used

KDB 971168 D01v02r01 – Section 4.1 & ANSI/TIA-603-C-2004

7.2.3. Test Setting

1. The spectrum analyzer center frequency is set to the nominal EUT channel center frequency.
The span range for the spectrum analyzer shall be between two and five times the anticipated OBW. RBW = approximately 1% of the emission bandwidth.
2. The nominal resolution bandwidth (RBW) shall be in the range of 1 to 5 % of the anticipated OBW, and the VBW shall be at least 3 times the RBW.
3. Set the detection mode to peak, and the trace mode to max hold.
4. Use the 99 % power bandwidth function of the spectrum analyzer (if available) and report the measured bandwidth.

7.2.4. Test Setup

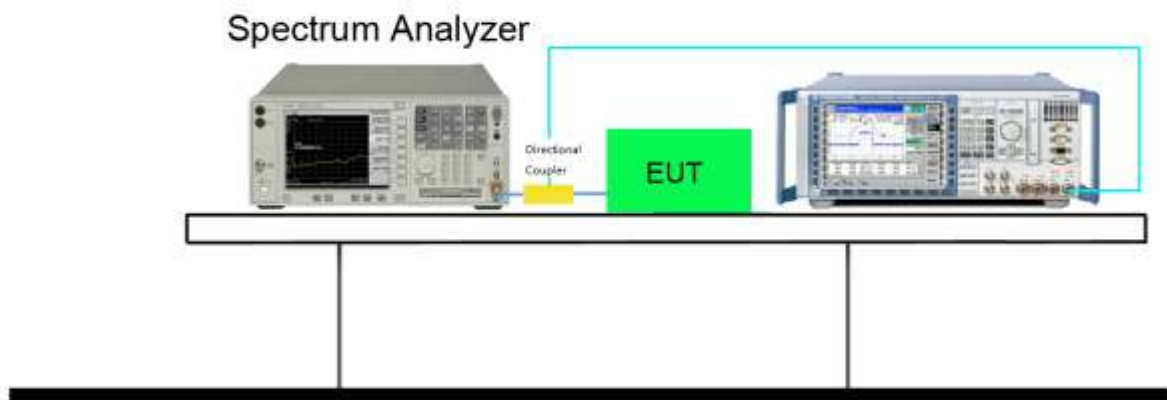

7.2.5. Test Result

Test Mode	Channel No.	Frequency (MHz)	99% Occupied Bandwidth (kHz)	-26dB Occupied Bandwidth (kHz)	Result
GSM850	128	824.2	243.560	312.603	Pass
	189	836.4	244.265	309.414	Pass
	251	848.8	245.925	312.188	Pass
PCS1900	512	1850.2	247.211	313.815	Pass
	661	1880.0	242.997	309.416	Pass
	810	1909.8	243.903	315.530	Pass
EDGE850	128	824.2	243.146	316.087	Pass
	189	836.4	244.616	316.192	Pass
	251	848.8	243.740	313.184	Pass
EDGE1900	512	1850.2	244.801	319.352	Pass
	661	1880.0	245.578	317.008	Pass
	810	1909.8	246.509	315.781	Pass
WCDMA Band II	9262	1852.4	4148.700	4671.000	Pass
	9400	1880.0	4149.400	4667.000	Pass
	9538	1907.6	4150.300	4667.000	Pass
WCDMA Band V	4132	826.4	4145.100	4667.000	Pass
	4182	836.4	4143.800	4676.000	Pass
	4233	846.6	4144.800	4678.000	Pass

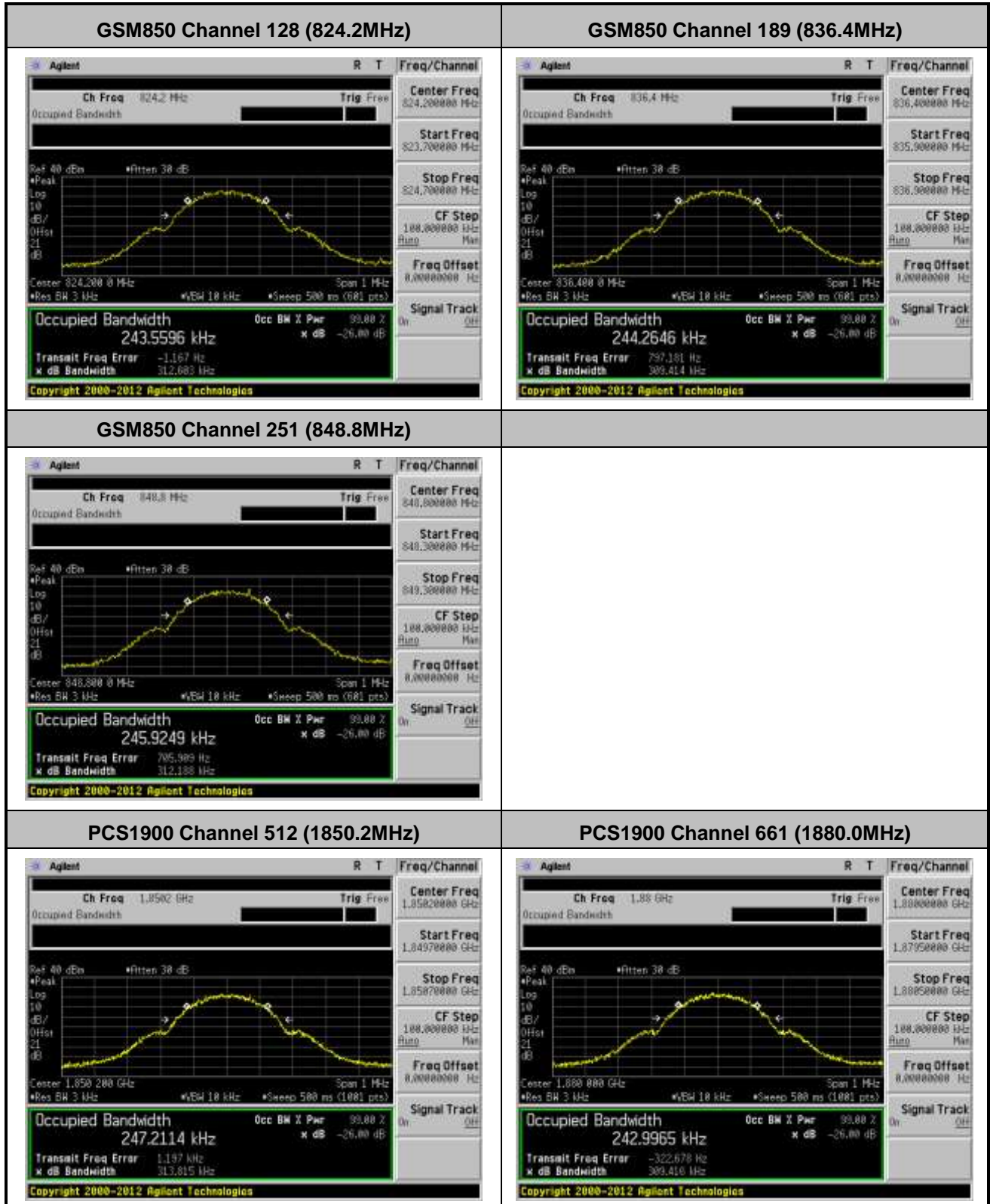

PCS1900 Channel 810 (1909.8MHz)	
<p>Agilent R T Freq/Channel</p> <p>Ch Freq 1.9098 GHz Trig Free</p> <p>Center Freq 1.90930000 GHz</p> <p>Start Freq 1.90930000 GHz</p> <p>Stop Freq 1.91030000 GHz</p> <p>CF Step 100.000000 Hz</p> <p>Freq Offset 0.00000000 Hz</p> <p>Signal Track Off</p> <p>Occupied Bandwidth 243.9026 kHz</p> <p>Transmit Freq Error 230.927 Hz</p> <p>x dB Bandwidth 315.530 kHz</p> <p>Copyright 2000-2012 Agilent Technologies</p>	
EDGE850 Channel 128 (824.2MHz)	
<p>Agilent R T Freq/Channel</p> <p>Ch Freq 824.2 MHz Trig Free</p> <p>Center Freq 824.200000 MHz</p> <p>Start Freq 823.700000 MHz</p> <p>Stop Freq 824.700000 MHz</p> <p>CF Step 100.000000 Hz</p> <p>Freq Offset 0.00000000 Hz</p> <p>Signal Track Off</p> <p>Occupied Bandwidth 243.1461 kHz</p> <p>Transmit Freq Error 1.633 kHz</p> <p>x dB Bandwidth 316.867 kHz</p> <p>Copyright 2000-2012 Agilent Technologies</p>	
EDGE850 Channel 189 (836.4MHz)	
<p>Agilent R T Freq/Channel</p> <p>Ch Freq 836.4 MHz Trig Free</p> <p>Center Freq 836.400000 MHz</p> <p>Start Freq 835.900000 MHz</p> <p>Stop Freq 836.900000 MHz</p> <p>CF Step 100.000000 Hz</p> <p>Freq Offset 0.00000000 Hz</p> <p>Signal Track Off</p> <p>Occupied Bandwidth 244.6155 kHz</p> <p>Transmit Freq Error 489.465 Hz</p> <p>x dB Bandwidth 316.192 kHz</p> <p>Copyright 2000-2012 Agilent Technologies</p>	
EDGE850 Channel 251 (848.8MHz)	
<p>Agilent R T Freq/Channel</p> <p>Ch Freq 848.8 MHz Trig Free</p> <p>Center Freq 848.800000 MHz</p> <p>Start Freq 848.300000 MHz</p> <p>Stop Freq 849.300000 MHz</p> <p>CF Step 100.000000 Hz</p> <p>Freq Offset 0.00000000 Hz</p> <p>Signal Track Off</p> <p>Occupied Bandwidth 243.7398 kHz</p> <p>Transmit Freq Error 474.477 Hz</p> <p>x dB Bandwidth 313.184 kHz</p> <p>Copyright 2000-2012 Agilent Technologies</p>	

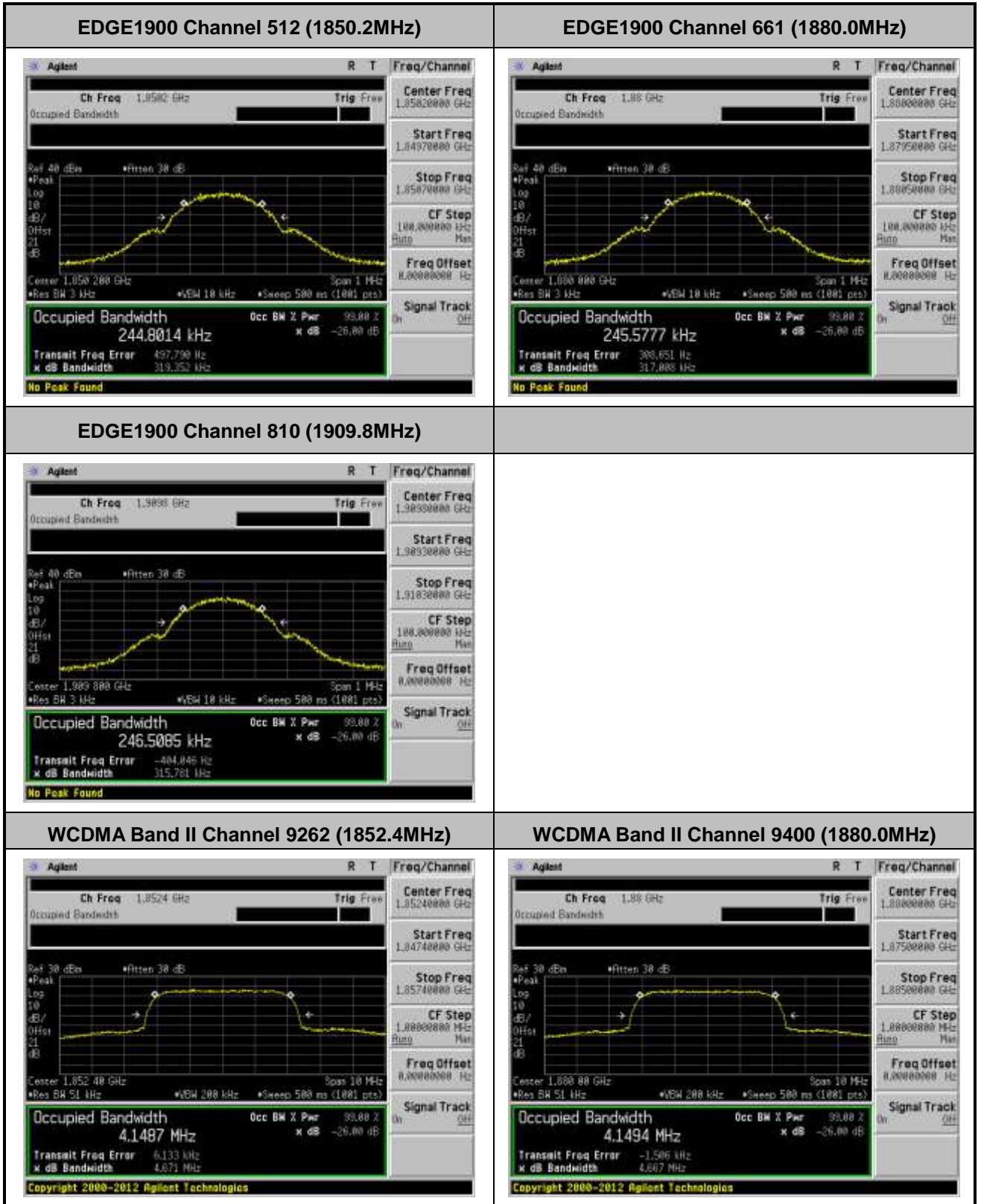

WCDMA Band II Channel 9538 (1907.6MHz)	
<p>Agilent R T Freq/Channel</p> <p>Ch Freq 1.9076 GHz Trig Free</p> <p>Center Freq 1.9076000 GHz</p> <p>Start Freq 1.9020000 GHz</p> <p>Stop Freq 1.9126000 GHz</p> <p>CF Step 1.0000000 MHz</p> <p>Freq Offset 0.0000000 Hz</p> <p>Occupied Bandwidth 4.1503 MHz</p> <p>Transmit Freq Error -20.704 kHz</p> <p>x dB Bandwidth 4.607 MHz</p> <p>Copyright 2000-2012 Agilent Technologies</p>	
WCDMA Band V Channel 4132 (826.4MHz)	
<p>Agilent R T Freq/Channel</p> <p>Ch Freq 826.4 MHz Trig Free</p> <p>Center Freq 826.40000 MHz</p> <p>Start Freq 821.40000 MHz</p> <p>Stop Freq 831.40000 MHz</p> <p>CF Step 1.0000000 MHz</p> <p>Freq Offset 0.0000000 Hz</p> <p>Occupied Bandwidth 4.1451 MHz</p> <p>Transmit Freq Error -8.043 kHz</p> <p>x dB Bandwidth 4.607 MHz</p> <p>Copyright 2000-2012 Agilent Technologies</p>	
WCDMA Band V Channel 4182 (836.4MHz)	
<p>Agilent R T Freq/Channel</p> <p>Ch Freq 836.4 MHz Trig Free</p> <p>Center Freq 836.40000 MHz</p> <p>Start Freq 831.40000 MHz</p> <p>Stop Freq 841.40000 MHz</p> <p>CF Step 1.0000000 MHz</p> <p>Freq Offset 0.0000000 Hz</p> <p>Occupied Bandwidth 4.1438 MHz</p> <p>Transmit Freq Error 3.591 kHz</p> <p>x dB Bandwidth 4.676 MHz</p> <p>Copyright 2000-2012 Agilent Technologies</p>	
WCDMA Band V Channel 4233 (846.6MHz)	
<p>Agilent R T Freq/Channel</p> <p>Ch Freq 846.6 MHz Trig Free</p> <p>Center Freq 846.60000 MHz</p> <p>Start Freq 841.60000 MHz</p> <p>Stop Freq 851.60000 MHz</p> <p>CF Step 1.0000000 MHz</p> <p>Freq Offset 0.0000000 Hz</p> <p>Occupied Bandwidth 4.1448 MHz</p> <p>Transmit Freq Error -9.227 kHz</p> <p>x dB Bandwidth 4.676 MHz</p> <p>Copyright 2000-2012 Agilent Technologies</p>	

7.3. Spurious and Harmonic Emissions at Antenna Terminal

7.3.1. Test Limit

The power of any emission outside of the authorized operating frequency ranges must be attenuated below the transmitting power (P) by a factor of at least $43 + 10\log(P)$ dB.

7.3.2. Test Procedure Used

KDB 971168 D01v02r01 – Section 6.0 & ANSI/TIA-603-C-2004

7.3.3. Test Setting

In the 1MHz bands immediately outside and adjacent to the frequency block a resolution bandwidth of at least one percent of the emission bandwidth of the fundamental emission of the transmitter may be employed to measure the out of band Emissions.

7.3.4. Test Setup

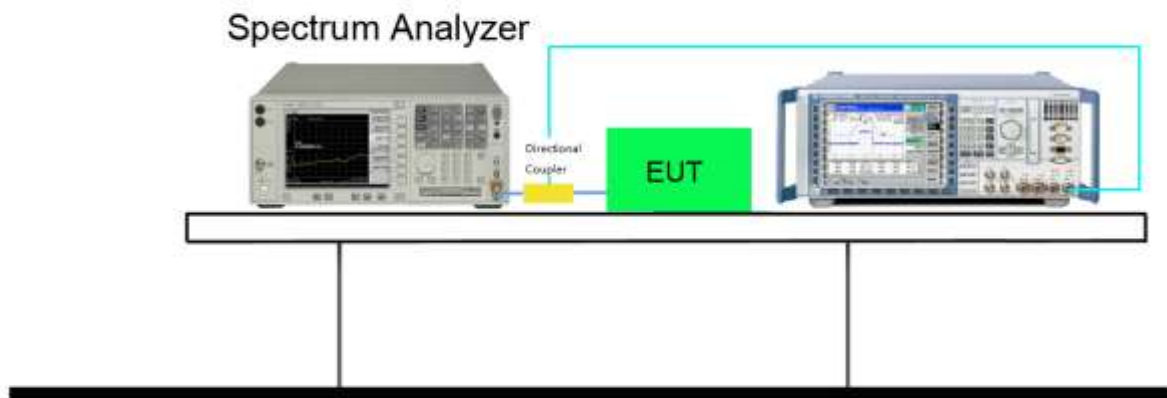

7.3.5. Test Result

Mode	Channel No.	Frequency (MHz)	Modulation	Test Result
GSM850	128	824.20	GMSK	Pass
GSM850	189	836.40	GMSK	Pass
GSM850	251	848.80	GMSK	Pass

Band Edge

Channel 128 (824.20MHz)

Channel 251 (848.80MHz)

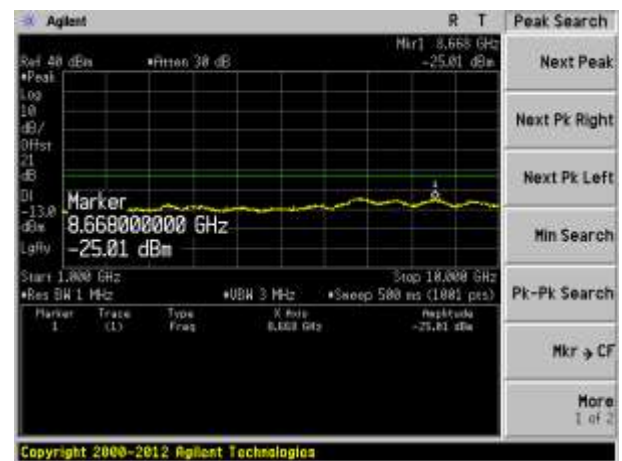
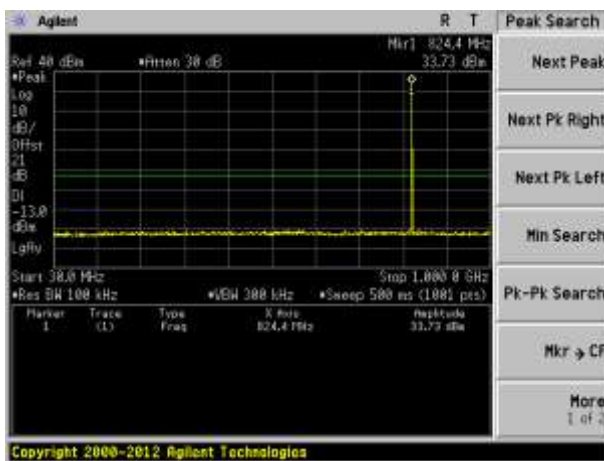

Conducted Spurious Emission

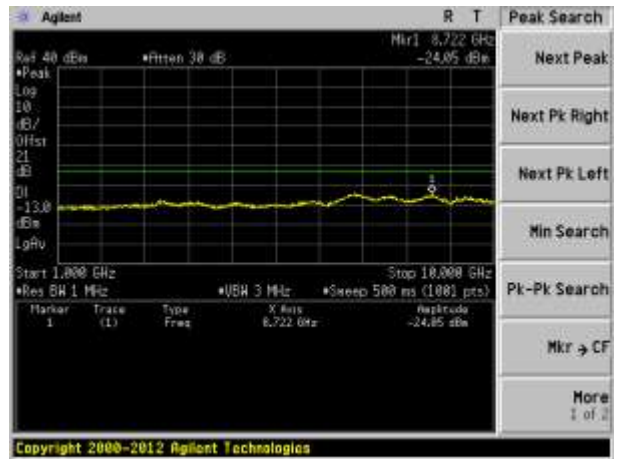
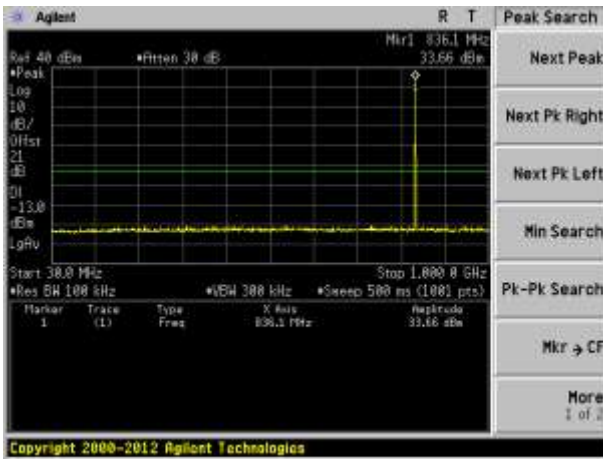
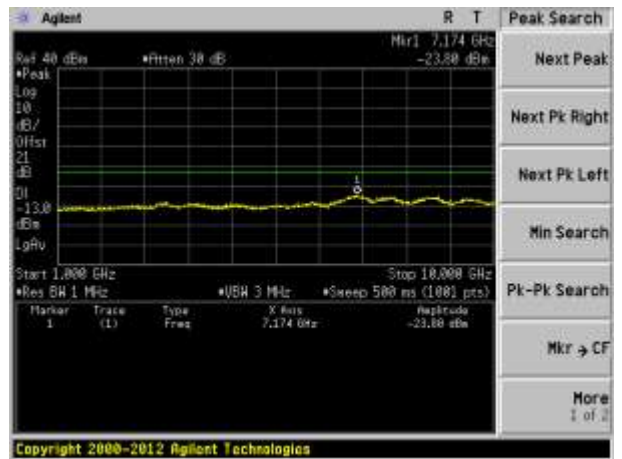
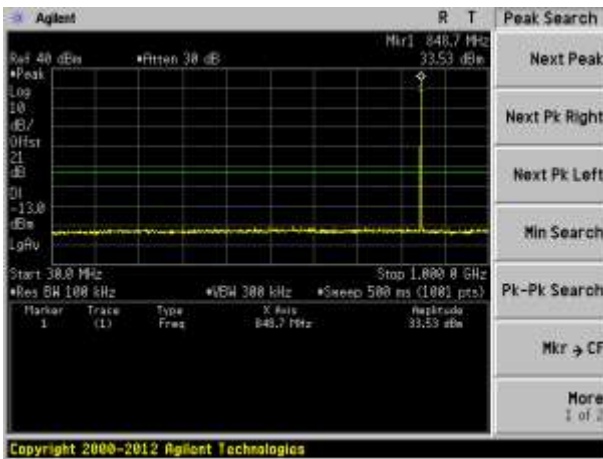
Channel 128 (824.20MHz)

Channel 189 (836.40MHz)

Channel 251 (848.80MHz)

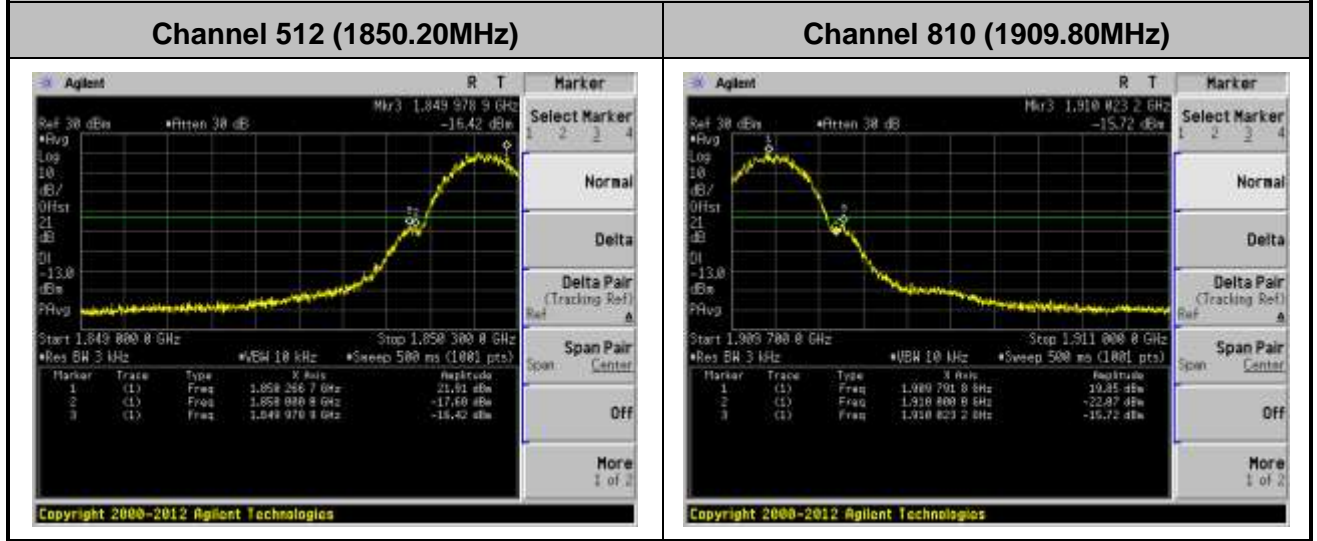
Mode	Channel No.	Frequency (MHz)	Modulation	Test Result
PCS1900	512	1850.20	GMSK	Pass
PCS1900	661	1880.00	GMSK	Pass
PCS1900	810	1909.80	GMSK	Pass

Band Edge

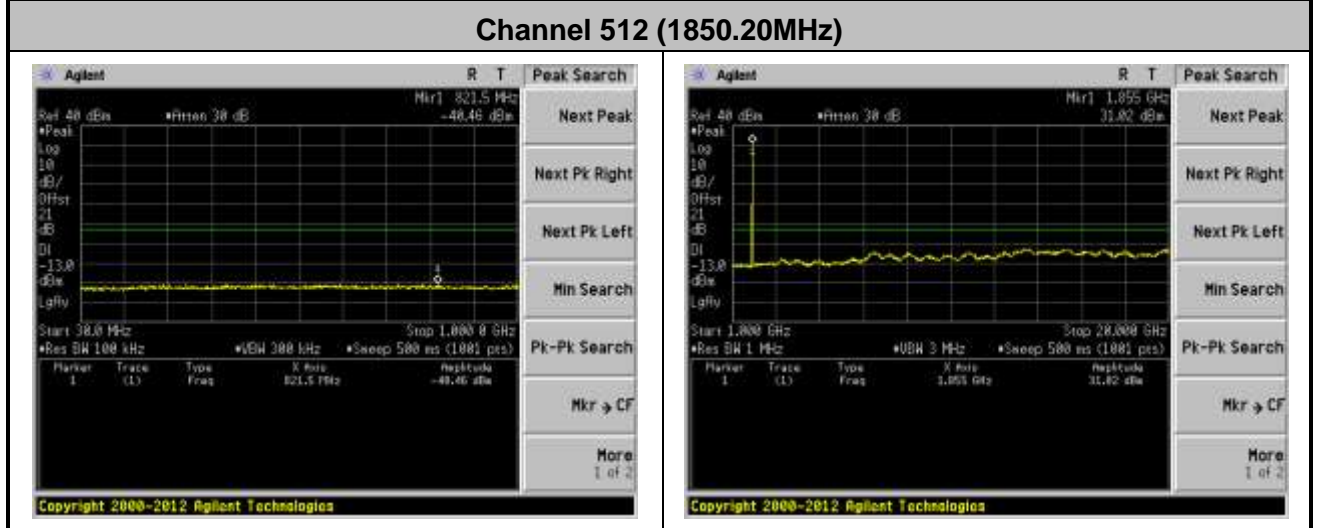

Conducted Spurious Emission



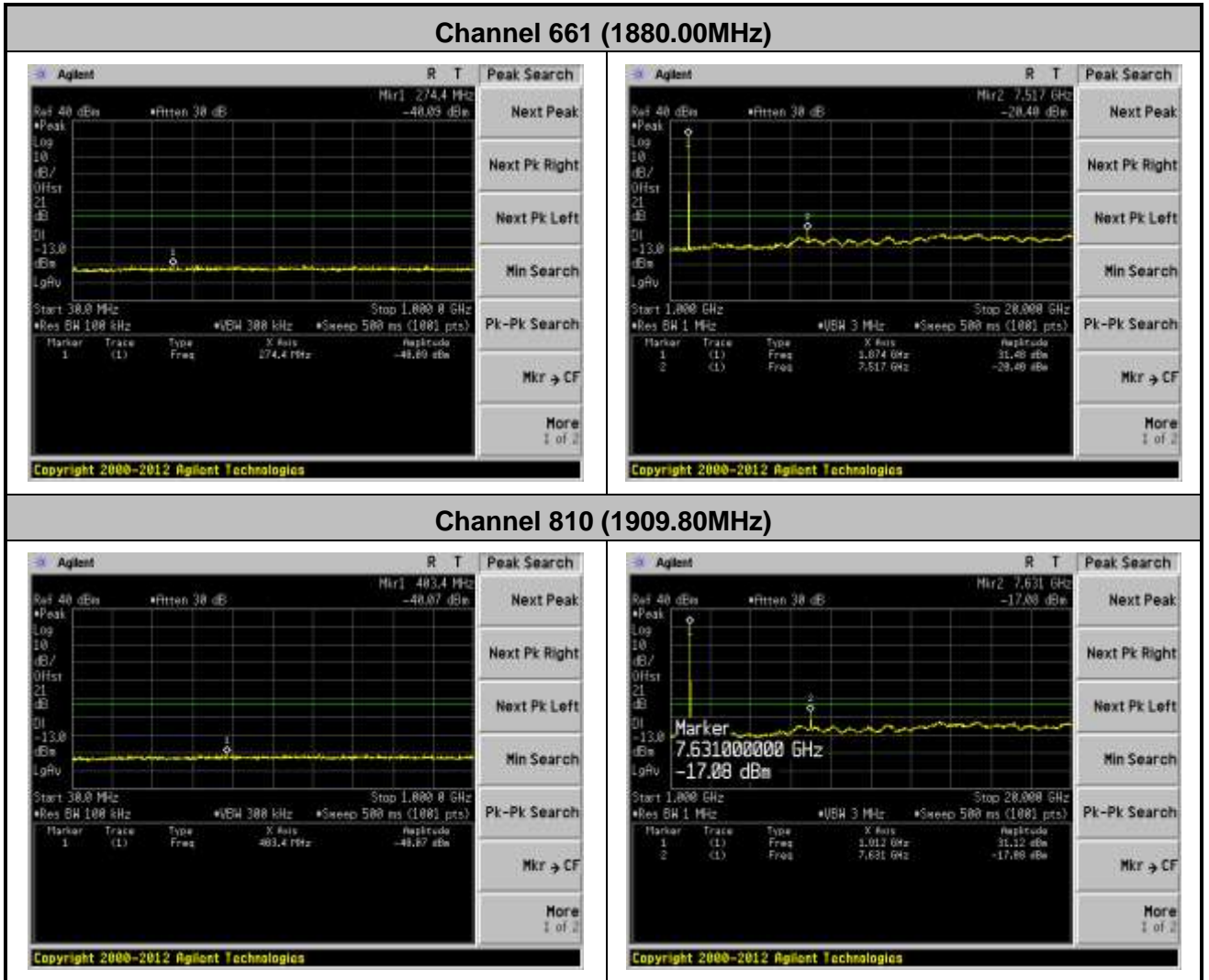

Mode	Channel No.	Frequency (MHz)	Modulation	Test Result
EDGE850	128	824.20	8PSK	Pass
EDGE850	189	836.40	8PSK	Pass
EDGE850	251	848.80	8PSK	Pass

Band Edge

Channel 128 (824.20MHz)

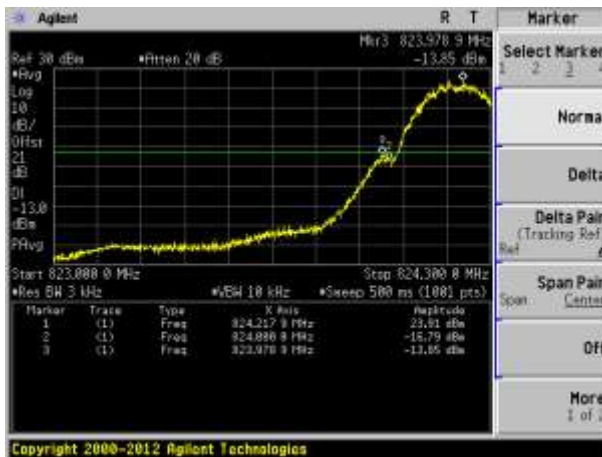

Channel 251 (848.80MHz)

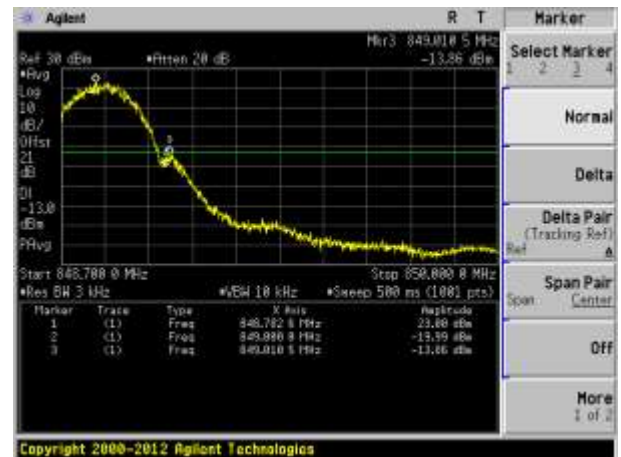

Conducted Spurious Emission

Channel 128 (824.20MHz)

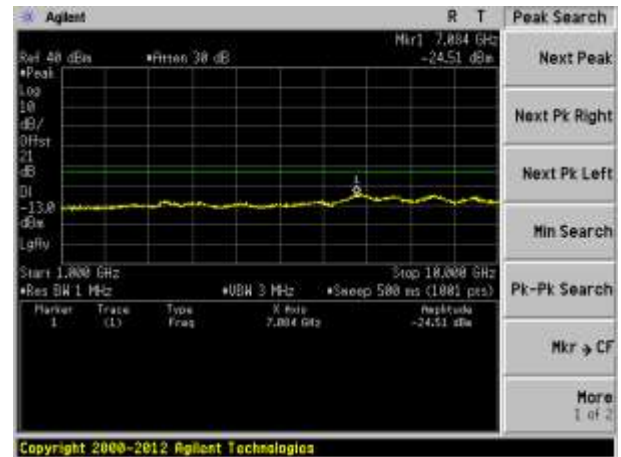
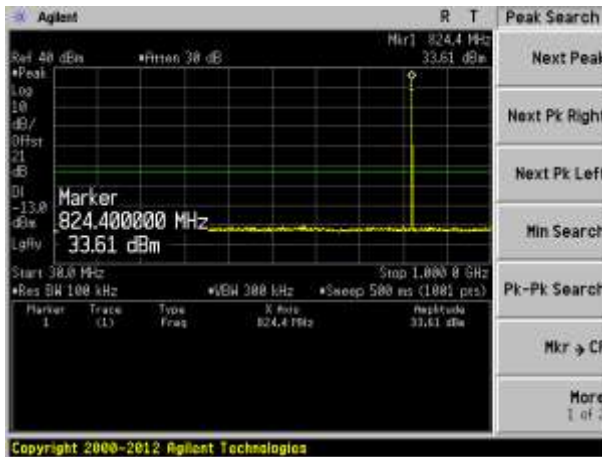

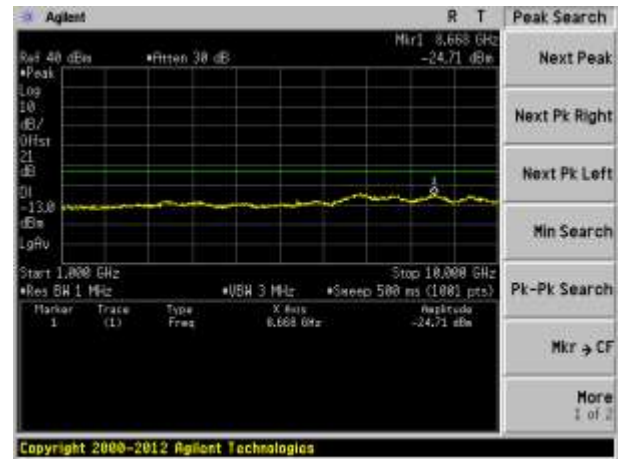
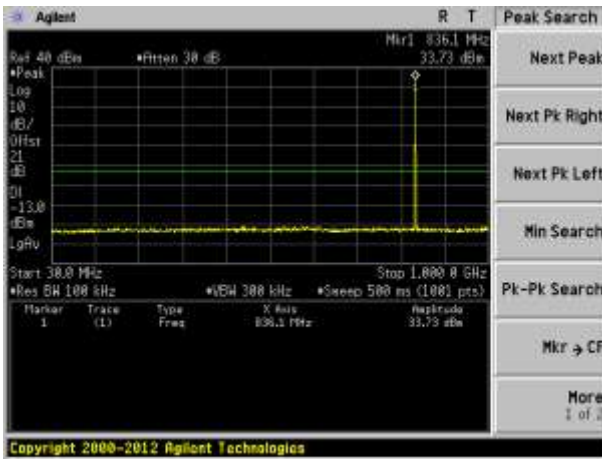
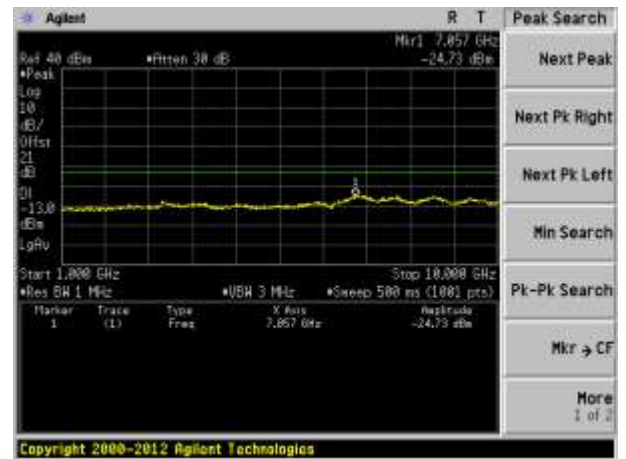
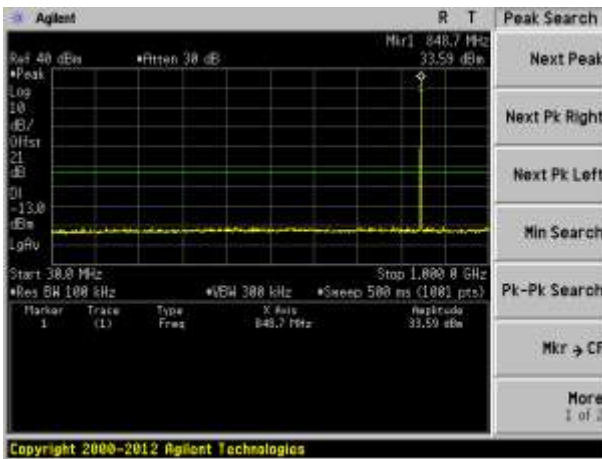
Channel 189 (836.40MHz)

Channel 251 (848.80MHz)

Mode	Channel No.	Frequency (MHz)	Modulation	Test Result
EDGE1900	512	1850.20	8PSK	Pass
EDGE1900	661	1880.00	8PSK	Pass
EDGE1900	810	1909.80	8PSK	Pass

Band Edge

Channel 512 (1850.20MHz)



Channel 810 (1909.80MHz)

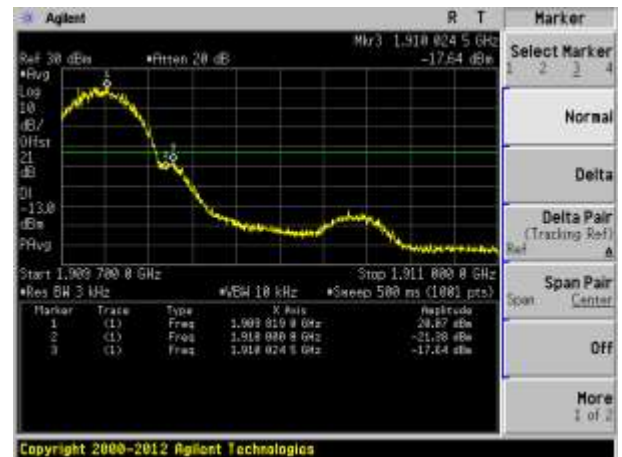

Conducted Spurious Emission

Channel 512 (1850.20MHz)

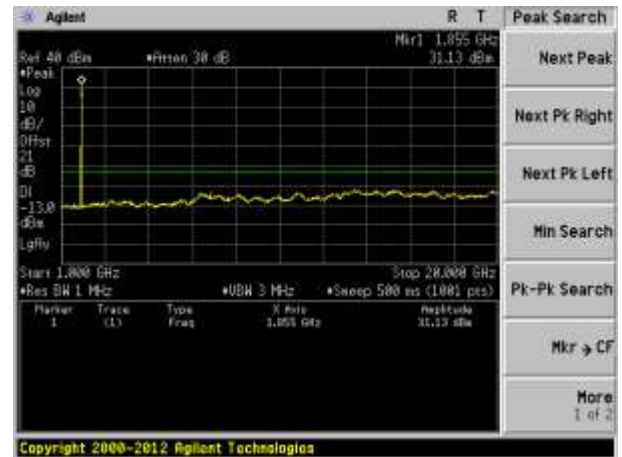
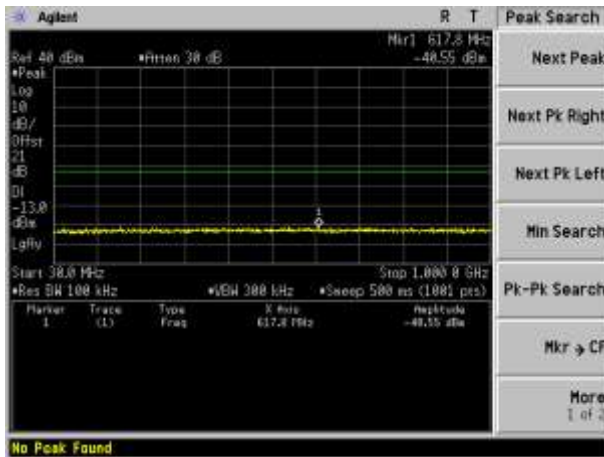

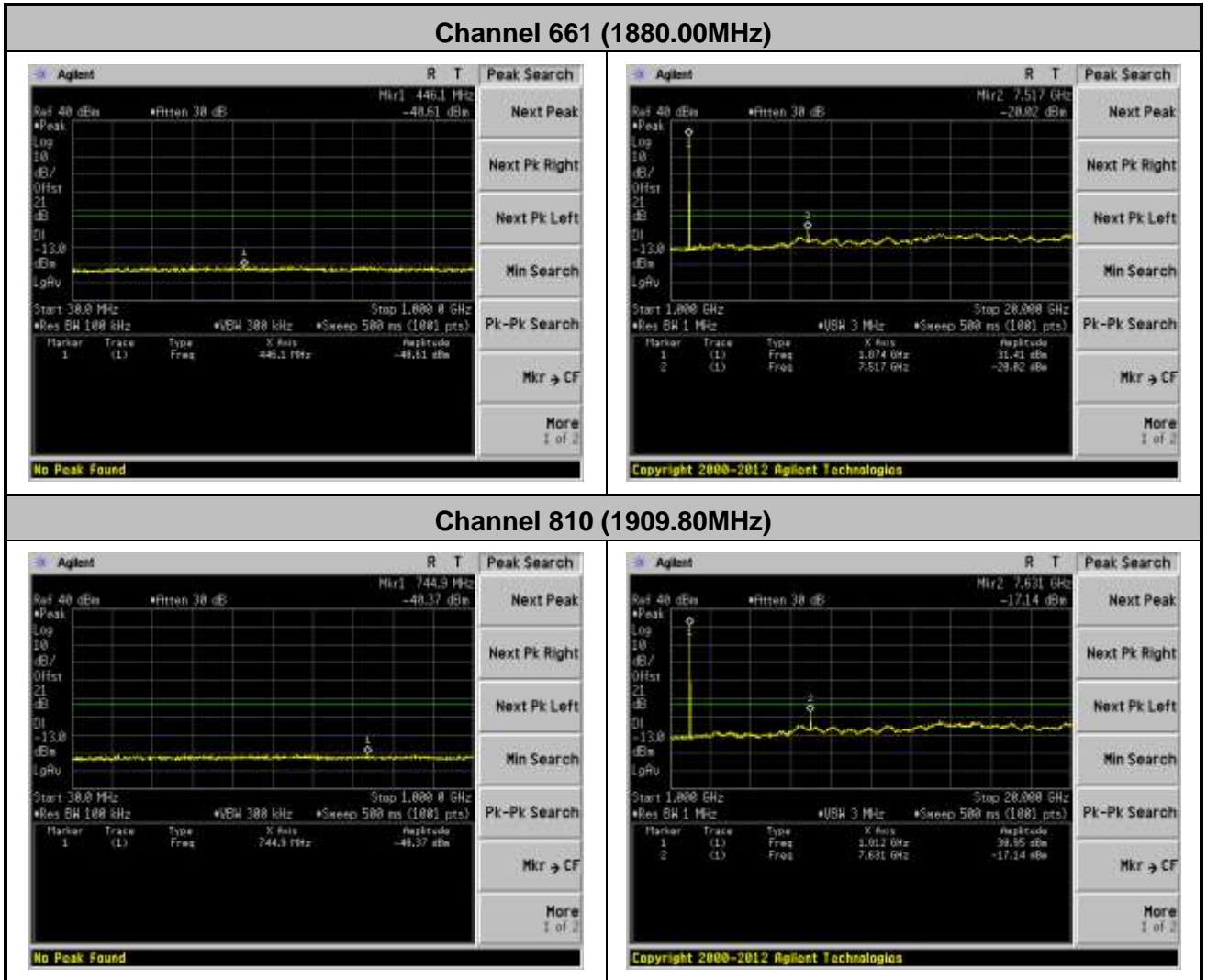

Mode	Channel No.	Frequency (MHz)	Modulation	Test Result
WCDMA Band II	9262	1852.40	QPSK	Pass
WCDMA Band II	9400	1880.00	QPSK	Pass
WCDMA Band II	9538	1907.60	QPSK	Pass

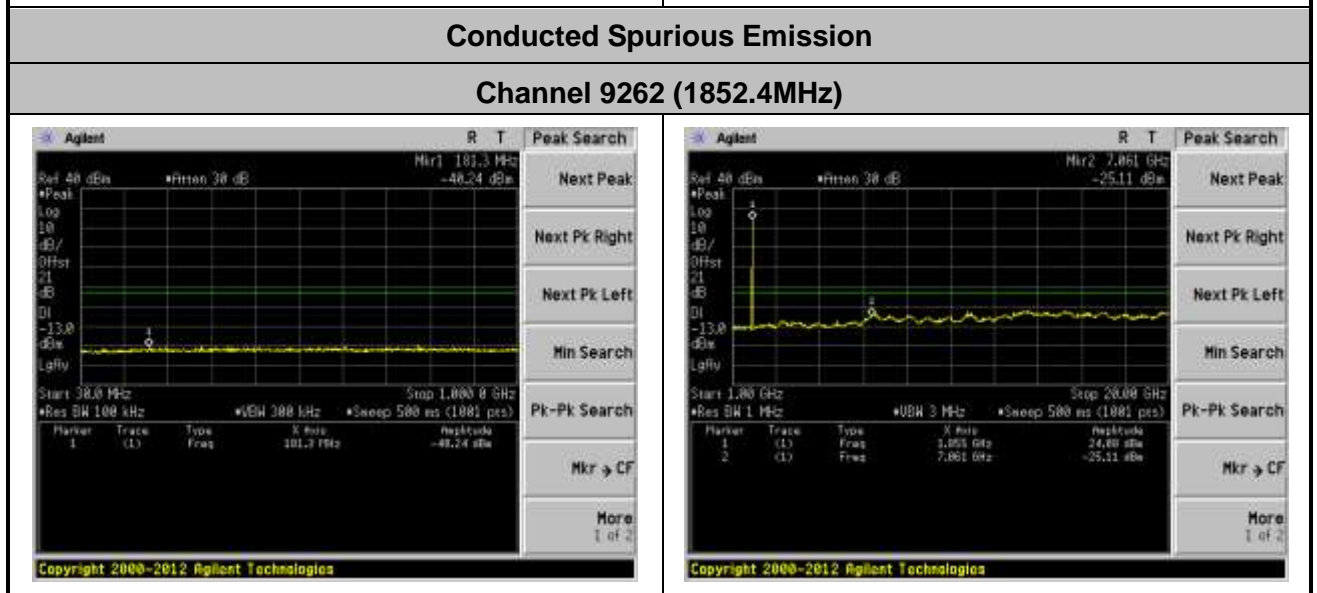
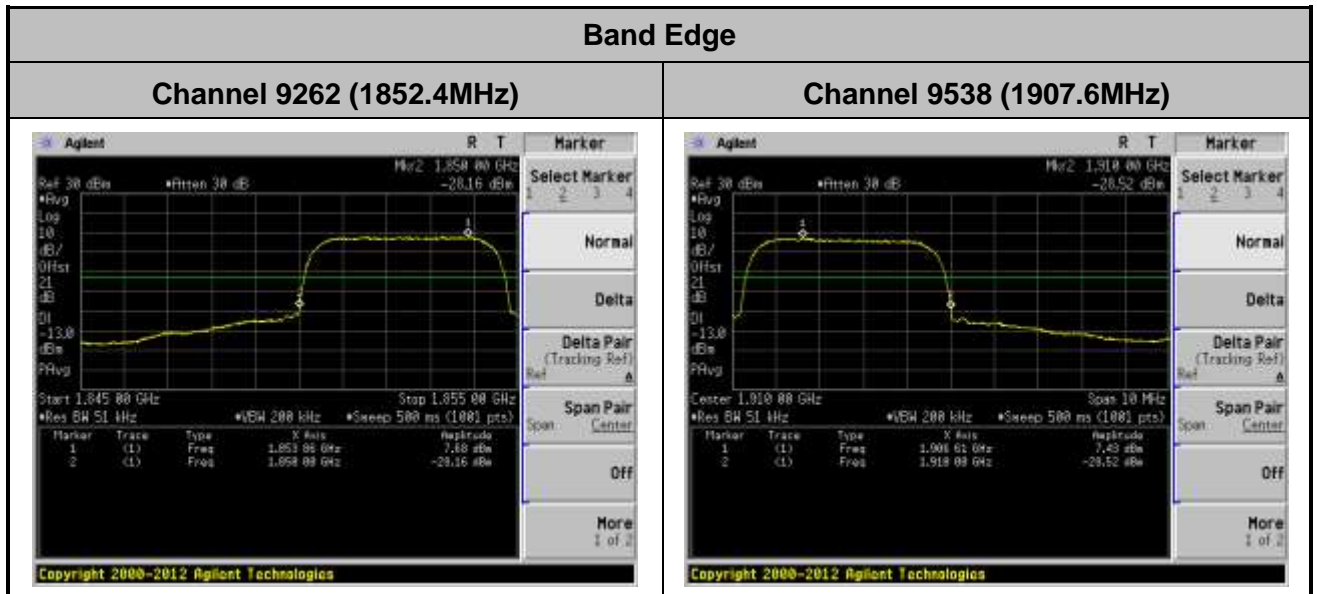

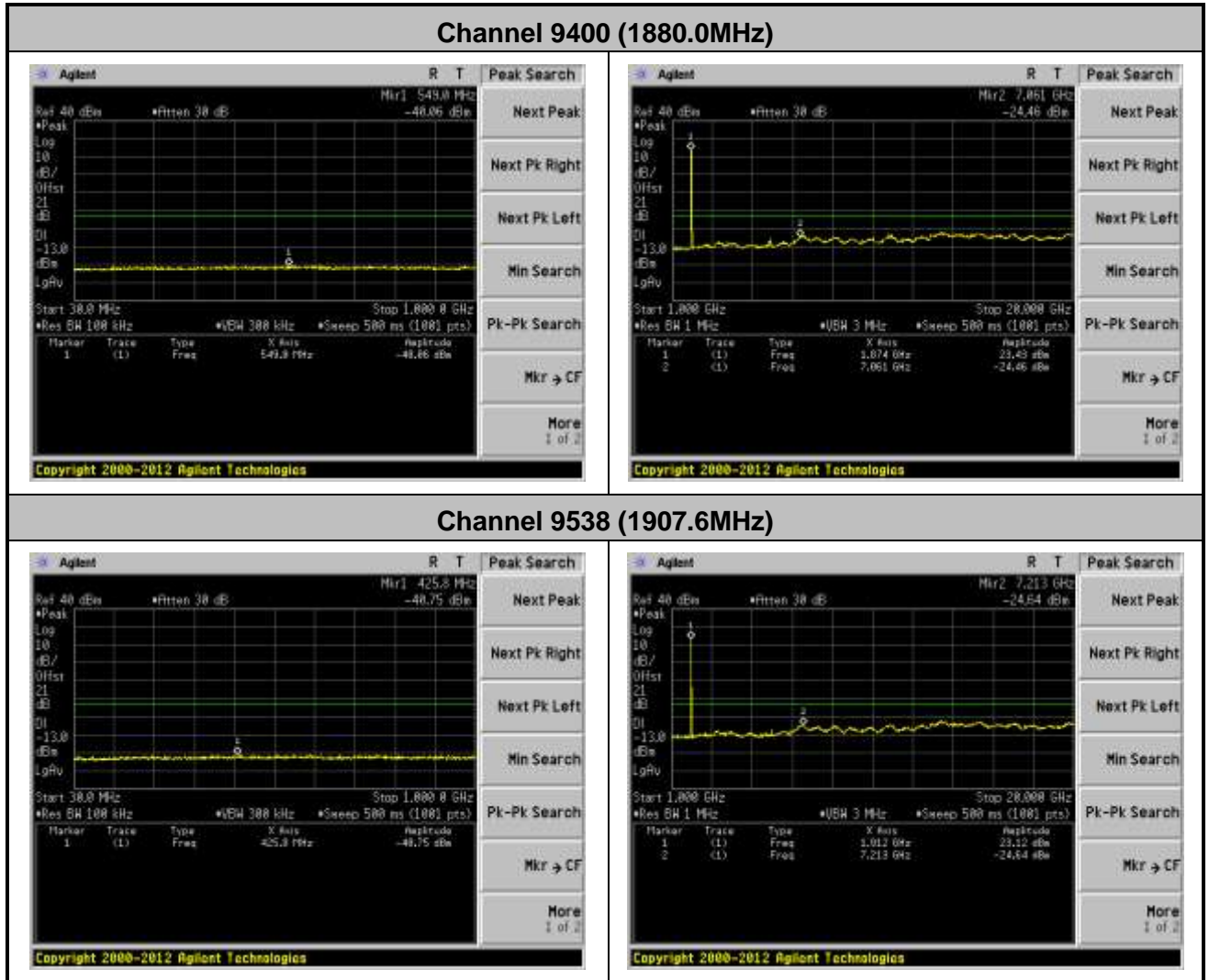

Mode	Channel No.	Frequency (MHz)	Modulation	Test Result
WCDMA Band V	4132	826.40	QPSK	Pass
WCDMA Band V	4182	836.40	QPSK	Pass
WCDMA Band V	4233	846.60	QPSK	Pass

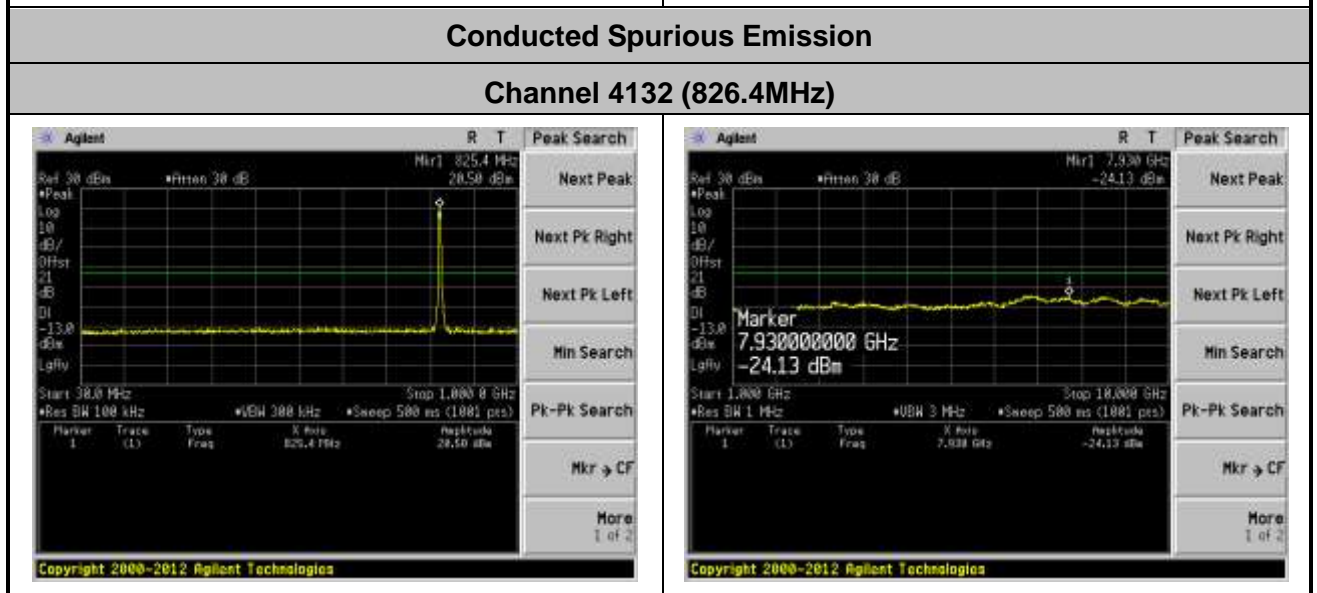
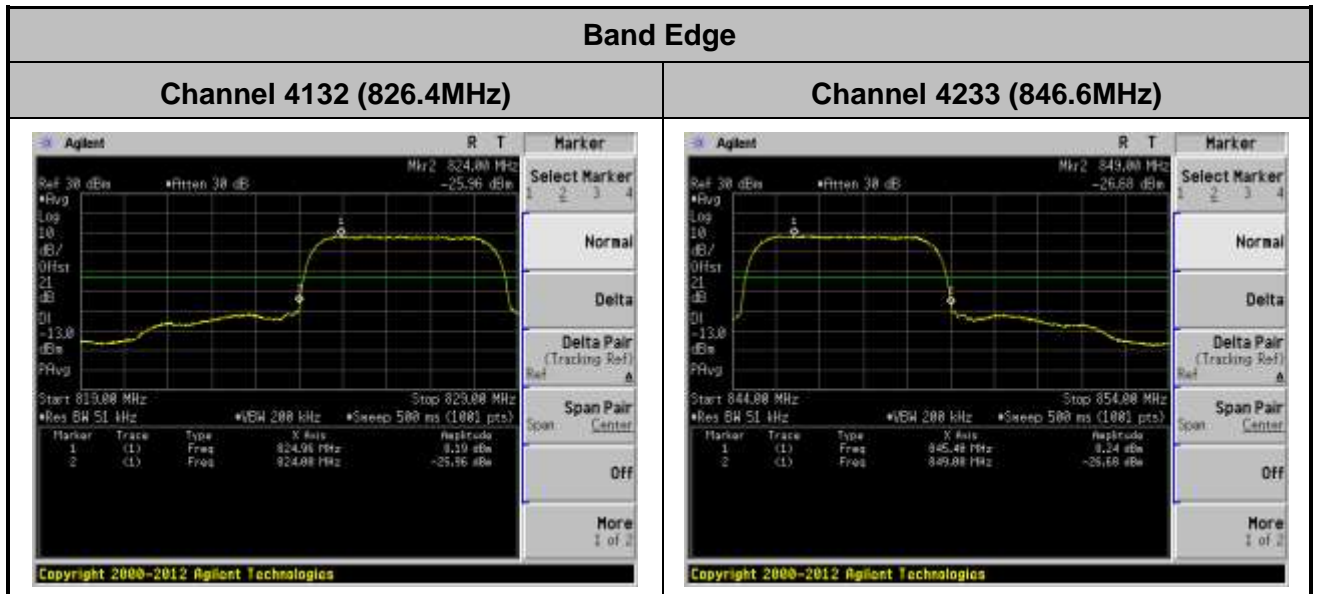

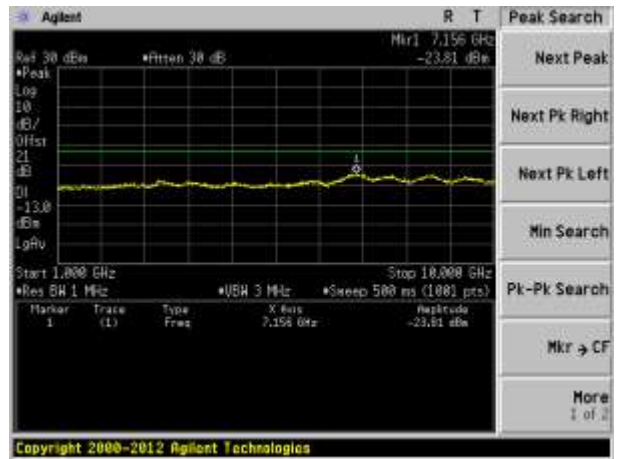
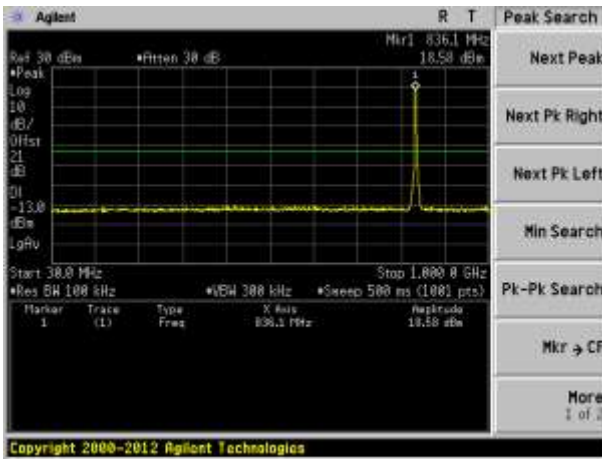
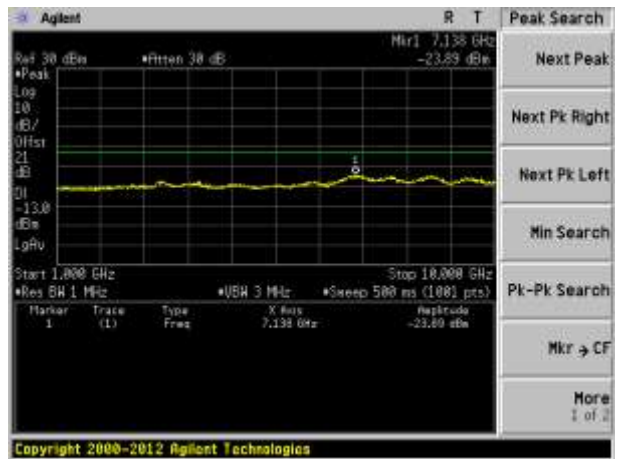
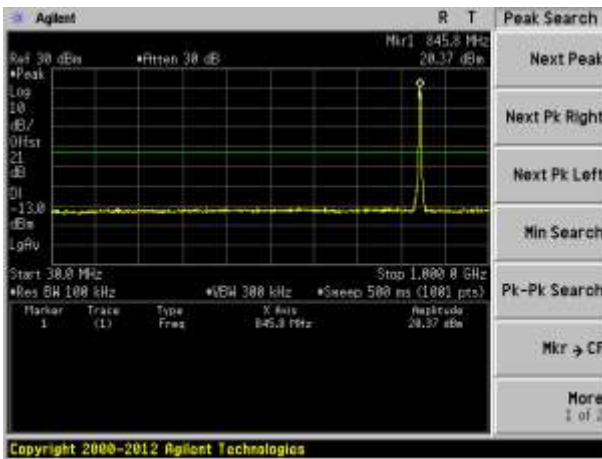
Channel 4182 (836.4MHz)

Channel 4233 (846.6MHz)

7.4. Radiated Power and Radiated Spurious Emissions

7.4.1. Test Limit

Radiated Power

For FCC Part 22.913(a)(2):

The ERP of mobile transmitters and auxiliary test transmitters must not exceed 7 Watts.

For FCC Part 24.232(b):

The EIRP of mobile transmitters and auxiliary test transmitters must not exceed 2 Watts.

Radiated Spurious Emissions

The power of any emission outside of the authorized operating frequency ranges must be attenuated below the transmitting power (P) by a factor of at least $43 + 10\log(P)$ dB.

7.4.2. Test Procedure Used

KDB 971168 D01v02r01 - Section 7.0 & ANSI/TIA-603-C-2004

7.4.3. Test Setting

1. The EUT shall be placed at the specified height on a support, and in the position closest to normal use as declared by provider.
2. The test antenna shall be oriented initially for vertical polarization and shall be chosen to correspond to the frequency of the transmitter
3. The output of the test antenna shall be connected to the measuring receiver.
4. The transmitter shall be switched on and the measuring receiver shall be tuned to the frequency of the transmitter under test.
5. The test antenna shall be raised and lowered through the specified range of height until a maximum signal level is detected by the measuring receiver.
6. The transmitter shall then be rotated through 360° in the horizontal plane, until the maximum signal level is detected by the measuring receiver.
7. The test antenna shall be raised and lowered again through the specified range of height until a maximum signal level is detected by the measuring receiver.

8. The maximum signal level detected by the measuring receiver shall be noted.
9. The transmitter shall be replaced by a substitution antenna.
10. The substitution antenna shall be orientated for vertical polarization and the length of the substitution antenna shall be adjusted to correspond to the frequency of the transmitter.
11. The substitution antenna shall be connected to a calibrated signal generator.
12. If necessary, the input attenuator setting of the measuring receiver shall be adjusted in order to increase the sensitivity of the measuring receiver.
13. The test antenna shall be raised and lowered through the specified range of height to ensure that the maximum signal is received.
14. The input signal to the substitution antenna shall be adjusted to the level that produces a level detected by the measuring receiver, that is equal to the level noted while the transmitter radiated power was measured, corrected for the change of input attenuator setting of the measuring receiver.
15. The measurement shall be repeated with the test antenna and the substitution antenna orientated for horizontal polarization.
16. The measure of the effective radiated power is the larger of the two levels recorded at the input to the substitution antenna, corrected for gain of the substitution antenna if necessary.
17. Test site anechoic chamber refer to ANSI C63.4: 2009.

7.4.4. Test Setup

30MHz ~ 1GHz Test Setup:

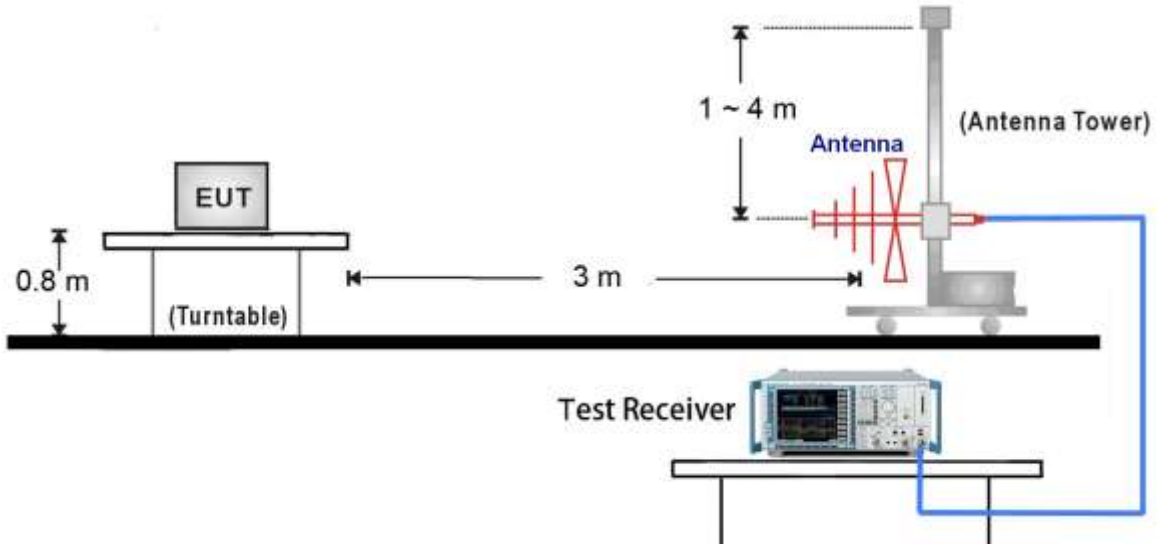

1GHz ~ 19GHz Test Setup:

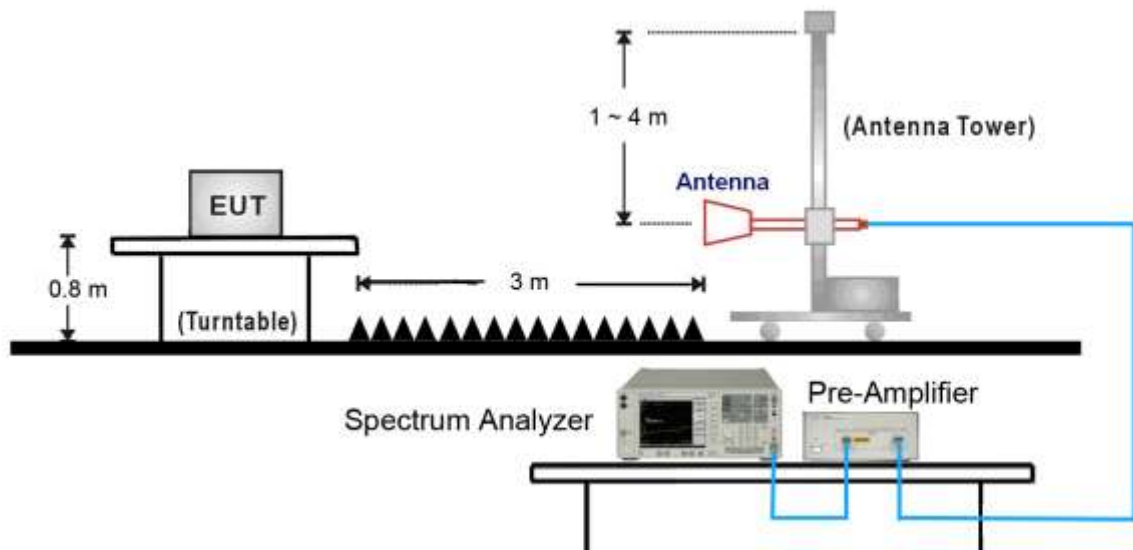

7.4.5. Test Result

Radiated Power

GSM850

Frequency (MHz)	Ant. Pol. (H/V)	SG Reading (dBm)	Cable Loss (dB)	Substitute Antenna Gain (dBd)	ERP (dBm)	Limit (dBm)	Margin (dB)
Low Channel 128 (824.20MHz)							
824.2	H	26.62	1.78	6.52	31.36	38.50	-7.14
824.2	V	22.74	1.78	6.38	27.34	38.50	-11.16
Middle Channel 189 (836.40MHz)							
836.4	H	25.92	1.80	6.63	30.75	38.50	-7.75
836.4	V	19.04	1.80	6.15	23.39	38.50	-15.11
High Channel 251 (848.80MHz)							
848.8	H	26.28	1.82	6.80	31.26	38.50	-7.24
848.8	V	21.56	1.82	6.54	26.28	38.50	-12.22

PCS1900

Frequency (MHz)	Ant. Pol. (H/V)	SG Reading (dBm)	Cable Loss (dB)	Substitute Antenna Gain (dBi)	EIRP (dBm)	Limit (dBm)	Margin (dB)
Low Channel 512 (1850.20MHz)							
1850.2	H	25.71	2.70	4.64	27.65	33.00	-5.35
1850.2	V	20.28	2.70	4.64	22.22	33.00	-10.78
Middle Channel 661 (1880.00MHz)							
1880.0	H	26.17	2.72	4.59	28.04	33.00	-4.96
1880.0	V	21.42	2.72	4.59	23.29	33.00	-9.71
High Channel 810 (1909.80MHz)							
1909.8	H	25.23	2.75	4.54	27.02	33.00	-5.98
1909.8	V	19.17	2.75	4.54	20.96	33.00	-12.04

EDGE850

Frequency (MHz)	Ant. Pol. (H/V)	SG Reading (dBm)	Cable Loss (dB)	Substitute Antenna Gain (dBd)	ERP (dBm)	Limit (dBm)	Margin (dB)
Low Channel 128 (824.20MHz)							
824.2	H	19.69	1.78	6.52	24.43	38.50	-14.07
824.2	V	13.77	1.78	6.38	18.37	38.50	-12.13
Middle Channel 189 (836.40MHz)							
836.4	H	19.55	1.80	6.63	24.38	38.50	-14.12
836.4	V	15.68	1.80	6.15	20.03	38.50	-18.47
High Channel 251 (848.80MHz)							
848.8	H	20.94	1.82	6.80	25.92	38.50	-12.58
848.8	V	17.18	1.82	6.54	21.90	38.50	-16.60

EDGE1900

Frequency (MHz)	Ant. Pol. (H/V)	SG Reading (dBm)	Cable Loss (dB)	Substitute Antenna Gain (dBi)	EIRP (dBm)	Limit (dBm)	Margin (dB)
Low Channel 512 (1850.20MHz)							
1850.2	H	22.00	2.70	4.64	23.94	33.00	-9.06
1850.2	V	17.80	2.70	4.64	19.74	33.00	-13.26
Middle Channel 661 (1880.00MHz)							
1880.0	H	23.05	2.72	4.59	24.92	33.00	-8.08
1880.0	V	18.34	2.72	4.59	20.21	33.00	-12.79
High Channel 810 (1909.80MHz)							
1909.8	H	22.01	2.75	4.54	23.80	33.00	-9.20
1909.8	V	19.28	2.75	4.54	21.07	33.00	-11.93

WCDMA Band II

Frequency (MHz)	Ant. Pol. (H/V)	SG Reading (dBm)	Cable Loss (dB)	Substitute Antenna Gain (dBi)	EIRP (dBm)	Limit (dBm)	Margin (dB)
Low Channel 9262 (1852.40MHz)							
1852.4	H	20.31	2.70	4.64	22.25	33.00	-10.75
1852.4	V	9.15	2.70	4.64	11.09	33.00	-21.91
Middle Channel 9400 (1880.00MHz)							
1880.0	H	21.04	2.72	4.59	22.91	33.00	-10.09
1880.0	V	11.21	2.72	4.59	13.08	33.00	-19.92
High Channel 9538 (1907.60MHz)							
1907.6	H	20.88	2.75	4.55	22.68	33.00	-10.32
1907.6	V	9.99	2.75	4.55	11.79	33.00	-21.21

WCDMA Band V

Frequency (MHz)	Ant. Pol. (H/V)	SG Reading (dBm)	Cable Loss (dB)	Substitute Antenna Gain (dBd)	ERP (dBm)	Limit (dBm)	Margin (dB)
Low Channel 4132 (826.40MHz)							
826.4	H	17.42	1.79	6.50	22.13	38.50	-16.37
826.4	V	8.10	1.79	6.30	12.61	38.50	-25.89
Middle Channel 4182 (836.40MHz)							
836.4	H	16.61	1.80	6.63	21.44	38.50	-17.06
836.4	V	7.26	1.80	6.15	11.61	38.50	-26.89
High Channel 4233 (846.60MHz)							
846.6	H	17.20	1.82	6.80	22.18	38.50	-16.32
846.6	V	7.34	1.82	6.51	12.03	38.50	-26.47

NOTES:

- 1) This device was tested under all configurations and the highest power is reported in GSM mode. This device employs UMTS technology with WCDMA (AMR/RMC), HSDPA, HSUPA, HSPA+ and GSM/GPRS/EDGE capabilities. For WCDMA and HSPA transmission, all configurations were investigated and the worst case UMTS emissions were found in RMC WCDMA mode at 12.2kbps rate.
- 2) This unit was tested with its standard adapter.
- 3) The EUT was tested in three orthogonal planes and in all possible test configurations and

positioning. The “H” positioning is defined with the EUT lying flat on the test surface, the “H2” positioning is defined with the EUT standing up on its side, and the “V” positioning is defined with the EUT standing upright. The worst case test configuration was found in the EUT in the V positioning. The data reported in the table above was measured in this test setup.

Radiated Spurious Emission

GSM850

Frequency (MHz)	Ant. Pol. (H/V)	SG Reading (dBm)	Cable Loss (dB)	Substitute Antenna Gain (dBd)	ERP (dBm)	Limit (dBm)	Margin (dB)
Low Channel 128 (824.20MHz)							
1646.0	V	-40.99	2.55	5.13	-38.41	-13.0	-25.41
2479.0	V	-47.29	3.15	5.56	-44.88	-13.0	-31.88
1646.0	H	-33.32	2.55	5.13	-30.74	-13.0	-17.74
2479.0	H	-47.95	3.15	5.56	-45.54	-13.0	-32.54
Middle Channel 189 (836.40MHz)							
1680.0	V	-39.57	2.58	5.02	-37.13	-13.0	-24.13
2513.0	V	-48.91	3.18	5.64	-46.45	-13.0	-33.45
1680.0	H	-38.33	2.58	5.02	-35.89	-13.0	-22.89
2513.0	H	-42.12	3.18	5.64	-39.66	-13.0	-26.66
High Channel 251 (848.80MHz)							
1697.0	V	-40.60	2.59	4.97	-38.22	-13.0	-25.22
2547.0	V	-43.32	3.20	5.73	-40.79	-13.0	-27.79
1697.0	H	-42.15	2.59	4.97	-39.77	-13.0	-26.77
2547.0	H	-40.21	3.20	5.73	-37.68	-13.0	-24.68

Note: Spurious emissions within 30-1000MHz were found more than 20dB below limit line.

PCS1900

Frequency (MHz)	Ant. Pol. (H/V)	SG Reading (dBm)	Cable Loss (dB)	Substitute Antenna Gain (dBi)	EIRP (dBm)	Limit (dBm)	Margin (dB)
Low Channel 512 (1850.20MHz)							
3703.0	V	-44.57	3.90	7.88	-40.59	-13.0	-27.59
5556.0	V	-38.18	4.83	10.10	-32.91	-13.0	-19.91
3703.0	H	-43.65	3.90	7.88	-39.67	-13.0	-26.67
5556.0	H	-41.06	4.83	10.10	-35.79	-13.0	-22.79
Middle Channel 661 (1880.00MHz)							
3754.0	V	-46.89	3.93	7.91	-42.91	-13.0	-29.91
5641.0	V	-38.60	4.94	10.10	-33.44	-13.0	-20.44
3754.0	H	-44.92	3.93	7.91	-40.94	-13.0	-27.94
5641.0	H	-38.98	4.94	10.10	-33.82	-13.0	-20.82
High Channel 810 (1909.80MHz)							
3754.0	V	-46.27	3.93	7.91	-42.29	-13.0	-29.29
5641.0	V	-39.48	4.94	10.10	-34.32	-13.0	-21.32
3754.0	H	-43.04	3.93	7.91	-39.06	-13.0	-26.06
5641.0	H	-40.56	4.94	10.10	-35.40	-13.0	-22.40

Note: Spurious emissions within 30-1000MHz were found more than 20dB below limit line.

EDGE850

Frequency (MHz)	Ant. Pol. (H/V)	SG Reading (dBm)	Cable Loss (dB)	Substitute Antenna Gain (dBd)	ERP (dBm)	Limit (dBm)	Margin (dB)
Low Channel 128 (824.20MHz)							
1646.0	V	-44.99	2.55	5.13	-42.41	-13.0	-29.41
2479.0	V	-51.31	3.15	5.56	-48.90	-13.0	-35.90
1646.0	H	-39.29	2.55	5.13	-36.71	-13.0	-23.71
2479.0	H	-50.31	3.15	5.56	-47.90	-13.0	-34.90
Middle Channel 189 (836.40MHz)							
1680.0	V	-45.87	2.58	5.02	-43.43	-13.0	-30.43
2513.0	V	-54.16	3.18	5.64	-51.70	-13.0	-38.70
1680.0	H	-43.76	2.58	5.02	-41.32	-13.0	-28.32
2513.0	H	-52.50	3.18	5.64	-50.04	-13.0	-37.04
High Channel 251 (848.80MHz)							
1697.0	V	-51.56	2.59	4.97	-49.18	-13.0	-36.18
2751.0	V	-56.04	3.33	6.30	-53.07	-13.0	-40.07
1697.0	H	-48.16	2.59	4.97	-45.78	-13.0	-32.78
2547.0	H	-55.47	3.20	5.73	-52.94	-13.0	-39.94

Note: Spurious emissions within 30-1000MHz were found more than 20dB below limit line.

EDGE1900

Frequency (MHz)	Ant. Pol. (H/V)	SG Reading (dBm)	Cable Loss (dB)	Substitute Antenna Gain (dBi)	EIRP (dBm)	Limit (dBm)	Margin (dB)
Low Channel 512 (1850.20MHz)							
3703.0	V	-48.97	3.90	7.88	-44.99	-13.0	-31.99
5556.0	V	-49.46	4.83	10.10	-44.19	-13.0	-31.19
3703.0	H	-50.14	3.90	7.88	-46.16	-13.0	-33.16
5556.0	H	-45.84	4.83	10.10	-40.57	-13.0	-27.57
Middle Channel 661 (1880.00MHz)							
3754.0	V	-46.168	3.93	7.91	-32.46	-13.0	-19.46
5641.0	V	-42.715	4.94	10.10	-29.15	-13.0	-16.15
3754.0	H	-48.153	3.93	7.91	-33.94	-13.0	-20.94
5641.0	H	-44.818	4.94	10.10	-30.42	-13.0	-17.42
High Channel 810 (1909.80MHz)							
3822.0	V	-45.897	3.98	8.07	-30.52	-13.0	-17.52
5726.0	V	-41.345	5.00	10.10	-32.17	-13.0	-19.17
3822.0	H	-49.939	3.98	8.07	-35.65	-13.0	-22.65
5726.0	H	-47.447	5.00	10.10	-33.93	-13.0	-20.93

Note: Spurious emissions within 30-1000MHz were found more than 20dB below limit line.

WCDMA Band II

Frequency (MHz)	Ant. Pol. (H/V)	SG Reading (dBm)	Cable Loss (dB)	Substitute Antenna Gain (dBi)	EIRP (dBm)	Limit (dBm)	Margin (dB)
Low Channel 9262 (1852.40MHz)							
3703.0	V	-42.36	3.90	7.88	-38.38	-13.0	-25.38
5556.0	V	-40.66	4.83	10.10	-35.39	-13.0	-22.39
3703.0	H	-45.21	3.90	7.88	-41.23	-13.0	-28.23
5556.0	H	-36.38	4.83	10.10	-31.11	-13.0	-18.11
Middle Channel 9400 (1880.00MHz)							
3762.5	V	-46.168	3.94	7.93	-37.15	-13.0	-24.15
5632.5	V	-42.715	4.94	10.10	-24.01	-13.0	-11.01
3762.5	H	-48.153	3.94	7.93	-37.35	-13.0	-24.35
5641.0	H	-44.818	4.94	10.10	-26.99	-13.0	-13.99
High Channel 9538 (1907.60MHz)							
3813.5	V	-45.897	3.97	8.05	-34.38	-13.0	-21.38
5726.0	V	-41.345	5.00	10.10	-28.10	-13.0	-15.10
3813.5	H	-49.939	3.97	8.05	-35.11	-13.0	-22.11
5726.0	H	-47.447	5.00	10.10	-27.76	-13.0	-14.76

Note: Spurious emissions within 30-1000MHz were found more than 20dB below limit line.

WCDMA Band V

Frequency (MHz)	Ant. Pol. (H/V)	SG Reading (dBm)	Cable Loss (dB)	Substitute Antenna Gain (dBd)	ERP (dBm)	Limit (dBm)	Margin (dB)
Low Channel 4132 (826.40MHz)							
1658.0	V	-49.68	2.56	5.09	-47.15	-13.0	-34.15
2477.0	V	-41.67	3.15	5.55	-39.27	-13.0	-26.27
1658.0	H	-48.16	2.56	5.09	-45.63	-13.0	-32.63
2477.0	H	-37.63	3.15	5.55	-35.23	-13.0	-22.23
Middle Channel 4182 (836.40MHz)							
1672.0	V	-42.91	2.57	5.05	-40.43	-13.0	-27.43
2512.0	V	-37.79	3.18	5.63	-35.34	-13.0	-22.34
1672.0	H	-41.50	2.57	5.05	-39.02	-13.0	-26.02
2512.0	H	-35.32	3.18	5.63	-32.87	-13.0	-19.87
High Channel 4233 (846.60MHz)							
1693.0	V	-46.49	2.59	4.98	-44.10	-13.0	-31.10
2533.0	V	-40.09	3.19	5.69	-37.59	-13.0	-24.59
1693.0	H	-41.60	2.59	4.98	-39.21	-13.0	-26.21
2533.0	H	-32.11	3.19	5.69	-29.61	-13.0	-16.61

Note: Spurious emissions within 30-1000MHz were found more than 20dB below limit line.

7.5. Peak-Average Ratio

7.5.1. Test Limit

The transmitter's peak-to-average power ratio (PAPR) shall not exceed 13 dB for more than 0.1% of the time using a signal corresponding to the highest PAPR during periods of continuous transmission.

7.5.2. Test Procedure

KDB 971168 D01v02r01 - Section 5.7 & ANSI/TIA-603-C-2004

7.5.3. Test Setup

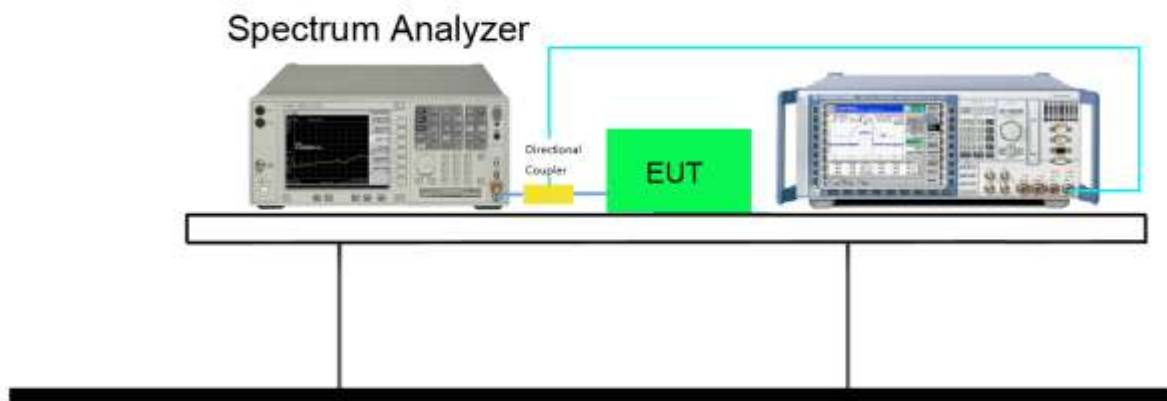

7.5.4. Test Result

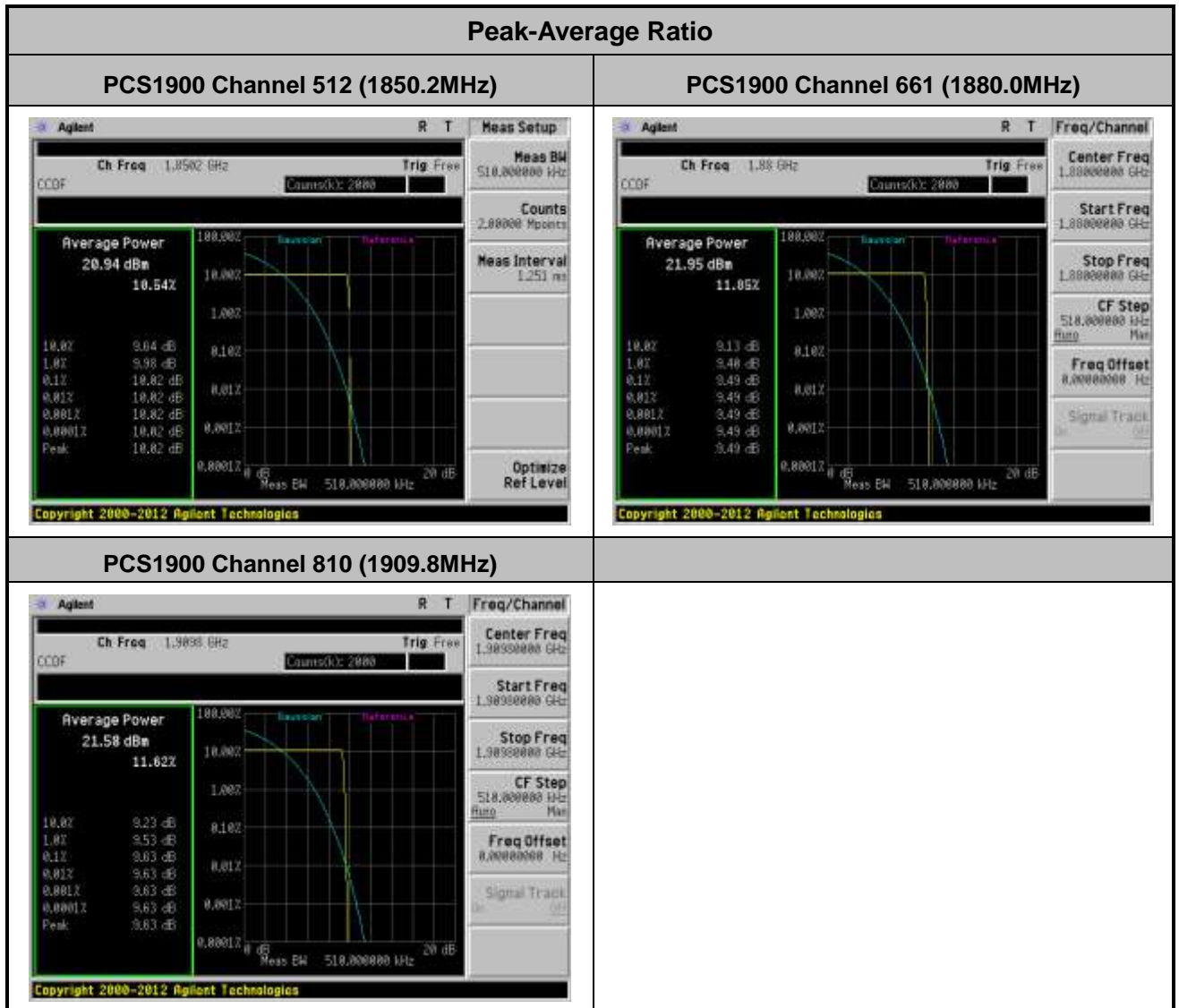

Peak-Average Ratio

EDGE1900 Channel 512 (1850.2MHz)



EDGE1900 Channel 661 (1880.0MHz)



EDGE1900 Channel 810 (1909.8MHz)

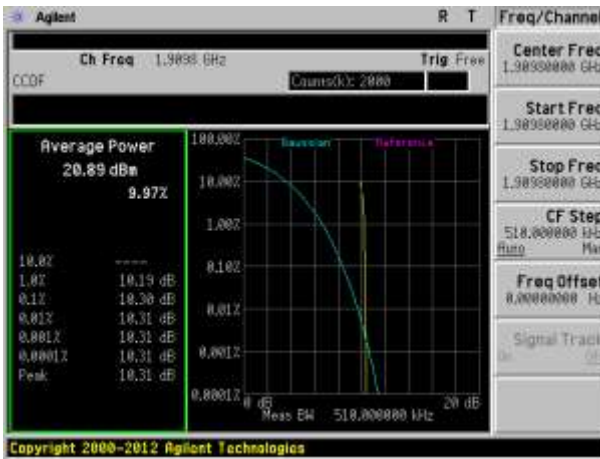

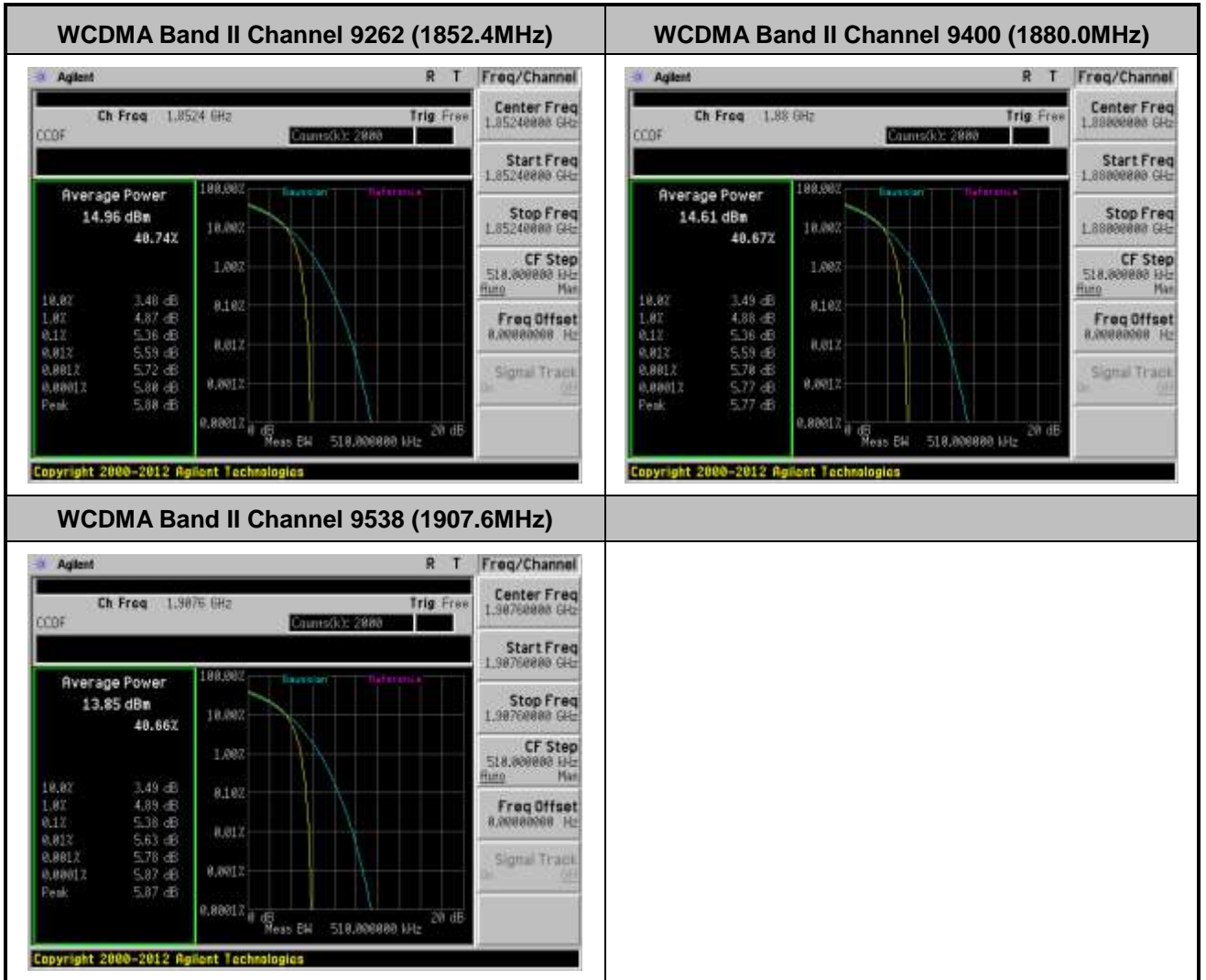

7.6. Frequency Stability Under Temperature & Voltage Variations

7.6.1. Test Limit

The frequency stability shall be sufficient to ensure that the fundamental emission stays within the authorized frequency block.

Limit	$< \pm 2.5$ ppm
-------	-----------------

7.6.2. Test Procedure

KDB 971168 D01v02r01 - Section 9.0 & ANSI/TIA-603-C-2004

7.6.3. Test Setup

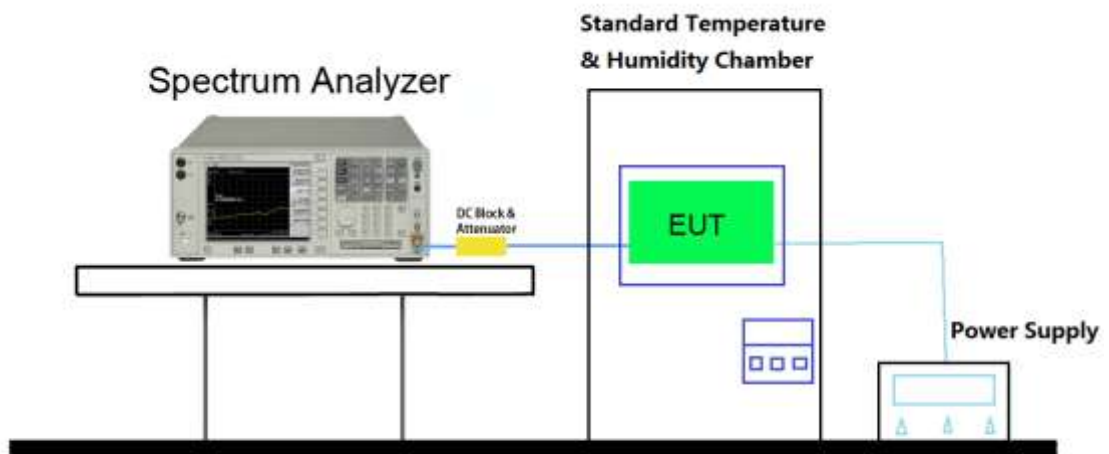

7.6.4. Test Result

Operating Frequency	836,400,000 Hz
Channel	189
Test Mode	GSM850
Reference Voltage	3.7 VDC
Deviation Limit	±0.000025% or 2.5ppm

Voltage (%)	Power (VDC)	TEMP (%)	Frequency (Hz)	Freq. Dev. (Hz)	Deviation (%)
100%	3.7	+20(Ref)	836,400,000	34	0.00000407
100%		-30	836,400,000	26	0.00000311
100%		-20	836,400,000	50	0.00000598
100%		-10	836,400,000	25	0.00000299
100%		0	836,400,000	36	0.00000430
100%		+10	836,400,000	45	0.00000538
100%		+20	836,400,000	32	0.00000383
100%		+30	836,400,000	-3	-0.00000036
100%		+40	836,400,000	-11	-0.00000132
100%		+50	836,400,000	34	0.00000407
115%		4.2	+20	836,400,000	35
BAT.ENDPOINT	3.6	+20	836,400,000	-14	-0.00000167

Operating Frequency	1,880,000,000 Hz
Channel	661
Test Mode	PCS1900
Reference Voltage	3.7 VDC
Deviation Limit	±0.000025% or 2.5ppm

Voltage (%)	Power (VDC)	TEMP (%)	Frequency (Hz)	Freq. Dev. (Hz)	Deviation (%)
100%	3.7	+20(Ref)	1,880,000,000	-24	-0.00000128
100%		-30	1,880,000,000	63	0.00000335
100%		-20	1,880,000,000	-12	-0.00000064
100%		-10	1,880,000,000	-20	-0.00000106
100%		0	1,880,000,000	51	0.00000271
100%		+10	1,880,000,000	29	0.00000154
100%		+20	1,880,000,000	-20	-0.00000106
100%		+30	1,880,000,000	60	0.00000319
100%		+40	1,880,000,000	-15	-0.00000080
100%		+50	1,880,000,000	28	0.00000149
115%		4.2	+20	1,880,000,000	50
BAT.ENDPOINT	3.6	+20	1,880,000,000	58	0.00000309

Operating Frequency	836,400,000 Hz
Channel	189
Test Mode	EDGE850
Reference Voltage	3.7 VDC
Deviation Limit	±0.000025% or 2.5ppm

Voltage (%)	Power (VDC)	TEMP (%)	Frequency (Hz)	Freq. Dev. (Hz)	Deviation (%)
100%	3.7	+20(Ref)	836,400,000	35	0.00000418
100%		-30	836,400,000	45	0.00000538
100%		-20	836,400,000	61	0.00000729
100%		-10	836,400,000	26	0.00000311
100%		0	836,400,000	51	0.00000610
100%		+10	836,400,000	60	0.00000717
100%		+20	836,400,000	50	0.00000598
100%		+30	836,400,000	-3	-0.00000036
100%		+40	836,400,000	-8	-0.00000096
100%		+50	836,400,000	55	0.00000658
115%		4.2	+20	836,400,000	53
BAT.ENDPOINT	3.6	+20	836,400,000	-5	-0.00000060

Operating Frequency	1,880,000,000 Hz
Channel	661
Test Mode	EDGE1900
Reference Voltage	3.7 VDC
Deviation Limit	±0.000025% or 2.5ppm

Voltage (%)	Power (VDC)	TEMP (%)	Frequency (Hz)	Freq. Dev. (Hz)	Deviation (%)
100%	3.7	+20(Ref)	1,880,000,000	-10	-0.00000053
100%		-30	1,880,000,000	80	0.00000426
100%		-20	1,880,000,000	-4	-0.00000021
100%		-10	1,880,000,000	-14	-0.00000074
100%		0	1,880,000,000	71	0.00000378
100%		+10	1,880,000,000	41	0.00000218
100%		+20	1,880,000,000	-11	-0.00000059
100%		+30	1,880,000,000	79	0.00000420
100%		+40	1,880,000,000	22	0.00000117
100%		+50	1,880,000,000	30	0.00000160
115%		4.2	+20	1,880,000,000	67
BAT.ENDPOINT	3.6	+20	1,880,000,000	73	0.00000388

Operating Frequency	1,880,000,000 Hz
Channel	9400
Test Mode	WCDMA Band II
Reference Voltage	3.7 VDC
Deviation Limit	±0.000025% or 2.5ppm

Voltage (%)	Power (VDC)	TEMP (%)	Frequency (Hz)	Freq. Dev. (Hz)	Deviation (%)
100%	3.7	+20(Ref)	1,880,000,000	42	0.00000223
100%		-30	1,880,000,000	13	0.00000069
100%		-20	1,880,000,000	34	0.00000181
100%		-10	1,880,000,000	50	0.00000266
100%		0	1,880,000,000	9	0.00000048
100%		+10	1,880,000,000	25	0.00000133
100%		+20	1,880,000,000	48	0.00000255
100%		+30	1,880,000,000	-14	-0.00000074
100%		+40	1,880,000,000	32	0.00000170
100%		+50	1,880,000,000	61	0.00000324
115%		4.2	+20	1,880,000,000	53
BAT.ENDPOINT	3.6	+20	1,880,000,000	67	0.00000356

Operating Frequency	836,400,000 Hz
Channel	4182
Test Mode	WCDMA Band V
Reference Voltage	3.7 VDC
Deviation Limit	±0.000025% or 2.5ppm

Voltage (%)	Power (VDC)	TEMP (%)	Frequency (Hz)	Freq. Dev. (Hz)	Deviation (%)
100%	3.7	+20(Ref)	836,400,000	42	0.00000502
100%		-30	836,400,000	10	0.00000120
100%		-20	836,400,000	25	0.00000299
100%		-10	836,400,000	39	0.00000466
100%		0	836,400,000	-5	-0.00000060
100%		+10	836,400,000	18	0.00000215
100%		+20	836,400,000	50	0.00000598
100%		+30	836,400,000	-14	-0.00000167
100%		+40	836,400,000	19	0.00000227
100%		+50	836,400,000	54	0.00000646
115%		4.2	+20	836,400,000	70
BAT.ENDPOINT	3.6	+20	836,400,000	61	0.00000729

8. CONCLUSION

The data collected relate only the item(s) tested and show that the **Smart Phone FCC ID: 2AAA6-S950** compliance with all the requirements of Parts 2, 22, 24 of the FCC Rules.

_____ The End _____