



Full

SAR TEST REPORT

No. 2014SAR0073

For

Client : VSN Technologies Inc.

d/b/a VSN Mobil

Production : WCDMA Digital Mobile Phone

Model Name : V.45

Model Number: V2002

FCC ID: 2AA9WV2002

Hardware Version: V01

Software Version: V01

Issued date: 2014-07-24

Note:

The test results in this test report relate only to the devices specified in this report. This report shall not be reproduced except in full without the written approval of ECIT Shanghai.

Test Laboratory:

ECIT Shanghai, East China Institute of Telecommunications

Add: 7-8F, G Area, No.668, Beijing East Road, Huangpu District, Shanghai, P. R. China

Tel: (+86)-021-63843300, E-Mail: welcome@ecit.org.cn

Revision Version

Report Number	Revision	Date	Memo
2014SAR0073	00	2014-06-25	Initial creation of test report
2014SAR0073	01	2014-07-24	Second creation of test report

CONTENTS

1.	TEST LABORATORY	6
1.1.	TESTING LOCATION	6
1.2.	TESTING ENVIRONMENT	6
1.3.	PROJECT DATA.....	6
1.4.	SIGNATURE	6
2.	STATEMENT OF COMPLIANCE.....	7
3.	CLIENT INFORMATION	9
3.1.	APPLICANT INFORMATION.....	9
3.2.	MANUFACTURER INFORMATION.....	9
4.	EQUIPMENT UNDER TEST (EUT) AND ANCILLARY EQUIPMENT (AE)	10
4.1.	ABOUT EUT	10
4.2.	INTERNAL IDENTIFICATION OF EUT USED DURING THE TEST	11
4.3.	INTERNAL IDENTIFICATION OF AE USED DURING THE TEST.....	11
5.	TEST METHODOLOGY	12
5.1.	APPLICABLE LIMIT REGULATIONS	12
5.2.	APPLICABLE MEASUREMENT STANDARDS	12
6.	SPECIFIC ABSORPTION RATE (SAR)	14
6.1.	INTRODUCTION.....	14
6.2.	SAR DEFINITION	14
7.	TISSUE SIMULATING LIQUIDS.....	15
7.1.	TARGETS FOR TISSUE SIMULATING LIQUID.....	15
7.2.	DIELECTRIC PERFORMANCE.....	15
8.	SYSTEM VERIFICATION	19
8.1.	SYSTEM SETUP	19
8.2.	SYSTEM VERIFICATION	20

9.	MEASUREMENT PROCEDURES.....	21
9.1.	TESTS TO BE PERFORMED.....	21
9.2.	GENERAL MEASUREMENT PROCEDURE.....	22
9.3.	WCDMA MEASUREMENT PROCEDURES FOR SAR.....	23
9.4.	BLUETOOTH & WI-FI MEASUREMENT PROCEDURES FOR SAR	24
9.5.	POWER DRIFT	25
10.	CONDUCTED OUTPUT POWER.....	26
10.1.	MANUFACTURING TOLERANCE	26
10.2.	GSM MEASUREMENT RESULT	30
10.3.	WCDMA MEASUREMENT RESULT	31
10.4.	WI-FI AND BT MEASUREMENT RESULT	32
11.	SIMULTANEOUS TX SAR CONSIDERATIONS.....	35
11.1.	INTRODUCTION.....	35
11.2.	TRANSMIT ANTENNA SEPARATION DISTANCES	35
11.3.	STANDALONE SAR TEST EXCLUSION CONSIDERATIONS.....	36
12.	EVALUATION OF SIMULTANEOUS	37
13.	SAR TEST RESULT	38
14.	SAR MEASUREMENT VARIABILITY	43
15.	MEASUREMENT UNCERTAINTY.....	45
16.	MAIN TEST INSTRUMENT	46
ANNEX A.	GRAPH RESULTS.....	47
ANNEX B.	SYSTEM VALIDATION RESULTS.....	124
ANNEX C.	SAR MEASUREMENT SETUP	130
ANNEX D.	POSITION OF THE WIRELESS DEVICE IN RELATION TO THE PHANTOM	136
ANNEX E.	EQUIVALENT MEDIA RECIPES	140
ANNEX F.	SYSTEM VALIDATION	141

ANNEX G. PROBE AND DAE CALIBRATION CERTIFICATE142

ANNEX H. DIPOLECALIBRATION CERTIFICATE167

1. Test Laboratory

1.1. Testing Location

Company Name:	ECIT Shanghai, East China Institute of Telecommunications
Address:	7-8F, G Area, No. 668, Beijing East Road, Huangpu District, Shanghai, P. R. China
Postal Code:	200001
Telephone:	(+86)-021-63843300
Fax:	(+86)-021-63843301

1.2. Testing Environment

Normal Temperature:	15-35°C
Relative Humidity:	20-75%
Ambient noise & Reflection:	< 0.012 W/kg

1.3. Project Data

Project Leader:	Wang Yaqiong
Testing Start Date:	2014-04-25
Testing End Date:	2014-05-05

1.4. Signature

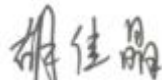

Hu Jiajing

(Prepared this test report)



Yu Naiping

(Reviewed this test report)

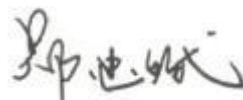

Zheng Zhongbin

Director of the laboratory

(Approved this test report)

2. Statement of Compliance

The maximum results of Specific Absorption Rate (SAR) found during testing for V.45 are as follows (with expanded uncertainty 22.4%)

Table 2.1: Max. Reported SAR (1g)

Band	Position/Distance	Reported SAR 1g(W/Kg)
GSM 850	Head/0mm	0.582
	Body/10mm	0.780
GSM 1900	Head/0mm	0.476
	Body/10mm	0.684
WCDMA850	Head/0mm	0.315
	Body/10mm	0.527
WCDMA 1900	Head/0mm	0.558
	Body/10mm	0.898
Wi-Fi	Head/0mm	0.329
	Body/10mm	0.452

The SAR values found for the Mobile Phone are below the maximum recommended levels of 1.6 W/Kg as averaged over any 1g tissue according to the ANSI C95.1-1992.

For body worn operation, this device has been tested and meets FCC RF exposure guidelines when used with any accessory that contains no metal. Use of other accessories may not ensure compliance with FCC RF exposure guidelines.

The measurement together with the test system set-up is described in chapter 7 of this test report. A detailed description of the equipment under test can be found in chapter 3 of this test report. The maximum reported SAR value is obtained at the case of **(Table 2.1)**, and the values are: **0.898 W/kg (1g)**.

NOTE:

- 1.Repeated measurement is not required when the original highest measured SAR is < 0.80 W/kg
- 2.Body Mode include Body-worn Mode and Hotspot Mode,The measurement of Body-worn Mode include hotspot mode test.

The sample has three antennas. One is main antenna for GSM/WCDMA, and the other two is for WiFi/BT and GPS. So simultaneous transmission is GSM/WCDMA and WiFi/BT.

Table 2.2: Simultaneous SAR (1g)

Simultaneous Transmission SAR(W/Kg)										
Test Position			GSM 850	GSM 1900	WCDMA B V	WCDMA B II	WCDMA B IV	WIFI	BT <small>note</small>	SUM
Head	Left	Cheek	0.582	0.476	0.315	0.558	0.255	0.329	0.167	0.911
		Tilt 15°	0.240	0.086	0.147	0.137	0.088	0.262	0.167	0.502
	Right	Cheek	0.313	0.395	0.186	0.460	0.422	0.158	0.167	0.627
		Tilt 15°	0.247	0.083	0.153	0.110	0.104	0.143	0.167	0.414
Body	Phantom Side		0.519	0.499	0.329	0.898	0.671	0.286	0.084	1.184
	Ground Side		0.780	0.422	0.527	0.762	1.127	0.452	0.084	1.579
	Left Side		0.511	0.245	0.322	0.238	0.211	0.021	0.084	0.595
	Right Side		0.380	0.015	0.268	0.141	N/A	0.308	0.084	0.688
	Top Side		N/A	N/A	N/A	N/A	N/A	0.086	0.084	N/A
	Bottom Side		0.131	0.684	0.110	0.496	0.953	0.029	0.084	1.037

According to the above table, the maximum sum of reported SAR values for GSM and WiFis is **1.579 W/kg (1g)**. The detail for simultaneous transmission consideration is described in chapter 13.

NOTE: Band IV test results are obtained from the TA report and the test report No. is RXA1405-0122SAR01R01).

3. Client Information

3.1. Applicant Information

Company Name: VSN Technologies Inc. d/b/a VSN Mobile
Address: 1975 E. Sunrise Blvd. Suite 400, Fort Lauderdale FL
Contact Person: Amit Verma
Telephone: 954-609-4912
Postcode: 33304

3.2. Manufacturer Information

Company Name: MOBIWIRE MOBILES (NINGBO) CO.,LTD
Address: No.999,Dacheng East Road,Fenghua City,Zhejiang
Contact Person: Xu Linzhong
Telephone: 0574 88916450
Postcode: 315500

4. Equipment Under Test (EUT) and Ancillary Equipment (AE)

4.1. About EUT

Description:	WCDMA Digital Mobile Phone
Model name:	V.45
Operation Model(s):	GSM850/1900,WCDMA1900/850,Wifi2450
Tx Frequency:	824.2-848.8, 1850.2-1909.8MHz (GSM) 1852.4-1907.6 MHz, 826.4-846.6MHz (WCDMA) 2412-2462 MHz (Wi-Fi) 2402~2480 MHz (BT)
Test device Production information:	Production unit
GPRS Class Mode:	B
GPRS Multislot Class:	12
Device type:	Portable device
UE category:	3
Antenna type:	Inner antenna
Accessories/Body-worn configurations:	Headset
Form factor:	13.7cm×6.8cm
Hotspot Mode:	Support simultaneous transmission of hotspot and voice (or data)
FCC ID:	2AA9WV2002

4.2. Internal Identification of EUT used during the test

EUT ID*	SN or IMEI	HW Version	SW Version
N03	SN:V.45201404080000083	V01	V01

*EUT ID: is used to identify the test sample in the lab internally.

4.3. Internal Identification of AE used during the test

AE ID*	Description	Model	SN	Manufacturer
B02	Battery	178069957	N/A	N/A
A01	Headset	TS813-28MS01-16R	N/A	HuiZhou Lianyun Electronic Technology Co., Ltd

*AE ID: is used to identify the test sample in the lab internally.

5. TEST METHODOLOGY

5.1. Applicable Limit Regulations

ANSI C95.1–1992: IEEE Standard for Safety Levels with Respect to Human Exposure to Radio Frequency Electromagnetic Fields, 3 kHz to 300 GHz.

It specifies the maximum exposure limit of **1.6 W/kg** as averaged over any 1 gram of tissue for portable devices being used within 20 cm of the user in the uncontrolled environment.

5.2. Applicable Measurement Standards

IC RSS-102 ISSUE4: Radio Frequency (RF) Exposure Compliance of Radiocommunication Apparatus (All Frequency Bands)

IEEE 1528–2003: Recommended Practice for Determining the Peak Spatial-Average Specific Absorption Rate (SAR) in the Human Body Due to Wireless Communications Devices: Experimental Techniques.

IEEE 1528a-2005: Recommended Practice for Determining the Peak Spatial-Average Specific Absorption Rate (SAR) in the Human Head From Wireless Communications Devices: Measurement Techniques.

KDB648474 D04 SAR Handsets Multi Xmitter and Ant v01r02: SAR Evaluation Considerations for Wireless Handsets.

KDB248227 SAR meas for 802.11abg v01r02: SAR measurement procedures for 802.112abg transmitters.

KDB447498 D01 General RF Exposure Guidance v05r02: Mobile and Portable Devices RF Exposure Procedures and Equipment Authorization Policies.

KDB865664 D01 v01r03: SAR Measurement Requirements for 100 MHz to 6 GHz

KDB865664 D02 RF Exposure Reporting v01r03: provides general reporting requirements as well as certain specific information required to support MPE and SAR compliance.

KDB941225 D01 SAR test for 3G devides v02: Recommended SAR Test Reduction Procedures for GSM/GPRS/EDGE.

KDB941225 D03 SAR test Redution GSM GPRS EDGE v01: Recommended SAR Test Reduction Procedures for GSM/GPRS/EDGE.

KDB941225 D06 hotspot SAR v01r01:SAR Evaluation Procedures for Portable Devices with Wireless Router Capabilities.

648474 D04 Handset SAR v01r01:SAR Evaluation Considerations for Wireless Handsets

6. Specific Absorption Rate (SAR)

6.1. Introduction

SAR is related to the rate at which energy is absorbed per unit mass in an object exposed to a radio field. The SAR distribution in a biological body is complicated and is usually carried out by experimental techniques or numerical modeling. The standard recommends limits for two tiers of groups, occupational/controlled and general population/uncontrolled, based on a person's awareness and ability to exercise control over his or her exposure. In general, occupational/controlled exposure limits are higher than the limits for general population/uncontrolled.

6.2. SAR Definition

The SAR definition is the time derivative (rate) of the incremental energy (dW) absorbed by (dissipated in) an incremental mass (dm) contained in a volume element (dv) of a given density (ρ). The equation description is as below:

$$SAR = \frac{d}{dt} \left(\frac{dW}{dm} \right) = \frac{d}{dt} \left(\frac{dW}{\rho dv} \right)$$

SAR is expressed in units of Watts per kilogram (W/kg)

SAR measurement can be either related to the temperature elevation in tissue by

$$SAR = c \left(\frac{\delta T}{\delta t} \right)$$

Where: C is the specific heat capacity, δT is the temperature rise and δt is the exposure duration, or related to the electrical field in the tissue by

$$SAR = \frac{\sigma |E|^2}{\rho}$$

Where: σ is the conductivity of the tissue, ρ is the mass density of tissue and E is the RMS electrical field strength.

However for evaluating SAR of low power transmitter, electrical field measurement is typically applied.

7. Tissue Simulating Liquids

7.1. Targets for tissue simulating liquid

Table 7.1: Targets for tissue simulating liquid

Frequency (MHz)	Liquid Type	Conductivity(σ)	$\pm 5\%$ Range	Permittivity(ϵ)	$\pm 5\%$ Range
835	Head	0.90	0.86~0.95	41.5	39.4~43.6
835	Body	0.97	0.92~1.02	55.2	52.4~58.0
1900	Head	1.40	1.33~1.47	40.0	38.0~42.0
1900	Body	1.52	1.44~1.60	53.3	50.6~56.0
2450	Head	1.80	1.71~1.89	39.2	37.2~41.2
2450	Body	1.95	1.85~2.05	52.7	50.1~55.3

7.2. Dielectric Performance

Table 7.2: Dielectric Performance of Tissue Simulating Liquid

Measurement Value						
Liquid Temperature: 21.0 °C						
Type	Frequency	Permittivity ϵ	Drift (%)	Conductivity σ	Drift (%)	Test Date
Head	835 MHz	41.04	-1.10%	0.917	1.88%	2014-04-25
Body	835 MHz	55.15	0.09%	0.99	2.97%	2014-04-26
Head	1900 MHz	39.64	-0.90%	1.385	-1.07%	2014-04-28
Body	1900 MHz	53.24	0.11%	1.524	0.26%	2014-04-29
Head	2450 MHz	39.12	-0.20%	1.809	0.5%	2014-05-04
Body	2450 MHz	53.95	2.37%	1.918	1.64%	2014-05-05

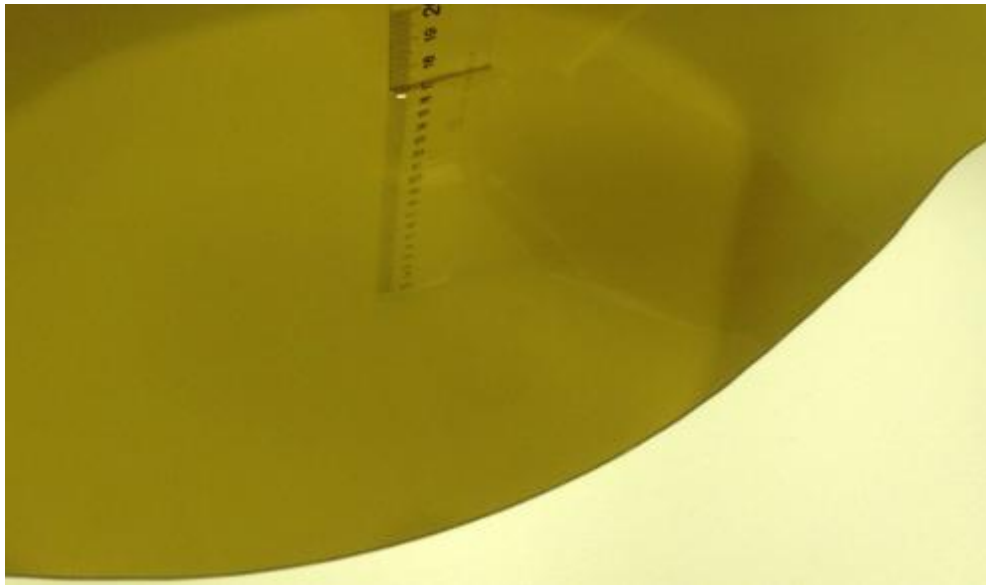

Picture 7-1: Liquid depth in the Flat Phantom (835 MHz Head)

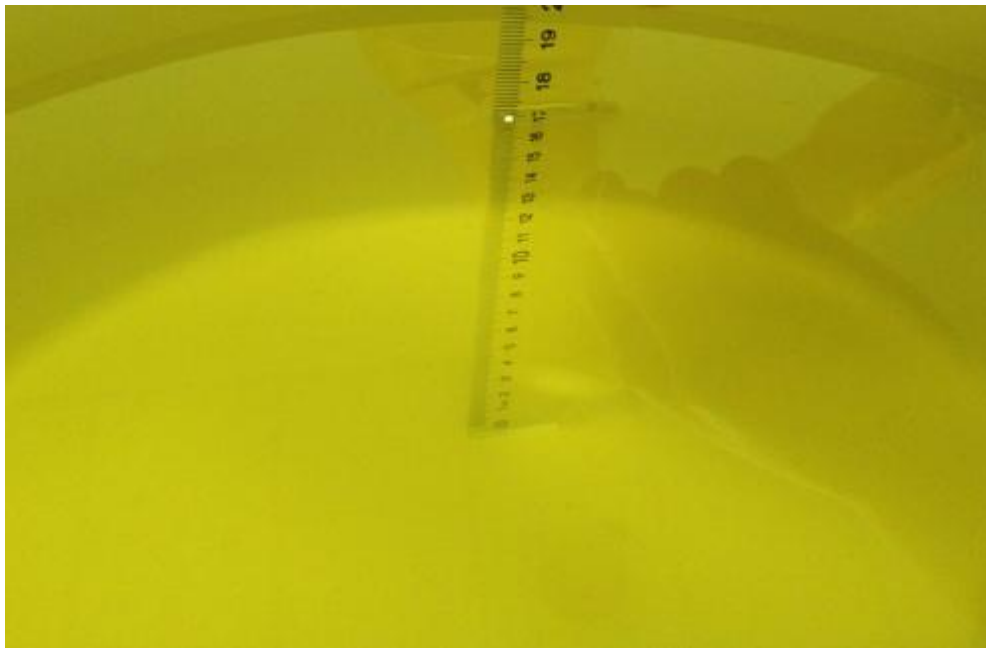

Picture 7-2: Liquid depth in the Flat Phantom (1900 MHz Head)



Picture 7-3: Liquid depth in the Flat Phantom (835 MHz Body)

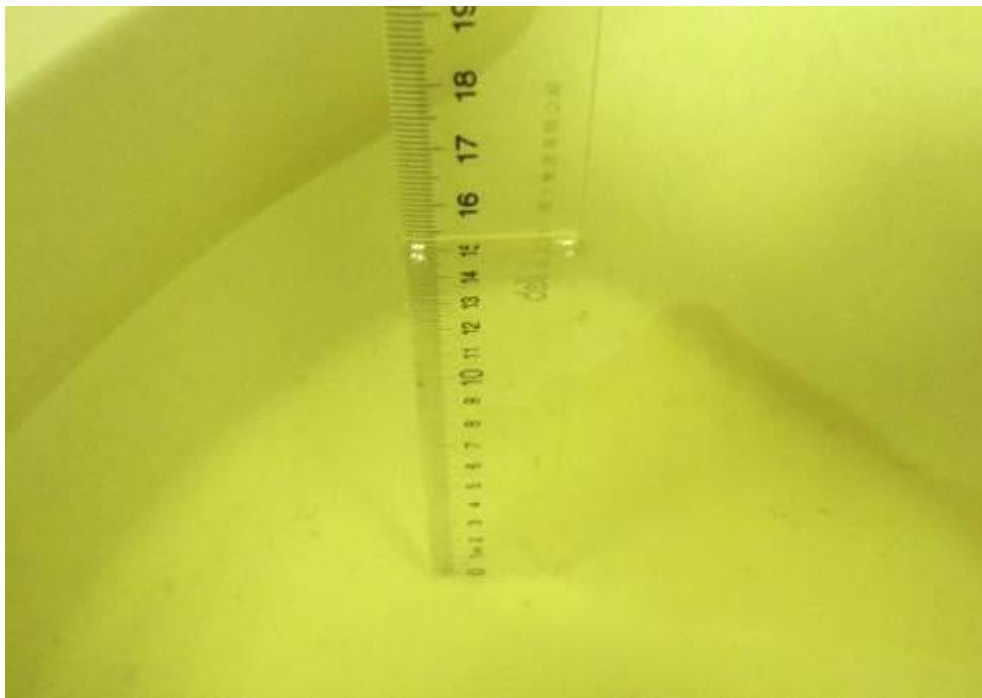

Picture 7-4: Liquid depth in the Flat Phantom (1900 MHz Body)

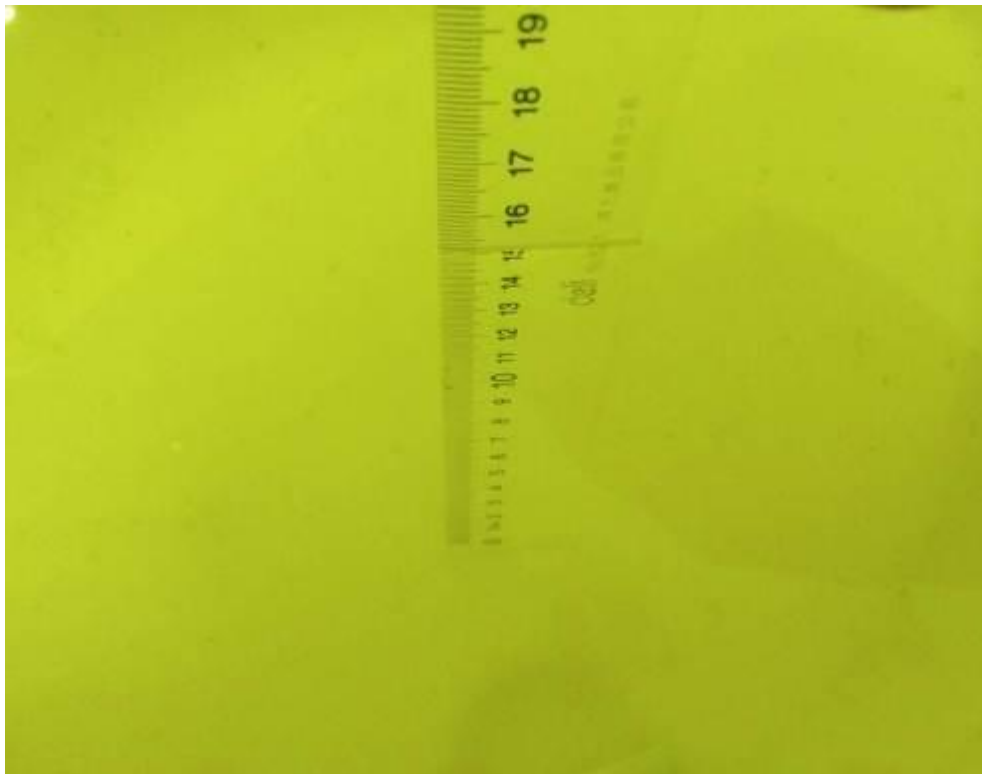

Picture 7-5: Liquid depth in the Flat Phantom (2450 MHz Head)

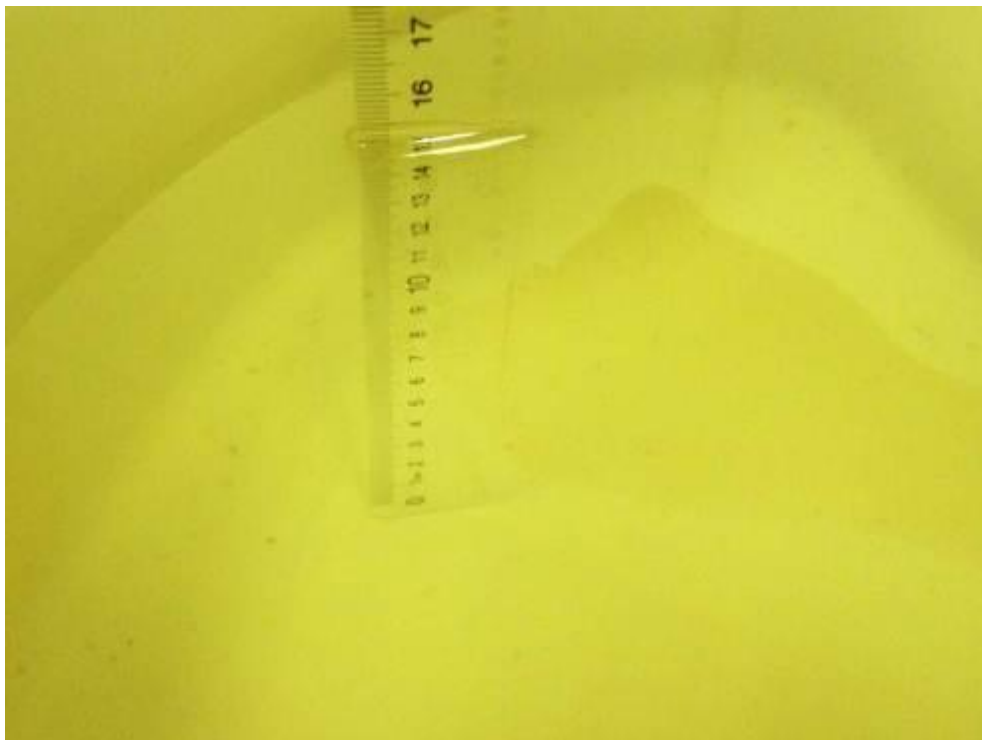

Picture 7-6: Liquid depth in the Flat Phantom (2450 MHz Body)

8. System verification

8.1. System Setup

In the simplified setup for system evaluation, the DUT is replaced by a calibrated dipole and the power source is replaced by a continuous wave that comes from a signal generator. The calibrated dipole must be placed beneath the flat phantom section of the SAM twin phantom with the correct distance holder. The distance holder should touch the phantom surface with a light pressure at the reference marking and be oriented parallel to the long side of the phantom. The equipment setup is shown below:

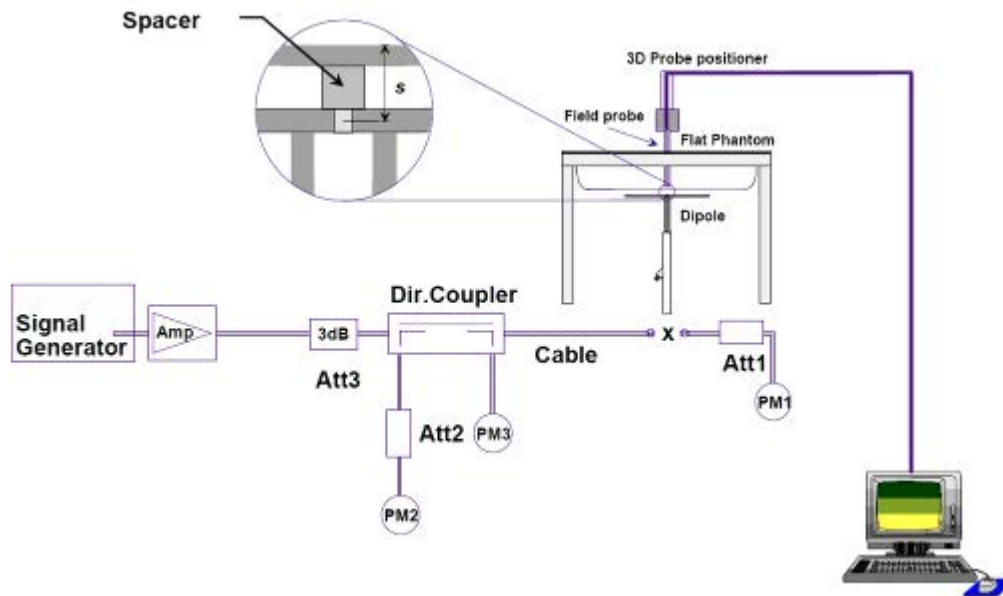

Picture 8.1 System Setup for System Evaluation



Picture 8.2 Photo of Dipole Setup

8.2. System Verification

SAR system verification is required to confirm measurement accuracy, according to the tissue dielectric media, probe calibration points and other system operating parameters required for measuring the SAR of a test device. The system verification must be performed for each frequency band and within the valid range of each probe calibration point required for testing the device.

Table 8.1: System Verification of Head

Verification Results							
Input power level: 250mW							
Frequency	Target value (W/kg)		Measured value (W/kg)		Deviation		Test date
	10 g Average	1 g Average	10 g Average	1 g Average	10 g Average	1 g Average	
835 MHz	5.98	9.12	6.04	9.16	1.00%	0.44%	2014-04-25
1900 MHz	22.2	42.7	21.68	42.2	-2.34%	-1.17%	2014-04-28
2450 MHz	23.0	49.5	23.88	50.48	3.83%	1.98%	2014-05-04

Table 8.2: System Verification of Body

Verification Results							
Input power level: 250mW							
Frequency	Target value (W/kg)		Measured value (W/kg)		Deviation		Test date
	10 g Average	1 g Average	10 g Average	1 g Average	10 g Average	1 g Average	
835 MHz	6.06	9.15	5.92	9	-2.31%	-1.64%	2014-04-26
1900 MHz	22.7	43.4	22.4	43.6	-1.32%	0.46%	2014-04-29
2450 MHz	22.2	47.7	22.24	47.88	0.18%	0.38%	2014-05-05

9. Measurement Procedures

9.1. Tests to be performed

In order to determine the highest value of the peak spatial-average SAR of a handset, all device positions, configurations and operational modes shall be tested for each frequency band according to steps 1 to 3 below. A flowchart of the test process is shown in Picture 11.1.

Step 1: The tests described in 11.2 shall be performed at the channel that is closest to the centre of the transmit frequency band (f_c) for:

- a) all device positions (cheek and tilt, for both left and right sides of the SAM phantom, as described in Chapter 8),
- b) all configurations for each device position in a), e.g., antenna extended and retracted, and
- c) all operational modes, e.g., analogue and digital, for each device position in a) and configuration in b) in each frequency band.

If more than three frequencies need to be tested according to 11.1 (i.e., $N_c > 3$), then all frequencies, configurations and modes shall be tested for all of the above test conditions.

Step 2: For the condition providing highest peak spatial-average SAR determined in Step 1, perform all tests described in 11.2 at all other test frequencies, i.e., lowest and highest frequencies. In addition, for all other conditions (device position, configuration and operational mode) where the peak spatial-average SAR value determined in Step 1 is within 3 dB of the applicable SAR limit, it is recommended that all other test frequencies shall be tested as well.

Step 3: Examine all data to determine the highest value of the peak spatial-average SAR found in Steps 1 to 2.

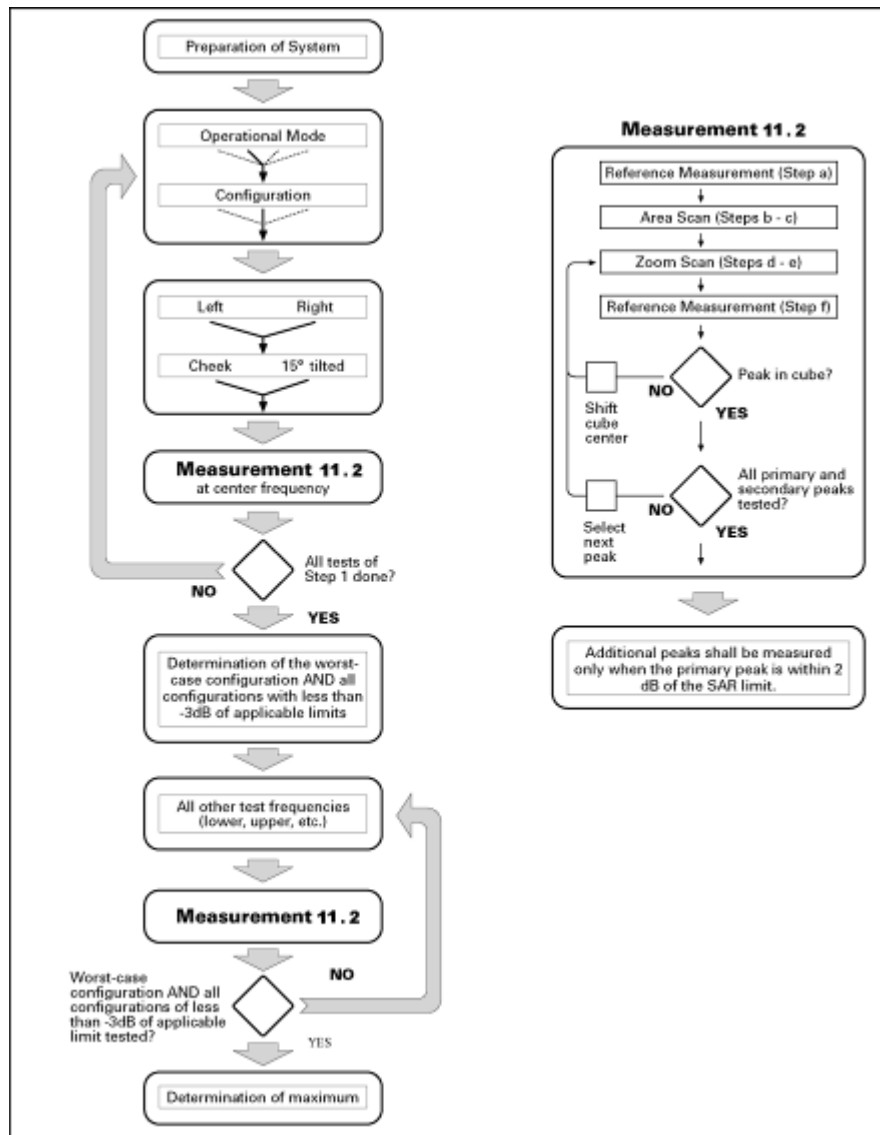

Picture 9.1 Block diagram of the tests to be performed

9.2. General Measurement Procedure

The following procedure shall be performed for each of the test conditions (see Picture 11.1) described in 11.1:

- a) Measure the local SAR at a test point within 8 mm or less in the normal direction from the inner surface of the phantom.
- b) Measure the two-dimensional SAR distribution within the phantom (area scan procedure). The boundary of the measurement area shall not be closer than 20 mm from the phantom side walls. The distance between the measurement points should enable the detection of the location of local maximum with an accuracy of better than half the linear dimension of the tissue cube after interpolation. A maximum grip spacing of 20 mm for frequencies below 3 GHz and $(60/f \text{ [GHz]})$ mm for frequencies of 3GHz and greater is recommended. The maximum distance between the geometrical centre of the probe detectors and the inner surface of the phantom shall be 5 mm for

frequencies below 3 GHz and $\delta \ln(2)/2$ mm for frequencies of 3 GHz and greater, where δ is the plane wave skin depth and $\ln(x)$ is the natural logarithm. The maximum variation of the sensor-phantom surface shall be ± 1 mm for frequencies below 3 GHz and ± 0.5 mm for frequencies of 3 GHz and greater. At all measurement points the angle of the probe with respect to the line normal to the surface should be less than 5° . If this cannot be achieved for a measurement distance to the phantom inner surface shorter than the probe diameter, additional uncertainty evaluation is needed.

c) From the scanned SAR distribution, identify the position of the maximum SAR value, in addition identify the positions of any local maxima with SAR values within 2 dB of the maximum value that are not within the zoom-scan volume; additional peaks shall be measured only when the primary peak is within 2 dB of the SAR limit. This is consistent with the 2 dB threshold already stated;

d) Measure the three-dimensional SAR distribution at the local maxima locations identified in step c). The horizontal grid step shall be $(24/f[\text{GHz}])$ mm or less but not more than 8 mm. The minimum zoom size of 30 mm by 30 mm and 30 mm for frequencies below 3 GHz. For higher frequencies, the minimum zoom size of 22 mm by 22 mm and 22 mm. The grid step in the vertical direction shall be $(8-f[\text{GHz}])$ mm or less but not more than 5 mm, if uniform spacing is used. If variable spacing is used in the vertical direction, the maximum spacing between the two closest measured points to the phantom shell shall be $(12 / f[\text{GHz}])$ mm or less but not more than 4 mm, and the spacing between farther points shall increase by an incremental factor not exceeding 1.5. When variable spacing is used, extrapolation routines shall be tested with the same spacing as used in measurements. The maximum distance between the geometrical centre of the probe detectors and the inner surface of the phantom shall be 5 mm for frequencies below 3 GHz and $\delta \ln(2)/2$ mm for frequencies of 3 GHz and greater, where δ is the plane wave skin depth and $\ln(x)$ is the natural logarithm. Separate grids shall be centered on each of the local SAR maxima found in step c). Uncertainties due to field distortion between the media boundary and the dielectric enclosure of the probe should also be minimized, which is achieved if the distance between the phantom surface and physical tip of the probe is larger than probe tip diameter. Other methods may utilize correction procedures for these boundary effects that enable high precision measurements closer than half the probe diameter. For all measurement points, the angle of the probe with respect to the flat phantom surface shall be less than 5° . If this cannot be achieved an additional uncertainty evaluation is needed.

e) Use post processing(e.g. interpolation and extrapolation) procedures to determine the local SAR values at the spatial resolution needed for mass averaging.

9.3. WCDMA Measurement Procedures for SAR

The following procedures are applicable to WCDMA handsets operating under 3GPP Release 99, Release 5 and Release 6. The default test configuration is to measure SAR with an established radio link between the DUT and a communication test set using a 12.2kbps RMC (reference measurement channel) configured in Test Loop Mode 1. SAR is selectively confirmed for other physical channel configurations (DPCCH & DPDCH_n), HSDPA and HSPA (HSUPA/HSDPA) modes according to output power, exposure conditions and device operating capabilities. Both uplink and downlink should be configured with the same RMC or AMR, when required. SAR for Release 5

HSDPA and Release 6 HSPA are measured using the applicable FRC (fixed reference channel) and E-DCH reference channel configurations. Maximum output power is verified according to applicable versions of 3GPP TS 34.121 and SAR must be measured according to these maximum output conditions. When Maximum Power Reduction (MPR) is not implemented according to Cubic Metric (CM) requirements for Release 6 HSPA, the following procedures do not apply.

For Release 5 HSDPA Data Devices:

Sub-test	β_c	β_d	β_d (SF)	β_c / β_d	β_{hs}	CM/dB
1	2/15	15/15	64	2/15	4/15	0.0
2	12/15	15/15	64	12/15	24/25	1.0
3	15/15	8/15	64	15/8	30/15	1.5
4	15/15	4/15	64	15/4	30/15	1.5

For Release 6 HSDPA Data Devices

Sub-test	β_c	β_d	β_d (SF)	β_c / β_d	β_{hs}	β_{ec}	β_{ed}	β_{ed} (SF)	β_{ed} (codes)	CM (dB)	MPR (dB)	AG Index	E-TFCI
1	11/15	15/15	64	11/15	22/15	209/225	1039/225	4	1	1.0	0.0	20	75
2	6/15	15/15	64	6/15	12/15	12/15	12/15	4	1	3.0	2.0	12	67
3	15/15	9/15	64	15/9	30/15	30/15	$\beta_{ed1}:47/15$ $\beta_{ed2}:47/15$	4	2	2.0	1.0	15	92
4	2/15	15/15	64	2/15	4/15	4/15	56/75	4	1	3.0	2.0	17	71
5	15/15	15/15	64	15/15	24/15	30/15	134/15	4	1	1.0	0.0	21	81

9.4. Bluetooth & Wi-Fi Measurement Procedures for SAR

Normal network operating configurations are not suitable for measuring the SAR of 802.11 transmitters in general. Unpredictable fluctuations in network traffic and antenna diversity conditions can introduce undesirable variations in SAR results. The SAR for these devices should be measured using chipset based test mode software to ensure that the results are consistent and reliable.

Chipset based test mode software is hardware dependent and generally varies among manufacturers. The device operating parameters established in a test mode for SAR measurements must be identical to those programmed in production units, including output power levels, amplifier gain settings and other RF performance tuning parameters. The test frequencies should correspond to actual channel frequencies defined for domestic use. SAR for devices with switched diversity should be measured with only one antenna transmitting at a time during each SAR measurement, according to a fixed modulation and data rate. The same data pattern should be used for all measurements.

9.5. Power Drift

To control the output power stability during the SAR test, DASY4 system calculates the power drift by measuring the E-field at the same location at the beginning and at the end of the measurement for each test position. These drift values can be found in Table 13.2 to Table 13.11 labeled as: (Power Drift [dB]). This ensures that the power drift during one measurement is within 5%.

10. Conducted Output Power

10.1. Manufacturing tolerance

Table 10.1: GSM Speech

GSM 835			
Channel	Channel 251	Channel 190	Channel 128
Maximum Target Value (dBm)	32.5	32.5	32.5
PCS 1900			
Channel	Channel 810	Channel 661	Channel 512
Maximum Target Value (dBm)	29.5	29.5	29.5

Table 10.2: GPRS (GMSK Modulation)

GSM 850 GPRS				
Channel		251	190	128
1 Txslots	Maximum Target Value (dBm)	32.5	32.5	32.5
2 Txslots	Maximum Target Value (dBm)	31.5	31.5	31.5
3 Txslots	Maximum Target Value (dBm)	30.5	30.5	30.5
4 Txslots	Maximum Target Value (dBm)	29.5	29.5	29.5
GSM 1900 GPRS				
Channel		810	661	512
1 Txslots	Maximum Target Value (dBm)	29.5	29.5	29.5
2 Txslots	Maximum Target Value (dBm)	28.5	28.5	28.5
3 Txslots	Maximum Target Value (dBm)	27.5	27.5	27.5
4 Txslots	Maximum Target Value (dBm)	26.5	26.5	26.5

Table 10.3: WCDMA

WCDMA Band V			
Channel	Channel 4132	Channel 4182	Channel 4233
Maximum Target Value (dBm)	22.5	22.5	22.5
WCDMA Band II			
Channel	Channel 9262	Channel 9400	Channel 9538
Maximum Target Value (dBm)	22.0	22.0	22.0

Table 10.4: HSDPA

WCDMA Band V				
Channel		4132	4182	4233
1	Maximum Target Value (dBm)	21.5	21.5	21.5
2	Maximum Target Value (dBm)	21.5	21.5	21.5
3	Maximum Target Value (dBm)	21.5	21.5	21.5
4	Maximum Target Value (dBm)	21.5	21.5	21.5
WCDMA Band II				
Channel		9262	9400	9538
1	Maximum Target Value (dBm)	21.5	21.5	21.5
2	Maximum Target Value (dBm)	21.5	21.5	21.5
3	Maximum Target Value (dBm)	21.5	21.5	21.5
4	Maximum Target Value (dBm)	21.5	21.5	21.5

Table 10.5: HSUPA

WCDMA Band V				
Channel		4132	4182	4233
1	Maximum Target Value (dBm)	21.5	21.5	21.5
2	Maximum Target Value (dBm)	21.5	21.5	21.5
3	Maximum Target Value (dBm)	21.5	21.5	21.5
4	Maximum Target Value (dBm)	21.5	21.5	21.5
5	Maximum Target Value (dBm)	21.5	21.5	21.5
WCDMA Band II				
Channel		9262	9400	9538
1	Maximum Target Value (dBm)	21.5	21.5	21.5
2	Maximum Target Value (dBm)	21.5	21.5	21.5
3	Maximum Target Value (dBm)	21.5	21.5	21.5
4	Maximum Target Value (dBm)	21.5	21.5	21.5
5	Maximum Target Value (dBm)	21.5	21.5	21.5

Table 10.6: WiFi

WiFi 802.11b			
Channel	Channel 1	Channel 6	Channel 11
Maximum Target Value (dBm)	13.0	13.0	13.0
WiFi 802.11g			
Channel	Channel 1	Channel 6	Channel 11
Maximum Target Value (dBm)	9.5	9.5	9.5
WiFi 802.11n			
Channel	Channel 1	Channel 6	Channel 11
Maximum Target Value (dBm)	9.5	9.5	9.5

Table 10.7: Bluetooth

Bluetooth			
Channel	Channel 0	Channel 39	Channel 78
Maximum Target Value (dBm)	6.0	6.0	6.0

10.2. GSM Measurement result

During the process of testing, the EUT was controlled via Agilent Digital Radio Communication tester (E5515C) to ensure the maximum power transmission and proper modulation. This result contains conducted output power for the EUT. In all cases, the measured peak output power should be greater and within 5% than EMI measurement.

Table 10.8: The conducted power measurement results for GSM850/1900

Frequency	Conducted Power (dBm)		
GSM835	Channel 251(848.8MHz)	Channel 190(836.6MHz)	Channel 128(824.2MHz)
	32.22	32.14	32.12
GSM1900	Channel 810(1909.8MHz)	Channel 661(1880MHz)	Channel 512(1850.2MHz)
	28.90	29.06	28.67

Table 10.9: The conducted power measurement results for GPRS and EGPRS

GSM 835 MHz							
GPRS (GMSK)	251	190	128	Calculation	251	190	128
1 Txslot	32.22	32.10	32.18	-9.03dB	23.19	23.07	23.15
2 Txslots	31.45	31.34	31.42	-6.02dB	25.43	25.32	25.40
3Txslots	30.32	30.22	30.28	-4.26dB	26.06	25.96	26.02
4 Txslots	29.44	29.32	29.41	-3.01dB	26.43	26.31	26.40
PCS 1900 MHz							
GPRS (GMSK)	810	661	512	Calculation	810	661	512
1 Txslot	28.96	29.04	28.64	-9.03dB	19.93	20.01	29.61
2 Txslots	28.42	28.49	28.13	-6.02dB	22.40	22.47	22.11
3Txslots	27.33	27.39	27.04	-4.26dB	23.07	23.13	22.78
4 Txslots	26.39	26.45	26.11	-3.01dB	23.38	23.44	23.10

NOTES:

1) Division Factors

To average the power, the division factor is as follows:

1TX-slot = 1 transmit time slot out of 8 time slots=> conducted power divided by (8/1) => -9.03dB

2TX-slots = 2 transmit time slots out of 8 time slots=> conducted power divided by (8/2) => -6.02dB

3TX-slots = 3 transmit time slots out of 8 time slots=> conducted power divided by (8/3) => -4.26dB

4TX-slots = 4 transmit time slots out of 8 time slots=> conducted power divided by (8/4) => -3.01dB

According to the conducted power as above, the body measurements are performed with GPRS 4Txslots for GSM850 and GSM1900.

10.3. WCDMA Measurement result

Table 10.10: The conducted power for WCDMA Band V

WCDMA Band V Result (dBm)				
Mode	ARFCN	Channel 4233 (846.6MHz)	Channel 4182 (836.4MHz)	Channel 4132 (826.4MHz)
WCDMA	RMC	22.19	22.29	22.12
HSDPA	1	21.29	21.34	21.24
	2	21.37	21.43	21.32
	3	21.34	21.39	21.29
	4	21.36	21.40	21.31
HSUPA	1	21.27	21.32	21.22
	2	21.35	21.40	21.30
	3	21.33	21.37	21.28
	4	21.34	21.39	21.29
	5	21.29	21.34	21.24

Table 10.11: The conducted power for WCDMA Band II

WCDMA Band II Result (dBm)				
Mode	ARFCN	Channel 9538 (1907.6MHz)	Channel 9400 (1880MHz)	Channel 9262 (1852.4MHz)
WCDMA	RMC	21.45	21.76	21.70
HSDPA	1	20.44	20.69	20.61
	2	20.54	20.78	20.65
	3	20.51	20.75	20.64
	4	20.52	20.78	20.66
HSUPA	1	20.44	20.65	20.58
	2	20.52	20.70	20.62
	3	20.48	20.66	20.59
	4	20.51	20.69	20.61
	5	20.47	20.65	20.57

Note: HSDPA/HSUPA body SAR are not required, because maximum average output power of each RF channel with HSDPA/HSUPA active is not 1/4 dB higher than that measured without HSDPA/HSUPA and the maximum SAR for WCDMA850 and WCDMA1900 are not above 75% of the SAR limit.

10.4. Wi-Fi and BT Measurement result

Table 10.12: The conducted power for Bluetooth

GFSK			
Channel	Ch0 (2402 MHz)	Ch39 (2441MHz)	CH78 (2480MHz)
Conducted Output Power (dBm)	4.66	5.05	5.07
π/4 DQPSK			
Channel	Ch0 (2402 MHz)	Ch39 (2441MHz)	CH78 (2480MHz)
Conducted Output Power (dBm)	3.78	4.15	4.23
8DPSK			
Channel	Ch0 (2402 MHz)	Ch39 (2441MHz)	CH78 (2480MHz)
Conducted Output Power (dBm)	3.78	4.16	4.24

NOTE:BT standalone SAR are not required, because maximum average output power is less than 10mW.

When the standalone SAR test exclusion is applied to an antenna that transmits simultaneously with other antennas, the standalone SAR must be estimated according to the following to determine simultaneous transmission SAR test exclusion:

(max. power of channel, including tune-up tolerance, mW)/(min. test separation distance, mm) • [√ f(GHz)/x] W/kg for test separation distances ≤ 50 mm;
 where x = 7.5 for 1-g SAR, and x = 18.75 for 10-g SAR.

SAR head value of BT is 0.167W/Kg. SAR body value of BT is 0.084W/Kg.

Table 10.13: The Peak conducted power for Wifi

WifiResults (dBm)								
802.11b (dBm)								
Channel\data rate	1Mbps	2Mbps	5.5Mbps	11Mbps				
1	14.88	14.89	14.53	15.08				
6	14.31	14.23	14.12	14.41				
11	14.11	14.21	14.26	14.39				
802.11g (dBm)								
Channel\data rate	6Mbps	9Mbps	12Mbps	18Mbps	24Mbps	36Mbps	48Mbps	54Mbps
1	17.48	17.22	17.86	16.88	17.94	18.25	17.66	18.05
6	17.18	16.49	16.85	16.92	17.26	17.41	17.15	17.08
11	16.90	17.24	17.05	16.84	17.11	17.55	17.35	17.48
20M 802.11n (dBm)								
Channel\data rate	MCS0	MCS1	MCS2	MCS3	MCS4	MCS5	MCS6	MCS7
1	13.47	13.34	12.96	13.42	18.01	18.10	17.64	17.57
6	13.12	13.38	12.24	13.31	17.05	17.14	16.89	17.59
11	13.26	13.12	12.75	13.65	17.42	17.58	17.49	17.45

Table 10.14: The average conducted power for Wifi

WifiResults (dBm)								
802.11b (dBm)								
Channel\data rate	1Mbps	2Mbps	5.5Mbps	11Mbps				
1	12.23	12.08	12.73	12.96				
6	12.04	11.98	11.85	12.12				
11	11.62	11.81	11.70	11.93				
802.11g (dBm)								
Channel\data rate	6Mbps	9Mbps	12Mbps	18Mbps	24Mbps	36Mbps	48Mbps	54Mbps
1	7.97	8.31	8.16	7.52	8.19	9.06	8.41	7.81
6	7.35	7.41	8.15	7.51	7.89	8.32	8.21	7.32
11	8.04	7.52	7.07	8.01	7.90	8.10	8.04	7.64
20M 802.11n (dBm)								
Channel\data rate	MCS0	MCS1	MCS2	MCS3	MCS4	MCS5	MCS6	MCS7
1	8.87	8.57	8.21	8.59	8.35	9.11	8.67	8.89
6	8.24	8.36	8.13	8.08	7.75	8.52	7.78	7.98
11	8.10	8.17	8.08	8.12	8.09	8.36	8.00	7.54

SAR is not required for 802.11g/n channels if the output power is less than 0.25dB higher than that measured on the corresponding 802.11b channels, and for each frequency band, testing at higher data rates and higher order modulations is not required when the maximum average output power for each of these configurations is less than 0.25dB higher than those measured at the lowest data rate. According to the above conducted power, the EUT should be tested for “802.11b, 11Mbps, channel 1”.

11. Simultaneous TX SAR Considerations

11.1. Introduction

The following procedures adopted from “FCC SAR Considerations for Cell Phones with Multiple Transmitters” are applicable to handsets with built-in unlicensed transmitters such as 802.11 a/b/g and Bluetooth devices which may simultaneously transmit with the licensed transmitter. For this device, the BT and Wi-Fi can transmit simultaneous with other transmitters.

11.2. Transmit Antenna Separation Distances



Picture 12.1 Antenna Locations

11.3. Standalone SAR Test Exclusion Considerations

Standalone 1-g head or body SAR evaluation by measurement or numerical simulation is not required when the corresponding SAR Exclusion Threshold condition, listed below, is satisfied. The 1-g SAR test exclusion threshold for 100 MHz to 6 GHz at test separation distances ≤ 50 mm are determined by:

$$\left[\frac{\text{(max. power of channel, including tune-up tolerance, mW)}}{\text{(min. test separation distance, mm)}} \right] \cdot \sqrt{f(\text{GHz})} \leq 3.0$$
 for 1-g SAR, where

- $f(\text{GHz})$ is the RF channel transmit frequency in GHz
- Power and distance are rounded to the nearest mW and mm before calculation
- The result is rounded to one decimal place for comparison

According to the KDB447498 appendix A, the SAR test exclusion threshold for 2450MHz at 5mm test separation distances is 10mW.

$$\frac{\text{(max. power of channel, including tune-up tolerance, mW)}}{\text{(min. test separation distance, mm)}} \cdot \sqrt{\text{Frequency (GHz)}} \leq 3.0$$

Based on the above equation, Bluetooth SAR was not required:

Evaluation=1.254 < 3.0

Based on the above equation, WiFi SAR was required:

Evaluation=6.245 > 3.0

12. Evaluation of Simultaneous

Table 12.1: Summary of Transmitters

Band/Mode	Frequency (GHz)	SAR test exclusion threshold(mW)	RF output power (mW)
Bluetooth	2.480	10	3.981
2.4GHz WLAN 802.11 b/g	2.45	10	19.953

Table12.2 Simultaneous transmission SAR

Simultaneous Transmission SAR(W/Kg)										
Test Position			GSM 850	GSM 1900	WCDMA B V	WCDMA B II	WCDMA B IV	WIFI	BT note	SUM
Head	Left	Cheek	0.582	0.476	0.315	0.558	0.255	0.329	0.167	0.911
		Tilt 15°	0.240	0.086	0.147	0.137	0.088	0.262	0.167	0.502
	Right	Cheek	0.313	0.395	0.186	0.460	0.422	0.158	0.167	0.627
		Tilt 15°	0.247	0.083	0.153	0.110	0.104	0.143	0.167	0.414
Body	Phantom Side		0.519	0.499	0.329	0.898	0.671	0.286	0.084	1.184
	Ground Side		0.780	0.422	0.527	0.762	1.127	0.452	0.084	1.579
	Left Side		0.511	0.245	0.322	0.238	0.211	0.021	0.084	0.595
	Right Side		0.380	0.015	0.268	0.141	N/A	0.308	0.084	0.688
	Top Side		N/A	N/A	N/A	N/A	N/A	0.086	0.084	N/A
	Bottom Side		0.131	0.684	0.110	0.496	0.953	0.029	0.084	1.037

According to the conducted power measurement result, we can draw the conclusion that: stand-alone SAR for WiFi should be performed. Then, simultaneous transmission SAR for WiFi/BT is considered with measurement results of GSM/WCDMA and WiFi/BT. According to the above table, the sum of reported SAR values for GSM and WiFi<1.6W/kg. So the simultaneous transmission SAR is not required for WiFi/BT transmitter.

NOTE: Band IV test results are obtained from the TA reports.

13. SAR Test Result

Table 13.1: Duty Cycle

Duty Cycle	
Speech for GSM835/1900	1:8.3
GPRS for GSM835/1900	1:2
WCDMA850/1900 and WiFi	1:1

Table 13.2: SAR Values(GSM 835 MHz Band - Head)

Frequency		Side	Test Position	Maximum allowed Power (dBm)	Measured average power (dBm)	Scaling factor	Measured SAR(1g) (W/kg)	Reported SAR(1g)(W/kg)	Power Drift (dB)
MHz	Ch.								
836.6	190	Left	Touch	32.5	32.14	1.086	0.325	0.353	-0.11
836.6	190	Left	Tilt	32.5	32.14	1.086	0.221	0.240	0.09
836.6	190	Right	Touch	32.5	32.14	1.086	0.288	0.313	0.17
836.6	190	Right	Tilt	32.5	32.14	1.086	0.227	0.247	0.13
824.2	128	Left	Touch	32.5	32.12	1.091	0.207	0.226	-0.14
848.8	251	Left	Touch	32.5	32.22	1.067	0.546	0.582	0.18
SIM 2									
848.8	251	Left	Touch	32.5	32.22	1.067	0.544	0.580	0.12

Table 13.3: SAR Values (GSM 835 MHz Band-Body)

Frequency		Mode (number of timeslots)	Test Position	Maximum allowed Power (dBm)	Measured average power (dBm)	Scaling factor	Measured SAR(1g) (W/kg)	Reported SAR(1g)(W/kg)	Power Drift (dB)
MHz	Ch.								
836.6	190	GPRS (4)	Phantom	29.5	29.32	1.042	0.498	0.519	-0.05
836.6	190	GPRS (4)	Ground	29.5	29.32	1.042	0.561	0.585	-0.01
836.6	190	GPRS (4)	Left	29.5	29.32	1.042	0.490	0.511	0.03
836.6	190	GPRS (4)	Right	29.5	29.32	1.042	0.365	0.380	0.07
836.6	190	GPRS (4)	Bottom	29.5	29.32	1.042	0.126	0.131	-0.18
824.2	128	GPRS (4)	Ground	29.5	29.41	1.021	0.397	0.405	-0.02
848.8	251	GPRS (4)	Ground	29.5	29.44	1.014	0.769	0.780	-0.08
848.8	251	Speech	Ground (Headset)	32.5	32.22	1.067	0.622	0.663	-0.05
SIM 2									
848.8	251	GPRS (4)	Ground	29.5	29.44	1.014	0.698	0.708	-0.04

Note: The distance between the EUT and the phantom bottom is 10mm.

Table 13.4: SAR Values(GSM 1900 MHz Band - Head)

Frequency		Side	Test Position	Maximum allowed Power (dBm)	Measured average power (dBm)	Scaling factor	Measured SAR(1g) (W/kg)	Reported SAR(1g)(W/kg)	Power Drift (dB)
MHz	Ch.								
1880	661	Left	Touch	29.5	29.06	1.107	0.379	0.419	-0.15
1880	661	Left	Tilt	29.5	29.06	1.107	0.078	0.086	0.05
1880	661	Right	Touch	29.5	29.06	1.107	0.357	0.395	0.07
1880	661	Right	Tilt	29.5	29.06	1.107	0.075	0.083	0.07
1909.8	810	Left	Touch	29.5	28.90	1.148	0.376	0.432	0.17
1850.2	512	Left	Touch	29.5	28.67	1.211	0.393	0.476	0.14
SIM 2									
1850.2	512	Right	Touch	29.5	28.67	1.211	0.366	0.443	0.14

Table 13.5: SAR Values (GSM 1900 MHz Band–Body)

Frequency		Mode (number of timeslots)	Test Position	Maximum allowed Power (dBm)	Measured average power (dBm)	Scaling factor	Measured SAR(1g) (W/kg)	Reported SAR(1g)(W/kg)	Power Drift (dB)
MHz	Ch.								
1880	661	GPRS (4)	Phantom	26.5	26.45	1.012	0.493	0.499	-0.16
1880	661	GPRS (4)	Ground	26.5	26.45	1.012	0.417	0.422	0.02
1880	661	GPRS (4)	Left	26.5	26.45	1.012	0.242	0.245	0.11
1880	661	GPRS (4)	Right	26.5	26.45	1.012	0.015	0.015	0.01
1880	661	GPRS (4)	Bottom	26.5	26.45	1.012	0.570	0.577	-0.02
1909.8	810	GPRS (4)	Bottom	26.5	26.39	1.026	0.667	0.684	0.05
1850.2	512	GPRS (4)	Bottom	26.5	26.11	1.094	0.500	0.547	0.07
1909.8	810	Speech	Bottom (Headset)	29.5	28.90	1.148	0.375	0.431	-0.18
SIM 2									
1909.8	810	GPRS (4)	Bottom	26.5	26.39	1.026	0.614	0.630	0.09

Note: The distance between the EUT and the phantom bottom is 10mm.

Table 13.6: SAR Values(WCDMA 850 MHz Band - Head)

Frequency		Side	Test Position	Maximum allowed Power (dBm)	Measured average power (dBm)	Scaling factor	Measured SAR(1g) (W/kg)	Reported SAR(1g)(W/kg)	Power Drift (dB)
MHz	Ch.								
836.4	4182	Left	Touch	22.5	22.29	1.050	0.208	0.218	0.11
836.4	4182	Left	Tilt	22.5	22.29	1.050	0.140	0.147	0.06
836.4	4182	Right	Touch	22.5	22.29	1.050	0.177	0.186	0.01
836.4	4182	Right	Tilt	22.5	22.29	1.050	0.146	0.153	0.17
846.6	4233	Left	Touch	22.5	22.19	1.074	0.293	0.315	0.13
826.4	4132	Left	Touch	22.5	22.12	1.091	0.199	0.217	0.09

Table 13.7: SAR Values (WCDMA 850 MHz Band–Body)

Frequency		Test Position	Maximum allowed Power (dBm)	Measured average power (dBm)	Scaling factor	Measured SAR(1g) (W/kg)	Reported SAR(1g)(W/kg)	Power Drift (dB)
MHz	Ch.							
836.4	4182	Phantom	22.5	22.29	1.050	0.313	0.329	-0.00
836.4	4182	Ground	22.5	22.29	1.050	0.375	0.394	0.02
836.4	4182	Left	22.5	22.29	1.050	0.307	0.322	0.05
836.4	4182	Right	22.5	22.29	1.050	0.255	0.268	-0.00
836.4	4182	Bottom	22.5	22.29	1.050	0.105	0.110	-0.05
846.6	4233	Ground	22.5	22.19	1.074	0.491	0.527	-0.01
826.4	4132	Ground	22.5	22.12	1.091	0.363	0.396	-0.00
846.6	4233	Ground (Headset)	22.5	22.19	1.074	0.323	0.347	0.01

Note: The distance between the EUT and the phantom bottom is 10mm

Table 13.8: SAR Values(WCDMA1900 MHz Band - Head)

Frequency		Side	Test Position	Maximum allowed Power (dBm)	Measured average power (dBm)	Scaling factor	Measured SAR(1g) (W/kg)	Reported SAR(1g)(W/kg)	Power Drift (dB)
MHz	Ch.								
1880	9400	Left	Touch	22.0	21.76	1.057	0.528	0.558	0.07
1880	9400	Left	Tilt	22.0	21.76	1.057	0.130	0.137	0.07
1880	9400	Right	Touch	22.0	21.76	1.057	0.435	0.460	0.08
1880	9400	Right	Tilt	22.0	21.76	1.057	0.104	0.110	0.03
1907.6	9538	Left	Touch	22.0	21.45	1.135	0.486	0.552	0.12
1852.4	9262	Left	Touch	22.0	22.70	1.072	0.498	0.534	0.17

Table 13.9: SAR Values (WCDMA1900 MHz Band–Body)

Frequency		Test Position	Maximum allowed Power (dBm)	Measured average power (dBm)	Scaling factor	Measured SAR(1g) (W/kg)	Reported SAR(1g)(W/kg)	Power Drift (dB)
MHz	Ch.							
1880	9400	Phantom	22.0	21.76	1.057	0.847	0.895	0.11
1880	9400	Ground	22.0	21.76	1.057	0.721	0.762	0.13
1880	9400	Left	22.0	21.76	1.057	0.225	0.238	0.14
1880	9400	Right	22.0	21.76	1.057	0.133	0.141	-0.08
1880	9400	Bottom	22.0	21.76	1.057	0.469	0.496	-0.06
1907.6	9538	Phantom	22.0	21.45	1.135	0.786	0.892	0.14
1852.4	9262	Phantom	22.0	22.70	1.072	0.783	0.839	0.17
1907.6	9538	Ground	22.0	21.45	1.135	0.676	0.767	0.07
1852.4	9262	Ground	22.0	22.70	1.072	0.659	0.706	0.05
1880	9400	Phantom (Headset)	22.0	21.76	1.057	0.737	0.779	0.15
1852.4	9262	Phantom (Headset)	22.0	22.70	1.072	0.677	0.725	0.15
1907.6	9538	Phantom (Headset)	22.0	21.45	1.135	0.688	0.781	0.16

Note: The distance between the EUT and the phantom bottom is 10mm.

Table 13.10: SAR Values (Wi-Fi 802.11b - Head)

Frequency		Side	Test Position	Maximum allowed Power (dBm)	Measured average power (dBm)	Scaling factor	Measured SAR(1g) (W/kg)	Reported SAR(1g)(W/kg)	Power Drift (dB)
MHz	Ch.								
2412	1	Left	Touch	13.0	12.96	1.009	0.326	0.329	0.12
2412	1	Left	Tilt	13.0	12.96	1.009	0.260	0.262	0.13
2412	1	Right	Touch	13.0	12.96	1.009	0.157	0.158	-0.06
2412	1	Right	Tilt	13.0	12.96	1.009	0.142	0.143	0.16

Table 13.11: SAR Values (Wi-Fi 802.11b - Body)

Frequency		Test Position	Maximum allowed Power (dBm)	Measured average power (dBm)	Scaling factor	Measured SAR(1g) (W/kg)	Reported SAR(1g)(W/kg)	Power Drift (dB)
MHz	Ch.							
2412	1	Phantom	13.0	12.96	1.009	0.283	0.286	-0.03
2412	1	Ground	13.0	12.96	1.009	0.448	0.452	0.08
2412	1	Left	13.0	12.96	1.009	0.021	0.021	0.10
2412	1	Right	13.0	12.96	1.009	0.305	0.308	0.11
2412	1	Top	13.0	12.96	1.009	0.085	0.086	0.07
2412	1	Bottom	13.0	12.96	1.009	0.029	0.029	-0.14

Note: The distance between the EUT and the phantom bottom is 10mm.

14. SAR Measurement Variability

SAR measurement variability must be assessed for each frequency band, which is determined by the SARprobe calibration point and tissue-equivalent medium used for the device measurements. When both head and body tissue-equivalent media are required for SAR measurements in a frequency band, the variability measurement procedures should be applied to the tissue medium with the highest measured SAR, using the highest measured SAR configuration for that tissue-equivalent medium.

The following procedures are applied to determine if repeated measurements are required.

- 1) Repeated measurement is not required when the original highest measured SAR is < 0.80 W/kg; steps 2) through 4) do not apply.
- 2) When the original highest measured SAR is ≥ 0.80 W/kg, repeat that measurement once.
- 3) Perform a second repeated measurement only if the ratio of largest to smallest SAR for the original and first repeated measurements is > 1.20 or when the original or repeated measurement is ≥ 1.45 W/kg (~ 10% from the 1-g SAR limit).
- 4) Perform a third repeated measurement only if the original, first or second repeated measurement is ≥ 1.5 W/kg and the ratio of largest to smallest SAR for the original, first and second repeated measurements is > 1.20 .

Table 14.1: SAR Measurement Variability for Head Value (1g)

Frequency		Side	Test Position	Original SAR (W/kg)	First Repeated SAR (W/kg)	Reported SAR(1g)(W/kg)	The Ratio
MHz	Ch.						
N/A	N/A	N/A	N/A	N/A	N/A	N/A	N/A
SIM 2							
N/A	N/A	N/A	N/A	N/A	N/A	N/A	N/A

Note: According to the KDB 865664 D01 repeated measurement is not required when the original highest measured SAR is < 0.8 W/kg.

Table 14.2: SAR Measurement Variability for Body Value (1g)

Frequency		Mode(number of timeslots)	Test Position	Spacing (mm)	Original SAR (W/kg)	First Repeated SAR (W/kg)	Reported SAR(1g)(W/kg)	The Ratio
MHz	Ch.							
1880	9400	Band 2	Phantom	10	0.847	0.850	0.898	1.00
1907.6	9538	Band 2	Phantom	10	0.786	0.786	0.892	1.00
1852.4	9262	Band 2	Phantom	10	0.783	0.783	0.839	1.00
SIM 2								
N/A	N/A	N/A	N/A	N/A	N/A	N/A	N/A	N/A

Note: According to the KDB 865664 D01 repeated measurement is not required when the original highest measured SAR is < 0.8 W/kg.

15. Measurement Uncertainty

Error Description	Unc. value, ±%	Prob. Dist.	Div.	c _i 1g	c _i 10g	Std. Unc. ±%, 1g	Std. Unc. ±%, 10g	V _i V _{eff}
Measurement System								
Probe Calibration	6.0	N	1	1	1	6.0	6.0	∞
Axial Isotropy	0.5	R	$\sqrt{3}$	0.7	0.7	0.2	0.2	∞
Hemispherical Isotropy	2.6	R	$\sqrt{3}$	0.7	0.7	1.1	1.1	∞
Boundary Effects	0.8	R	$\sqrt{3}$	1	1	0.5	0.5	∞
Linearity	0.6	R	$\sqrt{3}$	1	1	0.3	0.3	∞
System Detection Limits	1.0	R	$\sqrt{3}$	1	1	0.6	0.6	∞
Readout Electronics	0.7	N	1	1	1	0.7	0.7	∞
Response Time	0	R	$\sqrt{3}$	1	1	0	0	∞
Integration Time	2.6	R	$\sqrt{3}$	1	1	1.5	1.5	∞
RF Ambient Noise	3.0	R	$\sqrt{3}$	1	1	1.7	1.7	∞
RF Ambient Reflections	3.0	R	$\sqrt{3}$	1	1	1.7	1.7	∞
Probe Positioner	1.5	R	$\sqrt{3}$	1	1	0.9	0.9	∞
Probe Positioning	2.9	R	$\sqrt{3}$	1	1	1.7	1.7	∞
Max. SAR Eval.	1.0	R	$\sqrt{3}$	1	1	0.6	0.6	∞
Test Sample Related								
Device Positioning	2.9	N	1	1	1	2.9	2.9	145
Device Holder	3.6	N	1	1	1	3.6	3.6	5
Dipole								
Power Drift	5.0	R	$\sqrt{3}$	1	1	2.9	2.9	∞
Dipole Positioning	2.0	N	1	1	1	2.0	2.0	∞
Dipole Input Power	5.0	N	1	1	1	5.0	5.0	∞
Phantom and Setup								
Phantom Uncertainty	4.0	R	$\sqrt{3}$	1	1	2.3	2.3	∞
Liquid Conductivity (target)	5.0	R	$\sqrt{3}$	0.64	0.43	1.8	1.2	∞
Liquid Conductivity (meas.)	2.5	N	1	0.64	0.43	1.6	1.1	∞
Liquid Permittivity (target)	5.0	R	$\sqrt{3}$	0.6	0.49	1.7	1.4	∞
Liquid Permittivity (meas.)	2.5	N	1	0.6	0.49	1.5	1.2	∞
Combined Std Uncertainty								
						±11.2%	±10.9%	387
Expanded Std Uncertainty								
						±22.4%	±21.8%	

16. Main Test Instrument

Table 16.1: List of Main Instruments

No.	Name	Type	Serial Number	Calibration Date	Valid Period
01	Network analyzer	N5242A	MY51221755	Jan 8, 2014	One year
02	Power meter	NRVD	102257	Aug 31, 2013	One year
03	Power sensor	NRV-Z5	100644,100241		
04	Signal Generator	E4438C	MY49072044	Jan 8, 2014	One Year
05	Amplifier	NTWPA-0086010F	12023024	No Calibration Requested	
06	Coupler	778D	MY48220551	Aug 23, 2013	One year
07	BTS	E5515C	MY50266468	Jan 8, 2014	One year
08	E-field Probe	ES3DV3	3252	Aug 5, 2013	One year
09	E-field Probe	EX3DV4	3754	Aug 8, 2013	One year
10	DAE	SPEAG DAE4	1244	Jul 9, 2013	One year
11	Dipole Validation Kit	SPEAG D835V2	4d112	Oct 9, 2013	One year
12	Dipole Validation Kit	SPEAG D1900V2	5d134	Jul 12, 2013	One year
13	Dipole Validation Kit	SPEAG D2450V2	858	Jul 13, 2013	One year

ANNEX A. GRAPH RESULTS

GSM 850MHz Left Cheek Middle

Date/Time: 2014/4/25

Electronics: DAE4 Sn1244

Medium: Head 850MHz

Medium parameters used: $f = 837 \text{ MHz}$; $\sigma = 0.919 \text{ S/m}$; $\epsilon_r = 40.986$; $\rho = 1000 \text{ kg/m}^3$

Ambient Temperature: 22.5°C Liquid Temperature: 22.5°C

Communication System: GSM 850MHz; Frequency: 836.6 MHz ; Duty Cycle: 1:8.3

Probe: ES3DV3 - SN3252ConvF(6.1, 6.1, 6.1); Calibrated: 8/5/2013

GSM 850MHz Left Cheek Middle/Area Scan (11x61x1):

Measurement grid: $dx=10 \text{ mm}$, $dy=10 \text{ mm}$

Maximum value of SAR (Measurement) = 0.340 W/kg

GSM 850MHz Left Cheek Middle/Zoom Scan (7x7x7)/Cube 0:

Measurement grid: $dx=5\text{mm}$, $dy=5\text{mm}$, $dz=5\text{mm}$

Reference Value = 7.393 V/m ; Power Drift = -0.11 dB

Peak SAR (extrapolated) = 0.406 W/kg

SAR(1 g) = 0.325 W/kg ; SAR(10 g) = 0.245 W/kg

Maximum value of SAR (measured) = 0.341 W/kg

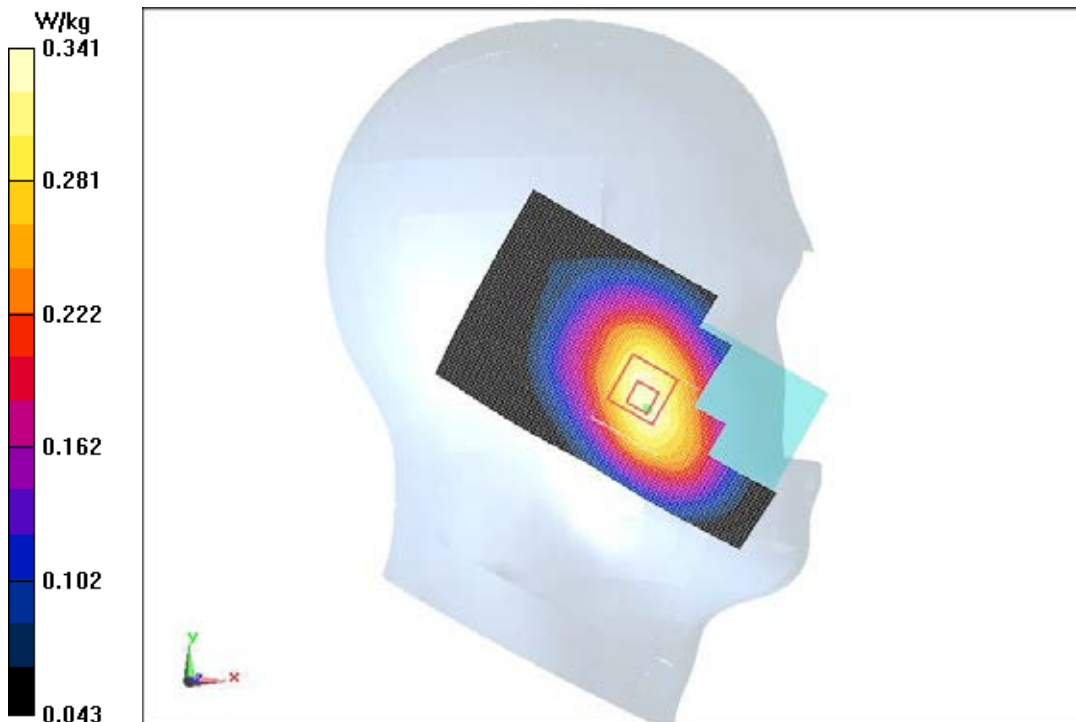

GSM 850MHz Left Tilt Middle

Date/Time: 2014/4/25

Electronics: DAE4 Sn1244

Medium: Head 850MHz

Medium parameters used: $f = 837 \text{ MHz}$; $\sigma = 0.919 \text{ S/m}$; $\epsilon_r = 40.986$; $\rho = 1000 \text{ kg/m}^3$

Ambient Temperature: 22.5°C Liquid Temperature: 22.5°C

Communication System: GSM 850MHz; Frequency: 836.6 MHz; Duty Cycle: 1:8.3

Probe: ES3DV3 - SN3252ConvF(6.1, 6.1, 6.1); Calibrated: 8/5/2013

GSM 850MHz Left Tilt Middle/Area Scan (111x61x1):

Measurement grid: $dx=10 \text{ mm}$, $dy=10 \text{ mm}$

Maximum value of SAR (Measurement) = 0.230 W/kg

GSM 850MHz Left Tilt Middle/Zoom Scan (7x7x7)/Cube 0:

Measurement grid: $dx=5\text{mm}$, $dy=5\text{mm}$, $dz=5\text{mm}$

Reference Value = 10.945 V/m; Power Drift = 0.09 dB

Peak SAR (extrapolated) = 0.255 W/kg

SAR(1 g) = 0.221 W/kg; SAR(10 g) = 0.174 W/kg

Maximum value of SAR (measured) = 0.232 W/kg

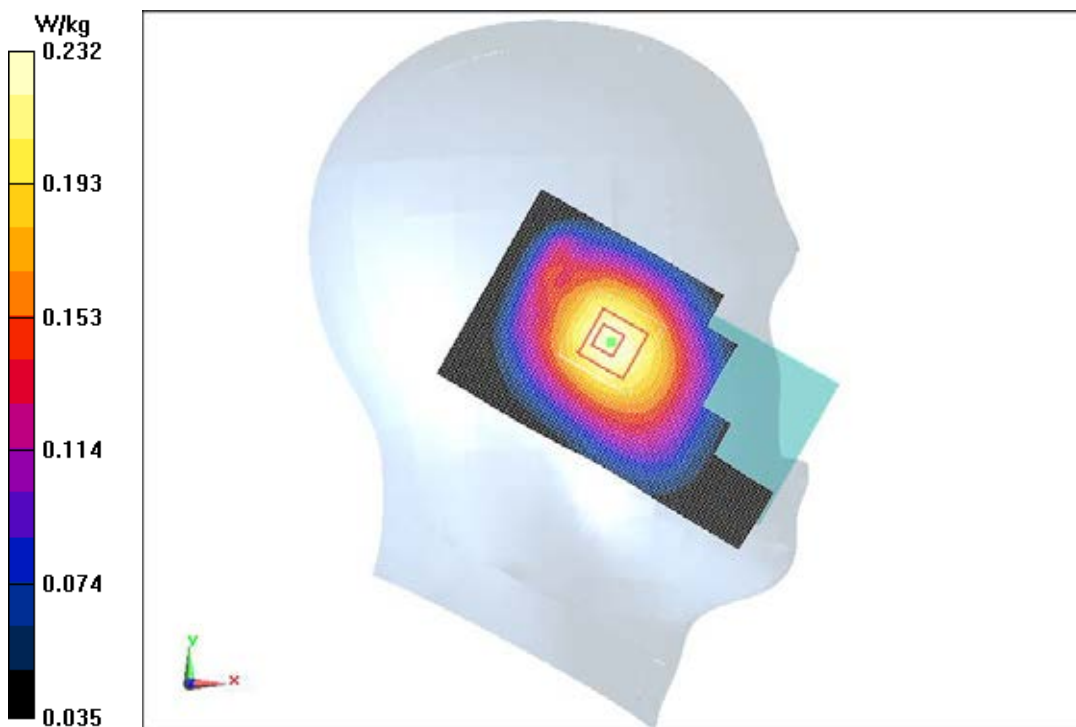

GSM 850MHz Right Cheek Middle

Date/Time: 2014/4/25

Electronics: DAE4 Sn1244

Medium: Head 850MHz

Medium parameters used: $f = 837 \text{ MHz}$; $\sigma = 0.919 \text{ S/m}$; $\epsilon_r = 40.986$; $\rho = 1000 \text{ kg/m}^3$

Ambient Temperature: 22.5°C Liquid Temperature: 22.5°C

Communication System: GSM 850MHz; Frequency: 836.6 MHz; Duty Cycle: 1:8.3

Probe: ES3DV3 - SN3252ConvF(6.1, 6.1, 6.1); Calibrated: 8/5/2013

GSM 850MHz Right Cheek Middle/Area Scan (111x61x1):

Measurement grid: $dx=10 \text{ mm}$, $dy=10 \text{ mm}$

Maximum value of SAR (Measurement) = 0.303 W/kg

GSM 850MHz Right Cheek Middle/Zoom Scan (7x7x7)/Cube 0:

Measurement grid: $dx=5\text{mm}$, $dy=5\text{mm}$, $dz=5\text{mm}$

Reference Value = 6.760 V/m; Power Drift = 0.17 dB

Peak SAR (extrapolated) = 0.345 W/kg

SAR(1 g) = 0.288 W/kg; SAR(10 g) = 0.220 W/kg

Maximum value of SAR (measured) = 0.302 W/kg

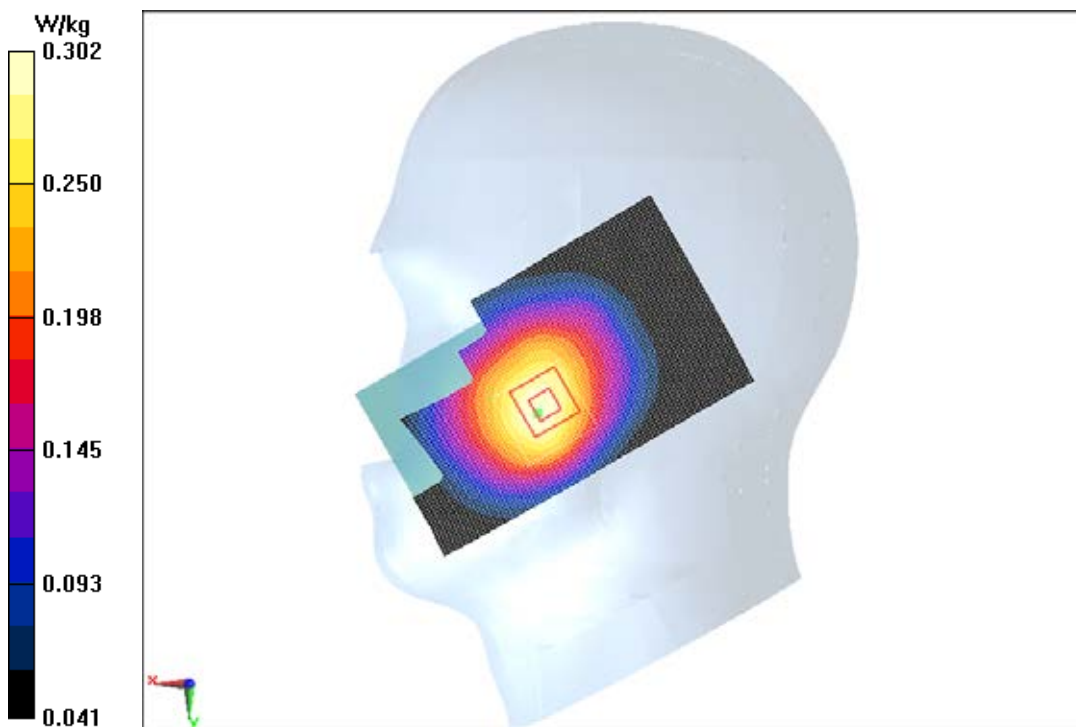

GSM 850MHz Right Tilt Middle

Date/Time: 2014/4/25

Electronics: DAE4 Sn1244

Medium: Head 850MHz

Medium parameters used: $f = 837 \text{ MHz}$; $\sigma = 0.919 \text{ S/m}$; $\epsilon_r = 40.986$; $\rho = 1000 \text{ kg/m}^3$

Ambient Temperature: 22.5°C Liquid Temperature: 22.5°C

Communication System: GSM 850MHz; Frequency: 836.6 MHz; Duty Cycle: 1:8.3

Probe: ES3DV3 - SN3252ConvF(6.1, 6.1, 6.1); Calibrated: 8/5/2013

GSM 850MHz Right Tilt Middle/Area Scan (111x61x1):

Measurement grid: $dx=10 \text{ mm}$, $dy=10 \text{ mm}$

Maximum value of SAR (Measurement) = 0.234 W/kg

GSM 850MHz Right Tilt Middle/Zoom Scan (7x7x7)/Cube 0:

Measurement grid: $dx=5\text{mm}$, $dy=5\text{mm}$, $dz=5\text{mm}$

Reference Value = 11.682 V/m; Power Drift = 0.13 dB

Peak SAR (extrapolated) = 0.262 W/kg

SAR(1 g) = 0.227 W/kg; SAR(10 g) = 0.177 W/kg

Maximum value of SAR (measured) = 0.236 W/kg

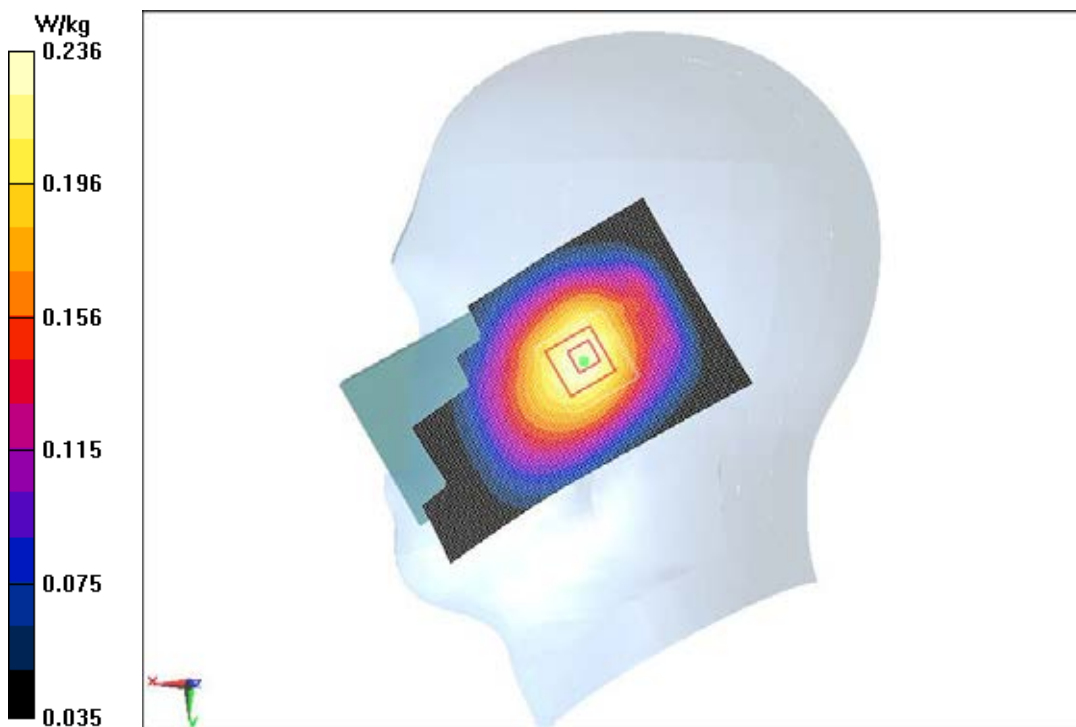

GSM 850MHz Left Cheek Low

Date/Time: 2014/4/25

Electronics: DAE4 Sn1244

Medium: Head 850MHz

Medium parameters used (interpolated): $f = 824.2$ MHz; $\sigma = 0.91$ S/m; $\epsilon_r = 41.32$; $\rho = 1000$ kg/m³

Ambient Temperature: 22.5°C Liquid Temperature: 22.5°C

Communication System: GSM 850MHz; Frequency: 824.2 MHz; Duty Cycle: 1:8.3

Probe: ES3DV3 - SN3252ConvF(6.1, 6.1, 6.1); Calibrated: 8/5/2013

GSM 850MHz Left Cheek Low/Area Scan (111x61x1):

Measurement grid: dx=10 mm, dy=10 mm

Maximum value of SAR (Measurement) = 0.219 W/kg

GSM 850MHz Left Cheek Low/Zoom Scan (7x7x7)/Cube 0:

Measurement grid: dx=5mm, dy=5mm, dz=5mm

Reference Value = 5.772 V/m; Power Drift = -0.14 dB

Peak SAR (extrapolated) = 0.261 W/kg

SAR(1 g) = 0.207 W/kg; SAR(10 g) = 0.153 W/kg

Maximum of SAR (measured) = 0.217 W/kg

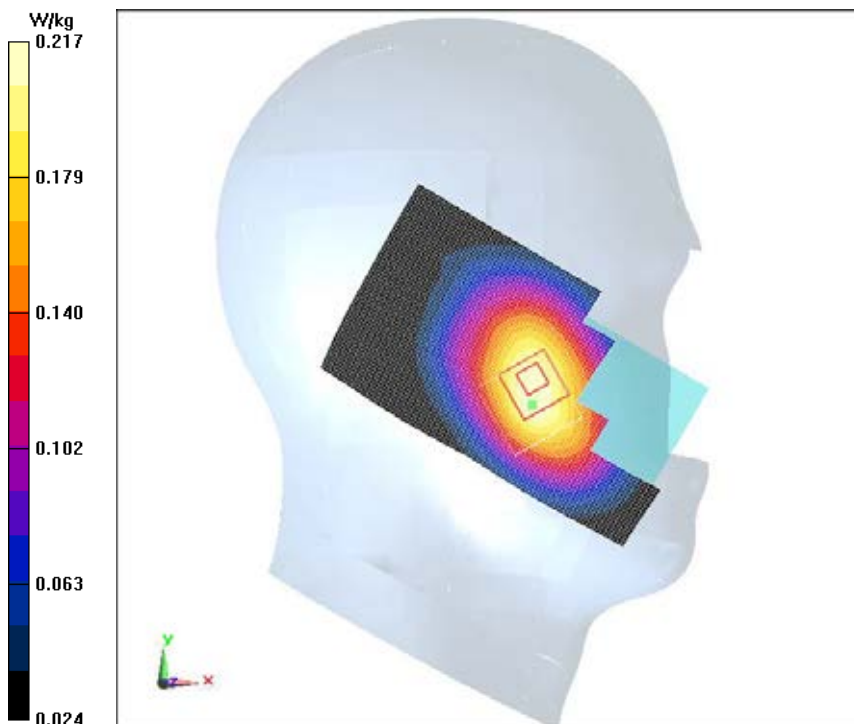

GSM 850MHz Left Cheek High

Date/Time: 2014/4/25

Electronics: DAE4 Sn1244

Medium: Head 850MHz

Medium parameters used: $f = 849 \text{ MHz}$; $\sigma = 0.929 \text{ S/m}$; $\epsilon_r = 40.788$; $\rho = 1000 \text{ kg/m}^3$

Ambient Temperature: 22.5°C Liquid Temperature: 22.5°C

Communication System: GSM 850MHz; Frequency: 848.8 MHz; Duty Cycle: 1:8.3

Probe: ES3DV3 - SN3252ConvF(6.1, 6.1, 6.1); Calibrated: 8/5/2013

GSM 850MHz Left Cheek High/Area Scan (111x61x1):

Measurement grid: $dx=10 \text{ mm}$, $dy=10 \text{ mm}$

Maximum value of SAR (Measurement) = 0.581 W/kg

GSM 850MHz Left Cheek High/Zoom Scan (7x7x7)/Cube 0:

Measurement grid: $dx=5\text{mm}$, $dy=5\text{mm}$, $dz=5\text{mm}$

Reference Value = 8.265 V/m; Power Drift = 0.18 dB

Peak SAR (extrapolated) = 0.694 W/kg

SAR(1 g) = 0.546 W/kg; SAR(10 g) = 0.403 W/kg

Maximum of SAR (measured) = 0.570 W/kg

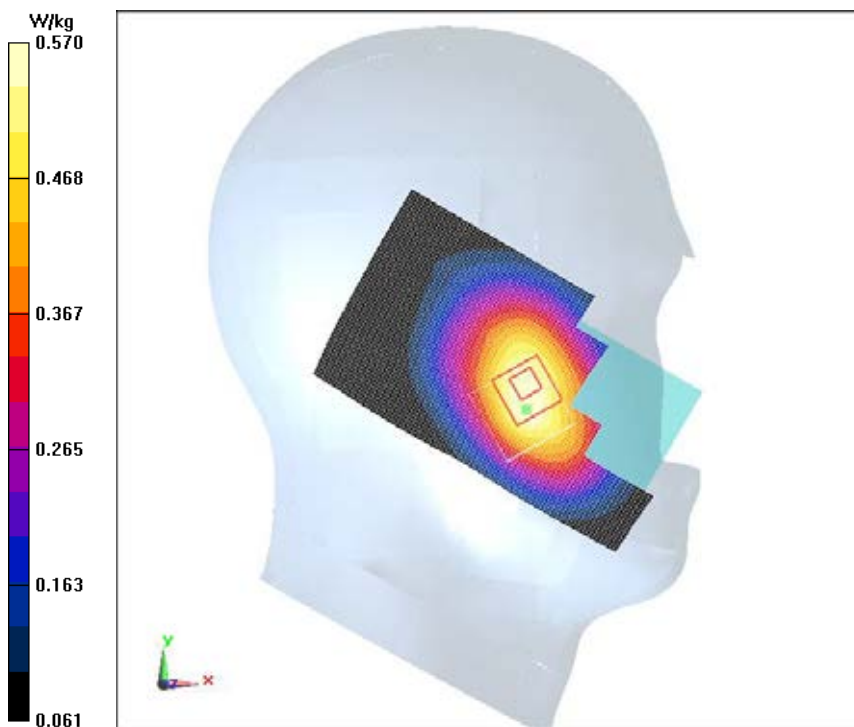

GSM 850MHz Left Cheek High SIM2

Date/Time: 2014/4/25

Electronics: DAE4 Sn1244

Medium: Head 850MHz

Medium parameters used: $f = 849 \text{ MHz}$; $\sigma = 0.929 \text{ S/m}$; $\epsilon_r = 40.788$; $\rho = 1000 \text{ kg/m}^3$

Ambient Temperature: 22.5°C Liquid Temperature: 22.5°C

Communication System: GSM 850MHz; Frequency: 848.8 MHz ; Duty Cycle: 1:8.3

Probe: ES3DV3 - SN3252ConvF(6.1, 6.1, 6.1); Calibrated: 8/5/2013

GSM 850MHz Left Cheek High SIM2/Area Scan (11x61x1):

Measurement grid: $dx=10 \text{ mm}$, $dy=10 \text{ mm}$

Maximum value of SAR (Measurement) = 0.581 W/kg

GSM 850MHz Left Cheek High SIM2/Zoom Scan (7x7x7)/Cube 0:

Measurement grid: $dx=5\text{mm}$, $dy=5\text{mm}$, $dz=5\text{mm}$

Reference Value = 8.178 V/m ; Power Drift = 0.12 dB

Peak SAR (extrapolated) = 0.691 W/kg

SAR(1 g) = 0.544 W/kg ; SAR(10 g) = 0.404 W/kg

Maximum of SAR (measured) = 0.565 W/kg

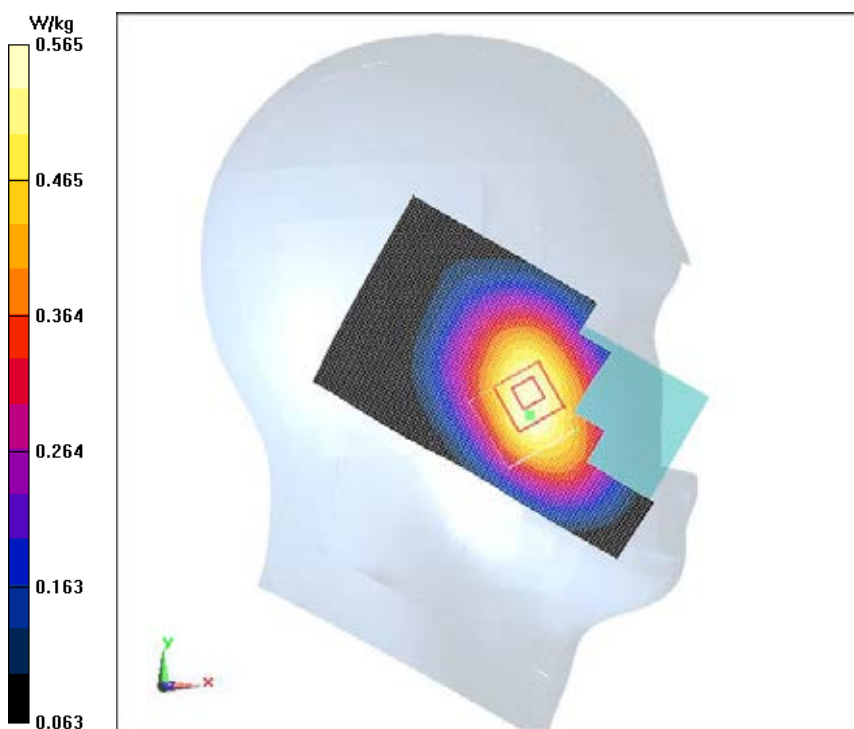

GPRS 850MHz 4TS Phantom Mode Middle

Date/Time: 2014/4/26

Electronics: DAE4 Sn1244

Medium: Body 850MHz

Medium parameters used: $f = 837 \text{ MHz}$; $\sigma = 1.001 \text{ S/m}$; $\epsilon_r = 55.152$; $\rho = 1000 \text{ kg/m}^3$

Ambient Temperature: 22.5°C Liquid Temperature: 22.5°C

Communication System: GSM 850MHz GPRS 4TS; Frequency: 836.6 MHz ; Duty Cycle: 1:2

Probe: ES3DV3 - SN3252ConvF(6.14, 6.14, 6.14); Calibrated: 8/5/2013

GPRS 850MHz 4TS Phantom Mode Middle/Area Scan (61x101x1):

Measurement grid: $dx=10 \text{ mm}$, $dy=10 \text{ mm}$

Maximum value of SAR (Measurement) = 0.518 W/kg

GPRS 850MHz 4TS Phantom Mode Middle/Zoom Scan (7x7x7)/Cube 0:

Measurement grid: $dx=5\text{mm}$, $dy=5\text{mm}$, $dz=5\text{mm}$

Reference Value = 22.691 V/m ; Power Drift = -0.05 dB

Peak SAR (extrapolated) = 0.605 W/kg

SAR(1 g) = 0.498 W/kg ; SAR(10 g) = 0.383 W/kg

Maximum value of SAR (measured) = 0.524 W/kg

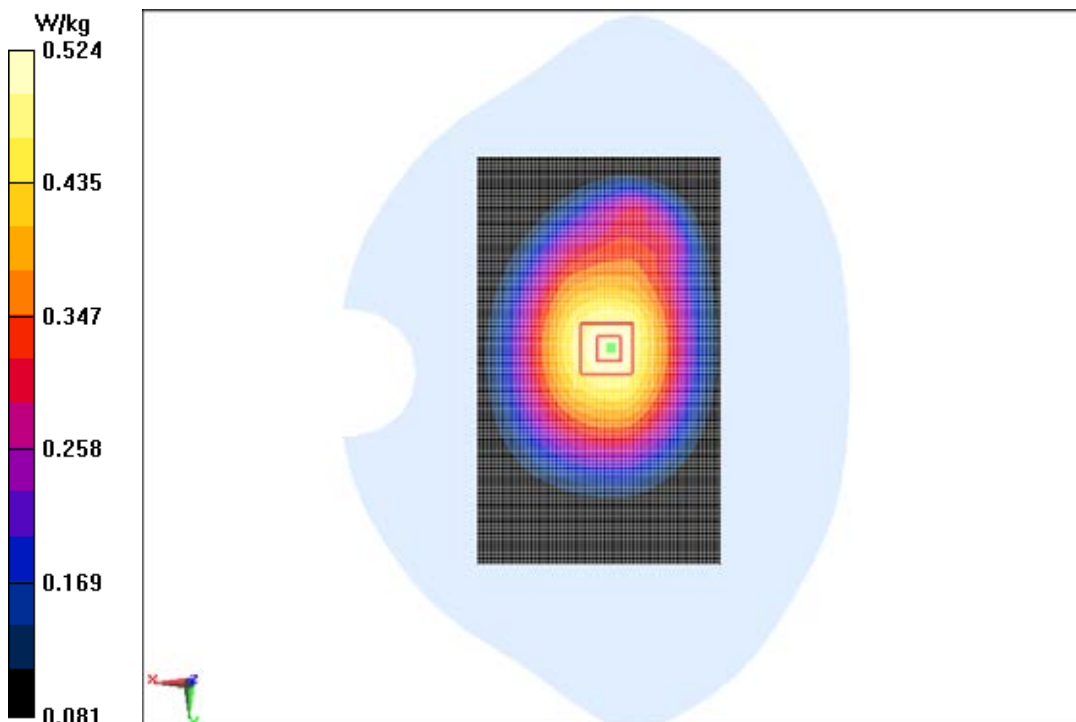

GPRS 850MHz 4TS Ground Mode Middle

Date/Time: 2014/4/26

Electronics: DAE4 Sn1244

Medium: Body 850MHz

Medium parameters used: $f = 837 \text{ MHz}$; $\sigma = 1.001 \text{ S/m}$; $\epsilon_r = 55.152$; $\rho = 1000 \text{ kg/m}^3$

Ambient Temperature: 22.5°C Liquid Temperature: 22.5°C

Communication System: GSM 850MHz GPRS 4TS; Frequency: 836.6 MHz ; Duty Cycle: 1:2

Probe: ES3DV3 - SN3252ConvF(6.14, 6.14, 6.14); Calibrated: 8/5/2013

GPRS 850MHz 4TS Ground Mode Middle/Area Scan (61x101x1):

Measurement grid: $dx=10 \text{ mm}$, $dy=10 \text{ mm}$

Maximum value of SAR (Measurement) = 0.586 W/kg

GPRS 850MHz 4TS Ground Mode Middle/Zoom Scan (7x7x7)/Cube 0:

Measurement grid: $dx=5\text{mm}$, $dy=5\text{mm}$, $dz=5\text{mm}$

Reference Value = 23.873 V/m ; Power Drift = -0.01 dB

Peak SAR (extrapolated) = 0.671 W/kg

SAR(1 g) = 0.561 W/kg ; SAR(10 g) = 0.434 W/kg

Maximum value of SAR (measured) = 0.588 W/kg

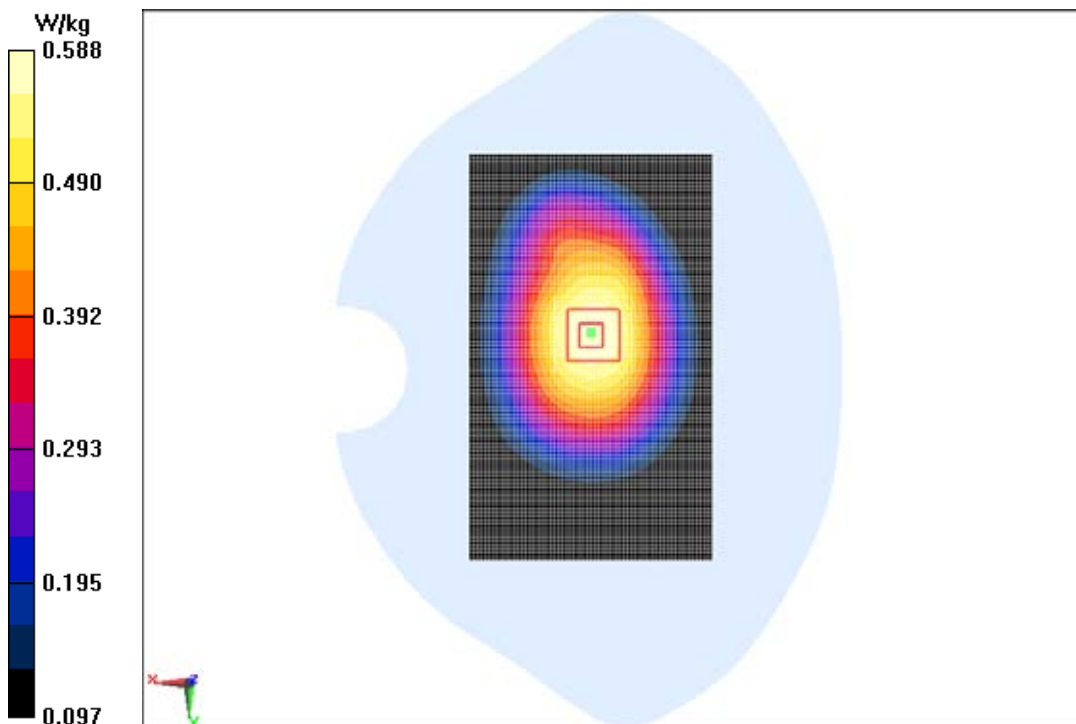

GPRS 850MHz 4TS Left Mode Middle

Date/Time: 2014/4/26

Electronics: DAE4 Sn1244

Medium: Body 850MHz

Medium parameters used: $f = 837 \text{ MHz}$; $\sigma = 1.001 \text{ S/m}$; $\epsilon_r = 55.152$; $\rho = 1000 \text{ kg/m}^3$ Ambient Temperature: 22.5°C Liquid Temperature: 22.5°C Communication System: GSM 850MHz GPRS 4TS; Frequency: 836.6 MHz ; Duty Cycle: 1:2

Probe: ES3DV3 - SN3252ConvF(6.14, 6.14, 6.14); Calibrated: 8/5/2013

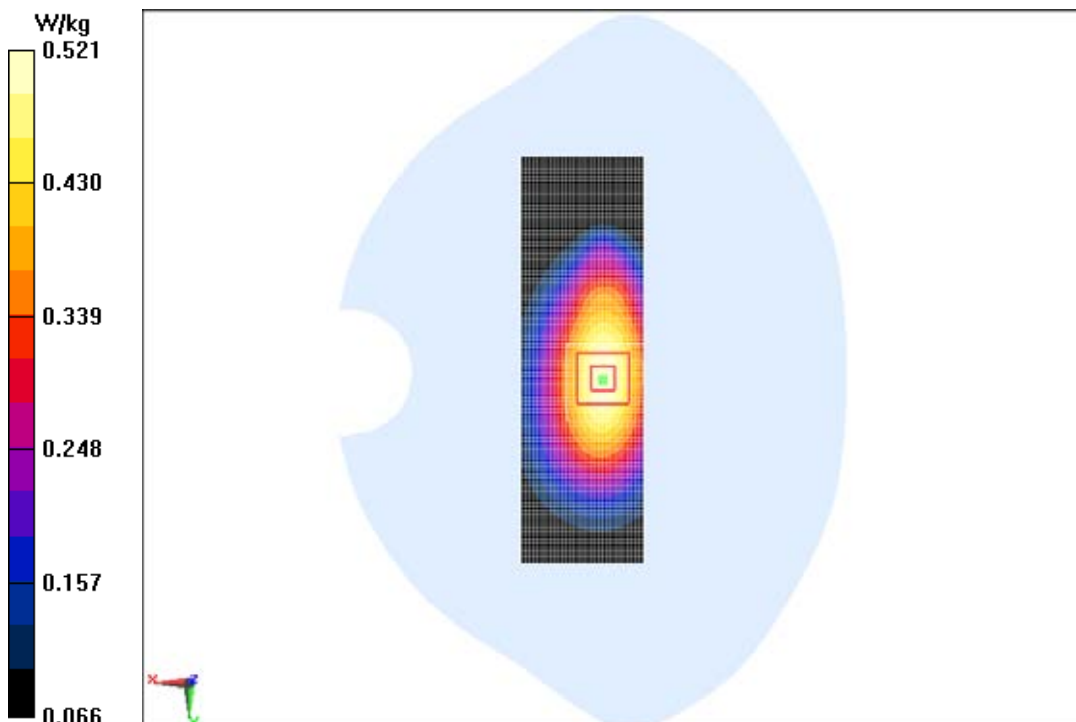
GPRS 850MHz 4TS Left Mode Middle/Area Scan (31x101x1):Measurement grid: $dx=10 \text{ mm}$, $dy=10 \text{ mm}$ Maximum value of SAR (Measurement) = 0.525 W/kg **GPRS 850MHz 4TS Left Mode Middle/Zoom Scan (7x7x7)/Cube 0:**Measurement grid: $dx=5\text{mm}$, $dy=5\text{mm}$, $dz=5\text{mm}$ Reference Value = 23.029 V/m ; Power Drift = 0.03 dB Peak SAR (extrapolated) = 0.651 W/kg SAR(1 g) = 0.490 W/kg ; SAR(10 g) = 0.346 W/kg Maximum value of SAR (measured) = 0.521 W/kg 

GPRS 850MHz 4TS Right Mode Middle

Date/Time: 2014/4/26

Electronics: DAE4 Sn1244

Medium: Body 850MHz

Medium parameters used: $f = 837 \text{ MHz}$; $\sigma = 1.001 \text{ S/m}$; $\epsilon_r = 55.152$; $\rho = 1000 \text{ kg/m}^3$

Ambient Temperature: 22.5°C Liquid Temperature: 22.5°C

Communication System: GSM 850MHz GPRS 4TS; Frequency: 836.6 MHz; Duty Cycle: 1:2

Probe: ES3DV3 - SN3252ConvF(6.14, 6.14, 6.14); Calibrated: 8/5/2013

GPRS 850MHz 4TS Right Mode Middle/Area Scan (31x101x1):Measurement grid: $dx=10 \text{ mm}$, $dy=10 \text{ mm}$

Maximum value of SAR (Measurement) = 0.393 W/kg

GPRS 850MHz 4TS Right Mode Middle/Zoom Scan (7x7x7)/Cube 0:Measurement grid: $dx=5\text{mm}$, $dy=5\text{mm}$, $dz=5\text{mm}$

Reference Value = 19.737 V/m; Power Drift = 0.07 dB

Peak SAR (extrapolated) = 0.486 W/kg

SAR(1 g) = 0.365 W/kg; SAR(10 g) = 0.257 W/kg

Maximum value of SAR (measured) = 0.390 W/kg

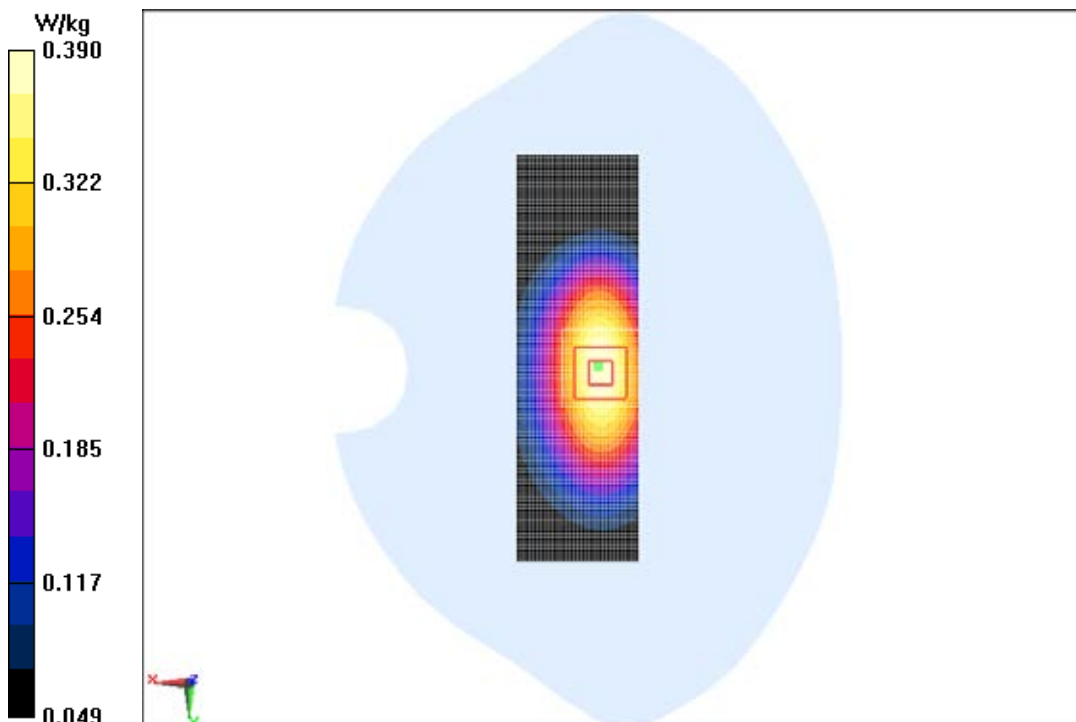

GPRS 850MHz 4TS Bottom Mode Middle

Date/Time: 2014/4/26

Electronics: DAE4 Sn1244

Medium: Body 850MHz

Medium parameters used: $f = 837 \text{ MHz}$; $\sigma = 1.001 \text{ S/m}$; $\epsilon_r = 55.152$; $\rho = 1000 \text{ kg/m}^3$

Ambient Temperature: 22.5°C Liquid Temperature: 22.5°C

Communication System: GSM 850MHz GPRS 4TS; Frequency: 836.6 MHz ; Duty Cycle: 1:2

Probe: ES3DV3 - SN3252ConvF(6.14, 6.14, 6.14); Calibrated: 8/5/2013

GPRS 850MHz 4TS Bottom Mode Middle/Area Scan (31x61x1):

Measurement grid: $dx=10 \text{ mm}$, $dy=10 \text{ mm}$

Maximum value of SAR (Measurement) = 0.149 W/kg

GPRS 850MHz 4TS Bottom Mode Middle/Zoom Scan (7x7x7)/Cube 0:

Measurement grid: $dx=5\text{mm}$, $dy=5\text{mm}$, $dz=5\text{mm}$

Reference Value = 12.225 V/m ; Power Drift = -0.18 dB

Peak SAR (extrapolated) = 0.213 W/kg

SAR(1 g) = 0.126 W/kg ; SAR(10 g) = 0.077 W/kg

Maximum of SAR (measured) = 0.134 W/kg

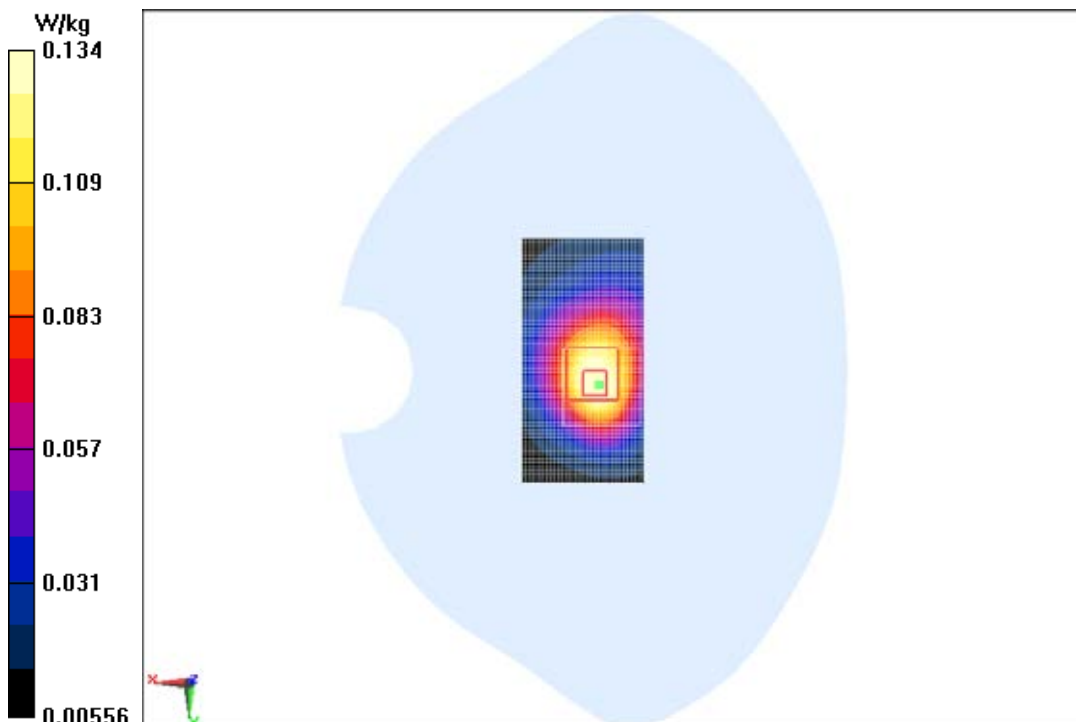

GPRS 850MHz 4TS Ground Mode Low

Date/Time: 2014/4/26

Electronics: DAE4 Sn1244

Medium: Body 850MHz

Medium parameters used (interpolated): $f = 824.2$ MHz; $\sigma = 0.993$ S/m; $\epsilon_r = 55.149$; $\rho = 1000$ kg/m³

Ambient Temperature: 22.5°C Liquid Temperature: 22.5°C

Communication System: GSM 850MHz GPRS 4TS; Frequency: 824.2 MHz; Duty Cycle: 1:2

Probe: ES3DV3 - SN3252ConvF(6.14, 6.14, 6.14); Calibrated: 8/5/2013

GPRS 850MHz 4TS Ground Mode Low/Area Scan (61x101x1):

Measurement grid: dx=10 mm, dy=10 mm

Maximum value of SAR (Measurement) = 0.416 W/kg

GPRS 850MHz 4TS Ground Mode Low/Zoom Scan (7x7x7)/Cube 0:

Measurement grid: dx=5mm, dy=5mm, dz=5mm

Reference Value = 20.044 V/m; Power Drift = -0.02 dB

Peak SAR (extrapolated) = 0.478 W/kg

SAR(1 g) = 0.397 W/kg; SAR(10 g) = 0.307 W/kg

Maximum value of SAR (measured) = 0.417 W/kg

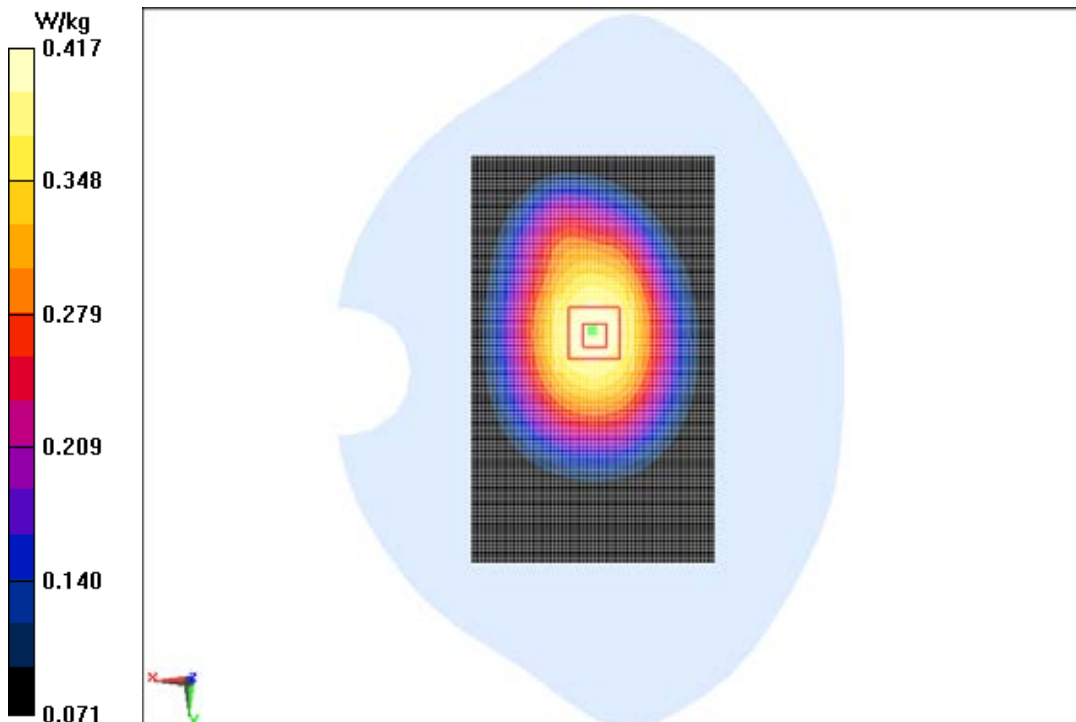

GPRS 850MHz 4TS Ground Mode high

Date/Time: 2014/4/26

Electronics: DAE4 Sn1244

Medium: Body 850MHz

Medium parameters used: $f = 849 \text{ MHz}$; $\sigma = 1.015 \text{ S/m}$; $\epsilon_r = 55.205$; $\rho = 1000 \text{ kg/m}^3$

Ambient Temperature: 22.5°C Liquid Temperature: 22.5°C

Communication System: GSM 850MHz GPRS 4TS (0); Frequency: 848.8 MHz; Duty Cycle: 1:2

Probe: ES3DV3 - SN3252ConvF(6.14, 6.14, 6.14); Calibrated: 8/5/2013

GPRS 850MHz 4TS Ground Mode high/Area Scan (61x101x1):

Measurement grid: $dx=10 \text{ mm}$, $dy=10 \text{ mm}$

Maximum value of SAR (Measurement) = 0.807 W/kg

GPRS 850MHz 4TS Ground Mode high/Zoom Scan (7x7x7)/Cube 0:

Measurement grid: $dx=5\text{mm}$, $dy=5\text{mm}$, $dz=5\text{mm}$

Reference Value = 28.261 V/m; Power Drift = -0.08 dB

Peak SAR (extrapolated) = 0.916 W/kg

SAR(1 g) = 0.769 W/kg; SAR(10 g) = 0.595 W/kg

Maximum value of SAR (measured) = 0.801 W/kg

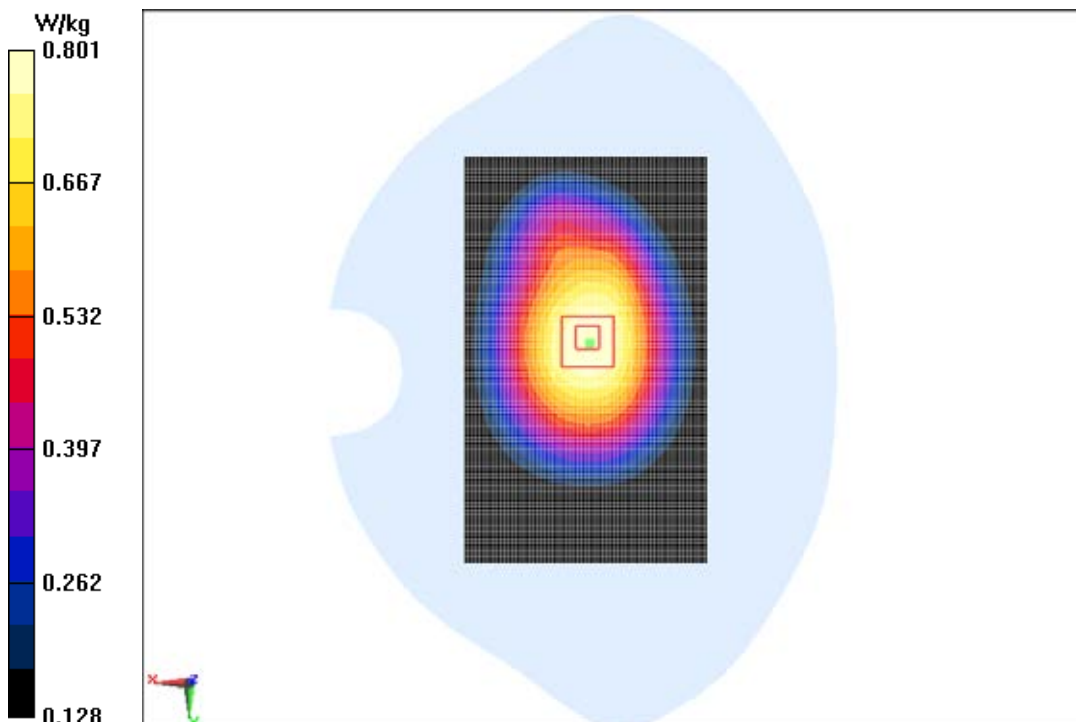

GSM 850MHz Ground Mode High With Headset

Date/Time: 2014/4/26

Electronics: DAE4 Sn1244

Medium: Body 850MHz

Medium parameters used: $f = 849 \text{ MHz}$; $\sigma = 1.015 \text{ S/m}$; $\epsilon_r = 55.205$; $\rho = 1000 \text{ kg/m}^3$

Ambient Temperature: 22.5°C Liquid Temperature: 22.5°C

Communication System: GSM Professional 850MHz; Frequency: 848.8 MHz; Duty Cycle: 1:8.3

Probe: ES3DV3 - SN3252ConvF(6.14, 6.14, 6.14); Calibrated: 8/5/2013

GSM 850MHz Ground Mode High With Headset/Area Scan (61x101x1):

Measurement grid: $dx=10 \text{ mm}$, $dy=10 \text{ mm}$

Maximum value of SAR (Measurement) = 0.651 W/kg

GSM 850MHz Ground Mode High With Headset/Zoom Scan (7x7x7)/Cube 0:

Measurement grid: $dx=5\text{mm}$, $dy=5\text{mm}$, $dz=5\text{mm}$

Reference Value = 25.291 V/m; Power Drift = -0.05 dB

Peak SAR (extrapolated) = 0.736 W/kg

SAR(1 g) = 0.622 W/kg; SAR(10 g) = 0.480 W/kg

Maximum value of SAR (measured) = 0.650 W/kg

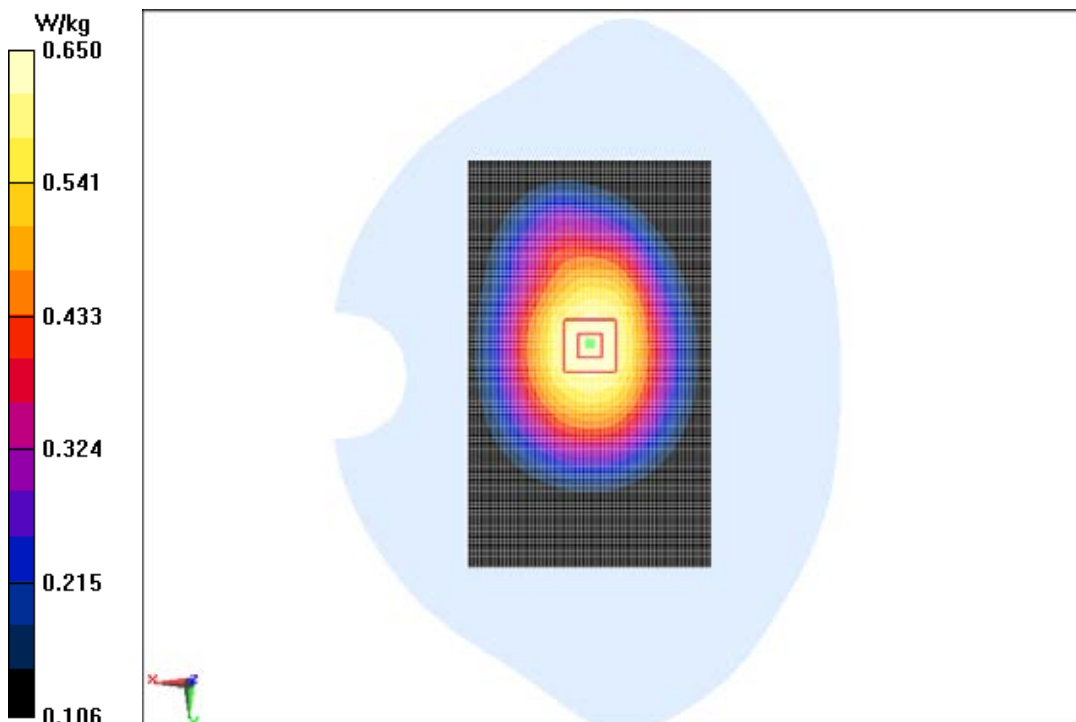

GPRS 850MHz 4TS Ground Mode high SIM2

Date/Time: 2014/4/26

Electronics: DAE4 Sn1244

Medium: Body 850MHz

Medium parameters used: $f = 849 \text{ MHz}$; $\sigma = 1.015 \text{ S/m}$; $\epsilon_r = 55.205$; $\rho = 1000 \text{ kg/m}^3$

Ambient Temperature: 22.5°C Liquid Temperature: 22.5°C

Communication System: GSM 850MHz GPRS 4TS (0); Frequency: 848.8 MHz; Duty Cycle: 1:2

Probe: ES3DV3 - SN3252ConvF(6.14, 6.14, 6.14); Calibrated: 8/5/2013

GPRS 850MHz 4TS Ground Mode high SIM2/Area Scan (61x101x1):

Measurement grid: $dx=10 \text{ mm}$, $dy=10 \text{ mm}$

Maximum value of SAR (Measurement) = 0.742 W/kg

GPRS 850MHz 4TS Ground Mode high SIM2/Zoom Scan (7x7x7)/Cube 0:

Measurement grid: $dx=5\text{mm}$, $dy=5\text{mm}$, $dz=5\text{mm}$

Reference Value = 27.976 V/m ; Power Drift = -0.04 dB

Peak SAR (extrapolated) = 0.846 W/kg

SAR(1 g) = 0.698 W/kg ; SAR(10 g) = 0.536 W/kg

Maximum value of SAR (measured) = 0.733 W/kg

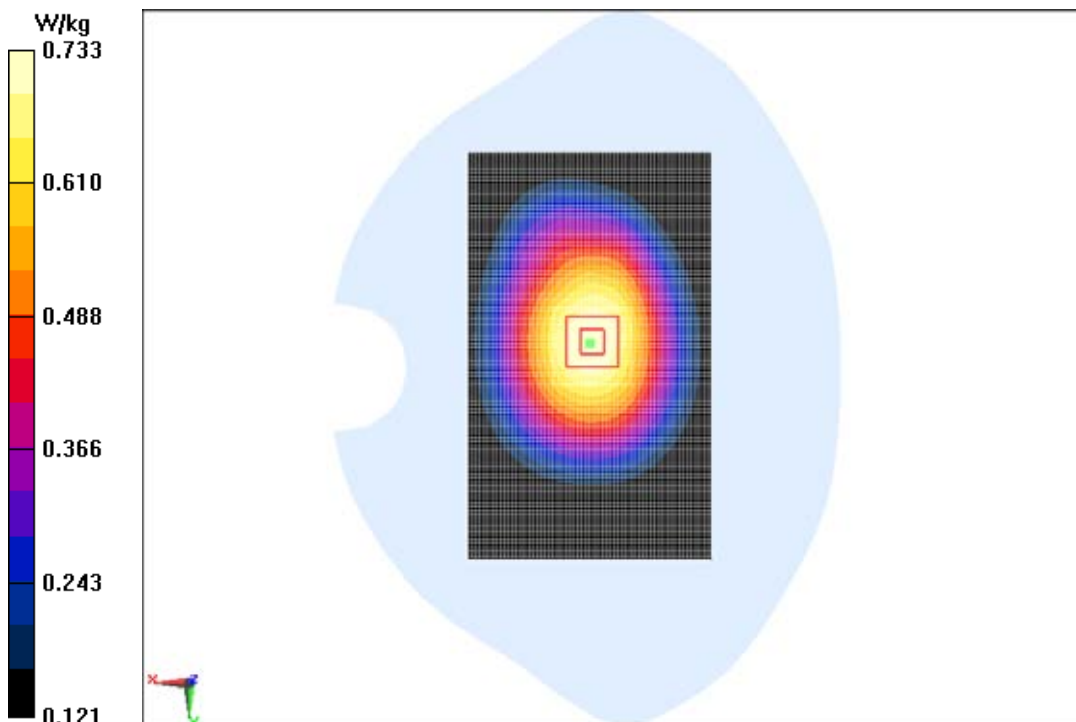

GSM 1900MHz Left Cheek Middle

Date/Time: 2014/4/28

Electronics: DAE4 Sn1244

Medium: Head 1900MHz

Medium parameters used: $f = 1880$ MHz; $\sigma = 1.379$ S/m; $\epsilon_r = 39.867$; $\rho = 1000$ kg/m³

Ambient Temperature: 22.5°C Liquid Temperature: 22.5°C

Communication System: GSM 1900MHz; Frequency: 1880 MHz; Duty Cycle: 1:8.3

Probe: ES3DV3 - SN3252ConvF(5.24, 5.24, 5.24); Calibrated: 8/5/2013

GSM 1900MHz Left Cheek Middle/Area Scan (111x71x1):

Measurement grid: dx=10 mm, dy=10 mm

Maximum value of SAR (Measurement) = 0.412 W/kg

GSM 1900MHz Left Cheek Middle/Zoom Scan (7x7x7)/Cube 0:

Measurement grid: dx=5mm, dy=5mm, dz=5mm

Reference Value = 4.507 V/m; Power Drift = -0.15 dB

Peak SAR (extrapolated) = 0.624 W/kg

SAR(1 g) = 0.379 W/kg; SAR(10 g) = 0.217 W/kg

Maximum value of SAR (measured) = 0.419 W/kg

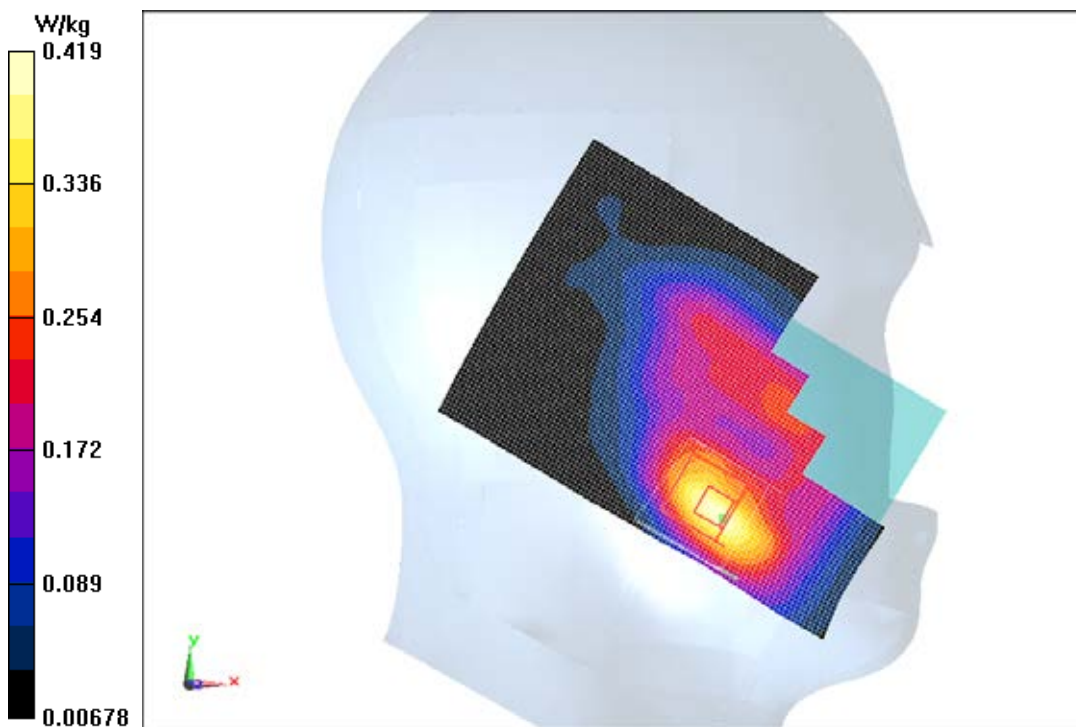

GSM 1900MHz Left Tilt Middle

Date/Time: 2014/4/28

Electronics: DAE4 Sn1244

Medium: Head 1900MHz

Medium parameters used: $f = 1880$ MHz; $\sigma = 1.379$ S/m; $\epsilon_r = 39.867$; $\rho = 1000$ kg/m³

Ambient Temperature: 22.5°C Liquid Temperature: 22.5°C

Communication System: GSM 1900MHz; Frequency: 1880 MHz; Duty Cycle: 1:8.3

Probe: ES3DV3 - SN3252ConvF(5.24, 5.24, 5.24); Calibrated: 8/5/2013

GSM 1900MHz Left Tilt Middle/Area Scan (11x71x1):

Measurement grid: dx=10 mm, dy=10 mm

Maximum value of SAR (Measurement) = 0.0840 W/kg

GSM 1900MHz Left Tilt Middle/Zoom Scan (7x7x7)/Cube 0:

Measurement grid: dx=5mm, dy=5mm, dz=5mm

Reference Value = 6.015 V/m; Power Drift = 0.05 dB

Peak SAR (extrapolated) = 0.131 W/kg

SAR(1 g) = 0.078 W/kg; SAR(10 g) = 0.046 W/kg

Maximum of SAR (measured) = 0.0937 W/kg

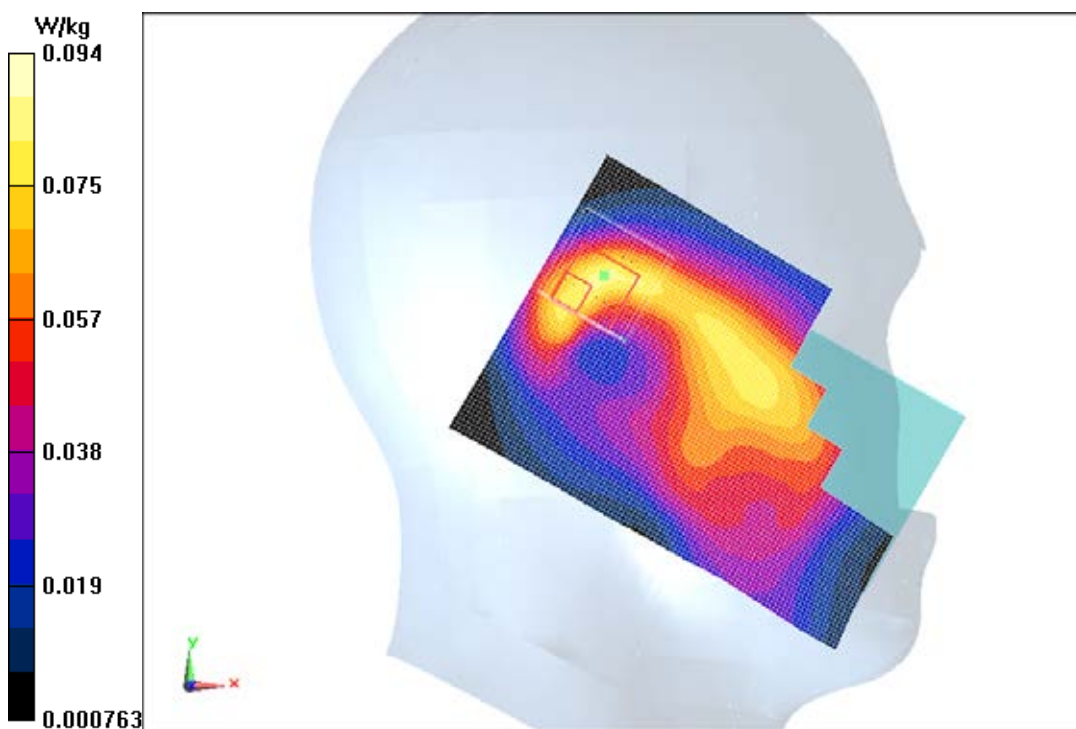

GSM 1900MHz Right Cheek Middle

Date/Time: 2014/4/28

Electronics: DAE4 Sn1244

Medium: Head 1900MHz

Medium parameters used: $f = 1880 \text{ MHz}$; $\sigma = 1.379 \text{ S/m}$; $\epsilon_r = 39.867$; $\rho = 1000 \text{ kg/m}^3$

Ambient Temperature: 22.5°C Liquid Temperature: 22.5°C

Communication System: GSM 1900MHz; Frequency: 1880 MHz; Duty Cycle: 1:8.3

Probe: ES3DV3 - SN3252ConvF(5.24, 5.24, 5.24); Calibrated: 8/5/2013

GSM 1900MHz Right Cheek Middle/Area Scan (111x71x1):

Measurement grid: $dx=10 \text{ mm}$, $dy=10 \text{ mm}$

Maximum value of SAR (Measurement) = 0.392 W/kg

GSM 1900MHz Right Cheek Middle/Zoom Scan (7x7x7)/Cube 0:

Measurement grid: $dx=5\text{mm}$, $dy=5\text{mm}$, $dz=5\text{mm}$

Reference Value = 3.419 V/m; Power Drift = 0.07 dB

Peak SAR (extrapolated) = 0.534 W/kg

SAR(1 g) = 0.357 W/kg; SAR(10 g) = 0.218 W/kg

Maximum value of SAR (measured) = 0.391 W/kg

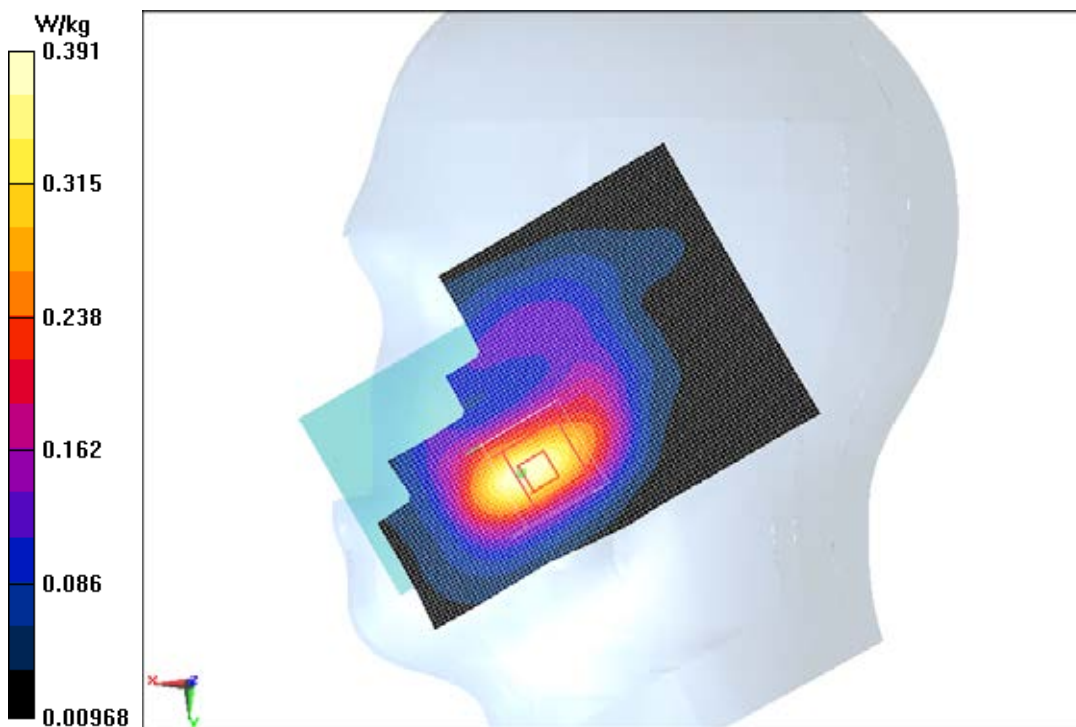

GSM 1900MHz Right Tilt Middle

Date/Time: 2014/4/28

Electronics: DAE4 Sn1244

Medium: Head 1900MHz

Medium parameters used: $f = 1880$ MHz; $\sigma = 1.379$ S/m; $\epsilon_r = 39.867$; $\rho = 1000$ kg/m³

Ambient Temperature: 22.5°C Liquid Temperature: 22.5°C

Communication System: GSM 1900MHz; Frequency: 1880 MHz; Duty Cycle: 1:8.3

Probe: ES3DV3 - SN3252ConvF(5.24, 5.24, 5.24); Calibrated: 8/5/2013

GSM 1900MHz Right Tilt Middle/Area Scan (111x71x1):

Measurement grid: dx=10 mm, dy=10 mm

Maximum value of SAR (Measurement) = 0.0799 W/kg

GSM 1900MHz Right Tilt Middle/Zoom Scan (7x7x7)/Cube 0:

Measurement grid: dx=5mm, dy=5mm, dz=5mm

Reference Value = 6.007 V/m; Power Drift = 0.07 dB

Peak SAR (extrapolated) = 0.105 W/kg

SAR(1 g) = 0.075 W/kg; SAR(10 g) = 0.050 W/kg

Maximum value of SAR (measured) = 0.0799 W/kg

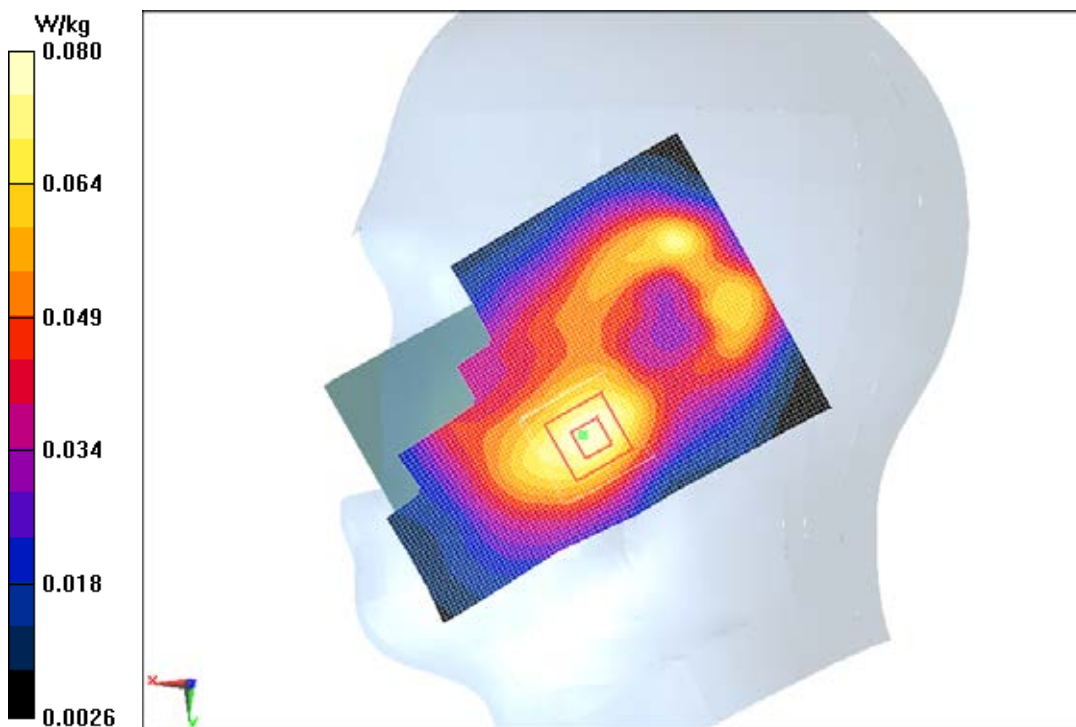

GSM 1900MHz Left Cheek Low

Date/Time: 2014/4/28

Electronics: DAE4 Sn1244

Medium: Head 1900MHz

Medium parameters used (interpolated): $f = 1850.2$ MHz; $\sigma = 1.372$ S/m; $\epsilon_r = 40.172$; $\rho = 1000$ kg/m³

Ambient Temperature: 22.5°C Liquid Temperature: 22.5°C

Communication System: GSM 1900MHz; Frequency: 1850.2 MHz; Duty Cycle: 1:8.3

Probe: ES3DV3 - SN3252ConvF(5.24, 5.24, 5.24); Calibrated: 8/5/2013

GSM 1900MHz Left Cheek Low/Area Scan (11x71x1):

Measurement grid: dx=10 mm, dy=10 mm

Maximum value of SAR (Measurement) = 0.417 W/kg

GSM 1900MHz Left Cheek Low/Zoom Scan (7x7x7)/Cube 0:

Measurement grid: dx=5mm, dy=5mm, dz=5mm

Reference Value = 3.277 V/m; Power Drift = 0.14 dB

Peak SAR (extrapolated) = 0.644 W/kg

SAR(1 g) = 0.393 W/kg; SAR(10 g) = 0.228 W/kg

Maximum value of SAR (measured) = 0.430 W/kg

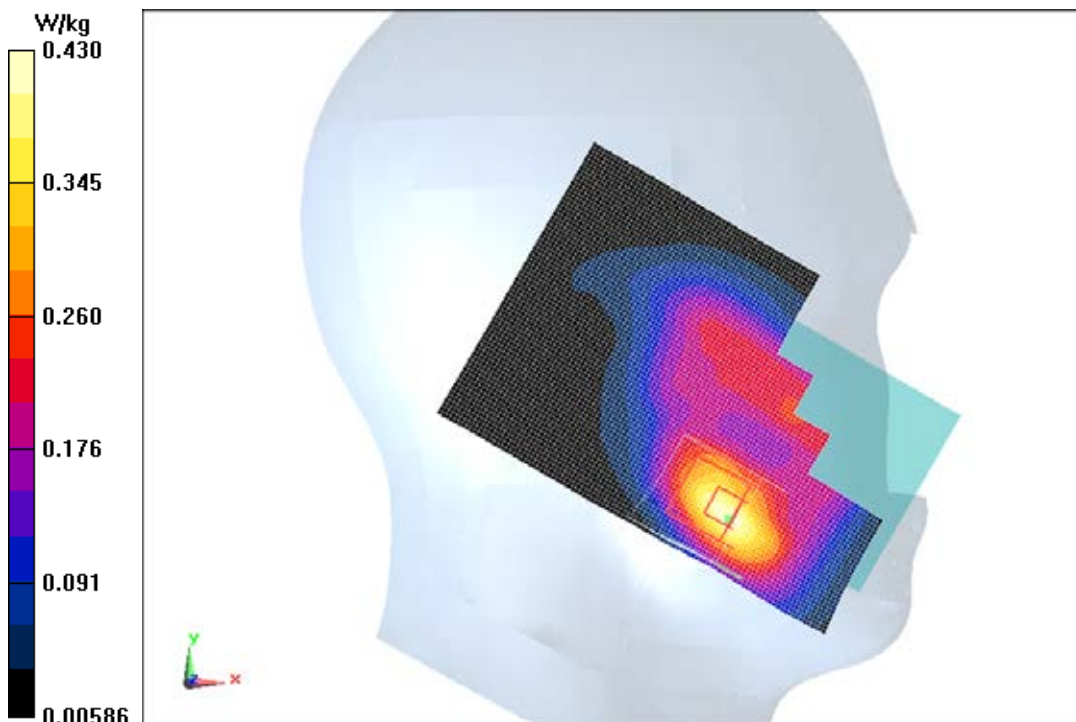

GSM 1900MHz Left Cheek High

Date/Time: 2014/4/28

Electronics: DAE4 Sn1244

Medium: Head 1900MHz

Medium parameters used: $f = 1910$ MHz; $\sigma = 1.393$ S/m; $\epsilon_r = 39.622$; $\rho = 1000$ kg/m³

Ambient Temperature: 22.5°C Liquid Temperature: 22.5°C

Communication System: GSM 1900MHz; Frequency: 1909.8 MHz; Duty Cycle: 1:8.3

Probe: ES3DV3 - SN3252ConvF(5.24, 5.24, 5.24); Calibrated: 8/5/2013

GSM 1900MHz Left Cheek High/Area Scan (111x71x1):

Measurement grid: dx=10 mm, dy=10 mm

Maximum value of SAR (Measurement) = 0.399 W/kg

GSM 1900MHz Left Cheek High/Zoom Scan (7x7x7)/Cube 0:

Measurement grid: dx=5mm, dy=5mm, dz=5mm

Reference Value = 4.381 V/m; Power Drift = 0.17 dB

Peak SAR (extrapolated) = 0.625 W/kg

SAR(1 g) = 0.376 W/kg; SAR(10 g) = 0.215 W/kg

Maximum value of SAR (measured) = 0.414 W/kg

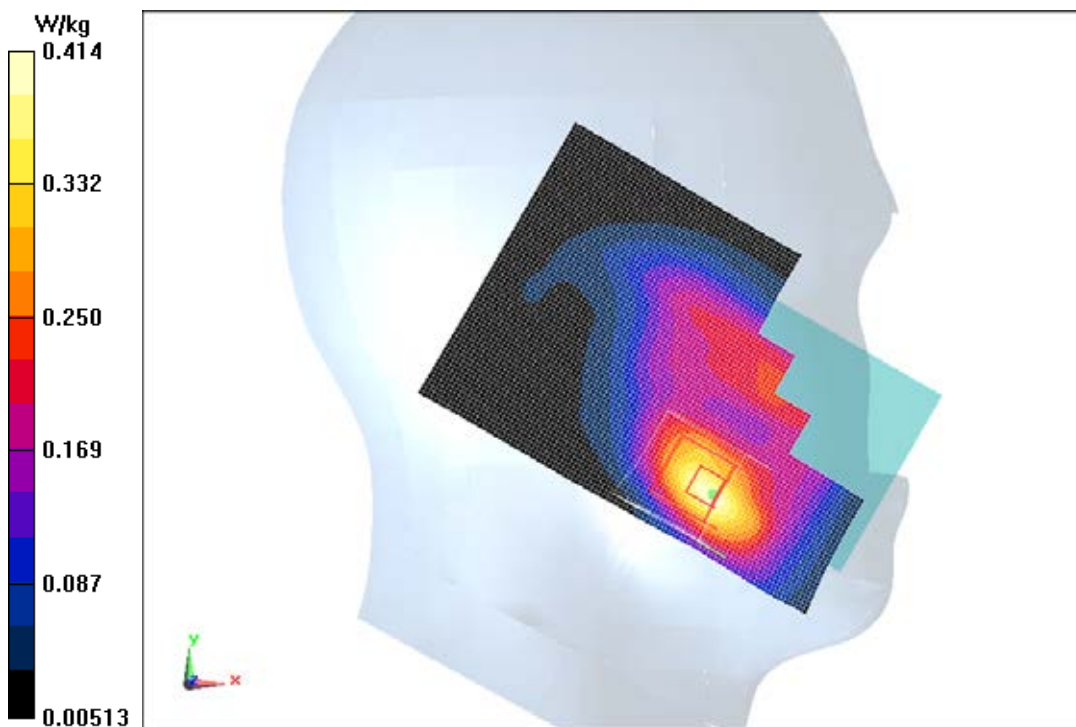

GSM 1900MHz Left Cheek Low SIM2

Date/Time: 2014/4/28

Electronics: DAE4 Sn1244

Medium: Head 1900MHz

Medium parameters used (interpolated): $f = 1850.2$ MHz; $\sigma = 1.372$ S/m; $\epsilon_r = 40.172$; $\rho = 1000$ kg/m³

Ambient Temperature: 22.5°C Liquid Temperature: 22.5°C

Communication System: GSM 1900MHz; Frequency: 1850.2 MHz; Duty Cycle: 1:8.3

Probe: ES3DV3 - SN3252ConvF(5.24, 5.24, 5.24); Calibrated: 8/5/2013

GSM 1900MHz Left Cheek Low SIM2/Area Scan (111x71x1):

Measurement grid: dx=10 mm, dy=10 mm

Maximum value of SAR (Measurement) = 0.381 W/kg

GSM 1900MHz Left Cheek Low SIM2/Zoom Scan (7x7x7)/Cube 0:

Measurement grid: dx=5mm, dy=5mm, dz=5mm

Reference Value = 3.749 V/m; Power Drift = 0.14 dB

Peak SAR (extrapolated) = 0.601 W/kg

SAR(1 g) = 0.366 W/kg; SAR(10 g) = 0.209 W/kg

Maximum value of SAR (measured) = 0.403 W/kg

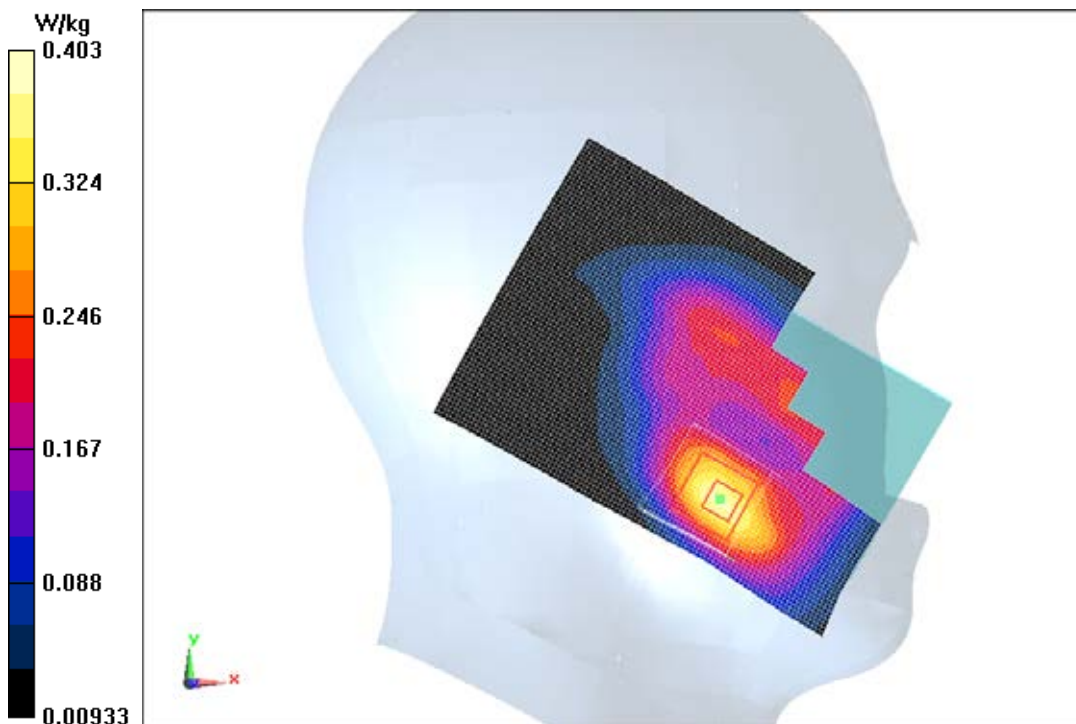

GPRS 1900MHz 4TS Phantom Mode Middle

Date/Time: 2014/4/29

Electronics: DAE4 Sn1244

Medium: Body 1900MHz

Medium parameters used: $f = 1880$ MHz; $\sigma = 1.504$ S/m; $\epsilon_r = 53.319$; $\rho = 1000$ kg/m³

Ambient Temperature: 22.5°C Liquid Temperature: 22.5°C

Communication System: GSM 1900MHz GPRS 4TS; Frequency: 1880 MHz; Duty Cycle: 1:2

Probe: ES3DV3 - SN3252ConvF(5.03, 5.03, 5.03); Calibrated: 8/5/2013

GPRS 1900MHz 4TS Phantom Mode Middle/Area Scan (61x111x1):

Measurement grid: dx=10 mm, dy=10 mm

Maximum value of SAR (Measurement) = 0.544 W/kg

GPRS 1900MHz 4TS Phantom Mode Middle/Zoom Scan (7x7x7)/Cube 0:

Measurement grid: dx=5mm, dy=5mm, dz=5mm

Reference Value = 5.665 V/m; Power Drift = -0.16 dB

Peak SAR (extrapolated) = 0.814 W/kg

SAR(1 g) = 0.493 W/kg; SAR(10 g) = 0.276 W/kg

Maximum value of SAR (measured) = 0.545 W/kg

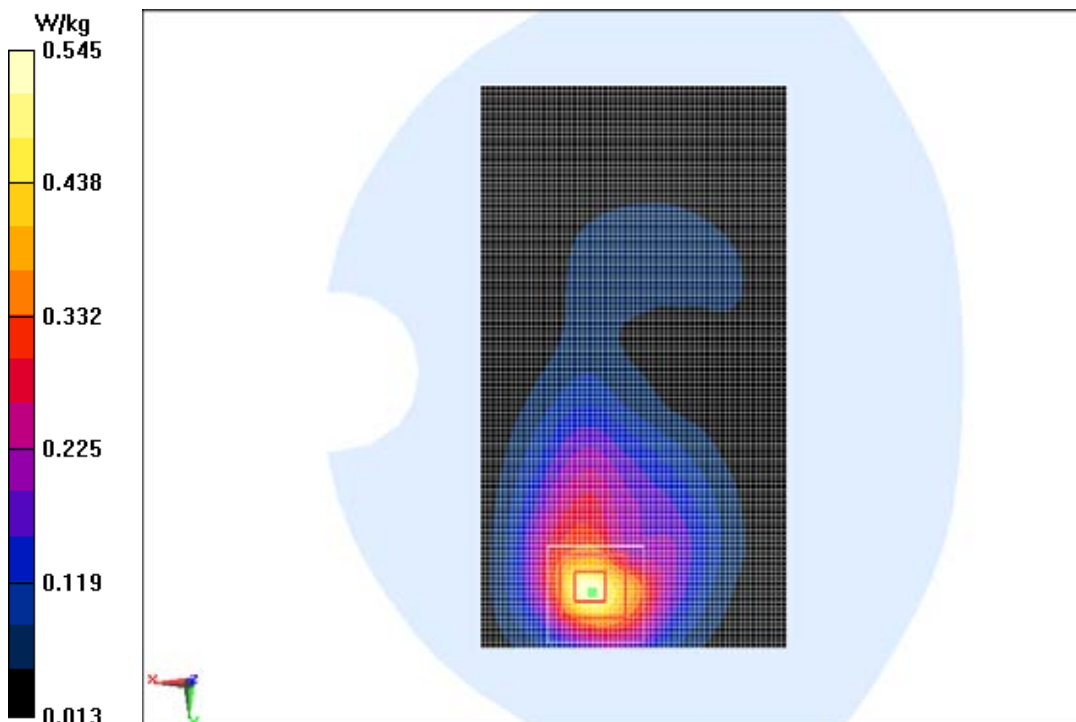

GPRS 1900MHz 4TS Ground Mode Middle

Date/Time: 2014/4/29

Electronics: DAE4 Sn1244

Medium: Body 1900MHz

Medium parameters used: $f = 1880$ MHz; $\sigma = 1.504$ S/m; $\epsilon_r = 53.319$; $\rho = 1000$ kg/m³

Ambient Temperature: 22.5°C Liquid Temperature: 22.5°C

Communication System: GSM 1900MHz GPRS 4TS; Frequency: 1880 MHz; Duty Cycle: 1:2

Probe: ES3DV3 - SN3252ConvF(5.03, 5.03, 5.03); Calibrated: 8/5/2013

GPRS 1900MHz 4TS Ground Mode Middle/Area Scan (61x111x1):

Measurement grid: dx=10 mm, dy=10 mm

Maximum value of SAR (Measurement) = 0.439 W/kg

GPRS 1900MHz 4TS Ground Mode Middle/Zoom Scan (7x7x7)/Cube 0:

Measurement grid: dx=5mm, dy=5mm, dz=5mm

Reference Value = 5.494 V/m; Power Drift = 0.02 dB

Peak SAR (extrapolated) = 0.661 W/kg

SAR(1 g) = 0.417 W/kg; SAR(10 g) = 0.247 W/kg

Maximum value of SAR (measured) = 0.452 W/kg

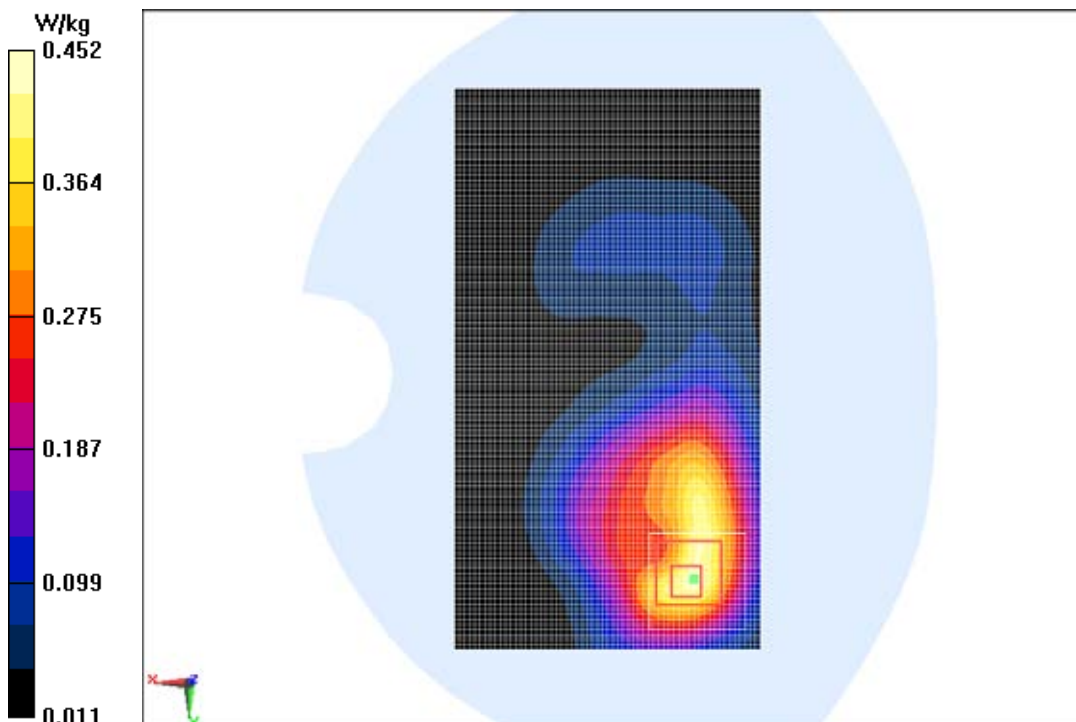

GPRS 1900MHz 4TS Left Mode Middle

Date/Time: 2014/4/29

Electronics: DAE4 Sn1244

Medium: Body 1900MHz

Medium parameters used: $f = 1880$ MHz; $\sigma = 1.504$ S/m; $\epsilon_r = 53.319$; $\rho = 1000$ kg/m³

Ambient Temperature: 22.5°C Liquid Temperature: 22.5°C

Communication System: GSM 1900MHz GPRS 4TS; Frequency: 1880 MHz; Duty Cycle: 1:2

Probe: ES3DV3 - SN3252ConvF(5.03, 5.03, 5.03); Calibrated: 8/5/2013

GPRS 1900MHz 4TS Left Mode Middle/Area Scan (31x101x1):

Measurement grid: dx=10 mm, dy=10 mm

Maximum value of SAR (Measurement) = 0.255 W/kg

GPRS 1900MHz 4TS Left Mode Middle/Zoom Scan (7x7x7)/Cube 0:

Measurement grid: dx=5mm, dy=5mm, dz=5mm

Reference Value = 7.607 V/m; Power Drift = 0.11 dB

Peak SAR (extrapolated) = 0.385 W/kg

SAR(1 g) = 0.242 W/kg; SAR(10 g) = 0.144 W/kg

Maximum value of SAR (measured) = 0.263 W/kg

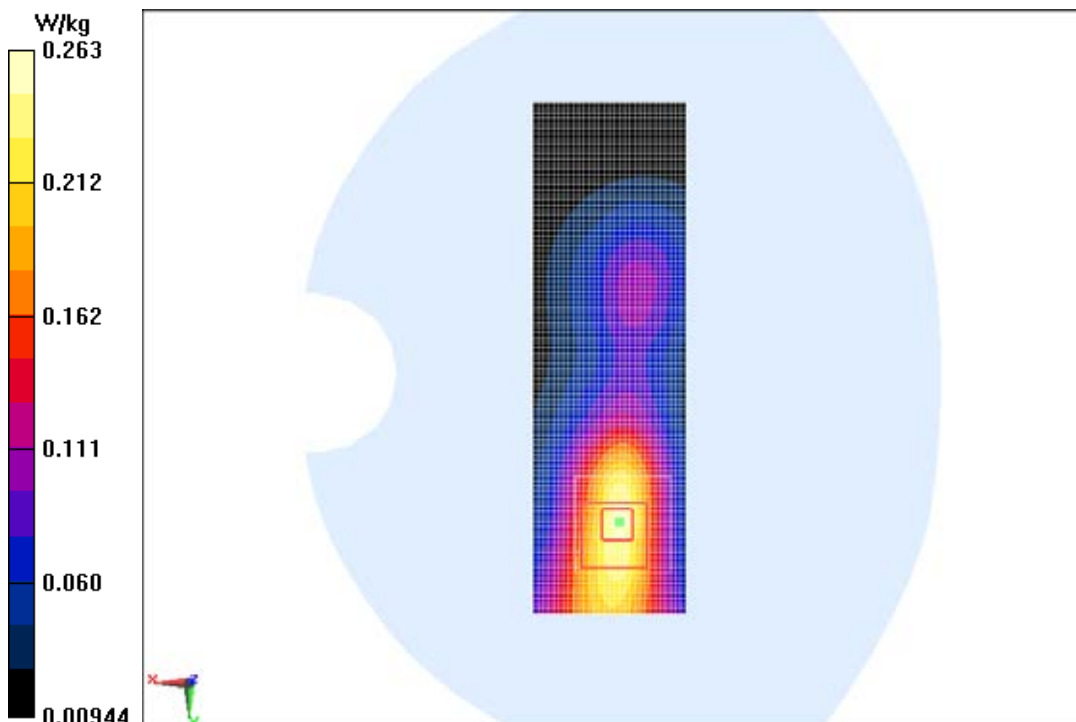

GPRS 1900MHz 4TS Right Mode Middle

Date/Time: 2014/4/29

Electronics: DAE4 Sn1244

Medium: Body 1900MHz

Medium parameters used: $f = 1880$ MHz; $\sigma = 1.504$ S/m; $\epsilon_r = 53.319$; $\rho = 1000$ kg/m³

Ambient Temperature: 22.5°C Liquid Temperature: 22.5°C

Communication System: GSM 1900MHz GPRS 4TS; Frequency: 1880 MHz; Duty Cycle: 1:2

Probe: ES3DV3 - SN3252ConvF(5.03, 5.03, 5.03); Calibrated: 8/5/2013

GPRS 1900MHz 4TS Right Mode Middle/Area Scan (61x181x1):

Measurement grid: dx=10 mm, dy=10 mm

Maximum value of SAR (Measurement) = 0.0167 W/kg

GPRS 1900MHz 4TS Right Mode Middle/Zoom Scan (7x7x7)/Cube 0:

Measurement grid: dx=5mm, dy=5mm, dz=5mm

Reference Value = 1.983 V/m; Power Drift = 0.01 dB

Peak SAR (extrapolated) = 0.0270 W/kg

SAR(1 g) = 0.015 W/kg; SAR(10 g) = 0.00934 W/kg

Maximum value of SAR (measured) = 0.0165 W/kg

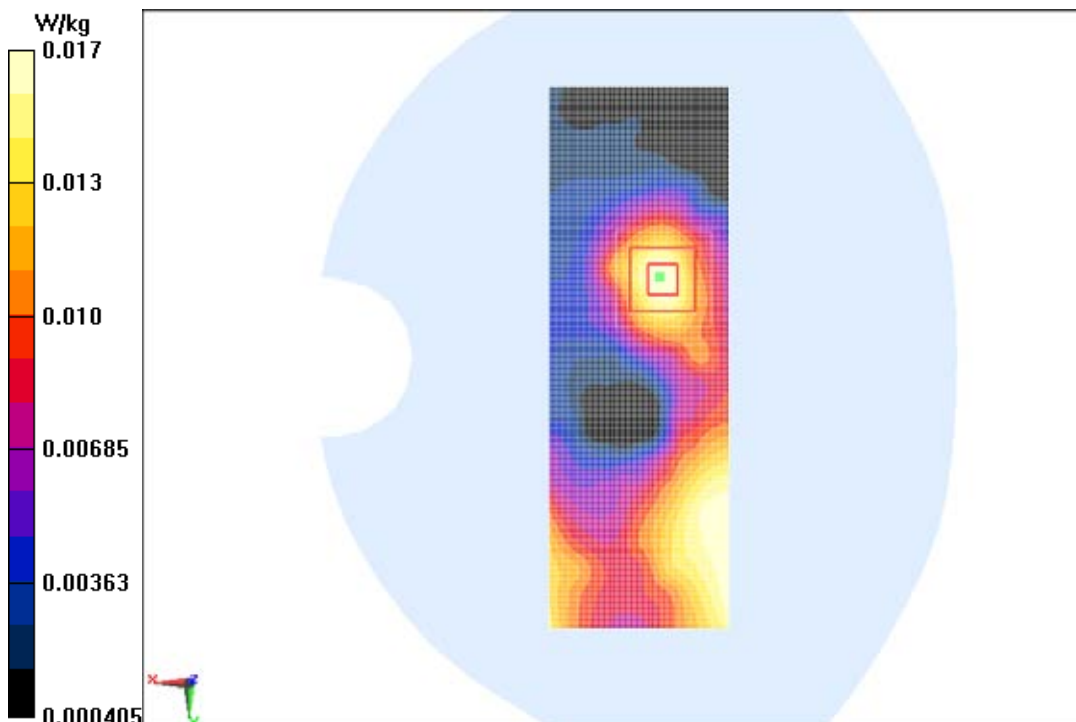

GPRS 1900MHz 4TS Bottom Mode Middle

Date/Time: 2014/4/29

Electronics: DAE4 Sn1244

Medium: Body 1900MHz

Medium parameters used: $f = 1880$ MHz; $\sigma = 1.504$ S/m; $\epsilon_r = 53.319$; $\rho = 1000$ kg/m³

Ambient Temperature: 22.5°C Liquid Temperature: 22.5°C

Communication System: GSM 1900MHz GPRS 4TS; Frequency: 1880 MHz; Duty Cycle: 1:2

Probe: ES3DV3 - SN3252ConvF(5.03, 5.03, 5.03); Calibrated: 8/5/2013

GPRS 1900MHz 4TS Bottom Mode Middle/Area Scan (41x71x1):

Measurement grid: dx=10 mm, dy=10 mm

Maximum value of SAR (Measurement) = 0.654 W/kg

GPRS 1900MHz 4TS Bottom Mode Middle/Zoom Scan (7x7x7)/Cube 0:

Measurement grid: dx=5mm, dy=5mm, dz=5mm

Reference Value = 19.305 V/m; Power Drift = -0.02 dB

Peak SAR (extrapolated) = 0.899 W/kg

SAR(1 g) = 0.570 W/kg; SAR(10 g) = 0.340 W/kg

Maximum value of SAR (measured) = 0.622 W/kg

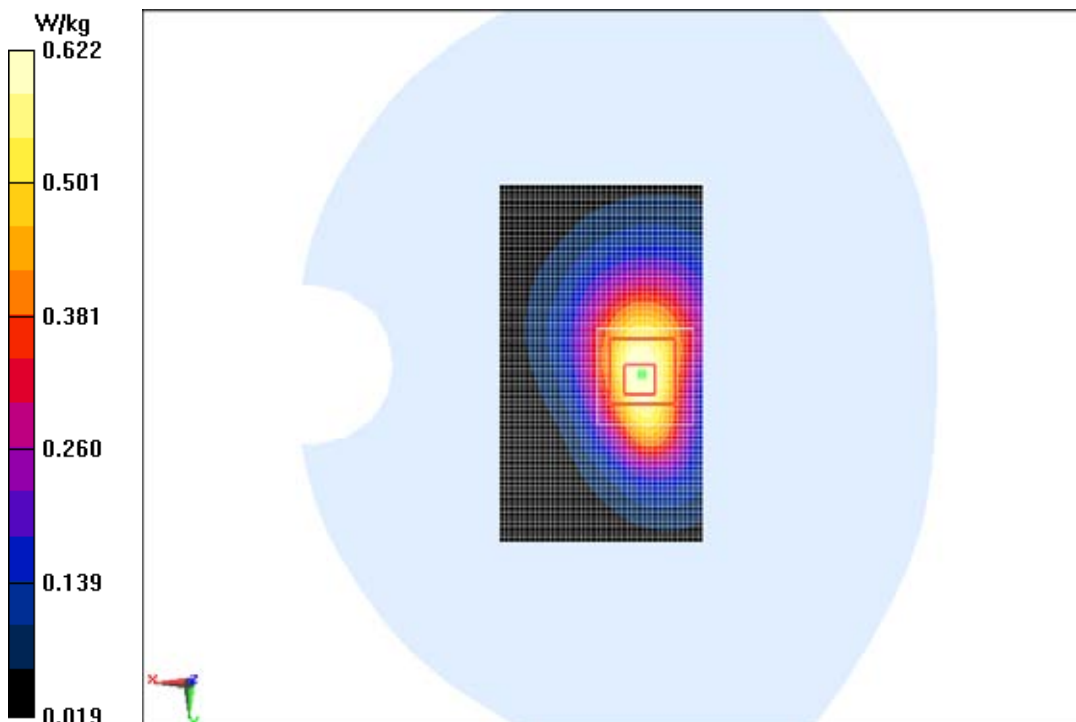

GPRS 1900MHz 4TS Bottom Mode Low

Date/Time: 2014/4/29

Electronics: DAE4 Sn1244

Medium: Body 1900MHz

Medium parameters used (interpolated): $f = 1850.2$ MHz; $\sigma = 1.475$ S/m; $\epsilon_r = 53.44$; $\rho = 1000$ kg/m³

Ambient Temperature: 22.5°C Liquid Temperature: 22.5°C

Communication System: GSM 1900MHz GPRS 4TS (0); Frequency: 1850.2 MHz; Duty Cycle: 1:2

Probe: ES3DV3 - SN3252ConvF(5.03, 5.03, 5.03); Calibrated: 8/5/2013

GPRS 1900MHz 4TS Bottom Mode Low/Area Scan (41x71x1):

Measurement grid: dx=10 mm, dy=10 mm

Maximum value of SAR (Measurement) = 0.581 W/kg

GPRS 1900MHz 4TS Bottom Mode Low/Zoom Scan (7x7x7)/Cube 0:

Measurement grid: dx=5mm, dy=5mm, dz=5mm

Reference Value = 16.991 V/m; Power Drift = 0.07 dB

Peak SAR (extrapolated) = 0.783 W/kg

SAR(1 g) = 0.500 W/kg; SAR(10 g) = 0.299 W/kg

Maximum value of SAR (measured) = 0.546 W/kg

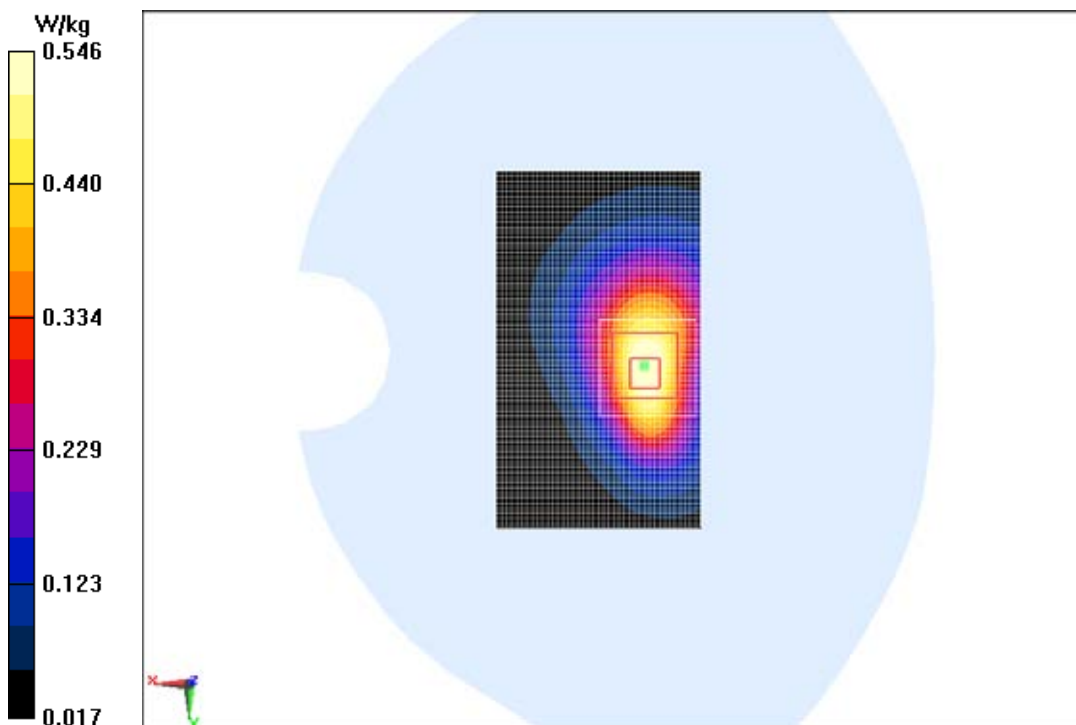

GPRS 1900MHz 4TS Bottom Mode High

Date/Time: 2014/4/29

Electronics: DAE4 Sn1244

Medium: Body 1900MHz

Medium parameters used: $f = 1910$ MHz; $\sigma = 1.534$ S/m; $\epsilon_r = 53.187$; $\rho = 1000$ kg/m³

Ambient Temperature: 22.5°C Liquid Temperature: 22.5°C

Communication System: GSM 1900MHz GPRS 4TS (0); Frequency: 1909.8 MHz; Duty Cycle: 1:2

Probe: ES3DV3 - SN3252ConvF(5.03, 5.03, 5.03); Calibrated: 8/5/2013

GPRS 1900MHz 4TS Bottom Mode High/Area Scan (41x71x1):

Measurement grid: dx=10 mm, dy=10 mm

Maximum value of SAR (Measurement) = 0.775 W/kg

GPRS 1900MHz 4TS Bottom Mode High/Zoom Scan (7x7x7)/Cube 0:

Measurement grid: dx=5mm, dy=5mm, dz=5mm

Reference Value = 18.159 V/m; Power Drift = 0.05 dB

Peak SAR (extrapolated) = 1.08 W/kg

SAR(1 g) = 0.667 W/kg; SAR(10 g) = 0.392 W/kg

Maximum value of SAR (measured) = 0.718 W/kg

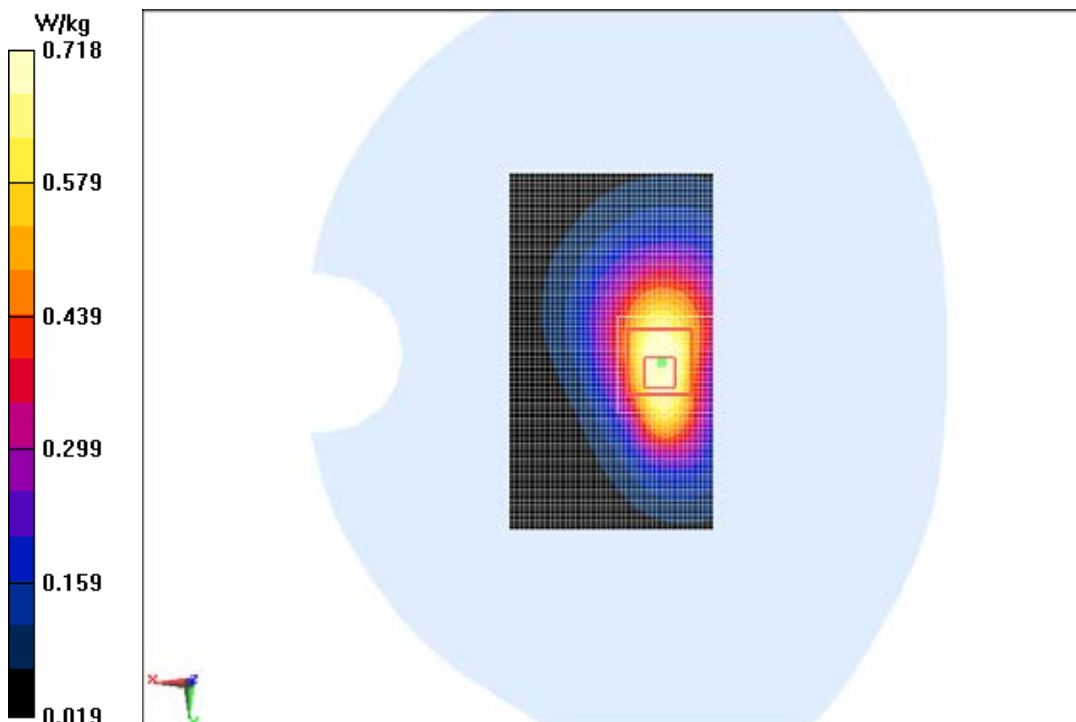

GPRS 1900MHz 4TS Bottom Mode High With Headset

Date/Time: 2014/4/29

Electronics: DAE4 Sn1244

Medium: Body 1900MHz

Medium parameters used: $f = 1910$ MHz; $\sigma = 1.534$ S/m; $\epsilon_r = 53.187$; $\rho = 1000$ kg/m³

Ambient Temperature:22.5°C Liquid Temperature:22.5°C

Communication System: GSM Professional 1900MHz; Frequency: 1909.8 MHz; Duty Cycle: 1:8.3

Probe: ES3DV3 - SN3252ConvF(5.03, 5.03, 5.03); Calibrated: 8/5/2013

GPRS 1900MHz 4TS Bottom Mode High With Headset/Area Scan (41x71x1):

Measurement grid: dx=10 mm, dy=10 mm

Maximum value of SAR (Measurement) = 0.426 W/kg

GPRS 1900MHz 4TS Bottom Mode High With Headset/Zoom Scan (7x7x7)/Cube 0:

Measurement grid: dx=5mm, dy=5mm, dz=5mm

Reference Value = 14.728 V/m; Power Drift = -0.18 dB

Peak SAR (extrapolated) = 0.600 W/kg

SAR(1 g) = 0.375 W/kg; SAR(10 g) = 0.224 W/kg

Maximum value of SAR (measured) = 0.405 W/kg

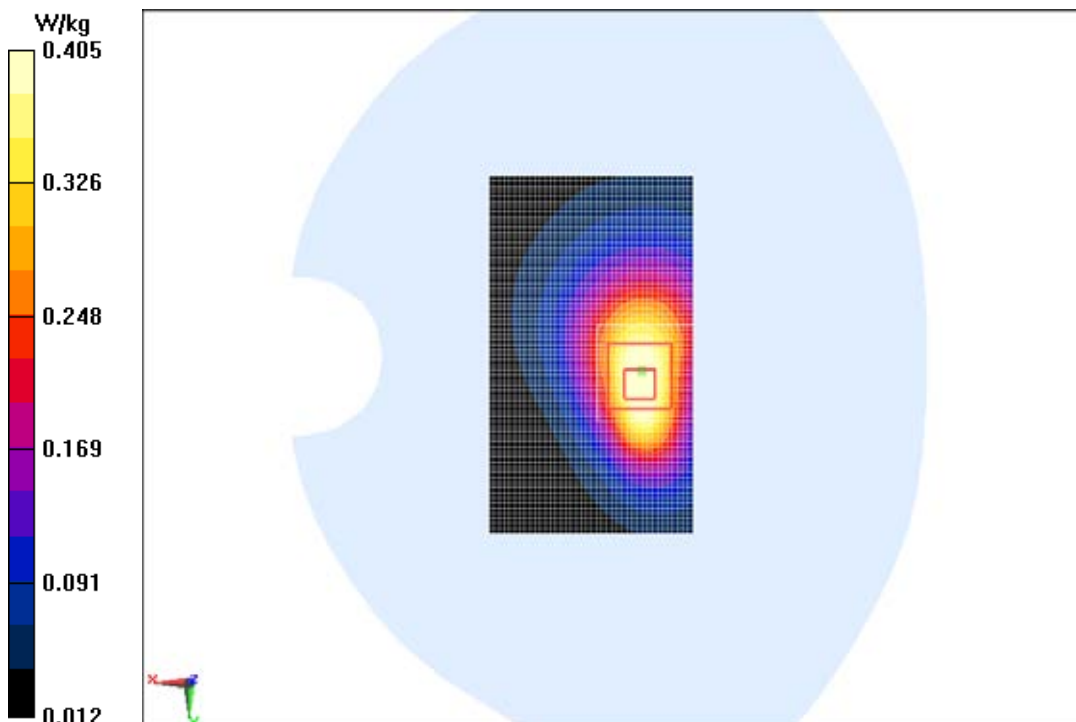

GPRS 1900MHz 4TS Bottom Mode High SIM2

Date/Time: 2014/4/29

Electronics: DAE4 Sn1244

Medium: Body 1900MHz

Medium parameters used: $f = 1910$ MHz; $\sigma = 1.534$ S/m; $\epsilon_r = 53.187$; $\rho = 1000$ kg/m³

Ambient Temperature:22.5°C Liquid Temperature:22.5°C

Communication System: GSM 1900MHz GPRS 4TS (0); Frequency: 1909.8 MHz; Duty Cycle: 1:2

Probe: ES3DV3 - SN3252ConvF(5.03, 5.03, 5.03); Calibrated: 8/5/2013

GPRS 1900MHz 4TS Bottom Mode High SIM2/Area Scan (41x71x1):

Measurement grid: dx=10 mm, dy=10 mm

Maximum value of SAR (Measurement) = 0.691 W/kg

GPRS 1900MHz 4TS Bottom Mode High SIM2/Zoom Scan (7x7x7)/Cube 0:

Measurement grid: dx=5mm, dy=5mm, dz=5mm

Reference Value = 18.763 V/m; Power Drift = 0.09 dB

Peak SAR (extrapolated) = 0.977 W/kg

SAR(1 g) = 0.614 W/kg; SAR(10 g) = 0.366 W/kg

Maximum value of SAR (measured) = 0.667 W/kg

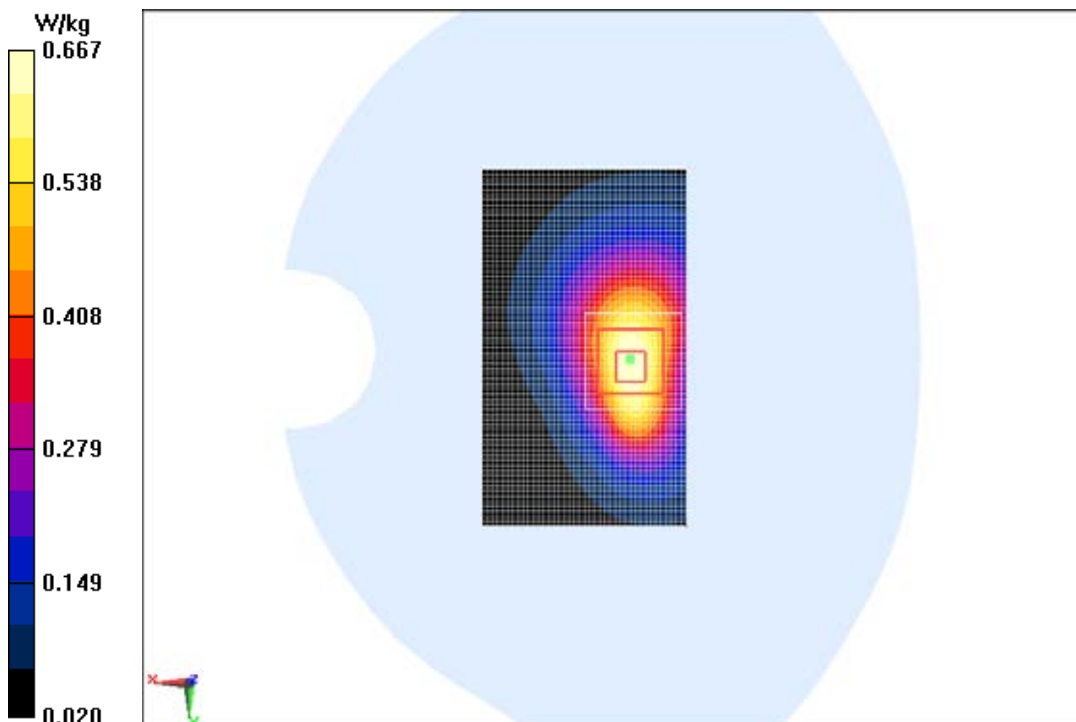

WCDMA Band5 Left Cheek Middle

Date/Time: 2014/4/25

Electronics: DAE4 Sn1244

Medium: Head 850MHz

Medium parameters used: $f = 837 \text{ MHz}$; $\sigma = 0.919 \text{ S/m}$; $\epsilon_r = 40.986$; $\rho = 1000 \text{ kg/m}^3$ Ambient Temperature: 22.5°C Liquid Temperature: 22.5°C Communication System: WCDMA Band V; Frequency: 836.6 MHz ; Duty Cycle: 1:1

Probe: ES3DV3 - SN3252ConvF(6.1, 6.1, 6.1); Calibrated: 8/5/2013

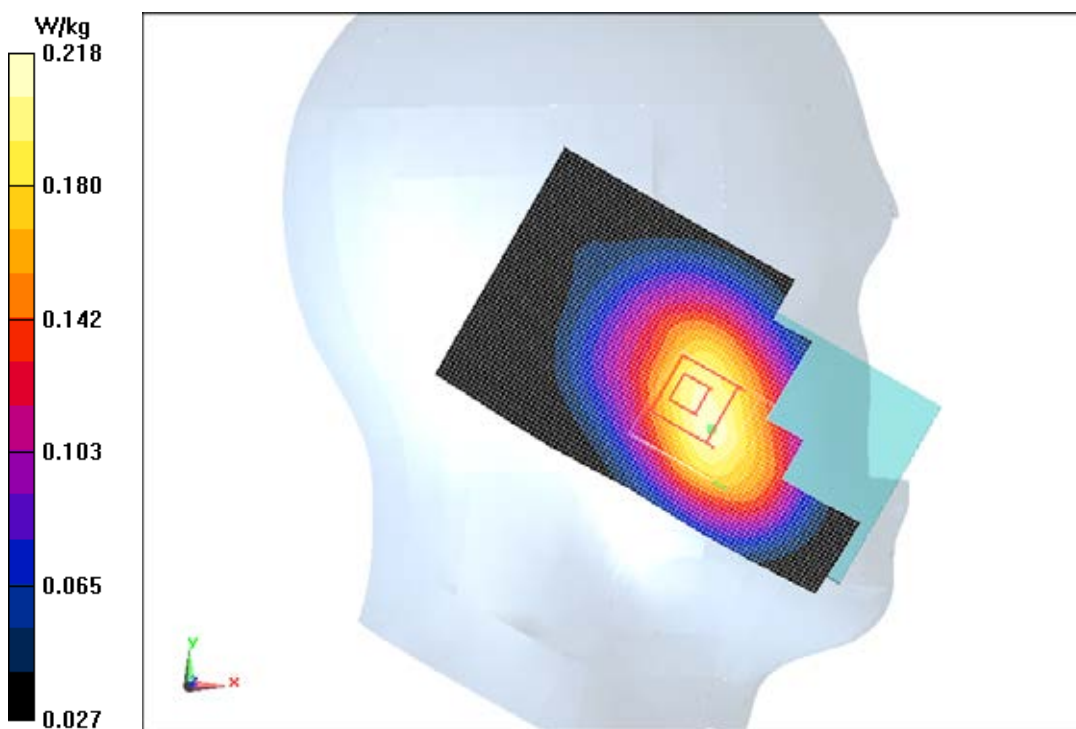
WCDMA Band5 Left Cheek Middle/Area Scan (111x61x1):Measurement grid: $dx=10 \text{ mm}$, $dy=10 \text{ mm}$ Maximum value of SAR (Measurement) = 0.216 W/kg **WCDMA Band5 Left Cheek Middle/Zoom Scan (7x7x7)/Cube 0:**Measurement grid: $dx=5\text{mm}$, $dy=5\text{mm}$, $dz=5\text{mm}$ Reference Value = 5.656 V/m ; Power Drift = 0.11 dB Peak SAR (extrapolated) = 0.266 W/kg SAR(1 g) = 0.208 W/kg ; SAR(10 g) = 0.155 W/kg Maximum of SAR (measured) = 0.218 W/kg 

WCDMA Band5 Left Tilt Middle

Date/Time: 2014/4/25

Electronics: DAE4 Sn1244

Medium: Head 850MHz

Medium parameters used: $f = 837 \text{ MHz}$; $\sigma = 0.919 \text{ S/m}$; $\epsilon_r = 40.986$; $\rho = 1000 \text{ kg/m}^3$

Ambient Temperature: 22.5°C Liquid Temperature: 22.5°C

Communication System: WCDMA Band V; Frequency: 836.6 MHz ; Duty Cycle: 1:1

Probe: ES3DV3 - SN3252ConvF(6.1, 6.1, 6.1); Calibrated: 8/5/2013

WCDMA Band5 Left Tilt Middle/Area Scan (11x61x1):

Measurement grid: $dx=10 \text{ mm}$, $dy=10 \text{ mm}$

Maximum value of SAR (Measurement) = 0.143 W/kg

WCDMA Band5 Left Tilt Middle/Zoom Scan (7x7x7)/Cube 0:

Measurement grid: $dx=5\text{mm}$, $dy=5\text{mm}$, $dz=5\text{mm}$

Reference Value = 9.313 V/m ; Power Drift = 0.06 dB

Peak SAR (extrapolated) = 0.162 W/kg

SAR(1 g) = 0.140 W/kg ; SAR(10 g) = 0.109 W/kg

Maximum value of SAR (measured) = 0.147 W/kg

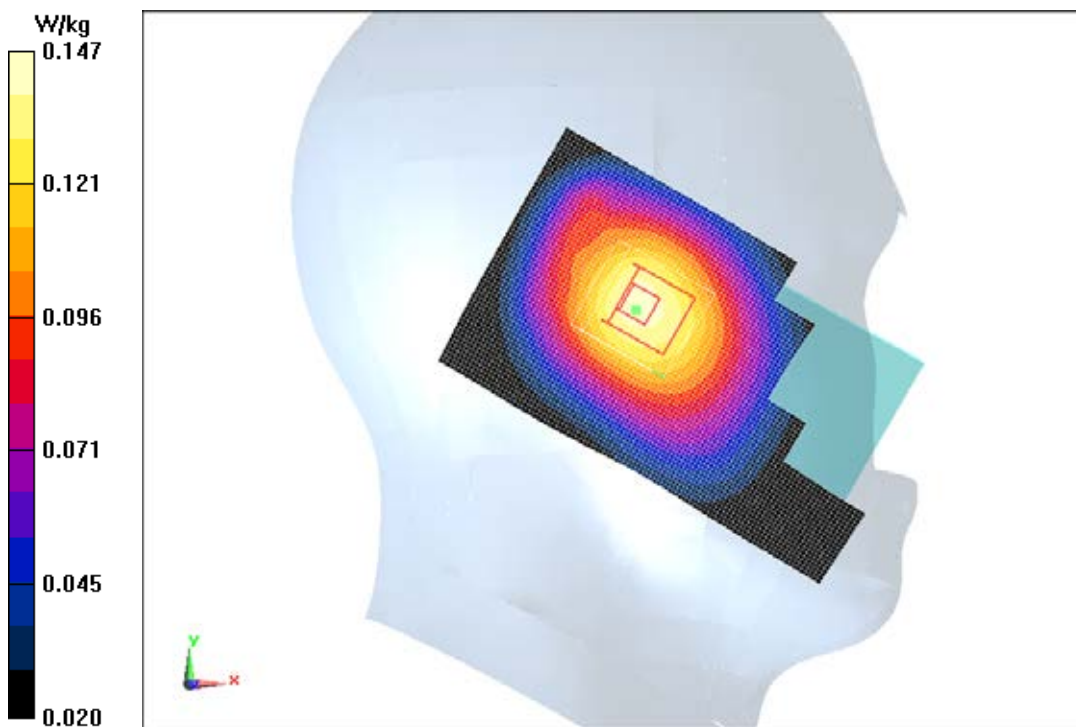

WCDMA Band5 Right Cheek Middle

Date/Time: 2014/4/25

Electronics: DAE4 Sn1244

Medium: Head 850MHz

Medium parameters used: $f = 837 \text{ MHz}$; $\sigma = 0.919 \text{ S/m}$; $\epsilon_r = 40.986$; $\rho = 1000 \text{ kg/m}^3$

Ambient Temperature: 22.5°C Liquid Temperature: 22.5°C

Communication System: WCDMA Band V; Frequency: 836.6 MHz ; Duty Cycle: 1:1

Probe: ES3DV3 - SN3252ConvF(6.1, 6.1, 6.1); Calibrated: 8/5/2013

WCDMA Band5 Right Cheek Middle/Area Scan (111x61x1):

Measurement grid: $dx=10 \text{ mm}$, $dy=10 \text{ mm}$

Maximum value of SAR (Measurement) = 0.183 W/kg

WCDMA Band5 Right Cheek Middle/Zoom Scan (7x7x7)/Cube 0:

Measurement grid: $dx=5\text{mm}$, $dy=5\text{mm}$, $dz=5\text{mm}$

Reference Value = 5.563 V/m ; Power Drift = 0.01 dB

Peak SAR (extrapolated) = 0.212 W/kg

SAR(1 g) = 0.177 W/kg ; SAR(10 g) = 0.134 W/kg

Maximum value of SAR (measured) = 0.185 W/kg

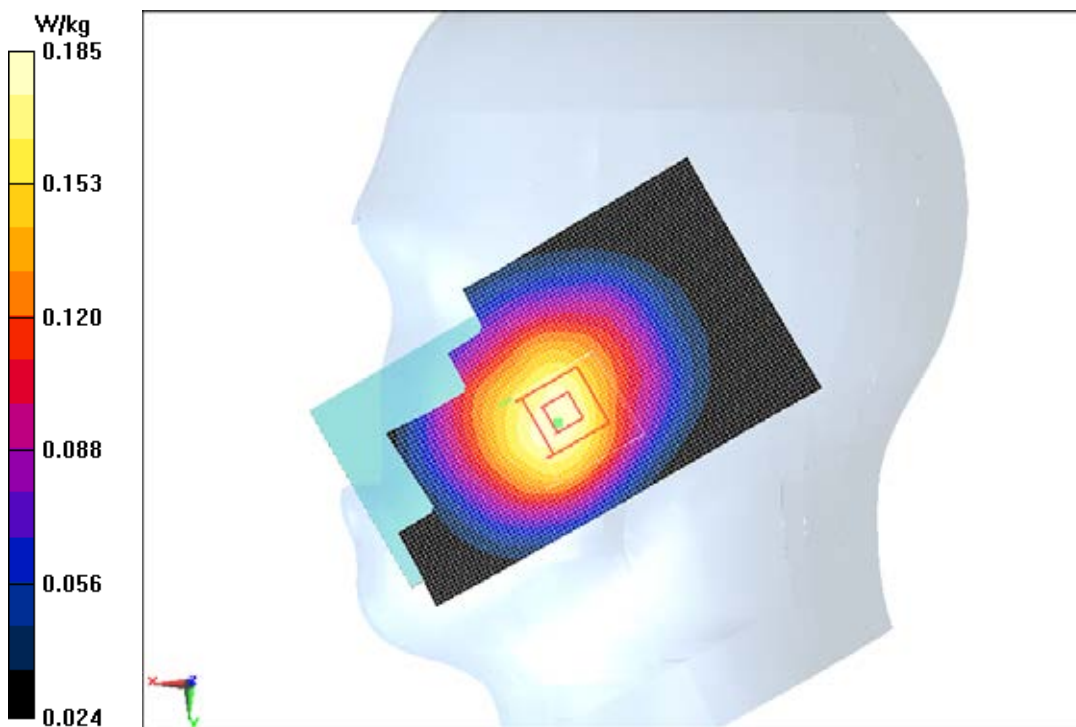

WCDMA Band5 Right Tilt Middle

Date/Time: 2014/4/25

Electronics: DAE4 Sn1244

Medium: Head 850MHz

Medium parameters used: $f = 837$ MHz; $\sigma = 0.919$ S/m; $\epsilon_r = 40.986$; $\rho = 1000$ kg/m³

Ambient Temperature: 22.5°C Liquid Temperature: 22.5°C

Communication System: WCDMA Band V; Frequency: 836.6 MHz; Duty Cycle: 1:1

Probe: ES3DV3 - SN3252ConvF(6.1, 6.1, 6.1); Calibrated: 8/5/2013

WCDMA Band5 Right Tilt Middle/Area Scan (111x61x1):

Measurement grid: dx=10 mm, dy=10 mm

Maximum value of SAR (Measurement) = 0.151 W/kg

WCDMA Band5 Right Tilt Middle/Zoom Scan (7x7x7)/Cube 0:

Measurement grid: dx=5mm, dy=5mm, dz=5mm

Reference Value = 9.713 V/m; Power Drift = 0.17 dB

Peak SAR (extrapolated) = 0.169 W/kg

SAR(1 g) = 0.146 W/kg; SAR(10 g) = 0.113 W/kg

Maximum value of SAR (measured) = 0.152 W/kg

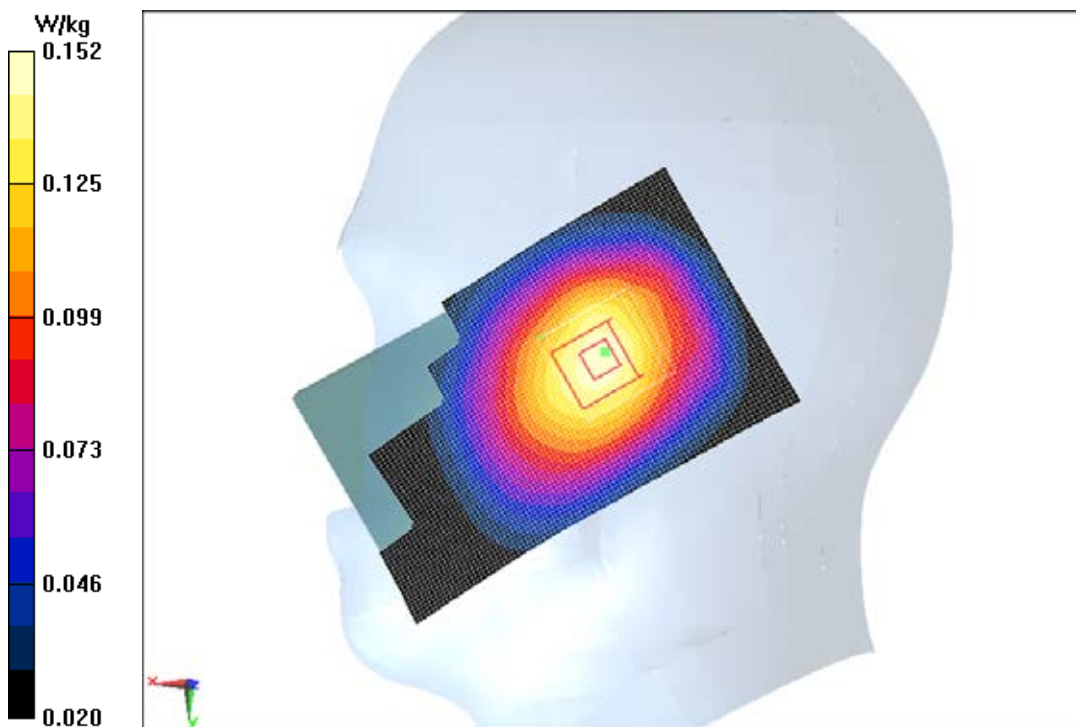

WCDMA Band5 Left Cheek Low

Date/Time: 2014/4/25

Electronics: DAE4 Sn1244

Medium: Head 850MHz

Medium parameters used (interpolated): $f = 826.4$ MHz; $\sigma = 0.911$ S/m; $\epsilon_r = 41.264$; $\rho = 1000$ kg/m³

Ambient Temperature: 22.5°C Liquid Temperature: 22.5°C

Communication System: WCDMA Band V; Frequency: 826.4 MHz; Duty Cycle: 1:1

Probe: ES3DV3 - SN3252ConvF(6.1, 6.1, 6.1); Calibrated: 8/5/2013

WCDMA Band5 Left Cheek Low/Area Scan (111x61x1):

Measurement grid: dx=10 mm, dy=10 mm

Maximum value of SAR (Measurement) = 0.210 W/kg

WCDMA Band5 Left Cheek Low/Zoom Scan (7x7x7)/Cube 0:

Measurement grid: dx=5mm, dy=5mm, dz=5mm

Reference Value = 5.414 V/m; Power Drift = 0.09 dB

Peak SAR (extrapolated) = 0.252 W/kg

SAR(1 g) = 0.199 W/kg; SAR(10 g) = 0.148 W/kg

Maximum of SAR (measured) = 0.207 W/kg

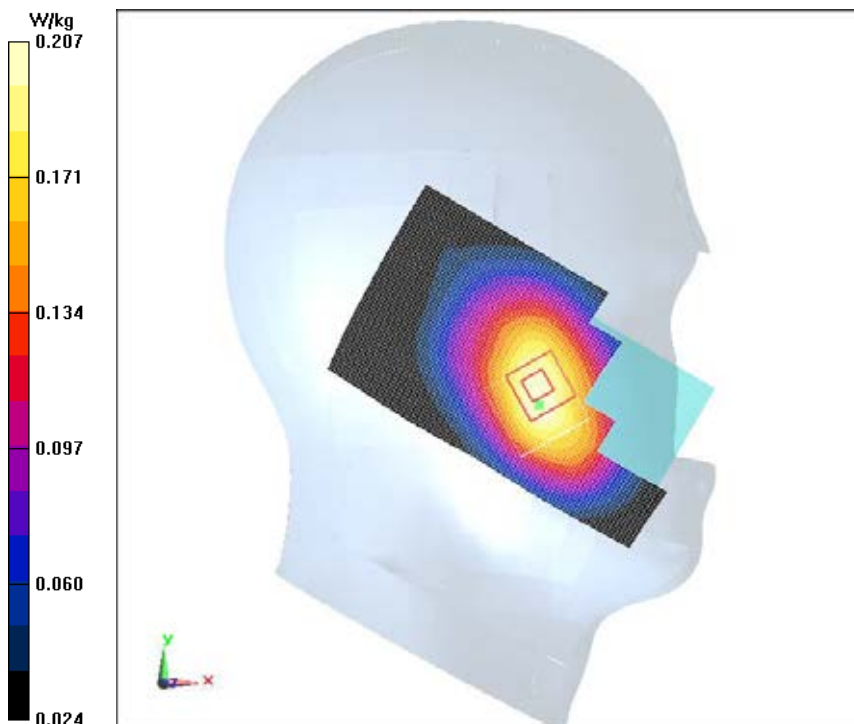

WCDMA Band5 Left Cheek High

Date/Time: 2014/4/25

Electronics: DAE4 Sn1244

Medium: Head 850MHz

Medium parameters used: $f = 847$ MHz; $\sigma = 0.927$ S/m; $\epsilon_r = 40.809$; $\rho = 1000$ kg/m³

Ambient Temperature: 22.5°C Liquid Temperature: 22.5°C

Communication System: WCDMA Band V; Frequency: 846.6 MHz; Duty Cycle: 1:1

Probe: ES3DV3 - SN3252ConvF(6.1, 6.1, 6.1); Calibrated: 8/5/2013

WCDMA Band5 Left Cheek High/Area Scan (11x61x1):

Measurement grid: dx=10 mm, dy=10 mm

Maximum value of SAR (Measurement) = 0.305 W/kg

WCDMA Band5 Left Cheek High/Zoom Scan (7x7x7)/Cube 0:

Measurement grid: dx=5mm, dy=5mm, dz=5mm

Reference Value = 6.464 V/m; Power Drift = 0.13 dB

Peak SAR (extrapolated) = 0.385 W/kg

SAR(1 g) = 0.293 W/kg; SAR(10 g) = 0.216 W/kg

Maximum of SAR (measured) = 0.306 W/kg

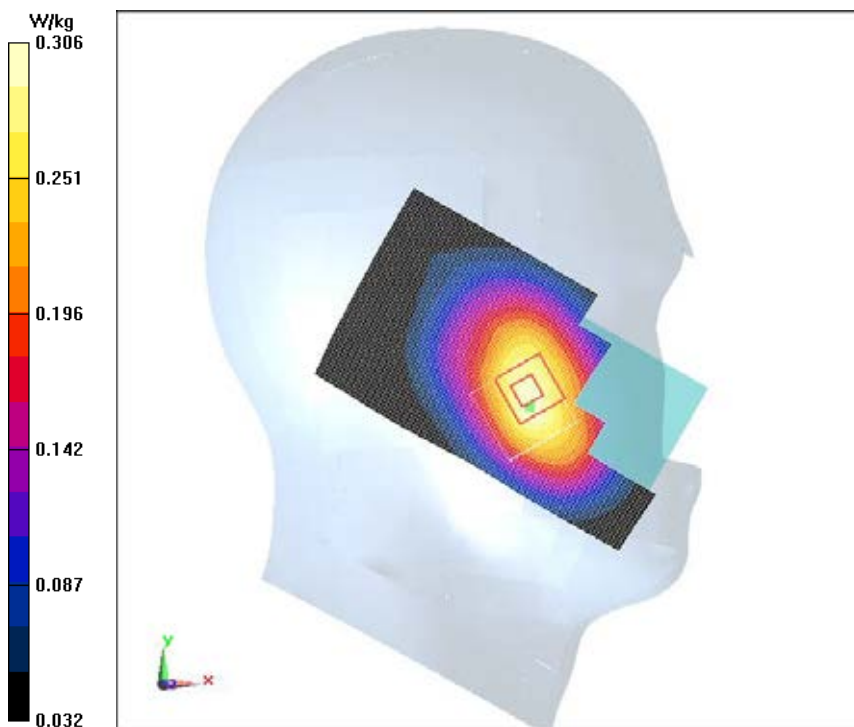

WCDMA Band5 Phantom Mode Middle

Date/Time: 2014/4/26

Electronics: DAE4 Sn1244

Medium: Body 850MHz

Medium parameters used: $f = 837 \text{ MHz}$; $\sigma = 1.001 \text{ S/m}$; $\epsilon_r = 55.152$; $\rho = 1000 \text{ kg/m}^3$

Ambient Temperature: 22.5°C Liquid Temperature: 22.5°C

Communication System: WCDMA Band V; Frequency: 836.6 MHz ; Duty Cycle: 1:1

Probe: ES3DV3 - SN3252ConvF(6.14, 6.14, 6.14); Calibrated: 8/5/2013

WCDMA Band5 Phantom Mode Middle/Area Scan (61x111x1):

Measurement grid: $dx=10 \text{ mm}$, $dy=10 \text{ mm}$

Maximum value of SAR (Measurement) = 0.326 W/kg

WCDMA Band5 Phantom Mode Middle/Zoom Scan (7x7x7)/Cube 0:

Measurement grid: $dx=5\text{mm}$, $dy=5\text{mm}$, $dz=5\text{mm}$

Reference Value = 17.911 V/m ; Power Drift = -0.00 dB

Peak SAR (extrapolated) = 0.371 W/kg

SAR(1 g) = 0.313 W/kg ; SAR(10 g) = 0.244 W/kg

Maximum value of SAR (measured) = 0.328 W/kg

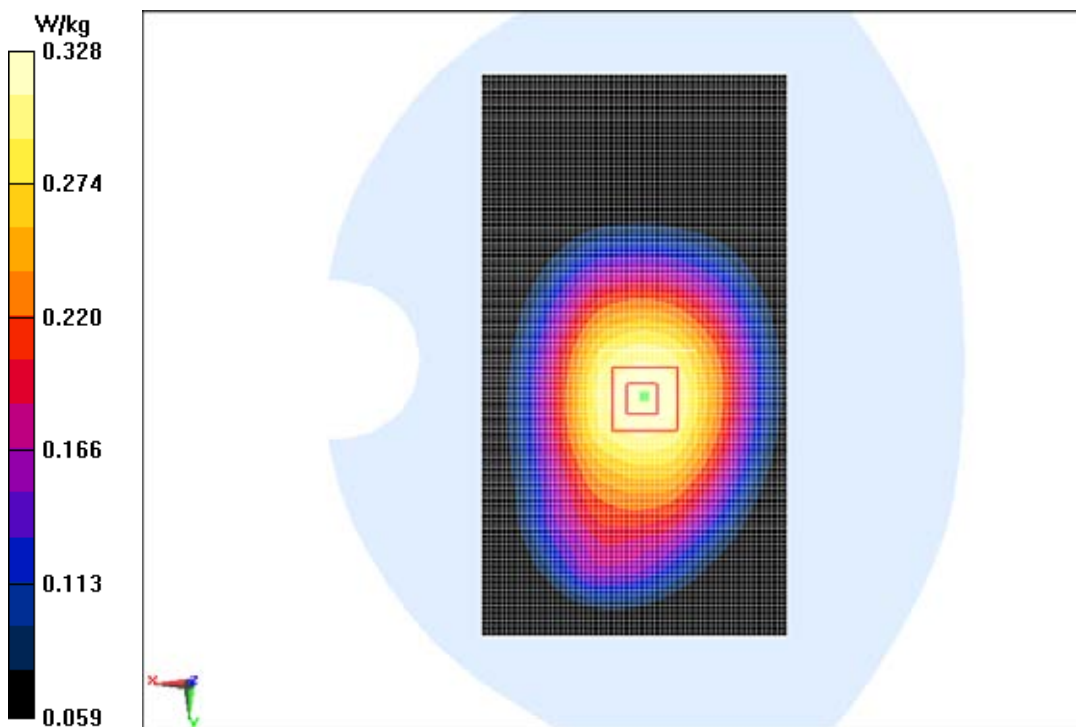

WCDMA Band5 Ground Mode Middle

Date/Time: 2014/4/26

Electronics: DAE4 Sn1244

Medium: Body 850MHz

Medium parameters used: $f = 837 \text{ MHz}$; $\sigma = 1.001 \text{ S/m}$; $\epsilon_r = 55.152$; $\rho = 1000 \text{ kg/m}^3$

Ambient Temperature: 22.5°C Liquid Temperature: 22.5°C

Communication System: WCDMA Band V; Frequency: 836.6 MHz ; Duty Cycle: 1:1

Probe: ES3DV3 - SN3252ConvF(6.14, 6.14, 6.14); Calibrated: 8/5/2013

WCDMA Band5 Ground Mode Middle/Area Scan (61x111x1):

Measurement grid: $dx=10 \text{ mm}$, $dy=10 \text{ mm}$

Maximum value of SAR (Measurement) = 0.393 W/kg

WCDMA Band5 Ground Mode Middle/Zoom Scan (7x7x7)/Cube 0:

Measurement grid: $dx=5\text{mm}$, $dy=5\text{mm}$, $dz=5\text{mm}$

Reference Value = 19.841 V/m ; Power Drift = 0.02 dB

Peak SAR (extrapolated) = 0.444 W/kg

SAR(1 g) = 0.375 W/kg ; SAR(10 g) = 0.292 W/kg

Maximum value of SAR (measured) = 0.392 W/kg

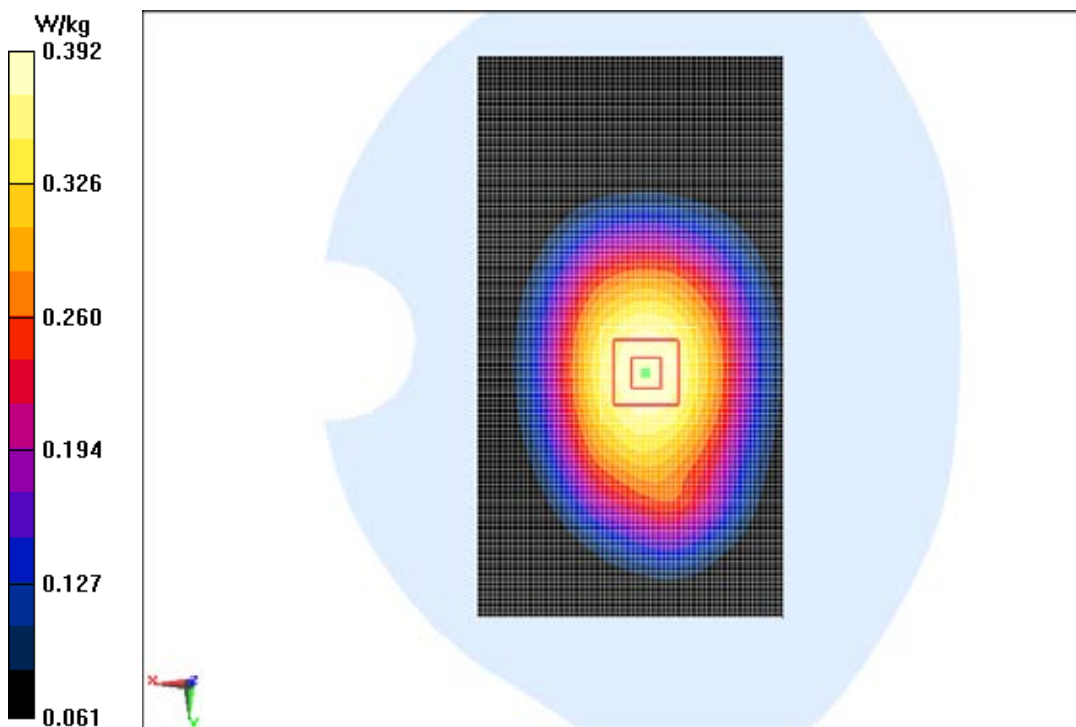

WCDMA Band5 Right Mode Middle

Date/Time: 2014/4/26

Electronics: DAE4 Sn1244

Medium: Body 850MHz

Medium parameters used: $f = 837 \text{ MHz}$; $\sigma = 1.001 \text{ S/m}$; $\epsilon_r = 55.152$; $\rho = 1000 \text{ kg/m}^3$

Ambient Temperature: 22.5°C Liquid Temperature: 22.5°C

Communication System: WCDMA Band V; Frequency: 836.6 MHz ; Duty Cycle: 1:1

Probe: ES3DV3 - SN3252ConvF(6.14, 6.14, 6.14); Calibrated: 8/5/2013

WCDMA Band5 Right Mode Middle/Area Scan (31x111x1):

Measurement grid: $dx=10 \text{ mm}$, $dy=10 \text{ mm}$

Maximum value of SAR (Measurement) = 0.271 W/kg

WCDMA Band5 Right Mode Middle/Zoom Scan (7x7x7)/Cube 0:

Measurement grid: $dx=5\text{mm}$, $dy=5\text{mm}$, $dz=5\text{mm}$

Reference Value = 16.595 V/m ; Power Drift = -0.00 dB

Peak SAR (extrapolated) = 0.337 W/kg

SAR(1 g) = 0.255 W/kg ; SAR(10 g) = 0.182 W/kg

Maximum value of SAR (measured) = 0.271 W/kg

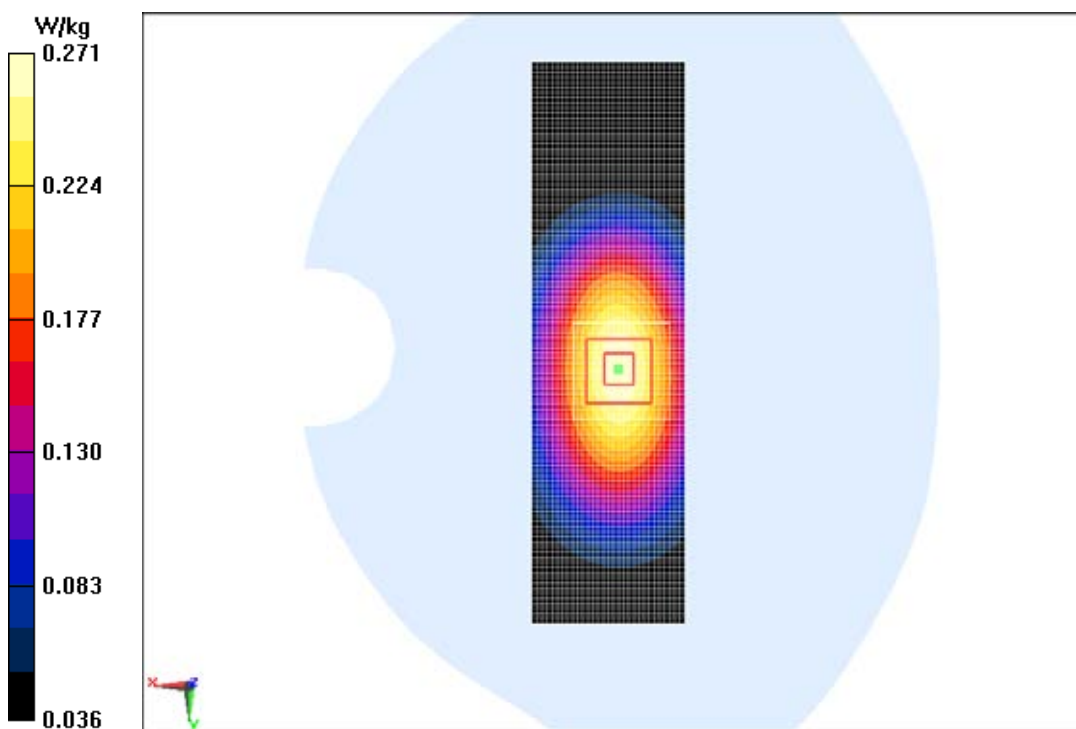

WCDMA Band5 Left Mode Middle

Date/Time: 2014/4/26

Electronics: DAE4 Sn1244

Medium: Body 850MHz

Medium parameters used: $f = 837 \text{ MHz}$; $\sigma = 1.001 \text{ S/m}$; $\epsilon_r = 55.152$; $\rho = 1000 \text{ kg/m}^3$

Ambient Temperature: 22.5°C Liquid Temperature: 22.5°C

Communication System: WCDMA Band V; Frequency: 836.6 MHz ; Duty Cycle: 1:1

Probe: ES3DV3 - SN3252ConvF(6.14, 6.14, 6.14); Calibrated: 8/5/2013

WCDMA Band5 Left Mode Middle/Area Scan (31x111x1):

Measurement grid: $dx=10 \text{ mm}$, $dy=10 \text{ mm}$

Maximum value of SAR (Measurement) = 0.327 W/kg

WCDMA Band5 Left Mode Middle/Zoom Scan (7x7x7)/Cube 0:

Measurement grid: $dx=5\text{mm}$, $dy=5\text{mm}$, $dz=5\text{mm}$

Reference Value = 17.995 V/m ; Power Drift = 0.05 dB

Peak SAR (extrapolated) = 0.405 W/kg

SAR(1 g) = 0.307 W/kg ; SAR(10 g) = 0.219 W/kg

Maximum value of SAR (measured) = 0.327 W/kg

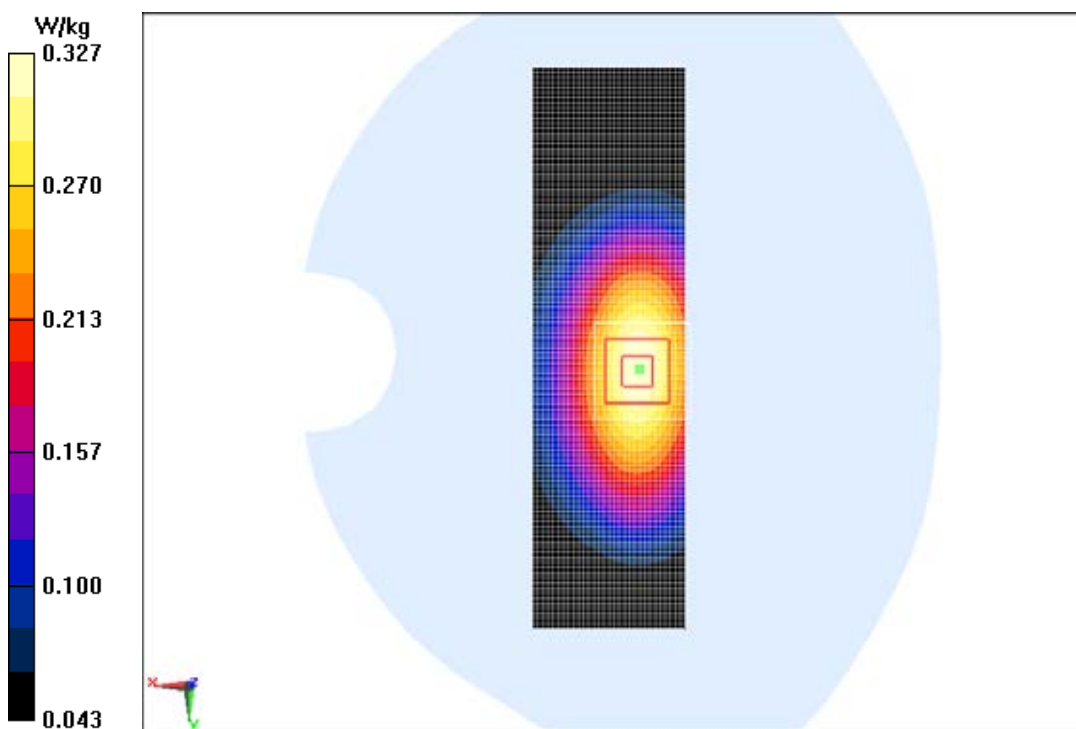

WCDMA Band5 Bottom Mode Middle

Date/Time: 2014/4/26

Electronics: DAE4 Sn1244

Medium: Body 850MHz

Medium parameters used: $f = 837 \text{ MHz}$; $\sigma = 1.001 \text{ S/m}$; $\epsilon_r = 55.152$; $\rho = 1000 \text{ kg/m}^3$

Ambient Temperature: 22.5°C Liquid Temperature: 22.5°C

Communication System: WCDMA Band V; Frequency: 836.6 MHz ; Duty Cycle: 1:1

Probe: ES3DV3 - SN3252ConvF(6.14, 6.14, 6.14); Calibrated: 8/5/2013

WCDMA Band5 Bottom Mode Middle/Area Scan (31x61x1):

Measurement grid: $dx=10 \text{ mm}$, $dy=10 \text{ mm}$

Maximum value of SAR (Measurement) = 0.126 W/kg

WCDMA Band5 Bottom Mode Middle/Zoom Scan (7x7x7)/Cube 0:

Measurement grid: $dx=5\text{mm}$, $dy=5\text{mm}$, $dz=5\text{mm}$

Reference Value = 10.509 V/m ; Power Drift = -0.05 dB

Peak SAR (extrapolated) = 0.185 W/kg

SAR(1 g) = 0.105 W/kg ; SAR(10 g) = 0.064 W/kg

Maximum value of SAR (measured) = 0.114 W/kg

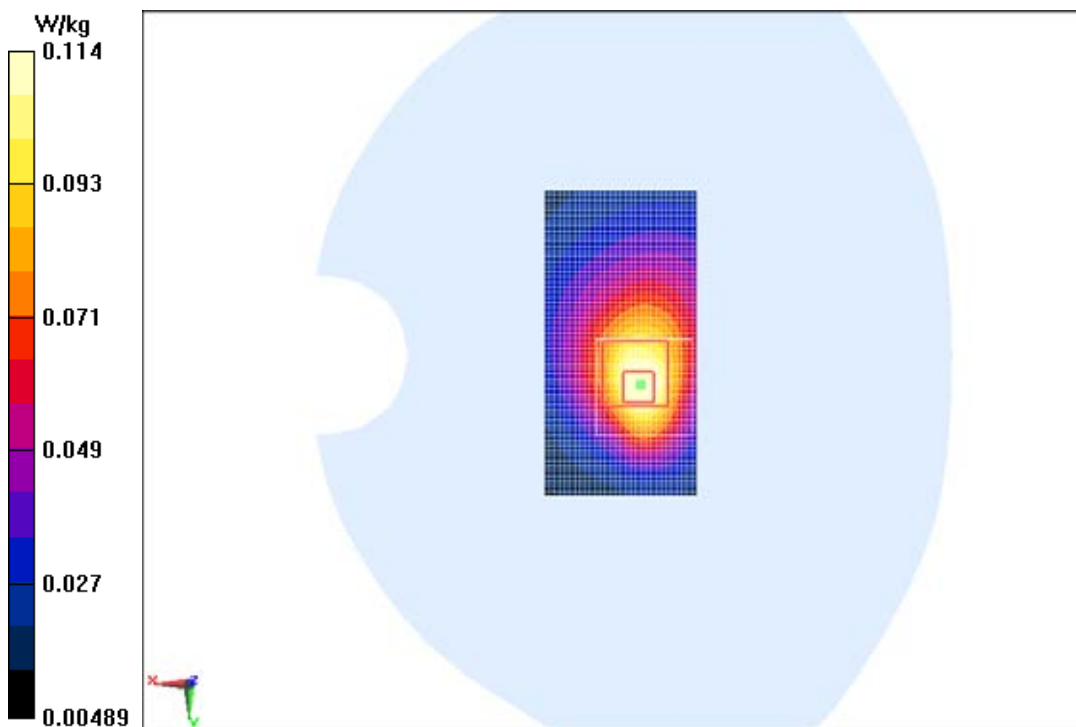

WCDMA Band5 Ground Mode Low

Date/Time: 2014/4/26

Electronics: DAE4 Sn1244

Medium: Body 850MHz

Medium parameters used (interpolated): $f = 826.4$ MHz; $\sigma = 0.994$ S/m; $\epsilon_r = 55.147$; $\rho = 1000$ kg/m³

Ambient Temperature: 22.5°C Liquid Temperature: 22.5°C

Communication System: WCDMA Band V; Frequency: 826.4 MHz; Duty Cycle: 1:1

Probe: ES3DV3 - SN3252ConvF(6.14, 6.14, 6.14); Calibrated: 8/5/2013

WCDMA Band5 Ground Mode Low/Area Scan (61x111x1):

Measurement grid: dx=10 mm, dy=10 mm

Maximum value of SAR (Measurement) = 0.382 W/kg

WCDMA Band5 Ground Mode Low/Zoom Scan (7x7x7)/Cube 0:

Measurement grid: dx=5mm, dy=5mm, dz=5mm

Reference Value = 19.578 V/m; Power Drift = -0.00 dB

Peak SAR (extrapolated) = 0.430 W/kg

SAR(1 g) = 0.363 W/kg; SAR(10 g) = 0.283 W/kg

Maximum value of SAR (measured) = 0.380 W/kg

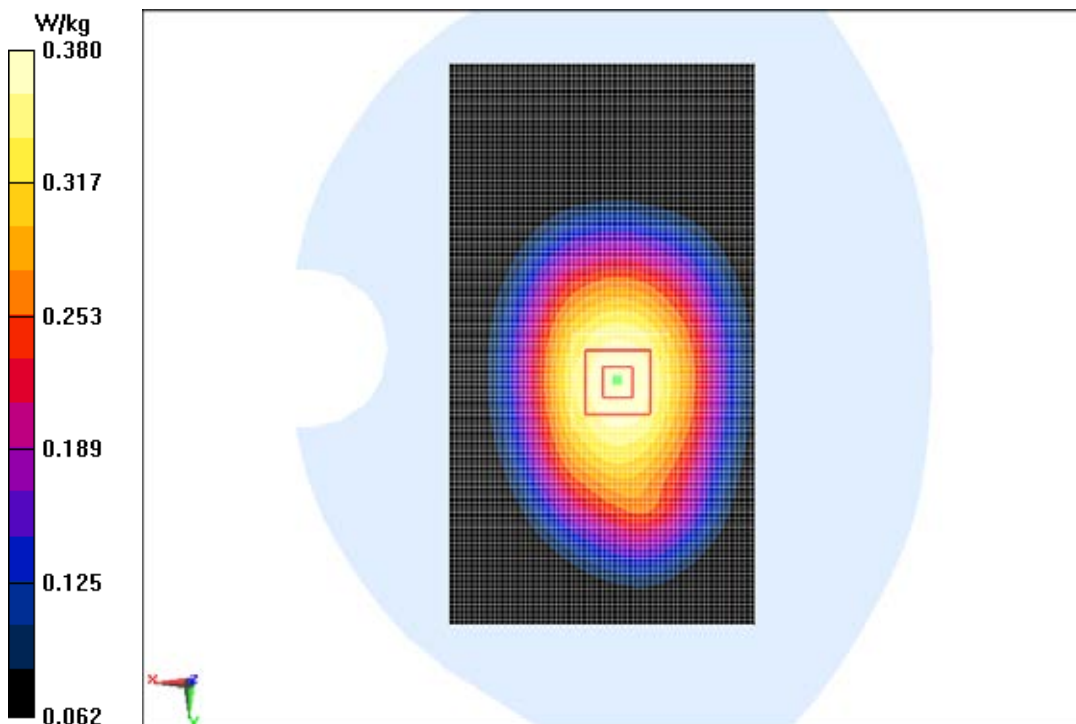

WCDMA Band5 Ground Mode High

Date/Time: 2014/4/26

Electronics: DAE4 Sn1244

Medium: Body 850MHz

Medium parameters used: $f = 847 \text{ MHz}$; $\sigma = 1.012 \text{ S/m}$; $\epsilon_r = 55.214$; $\rho = 1000 \text{ kg/m}^3$

Ambient Temperature: 22.5°C Liquid Temperature: 22.5°C

Communication System: WCDMA Band V; Frequency: 846.6 MHz ; Duty Cycle: 1:1

Probe: ES3DV3 - SN3252ConvF(6.14, 6.14, 6.14); Calibrated: 8/5/2013

WCDMA Band5 Ground Mode High/Area Scan (61x111x1):

Measurement grid: $dx=10 \text{ mm}$, $dy=10 \text{ mm}$

Maximum value of SAR (Measurement) = 0.518 W/kg

WCDMA Band5 Ground Mode High/Zoom Scan (7x7x7)/Cube 0:

Measurement grid: $dx=5\text{mm}$, $dy=5\text{mm}$, $dz=5\text{mm}$

Reference Value = 22.481 V/m ; Power Drift = -0.01 dB

Peak SAR (extrapolated) = 0.581 W/kg

SAR(1 g) = 0.491 W/kg ; SAR(10 g) = 0.381 W/kg

Maximum value of SAR (measured) = 0.514 W/kg

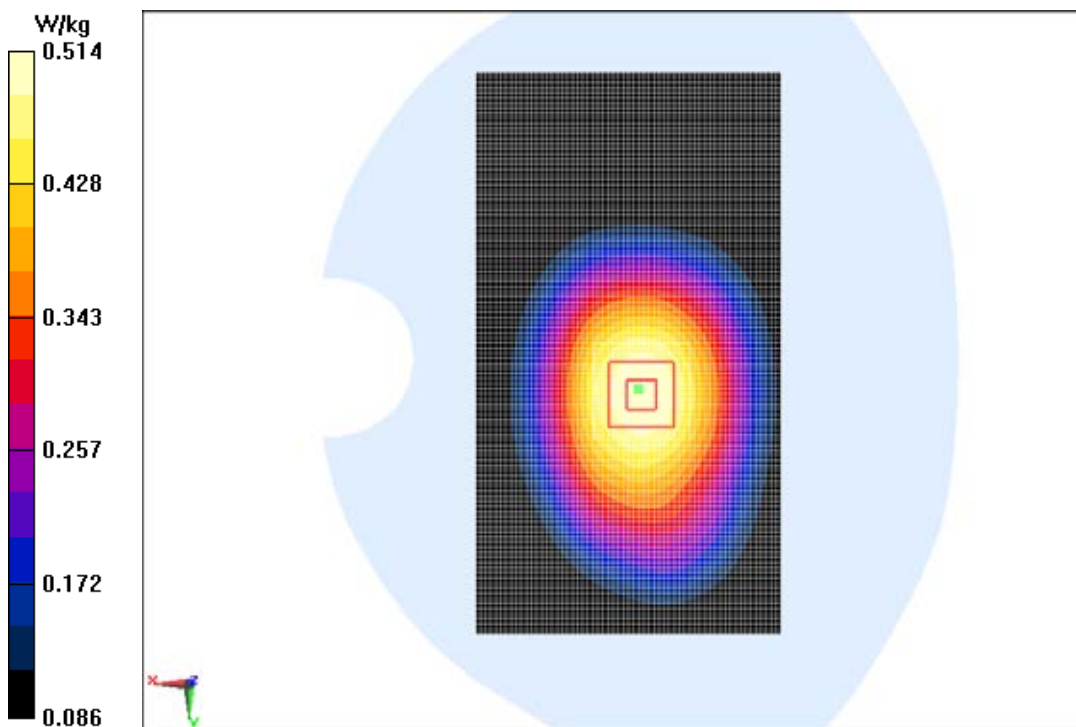

WCDMA Band5 Ground Mode High With Headset

Date/Time: 2014/4/26

Electronics: DAE4 Sn1244

Medium: Body 850MHz

Medium parameters used: $f = 847 \text{ MHz}$; $\sigma = 1.012 \text{ S/m}$; $\epsilon_r = 55.214$; $\rho = 1000 \text{ kg/m}^3$

Ambient Temperature: 22.5°C Liquid Temperature: 22.5°C

Communication System: WCDMA Band V; Frequency: 846.6 MHz; Duty Cycle: 1:1

Probe: ES3DV3 - SN3252ConvF(6.14, 6.14, 6.14); Calibrated: 8/5/2013

WCDMA Band5 Ground Mode High With Headset/Area Scan (61x111x1):

Measurement grid: $dx=10 \text{ mm}$, $dy=10 \text{ mm}$

Maximum value of SAR (Measurement) = 0.341 W/kg

WCDMA Band5 Ground Mode High With Headset/Zoom Scan (7x7x7)/Cube 0:

Measurement grid: $dx=5\text{mm}$, $dy=5\text{mm}$, $dz=5\text{mm}$

Reference Value = 18.310 V/m; Power Drift = 0.01 dB

Peak SAR (extrapolated) = 0.384 W/kg

SAR(1 g) = 0.323 W/kg; SAR(10 g) = 0.251 W/kg

Maximum value of SAR (measured) = 0.338 W/kg

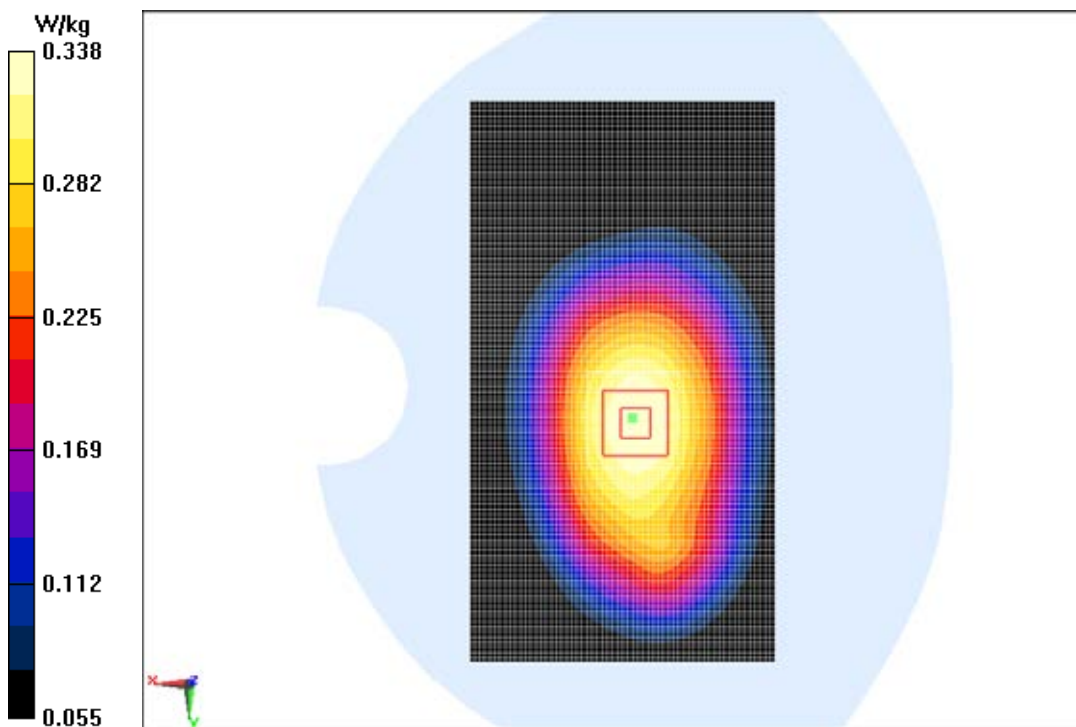

WCDMA Band2 Left Cheek Middle

Date/Time: 2014/4/28

Electronics: DAE4 Sn1244

Medium: Head 1900MHz

Medium parameters used: $f = 1880$ MHz; $\sigma = 1.379$ S/m; $\epsilon_r = 39.867$; $\rho = 1000$ kg/m³

Ambient Temperature: 22.5°C Liquid Temperature: 22.5°C

Communication System: WCDMA Band II; Frequency: 1880 MHz; Duty Cycle: 1:1

Probe: ES3DV3 - SN3252ConvF(5.24, 5.24, 5.24); Calibrated: 8/5/2013

WCDMA Band2 Left Cheek Middle/Area Scan (111x71x1):

Measurement grid: $dx=10$ mm, $dy=10$ mm

Maximum value of SAR (Measurement) = 0.544 W/kg

WCDMA Band2 Left Cheek Middle/Zoom Scan (7x7x7)/Cube 0:

Measurement grid: $dx=5$ mm, $dy=5$ mm, $dz=5$ mm

Reference Value = 5.254 V/m; Power Drift = 0.07 dB

Peak SAR (extrapolated) = 0.865 W/kg

SAR(1 g) = 0.528 W/kg; SAR(10 g) = 0.306 W/kg

Maximum value of SAR (measured) = 0.583 W/kg

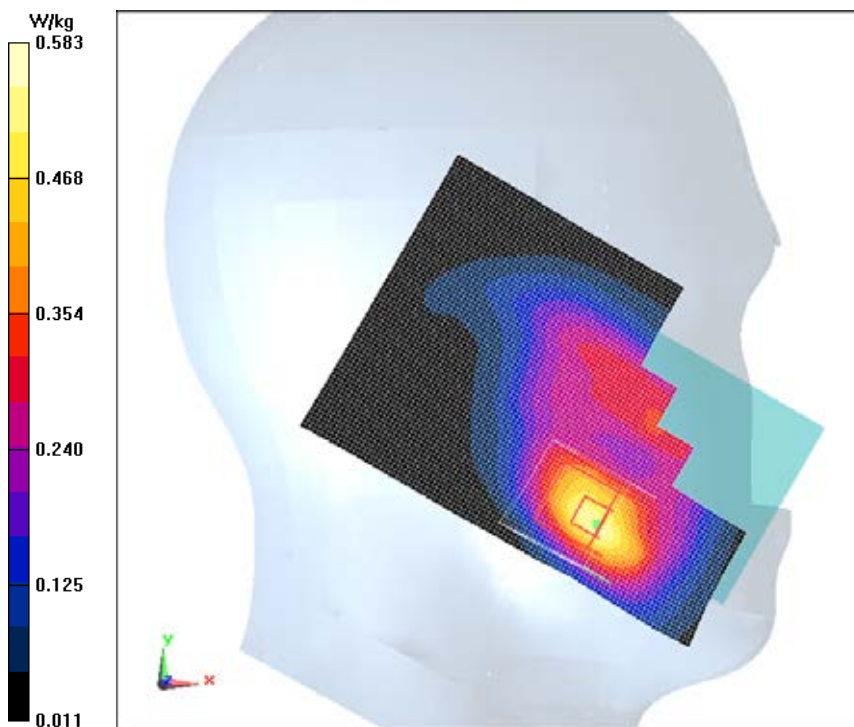

WCDMA Band2 Left Tilt Middle

Date/Time: 2014/4/28

Electronics: DAE4 Sn1244

Medium: Head 1900MHz

Medium parameters used: $f = 1880$ MHz; $\sigma = 1.379$ S/m; $\epsilon_r = 39.867$; $\rho = 1000$ kg/m³

Ambient Temperature: 22.5°C Liquid Temperature: 22.5°C

Communication System: WCDMA Band II ; Frequency: 1880 MHz; Duty Cycle: 1:1

Probe: ES3DV3 - SN3252ConvF(5.24, 5.24, 5.24); Calibrated: 8/5/2013

WCDMA Band2 Left Tilt Middle/Area Scan (11x7x1):

Measurement grid: dx=10 mm, dy=10 mm

Maximum value of SAR (Measurement) = 0.133 W/kg

WCDMA Band2 Left Tilt Middle/Zoom Scan (7x7x7)/Cube 0:

Measurement grid: dx=5mm, dy=5mm, dz=5mm

Reference Value = 7.983 V/m; Power Drift = 0.07 dB

Peak SAR (extrapolated) = 0.195 W/kg

SAR(1 g) = 0.130 W/kg; SAR(10 g) = 0.076 W/kg

Maximum of SAR (measured) = 0.140 W/kg

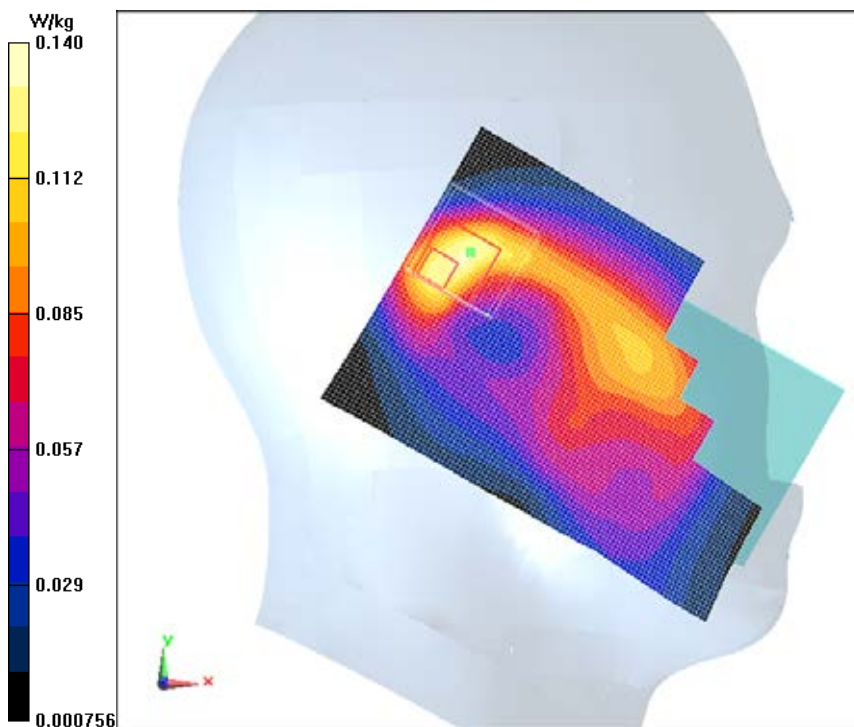

WCDMA Band2 Right Cheek Middle

Date/Time: 2014/4/28

Electronics: DAE4 Sn1244

Medium: Head 1900MHz

Medium parameters used: $f = 1880$ MHz; $\sigma = 1.379$ S/m; $\epsilon_r = 39.867$; $\rho = 1000$ kg/m³

Ambient Temperature: 22.5°C Liquid Temperature: 22.5°C

Communication System: WCDMA Band II ; Frequency: 1880 MHz; Duty Cycle: 1:1

Probe: ES3DV3 - SN3252ConvF(5.24, 5.24, 5.24); Calibrated: 8/5/2013

WCDMA Band2 Right Cheek Middle/Area Scan (11x71x1):

Measurement grid: dx=10 mm, dy=10 mm

Maximum value of SAR (Measurement) = 0.487 W/kg

WCDMA Band2 Right Cheek Middle/Zoom Scan (7x7x7)/Cube 0:

Measurement grid: dx=5mm, dy=5mm, dz=5mm

Reference Value = 5.473 V/m; Power Drift = 0.08 dB

Peak SAR (extrapolated) = 0.631 W/kg

SAR(1 g) = 0.435 W/kg; SAR(10 g) = 0.275 W/kg

Maximum value of SAR (measured) = 0.474 W/kg

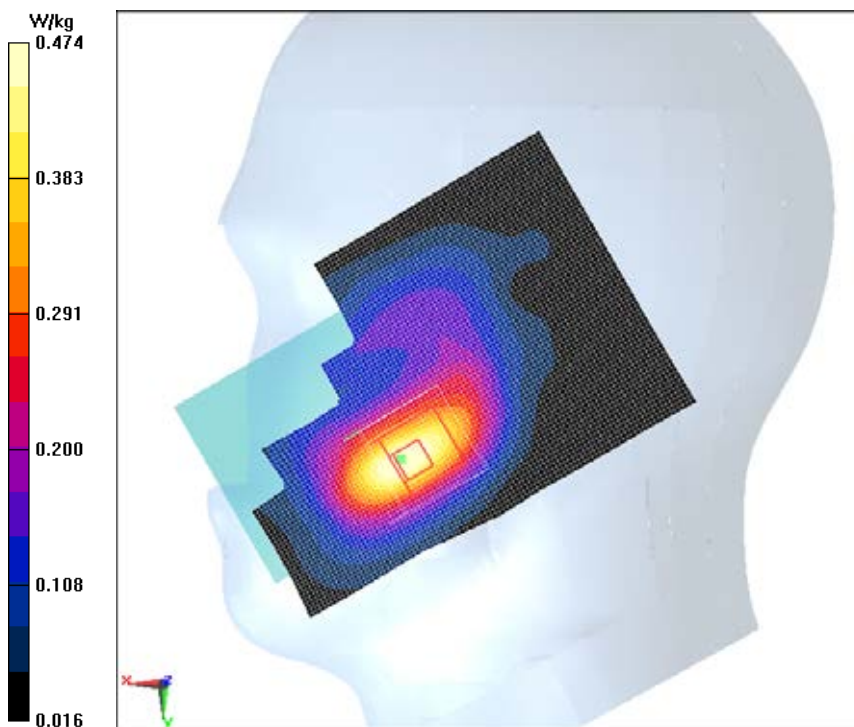

WCDMA Band2 Right Tilt Middle

Date/Time: 2014/4/28

Electronics: DAE4 Sn1244

Medium: Head 1900MHz

Medium parameters used: $f = 1880$ MHz; $\sigma = 1.379$ S/m; $\epsilon_r = 39.867$; $\rho = 1000$ kg/m³

Ambient Temperature: 22.5°C Liquid Temperature: 22.5°C

Communication System: WCDMA Band II ; Frequency: 1880 MHz; Duty Cycle: 1:1

Probe: ES3DV3 - SN3252ConvF(5.24, 5.24, 5.24); Calibrated: 8/5/2013

WCDMA Band2 Right Tilt Middle/Area Scan (111x71x1):

Measurement grid: dx=10 mm, dy=10 mm

Maximum value of SAR (Measurement) = 0.110 W/kg

WCDMA Band2 Right Tilt Middle/Zoom Scan (7x7x7)/Cube 0:

Measurement grid: dx=5mm, dy=5mm, dz=5mm

Reference Value = 7.208 V/m; Power Drift = 0.03 dB

Peak SAR (extrapolated) = 0.157 W/kg

SAR(1 g) = 0.104 W/kg; SAR(10 g) = 0.061 W/kg

Maximum value of SAR (measured) = 0.113 W/kg

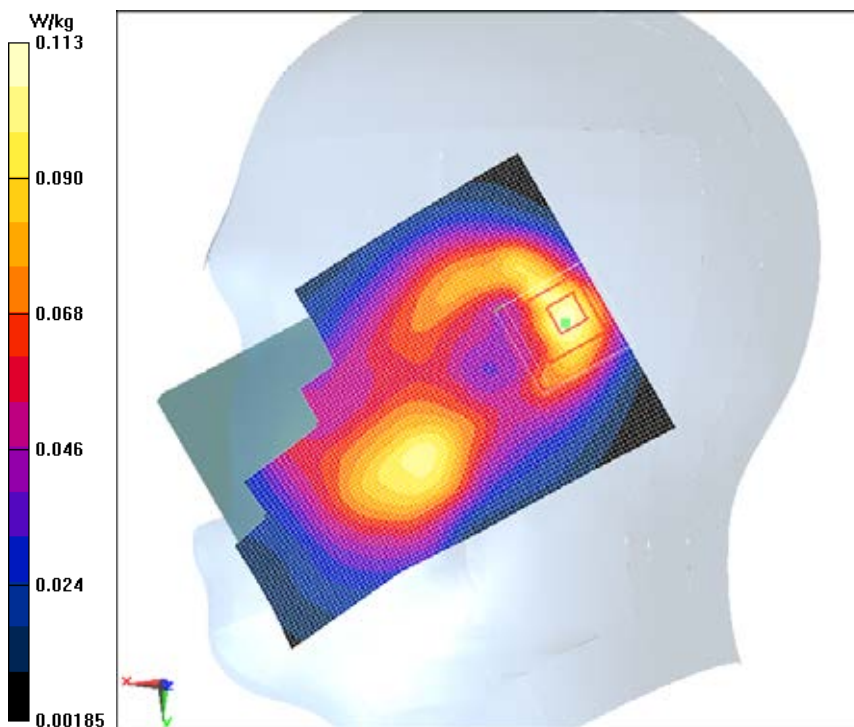

WCDMA Band2 Left Cheek Low

Date/Time: 2014/4/28

Electronics: DAE4 Sn1244

Medium: Head 1900MHz

Medium parameters used (interpolated): $f = 1852.4$ MHz; $\sigma = 1.373$ S/m; $\epsilon_r = 40.159$; $\rho = 1000$ kg/m³

Ambient Temperature: 22.5°C Liquid Temperature: 22.5°C

Communication System: WCDMA Band II; Frequency: 1852.4 MHz; Duty Cycle: 1:1

Probe: ES3DV3 - SN3252ConvF(5.24, 5.24, 5.24); Calibrated: 8/5/2013

WCDMA Band2 Left Cheek Low/Area Scan (111x61x1):

Measurement grid: dx=10 mm, dy=10 mm

Maximum value of SAR (Measurement) = 0.543 W/kg

WCDMA Band2 Left Cheek Low/Zoom Scan (7x7x7)/Cube 0:

Measurement grid: dx=5mm, dy=5mm, dz=5mm

Reference Value = 4.983 V/m; Power Drift = 0.17 dB

Peak SAR (extrapolated) = 0.811 W/kg

SAR(1 g) = 0.498 W/kg; SAR(10 g) = 0.288 W/kg

Maximum value of SAR (measured) = 0.533 W/kg

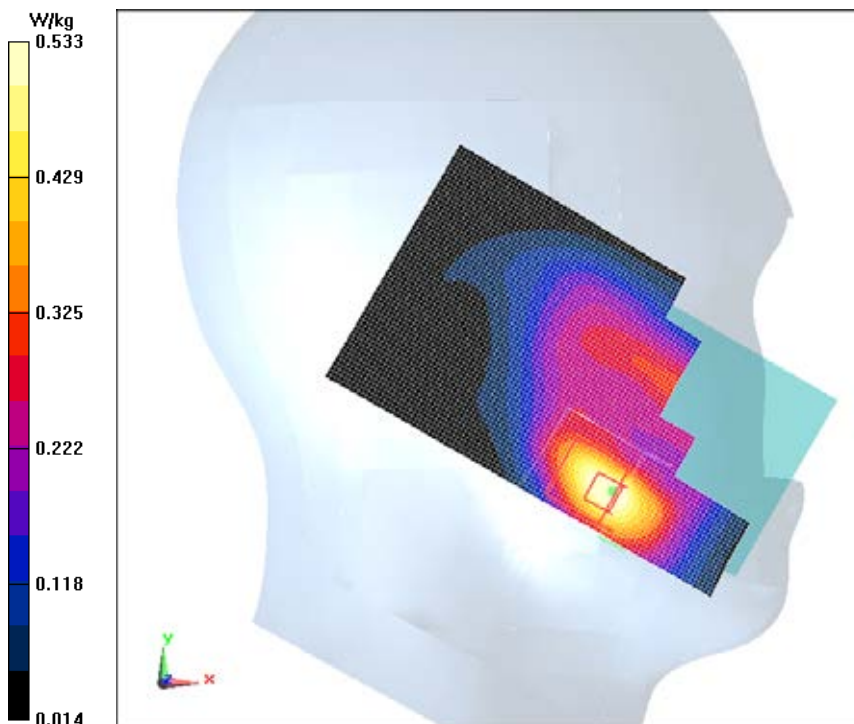

WCDMA Band2 Left Cheek High

Date/Time: 2014/4/28

Electronics: DAE4 Sn1244

Medium: Head 1900MHz

Medium parameters used: $f = 1908$ MHz; $\sigma = 1.391$ S/m; $\epsilon_r = 39.62$; $\rho = 1000$ kg/m³

Ambient Temperature: 22.5°C Liquid Temperature: 22.5°C

Communication System: WCDMA Band II ; Frequency: 1907.6 MHz; Duty Cycle: 1:1

Probe: ES3DV3 - SN3252ConvF(5.24, 5.24, 5.24); Calibrated: 8/5/2013

WCDMA Band2 Left Cheek High/Area Scan (111x61x1):

Measurement grid: dx=10 mm, dy=10 mm

Maximum value of SAR (Measurement) = 0.532 W/kg

WCDMA Band2 Left Cheek High/Zoom Scan (7x7x7)/Cube 0:

Measurement grid: dx=5mm, dy=5mm, dz=5mm

Reference Value = 5.620 V/m; Power Drift = 0.12 dB

Peak SAR (extrapolated) = 0.796 W/kg

SAR(1 g) = 0.486 W/kg; SAR(10 g) = 0.279 W/kg

Maximum value of SAR (measured) = 0.526 W/kg

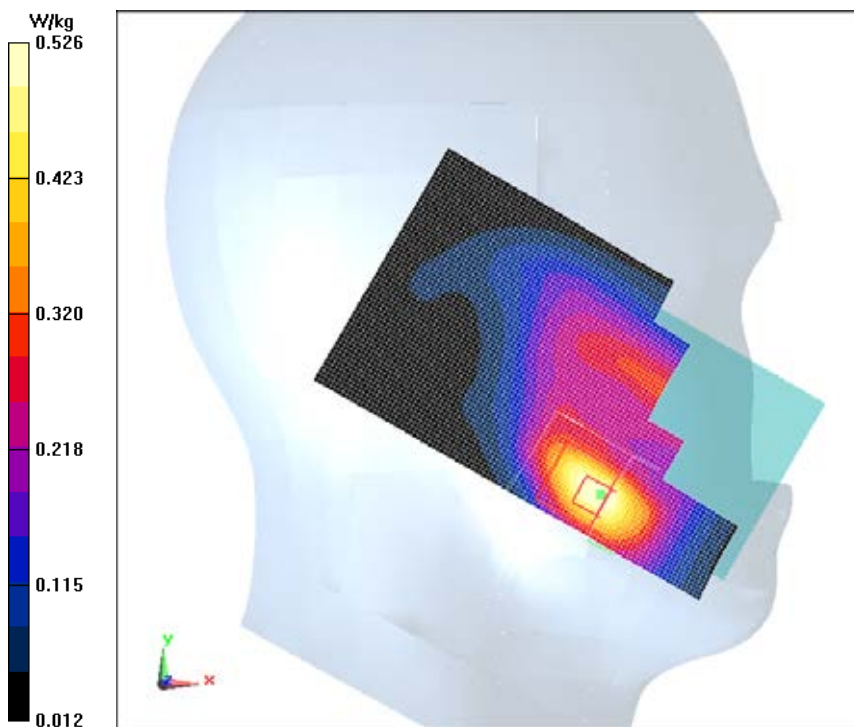

WCDMA Band2 Phantom Mode Middle

Date/Time: 2014/4/29

Electronics: DAE4 Sn1244

Medium: Body 1900MHz

Medium parameters used: $f = 1880$ MHz; $\sigma = 1.504$ S/m; $\epsilon_r = 53.319$; $\rho = 1000$ kg/m³

Ambient Temperature: 22.5°C Liquid Temperature: 22.5°C

Communication System: WCDMA Band II ; Frequency: 1880 MHz; Duty Cycle: 1:1

Probe: ES3DV3 - SN3252ConvF(5.03, 5.03, 5.03); Calibrated: 8/5/2013

WCDMA Band2 Phantom Mode Middle/Area Scan (61x111x1):

Measurement grid: dx=10 mm, dy=10 mm

Maximum value of SAR (Measurement) = 0.898 W/kg

WCDMA Band2 Phantom Mode Middle/Zoom Scan (7x7x7)/Cube 0:

Measurement grid: dx=5mm, dy=5mm, dz=5mm

Reference Value = 10.341 V/m; Power Drift = 0.11 dB

Peak SAR (extrapolated) = 1.36 W/kg

SAR(1 g) = 0.847 W/kg; SAR(10 g) = 0.507 W/kg

Maximum value of SAR (measured) = 0.935 W/kg

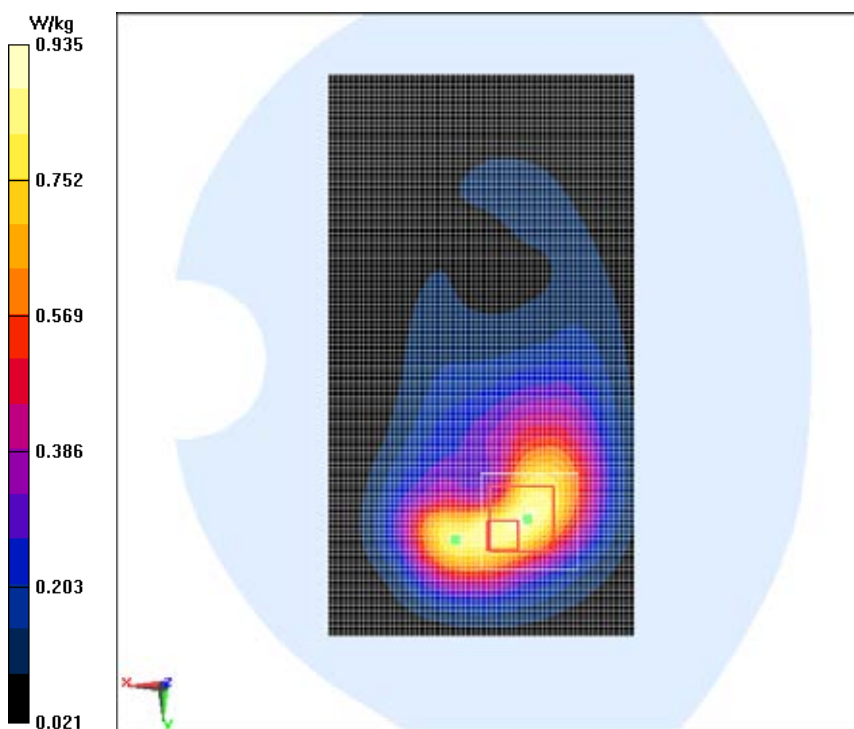

WCDMA Band2 Ground Mode Middle

Date/Time: 2014/4/29

Electronics: DAE4 Sn1244

Medium: Body 1900MHz

Medium parameters used: $f = 1880$ MHz; $\sigma = 1.504$ S/m; $\epsilon_r = 53.319$; $\rho = 1000$ kg/m³

Ambient Temperature: 22.5°C Liquid Temperature: 22.5°C

Communication System: WCDMA Band II; Frequency: 1880 MHz; Duty Cycle: 1:1

Probe: ES3DV3 - SN3252ConvF(5.03, 5.03, 5.03); Calibrated: 8/5/2013

WCDMA Band2 Ground Mode Middle/Area Scan (61x111x1):

Measurement grid: $dx=10$ mm, $dy=10$ mm

Maximum value of SAR (Measurement) = 0.783 W/kg

WCDMA Band2 Ground Mode Middle/Zoom Scan (7x7x7)/Cube 0:

Measurement grid: $dx=5$ mm, $dy=5$ mm, $dz=5$ mm

Reference Value = 12.393 V/m; Power Drift = 0.13 dB

Peak SAR (extrapolated) = 1.09 W/kg

SAR(1 g) = 0.721 W/kg; SAR(10 g) = 0.449 W/kg

Maximum of SAR (measured) = 0.771 W/kg

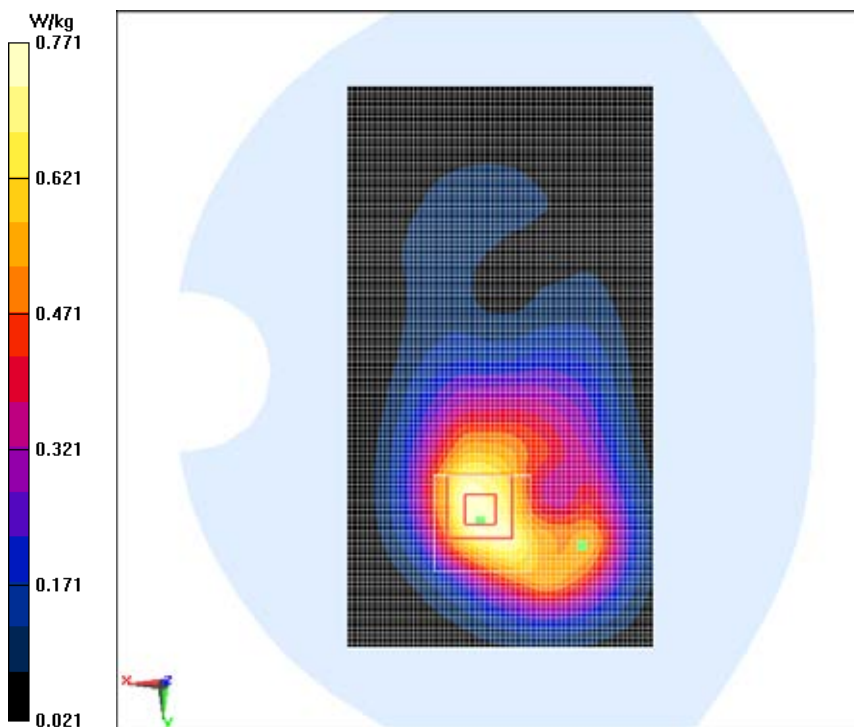

WCDMA Band2 Left Mode Middle

Date/Time: 2014/4/29

Electronics: DAE4 Sn1244

Medium: Body 1900MHz

Medium parameters used: $f = 1880$ MHz; $\sigma = 1.504$ S/m; $\epsilon_r = 53.319$; $\rho = 1000$ kg/m³

Ambient Temperature: 22.5°C Liquid Temperature: 22.5°C

Communication System: WCDMA Band II ; Frequency: 1880 MHz; Duty Cycle: 1:1

Probe: ES3DV3 - SN3252ConvF(5.03, 5.03, 5.03); Calibrated: 8/5/2013

WCDMA Band2 Left Mode Middle/Area Scan (31x111x1):

Measurement grid: dx=10 mm, dy=10 mm

Maximum value of SAR (Measurement) = 0.245 W/kg

WCDMA Band2 Left Mode Middle/Zoom Scan (7x7x7)/Cube 0:

Measurement grid: dx=5mm, dy=5mm, dz=5mm

Reference Value = 8.238 V/m; Power Drift = 0.14 dB

Peak SAR (extrapolated) = 0.361 W/kg

SAR(1 g) = 0.225 W/kg; SAR(10 g) = 0.132 W/kg

Maximum value of SAR (measured) = 0.246 W/kg

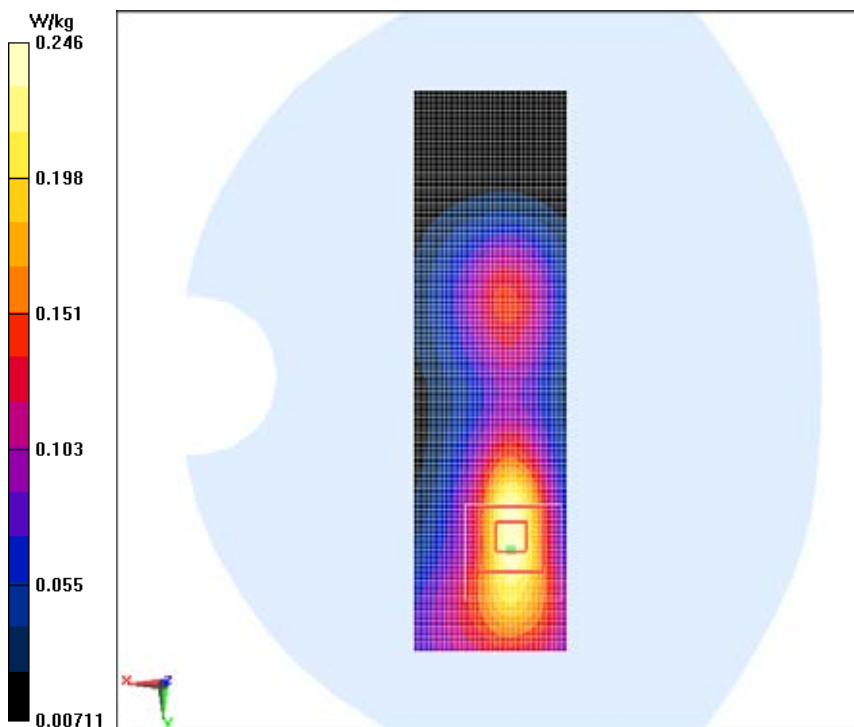

WCDMA Band2 Right Mode Middle

Date/Time: 2014/4/29

Electronics: DAE4 Sn1244

Medium: Body 1900MHz

Medium parameters used: $f = 1880$ MHz; $\sigma = 1.504$ S/m; $\epsilon_r = 53.319$; $\rho = 1000$ kg/m³

Ambient Temperature: 22.5°C Liquid Temperature: 22.5°C

Communication System: WCDMA Band II ; Frequency: 1880 MHz; Duty Cycle: 1:1

Probe: ES3DV3 - SN3252ConvF(5.03, 5.03, 5.03); Calibrated: 8/5/2013

WCDMA Band2 Right Mode Middle/Area Scan (41x111x1):

Measurement grid: dx=10 mm, dy=10 mm

Maximum value of SAR (Measurement) = 0.142 W/kg

WCDMA Band2 Right Mode Middle/Zoom Scan (7x7x7)/Cube 0:

Measurement grid: dx=5mm, dy=5mm, dz=5mm

Reference Value = 8.090 V/m; Power Drift = -0.08 dB

Peak SAR (extrapolated) = 0.282 W/kg

SAR(1 g) = 0.133 W/kg; SAR(10 g) = 0.082 W/kg

Maximum of SAR (measured) = 0.145 W/kg

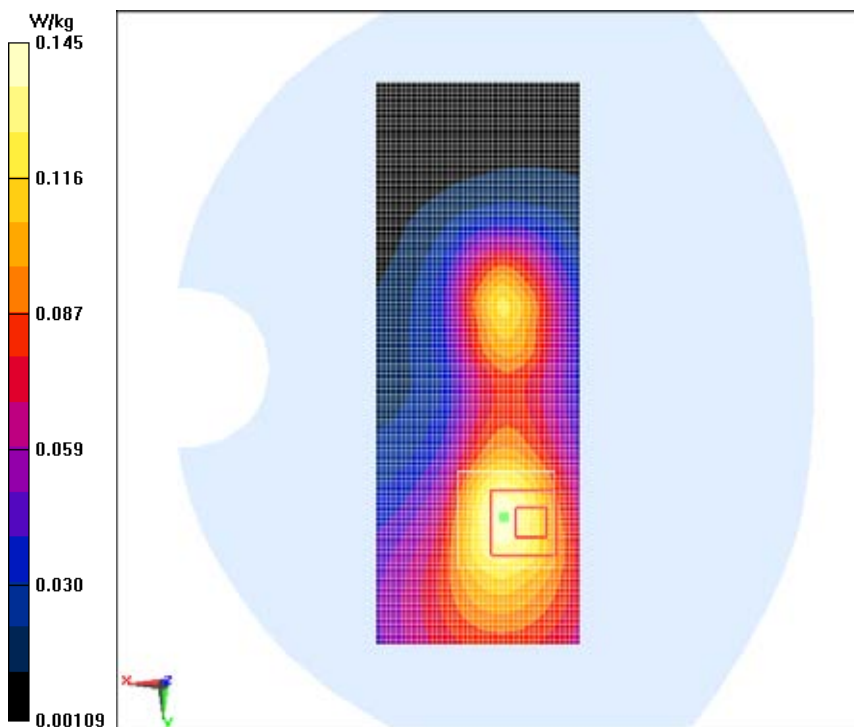

WCDMA Band2 Bottom Mode Middle

Date/Time: 2014/4/29

Electronics: DAE4 Sn1244

Medium: Body 1900MHz

Medium parameters used: $f = 1880$ MHz; $\sigma = 1.504$ S/m; $\epsilon_r = 53.319$; $\rho = 1000$ kg/m³

Ambient Temperature: 22.5°C Liquid Temperature: 22.5°C

Communication System: WCDMA Band II; Frequency: 1880 MHz; Duty Cycle: 1:1

Probe: ES3DV3 - SN3252ConvF(5.03, 5.03, 5.03); Calibrated: 8/5/2013

WCDMA Band2 Bottom Mode Middle/Area Scan (41x71x1):

Measurement grid: dx=10 mm, dy=10 mm

Maximum value of SAR (Measurement) = 0.574 W/kg

WCDMA Band2 Bottom Mode Middle/Zoom Scan (7x7x7)/Cube 0:

Measurement grid: dx=5mm, dy=5mm, dz=5mm

Reference Value = 21.444 V/m; Power Drift = -0.06 dB

Peak SAR (extrapolated) = 0.736 W/kg

SAR(1 g) = 0.469 W/kg; SAR(10 g) = 0.283 W/kg

Maximum value of SAR (measured) = 0.510 W/kg

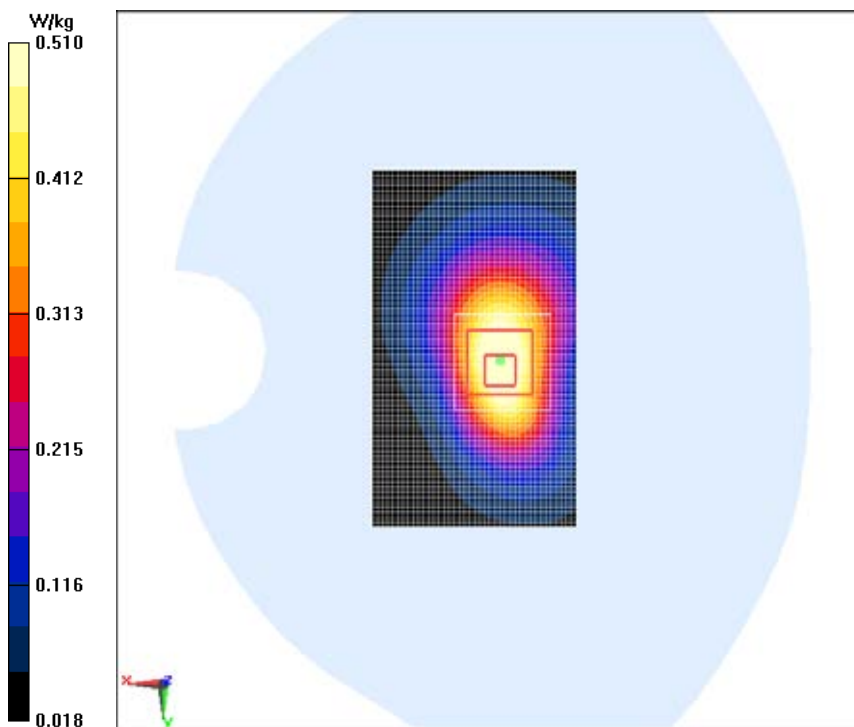

WCDMA Band2 Phantom Mode Low

Date/Time: 2014/4/29

Electronics: DAE4 Sn1244

Medium: Body 1900MHz

Medium parameters used (interpolated): $f = 1852.4$ MHz; $\sigma = 1.477$ S/m; $\epsilon_r = 53.431$; $\rho = 1000$ kg/m³

Ambient Temperature: 22.5°C Liquid Temperature: 22.5°C

Communication System: WCDMA Band II; Frequency: 1852.4 MHz; Duty Cycle: 1:1

Probe: ES3DV3 - SN3252ConvF(5.03, 5.03, 5.03); Calibrated: 8/5/2013

WCDMA Band2 Phantom Mode Low/Area Scan (61x111x1):

Measurement grid: dx=10 mm, dy=10 mm

Maximum value of SAR (Measurement) = 0.875 W/kg

WCDMA Band2 Phantom Mode Low/Zoom Scan (7x7x7)/Cube 0:

Measurement grid: dx=5mm, dy=5mm, dz=5mm

Reference Value = 9.882 V/m; Power Drift = 0.17 dB

Peak SAR (extrapolated) = 1.26 W/kg

SAR(1 g) = 0.783 W/kg; SAR(10 g) = 0.464 W/kg

Maximum of SAR (measured) = 0.864 W/kg

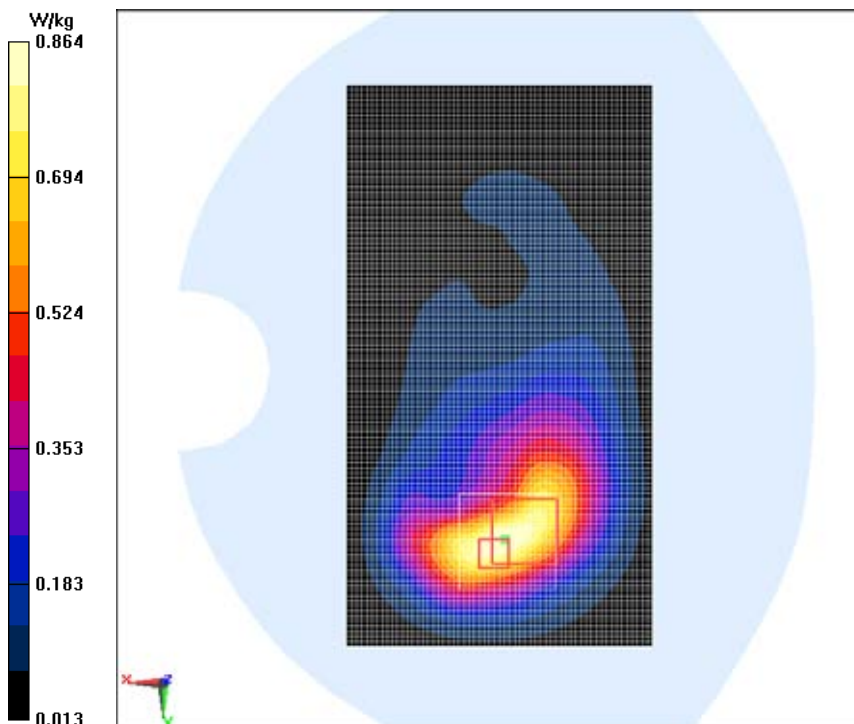

WCDMA Band2 Phantom Mode High

Date/Time: 2014/4/29

Electronics: DAE4 Sn1244

Medium: Body 1900MHz

Medium parameters used: $f = 1908$ MHz; $\sigma = 1.532$ S/m; $\epsilon_r = 53.199$; $\rho = 1000$ kg/m³

Ambient Temperature: 22.5°C Liquid Temperature: 22.5°C

Communication System: WCDMA Band II ; Frequency: 1907.6 MHz; Duty Cycle: 1:1

Probe: ES3DV3 - SN3252ConvF(5.03, 5.03, 5.03); Calibrated: 8/5/2013

WCDMA Band2 Phantom Mode High/Area Scan (61x111x1):

Measurement grid: $dx=10$ mm, $dy=10$ mm

Maximum value of SAR (Measurement) = 0.888 W/kg

WCDMA Band2 Phantom Mode High/Zoom Scan (7x7x7)/Cube 0:

Measurement grid: $dx=5$ mm, $dy=5$ mm, $dz=5$ mm

Reference Value = 10.308 V/m; Power Drift = 0.14 dB

Peak SAR (extrapolated) = 1.27 W/kg

SAR(1 g) = 0.786 W/kg; SAR(10 g) = 0.475 W/kg

Maximum of SAR (measured) = 0.876 W/kg

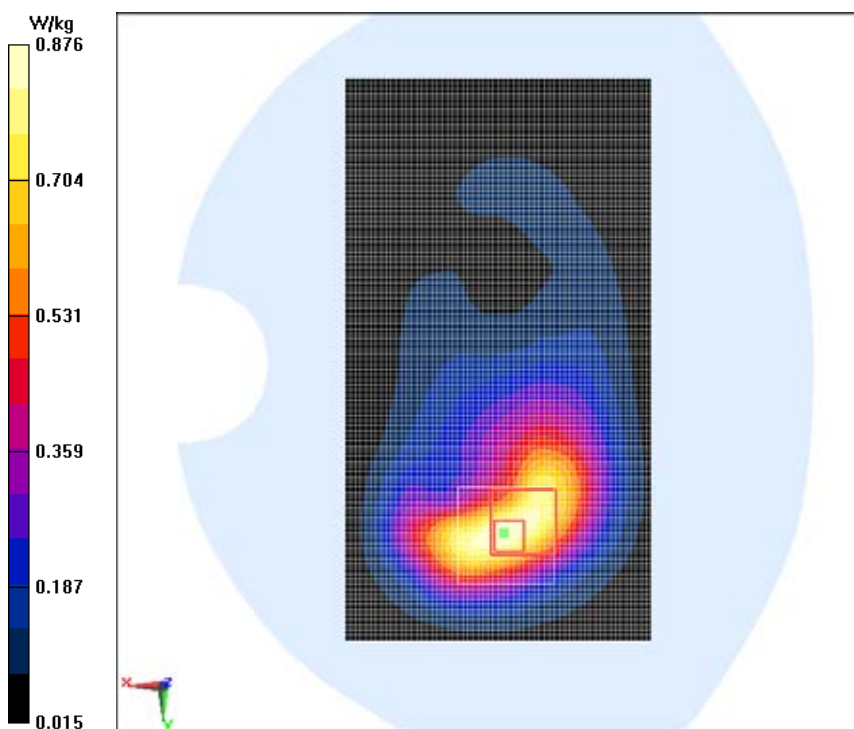

WCDMA Band2 Ground Mode Low

Date/Time: 2014/4/29

Electronics: DAE4 Sn1244

Medium: Body 1900MHz

Medium parameters used (interpolated): $f = 1852.4$ MHz; $\sigma = 1.477$ S/m; $\epsilon_r = 53.431$; $\rho = 1000$ kg/m³

Ambient Temperature: 22.5°C Liquid Temperature: 22.5°C

Communication System: WCDMA Band II; Frequency: 1852.4 MHz; Duty Cycle: 1:1

Probe: ES3DV3 - SN3252ConvF(5.03, 5.03, 5.03); Calibrated: 8/5/2013

WCDMA Band2 Ground Mode Low/Area Scan (61x111x1):

Measurement grid: dx=10 mm, dy=10 mm

Maximum value of SAR (Measurement) = 0.715 W/kg

WCDMA Band2 Ground Mode Low/Zoom Scan (7x7x7)/Cube 0:

Measurement grid: dx=5mm, dy=5mm, dz=5mm

Reference Value = 12.319 V/m; Power Drift = 0.05 dB

Peak SAR (extrapolated) = 0.984 W/kg

SAR(1 g) = 0.659 W/kg; SAR(10 g) = 0.412 W/kg

Maximum of SAR (measured) = 0.703 W/kg

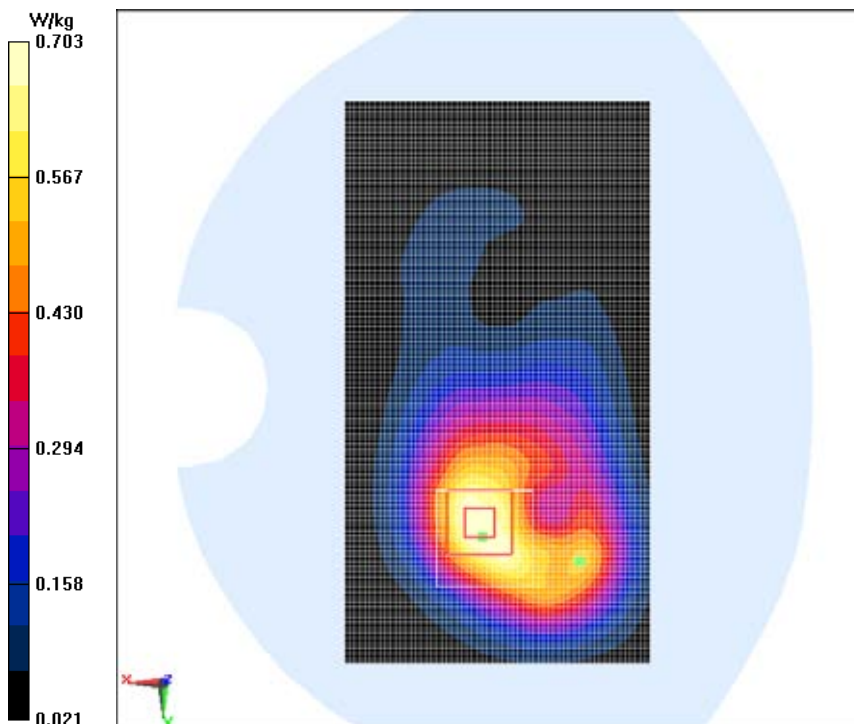

WCDMA Band2 Ground Mode High

Date/Time: 2014/4/29

Electronics: DAE4 Sn1244

Medium: Body 1900MHz

Medium parameters used: $f = 1908$ MHz; $\sigma = 1.532$ S/m; $\epsilon_r = 53.199$; $\rho = 1000$ kg/m³

Ambient Temperature: 22.5°C Liquid Temperature: 22.5°C

Communication System: WCDMA Band II ; Frequency: 1907.6 MHz; Duty Cycle: 1:1

Probe: ES3DV3 - SN3252ConvF(5.03, 5.03, 5.03); Calibrated: 8/5/2013

WCDMA Band2 Ground Mode High/Area Scan (61x111x1):

Measurement grid: dx=10 mm, dy=10 mm

Maximum value of SAR (Measurement) = 0.728 W/kg

WCDMA Band2 Ground Mode High/Zoom Scan (7x7x7)/Cube 0:

Measurement grid: dx=5mm, dy=5mm, dz=5mm

Reference Value = 12.178 V/m; Power Drift = 0.07 dB

Peak SAR (extrapolated) = 1.02 W/kg

SAR(1 g) = 0.676 W/kg; SAR(10 g) = 0.419 W/kg

Maximum value of SAR (measured) = 0.725 W/kg

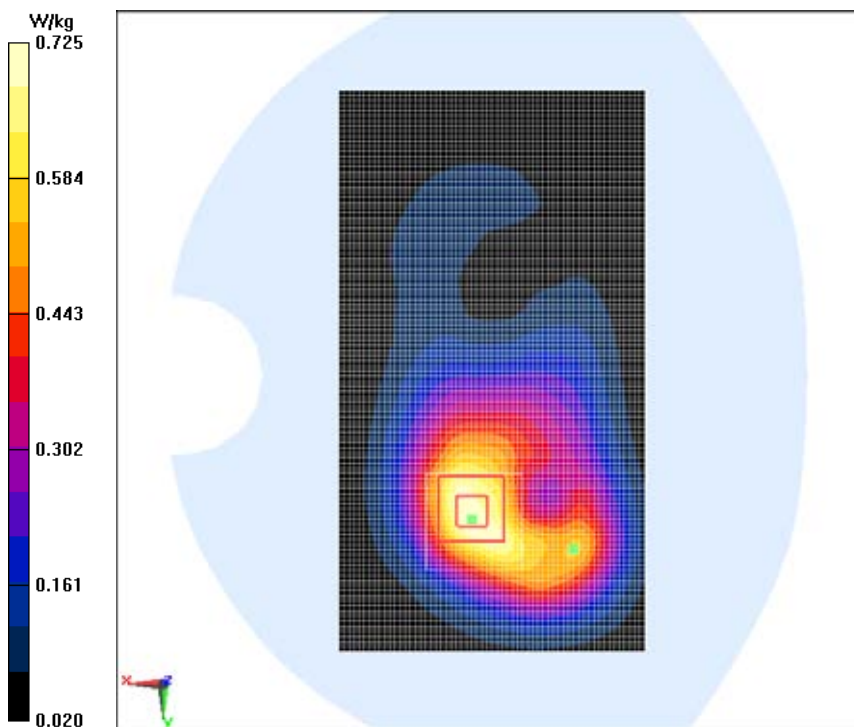

WCDMA Band2 Phantom Mode Middle With Headset

Date/Time: 2014/4/29

Electronics: DAE4 Sn1244

Medium: Body 1900MHz

Medium parameters used: $f = 1880$ MHz; $\sigma = 1.504$ S/m; $\epsilon_r = 53.319$; $\rho = 1000$ kg/m³

Ambient Temperature: 22.5°C Liquid Temperature: 22.5°C

Communication System: WCDMA Professional Band II ; Frequency: 1880 MHz; Duty Cycle: 1:1

Probe: ES3DV3 - SN3252ConvF(5.03, 5.03, 5.03); Calibrated: 8/5/2013

WCDMA Band2 Phantom Mode Middle With Headset/Area Scan (61x111x1):

Measurement grid: dx=10 mm, dy=10 mm

Maximum value of SAR (Measurement) = 0.825 W/kg

WCDMA Band2 Phantom Mode Middle With Headset/Zoom Scan (7x7x7)/Cube 0:

Measurement grid: dx=5mm, dy=5mm, dz=5mm

Reference Value = 10.005 V/m; Power Drift = 0.15 dB

Peak SAR (extrapolated) = 1.15 W/kg

SAR(1 g) = 0.737 W/kg; SAR(10 g) = 0.456 W/kg

Maximum value of SAR (measured) = 0.804 W/kg

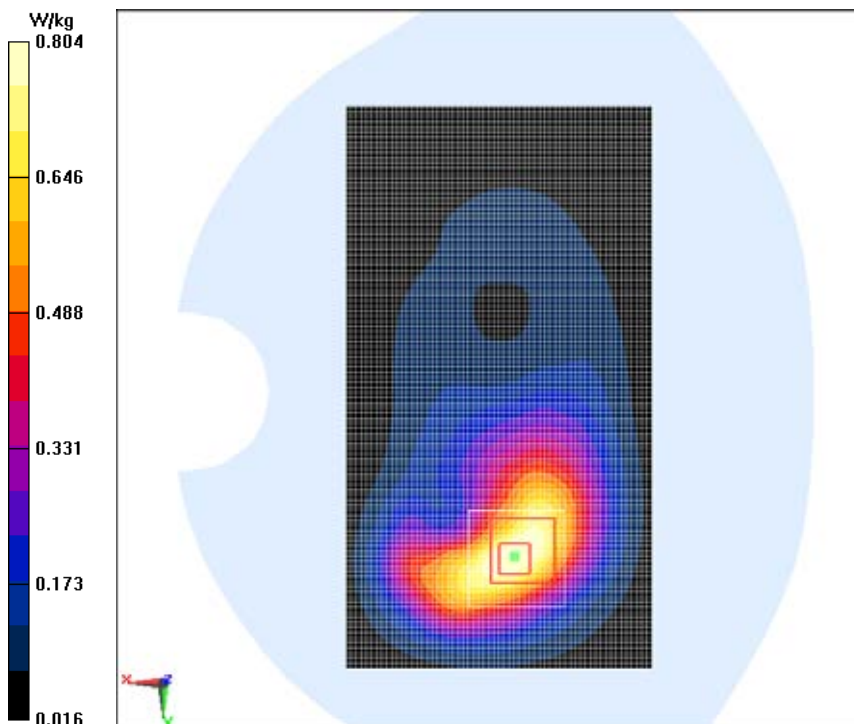

WCDMA Band2 Phantom Mode Low With Headset

Date/Time: 2014/4/29

Electronics: DAE4 Sn1244

Medium: Body 1900MHz

Medium parameters used (interpolated): $f = 1852.4$ MHz; $\sigma = 1.477$ S/m; $\epsilon_r = 53.431$; $\rho = 1000$ kg/m³

Ambient Temperature: 22.5°C Liquid Temperature: 22.5°C

Communication System: WCDMA Professional Band II; Frequency: 1852.4 MHz; Duty Cycle: 1:1

Probe: ES3DV3 - SN3252ConvF(5.03, 5.03, 5.03); Calibrated: 8/5/2013

WCDMA Band2 Phantom Mode Low With Headset/Area Scan (61x111x1):

Measurement grid: dx=10 mm, dy=10 mm

Maximum value of SAR (Measurement) = 0.760 W/kg

WCDMA Band2 Phantom Mode Low With Headset/Zoom Scan (7x7x7)/Cube 0:

Measurement grid: dx=5mm, dy=5mm, dz=5mm

Reference Value = 9.432 V/m; Power Drift = 0.15 dB

Peak SAR (extrapolated) = 1.07 W/kg

SAR(1 g) = 0.677 W/kg; SAR(10 g) = 0.419 W/kg

Maximum value of SAR (measured) = 0.734 W/kg

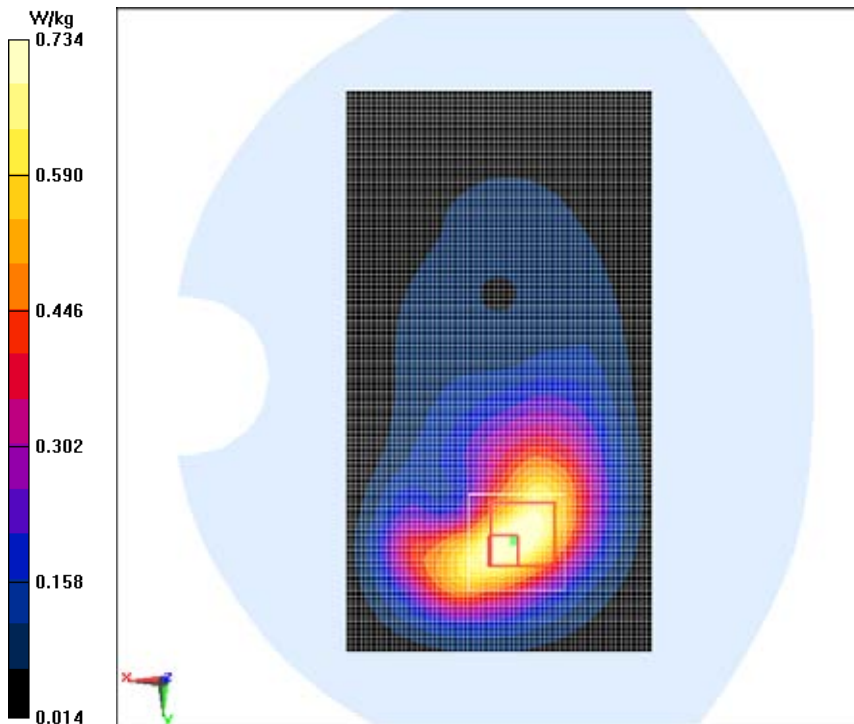

WCDMA Band2 Phantom Mode High With Headset

Date/Time: 2014/4/29

Electronics: DAE4 Sn1244

Medium: Body 1900MHz

Medium parameters used: $f = 1908 \text{ MHz}$; $\sigma = 1.532 \text{ S/m}$; $\epsilon_r = 53.199$; $\rho = 1000 \text{ kg/m}^3$

Ambient Temperature: 22.5°C Liquid Temperature: 22.5°C

Communication System: WCDMA Professional Band II ; Frequency: 1907.6 MHz; Duty Cycle: 1:1

Probe: ES3DV3 - SN3252ConvF(5.03, 5.03, 5.03); Calibrated: 8/5/2013

WCDMA Band2 Phantom Mode High With Headset/Area Scan (61x111x1):

Measurement grid: $dx=10 \text{ mm}$, $dy=10 \text{ mm}$

Maximum value of SAR (Measurement) = 0.765 W/kg

WCDMA Band2 Phantom Mode High With Headset/Zoom Scan (7x7x7)/Cube 0:

Measurement grid: $dx=5\text{mm}$, $dy=5\text{mm}$, $dz=5\text{mm}$

Reference Value = 9.960 V/m; Power Drift = 0.16 dB

Peak SAR (extrapolated) = 1.08 W/kg

SAR(1 g) = 0.688 W/kg; SAR(10 g) = 0.423 W/kg

Maximum value of SAR (measured) = 0.749 W/kg

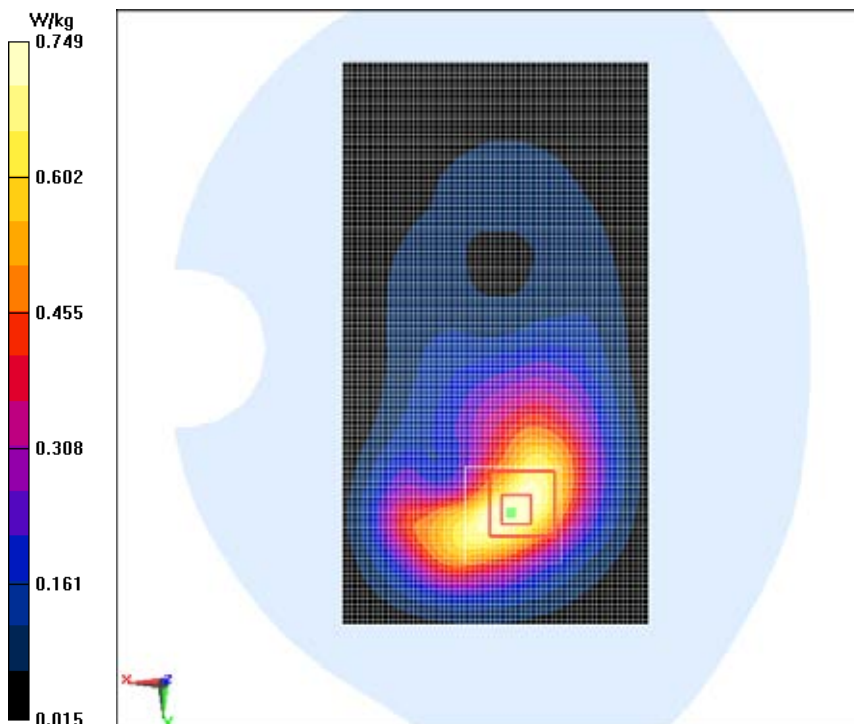

WCDMA Band2 Phantom Mode Middle 2

Date/Time: 2014/4/29

Electronics: DAE4 Sn1244

Medium: Body 1900MHz

Medium parameters used: $f = 1880$ MHz; $\sigma = 1.504$ S/m; $\epsilon_r = 53.319$; $\rho = 1000$ kg/m³

Ambient Temperature: 22.5°C Liquid Temperature: 22.5°C

Communication System: WCDMA Band II ; Frequency: 1880 MHz; Duty Cycle: 1:1

Probe: ES3DV3 - SN3252ConvF(5.03, 5.03, 5.03); Calibrated: 8/5/2013

WCDMA Band2 Phantom Mode Middle 2/Area Scan (61x111x1):

Measurement grid: $dx=10$ mm, $dy=10$ mm

Maximum value of SAR (Measurement) = 0.900 W/kg

WCDMA Band2 Phantom Mode Middle 2/Zoom Scan (7x7x7)/Cube 0:

Measurement grid: $dx=5$ mm, $dy=5$ mm, $dz=5$ mm

Reference Value = 10.337 V/m; Power Drift = 0.19 dB

Peak SAR (extrapolated) = 1.37 W/kg

SAR(1 g) = 0.850 W/kg; SAR(10 g) = 0.509 W/kg

Maximum value of SAR (measured) = 0.931 W/kg

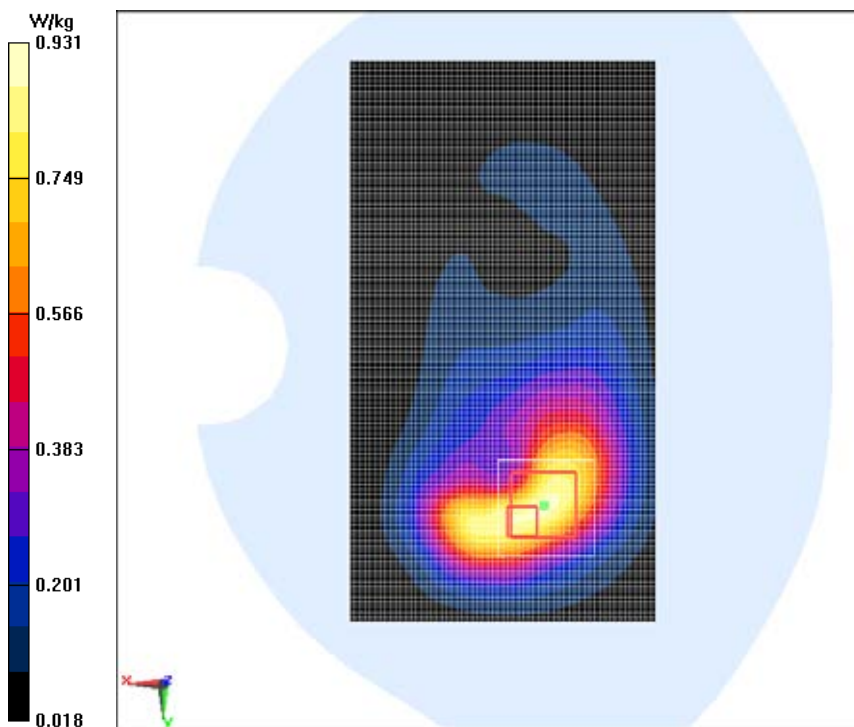

WCDMA Band2 Phantom Mode Low 2

Date/Time: 2014/4/29

Electronics: DAE4 Sn1244

Medium: Body 1900MHz

Medium parameters used (interpolated): $f = 1852.4$ MHz; $\sigma = 1.477$ S/m; $\epsilon_r = 53.431$; $\rho = 1000$ kg/m³

Ambient Temperature: 22.5°C Liquid Temperature: 22.5°C

Communication System: WCDMA Band II; Frequency: 1852.4 MHz; Duty Cycle: 1:1

Probe: ES3DV3 - SN3252ConvF(5.03, 5.03, 5.03); Calibrated: 8/5/2013

WCDMA Band2 Phantom Mode Low 2/Area Scan (61x111x1):

Measurement grid: dx=10 mm, dy=10 mm

Maximum value of SAR (Measurement) = 0.877 W/kg

WCDMA Band2 Phantom Mode Low 2/Zoom Scan (7x7x7)/Cube 0:

Measurement grid: dx=5mm, dy=5mm, dz=5mm

Reference Value = 9.927 V/m; Power Drift = 0.17 dB

Peak SAR (extrapolated) = 1.26 W/kg

SAR(1 g) = 0.783 W/kg; SAR(10 g) = 0.463 W/kg

Maximum of SAR (measured) = 0.864 W/kg

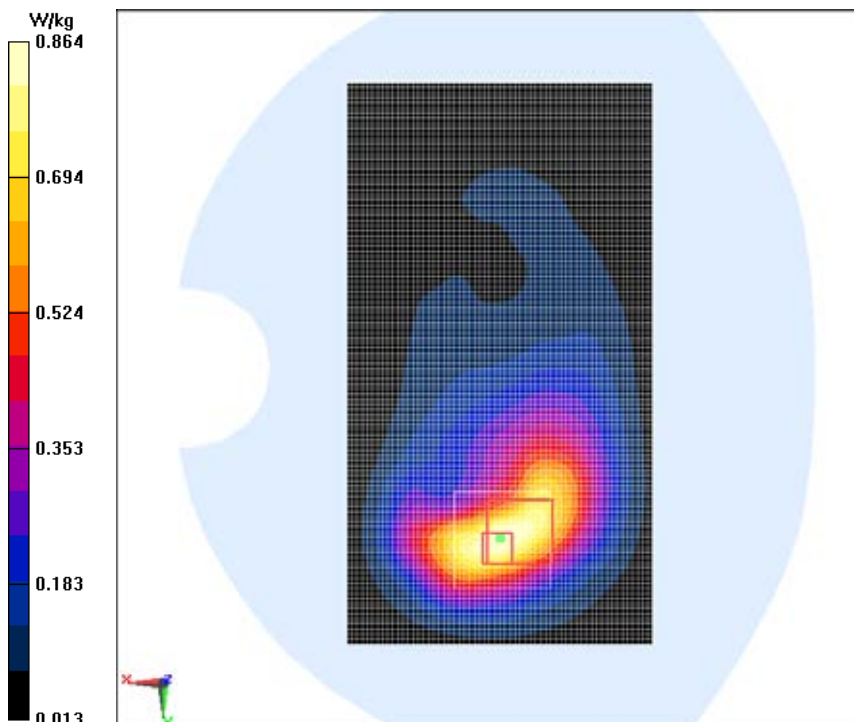

WCDMA Band2 Phantom Mode High 2

Date/Time: 2014/4/29

Electronics: DAE4 Sn1244

Medium: Body 1900MHz

Medium parameters used: $f = 1908$ MHz; $\sigma = 1.532$ S/m; $\epsilon_r = 53.199$; $\rho = 1000$ kg/m³

Ambient Temperature: 22.5°C Liquid Temperature: 22.5°C

Communication System: WCDMA Band II; Frequency: 1907.6 MHz; Duty Cycle: 1:1

Probe: ES3DV3 - SN3252ConvF(5.03, 5.03, 5.03); Calibrated: 8/5/2013

WCDMA Band2 Phantom Mode High 2/Area Scan (61x111x1):

Measurement grid: dx=10 mm, dy=10 mm

Maximum value of SAR (Measurement) = 0.889 W/kg

WCDMA Band2 Phantom Mode High 2/Zoom Scan (7x7x7)/Cube 0:

Measurement grid: dx=5mm, dy=5mm, dz=5mm

Reference Value = 10.306 V/m; Power Drift = 0.17 dB

Peak SAR (extrapolated) = 1.26 W/kg

SAR(1 g) = 0.786 W/kg; SAR(10 g) = 0.475 W/kg

Maximum of SAR (measured) = 0.876 W/kg

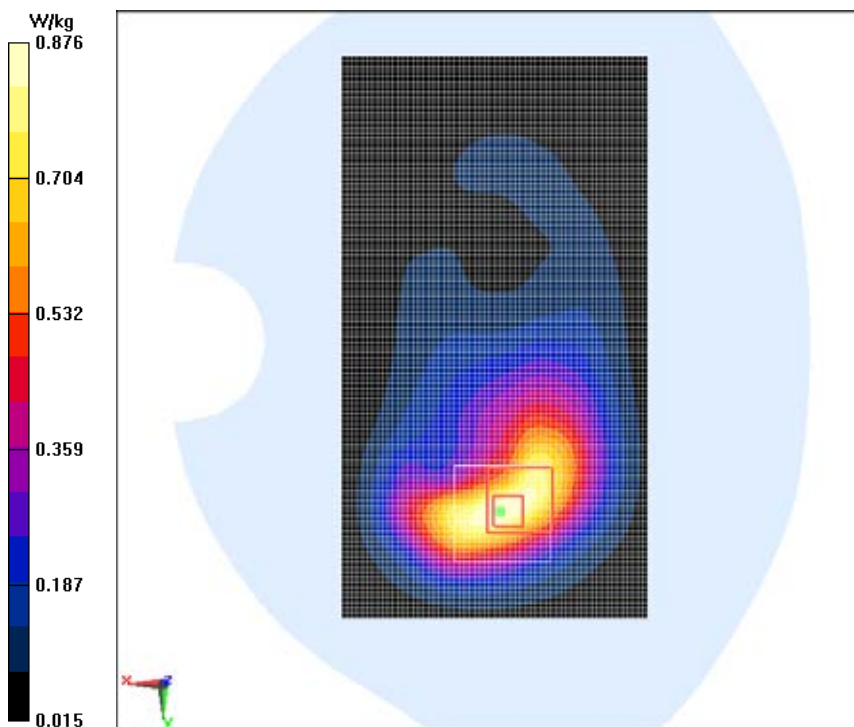

WiFi 802.11b Left Cheek Middle

Date/Time: 2014/5/4

Electronics: DAE4 Sn1244

Medium: Head 2450MHz

Medium parameters used: $f = 2412$ MHz; $\sigma = 1.772$ S/m; $\epsilon_r = 39.251$; $\rho = 1000$ kg/m³

Ambient Temperature: 22.5°C Liquid Temperature: 22.5°C

Communication System: Wifi 2450MHz; Frequency: 2412 MHz; Duty Cycle: 1:1

Probe: EX3DV4 - SN3754ConvF(7.09, 7.09, 7.09); Calibrated: 8/8/2013

WiFi 802.11b Left Cheek Middle/Area Scan (111x71x1):

Measurement grid: dx=10 mm, dy=10 mm

Maximum value of SAR (Measurement) = 0.384 W/kg

WiFi 802.11b Left Cheek Middle/Zoom Scan (7x7x7)/Cube 0:

Measurement grid: dx=5mm, dy=5mm, dz=5mm

Reference Value = 8.374 V/m; Power Drift = 0.12 dB

Peak SAR (extrapolated) = 0.710 W/kg

SAR(1 g) = 0.326 W/kg; SAR(10 g) = 0.159 W/kg

Maximum value of SAR (measured) = 0.357 W/kg

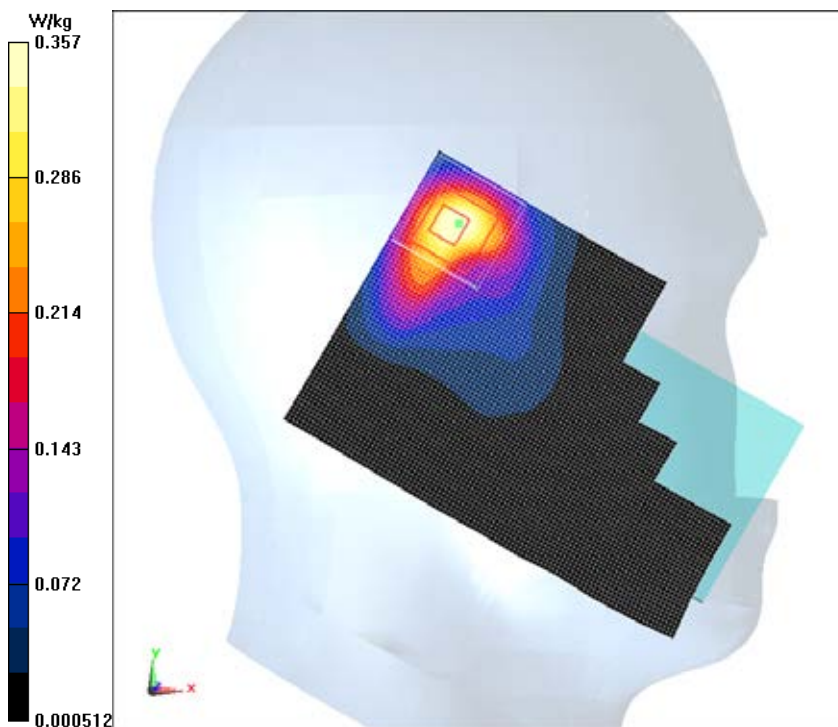

WiFi 802.11b Left Tilt Middle

Date/Time: 2014/5/4

Electronics: DAE4 Sn1244

Medium: Head 2450MHz

Medium parameters used: $f = 2412$ MHz; $\sigma = 1.772$ S/m; $\epsilon_r = 39.251$; $\rho = 1000$ kg/m³

Ambient Temperature: 22.5°C Liquid Temperature: 22.5°C

Communication System: Wifi 2450MHz; Frequency: 2412 MHz; Duty Cycle: 1:1

Probe: EX3DV4 - SN3754ConvF(7.09, 7.09, 7.09); Calibrated: 8/8/2013

WiFi 802.11b Left Tilt Middle/Area Scan (11x71x1):

Measurement grid: dx=10 mm, dy=10 mm

Maximum value of SAR (Measurement) = 0.282 W/kg

WiFi 802.11b Left Tilt Middle/Zoom Scan (7x7x7)/Cube 0:

Measurement grid: dx=5mm, dy=5mm, dz=5mm

Reference Value = 8.448 V/m; Power Drift = 0.13 dB

Peak SAR (extrapolated) = 0.546 W/kg

SAR(1 g) = 0.260 W/kg; SAR(10 g) = 0.125 W/kg

Maximum value of SAR (measured) = 0.288 W/kg

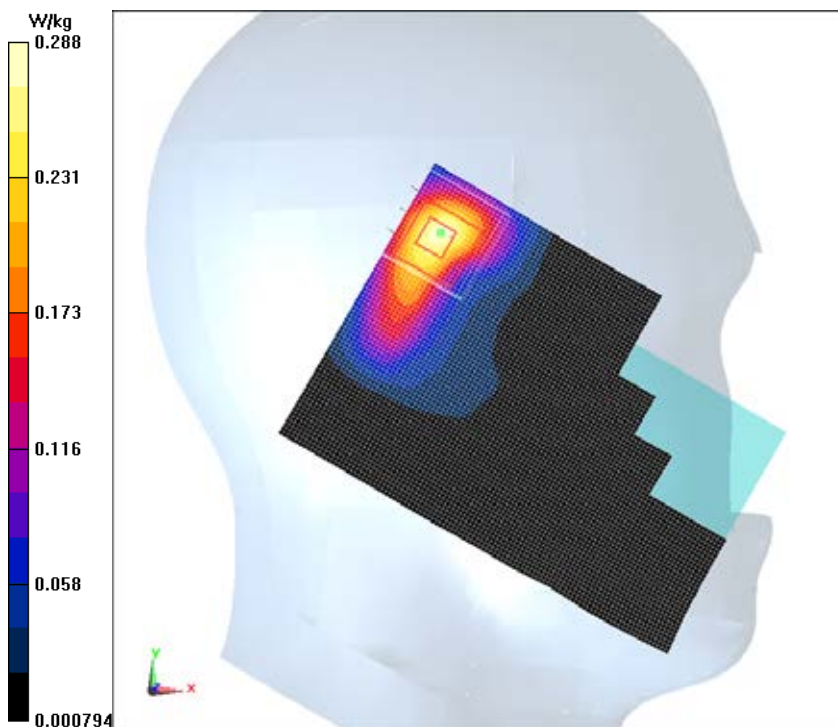

WiFi 802.11b Right Cheek Middle

Date/Time: 2014/5/4

Electronics: DAE4 Sn1244

Medium: Head 2450MHz

Medium parameters used: $f = 2412$ MHz; $\sigma = 1.772$ S/m; $\epsilon_r = 39.251$; $\rho = 1000$ kg/m³

Ambient Temperature: 22.5°C Liquid Temperature: 22.5°C

Communication System: Wifi 2450MHz; Frequency: 2412 MHz; Duty Cycle: 1:1

Probe: EX3DV4 - SN3754ConvF(7.09, 7.09, 7.09); Calibrated: 8/8/2013

WiFi 802.11b Right Cheek Middle/Area Scan (111x71x1):

Measurement grid: dx=10 mm, dy=10 mm

Maximum value of SAR (Measurement) = 0.180 W/kg

WiFi 802.11b Right Cheek Middle/Zoom Scan (7x7x7)/Cube 0:

Measurement grid: dx=5mm, dy=5mm, dz=5mm

Reference Value = 9.335 V/m; Power Drift = -0.06 dB

Peak SAR (extrapolated) = 0.304 W/kg

SAR(1 g) = 0.157 W/kg; SAR(10 g) = 0.081 W/kg

Maximum value of SAR (measured) = 0.178 W/kg

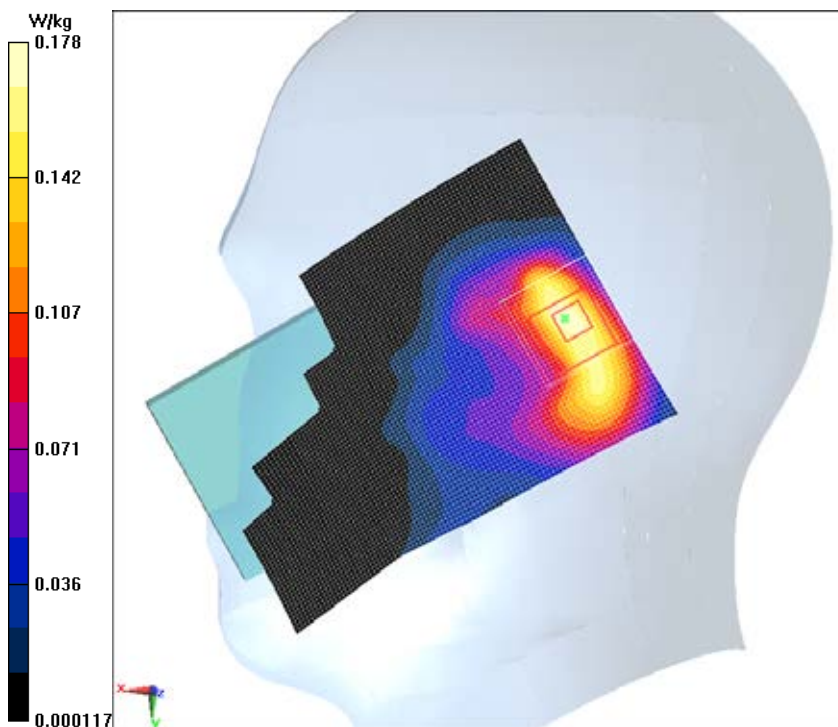

WiFi 802.11b Right Tilt Middle

Date/Time: 2014/5/4

Electronics: DAE4 Sn1244

Medium: Head 2450MHz

Medium parameters used: $f = 2412$ MHz; $\sigma = 1.772$ S/m; $\epsilon_r = 39.251$; $\rho = 1000$ kg/m³

Ambient Temperature: 22.5°C Liquid Temperature: 22.5°C

Communication System: Wifi 2450MHz; Frequency: 2412 MHz; Duty Cycle: 1:1

Probe: EX3DV4 - SN3754ConvF(7.09, 7.09, 7.09); Calibrated: 8/8/2013

WiFi 802.11b Right Tilt Middle/Area Scan (111x71x1):

Measurement grid: dx=10 mm, dy=10 mm

Maximum value of SAR (Measurement) = 0.162 W/kg

WiFi 802.11b Right Tilt Middle/Zoom Scan (7x7x7)/Cube 0:

Measurement grid: dx=5mm, dy=5mm, dz=5mm

Reference Value = 9.015 V/m; Power Drift = 0.16 dB

Peak SAR (extrapolated) = 0.278 W/kg

SAR(1 g) = 0.142 W/kg; SAR(10 g) = 0.070 W/kg

Maximum value of SAR (measured) = 0.161 W/kg

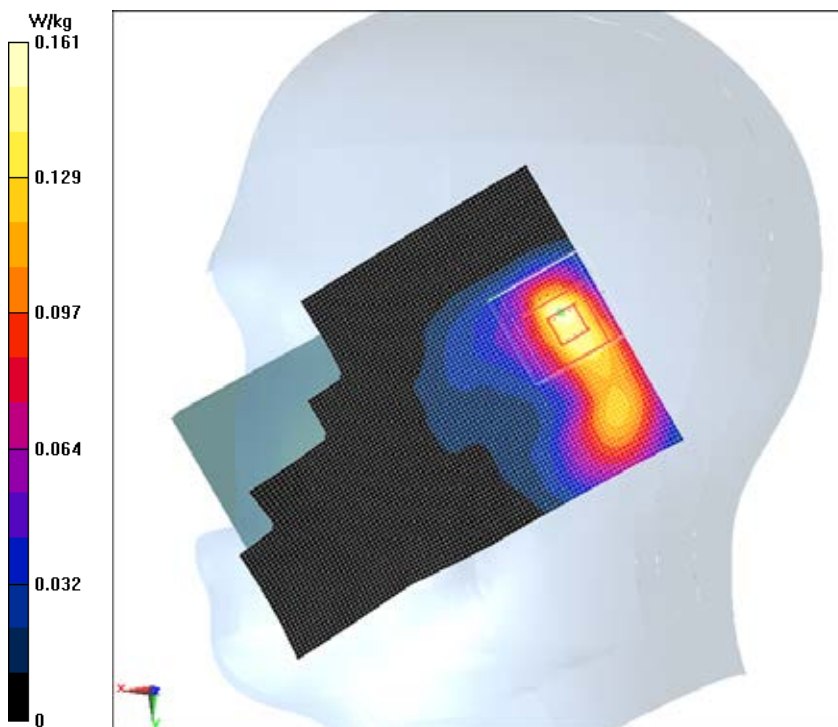

WiFi 802.11b Phantom Mode Middle

Date/Time: 2014/5/5

Electronics: DAE4 Sn1244

Medium: Body 2450MHz

Medium parameters used: $f = 2412$ MHz; $\sigma = 1.869$ S/m; $\epsilon_r = 53.925$; $\rho = 1000$ kg/m³

Ambient Temperature: 22.5°C Liquid Temperature: 22.5°C

Communication System: Wifi 2450MHz; Frequency: 2412 MHz; Duty Cycle: 1:1

Probe: EX3DV4 - SN3754ConvF(6.66, 6.66, 6.66); Calibrated: 8/8/2013

WiFi 802.11b Phantom Mode Middle/Area Scan (61x111x1):

Measurement grid: dx=10 mm, dy=10 mm

Maximum value of SAR (Measurement) = 0.345 W/kg

WiFi 802.11b Phantom Mode Middle/Zoom Scan (7x7x7)/Cube 0:

Measurement grid: dx=5mm, dy=5mm, dz=5mm

Reference Value = 9.206 V/m; Power Drift = -0.03 dB

Peak SAR (extrapolated) = 0.453 W/kg

SAR(1 g) = 0.283 W/kg; SAR(10 g) = 0.162 W/kg

Maximum value of SAR (measured) = 0.307 W/kg

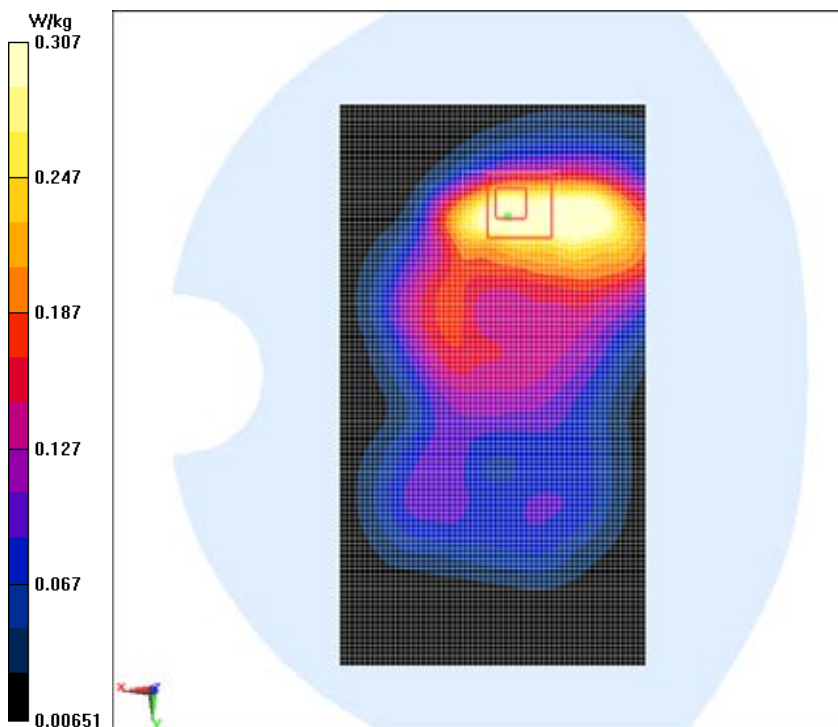

WiFi 802.11b Ground Mode Middle

Date/Time: 2014/5/5

Electronics: DAE4 Sn1244

Medium: Body 2450MHz

Medium parameters used: $f = 2412$ MHz; $\sigma = 1.869$ S/m; $\epsilon_r = 53.925$; $\rho = 1000$ kg/m³

Ambient Temperature: 22.5°C Liquid Temperature: 22.5°C

Communication System: Wifi 2450MHz; Frequency: 2412 MHz; Duty Cycle: 1:1

Probe: EX3DV4 - SN3754ConvF(6.66, 6.66, 6.66); Calibrated: 8/8/2013

WiFi 802.11b Ground Mode Middle/Area Scan (61x111x1):

Measurement grid: dx=10 mm, dy=10 mm

Maximum value of SAR (Measurement) = 0.348 W/kg

WiFi 802.11b Ground Mode Middle/Zoom Scan (7x7x7)/Cube 0:

Measurement grid: dx=5mm, dy=5mm, dz=5mm

Reference Value = 7.517 V/m; Power Drift = 0.08 dB

Peak SAR (extrapolated) = 0.841 W/kg

SAR(1 g) = 0.448 W/kg; SAR(10 g) = 0.208 W/kg

Maximum value of SAR (measured) = 0.552 W/kg

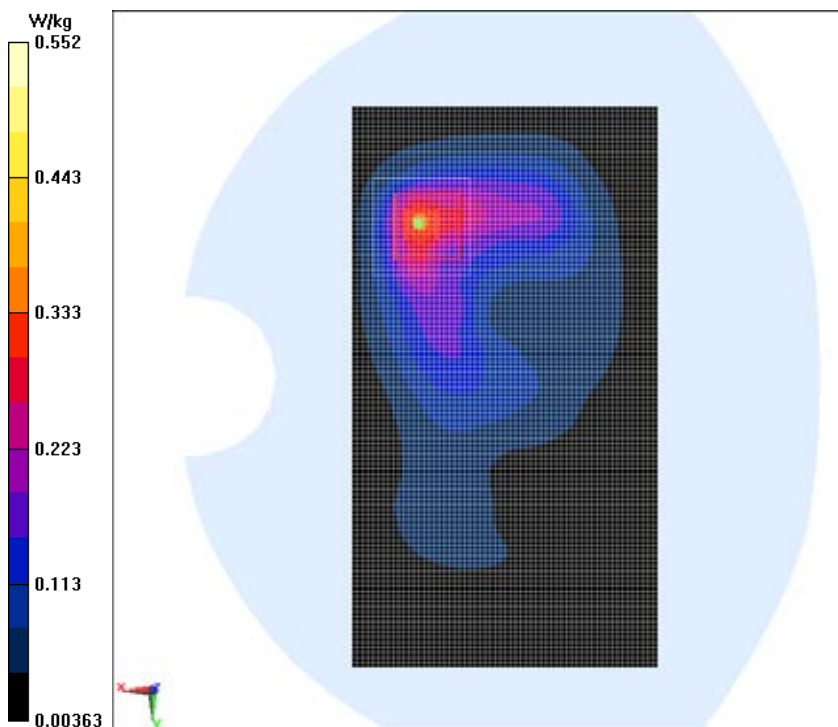

WiFi 802.11b Top Mode Middle

Date/Time: 2014/5/5

Electronics: DAE4 Sn1244

Medium: Body 2450MHz

Medium parameters used: $f = 2412$ MHz; $\sigma = 1.869$ S/m; $\epsilon_r = 53.925$; $\rho = 1000$ kg/m³

Ambient Temperature: 22.5°C Liquid Temperature: 22.5°C

Communication System: Wifi 2450 2450MHz; Frequency: 2412 MHz; Duty Cycle: 1:1

Probe: EX3DV4 - SN3754ConvF(6.66, 6.66, 6.66); Calibrated: 8/9/2013

WiFi 802.11b Top Mode Middle/Area Scan (31x71x1):

Measurement grid: dx=10 mm, dy=10 mm

Maximum value of SAR (Measurement) = 0.0953 W/kg

WiFi 802.11b Top Mode Middle/Zoom Scan (7x7x7)/Cube 0:

Measurement grid: dx=5mm, dy=5mm, dz=5mm

Reference Value = 6.505 V/m; Power Drift = 0.07 dB

Peak SAR (extrapolated) = 0.134 W/kg

SAR(1 g) = 0.085 W/kg; SAR(10 g) = 0.048 W/kg

Maximum value of SAR (measured) = 0.0907 W/kg

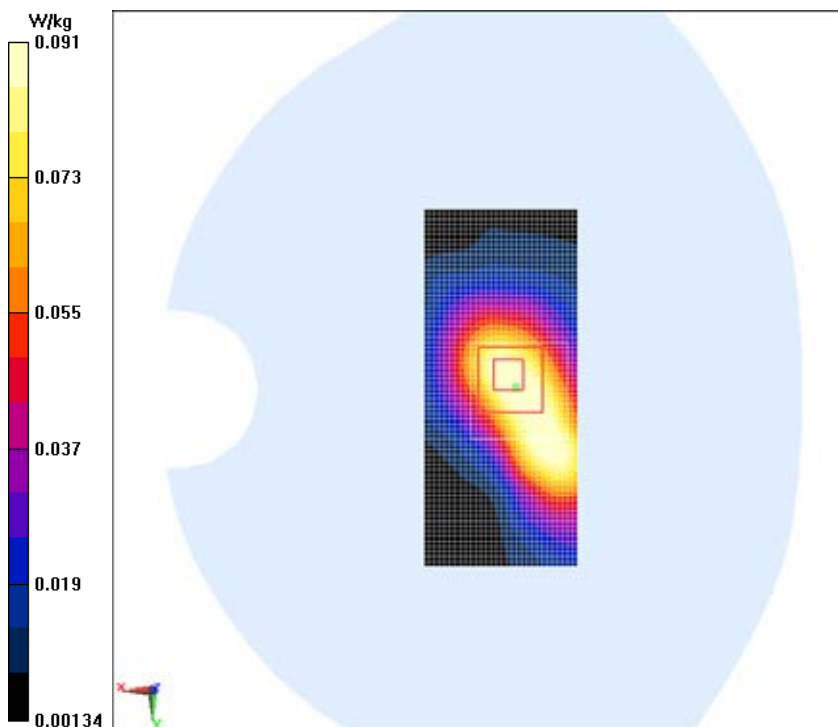

WiFi 802.11b Bottom Mode Middle

Date/Time: 2014/5/5

Electronics: DAE4 Sn1244

Medium: Body 2450MHz

Medium parameters used: $f = 2412$ MHz; $\sigma = 1.869$ S/m; $\epsilon_r = 53.925$; $\rho = 1000$ kg/m³

Ambient Temperature: 22.5°C Liquid Temperature: 22.5°C

Communication System: Wifi 2450 2450MHz; Frequency: 2412 MHz; Duty Cycle: 1:1

Probe: EX3DV4 - SN3754ConvF(6.66, 6.66, 6.66); Calibrated: 8/9/2013

WiFi 802.11b Bottom Mode Middle/Area Scan (31x71x1):

Measurement grid: dx=10 mm, dy=10 mm

Maximum value of SAR (Measurement) = 0.0350 W/kg

WiFi 802.11b Bottom Mode Middle/Zoom Scan (7x7x7)/Cube 0:

Measurement grid: dx=5mm, dy=5mm, dz=5mm

Reference Value = 3.584 V/m; Power Drift = -0.14 dB

Peak SAR (extrapolated) = 0.0450 W/kg

SAR(1 g) = 0.029 W/kg; SAR(10 g) = 0.018 W/kg

Maximum value of SAR (measured) = 0.0324 W/kg

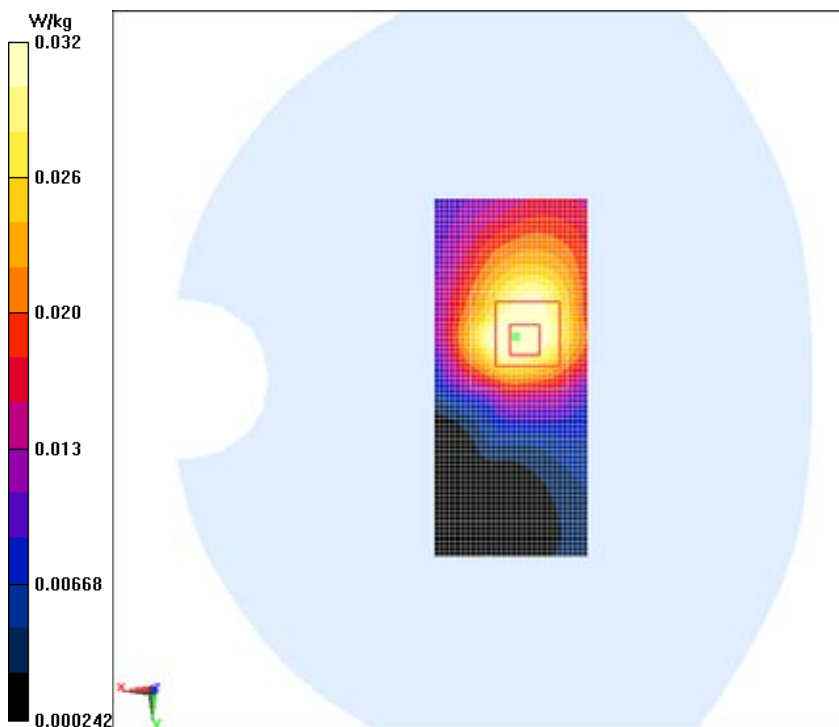

WiFi 802.11b Left Mode Middle

Date/Time: 2014/5/5

Electronics: DAE4 Sn1244

Medium: Body 2450MHz

Medium parameters used: $f = 2412$ MHz; $\sigma = 1.869$ S/m; $\epsilon_r = 53.925$; $\rho = 1000$ kg/m³

Ambient Temperature: 22.5°C Liquid Temperature: 22.5°C

Communication System: Wifi 2450 2450MHz; Frequency: 2412 MHz; Duty Cycle: 1:1

Probe: EX3DV4 - SN3754ConvF(6.66, 6.66, 6.66); Calibrated: 8/8/2013

WiFi 802.11b Left Mode Middle/Area Scan (31x111x1):

Measurement grid: dx=10 mm, dy=10 mm

Maximum value of SAR (Measurement) = 0.0230 W/kg

WiFi 802.11b Left Mode Middle/Zoom Scan 2 (5x5x7)/Cube 0:

Measurement grid: dx=5mm, dy=5mm, dz=5mm

Reference Value = 2.089 V/m; Power Drift = 0.10 dB

Peak SAR (extrapolated) = 0.0360 W/kg

SAR(1 g) = 0.021 W/kg; SAR(10 g) = 0.013 W/kg

Maximum of SAR (measured) = 0.0233 W/kg

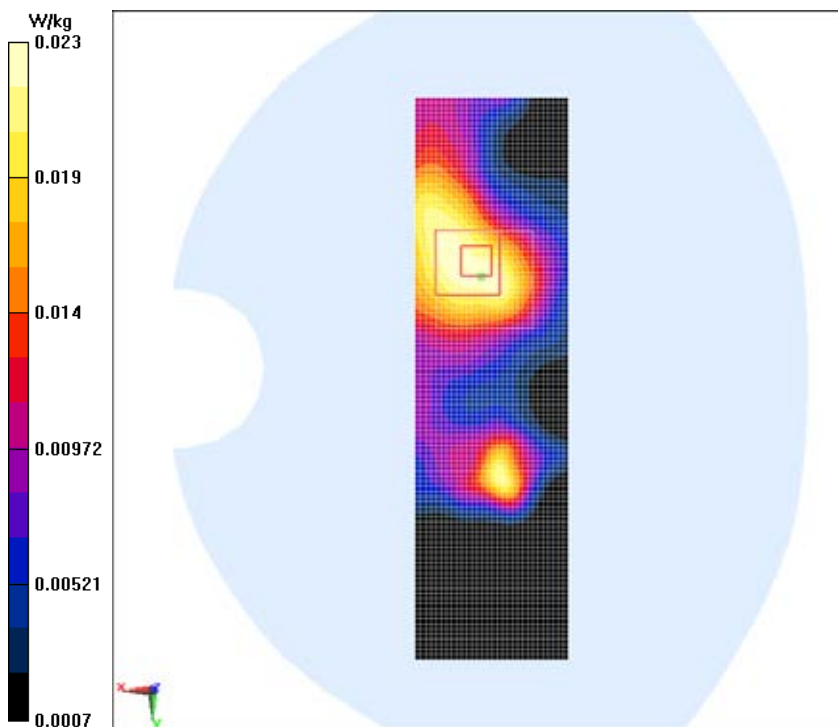

WiFi 802.11b Right Mode Middle

Date/Time: 2014/5/5

Electronics: DAE4 Sn1244

Medium: Body 2450MHz

Medium parameters used: $f = 2412$ MHz; $\sigma = 1.869$ S/m; $\epsilon_r = 53.925$; $\rho = 1000$ kg/m³

Ambient Temperature: 22.5°C Liquid Temperature: 22.5°C

Communication System: Wifi 2450 2450MHz; Frequency: 2412 MHz; Duty Cycle: 1:1

Probe: EX3DV4 - SN3754ConvF(6.66, 6.66, 6.66); Calibrated: 8/8/2013

WiFi 802.11b Right Mode Middle/Area Scan (31x111x1):

Measurement grid: dx=10 mm, dy=10 mm

Maximum value of SAR (Measurement) = 0.341 W/kg

WiFi 802.11b Right Mode Middle/Zoom Scan (7x7x7)/Cube 0:

Measurement grid: dx=5mm, dy=5mm, dz=5mm

Reference Value = 7.969 V/m; Power Drift = 0.11 dB

Peak SAR (extrapolated) = 0.550 W/kg

SAR(1 g) = 0.305 W/kg; SAR(10 g) = 0.150 W/kg

Maximum value of SAR (measured) = 0.356 W/kg

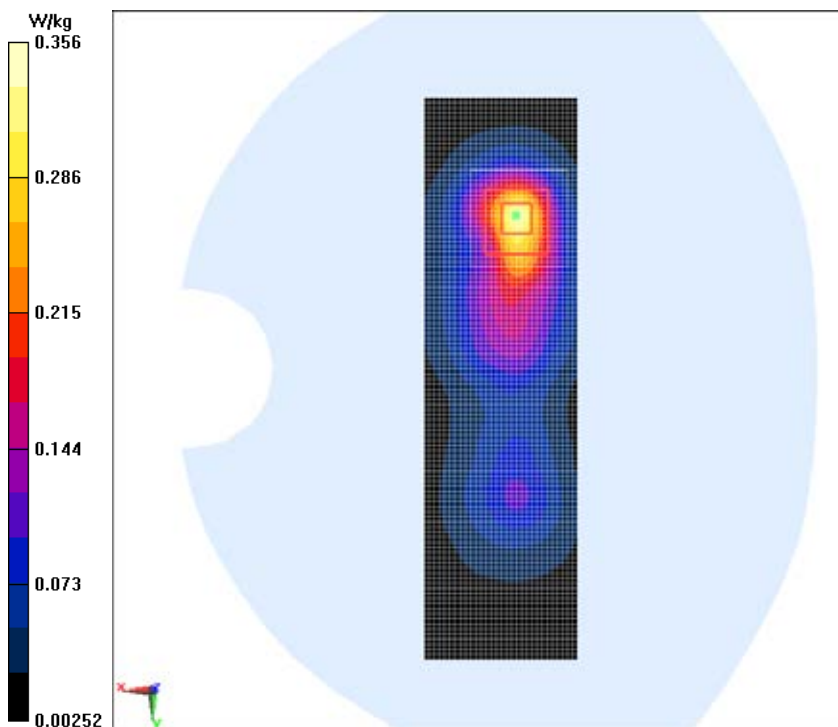

ANNEX B. SYSTEM VALIDATION RESULTS

835MHz-Head

Date/Time: 4/25/2014

Electronics: DAE4 Sn1244

Medium: Head 835MHz

Medium parameters used: $f = 835 \text{ MHz}$; $\sigma = 0.917 \text{ mho/m}$; $\epsilon_r = 41.04$; $\rho = 1000 \text{ kg/m}^3$

Ambient Temperature: 22.5° C Liquid Temperature: 22.5° C

Communication System: CW; Frequency: 835 MHz; Duty Cycle: 1:1

Probe: ES3DV3 - SN3252ConvF(6.1, 6.1, 6.1); Calibrated: 8/5/2013

System Validation/Area Scan(101x101x1):Measurement grid: $dx=10\text{mm}$, $dy=10\text{mm}$

Maximum value of SAR (measured) = 2.63 mW/g

System Validation/Zoom Scan(7x7x7)/Cube 0:Measurement grid: $dx=5\text{mm}$, $dy=5\text{mm}$, $dz=5\text{mm}$

Reference Value = 60.065 V/m; Power Drift = 0.01 dB

Peak SAR (extrapolated) = 3.41 mW/g

SAR(1 g) = 2.29 mW/g; SAR(10 g) = 1.51 mW/g

Maximum value of SAR (measured) = 2.680 mW/g

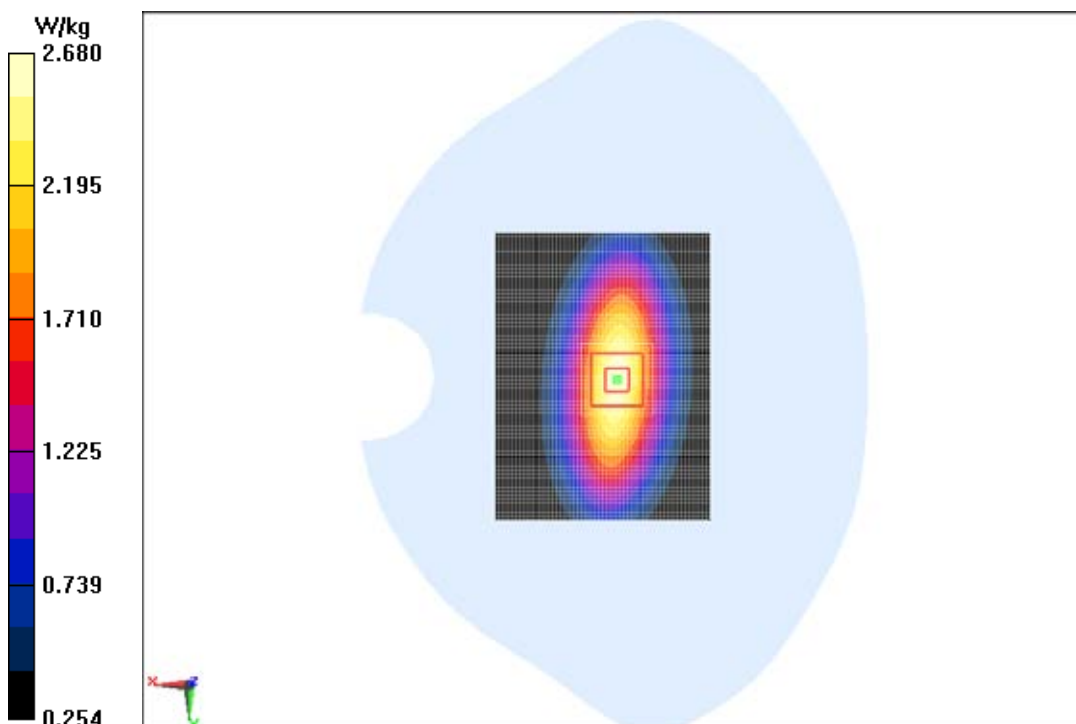

835MHz-Body

Date/Time: 4/26/2014

Electronics: DAE4 Sn1244

Medium: Body 850MHz

Medium parameters used: $f = 835$ MHz; $\sigma = 0.999$ mho/m; $\epsilon_r = 55.15$; $\rho = 1000$ kg/m³

Ambient Temperature: 22.5° C Liquid Temperature: 22.5° C

Communication System: CW; Frequency: 835 MHz; Duty Cycle: 1:1

Probe: ES3DV3 - SN3252ConvF(6.14, 6.14, 6.14); Calibrated: 8/5/2013

System Validation/Area Scan(101x101x1): Measurement grid: dx=10mm, dy=10mm

Maximum value of SAR (measured) = 2.59 mW/g

System Validation/Zoom Scan(7x7x7)/Cube 0: Measurement grid: dx=5mm, dy=5mm, dz=5mm

Reference Value = 60.203 V/m; Power Drift = 0.00 dB

Peak SAR (extrapolated) = 3.34 mW/g

SAR(1 g) = 2.25 mW/g; SAR(10 g) = 1.48 mW/g

Maximum value of SAR (measured) = 2.63 mW/g

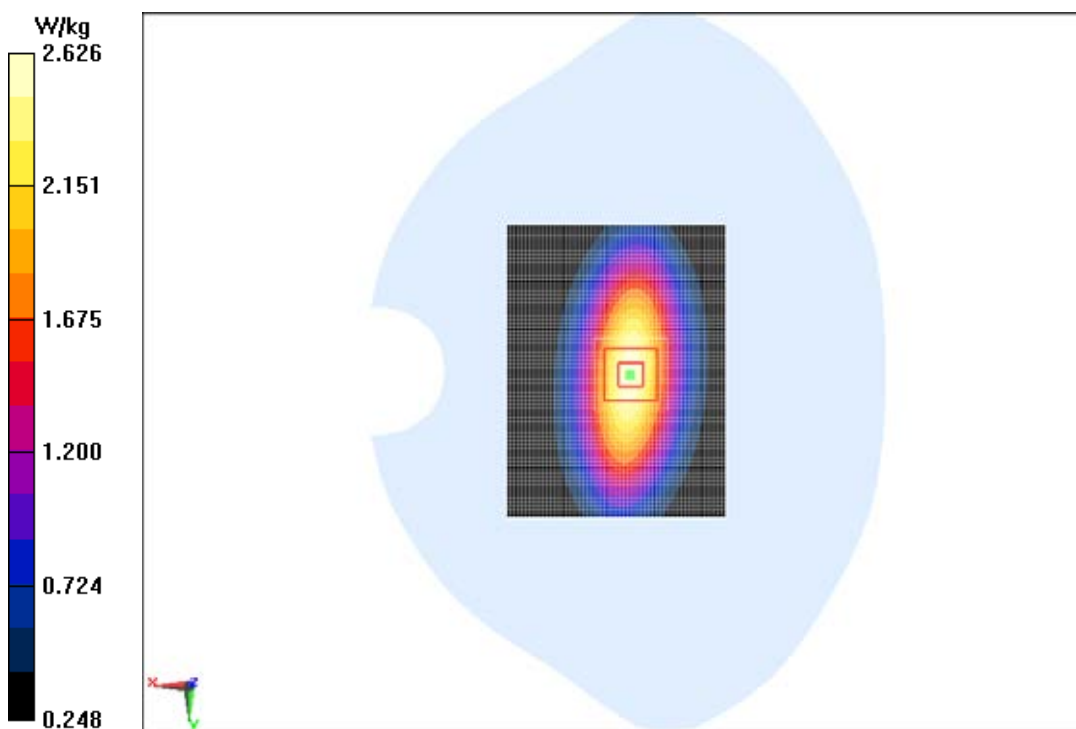

1900MHz-Head

Date/Time: 4/28/2014

Electronics: DAE4 Sn1244

Medium: Head 1900 MHz

Medium parameters used: $f = 1900$ MHz; $\sigma = 1.385$ mho/m; $\epsilon_r = 39.64$; $\rho = 1000$ kg/m³

Ambient Temperature: 22.5° C Liquid Temperature: 22.5° C

Communication System: CW; Frequency: 1900 MHz; Duty Cycle: 1:1

Probe: ES3DV3 - SN3252ConvF(5.24, 5.24, 5.24); Calibrated: 8/5/2013

System Validation/Area Scan(101x101x1): Measurement grid: dx=15mm, dy=15mm

Maximum value of SAR (measured) = 11.356 mW/g

System Validation/Zoom Scan(7x7x7)/Cube 0: Measurement grid: dx=5mm, dy=5mm, dz=5mm

Reference Value = 101.525 V/m; Power Drift = 0.02 dB

Peak SAR (extrapolated) = 18.376 mW/g

SAR(1 g) = 10.55mW/g; SAR(10 g) = 5.42mW/g

Maximum value of SAR (measured) = 13.5 mW/g

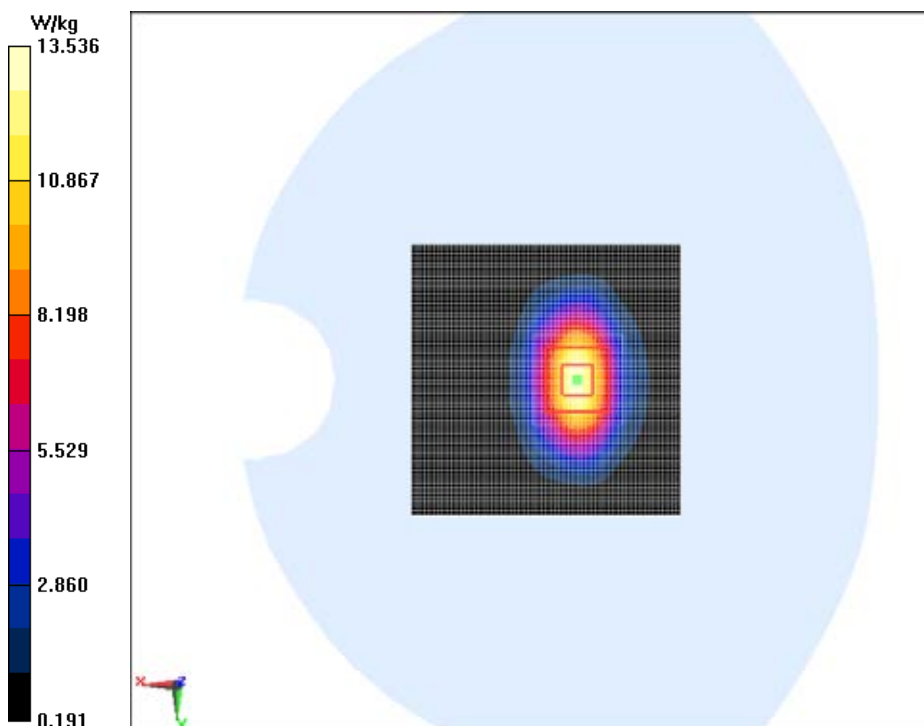

1900MHz-Body

Date/Time: 4/29/2014

Electronics: DAE4 Sn1244

Medium: Body 1900 MHz

Medium parameters used: $f = 1900$ MHz; $\sigma = 1.524$ mho/m; $\epsilon_r = 53.237$; $\rho = 1000$ kg/m³

Ambient Temperature: 22.5° C Liquid Temperature: 22.5° C

Communication System: CW; Frequency: 1900 MHz; Duty Cycle: 1:1

Probe: ES3DV3 - SN3252ConvF(5.03, 5.03, 5.03); Calibrated: 8/5/2013

System Validation/Area Scan(101x101x1): Measurement grid: dx=15mm, dy=15mm

Maximum value of SAR (measured) = 13.8 mW/g

System Validation/Zoom Scan(7x7x7)/Cube 0: Measurement grid: dx=5mm, dy=5mm, dz=5mm

Reference Value = 92.696 V/m; Power Drift = -0.04 dB

Peak SAR (extrapolated) = 18.376 mW/g

SAR(1 g) = 10.9mW/g; SAR(10 g) = 5.6mW/g

Maximum value of SAR (measured) = 14.1 mW/g

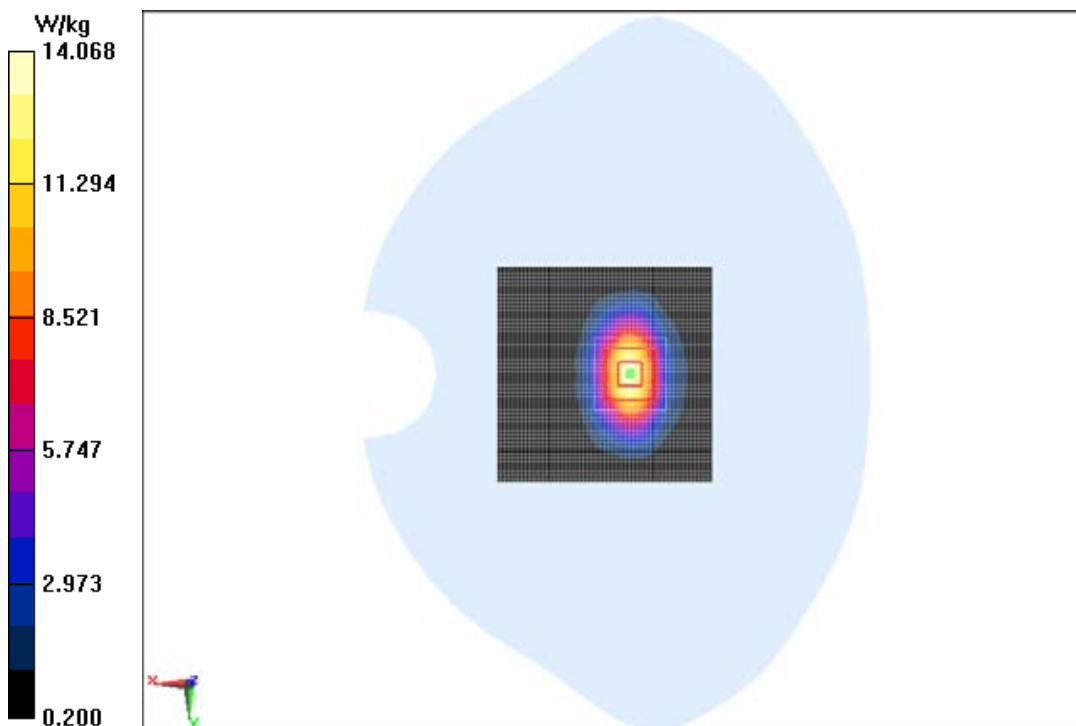

2450MHz-Head

Date/Time: 5/4/2014

Electronics: DAE4 Sn1244

Medium: Head 2450MHz

Medium parameters used: $f = 2450$ MHz; $\sigma = 1.809$ mho/m; $\epsilon_r = 39.12$; $\rho = 1000$ kg/m³

Ambien Temperature: 22.5° C Liquid Temperature: 22.5° C

Communication System: CW; Frequency: 2450 MHz; Duty Cycle: 1:1

Probe: EX3DV4 - SN3754ConvF(7.09, 7.09, 7.09); Calibrated: 8/8/2013

System Validation/ Area Scan (101x101x1): Measurement grid: dx=10mm, dy=10mm

Maximum value of SAR (measured) = 11.68 mW/g

System Validation/Zoom Scan (7x7x7)/Cube 0: Measurement grid: dx=5mm, dy=5mm, dz=5mm

Reference Value = 82.831 V/m; Power Drift = 0.03 dB

Peak SAR (extrapolated) = 16.473 mW/g

SAR(1 g) = 12.62 mW/g; SAR(10 g) = 5.97 mW/g

Maximum value of SAR (measured) = 13.4 mW/g

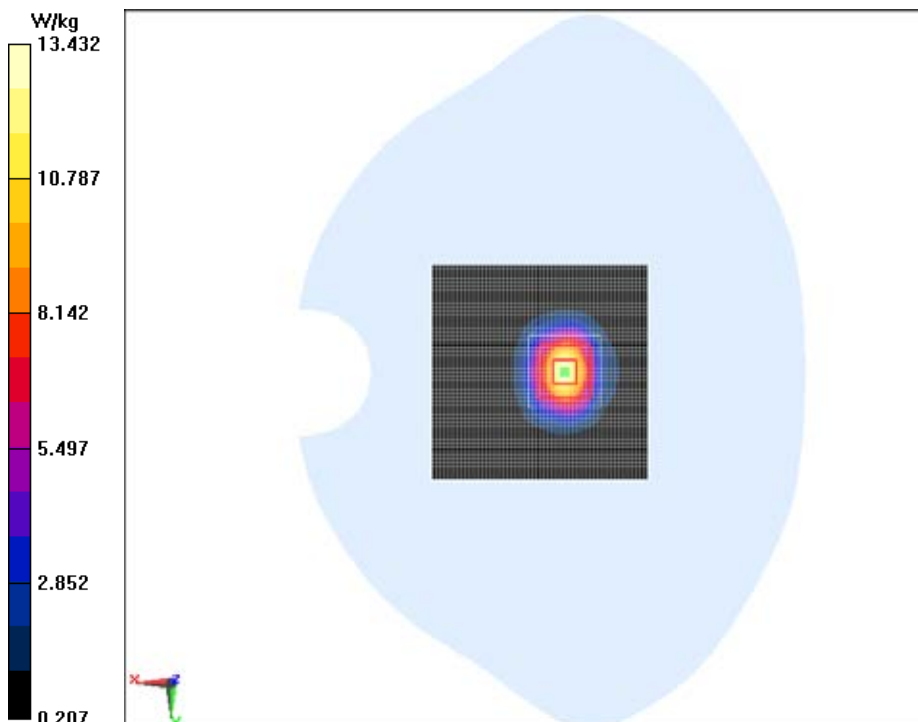

2450MHz-Body

Date/Time: 5/5/2014

Electronics: DAE4 Sn1244

Medium: Body 2450 MHz

Medium parameters used: $f = 2450$ MHz; $\sigma = 1.918$ mho/m; $\epsilon_r = 53.946$; $\rho = 1000$ kg/m³

Ambien Temperature: 22.5° C Liquid Temperature: 22.5° C

Communication System: CW; Frequency: 2450 MHz; Duty Cycle: 1:1

Probe: EX3DV4 - SN3754ConvF(6.66, 6.66, 6.66); Calibrated: 8/8/2013

System Validation/ Area Scan (101x101x1): Measurement grid: dx=10mm, dy=10mm

Maximum value of SAR (measured) = 12.962 mW/g

System Validation/Zoom Scan (7x7x7)/Cube 0: Measurement grid: dx=5mm, dy=5mm, dz=5mm

Reference Value = 84.466 V/m; Power Drift = 0.09 dB

Peak SAR (extrapolated) = 24.396 mW/g

SAR(1 g) = 11.97 mW/g; SAR(10 g) = 5.56 mW/g

Maximum value of SAR (measured) = 13.9 mW/g

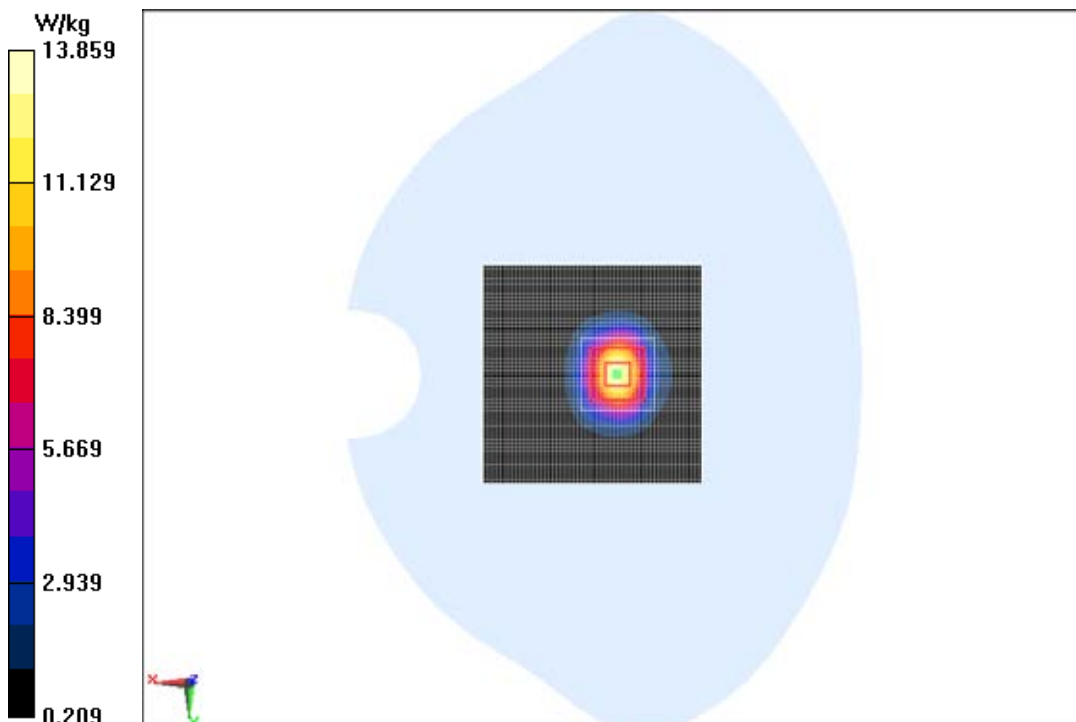

ANNEX C. SAR Measurement Setup

C.1. Measurement Set-up

The DASY5 system for performing compliance tests is illustrated above graphically. This system consists of the following items:

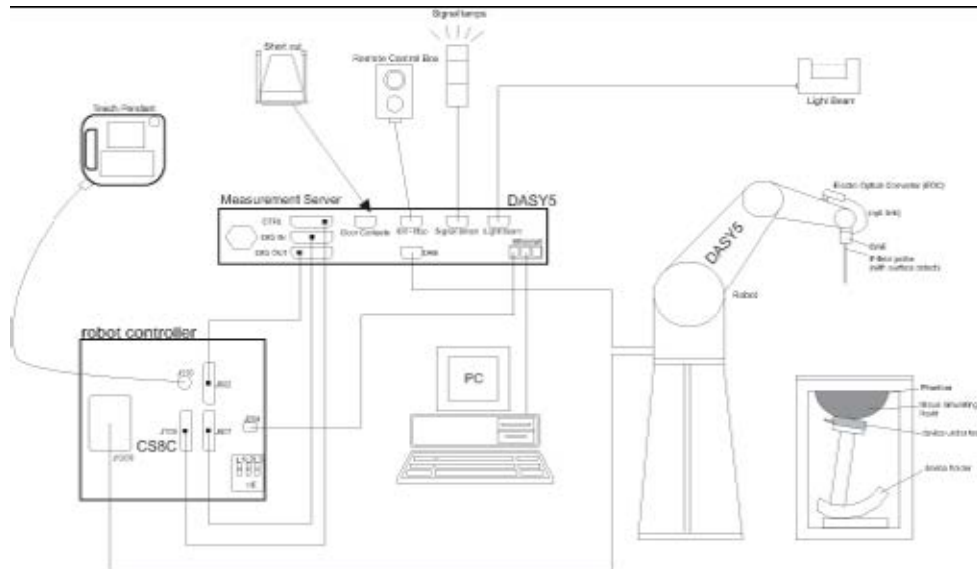

Picture C.1 SAR Lab Test Measurement Set-up

- A standard high precision 6-axis robot (Stäubli TX=RX family) with controller, teach pendant and software. An arm extension for accommodating the data acquisition electronics (DAE).
- An isotropic field probe optimized and calibrated for the targeted measurement.
- A data acquisition electronics (DAE) which performs the signal amplification, signal multiplexing, AD-conversion, offset measurements, mechanical surface detection, collision detection, etc. The unit is battery powered with standard or rechargeable batteries. The signal is optically transmitted to the EOC.
- The Electro-optical converter (EOC) performs the conversion from optical to electrical signals for the digital communication to the DAE. To use optical surface detection, a special version of the EOC is required. The EOC signal is transmitted to the measurement server.
- The function of the measurement server is to perform the time critical tasks such as signal filtering, control of the robot operation and fast movement interrupts.
- The Light Beam used is for probe alignment. This improves the (absolute) accuracy of the probe positioning.
- A computer running WinXP and the DASY5 software.
- Remote control and teach pendant as well as additional circuitry for robot safety such as
- warning lamps, etc.
- The phantom, the device holder and other accessories according to the targeted measurement.

C.2. DASY5 E-field Probe System

The SAR measurements were conducted with the dosimetric probe designed in the classical triangular configuration and optimized for dosimetric evaluation. The probe is constructed using the thick film technique; with printed resistive lines on ceramic substrates. The probe is equipped with an optical multifiber line ending at the front of the probe tip. It is connected to the EOC box on the robot arm and provides an automatic detection of the phantom surface. Half of the fibers are connected to a pulsed infrared transmitter, the other half to a synchronized receiver. As the probe approaches the surface, the reflection from the surface produces a coupling from the transmitting to the receiving fibers. This reflection increases first during the approach, reaches maximum and then decreases. If the probe is flatly touching the surface, the coupling is zero. The distance of the coupling maximum to the surface is independent of the surface reflectivity and largely independent of the surface to probe angle. The DASY5 software reads the reflection during a software approach and looks for the maximum using 2nd order curve fitting. The approach is stopped at reaching the maximum.

Probe Specifications:

- Model:** ES3DV3, EX3DV4
- Frequency** 2.0GHz — 3.0GHz(EX3DV4)
- Range:** 700MHz — 2.0GHz(ES3DV3)
- Calibration:** In head and body simulating tissue at Frequencies from 835 up to 2450MHz
- Linearity:** ± 0.2 dB(2.0GHz — 3.0GHz) for EX3DV4
± 0.2 dB(700MHz — 2.0GHz) for ES3DV3
- Dynamic Range:** 10 mW/kg — 100W/kg
- Probe Length:** 330 mm
- Probe Tip**
- Length:** 20 mm
- Body Diameter:** 12 mm
- Tip Diameter:** 2.5 mm (3.9 mm for ES3DV3)
- Tip-Center:** 1 mm (2.0mm for ES3DV3)
- Application:**SAR Dosimetry Testing
Compliance tests of mobile phones



Picture C.2 Near-field Probe



Dosimetry in strong gradient fields

Picture C.3 E-field Probe

C.3. E-field Probe Calibration

Each E-Probe/Probe Amplifier combination has unique calibration parameters. A TEM cell calibration procedure is conducted to determine the proper amplifier settings to enter in the probe parameters. The amplifier settings are determined for a given frequency by subjecting the probe to a known E-field density (1 mW/cm²) using an RF Signal generator, TEM cell, and RF Power Meter.

The free space E-field from amplified probe outputs is determined in a test chamber. This calibration can be performed in a TEM cell if the frequency is below 1 GHz and in a waveguide or other methodologies above 1 GHz for free space. For the free space calibration, the probe is

placed in the volumetric center of the cavity and at the proper orientation with the field. The probe is then rotated 360 degrees until the three channels show the maximum reading. The power density readings equates to 1 mW/ cm²:

E-field temperature correlation calibration is performed in a flat phantom filled with the appropriate simulated brain tissue. The E-field in the medium correlates with the temperature rise in the dielectric medium. For temperature correlation calibration a RF transparent thermistor-based temperature probe is used in conjunction with the E-field probe.

$$SAR = C \frac{\Delta T}{\Delta t}$$

Where:

Δt = Exposure time (30 seconds),

C = Heat capacity of tissue (brain or muscle),

ΔT = Temperature increase due to RF exposure.

$$SAR = \frac{|E|^2 \cdot \sigma}{\rho}$$

Where:

σ = Simulated tissue conductivity,

ρ = Tissue density (kg/m³).

C.4. Other Test Equipment

C.4.1. Data Acquisition Electronics(DAE)

The data acquisition electronics consist of a highly sensitive electrometer-grade preamplifier with auto-zeroing, a channel and gain-switching multiplexer, a fast 16 bit AD-converter and a command decoder with a control logic unit. Transmission to the measurement server is accomplished through an optical downlink for data and status information, as well as an optical uplink for commands and the clock.

The mechanical probe mounting device includes two different sensor systems for frontal and sideways probe contacts. They are used for mechanical surface detection and probe collision detection.

The input impedance of the DAE is 200 MOhm; the inputs are symmetrical and floating. Common mode rejection is above 80 dB.



PictureC.4: DAE

C.4.2. Robot

The SPEAG DASY system uses the high precision robots (DASY5: RX90L) type from Stäubli SA (France). For the 6-axis controller system, the robot controller version from Stäubli is used. The Stäubli robot series have many features that are important for our application:

- High precision (repeatability 0.02mm)
- High reliability (industrial design)
- Low maintenance costs (virtually maintenance free due to direct drive gears; no belt drives)
- Jerk-free straight movements (brushless synchron motors; no stepper motors)
- Low ELF interference (motor control fields shielded via the closed metallic construction shields)



Picture C.5 DASY 5

C.4.3. Measurement Server

The Measurement server is based on a PC/104 CPU board with CPU (DASY5: 400 MHz, Intel Celeron), chipdisk (DASY5: 128MB), RAM (DASY5: 128MB). The necessary circuits for communication with the DAE electronic box, as well as the 16 bit AD converter system for optical detection and digital I/O interface are contained on the DASY I/O board, which is directly connected to the PC/104 bus of the CPU board.

The measurement server performs all real-time data evaluation of field measurements and surface detection, controls robot movements and handles safety operation. The PC operating system cannot interfere with these time critical processes. All connections are supervised by a watchdog, and disconnection of any of the cables to the measurement server will automatically disarm the robot and disable all program-controlled robot movements. Furthermore, the measurement server

is equipped with an expansion port which is reserved for future applications. Please note that this expansion port does not have a standardized pinout, and therefore only devices provided by SPEAG can be connected. Devices from any other supplier could seriously damage the measurement server.



Picture C.6 Server for DASY 5

C.4.4. Device Holder for Phantom

The SAR in the phantom is approximately inversely proportional to the square of the distance between the source and the liquid surface. For a source at 5mm distance, a positioning uncertainty of $\pm 0.5\text{mm}$ would produce a SAR uncertainty of $\pm 20\%$. Accurate device positioning is therefore crucial for accurate and repeatable measurements. The positions in which the devices must be measured are defined by the standards.

The DASY device holder is designed to cope with the different positions given in the standard. It has two scales for device rotation (with respect to the body axis) and device inclination (with respect to the line between the ear reference points). The rotation centers for both scales is the ear reference point (ERP). Thus the device needs no repositioning when changing the angles.

The DASY device holder is constructed of low-loss POM material having the following dielectric

parameters: relative permittivity $\epsilon = 3$ and loss tangent $\delta = 0.02$. The amount of dielectric material has been reduced in the closest vicinity of the device, since measurements have suggested that the influence of the clamp on the test results could thus be lowered.

<Laptop Extension Kit>

The extension is lightweight and made of POM, acrylic glass and foam. It fits easily on the upper part of the Mounting Device in place of the phone positioner. The extension is fully compatible with the Twin-SAM and ELI phantoms.

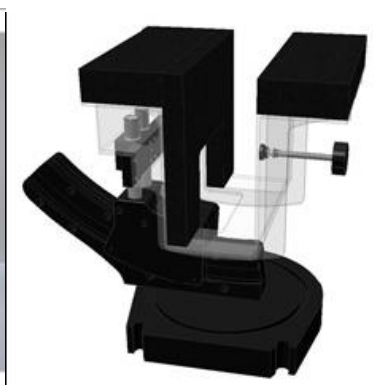

Picture C.7: Device Holder

Picture C.8: Laptop Extension Kit

C.4.5. Phantom

The SAM Twin Phantom V4.0 is constructed of a fiberglass shell integrated in a table. The shape of the shell is based on data from an anatomical study designed to represent the 90th percentile of the population. The phantom enables the dissymmetric evaluation of SAR for both left and right handed handset usage, as well as body-worn usage using the flat phantom region. Reference markings on the Phantom allow the complete setup of all predefined phantom positions and measurement grids by manually teaching three points in the robot. The shell phantom has a 2mm shell thickness (except the ear region where shell thickness increases to 6 mm).

Shell Thickness: 2 ± 0.2 mm

Filling Volume: Approx. 25 liters

Dimensions: 810 x 1000 x 500 mm (H x L x W)

Available: Special



Picture C.9: SAM Twin Phantom

ANNEX D. Position of the wireless device in relation to the phantom

D.1. General considerations

This standard specifies two handset test positions against the head phantom – the “cheek” position and the “tilt” position.

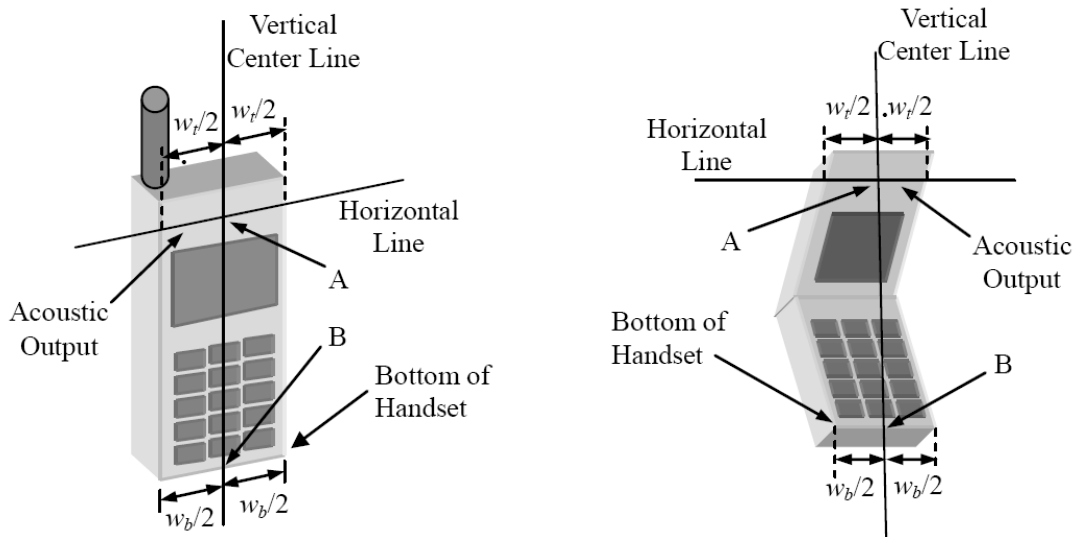

- w_t Width of the handset at the level of the acoustic
- w_b Width of the bottom of the handset
- A Midpoint of the width w_t of the handset at the level of the acoustic output
- B Midpoint of the width w_b of the bottom of the handset

Picture D.1-a Typical “fixed” case handset Picture D.1-b Typical “clam-shell” case handset

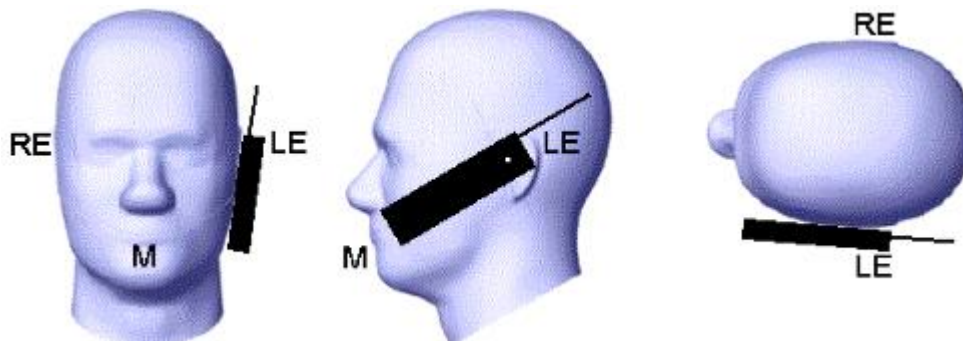

Picture D.2 Cheek position of the wireless device on the left side of SAM

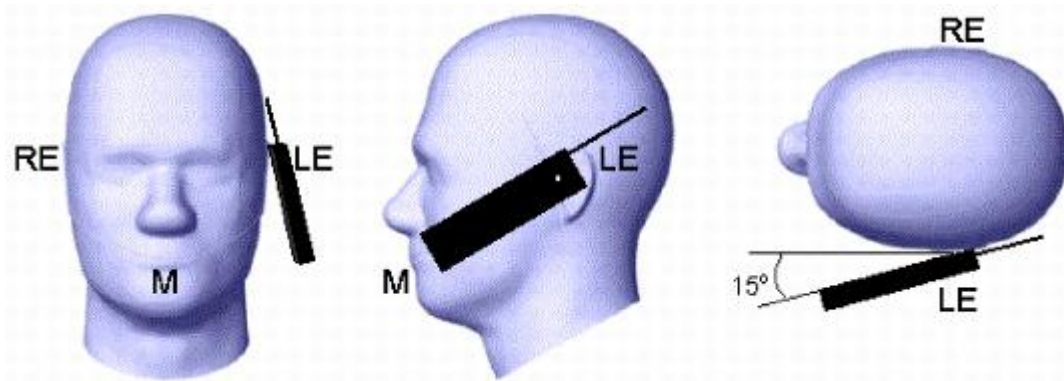

Picture D.3 Tilt position of the wireless device on the left side of SAM

D.2. Body-worn device

A typical example of a body-worn device is a mobile phone, wireless enabled PDA or other battery operated wireless device with the ability to transmit while mounted on a person's body using a carry accessory approved by the wireless device manufacturer.

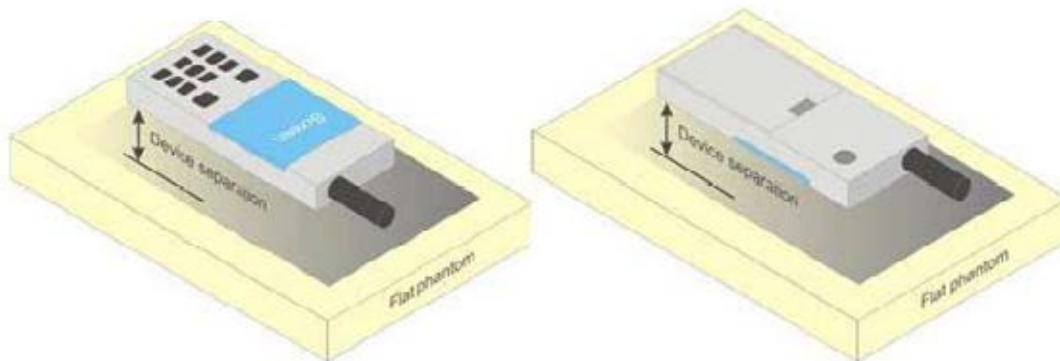

Picture D.4 Test positions for body-worn devices

D.3. Desktop device

A typical example of a desktop device is a wireless enabled desktop computer placed on a table or desk when used.

The DUT shall be positioned at the distance and in the orientation to the phantom that corresponds to the intended use as specified by the manufacturer in the user instructions. For devices that employ an external antenna with variable positions, tests shall be performed for all antenna positions specified. Picture 8.5 show positions for desktop device SAR tests. If the intended use is not specified, the device shall be tested directly against the flat phantom.

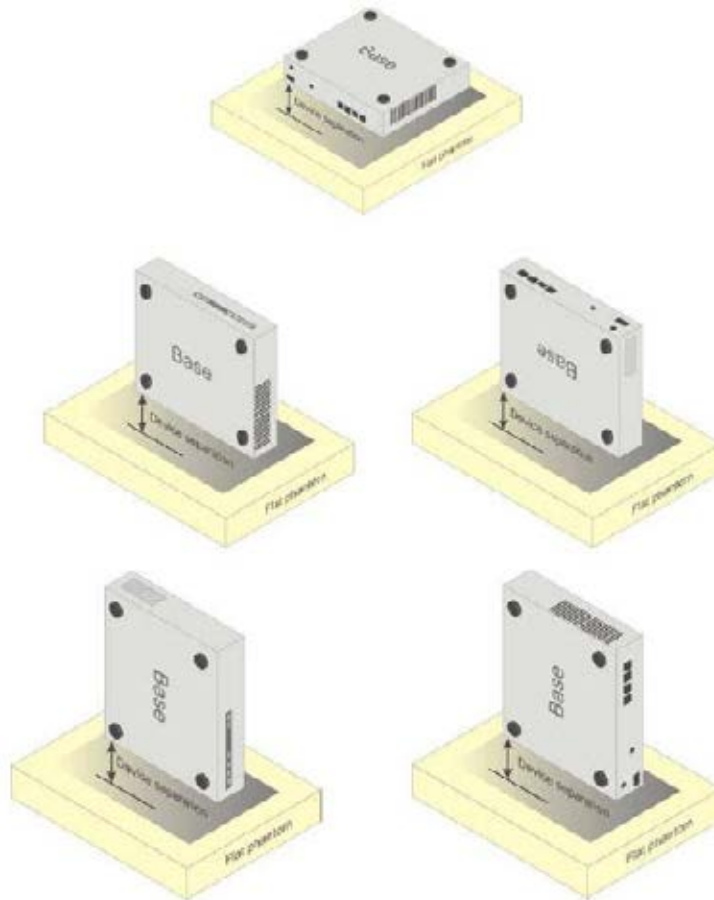

Picture D.5 Test positions for desktop devices

D.4. DUT Setup Photos**Picture D.6 DSY5 system Set-up****Note:**

The photos of test sample and test positions show in additional document.

ANNEX E. Equivalent Media Recipes

The liquid used for the frequency range of 800-3000 MHz consisted of water, sugar, salt, preventol, glycol monobutyl and Cellulose. The liquid has been previously proven to be suited for worst-case. The Table E.1 shows the detail solution. It's satisfying the latest tissue dielectric parameters requirements proposed by the IEEE 1528 and IEC 62209.

Table E.1: Composition of the Tissue Equivalent Matter

Frequency (MHz)	835 Head	835 Body	1900 Head	1900 Body	2450 Head	2450 Body
Ingredients (% by weight)						
Water	41.45	52.5	55.242	69.91	58.79	72.60
Sugar	56.0	45.0	\	\	\	\
Salt	1.45	1.4	0.306	0.13	0.06	0.18
Preventol	0.1	0.1	\	\	\	\
Cellulose	1.0	1.0	\	\	\	\
Glycol Monobutyl	\	\	44.452	29.96	41.15	27.22
Dielectric Parameters Target Value	$\epsilon=41.5$ $\sigma=0.90$	$\epsilon=55.2$ $\sigma=0.97$	$\epsilon=40.0$ $\sigma=1.40$	$\epsilon=53.3$ $\sigma=1.52$	$\epsilon=39.2$ $\sigma=1.80$	$\epsilon=52.7$ $\sigma=1.95$

ANNEX F. System Validation

The SAR system must be validated against its performance specifications before it is deployed. When SAR probes, system components or software are changed, upgraded or recalibrated, these must be validated with the SAR system(s) that operates with such components.

Table F.1: System Validation Part 1

System No.	Probe SN.	Liquid name	Validation date	Frequency point	Permittivity ϵ	Conductivity σ (S/m)
1	3252	Head 835MHz	Aug 15,2013	835MHz	41.01	0.923
2	3252	Head 1900MHz	Aug 15,2013	1900MHz	39.66	1.424
3	3754	Head 2450MHz	Aug 15,2013	2450MHz	39.13	1.794
4	3252	Body 835MHz	Aug 15,2013	835MHz	55.13	0.979
5	3252	Body 1900MHz	Aug 15,2013	1900MHz	53.22	1.528
6	3754	Body 2450MHz	Aug 15,2013	2450MHz	53.94	1.946

Table F.2: System Validation Part 2

CW Validation	Sensitivity	PASS	PASS
	Probe linearity	PASS	PASS
	Probe Isotropy	PASS	PASS
Mod Validation	MOD.type	GMSK	GMSK
	MOD.type	OFDM	OFDM
	Duty factor	PASS	PASS
	PAR	PASS	PASS

ANNEX G. Probe and DAE Calibration Certificate



TMC

In Collaboration with
s p e a g
CALIBRATION LABORATORY

Add: No.52 Huayuanbei Road, Haidian District, Beijing, 100191, China
 Tel: +86-10-62304633-2079 Fax: +86-10-62304633-2504
 E-mail: info@emcrite.com Http://www.emcrite.com



校 准
CNAS L0442

Client : **CATR-SH** Certificate No.: **JZ13-2-2040**

CALIBRATION CERTIFICATE

Object: **DAE4 - SN: 1244**

Calibration Procedure(s): **TMC-OS-E-01-198
Calibration Procedure for the Data Acquisition Electronics (DAEx)**

Calibration date: **July 9, 2013**

This calibration Certificate documents the traceability to national standards, which realize the physical units of measurements(SI). The measurements and the uncertainties with confidence probability are given on the following pages and are part of the certificate.

All calibrations have been conducted in the closed laboratory facility: environment temperature(22±3)℃ and humidity<70%.

Calibration Equipment used (M&TE critical for calibration)

Primary Standards	ID #	Cal Date(Calibrated by, Certificate No.)	Scheduled Calibration
Documenting Process Calibrator 753	1971018	01-July-13 (TMC, No.JW13-049)	July-14

	Name	Function	Signature
Calibrated by:	Zhao Jing	SAR Test Engineer	
Reviewed by:	Qi Dianyuan	SAR Project Leader	
Approved by:	Xiao Li	Deputy Director of the laboratory	

Issued: July 24, 2013

This calibration certificate shall not be reproduced except in full without written approval of the laboratory.

Certificate No: JZ13-2-2040

Page 1 of 3



Add: No.52 Huayuanbei Road, Haidian District, Beijing, 100191, China
Tel: +86-10-62304633-2079 Fax: +86-10-62304633-2504
E-mail: info@emcic.com Http://www.emcic.com

Glossary:

DAE data acquisition electronics
Connector angle information used in DASY system to align probe sensor X to the robot coordinate system.

Methods Applied and Interpretation of Parameters:

- *DC Voltage Measurement:* Calibration Factor assessed for use in DASY system by comparison with a calibrated instrument traceable to national standards. The figure given corresponds to the full scale range of the voltmeter in the respective range.
- *Connector angle:* The angle of the connector is assessed measuring the angle mechanically by a tool inserted. Uncertainty is not required.
- The report provide only calibration results for DAE, it does not contain other performance test results.



Add: No.52 Huayuanbei Road, Haidian District, Beijing, 100191, China
 Tel: +86-10-62104633-2079 Fax: +86-10-62104633-2504
 E-mail: info@emcife.com <http://www.emcife.com>

DC Voltage Measurement

A/D - Converter Resolution nominal
 High Range: 1LSB = 6.1 μ V, full range = -100...+300 mV
 Low Range: 1LSB = 61nV, full range = -1.....+3mV
 DASy measurement parameters: Auto Zero Time: 3 sec; Measuring time: 3 sec

Calibration Factors	X	Y	Z
High Range	403.907 \pm 0.15% (k=2)	403.655 \pm 0.15% (k=2)	404.564 \pm 0.15% (k=2)
Low Range	3.98600 \pm 0.7% (k=2)	3.96971 \pm 0.7% (k=2)	4.01324 \pm 0.7% (k=2)

Connector Angle

Connector Angle to be used in DASy system	46° \pm 1°
---	--------------



In Collaboration with
s p e a g
CALIBRATION LABORATORY

Addr: No.52 Hanyuabei Road, Haidian District, Beijing, 100191, China
Tel: +86-10-62304633-2079 Fax: +86-10-62304633-2504
E-mail: info@emctc.com Http://www.emctc.com



Client

CATR-SH

Certificate No: J13-2-2042

CALIBRATION CERTIFICATE

Object ES3DV3 - SN:3252

 Calibration Procedure(s) TMC-OS-E-02-195
Calibration Procedures for Dosimetric E-field Probes



Calibration date: August 5, 2013

This calibration Certificate documents the traceability to national standards, which realize the physical units of measurements(SI). The measurements and the uncertainties with confidence probability are given on the following pages and are part of the certificate.

All calibrations have been conducted in the closed laboratory facility, environment temperature(22±3)°C and humidity<70%.

Calibration Equipment used (M&TE critical for calibration)

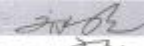
Primary Standards	ID #	Cal Date(Calibrated by, Certificate No.)	Scheduled Calibration
Power Meter NRP2	101919	01-Jul-13 (TMC, No.JW13-044)	Jun-14
Power sensor NRP-Z91	101547	01-Jul-13 (TMC, No.JW13-044)	Jun-14
Power sensor NRP-Z91	101548	01-Jul-13 (TMC, No.JW13-044)	Jun-14
Reference10dBAttenuator	BT0520	12-Dec-12(TMC, No.JZ12-887)	Dec-14
Reference20dBAttenuator	BT0267	12-Dec-12(TMC, No.JZ12-888)	Dec-14
Reference Probe EX3DV4	SN 3848	20-Dec-12(SPEAG, No.EX3-3848_Dec12)	Dec-13
DAE4	SN 777	22-Feb-13 (SPEAG, DAE4-777_Feb13)	Feb -14
Secondary Standards	ID #	Cal Date(Calibrated by, Certificate No.)	Scheduled Calibration
SignalGeneratorMG3700A	6201052605	01-Jul-13 (TMC, No.JW13-045)	Jun-14
Network Analyzer E5071C	MY46110673	15-Feb-13 (TMC, No.JZ13-781)	Feb-14

	Name	Function	Signature
Calibrated by:	Zhao Jing	SAR Test Engineer	
Reviewed by:	Qi Dianyuan	SAR Project Leader	
Approved by:	Xiao Li	Deputy Director of the laboratory	

Issued: August 7, 2013

This calibration certificate shall not be reproduced except in full without written approval of the laboratory.

Certificate No: J13-2-2042

Page 1 of 11



Addr: No.52 Huayuanbei Road, Haidian District, Beijing, 100191, China
Tel: +86-10-62304633-2079 Fax: +86-10-62304633-2504
E-mail: Info@emctc.com Http://www.emctc.com

Glossary:

TSL	tissue simulating liquid
NORM _{x,y,z}	sensitivity in free space
ConvF	sensitivity in TSL / NORM _{x,y,z}
DCP	diode compression point
CF	crest factor (1/duty_cycle) of the RF signal
A,B,C,D	modulation dependent linearization parameters
Polarization Φ	Φ rotation around probe axis
Polarization θ	θ rotation around an axis that is in the plane normal to probe axis (at measurement center), $\theta=0$ is normal to probe axis

Calibration is Performed According to the Following Standards:

- IEEE Std 1528-2003, "IEEE Recommended Practice for Determining the Peak Spatial-Averaged Specific Absorption Rate (SAR) in the Human Head from Wireless Communications Devices: Measurement Techniques", December 2003
- IEC 62209-1, "Procedure to measure the Specific Absorption Rate (SAR) for hand-held devices used in close proximity to the ear (frequency range of 300MHz to 3GHz)", February 2005

Methods Applied and Interpretation of Parameters:

- NORM_{x,y,z}: Assessed for E-field polarization $\theta=0$ (fs900MHz in TEM-cell; $f>1800$ MHz: waveguide). NORM_{x,y,z} are only intermediate values, i.e., the uncertainties of NORM_{x,y,z} does not effect the E^2 -field uncertainty inside TSL (see below ConvF).
- NORM(f)_{x,y,z} = NORM_{x,y,z} * frequency_response (see Frequency Response Chart). This linearization is implemented in DASY4 software versions later than 4.2. The uncertainty of the frequency response is included in the stated uncertainty of ConvF.
- DCP_{x,y,z}: DCP are numerical linearization parameters assessed based on the data of power sweep (no uncertainty required). DCP does not depend on frequency nor media.
- PAR: PAR is the Peak to Average Ratio that is not calibrated but determined based on the signal characteristics.
- A_{x,y,z}; B_{x,y,z}; C_{x,y,z}; VR_{x,y,z}; A,B,C are numerical linearization parameters assessed based on the data of power sweep for specific modulation signal. The parameters do not depend on frequency nor media. VR is the maximum calibration range expressed in RMS voltage across the diode.
- ConvF and Boundary Effect Parameters: Assessed in flat phantom using E-field (or Temperature Transfer Standard for fs800MHz) and inside waveguide using analytical field distributions based on power measurements for $f>900$ MHz. The same setups are used for assessment of the parameters applied for boundary compensation (alpha, depth) of which typical uncertainty valued are given. These parameters are used in DASY4 software to improve probe accuracy close to the boundary. The sensitivity in TSL corresponds to NORM_{x,y,z} * ConvF whereby the uncertainty corresponds to that given for ConvF. A frequency dependent ConvF is used in DASY version 4.4 and higher which allows extending the validity from ± 50 MHz to ± 100 MHz.
- Spherical isotropy (3D deviation from isotropy): in a field of low gradients realized using a flat phantom exposed by a patch antenna.
- Sensor Offset: The sensor offset corresponds to the offset of virtual measurement center from the probe tip (on probe axis). No tolerance required.
- Connector Angle: The angle is assessed using the information gained by determining the NORM_x (no uncertainty required).



Add: No.52 Huayuanbei Road, Haidian District, Beijing, 100191, China
Tel: +86-10-62304633-2079 Fax: +86-10-62304633-2504
E-mail: info@entcic.com Http://www.entcic.com

Probe ES3DV3

SN: 3252

Calibrated: August 5, 2013

Calibrated for DASY/EASY Systems

(Note: non-compatible with DASY2 system!)



Add: No.52 Huayuanbei Road, Haidian District, Beijing, 100191, China
 Tel: +86-10-62304633-2079 Fax: +86-10-62304633-2504
 E-mail: info@emcete.com http://www.emcete.com

DASY – Parameters of Probe: ES3DV3 - SN: 3252

Basic Calibration Parameters

	Sensor X	Sensor Y	Sensor Z	Unc (k=2)
Norm($\mu V/(V/m)^2$) ^A	1.29	1.34	1.32	±10.8%
DCP(mV) ^B	103.4	104.6	102.4	

Modulation Calibration Parameters

UID	Communication System Name		A dB	B dB/μV	C	D dB	VR mV	Unc ^E (k=2)
0	CW	X	0.0	0.0	1.0	0.00	207.8	±3.3%
		Y	0.0	0.0	1.0		209.7	
		Z	0.0	0.0	1.0		209.5	

The reported uncertainty of measurement is stated as the standard uncertainty of Measurement multiplied by the coverage factor k=2, which for a normal distribution Corresponds to a coverage probability of approximately 95%.

^A The uncertainties of Norm X, Y, Z do not affect the E²-field uncertainty inside TSL (see Page 5 and Page 6).
^B Numerical linearization parameter: uncertainty not required.
^E Uncertainty is determined using the max. deviation from linear response applying rectangular distribution and is expressed for the square of the field value.



DASY – Parameters of Probe: ES3DV3 - SN: 3252

Calibration Parameter Determined in Head Tissue Simulating Media

f [MHz] ^c	Relative Permittivity ^e	Conductivity (S/m) ^f	ConvF X	ConvF Y	ConvF Z	Alpha	Depth (mm)	Unct. (k=2)
850	41.5	0.92	6.10	6.10	6.10	0.27	1.98	±12%
900	41.5	0.97	6.19	6.19	6.19	0.31	1.79	±12%
1750	40.1	1.37	5.58	5.58	5.58	0.37	1.87	±12%
1900	40.0	1.40	5.24	5.24	5.24	0.43	1.82	±12%

^c Frequency validity of ±100MHz only applies for DASY v4.4 and higher (Page 2), else it is restricted to ±50MHz. The uncertainty is the RSS of ConvF uncertainty at calibration frequency and the uncertainty for the indicated frequency band.

^e At frequency below 3 GHz, the validity of tissue parameters (ϵ and σ) can be relaxed to ±10% if liquid compensation formula is applied to measured SAR values. At frequencies above 3 GHz, the validity of tissue parameters (ϵ and σ) is restricted to ±5%. The uncertainty is the RSS of the ConvF uncertainty for indicated target tissue parameters.



Add: No.52 Huayuanbei Road, Haidian District, Beijing, 100191, China
 Tel: +86-10-62504633-2079 Fax: +86-10-62504633-2504
 E-mail: info@emctc.com Http://www.emctc.com

DASY – Parameters of Probe: ES3DV3 - SN: 3252

Calibration Parameter Determined in Body Tissue Simulating Media

f [MHz] ^c	Relative Permittivity ^r	Conductivity (S/m) ^f	ConvF X	ConvF Y	ConvF Z	Alpha	Depth (mm)	Unct. (k=2)
850	55.2	0.99	6.14	6.14	6.14	0.40	1.69	±12%
900	55.0	1.05	6.11	6.11	6.11	0.39	1.60	±12%
1750	53.4	1.49	5.20	5.20	5.20	0.43	1.94	±12%
1900	53.3	1.52	5.03	5.03	5.03	0.46	1.85	±12%

^c Frequency validity of ±100MHz only applies for DASY v4.4 and higher (Page 2), else it is restricted to ±50MHz. The uncertainty is the RSS of ConvF uncertainty at calibration frequency and the uncertainty for the indicated frequency band.

^f At frequency below 3 GHz, the validity of tissue parameters (ϵ and σ) can be relaxed to ±10% if liquid compensation formula is applied to measured SAR values. At frequencies above 3 GHz, the validity of tissue parameters (ϵ and σ) is restricted to ±5%. The uncertainty is the RSS of the ConvF uncertainty for indicated target tissue parameters.



Add: No.52 Huayuanbei Road, Haidian District, Beijing, 100191, China
Tel: +86-10-62304633-2079 Fax: +86-10-62304633-2504
E-mail: Info@emctc.com Http://www.emctc.com

Frequency Response of E-Field (TEM-Cell: ifi110 EXX, Waveguide: R22)

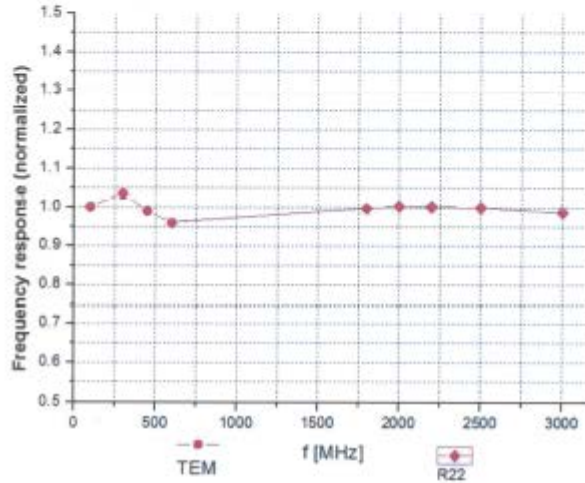

Uncertainty of Frequency Response of E-field: $\pm 7.5\%$ ($k=2$)



Add: No.52 Huayuanbei Road, Haidian District, Beijing, 100191, China
 Tel: +86-10-62304633-2079 Fax: +86-10-62304633-2504
 E-mail: info@emete.com http://www.emete.com

Receiving Pattern (Φ), $\theta=0^\circ$

f=600 MHz, TEM

f=1800 MHz, R22

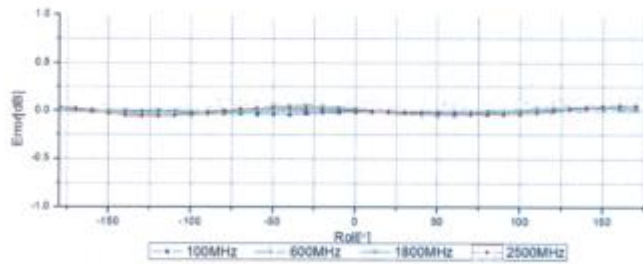
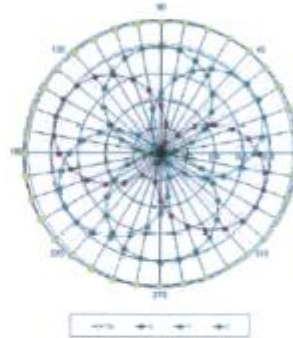
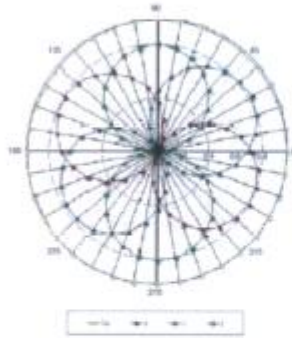

Uncertainty of Axial Isotropy Assessment: $\pm 0.9\%$ (k=2)



Add: No.52 Huzhuang Road, Haidian District, Beijing, 100191, China
 Tel: +86-10-62104633-2079 Fax: +86-10-62104633-2504
 E-mail: info@emcic.com Http://www.emcic.com

Dynamic Range f(SAR_{head}) (TEM cell, f = 900 MHz)

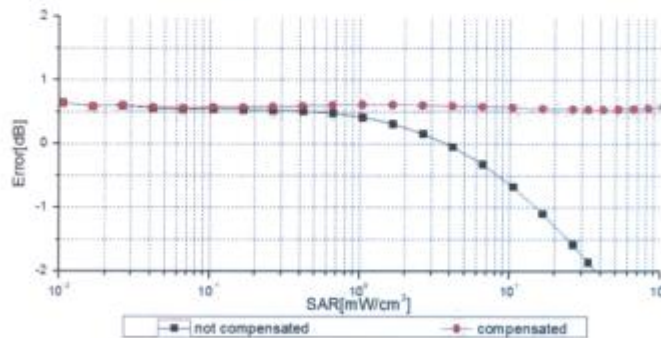
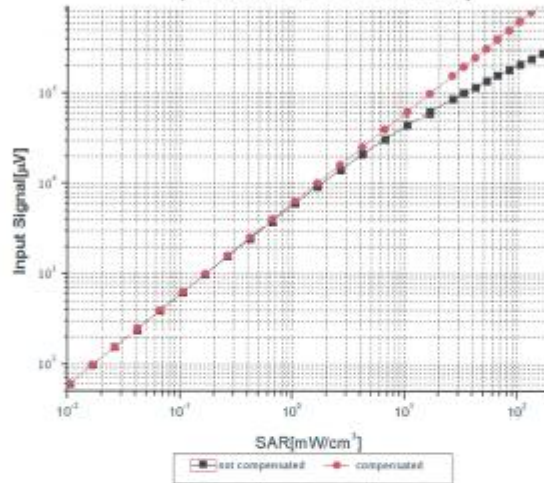

Uncertainty of Linearity Assessment: ±0.9% (k=2)



Add: No.52 Huayuanbei Road, Haidian District, Beijing, 100191, China
 Tel: +86-10-62304633-2079 Fax: +86-10-62304633-2504
 E-mail: Info@emults.com Http://www.emults.com

Conversion Factor Assessment

f=900 MHz, WGLS R9(H_convF)

f=1750 MHz, WGLS R22(H_convF)

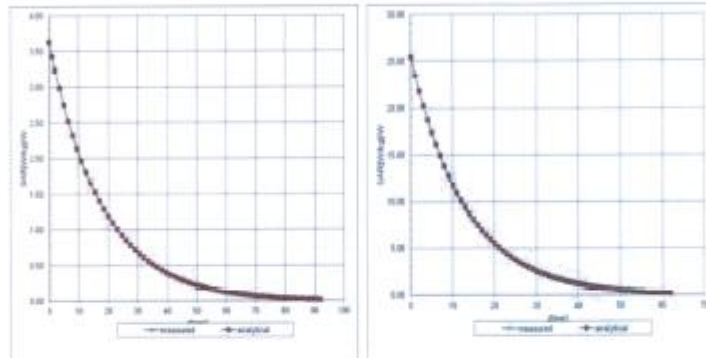

Deviation from Isotropy in Liquid

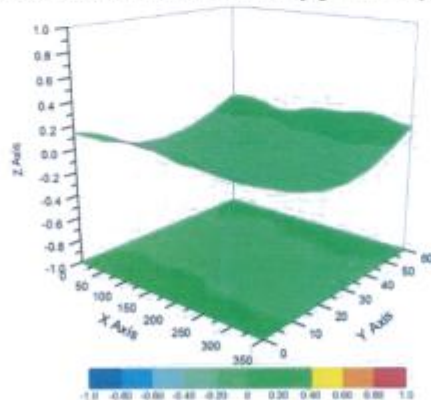

Uncertainty of Spherical Isotropy Assessment: ±2.8% (K=2)



Addr: No.52 Huayuanbei Road, Haidian District, Beijing, 100191, China
Tel: +86-10-62304633-2079 Fax: +86-10-62304633-2504
E-mail: info@emote.com Http://www.emote.com

DASY - Parameters of Probe: ES3DV3 - SN: 3252

Other Probe Parameters

Sensor Arrangement	Triangular
Connector Angle (°)	129.3
Mechanical Surface Detection Mode	enabled
Optical Surface Detection Mode	disable
Probe Overall Length	337mm
Probe Body Diameter	10mm
Tip Length	10mm
Tip Diameter	4mm
Probe Tip to Sensor X Calibration Point	2mm
Probe Tip to Sensor Y Calibration Point	2mm
Probe Tip to Sensor Z Calibration Point	2mm
Recommended Measurement Distance from Surface	3mm



In Collaboration with
s p e a g
CALIBRATION LABORATORY

Add: No.52 Huayuanbei Road, Haidian District, Beijing, 100191, China
Tel: +86-10-62304633-2079 Fax: +86-10-62304633-2504
E-mail: Info@emcete.com Http://www.emcete.com

 Client **CATR-SH**

 Certificate No: **J13-2-2041**

CALIBRATION CERTIFICATE

Object: **EX3DV4 - SN:3754**

Calibration Procedure(s): **TMC-OS-E-02-185**
Calibration Procedures for Dosimetric E-field Probes



Calibration date: **August 8, 2013**

This calibration Certificate documents the traceability to national standards, which realize the physical units of measurements(SI). The measurements and the uncertainties with confidence probability are given on the following pages and are part of the certificate.

All calibrations have been conducted in the closed laboratory facility: environment temperature(22±3)°C and humidity<70%.

Calibration Equipment used (M&TE critical for calibration)

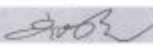
Primary Standards	ID #	Cal Date(Calibrated by, Certificate No.)	Scheduled Calibration
Power Meter NRP2	101919	01-Jul-13 (TMC, No.JW13-044)	Jun-14
Power sensor NRP-Z91	101547	01-Jul-13 (TMC, No.JW13-044)	Jun-14
Power sensor NRP-Z91	101548	01-Jul-13 (TMC, No.JW13-044)	Jun-14
Reference10dBAttenuator	BT0520	12-Dec-12(TMC, No. JZ12-867)	Dec-14
Reference20dBAttenuator	BT0267	12-Dec-12(TMC, No. JZ12-866)	Dec-14
Reference Probe EX3DV4	SN 3846	20-Dec-12(SPEAG, No. EX3-3846_Dec12)	Dec-13
DAE4	SN 777	22-Feb-13 (SPEAG, DAE4-777_Feb13)	Feb -14
Secondary Standards	ID #	Cal Date(Calibrated by, Certificate No.)	Scheduled Calibration
SignalGeneratorMG3700A	6201052805	01-Jul-13 (TMC, No. JW13-045)	Jun-14
Network Analyzer E5071C	MY46110673	15-Feb-13 (TMC, No. JZ13-781)	Feb-14

	Name	Function	Signature
Calibrated by:	Zhao Jing	SAR Test Engineer	
Reviewed by:	Qi Dianyuan	SAR Project Leader	
Approved by:	Xiao Li	Deputy Director of the laboratory	

Issued: August 9, 2013

This calibration certificate shall not be reproduced except in full without written approval of the laboratory.

Certificate No: J13-2-2041

Page 1 of 11



Glossary:

TSL	tissue simulating liquid
NORM _{x,y,z}	sensitivity in free space
ConvF	sensitivity in TSL / NORM _{x,y,z}
DCP	diode compression point
CF	crest factor (1/duty_cycle) of the RF signal
A,B,C,D	modulation dependent linearization parameters
Polarization Φ	Φ rotation around probe axis
Polarization θ	θ rotation around an axis that is in the plane normal to probe axis (at measurement center), $\theta=0$ is normal to probe axis

Calibration is Performed According to the Following Standards:

- a) IEEE Std 1528-2003, "IEEE Recommended Practice for Determining the Peak Spatial-Averaged Specific Absorption Rate (SAR) in the Human Head from Wireless Communications Devices: Measurement Techniques", December 2003
- b) IEC 62209-1, "Procedure to measure the Specific Absorption Rate (SAR) for hand-held devices used in close proximity to the ear (frequency range of 300MHz to 3GHz)", February 2005

Methods Applied and Interpretation of Parameters:

- NORM_{x,y,z}: Assessed for E-field polarization $\theta=0$ (fs900MHz in TEM-cell; f>1800MHz: waveguide). NORM_{x,y,z} are only intermediate values, i.e., the uncertainties of NORM_{x,y,z} does not effect the E^2 -field uncertainty inside TSL (see below ConvF).
- NORM(f)_{x,y,z} = NORM_{x,y,z}* frequency_response (see Frequency Response Chart). This linearization is implemented in DASY4 software versions later than 4.2. The uncertainty of the frequency response is included in the stated uncertainty of ConvF.
- DCP_{x,y,z}: DCP are numerical linearization parameters assessed based on the data of power sweep (no uncertainty required). DCP does not depend on frequency nor media.
- PAR: PAR is the Peak to Average Ratio that is not calibrated but determined based on the signal characteristics.
- A_{x,y,z}; B_{x,y,z}; C_{x,y,z}; VR_{x,y,z}; A,B,C are numerical linearization parameters assessed based on the data of power sweep for specific modulation signal. The parameters do not depend on frequency nor media. VR is the maximum calibration range expressed in RMS voltage across the diode.
- ConvF and Boundary Effect Parameters: Assessed in flat phantom using E-field (or Temperature Transfer Standard for fs800MHz) and inside waveguide using analytical field distributions based on power measurements for f > 800MHz. The same setups are used for assessment of the parameters applied for boundary compensation (alpha, depth) of which typical uncertainty valued are given. These parameters are used in DASY4 software to improve probe accuracy close to the boundary. The sensitivity in TSL corresponds to NORM_{x,y,z}* ConvF whereby the uncertainty corresponds to that given for ConvF. A frequency dependent ConvF is used in DASY version 4.4 and higher which allows extending the validity from ± 50 MHz to ± 100 MHz.
- Spherical isotropy (3D deviation from isotropy): in a field of low gradients realized using a flat phantom exposed by a patch antenna.
- Sensor Offset: The sensor offset corresponds to the offset of virtual measurement center from the probe tip (on probe axis). No tolerance required.
- Connector Angle: The angle is assessed using the information gained by determining the NORM_x (no uncertainty required).



Add: No.52 Huayuanbei Road, Haidian District, Beijing, 100191, China
Tel: +86-10-62304633-2079 Fax: +86-10-62304633-2504
E-mail: info@tmc2c.com Http://www.tmc2c.com

Probe EX3DV4

SN: 3754

Calibrated: August 8, 2013

Calibrated for DASY/EASY Systems

(Note: non-compatible with DASY2 system!)



Add: No.52 Huayuanbei Road, Haidian District, Beijing, 100191, China
 Tel: +86-10-62304633-2079 Fax: +86-10-62304633-2504
 E-mail: info@tmcic.com Http://www.tmcic.com

DASY – Parameters of Probe: EX3DV4 - SN: 3754

Basic Calibration Parameters

	Sensor X	Sensor Y	Sensor Z	Unc (k=2)
Norm($\mu\text{V}/(\text{V}/\text{m})^2$) ^A	0.40	0.45	0.45	±10.8%
DCP(mV) ^B	104.0	104.0	103.1	

Modulation Calibration Parameters

UID	Communication System Name		A dB	B dB μV	C	D dB	VR mV	Unc ^E (k=2)
0	CW	X	0.0	0.0	1.0	0.00	108.0	±3.2%
		Y	0.0	0.0	1.0		115.1	
		Z	0.0	0.0	1.0		115.7	

The reported uncertainty of measurement is stated as the standard uncertainty of Measurement multiplied by the coverage factor k=2, which for a normal distribution Corresponds to a coverage probability of approximately 95%.

^A The uncertainties of Norm X, Y, Z do not affect the E²-field uncertainty inside TSL (see Page 5 and Page 6).

^B Numerical linearization parameter: uncertainty not required.

^E Uncertainty is determined using the max. deviation from linear response applying rectangular distribution and is expressed for the square of the field value.



Add: No.52 Huayuanbei Road, Haidian District, Beijing, 100191, China
 Tel: +86-10-62104633-2079 Fax: +86-10-62104633-2504
 E-mail: tmcb@cmcltc.com Http://www.cmcltc.com

DASY – Parameters of Probe: EX3DV4 - SN: 3754

Calibration Parameter Determined in Head Tissue Simulating Media

f [MHz] ^C	Relative Permittivity ^F	Conductivity (S/m) ^F	ConvF X	ConvF Y	ConvF Z	Alpha	Depth (mm)	Unct. (k=2)
2000	40.0	1.40	7.57	7.57	7.57	0.13	3.89	± 12%
2300	39.5	1.67	7.33	7.33	7.33	0.17	2.17	± 12%
2450	39.2	1.80	7.09	7.09	7.09	0.14	2.92	± 12%
2600	39.0	1.96	6.72	6.72	6.72	0.14	2.89	± 12%

^C Frequency validity of ±100MHz only applies for DASY v4.4 and higher (Page 2), else it is restricted to ±50MHz. The uncertainty is the RSS of ConvF uncertainty at calibration frequency and the uncertainty for the indicated frequency band.

^F At frequency below 3 GHz, the validity of tissue parameters (ϵ and σ) can be relaxed to ±10% if liquid compensation formula is applied to measured SAR values. At frequencies above 3 GHz, the validity of tissue parameters (ϵ and σ) is restricted to ±5%. The uncertainty is the RSS of the ConvF uncertainty for indicated target tissue parameters.



Add: No.52 Huayuanbei Road, Haidian District, Beijing, 100191, China
 Tel: +86-10-62304633-2079 Fax: +86-10-62304633-2504
 E-mail: Info@emsitc.com Http://www.emsitc.com

DASY – Parameters of Probe: EX3DV4 - SN: 3754

Calibration Parameter Determined in Body Tissue Simulating Media

f [MHz] ^c	Relative Permittivity ^e	Conductivity (S/m) ^e	ConvF X	ConvF Y	ConvF Z	Alpha	Depth (mm)	Unct. (k=2)
2000	53.3	1.52	7.61	7.61	7.61	0.17	2.87	±12%
2300	52.9	1.81	7.20	7.20	7.20	0.19	2.05	±12%
2450	52.7	1.95	6.66	6.66	6.66	0.17	3.22	±12%
2600	52.5	2.16	6.29	6.29	6.29	0.14	3.23	±12%

^c Frequency validity of ±100MHz only applies for DASY v4.4 and higher (Page 2), else it is restricted to ±50MHz. The uncertainty is the RSS of ConvF uncertainty at calibration frequency and the uncertainty for the indicated frequency band.

^e At frequency below 3 GHz, the validity of tissue parameters (ϵ and σ) can be relaxed to ±10% if liquid compensation formula is applied to measured SAR values. At frequencies above 3 GHz, the validity of tissue parameters (ϵ and σ) is restricted to ±5%. The uncertainty is the RSS of the ConvF uncertainty for indicated target tissue parameters.



Add: No.52 Huayuanbei Road, Haidian District, Beijing, 100191, China
 Tel: +86-10-62304633-2079 Fax: +86-10-62304633-2504
 Email: info@ecit.com.cn Http://www.ecit.com.cn

Frequency Response of E-Field (TEM-Cell: ifi110 EXX, Waveguide: R22)

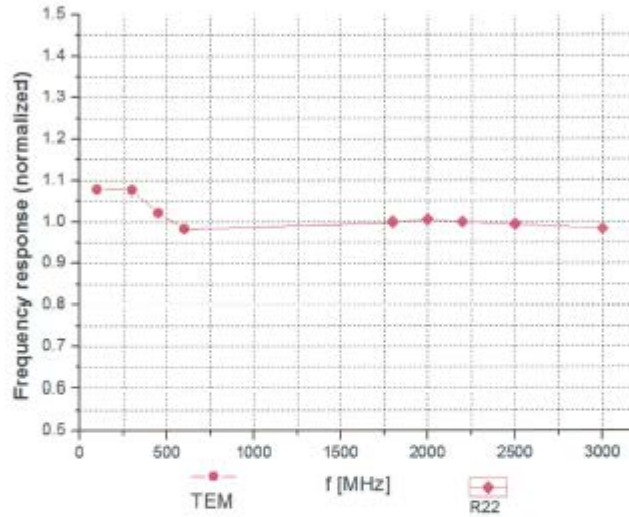

Uncertainty of Frequency Response of E-field: $\pm 7.5\%$ (k=2)



Add: No.52 Huayuanbei Road, Haidian District, Beijing, 100191, China
 Tel: +86-10-62304633-2079 Fax: +86-10-62304633-2504
 E-mail: info@emtcz.com Http://www.emtcz.com

Receiving Pattern (Φ), $\theta=0^\circ$

f=600 MHz, TEM

f=1800 MHz, R22

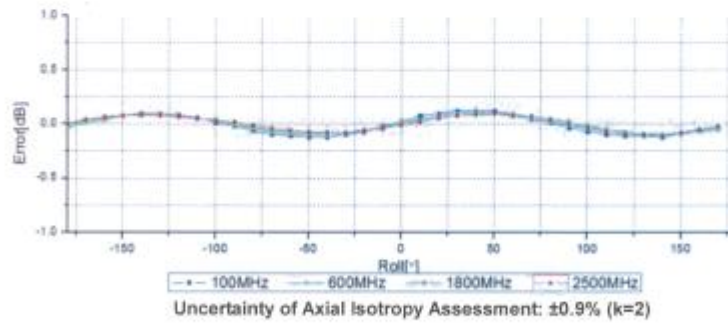
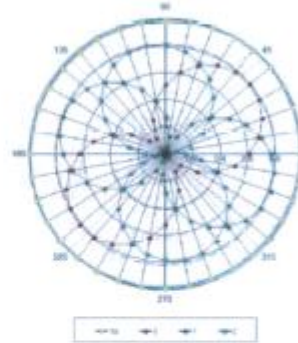
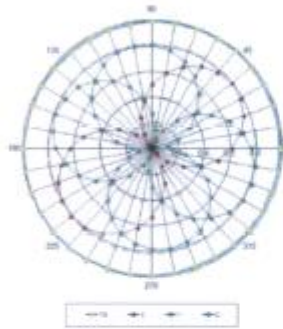



Add: No.52 Huayuanbei Road, Haidian District, Beijing, 100191, China
 Tel: +86-10-62304633-2079 Fax: +86-10-62304633-2504
 E-mail: info@emctc.com Http://www.emctc.com

Dynamic Range f(SAR_{head}) (TEM cell, f = 900 MHz)

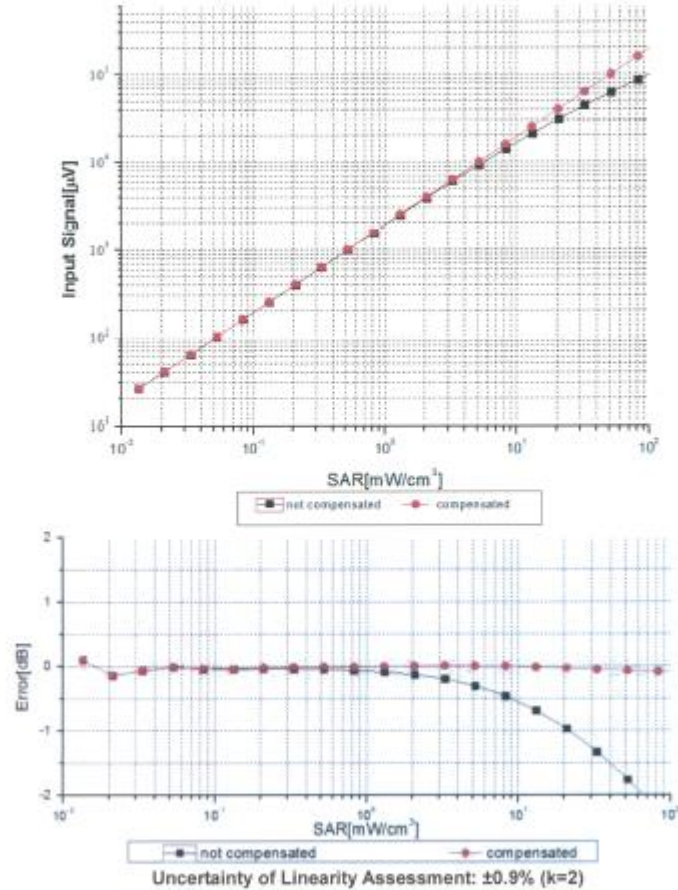



Add: No.52 Huayuanbei Road, Haidian District, Beijing, 100191, China
 Tel: +86-10-62304633-2079 Fax: +86-10-62304633-2504
 E-mail: info@emete.com http://www.emete.com

Conversion Factor Assessment

f=2000 MHz, WGLS R22(H_convF)

f=2450 MHz, WGLS R26(H_convF)

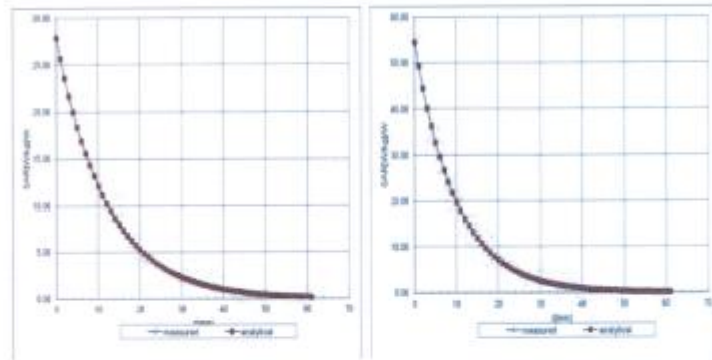

Deviation from Isotropy in Liquid

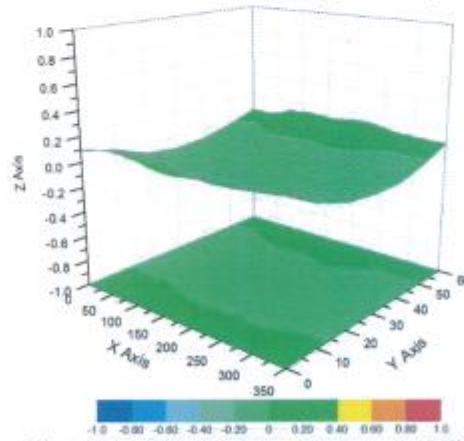

Uncertainty of Spherical Isotropy Assessment: $\pm 2.8\%$ (K=2)



Add: No.52 Huayuanbei Road, Haidian District, Beijing, 100191, China
 Tel: +86-10-62304633-2079 Fax: +86-10-62304633-2504
 E-mail: info@ecitc.com Http://www.ecitc.com

DASY - Parameters of Probe: EX3DV4 - SN: 3754

Other Probe Parameters

Sensor Arrangement	Triangular
Connector Angle (°)	15.8
Mechanical Surface Detection Mode	enabled
Optical Surface Detection Mode	disable
Probe Overall Length	337mm
Probe Body Diameter	10mm
Tip Length	3mm
Tip Diameter	2.5mm
Probe Tip to Sensor X Calibration Point	1mm
Probe Tip to Sensor Y Calibration Point	1mm
Probe Tip to Sensor Z Calibration Point	1mm
Recommended Measurement Distance from Surface	2mm

ANNEX H. Dipole Calibration Certificate





Add: No.52 Huayuanbei Road, Haidian District, Beijing, 100191, China
 Tel: +86-10-62304633-2079 Fax: +86-10-62304633-2504
 E-mail: Info@emcite.com Http://www.emcite.com

In Collaboration with



SPEAG
CALIBRATION LABORATORY

核准
CNAS L0442

Client: **CATR-SH** Certificate No: **J13-2-2032**

CALIBRATION CERTIFICATE

Object: **D835V2 - SN: 4d112**

Calibration Procedure(s): **TMC-OS-E-02-194
Calibration procedure for dipole validation kits**

Calibration date: **October 9, 2013**

This calibration Certificate documents the traceability to national standards, which realize the physical units of measurements(SI). The measurements and the uncertainties with confidence probability are given on the following pages and are part of the certificate.

All calibrations have been conducted in the closed laboratory facility: environment temperature(22±3)°C and humidity<70%.

Calibration Equipment used (M&TE critical for calibration)

Primary Standards	ID #	Cal Date(Calibrated by, Certificate No.)	Scheduled Calibration
Power Meter NRVD	102083	11-Sep-13 (TMC, No.JZ13-443)	Sep-14
Power sensor NRV-Z5	100595	11-Sep-13 (TMC, No. JZ13-443)	Sep -14
Reference Probe EX3DV4	SN 3846	3-Sep-13 (SPEAG, No.EX3-3846_Sep13)	Sep-14
DAE4	SN 777	22-Feb-13 (SPEAG, DAE4-777_Feb13)	Feb -14
Signal Generator E4438C	MY49070393	13-Nov-12 (TMC, No. JZ12-394)	Nov-13
Network Analyzer E8362B	MY43021135	19-Oct-12 (TMC, No. JZ13-278)	Oct-13

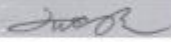
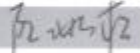
	Name	Function	Signature
Calibrated by:	Zhao Jing	SAR Test Engineer	
Reviewed by:	Qi Dianyuan	SAR Project Leader	
Approved by:	Lu Bingsong	Deputy Director of the laboratory	

Issued: October 11, 2013

This calibration certificate shall not be reproduced except in full without written approval of the laboratory.



Add: No.52 Huayuanbei Road, Haidian District, Beijing, 100191, China
Tel: +86-10-62304633-2079 Fax: +86-10-62304633-2504
E-mail: Info@emcibe.com [Http://www.emcibe.com](http://www.emcibe.com)

Glossary:

TSL tissue simulating liquid
ConvF sensitivity in TSL / NORM_{x,y,z}
N/A not applicable or not measured

Calibration is Performed According to the Following Standards:

- a) IEEE Std 1528-2003, "IEEE Recommended Practice for Determining the Peak Spatial-Averaged Specific Absorption Rate (SAR) in the Human Head from Wireless Communications Devices: Measurement Techniques", December 2003
- b) IEC 62209-1, "Procedure to measure the Specific Absorption Rate (SAR) For hand-held devices used in close proximity to the ear (frequency range of 300MHz to 3GHz)", February 2005
- c) KDB865664, SAR Measurement Requirements for 100 MHz to 6 GHz

Additional Documentation:

- d) DASY4/5 System Handbook

Methods Applied and Interpretation of Parameters:

- *Measurement Conditions:* Further details are available from the Validation Report at the end of the certificate. All figures stated in the certificate are valid at the frequency indicated.
- *Antenna Parameters with TSL:* The dipole is mounted with the spacer to position its feed point exactly below the center marking of the flat phantom section, with the arms oriented parallel to the body axis.
- *Feed Point Impedance and Return Loss:* These parameters are measured with the dipole positioned under the liquid filled phantom. The impedance stated is transformed from the measurement at the SMA connector to the feed point. The Return Loss ensures low reflected power. No uncertainty required.
- *Electrical Delay:* One-way delay between the SMA connector and the antenna feed point. No uncertainty required.
- *SAR measured:* SAR measured at the stated antenna input power.
- *SAR normalized:* SAR as measured, normalized to an input power of 1 W at the antenna connector.
- *SAR for nominal TSL parameters:* The measured TSL parameters are used to calculate the nominal SAR result.

The reported uncertainty of measurement is stated as the standard uncertainty of Measurement multiplied by the coverage factor $k=2$, which for a normal distribution Corresponds to a coverage probability of approximately 95%.



Measurement Conditions

DASY system configuration, as far as not given on page 1.

DASY Version	DASY52	52.8.7.1137
Extrapolation	Advanced Extrapolation	
Phantom	Twin Phantom	
Distance Dipole Center - TSL	15 mm	with Spacer
Zoom Scan Resolution	dx, dy, dz = 5 mm	
Frequency	835 MHz ± 1 MHz	

Head TSL parameters

The following parameters and calculations were applied.

	Temperature	Permittivity	Conductivity
Nominal Head TSL parameters	22.0 °C	41.5	0.90 mho/m
Measured Head TSL parameters	(22.0 ± 0.2) °C	41.3 ± 6 %	0.91 mho/m ± 6 %
Head TSL temperature change during test	<0.5 °C	---	---

SAR result with Head TSL

SAR averaged over 1 cm ³ (1 g) of Head TSL	Condition	
SAR measured	250 mW input power	2.31 mW / g
SAR for nominal Head TSL parameters	normalized to 1W	9.12 mW / g ± 20.8 % (k=2)
SAR averaged over 10 cm ³ (10 g) of Head TSL	Condition	
SAR measured	250 mW input power	1.51 mW / g
SAR for nominal Head TSL parameters	normalized to 1W	5.98 mW / g ± 20.4 % (k=2)

Body TSL parameters

The following parameters and calculations were applied.

	Temperature	Permittivity	Conductivity
Nominal Body TSL parameters	22.0 °C	55.2	0.97 mho/m
Measured Body TSL parameters	(22.0 ± 0.2) °C	56.1 ± 6 %	0.96 mho/m ± 6 %
Body TSL temperature change during test	<0.5 °C	---	---

SAR result with Body TSL

SAR averaged over 1 cm ³ (1 g) of Body TSL	Condition	
SAR measured	250 mW input power	2.26 mW / g
SAR for nominal Body TSL parameters	normalized to 1W	9.15 mW / g ± 20.8 % (k=2)
SAR averaged over 10 cm ³ (10 g) of Body TSL	Condition	
SAR measured	250 mW input power	1.5 mW / g
SAR for nominal Body TSL parameters	normalized to 1W	6.06 mW / g ± 20.4 % (k=2)



In Collaboration with
s p e a g
CALIBRATION LABORATORY

Add: No.52 Huayuanbei Road, Haidian District, Beijing, 100191, China
 Tel: +86-10-62304633-2079 Fax: +86-10-62304633-2504
 E-mail: Info@emcote.com [Http://www.emcote.com](http://www.emcote.com)

Appendix

Antenna Parameters with Head TSL

Impedance, transformed to feed point	46.0Ω - 4.61jΩ
Return Loss	- 24.1dB

Antenna Parameters with Body TSL

Impedance, transformed to feed point	42.6Ω - 5.07jΩ
Return Loss	- 20.4dB

After long term use with 100W radiated power, only a slight warming of the dipole near the feedpoint can be measured.

The dipole is made of standard semirigid coaxial cable. The center conductor of the feeding line is directly connected to the second arm of the dipole. The antenna is therefore short-circuited for DC-signals. On some of the dipoles, small end caps are added to the dipole arms in order to improve matching when loaded according to the position as explained in the "Measurement Conditions" paragraph. The SAR data are not affected by this change. The overall dipole length is still according to the Standard.

No excessive force must be applied to the dipole arms, because they might bend or the soldered connections near the feedpoint may be damaged.

Additional EUT Data

Manufactured by	SPEAG
-----------------	-------



Add: No.52 Huayuanbei Road, Haidian District, Beijing, 100191, China
 Tel: +86-10-62304633-2079 Fax: +86-10-62304633-2504
 E-mail: Info@emcile.com [Http://www.emcile.com](http://www.emcile.com)

DASY5 Validation Report for Head TSL

Date: 09.10.2013

Test Laboratory: TMC, Beijing, China

DUT: Dipole 835 MHz; Type: D835V2; Serial: D835V2 - SN: 4d112

Communication System: CW; Frequency: 835 MHz

Medium parameters used: $f = 835 \text{ MHz}$; $\sigma = 0.914 \text{ mho/m}$; $\epsilon_r = 41.328$; $\rho = 1000 \text{ kg/m}^3$

Phantom section: Flat Section

Measurement Standard: DASY5 (IEEE/IEC/ANSI C63.19-2007)

DASY5 Configuration:

- Probe: EX3DV4 - SN3846; ConvF(9.32,9.32,9.32); Calibrated: 2013/9/3
- Sensor-Surface: 2mm (Mechanical Surface Detection); 1.0, 31.0
- Electronics: DAE4 Sn777; Calibrated: 22/2/2013
- Phantom: SAM 1593;Type: QD000P40CC;
- Measurement SW: DASY52 52.8.7(1137); SEMCAD X Version 14.6.10 (7164)

Dipole Calibration for Head Tissue/Pin=250mW, d=15mm/Zoom Scan

(7x7x7)/Cube 0: Measurement grid: dx=5mm, dy=5mm, dz=5mm

Reference Value = 53.960 V/m; Power Drift = 0.04 dB

Peak SAR (extrapolated) = 3.46 W/kg

SAR(1 g) = 2.31 W/kg; SAR(10 g) = 1.51 W/kg

Maximum value of SAR (measured) = 2.93 W/kg

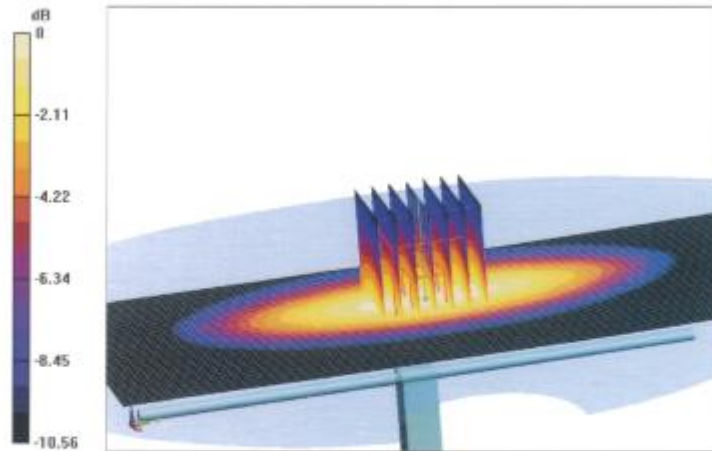

0 dB = 2.93 W/kg = 4.67 dBW/kg



Add: No 52 Huayuanbei Road, Haidian District, Beijing, 100191, China
Tel: +86-10-62304633-2079 Fax: +86-10-62304633-2504
E-mail: info@emcrite.com [Http://www.emcrite.com](http://www.emcrite.com)

Impedance Measurement Plot for Head TSL

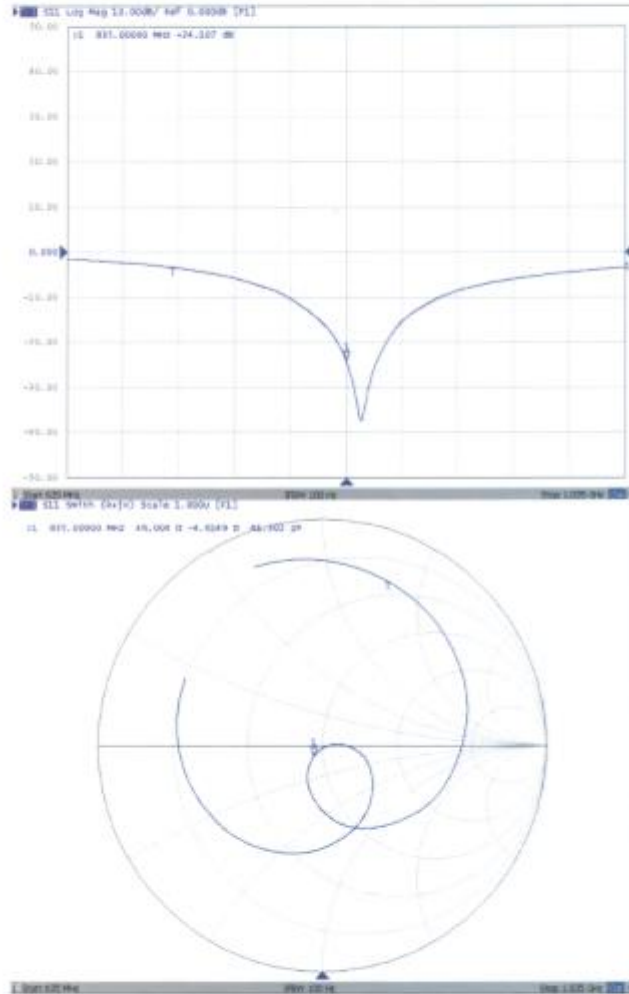

Certificate No: J13-2-2032

Page 6 of 8



Add: No 52 Huayuanbei Road, Haidian District, Beijing, 100191, China
 Tel: +86-10-62304633-2079 Fax: +86-10-62304633-2504
 E-mail: Info@emcife.com Http://www.emcife.com

DASY5 Validation Report for Body TSL

Date: 09.10.2013

Test Laboratory: TMC, Beijing, China

DUT: Dipole 835 MHz; Type: D835V2; Serial: D835V2 - SN: 4d112

Communication System: CW; Frequency: 835 MHz;

Medium parameters used: $f = 835 \text{ MHz}$; $\sigma = 0.959 \text{ mho/m}$; $\epsilon_r = 56.13$; $\rho = 1000 \text{ kg/m}^3$

Phantom section: Flat Section

Measurement Standard: DASY5 (IEEE/IEC/ANSI C63.19-2007)

DASY5 Configuration:

- Probe: EX3DV4 - SN3846; ConvF(8.96,8.96,8.96) ; Calibrated: 2013/9/3
- Sensor-Surface: 2mm (Mechanical Surface Detection); 1.0, 31.0
- Electronics: DAE4 Sn777; Calibrated: 22/2/2013
- Phantom: SAM 1186;Type: QD000P40CC;
- Measurement SW: DASY52 52.8.7(1137); SEMCAD X Version 14.6.10 (7164)

Dipole Calibration for Body Tissue/Pin=250mW, d=15mm/Zoom Scan

(7x7x7)/Cube 0: Measurement grid: dx=5mm, dy=5mm, dz=5mm

Reference Value = 53.919 V/m; Power Drift = -0.05 dB

Peak SAR (extrapolated) = 3.37 W/kg

SAR(1 g) = 2.26 W/kg; SAR(10 g) = 1.5 W/kg

Maximum value of SAR (measured) = 2.85 W/kg

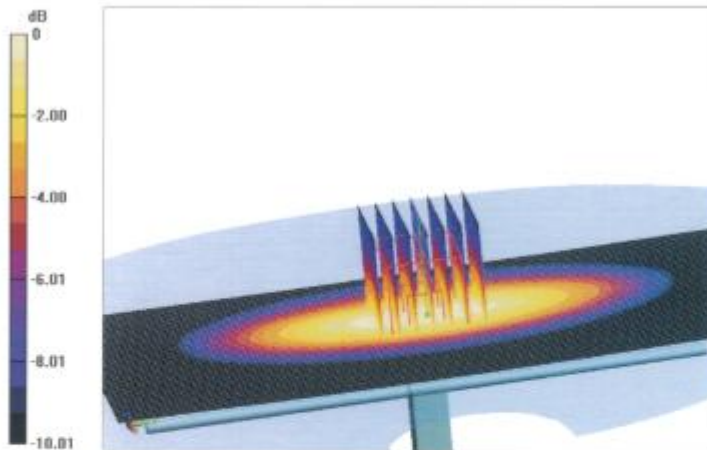

0 dB = 2.85 W/kg = 4.55 dBW/kg



Add: No.52 Huayuanbei Road, Haidian District, Beijing, 100191, China
Tel: +86-10-62304633-2079 Fax: +86-10-62304633-2504
E-mail: info@emcite.com [Http://www.emcite.com](http://www.emcite.com)

Impedance Measurement Plot for Body TSL

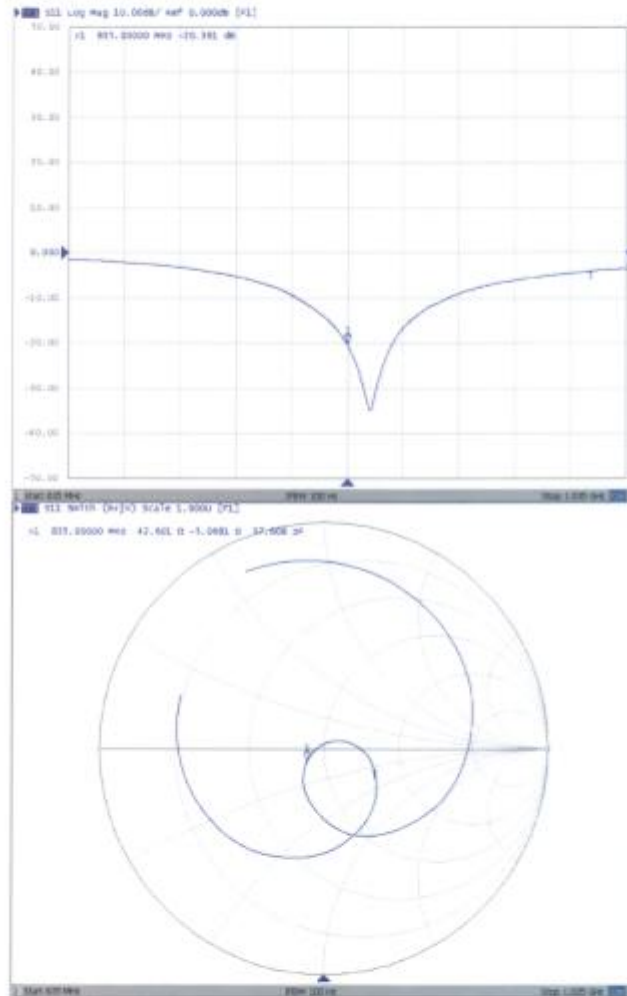



Acceptable Conditions for SAR Measurements Using Probes and Dipoles Calibrated under the SPEAG-TMC Dual-Logo Calibration Program to Support FCC Equipment Certification

The acceptable conditions for SAR measurements using probes, dipoles and DAEs calibrated by TMC (*Telecommunication Metrology Center of MITT in Beijing, China*), under the Dual-Logo Calibration Certificate program and quality assurance (QA) protocols established between SPEAG (*Schmid & Partner Engineering AG, Switzerland*) and TMC, to support FCC (*U.S. Federal Communications Commission*) equipment certification are defined and described in the following.

- 1) The agreement established between SPEAG and TMC is only applicable to calibration services performed by TMC where its clients (companies and divisions of such companies) are headquartered in the Greater China Region, including Taiwan and Hong Kong. This agreement is subject to renewal at the end of each calendar year between SPEAG and TMC. TMC shall inform the FCC of any changes or early termination to the agreement.
- 2) Only a subset of the calibration services specified in the SPEAG-TMC agreement, while it remains valid, are applicable to SAR measurements performed using such equipment for supporting FCC equipment certification. These are identified in the following.
 - a) Calibration of dosimetric (SAR) probes EX3DVx, ET3DVx and ES3DVx.
 - i) Free-space E-field and H-field probes, including those used for HAC (hearing aid compatibility) evaluation, temperature probes, other probes or equipment not identified in this document, when calibrated by TMC, are excluded and cannot be used for measurements to support FCC equipment certification.
 - ii) Signal specific and bundled probe calibrations based on PMR (probe modulation response) characteristics are handled according to the requirements of KDB 865664; that is, "Until standardized procedures are available to make such determination, the applicability of a signal specific probe calibration for testing specific wireless modes and technologies is determined on a case-by-case basis through KDB inquiries, including SAR system verification requirements."
 - b) Calibration of SAR system validation dipoles, excluding HAC dipoles.
 - c) Calibration of data acquisition electronics DAE3Vx, DAE4Vx and DAEasyVx.
 - d) For FCC equipment certification purposes, the frequency range of SAR probe and dipole calibrations is limited to 700 MHz - 6 GHz and provided it is supported by the equipment identified in the TMC QA protocol (a separate attachment to this document).
 - e) The identical system and equipment setup, measurement configurations, hardware, evaluation algorithms, calibration and QA protocols, including the format of calibration certificates and reports used by SPEAG shall be applied by TMC.
 - f) The calibrated items are only applicable to SPEAG DASY 4 and DASY 5 or higher version systems.



- 3) The SPEAG-TMC agreement includes specific protocols identified in the following to ensure the quality of calibration services provided by TMC under this SPEAG-TMC Dual-Logo calibration agreement are equivalent to the calibration services provided by SPEAG. TMC shall, upon request, provide copies of documentation to the FCC to substantiate program implementation.
 - a) The Inter-laboratory Calibration Evaluation (ILCE) stated in the TMC QA protocol shall be performed between SPEAG and TMC at least once every 12 months. The ILCE acceptance criteria defined in the TMC QA protocol shall be satisfied for the TMC, SPEAG and FCC agreements to remain valid.
 - b) Check of Calibration Certificate (CCC) shall be performed by SPEAG for all calibrations performed by TMC. Written confirmation from SPEAG is required for TMC to issue calibration certificates under the SPEAG-TMC Dual-Logo calibration program. Quarterly reports for all calibrations performed by TMC under the program are also issued by SPEAG.
 - c) The calibration equipment and measurement system used by TMC shall be verified before each calibration service according to the specific reference SAR probes, dipoles, and DAE calibrated by SPEAG. The results shall be reproducible and within the defined acceptance criteria specified in the TMC QA protocol before each actual calibration can commence. TMC shall maintain records of the measurement and calibration system verification results for all calibrations.
 - d) Quality Check of Calibration (QCC) certificates shall be performed by SPEAG at least once every 12 months. SPEAG shall visit TMC facilities to verify the laboratory, equipment, applied procedures and plausibility of randomly selected certificates.
- 4) A copy of this document, to be updated annually, shall be provided to TMC clients that accept calibration services according to the SPEAG-TMC Dual-Logo calibration program, which should be presented to a TCB (*Telecommunication Certification Body*), to facilitate FCC equipment approval.
- 5) TMC shall address any questions raised by its clients or TCBs relating to the SPEAG-TMC Dual-Logo calibration program and inform the FCC and SPEAG of any critical issues.

Change Note: Revised on June 26 to clarify the applicability of PMR and Bundled probe calibrations according to the requirements of KDB 865664.



In Collaboration with
s p e a g
 CALIBRATION LABORATORY
 Add: No.52 Huayuanbei Road, Haidian District, Beijing, 100191, China
 Tel: +86-10-62304833-2079 Fax: +86-10-62304633-2504
 E-mail: info@emctde.com Http://www.emctde.com



Client **CATR-SH** Certificate No: **J13-2-2035**

CALIBRATION CERTIFICATE

Object: **D1900V2 - SN: 5d134**

Calibration Procedure(s): **TMC-OS-E-02-194**
 Calibration procedure for dipole validation kits



Calibration date: **July 12, 2013**

This calibration Certificate documents the traceability to national standards, which realize the physical units of measurements(SI). The measurements and the uncertainties with confidence probability are given on the following pages and are part of the certificate.

All calibrations have been conducted in the closed laboratory facility: environment temperature(22±3)°C and humidity<70%.

Calibration Equipment used (M&TE critical for calibration)

Primary Standards	ID #	Cal Date(Calibrated by, Certificate No.)	Scheduled Calibration
Power Meter NRVD	102083	11-Sep-12 (TMC, No.JZ12-443)	Sep-13
Power sensor NRV-Z5	100595	11-Sep-12 (TMC, No. JZ12-443)	Sep-13
Reference Probe EX3D/V4 DAE4	SN 3846	20- Dec-12 (SPEAG, No.EX3-3846_Dec12)	Dec-13
	SN 777	22-Feb-13 (SPEAG, DAE4-777_Feb13)	Feb-14
Signal Generator E4438C	MY49070393	13-Nov-12 (TMC, No.JZ12-394)	Nov-13
Network Analyzer E8362B	MY43021135	19-Oct-12 (TMC, No.JZ13-278)	Oct-13

	Name	Function	Signature
Calibrated by:	Zhao Jing	SAR Test Engineer	
Reviewed by:	Qi Dianyuan	SAR Project Leader	
Approved by:	Xiao Li	Deputy Director of the laboratory	

Issued: July 26, 2013

This calibration certificate shall not be reproduced except in full without written approval of the laboratory.

**Glossary:**

TSL	tissue simulating liquid
ConvF	sensitivity in TSL / NORM _{x,y,z}
N/A	not applicable or not measured

Calibration is Performed According to the Following Standards:

- IEEE Std 1528-2003, "IEEE Recommended Practice for Determining the Peak Spatial-Averaged Specific Absorption Rate (SAR) in the Human Head from Wireless Communications Devices: Measurement Techniques", December 2003
- IEC 62209-1, "Procedure to measure the Specific Absorption Rate (SAR) For hand-held devices used in close proximity to the ear (frequency range of 300MHz to 3GHz)", February 2005
- KDR865664, SAR Measurement Requirements for 100 MHz to 6 GHz

Additional Documentation:

- DASY4/5 System Handbook

Methods Applied and Interpretation of Parameters:

- Measurement Conditions:** Further details are available from the Validation Report at the end of the certificate. All figures stated in the certificate are valid at the frequency indicated.
- Antenna Parameters with TSL:** The dipole is mounted with the spacer to position its feed point exactly below the center marking of the flat phantom section, with the arms oriented parallel to the body axis.
- Feed Point Impedance and Return Loss:** These parameters are measured with the dipole positioned under the liquid filled phantom. The impedance stated is transformed from the measurement at the SMA connector to the feed point. The Return Loss ensures low reflected power. No uncertainty required.
- Electrical Delay:** One-way delay between the SMA connector and the antenna feed point. No uncertainty required.
- SAR measured:** SAR measured at the stated antenna input power.
- SAR normalized:** SAR as measured, normalized to an input power of 1 W at the antenna connector.
- SAR for nominal TSL parameters:** The measured TSL parameters are used to calculate the nominal SAR result.

The reported uncertainty of measurement is stated as the standard uncertainty of Measurement multiplied by the coverage factor $k=2$, which for a normal distribution Corresponds to a coverage probability of approximately 95%.



Add: No.52 Huayuanbei Road, Haidian District, Beijing, 100191, China
 Tel: +86-10-62304633-2079 Fax: +86-10-62304633-2504
 E-mail: Info@emote.com <http://www.emote.com>

Measurement Conditions

DASY system configuration, as far as not given on page 1.

DASY Version	DASY52	52.8.7.1137
Extrapolation	Advanced Extrapolation	
Phantom	Twin Phantom	
Distance Dipole Center - TSL	10 mm	with Spacer
Znom Scan Resolution	dx, dy, dz = 5 mm	
Frequency	1900 MHz \pm 1 MHz	

Head TSL parameters

The following parameters and calculations were applied.

	Temperature	Permittivity	Conductivity
Nominal Head TSL parameters	22.0 °C	40.0	1.40 mho/m
Measured Head TSL parameters	(22.0 \pm 0.2) °C	38.6 \pm 6 %	1.37 mho/m \pm 6 %
Head TSL temperature change during test	<0.5 °C	---	---

SAR result with Head TSL

SAR averaged over 1 cm^3 (1 g) of Head TSL	Condition	
SAR measured	250 mW input power	10.8 mW / g
SAR for nominal Head TSL parameters	normalized to 1W	42.7 mW / g \pm 20.8 % (k=2)
SAR averaged over 10 cm^3 (10 g) of Head TSL	Condition	
SAR measured	250 mW input power	5.52 mW / g
SAR for nominal Head TSL parameters	normalized to 1W	22.2 mW / g \pm 20.4 % (k=2)

Body TSL parameters

The following parameters and calculations were applied.

	Temperature	Permittivity	Conductivity
Nominal Body TSL parameters	22.0 °C	53.3	1.52 mho/m
Measured Body TSL parameters	(22.0 \pm 0.2) °C	50.8 \pm 6 %	1.50 mho/m \pm 6 %
Body TSL temperature change during test	<0.5 °C	---	---

SAR result with Body TSL

SAR averaged over 1 cm^3 (1 g) of Body TSL	Condition	
SAR measured	250 mW input power	10.9 mW / g
SAR for nominal Body TSL parameters	normalized to 1W	43.4 mW / g \pm 20.8 % (k=2)
SAR averaged over 10 cm^3 (10 g) of Body TSL	Condition	
SAR measured	250 mW input power	5.7 mW / g
SAR for nominal Body TSL parameters	normalized to 1W	22.7 mW / g \pm 20.4 % (k=2)



Appendix

Antenna Parameters with Head TSL

Impedance, transformed to feed point	51.5Ω+0.78jΩ
Return Loss	- 26.8dB

Antenna Parameters with Body TSL

Impedance, transformed to feed point	46.9Ω+ 3.49jΩ
Return Loss	- 24.3dB

After long term use with 100W radiated power, only a slight warming of the dipole near the feedpoint can be measured.

The dipole is made of standard semirigid coaxial cable. The center conductor of the feeding line is directly connected to the second arm of the dipole. The antenna is therefore short-circuited for DC-signals. On some of the dipoles, small end caps are added to the dipole arms in order to improve matching when loaded according to the position as explained in the "Measurement Conditions" paragraph. The SAR data are not affected by this change. The overall dipole length is still according to the Standard.
No excessive force must be applied to the dipole arms, because they might bend or the soldered connections near the feedpoint may be damaged.

Additional EUT Data

Manufactured by	SPEAG
Manufactured on	April 14, 2010



Add: No.52 Huiyuanbei Road, Haidian District, Beijing, 100191, China
 Tel: +86-10-62304633-2079 Fax: +86-10-62304633-2504
 E-mail: info@emcrite.com <http://www.emcrite.com>

DASY5 Validation Report for Head TSL

Date: 12.07.2013

Test Laboratory: TMC, Beijing, China

DUT: Dipole 1900 MHz; Type: D1900V2; Serial: D1900V2 - SN: 5d134

Communication System: CW; Frequency: 1900 MHz

Medium parameters used: $f = 1900 \text{ MHz}$; $\sigma = 1.365 \text{ mho/m}$; $\epsilon_r = 38.576$; $\rho = 1000 \text{ kg/m}^3$

Phantom section: Flat Section

Measurement Standard: DASY5 (IEEE/IEC/ANSI C63.19-2007)

DASY5 Configuration:

- Probe: EX3DV4 - SN3846; ConvF(8.01,8.01,8.01); Calibrated:20.12.2012
- Sensor-Surface: 4mm (Mechanical Surface Detection)
- Electronics: DAE4 Sn777; Calibrated: 22/2/2013
- Phantom: Flat Phantom; Type: QD000P40CC;
- Measurement SW: DASY52 52.8.7(1137); SEMCAD X Version 14.6.10 (7164)

Dipole Calibration for Head Tissue/Pin=250mW, d=10mm/Zoom Scan

(7x7x7)/Cube 0: Measurement grid: $d_x=5\text{mm}$, $d_y=5\text{mm}$, $d_z=5\text{mm}$

Reference Value = 92.229 V/m; Power Drift = -0.00 dB

Peak SAR (extrapolated) = 19.8 W/kg

SAR(1 g) = 10.6 W/kg; SAR(10 g) = 5.52 W/kg

Maximum value of SAR (measured) = 12.0 W/kg

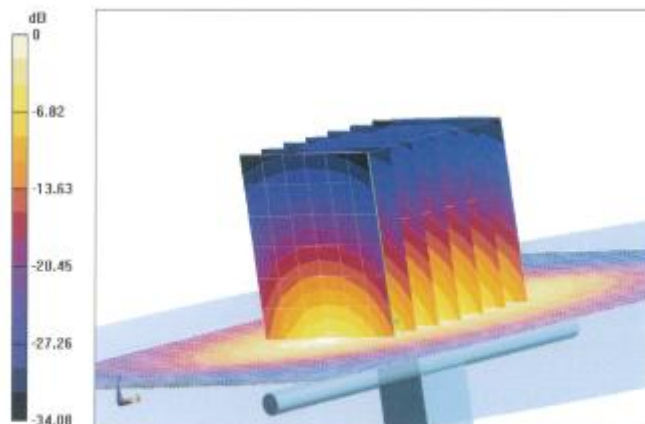

0 dB = 12.3 W/kg = 10.91 dBW/kg



Add: No.52 Huayuanbei Road, Haidian District, Beijing, 100191, China
Tel: +86-10-62304533-2079 Fax: +86-10-62304533-2504
E-mail: info@emcnc.com <http://www.rctscn.com>

Impedance Measurement Plot for Head TSL

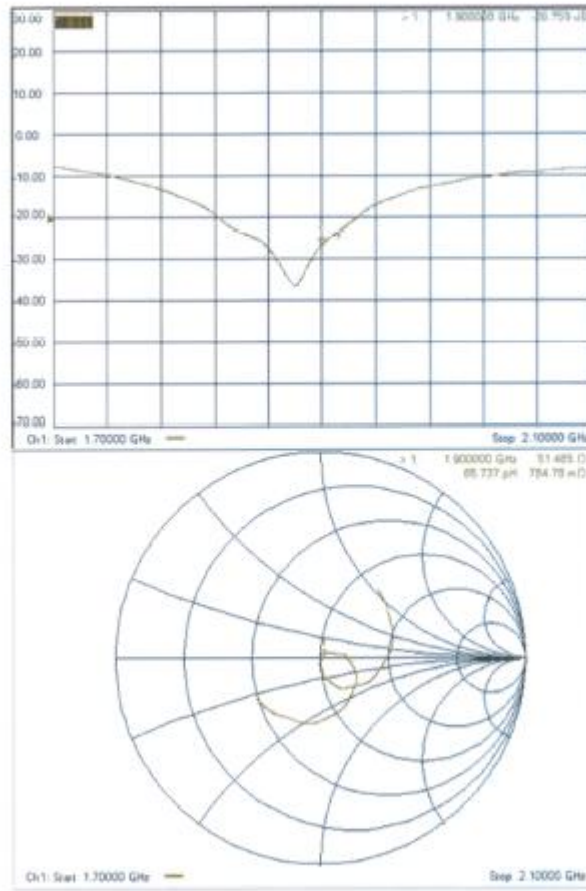



Add: No.52 Huayuanbei Road, Haidian District, Beijing, 100191, China
 Tel: +86-10-62304633-2079 Fax: +86-10-62304633-2504
 E-mail: Info@emcbe.com <http://www.emcbe.com>

DASY5 Validation Report for Body TSL

Date: 12.07.2013

Test Laboratory: TMC, Beijing, China

DUT: Dipole 1900 MHz; Type: D1900V2; Serial: D1900V2 - SN: 5d1134

Communication System: CW; Frequency: 1900 MHz;

Medium parameters used: $f = 1900$ MHz; $\sigma = 1.502$ mho/m; $\epsilon_r = 50.767$; $\rho = 1000$ kg/m³

Phantom section: Flat Phantom

Measurement Standard: DASY5 (IEEE/IEC/ANSI C63.19-2007)

DASY5 Configuration:

- Probe: EX3DV4 - SN3846; ConvF(7.37,7.37,7.37) ; Calibrated:20.12.2012
- Sensor-Surface: 4mm (Mechanical Surface Detection)
- Electronics: DAE4 Sn777; Calibrated: 22/2/2013
- Phantom: Flat Phantom; Type: QD000P40CC
- Measurement SW: DASY52 52.8.7(1137); SEMCAD X Version 14.6.10 (7164)

Dipole Calibration for Body Tissue/Pin=250mW, d=10mm/Zoom Scan

(7x7x7)/Cube 0: Measurement grid: dx=5mm, dy=5mm, dz=5mm

Reference Value = 74.485 W/m; Power Drift = -0.01 dB

Peak SAR (extrapolated) = 19.8 W/kg

SAR(1 g) = 10.9 W/kg; SAR(10 g) = 5.7 W/kg

Maximum value of SAR (measured) = 12.3 W/kg

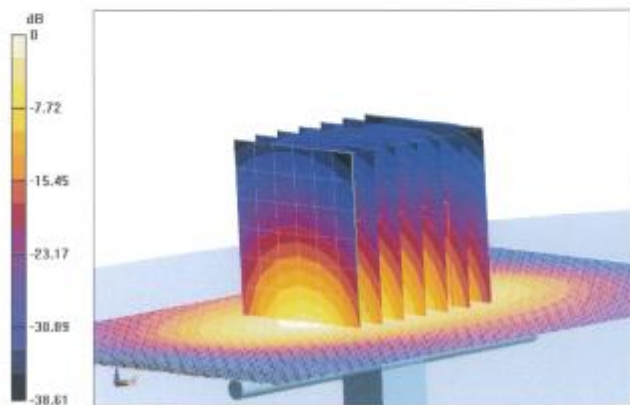

0 dB = 12.4 W/kg = 10.95 dBW/kg



Impedance Measurement Plot for Body TSL

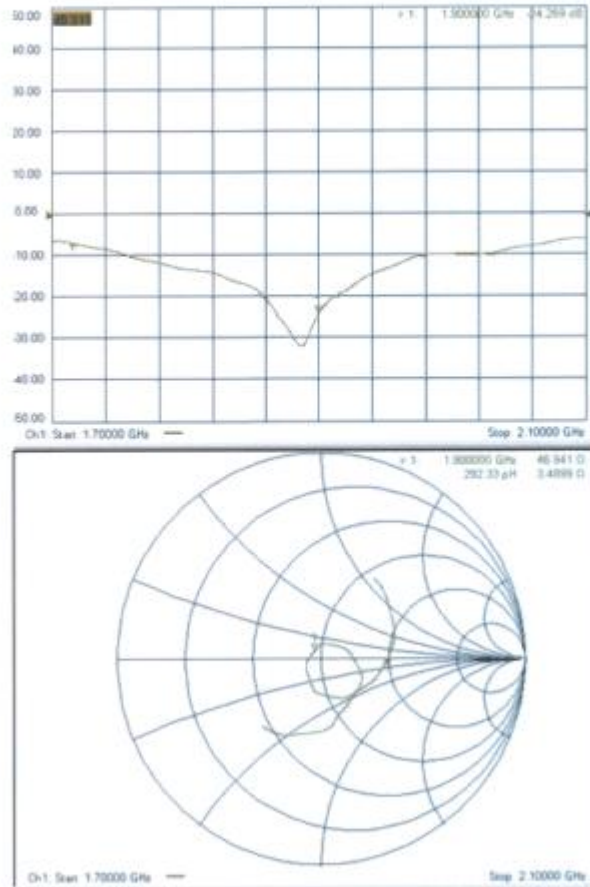



In Collaboration with
s p e a g
CALIBRATION LABORATORY

Add: No.52 Huayuanbei Road, Haidian District, Beijing, 100191, China
Tel: +86-10-62304633-2079 Fax: +86-10-62304633-2504
E-mail: info@emc3e.com Http://www.emc3e.com



Client **CATR-SH** Certificate No: **J13-2-2038**

CALIBRATION CERTIFICATE

Object: **D2450V2 - SN: 858**

Calibration Procedure(s): **TMC-OS-E-02-194**
Calibration procedure for dipole validation kits



Calibration date: **July 13, 2013**

This calibration Certificate documents the traceability to national standards, which realize the physical units of measurements(SI). The measurements and the uncertainties with confidence probability are given on the following pages and are part of the certificate.

All calibrations have been conducted in the closed laboratory facility: environment temperature(22±3)°C and humidity<70%.

Calibration Equipment used (M&TE critical for calibration)

Primary Standards	ID #	Cal Date(Calibrated by, Certificate No.)	Scheduled Calibration
Power Meter NRVD	102083	11-Sep-12 (TMC, No.JZ12-443)	Sep-13
Power sensor NRV-Z5	100595	11-Sep-12 (TMC, No. JZ12-443)	Sep -13
Reference Probe EX3DV4	SN 3846	20- Dec-12 (SPEAG, No.EX3-3846_Dec12)	Dec-13
DAE4	SN 777	22-Feb-13 (SPEAG, DAE4-777_Feb13)	Feb -14
Signal Generator E4438C	MY49070393	13-Nov-12 (TMC, No.JZ12-394)	Nov-13
Network Analyzer E8362B	MY43021135	19-Oct-12 (TMC, No.JZ13-278)	Oct-13

	Name	Function	Signature
Calibrated by:	Zhao Jing	SAR Test Engineer	
Reviewed by:	Qi Dianyuan	SAR Project Leader	
Approved by:	Xiao Li	Deputy Director of the laboratory	

Issued: July 26, 2013

This calibration certificate shall not be reproduced except in full without written approval of the laboratory.



Add: No.52 Huayuanbei Road, Haidian District, Beijing, 100191, China
Tel: +86-10-62304633-2079 Fax: +86-10-62304633-2804
E-mail: info@emote.com [Http://www.emote.com](http://www.emote.com)

Glossary:

TSL	tissue simulating liquid
ConvF	sensitivity in TSL / NORM _{x,y,z}
N/A	not applicable or not measured

Calibration is Performed According to the Following Standards:

- IEEE Std 1528-2003, "IEEE Recommended Practice for Determining the Peak Spatial-Averaged Specific Absorption Rate (SAR) in the Human Head from Wireless Communications Devices: Measurement Techniques", December 2003
- IEC 62209-1, "Procedure to measure the Specific Absorption Rate (SAR) For hand-held devices used in close proximity to the ear (frequency range of 300MHz to 3GHz)", February 2005
- KDB865664, SAR Measurement Requirements for 100 MHz to 6 GHz

Additional Documentation:

- DASY4/5 System Handbook

Methods Applied and Interpretation of Parameters:

- Measurement Conditions:** Further details are available from the Validation Report at the end of the certificate. All figures stated in the certificate are valid at the frequency indicated.
- Antenna Parameters with TSL:** The dipole is mounted with the spacer to position its feed point exactly below the center marking of the flat phantom section, with the arms oriented parallel to the body axis.
- Feed Point Impedance and Return Loss:** These parameters are measured with the dipole positioned under the liquid filled phantom. The impedance stated is transformed from the measurement at the SMA connector to the feed point. The Return Loss ensures low reflected power. No uncertainty required.
- Electrical Delay:** One-way delay between the SMA connector and the antenna feed point. No uncertainty required.
- SAR measured:** SAR measured at the stated antenna input power.
- SAR normalized:** SAR as measured, normalized to an input power of 1 W at the antenna connector.
- SAR for nominal TSL parameters:** The measured TSL parameters are used to calculate the nominal SAR result.

The reported uncertainty of measurement is stated as the standard uncertainty of Measurement multiplied by the coverage factor $k=2$, which for a normal distribution Corresponds to a coverage probability of approximately 95%.



Add: No.52 Huayuanbei Road, Haidian District, Beijing, 100191, China
 Tel: +86-10-62304633-2079 Fax: +86-10-62304633-2504
 E-mail: info@emcote.com Http://www.emcote.com

Measurement Conditions

DASY system configuration, as far as not given on page 1.

DASY Version	DASYS2	52.8.7.1137
Extrapolation	Advanced Extrapolation	
Phantom	Twin Phantom	
Distance Dipole Center - TSL	10 mm	with Spacer
Zoom Scan Resolution	$dx, dy, dz = 5$ mm	
Frequency	2450 MHz \pm 1 MHz	

Head TSL parameters

The following parameters and calculations were applied.

	Temperature	Permittivity	Conductivity
Nominal Head TSL parameters	22.0 °C	39.2	1.80 mho/m
Measured Head TSL parameters	(22.0 \pm 0.2) °C	37.6 \pm 6 %	1.78 mho/m \pm 6 %
Head TSL temperature change during test	<0.5 °C	---	---

SAR result with Head TSL

SAR averaged over 1 cm^3 (1 g) of Head TSL	Condition	
SAR measured	250 mW input power	12.4 mW / g
SAR for nominal Head TSL parameters	normalized to 1W	49.5 mW / g \pm 20.8 % (k=2)
SAR averaged over 10 cm^3 (10 g) of Head TSL	Condition	
SAR measured	250 mW input power	5.78 mW / g
SAR for nominal Head TSL parameters	normalized to 1W	23.0 mW / g \pm 20.4 % (k=2)

Body TSL parameters

The following parameters and calculations were applied.

	Temperature	Permittivity	Conductivity
Nominal Body TSL parameters	22.0 °C	52.7	1.95 mho/m
Measured Body TSL parameters	(22.0 \pm 0.2) °C	51.9 \pm 6 %	1.93 mho/m \pm 6 %
Body TSL temperature change during test	<0.5 °C	---	---

SAR result with Body TSL

SAR averaged over 1 cm^3 (1 g) of Body TSL	Condition	
SAR measured	250 mW input power	11.9 mW / g
SAR for nominal Body TSL parameters	normalized to 1W	47.7 mW / g \pm 20.8 % (k=2)
SAR averaged over 10 cm^3 (10 g) of Body TSL	Condition	
SAR measured	250 mW input power	5.55 mW / g
SAR for nominal Body TSL parameters	normalized to 1W	22.2 mW / g \pm 20.4 % (k=2)



Add: No.52 Huayuanbei Road, Haidian District, Beijing, 100191, China
 Tel: +86-10-62304633-2079 Fax: +86-10-62304633-2504
 E-mail: Info@emcite.com <http://www.emcite.com>

Appendix

Antenna Parameters with Head TSL

Impedance, transformed to feed point	54.9Ω+4.5jΩ
Return Loss	- 24.0dB

Antenna Parameters with Body TSL

Impedance, transformed to feed point	50.8Ω+ 5.86jΩ
Return Loss	- 24.6dB

After long term use with 100W radiated power, only a slight warming of the dipole near the feedpoint can be measured.

The dipole is made of standard semirigid coaxial cable. The center conductor of the feeding line is directly connected to the second arm of the dipole. The antenna is therefore short-circuited for DC-signals. On some of the dipoles, small end caps are added to the dipole arms in order to improve matching when loaded according to the position as explained in the "Measurement Conditions" paragraph. The SAR data are not affected by this change. The overall dipole length is still according to the Standard.

No excessive force must be applied to the dipole arms, because they might bend or the soldered connections near the feedpoint may be damaged.

Additional EUT Data

Manufactured by	SPEAG
Manufactured on	April 23, 2010



Addr: No.52 Huayuanbei Road, Haidian District, Beijing, 100191, China
 Tel: +86-10-62304633-2079 Fax: +86-10-62304633-2604
 E-mail: info@emcste.com [Http://www.emcste.com](http://www.emcste.com)

DASY5 Validation Report for Head TSL

Date: 13.07.2013

Test Laboratory: TMC, Beijing, China

DUT: Dipole 2450 MHz; Type: D2450V2; Serial: D2450V2 - SN: 858

Communication System: CW; Frequency: 2450 MHz

Medium parameters used: $f = 2450$ MHz; $\sigma = 1.777$ mho/m; $\epsilon_r = 37.01$; $\rho = 1000$ kg/m³

Phantom section: Flat Section

Measurement Standard: DASY5 (IEEE/IEC/ANSI C63.19-2007)

DASY5 Configuration:

- Probe: EX3DV4 - SN3846; ConvF(7.13,7.13,7.13); Calibrated:20,12,2012
- Sensor-Surface: 4mm (Mechanical Surface Detection)
- Electronics: DAE4 Sn777; Calibrated: 22/2/2013
- Phantom: Flat Phantom; Type: QD000P40CC;
- Measurement SW: DASY52 52.8.7(113.7); SEMCAD X Version 14.6.10 (7164)

Dipole Calibration for Head Tissue/Pin=250mW, d=10mm/Zoom Scan

(7x7x7)/Cube 0: Measurement grid: dx=5mm, dy=5mm, dz=5mm

Reference Value = 82.927 V/m; Power Drift = -0.01 dB

Peak SAR (extrapolated) = 26.0 W/kg

SAR(1 g) = 12.4 W/kg; SAR(10 g) = 5.76 W/kg

Maximum value of SAR (measured) = 14.2 W/kg

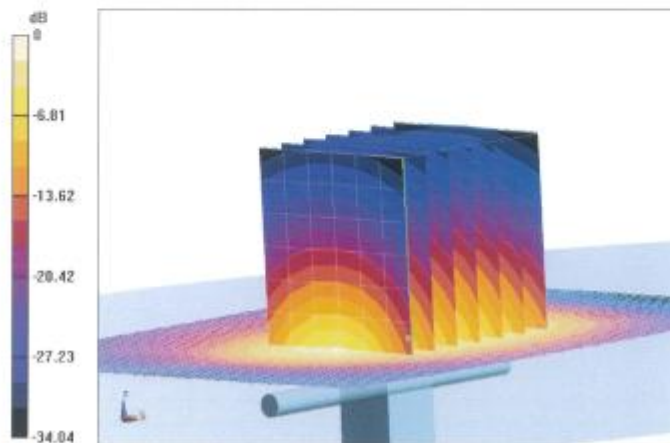

0 dB = 14.4 W/kg = 11.57 dBW/kg



Add: No.52 Huayuanbei Road, Haidian District, Beijing, 100191, China
 Tel: +86-10-62304633-2079 Fax: +86-10-62304633-2504
 E-mail: Info@emcife.com <http://www.emcife.com>

Impedance Measurement Plot for Head TSL

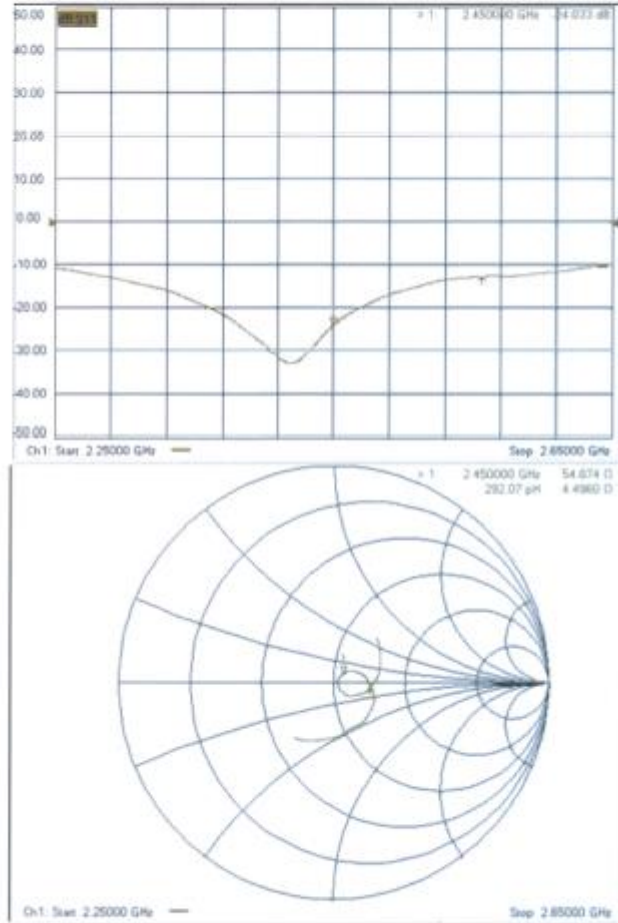



Add: No.52 Huayuanbei Road, Haidian District, Beijing, 100191, China
 Tel: +86-10-82304633-2079 Fax: +86-10-82304633-2504
 E-mail: Info@emcile.com <http://www.emcile.com>

DASY5 Validation Report for Body TSL

Date: 11.07.2013

Test Laboratory: TMC, Beijing, China

DUT: Dipole 2450 MHz; Type: D2450V2; Serial: D2450V2 - SN: 858

Communication System: CVV; Frequency: 2450 MHz;

Medium parameters used: $f = 2450$ MHz; $\sigma = 1.927$ mho/m; $\epsilon_r = 51.858$; $\rho = 1000$ kg/m³

Phantom section: Flat Phantom

Measurement Standard: DASY5 (IEEE/IEC/ANSI C63.19-2007)

DASY5 Configuration:

- Probe: EX3DV4 - SN3846; ConvF(7,7,7) ; Calibrated:20.12.2012
- Sensor-Surface: 4mm (Mechanical Surface Detection)
- Electronics: DAE4 Sn777; Calibrated: 22/2/2013
- Phantom: Flat Phantom; Type: QD000P40CC
- Measurement SW: DASY52 52.8.7(1137); SEMCAD X Version 14.6.10 (7164)

Dipole Calibration for Body Tissue/Pin=250mW, d=10mm/Zoom Scan

(7x7x7)/Cube 0: Measurement grid: dx=5mm, dy=5mm, dz=5mm

Reference Value = 83.465 V/m; Power Drift = -0.01 dB

Peak SAR (extrapolated) = 24.1 W/kg

SAR(1 g) = 11.9 W/kg; SAR(10 g) = 5.55 W/kg

Maximum value of SAR (measured) = 13.7 W/kg

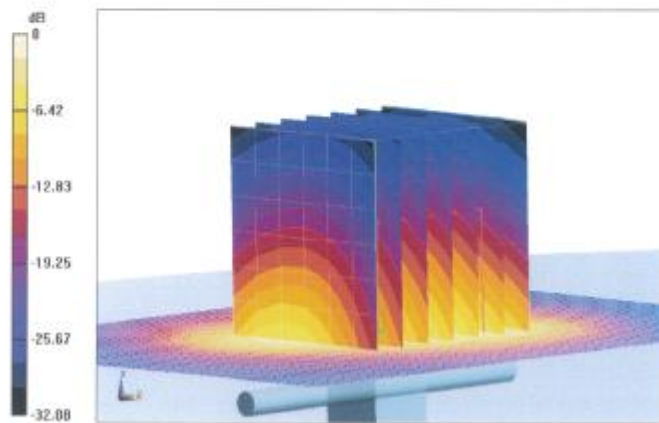

0 dB = 13.6 W/kg = 11.32 dBW/kg



Impedance Measurement Plot for Body TSL

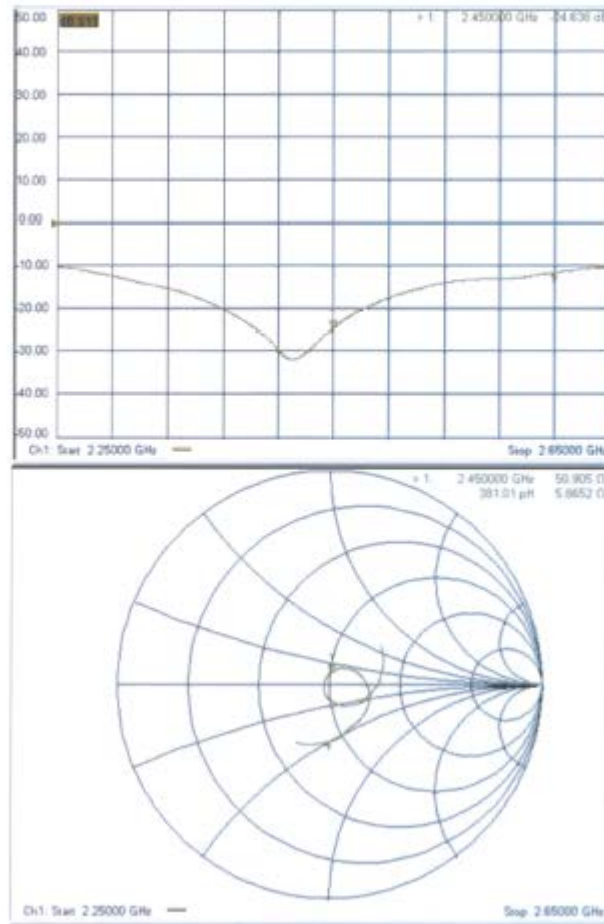

Certificate No: J13-2-2038

Page 8 of 8



Acceptable Conditions for SAR Measurements Using Probes and Dipoles Calibrated under the SPEAG-TMC Dual-Logo Calibration Program to Support FCC Equipment Certification

The acceptable conditions for SAR measurements using probes, dipoles and DAES calibrated by TMC (*Telecommunication Metrology Center of MITT in Beijing, China*), under the Dual-Logo Calibration Certificate program and quality assurance (QA) protocols established between SPEAG (*Schmid & Partner Engineering AG, Switzerland*) and TMC, to support FCC (*U.S. Federal Communications Commission*) equipment certification are defined and described in the following.

- 1) The agreement established between SPEAG and TMC is only applicable to calibration services performed by TMC where its clients (companies and divisions of such companies) are headquartered in the Greater China Region, including Taiwan and Hong Kong. This agreement is subject to renewal at the end of each calendar year between SPEAG and TMC. TMC shall inform the FCC of any changes or early termination to the agreement.
- 2) Only a subset of the calibration services specified in the SPEAG-TMC agreement, while it remains valid, are applicable to SAR measurements performed using such equipment for supporting FCC equipment certification. These are identified in the following.
 - a) Calibration of dosimetric (SAR) probes EX3DVx, ET3DVx and ES3DVx.
 - i) Free-space E-field and H-field probes, including those used for HAC (hearing aid compatibility) evaluation, temperature probes, other probes or equipment not identified in this document, when calibrated by TMC, are excluded and cannot be used for measurements to support FCC equipment certification.
 - ii) Signal specific and bundled probe calibrations based on PMR (probe modulation response) characteristics are handled according to the requirements of KDB 865664; that is, "Until standardized procedures are available to make such determination, the applicability of a signal specific probe calibration for testing specific wireless modes and technologies is determined on a case-by-case basis through KDB inquiries, including SAR system verification requirements."
 - b) Calibration of SAR system validation dipoles, excluding HAC dipoles.
 - c) Calibration of data acquisition electronics DAE3Vx, DAE4Vx and DAEasyVx.
 - d) For FCC equipment certification purposes, the frequency range of SAR probe and dipole calibrations is limited to 700 MHz - 6 GHz and provided it is supported by the equipment identified in the TMC QA protocol (a separate attachment to this document).
 - e) The identical system and equipment setup, measurement configurations, hardware, evaluation algorithms, calibration and QA protocols, including the format of calibration certificates and reports used by SPEAG shall be applied by TMC.
 - f) The calibrated items are only applicable to SPEAG DASY 4 and DASY 5 or higher version systems.



- 3) The SPEAG-TMC agreement includes specific protocols identified in the following to ensure the quality of calibration services provided by TMC under this SPEAG-TMC Dual-Logo calibration agreement are equivalent to the calibration services provided by SPEAG. TMC shall, upon request, provide copies of documentation to the FCC to substantiate program implementation.
 - a) The Inter-laboratory Calibration Evaluation (ILCE) stated in the TMC QA protocol shall be performed between SPEAG and TMC at least once every 12 months. The ILCE acceptance criteria defined in the TMC QA protocol shall be satisfied for the TMC, SPEAG and FCC agreements to remain valid.
 - b) Check of Calibration Certificate (CCC) shall be performed by SPEAG for all calibrations performed by TMC. Written confirmation from SPEAG is required for TMC to issue calibration certificates under the SPEAG-TMC Dual-Logo calibration program. Quarterly reports for all calibrations performed by TMC under the program are also issued by SPEAG.
 - c) The calibration equipment and measurement system used by TMC shall be verified before each calibration service according to the specific reference SAR probes, dipoles, and DAE calibrated by SPEAG. The results shall be reproducible and within the defined acceptance criteria specified in the TMC QA protocol before each actual calibration can commence. TMC shall maintain records of the measurement and calibration system verification results for all calibrations.
 - d) Quality Check of Calibration (QCC) certificates shall be performed by SPEAG at least once every 12 months. SPEAG shall visit TMC facilities to verify the laboratory, equipment, applied procedures and plausibility of randomly selected certificates.
- 4) A copy of this document, to be updated annually, shall be provided to TMC clients that accept calibration services according to the SPEAG-TMC Dual-Logo calibration program, which should be presented to a TCB (*Telecommunication Certification Body*), to facilitate FCC equipment approval.
- 5) TMC shall address any questions raised by its clients or TCBs relating to the SPEAG-TMC Dual-Logo calibration program and inform the FCC and SPEAG of any critical issues.

Change Note: Revised on June 26 to clarify the applicability of PMR and Bundled probe calibrations according to the requirements of KDB 865664.

*****End The Report*****