



# LTE RADIO TEST REPORT

Report No: STS1601014F05

Issued for

VSN Technologies Inc

1975 E. Sunrise Blvd., Suite 400, Fort Lauderdale, United States

<b>Product Name:</b>	LTE smart phone
<b>Brand Name:</b>	VSN
<b>Model No.:</b>	V.40R
<b>Series Model:</b>	N/A
<b>FCC ID:</b>	2AA9WV1003
<b>Test Standard:</b>	FCC Part 22H FCC Part 24E FCC Part 27L/M

Any reproduction of this document must be done in full. No single part of this document may be reproduced without permission from STS, All Test Data Presented in this report is only applicable to presented Test sample.





### TEST RESULT CERTIFICATION

**Applicant's name**..... VSN Technologies Inc  
 Address..... 1975 E. Sunrise Blvd., Suite 400, Fort Lauderdale, United States  
**Manufacture's Name** ..... Skycom Telecommunications Co., Limited  
 Address..... Rm604, East Block, Shengtang Bldg., No.1, Tairan 9 Rd.,  
 Chegongmiao, Futian District, Shenzhen, China  
 Product name..... LTE smart phone  
 Brand name ..... VSN  
 Model and/or type reference. V.40R  
**Standards**..... FCC Part 24H. FCC Part 24E. FCC Part 27L/M  
 Test procedure ..... ANSI / TIA / EIA-603-C-2009

This device described above has been tested by STS and the test results show that the equipment under test (EUT) is in compliance with the FCC requirements. And it is applicable only to the tested sample identified in the report.

This report shall not be reproduced except in full, without the written approval of STS, this document may be altered or revised by STS, personal only, and shall be noted in the revision of the document.

**Date of Test**.....  
 Date of performance of tests..... 04 Jan. 2016 ~19 Jan. 2016  
 Date of Issue ..... 20 Jan. 2016  
 Test Result ..... **Pass**

Testing Engineer :   
 \_\_\_\_\_  
 (Jin Ming)

Technical Manager :   
 \_\_\_\_\_  
 (Tony Liu)

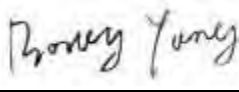
Authorized Signatory :   
 \_\_\_\_\_  
 (Bovey Yang)





<b>TABLE OF CONTENTS</b>	<b>Page</b>
1. SUMMARY OF TEST RESULTS	5
2. GENERAL INFORMATION	8
3. CONDUCTED OUTPUT POWER	17
4. PEAK-TO-AVERAGE RATIO	27
5. RADIATED POWER AND EFFECTIVE ISOTROPIC RADIATED POWER	30
6. OCCUPIED BANDWIDTH	39
7. CONDUCTED BAND EDGE	60
8. CONDUCTED SPURIOUS EMISSION	98
9. RADIATED SPURIOUS EMISSION	117
10. FREQUENCY STABILITY	137
PHOTOS OF TEST SETUP	142



**Revision History**

Rev.	Issue Date	Report NO.	Effect Page	Contents
00	20 Jan. 2016	STS1601014F05	ALL	Initial Issue





1. SUMMARY OF TEST RESULTS

1.1 TEST RESULTS DESCRIPTION AND LABORATORY INFORMATION

Setion	FCC Rule	Description	Limit	Result
	§2.1046	Conducted Output Power	Reporting Only	PASS
	§24.232(d)	Peak-to-Average Ratio	<13 dB	PASS
	§2.1049 §24.238(b) §27.53(h)(3) §27.53(m)(6)	Occupied Bandwidth	Reporting Only	PASS
	§2.1051 §2.917(a) §24.238(a) §27.53(g) §27.53(h)	Conducted Band Edge Measurement (Band 5 ) (Band 2 )(Band 4) (Band 17)	<43+10log10(P[Watts])	PASS
	§27.53(m)(4/6)	(Band 7)	<43+10log10(P[Watts])	PASS
	§2.1051 §2.917(a) §24.238(a) §27.53(g) §27.53(h)	Conducted Spurious Emission (Band 5 ) (Band 2 )(Band 4) (Band 17)	<43+10log10(P[Watts])	PASS
	§27.53(m)(4/6)	Conducted Spurious Emission (Band 7)	< 55+10log10(P[Watts])	PASS
	§2.1055 §24.235 §27.54	Frequency Stability Temperature & Voltage	< 2.5 ppm for Part 22 Within Authorized Band	PASS



	§22.913(a)(2)	Effective Radiated Power (Band 5)	ERP < 7 Watt	
	§27.50(c)(10)	Effective Radiated Power (Band 17)	ERP < 3 Watt	PASS
	§24.232(c) §27.50(h)(2)	Equivalent Isotropic Radiated Power (Band 2)((Band 7)	EIRP < 2Watt	PASS
	§27.50(d)(4)	Equivalent Isotropic Radiated Power (Band 4)	EIRP < 1Watt	PASS
	§2.1051 §2.917(a) §24.238(a) §27.53(g) §27.53(h)	Radiated Spurious Emission (Band 5 ) (Band 2 )(Band 4) (Band 17)	< 43+10log10(P[Watts])	PASS
	§27.53(m)(4)(6)	Radiated Spurious Emission (Band 7)	< 55+10log10(P[Watts])	PASS

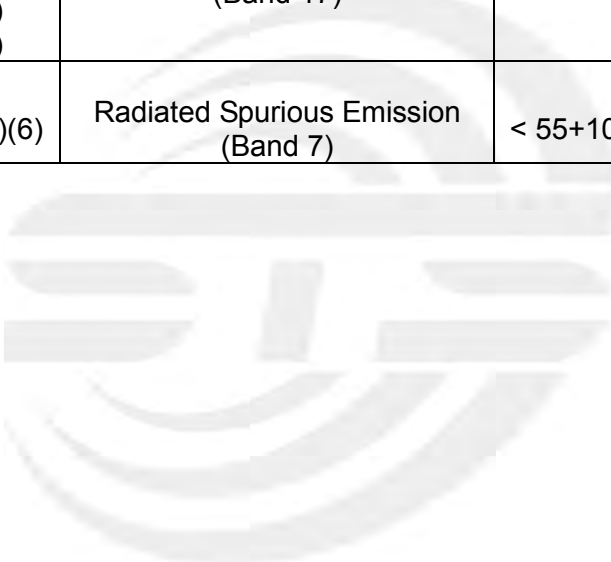



### 1.1.1 TEST FACTORY

Shenzhen STS Test Services Co., Ltd.

Add. : 1/F., Building B, Zhuoke Science Park, No.190, Chongqing Road,  
Fuyong Street, Bao'an District, Shenzhen, Guangdong, China  
CNAS Registration No.: L7649;

FCC Registration No.: 842334; IC Registration No.: 12108A-1

### 1.1.2 MEASUREMENT UNCERTAINTY

The reported uncertainty of measurement  $y \pm U$ , where expanded uncertainty  $U$  is based on a standard uncertainty multiplied by a coverage factor of  $k=2$ , providing a level of confidence of approximately **95 %**.

No.	Item	Uncertainty
1	Conducted Emission (9KHz-150KHz)	$\pm 2.88\text{dB}$
2	Conducted Emission (150KHz-30MHz)	$\pm 2.67\text{dB}$
3	RF power,conducted	$\pm 0.70\text{dB}$
4	Spurious emissions,conducted	$\pm 1.19\text{dB}$
5	All emissions,radiated(<1G) 30MHz-200MHz	$\pm 2.83\text{dB}$
6	All emissions,radiated(<1G) 200MHz-1000MHz	$\pm 2.94\text{dB}$
7	All emissions,radiated(>1G)	$\pm 3.03\text{dB}$
8	Temperature	$\pm 0.5\text{C}$
9	Humidity	$\pm 2\%$



## 2. GENERAL INFORMATION

### 2.1 TECHNICAL SPECIFICATIONS AND REGULATIONS

#### 2.1.1 PRODUCT DESCRIPTION

A major technical description of EUT is described as following:

Product Designation:	LTE smart phone
Hardware version:	V01
Software version:	--
FCC ID:	2AA9WV1003
Frequency Bands:	U.S. Bands: <input checked="" type="checkbox"/> LTE FDD Band 2 <input checked="" type="checkbox"/> LTE FDD Band 4 <input type="checkbox"/> LTE FDD Band 5 <input checked="" type="checkbox"/> LTE FDD Band 7 <input type="checkbox"/> LTE FDD Band 12 <input type="checkbox"/> LTE FDD Band 13 <input checked="" type="checkbox"/> LTE FDD Band 17
SIM CARD	SIM 1 and SIM 2 is a chipset unit and tested as single chipset, SIM 1 is used to tested
Antenna:	PIFA Antenna
Antenna gain:	LTE Band 2: 1 dBi LTE Band 4: 1.2 dBi LTE Band 7: 1.4 dBi LTE Band 17: 1.6 dBi
Power Supply:	DC 3.8V by battery or DC 5.0V supplied by adapter
Battery parameter:	Capacitance: 2000mA, Rated Voltage: 3.8V
Adapter Input:	AC100-240V, 50-60Hz, 200mA
Adapter Output:	DC 5.0V, 1000mA





## 2.1.2 PRODUCT SPECIFICATION SUBJECTIVE TO THIS STANDARD

<b>Product Specification Subjective To This Standard</b>	
<b>Tx Frequency</b>	LTE Band 2:1850.7~1909.3MHz LTE Band 4:1710.7~1754.3MHz LTE Band 7:2502.5~2567.5MHz LTE Band 17:706.5~713.5MHz
<b>Rx Frequency</b>	LTE Band 2:1930.7~1989.3MHz LTE Band 4:2110.7~2154.3MHz LTE Band 7:2622.5~2687.5MHz LTE Band 17:736.5~743.5MHz
<b>Bandwidth</b>	LTE Band 2 : 1.4MHz / 3MHz / 5MHz / 10MHz / 15MHz / 20MHz LTE Band 4 : 1.4MHz / 3MHz / 5MHz / 10MHz / 15MHz / 20MHz LTE Band 7 : 5MHz / 10MHz / 15MHz / 20MHz LTE Band 17 : 5MHz / 10MHz
<b>Maximum Output Power Limit</b>	LTE Band 2 : 23.64 dBm LTE Band 4 : 24.32 dBm LTE Band 7 : 23.35 dBm LTE Band 17 : 24.50 dBm
<b>Type of Modulation</b>	QPSK / 16QAM



## 2.1.3 EMISSION DESIGNATOR

LTE Band 2 BW(MHz)	Emission Designator (99%OBW)QPSK	Emission Designator (99%OBW)16QAM
1.4	1M10G7D	1M11W7D
3	2M69G7D	2M68W7D
5	4M48G7D	4M48W7D
10	8M95G7D	8M95W7D
15	13M43G7D	13M43W7D
20	17M98G7D	17M99W7D

LTE Band 4 BW(MHz)	Emission Designator (99%OBW)QPSK	Emission Designator (99%OBW)16QAM
1.4	1M10G7D	1M11W7D
3	2M69G7D	2M69W7D
5	4M48G7D	4M48W7D
10	8M95G7D	8M95W7D
15	13M42G7D	13M42W7D
20	17M97G7D	17M97W7D

LTE Band 7 BW(MHz)	Emission Designator (99%OBW)QPSK	Emission Designator (99%OBW)16QAM
5	4M49G7D	4M49W7D
10	8M94G7D	8M94W7D
15	13M44G7D	14M44W7D
20	17M95G7D	17M94W7D

LTE Band 17 BW(MHz)	Emission Designator (99%OBW)QPSK	Emission Designator (99%OBW)16QAM
5	4M49G7D	4M49W7D
10	8M94G7D	8M96W7D



2.1.4 TEST CONFIGURATION OF EQUIPMENT UNDER TEST

Antenna port conducted and radiated test items listed below are performed according to KDB 971168 D02 Power Meas. License Digital Systems v02r02 with maximum output power. Radiated measurements are performed by rotating the EUT in three different orthogonal test planes to find the maximum emission.

Remark:

1. The mark “v “ means that this configuration is chosen for testing
2. The mark “-“ means that this bandwidth is not supported.
3. The device is investigated from 30MHz to 10 times of fundamental signal for radiated

ITEMS	Band	Bandwidth (MHz)						Modulation		RB #			Test Channel		
		1.4	3	5	10	15	20	QPSK	16QAM	1	Half	Full	L	M	H
Max. Output Power	2	v	v	v	v	v	v	v	v	v	v	v	v	v	v
	4	v	v	v	v	v	v	v	v	v	v	v	v	v	v
	7	-	-	v	v	v	v	v	v	v	v	v	v	v	v
	17	-	-	v	v	-	-	v	v	v	v	v	v	v	v
Peak&Avera Ratio	2						v	v	v	v		v	v	v	v
	4						v	v	v	v		v	v	v	v
	7	-	-				v	v	v	v		v	v	v	v
	17	-	-		v	-	-	v	v	v		v	v	v	v
26dB&99% Bandwidth	2	v	v	v	v	v	v	v	v			v	v	v	v
	4	v	v	v	v	v	v	v	v			v	v	v	v
	7	-	-	v	v	v	v	v	v			v	v	v	v
	17	-	-	v	v	-	-	v	v			v	v	v	v
Conducted Band Edge	2	v	v	v	v	v	v	v	v	v		v	v	v	v
	4	v	v	v	v	v	v	v	v	v		v	v	v	v
	7	-	-	v	v	v	v	v	v	v		v	v	v	v
	17	-	-	v	v	-	-	v	v	v		v	v	v	v



ITEMS	Band	Bandwidth (MHz)						Modulation		RB #			Test Channel		
		1.4	3	5	10	15	20	QPSK	16QAM	1	Half	Full	L	M	H
Conducted Spurious Emission	2	v	v	v	v	v	v	v	v	v			v	v	v
	4	v	v	v	v	v	v	v	v	v			v	v	v
	7	-	-	v	v	v	v	v	v	v			v	v	v
	17	-	-	v	v	-	-	v	v	v			v	v	v
Frequency Stability	2				v			v				v		v	
	4				v			v				v		v	
	7	-	-		v			v				v		v	
	17	-	-		v	-	-	v				v		v	
E.R.P.& E.I.R.P.	2	v	v	v	v	v	v	v	v	v			v	v	v
	4	v	v	v	v	v	v	v	v	v			v	v	v
	7	-	-	v	v	v	v	v	v	v			v	v	v
	17	-	-	v	v	-	-	v	v	v			v	v	v
Radiated Spurious Emission	2	v	v	v	v	v	v	v		v			v	v	v
	4	v	v	v	v	v	v	v		v			v	v	v
	7	-	-	v	v	v	v	v		v			v	v	v
	17	-	-	v	v	-	-	v		v			v	v	v



#### 2.1.5 RELATED SUBMITTAL(S) / GRANT (S)

This submittal(s) (test report) is intended for filing to comply with the fcc part 22H&24E&27.

#### 2.1.6 SPECIAL ACCESSORIES

The battery and the charger, earphone supplied by the applicant were used as accessories and being tested with eut intended for fcc grant together.

#### 2.1.7 EUT CONFIGURATION

The EUT configuration for testing is installed on RF field strength measurement to meet the Commission's requirement and operating in a manner which intends to maximize its emission characteristics in a continuous normal application.

#### 2.1.8 EUT EXERCISE

The Transmitter was operated in the maximum output power mode through Communication Tester. The TX frequency was fixed which was for the purpose of the measurements.

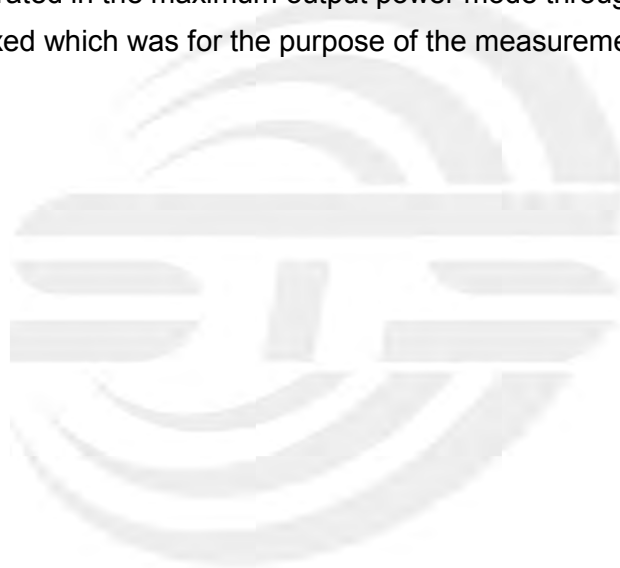

### 2.1.9 CONFIGURATION OF EUT SYSTEM

The EUT configuration for testing is installed on RF field strength measurement to meet the Commission’s requirement and operating in a manner which intends to maximize its emission characteristics in a continuous normal application.

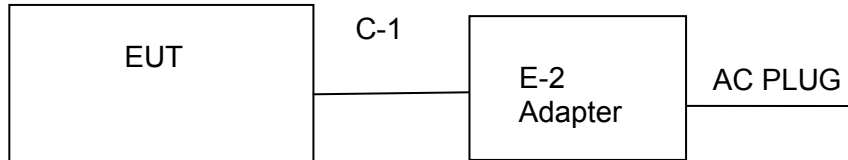

Table 2-1 Equipment Used in EUT System

Item	Equipment	Model No.	Serial No.	Note
E-1	LTE smart phone	V.40R	N/A	EUT
E-2	Adapter	V.40R	N/A	EUT

Item	Shielded Type	Ferrite Core	Length	Note
C-1	USB Cable shielded line (Charging )	NO	100cm	N/A

Note:

- (1) The support equipment was authorized by Declaration of Confirmation.
- (2) For detachable type I/O cable should be specified the length in cm in 『Length』 column.
- (3) “YES” is means “shielded” “with core”; “NO” is means “unshielded” “without core”.
- (4) PC is the FCC DOC is approved.



### 2.1.10 MEASUREMENT INSTRUMENTS

The radiated emission testing was performed according to the procedures of ansi ANSI / TIA / EIA-603-C-2004 and fcc cfr 47 rules of 2.1046, 2.1047, 2.1049, 2.1051, 2.1053, 2.1055, 2.1057.

Kind of Equipment	Manufacturer	Type No.	Serial No.	Last Calibration	Calibrated Until
Spectrum Analyzer	Agilent	E4407B	MY50140340	2015.10.25	2016.10.24
Test Receiver	R&S	ESCI	101427	2015.10.25	2016.10.24
Communication Tester	Agilent	8960	MY48360751	2015.11.20	2016.11.19
Communication Tester	R&S	CMU200	112012	2015.10.25	2016.10.24
Test Receiver	R&S	ESCI	102086	2015.10.25	2016.10.24
Bilog Antenna (measurement)	TESEQ	CBL6111D (30MHz-1GHz)	34678	2015.11.25	2016.11.24
Horn Antenna (measurement)	Schwarzbeck	BBHA 9120D(1201) (1GHz-18GHz)	9120D-1343	2015.03.06	2016.03.05
STS-E048	MXA SIGNAL Analyzer	Agilent	N9020A	2015.10.25	2016.10.24
Logarithm -Antenna(substituted)	Schwarzbeck	VUSLP 9111 (200MHz-4GHz)	9111-512	2015.09.03	2016.09.02
Horn-Antenna(substituted)	Schwarzbeck	BBHA9120D (1GHz-18GHz)	D:266	2015.03.06	2016.03.05



## 2. 1.11 MEASUREMENT RESULTS EXPLANATION EXAMPLE

For all conducted test items:

The offset level is set in the spectrum analyzer to compensate the RF cable loss and attenuator factor between EUT conducted output port and spectrum analyzer. With the offset compensation, the spectrum analyzer reading level is exactly the EUT RF output level.

The spectrum analyzer offset is derived from RF cable loss and attenuator factor.

*Offset = RF Cable Loss + Attenuator Factor.*





### 3. CONDUCTED OUTPUT POWER

#### 3.1 DESCRIPTION OF THE CONDUCTED OUTPUT POWER MEASUREMENT

##### 3.1.1 MEASUREMENT METHOD

A System Simulator Was Used To Establish Communication With The EUT. Its Parameters Were Set To Force The EUT Transmitting At Maximum Output Power. The Measured Power In The Radio Frequency On The Transmitter Output Terminals Shall Be Reported.  
configuration follows KDB 971168 D01.

##### 3.1.2 TEST SETUP



##### 3.1.3 TEST PROCEDURES

1. The Transmitter Output Port Was Connected To The System Simulator.
2. Set EUT at maximum power through the system simulator.
3. Select lowest, middle, and highest channels for each band and different modulation.
4. Measure and record the power level from the system simulator.



3.1.4 TEST RESULTS

LTE BAND 2

LTE Band 2 Maximum Average Power [dBm]						
BW [MHz]	RB Size	RB Offset	Mod	Lowest	Middle	Highest
1.4	1	0	QPSK	23.56	23.35	23.36
1.4	1	2		23.57	23.36	23.39
1.4	1	5		23.56	23.39	23.38
1.4	3	0		23.56	23.40	23.26
1.4	3	1		23.50	23.32	23.22
1.4	3	2		23.52	23.39	23.25
1.4	6	0		22.51	22.38	22.31
1.4	1	0	16-QAM	22.39	22.50	22.23
1.4	1	2		22.36	22.53	22.18
1.4	1	5		22.35	22.56	22.21
1.4	3	0		22.47	22.36	22.10
1.4	3	1		22.44	22.25	22.03
1.4	3	2		22.46	21.30	22.08
1.4	6	0		21.56	21.38	21.26
3	1	0	QPSK	23.53	23.31	23.40
3	1	7		23.48	23.28	23.31
3	1	14		23.45	23.38	23.35
3	8	0		22.61	22.44	22.40
3	8	4		22.62	22.42	22.41
3	8	7		22.58	22.44	22.37
3	15	0		22.57	22.38	22.34
3	1	0	16-QAM	22.58	22.51	22.28
3	1	7		22.61	22.45	22.19
3	1	14		22.53	22.56	22.19
3	8	0		21.74	21.55	21.44
3	8	4		21.72	21.53	21.39
3	8	7		21.71	21.54	21.39
3	15	0		21.59	21.42	21.31



LTE BAND 2

LTE Band 2 Maximum Average Power [dBm]						
BW [MHz]	RB Size	RB Offset	Mod	Lowest	Middle	Highest
5	1	0	QPSK	23.64	23.48	23.48
5	1	12		23.55	23.42	23.35
5	1	24		23.50	23.50	23.35
5	12	0		22.60	22.45	22.45
5	12	6		22.59	22.43	22.38
5	12	11		22.56	22.46	22.36
5	25	0		22.51	22.40	22.33
5	1	0	16-QAM	22.60	22.56	22.73
5	1	12		22.57	22.49	22.54
5	1	24		22.54	22.55	22.48
5	12	0		21.67	21.50	21.41
5	12	6		21.63	21.48	21.34
5	12	11		21.62	21.48	21.30
5	25	0		21.60	21.38	21.31
10	1	0	QPSK	23.58	23.42	23.55
10	1	24		23.50	23.42	23.48
10	1	49		23.29	23.48	23.25
10	25	0		22.53	22.39	22.48
10	25	12		22.50	22.40	22.44
10	25	24		22.50	22.48	22.39
10	50	0		22.50	22.43	22.45
10	1	0	16-QAM	22.63	22.59	22.52
10	1	24		22.59	22.57	22.44
10	1	49		22.49	22.63	22.25
10	25	0		21.61	21.45	21.59
10	25	12		21.59	21.48	21.54
10	25	24		21.58	21.49	21.46
10	50	0		21.50	21.42	21.44



LTE BAND 2

LTE Band 2 Maximum Average Power [dBm]						
BW [MHz]	RB Size	RB Offset	Mod	Lowest	Middle	Highest
15	1	0	QPSK	23.60	23.44	23.49
15	1	37		23.42	23.36	23.51
15	1	74		23.41	23.56	23.31
15	36	0		22.62	22.48	22.66
15	36	18		22.55	22.53	22.58
15	36	39		22.53	22.64	22.58
15	75	0		22.59	22.59	22.63
15	1	0	16-QAM	22.66	22.62	22.32
15	1	38		22.57	22.53	22.33
15	1	75		22.58	22.72	22.15
15	36	0		21.64	21.46	21.64
15	36	18		21.58	21.50	21.55
15	36	39		21.55	21.58	21.52
15	75	0		21.54	21.54	21.53
20	1	0	QPSK	23.62	23.47	23.54
20	1	49		23.44	23.45	23.33
20	1	99		23.46	23.61	23.32
20	50	0		22.53	22.40	22.56
20	50	24		22.50	22.45	22.56
20	50	49		22.47	22.54	22.47
20	100	0		22.49	22.47	22.54
20	1	0	16-QAM	22.60	22.82	23.04
20	1	49		22.46	22.76	22.93
20	1	99		22.49	22.93	22.73
20	50	0		21.57	21.42	21.57
20	50	24		21.49	21.46	21.52
20	50	49		21.51	21.51	21.44
20	100	0		21.51	21.49	21.58



LTE BAND 4

LTE Band 4 Maximum Average Power [dBm]						
BW [MHz]	RB Size	RB Offset	Mod	Lowest	Middle	Highest
1.4	1	0	QPSK	23.75	23.84	24.23
1.4	1	2		23.73	23.82	24.24
1.4	1	5		23.75	23.87	24.24
1.4	3	0		23.74	23.88	24.23
1.4	3	1		23.67	23.85	24.18
1.4	3	3		23.71	23.89	24.22
1.4	6	0		22.77	22.86	23.18
1.4	1	0	16-QAM	22.60	23.02	23.25
1.4	1	2		22.60	23.02	23.22
1.4	1	5		22.60	23.07	23.25
1.4	3	0		22.66	22.90	23.07
1.4	3	1		22.59	22.81	23.03
1.4	3	3		22.63	22.83	23.08
1.4	6	0		21.80	21.88	22.19
3	1	0	QPSK	23.74	23.80	24.21
3	1	7		23.71	23.87	24.17
3	1	14		23.72	23.83	24.23
3	8	0		22.83	22.95	23.26
3	8	4		22.82	22.95	23.29
3	8	8		22.82	22.98	23.26
3	15	0		22.75	22.92	23.22
3	1	0	16-QAM	22.82	23.01	23.19
3	1	7		22.82	23.04	23.18
3	1	14		22.79	23.01	23.23
3	8	0		21.92	22.04	22.29
3	8	4		21.90	22.08	22.30
3	8	7		21.94	22.07	22.33
3	15	0		21.75	21.95	22.20



LTE BAND 4

LTE Band 4 Maximum Average Power [dBm]						
BW [MHz]	RB Size	RB Offset	Mod	Lowest	Middle	Highest
5	1	0	QPSK	23.85	23.97	24.25
5	1	12		23.78	23.99	24.18
5	1	24		23.78	23.98	24.24
5	12	0		22.81	22.94	23.23
5	12	6		22.79	22.95	23.22
5	12	11		22.80	22.94	23.22
5	25	0		22.75	22.91	23.16
5	1	0	16-QAM	22.86	23.05	23.49
5	1	12		22.80	23.07	23.42
5	1	24		22.82	23.02	23.50
5	12	0		21.85	21.99	22.17
5	12	6		21.83	22.00	22.17
5	12	11		21.86	21.98	22.20
5	25	0		21.81	21.87	22.12
10	1	0	QPSK	23.81	23.84	24.20
10	1	24		23.78	23.91	24.22
10	1	49		23.78	23.96	24.27
10	25	0		22.73	22.88	23.12
10	25	12		22.76	22.90	23.14
10	25	24		22.77	22.97	23.19
10	50	0		22.74	22.93	23.14
10	1	0	16-QAM	22.89	23.01	23.11
10	1	12		22.86	23.10	23.18
10	1	24		22.91	23.09	23.29
10	25	0		21.77	21.94	22.17
10	25	12		21.81	21.97	22.20
10	25	24		21.83	21.99	22.25
10	50	0		21.72	21.90	22.10



LTE BAND 4

LTE Band 4 Maximum Average Power [dBm]						
BW [MHz]	RB Size	RB Offset	Mod	Lowest	Middle	Highest
15	1	0	QPSK	23.84	23.87	24.17
15	1	37		23.69	23.92	24.17
15	1	75		23.88	24.05	24.32
15	36	0		23.89	22.95	23.24
15	36	18		22.87	22.99	23.30
15	36	37		22.91	23.08	23.36
15	75	0		22.88	23.01	23.32
15	1	0	16-QAM	22.91	23.08	22.93
15	1	37		22.85	23.09	22.95
15	1	74		23.02	23.17	23.12
15	36	0		21.87	21.94	22.17
15	36	18		21.88	21.99	22.23
15	36	36		21.94	22.04	22.29
15	75	0		21.84	21.98	22.17
20	1	0	QPSK	23.85	23.90	24.00
20	1	50		23.81	23.98	24.15
20	1	99		23.94	24.11	24.28
20	50	0		22.78	22.89	23.07
20	50	24		22.82	22.93	23.11
20	50	49		22.87	23.01	23.16
20	100	0		22.81	22.95	23.12
20	1	0	16-QAM	22.81	23.25	23.48
20	1	49		22.82	23.30	23.55
20	1	99		22.98	23.42	23.74
20	50	0		21.80	21.88	22.00
20	50	24		21.82	21.93	22.03
20	50	49		21.90	21.99	22.11
20	100	0		21.83	21.96	22.11



LTE BAND 7

LTE Band 7 Maximum Average Power [dBm]						
BW [MHz]	RB Size	RB Offset	Mod	Lowest	Middle	Highest
5	1	0	QPSK	22.77	22.83	23.16
5	1	12		22.74	22.81	23.15
5	1	24		22.76	22.80	23.21
5	12	0		21.83	21.87	23.23
5	12	6		21.84	21.86	22.18
5	12	11		21.83	21.85	22.26
5	25	0		21.76	21.82	22.18
5	1	0	16-QAM	21.86	21.97	22.45
5	1	12		21.85	21.96	22.35
5	1	24		21.84	21.92	22.41
5	12	0		20.92	20.98	21.20
5	12	6		20.94	20.93	21.20
5	12	11		20.90	20.94	21.26
5	25	0		20.90	20.83	21.19
10	1	0	QPSK	22.48	22.51	22.91
10	1	24		22.54	22.50	22.85
10	1	49		22.50	22.47	22.96
10	25	0		21.49	21.67	22.01
10	25	12		21.54	21.52	21.80
10	25	24		21.45	21.55	21.95
10	50	0		21.50	21.45	21.96
10	1	0	16-QAM	21.53	21.75	22.11
10	1	12		21.59	21.68	21.98
10	1	24		21.62	21.63	22.11
10	25	0		20.67	20.60	20.86
10	25	12		20.57	20.73	20.96
10	25	24		20.61	20.71	20.95
10	50	0		20.60	20.63	20.84





LTE BAND 7

LTE Band 7 Maximum Average Power [dBm]						
BW [MHz]	RB Size	RB Offset	Mod	Lowest	Middle	Highest
15	1	0	QPSK	22.84	22.92	23.12
15	1	37		22.65	22.95	23.20
15	1	75		22.79	22.82	23.35
15	36	0		21.97	22.02	23.25
15	36	18		21.98	21.83	22.24
15	36	37		22.02	22.09	22.39
15	75	0		21.85	21.94	22.24
15	1	0	16-QAM	21.96	22.04	22.45
15	1	37		21.77	22.09	22.57
15	1	74		21.94	21.86	22.51
15	36	0		20.89	21.23	21.21
15	36	18		21.04	21.02	21.11
15	36	36		20.88	21.13	21.34
15	75	0		20.96	20.84	21.17
20	1	0	QPSK	22.76	22.92	23.28
20	1	50		22.78	22.85	23.30
20	1	99		23.02	22.99	23.28
20	50	0		21.74	22.08	23.44
20	50	24		21.87	22.12	22.14
20	50	49		21.98	21.69	22.34
20	100	0		21.79	21.83	22.39
20	1	0	16-QAM	22.01	21.90	22.45
20	1	49		22.00	21.98	22.19
20	1	99		21.72	22.05	22.60
20	50	0		21.10	20.83	21.21
20	50	24		21.12	21.15	21.09
20	50	49		21.04	21.02	21.26
20	100	0		21.03	20.89	21.30



LTE BAND 17

LTE Band 17 Maximum Average Power [dBm]						
BW [MHz]	RB Size	RB Offset	Mod	Lowest	Middle	Highest
5	1	0	QPSK	23.49	24.17	24.26
5	1	12		23.87	24.50	23.82
5	1	24		24.26	24.11	23.62
5	12	0		22.74	23.32	23.13
5	12	6		22.95	23.43	22.94
5	12	11		23.07	23.36	22.76
5	25	0		22.90	23.29	22.90
5	1	0	16-QAM	22.75	23.25	23.67
5	1	12		23.04	23.60	23.27
5	1	24		23.40	23.27	23.05
5	12	0		21.96	22.42	22.15
5	12	6		22.06	22.50	21.95
5	12	11		22.19	22.48	21.80
5	25	0		22.06	22.29	21.92
10	1	0	QPSK	23.48	23.68	23.91
10	1	24		24.29	24.41	24.31
10	1	49		23.84	23.70	23.65
10	25	0		22.93	23.10	23.22
10	25	12		23.24	23.32	23.28
10	25	24		23.27	23.16	23.01
10	50	0		23.11	23.10	23.13
10	1	0	16-QAM	22.72	22.94	23.06
10	1	24		23.46	23.63	23.46
10	1	49		23.03	22.92	22.86
10	25	0		22.20	22.16	22.35
10	25	12		22.35	22.38	22.39
10	25	24		22.36	22.20	22.14
10	50	0		22.13	22.11	22.14

#### 4. PEAK-TO-AVERAGE RATIO

##### 4.1 DESCRIPTION OF THE CONDUCTED OUTPUT POWER MEASUREMENT

###### 4.1.1 MEASUREMENT METHOD

Use one of the procedures presented in 4.1 to measure the total peak power and record as PPK. Use one of the applicable procedures presented 4.2 to measure the total average power and record as PAvg. Both the peak and average power levels must be expressed in the same logarithmic units (e.g., dBm). Determine the PAPR from:  
 $PAPR (dB) = PPK (dBm) - PAvg (dBm)$ .

###### 4.1.2 TEST SETUP

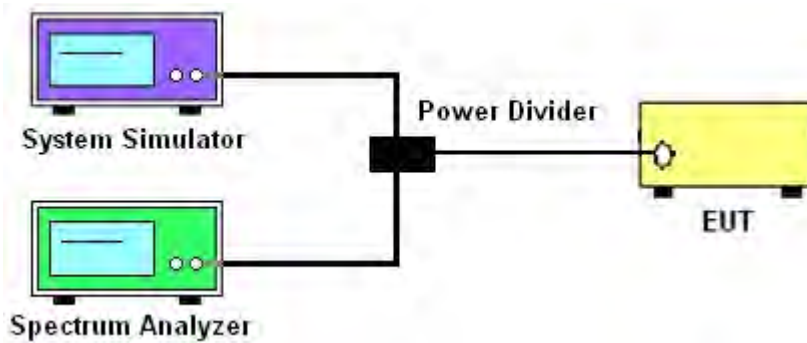

###### 4.1.3 TEST PROCEDURES

1. The testing follows FCC KDB 971168 v02r02 Section 5.7.2..
2. The EUT was connected to spectrum and system simulator via a power divider
3. Select lowest, middle, and highest channels for each band and different modulation.
4. Set the test probe and measure the peak and average power of the spectrum analyzer
5. Record the deviation as Peak to Average Ratio.

	LTE					
LTE BW	1.4M	3M	5M	10M	15M	20M
Span	3MHz	6MHz	10MHz	20MHz	30MHz	40MHz
RBW	30kHz	100kHz	100kHz	300kHz	300kHz	300kHz
VBW	100kHz	300kHz	300kHz	1000kHz	1000kHz	1000kHz
Detector	PK/RMS	PK/RMS	PK/RMS	PK/RMS	PK/RMS	PK/RMS
Peak Trace	Max	Max	Max	Max	Max	Max
AVG Trace	Trace average at least 100 traces in power averaging (i.e., RMS) mode.					
Sweep Count	Auto	Auto	Auto	Auto	Auto	Auto



4.1.4 TEST RESULTS

**LTE BAND 2**

LTE Band 2 PAR [dBm]											
BW [MHz]	RB Size	Mod	Lowest			Middle			Highest		
			PEAK	AVG	P-A	PEAK	AVG	P-A	PEAK	AVG	P-A
20	1	QPSK	26.72	23.62	2.81	26.76	23.61	3.15	26.38	23.56	2.82
20	100		25.40	22.49	3.07	25.44	22.47	2.97	25.48	22.54	2.94
20	1	16-QA	25.49	22.60	3.25	25.85	22.93	2.92	26.16	23.04	3.12
20	100	M	24.43	21.51	3.17	24.37	21.49	2.88	24.54	21.58	2.96
Limit			≤13dBm								

**LTE BAND 4**

LTE Band 4 PAR [dBm]											
BW [MHz]	RB Size	Mod	Lowest			Middle			Highest		
			PEAK	AVG	P-A	PEAK	AVG	P-A	PEAK	AVG	P-A
20	1	QPSK	27.08	23.94	3.14	27.37	24.11	3.26	27.18	24.28	2.90
20	100		25.64	22.81	2.83	26.17	22.95	3.22	26.13	23.12	3.01
20	1	16-QA	26.26	22.98	3.28	26.55	23.42	3.13	26.92	23.74	3.18
20	100	M	24.79	21.83	2.96	24.85	21.96	2.89	25.23	22.11	3.12
Limit			≤13dBm								

**LTE BAND 7**

LTE Band 7 PAR [dBm]											
BW [MHz]	RB Size	Mod	Lowest			Middle			Highest		
			PEAK	AVG	P-A	PEAK	AVG	P-A	PEAK	AVG	P-A
20	1	QPSK	26.07	23.02	3.05	26.19	22.99	3.20	26.30	23.30	3.00
20	100		25.07	21.79	3.28	24.80	21.83	2.97	25.43	22.39	3.04
20	1	16-QA	25.28	22.01	3.27	25.03	22.05	2.98	25.46	22.60	2.86
20	100	M	24.08	21.03	3.05	24.09	20.89	3.20	24.25	21.30	2.95
Limit			≤13dBm								

**LTE BAND 17**

LTE Band 17 PAR [dBm]											
BW [MHz]	RB Size	Mod	Lowest			Middle			Highest		
			PEAK	AVG	P-A	PEAK	AVG	P-A	PEAK	AVG	P-A
10	1	QPSK	27.10	24.29	2.81	27.66	24.41	3.25	27.41	24.31	3.10
10	75		26.04	23.11	2.93	26.07	23.10	2.97	26.11	23.13	2.98
10	1	16-QA	26.43	23.46	2.97	26.83	23.63	3.20	26.76	23.46	3.30
10	75	M	25.21	22.13	3.08	25.14	22.11	3.03	25.02	22.14	2.88
Limit			≤13dBm								

5. RADIATED POWER AND EFFECTIVE ISOTROPIC RADIATED POWER

5.1 DESCRIPTION OF THE ERP/EIRP MEASUREMENT

5.1.1 MEASUREMENT METHOD

Effective radiated power output measurements by substitution method according to ANSI / TIA / EIA-603-C, and the spectrum analyzer configuration follows KDB 971168 D01 Power Meas. License Digital Systems v02r02. Mobile and portable (hand-held) stations operating are limited to average ERP of 3 watts with LTE band17 . average ERP of 7 watts with LTE band 5. Equivalent isotropic radiated power output measurements by substitution method according to ANSI /TIA / EIA-603-C, and the spectrum analyzer configuration follows KDB 971168 D01 Power Meas. License Digital Systems v02r02. Mobile and portable (hand-held) stations operating are limited to average EIRP of 2 watts with LTE band 2 / 7 and 1 watt with LTE band 4.

5.1.2 TEST SETUP

The procedure of radiated spurious emissions is as follows:

a) Pre-calibration With pre-calibration method, the Radiated Spurious Emissions(RSE) is calculated as,  $RSE = Rx \text{ (dBuV)} + CL \text{ (dB)} + SA \text{ (dB)} + Gain \text{ (dBi)} - 107 \text{ (dBuV to dBm)}$  The SA is calibrated using following setup.

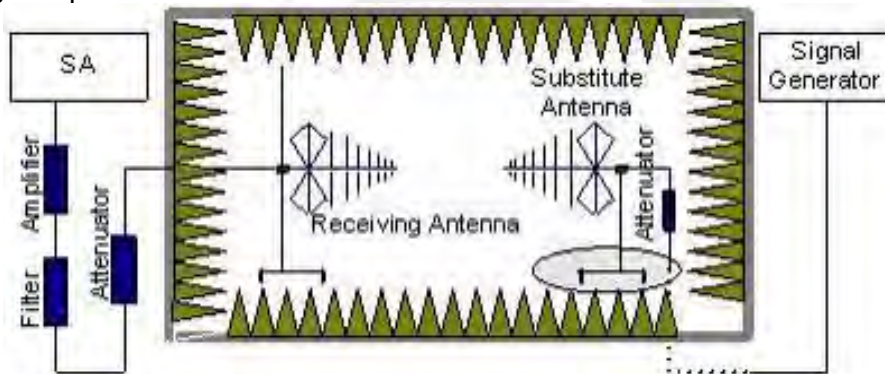

b) EUT was placed on a 0.8 meter high non-conductive stand at a 3 meter test distance from the receive antenna. A receiving antenna was placed on the antenna mast 3 meters from the test item for emission measurements. The height of receiving antenna is 0.8m. The test setup refers to figure below. Detected emissions were maximized at each frequency by rotating the test item and adjusting the receiving antenna polarization. The radiated emission measurements of all non-harmonic and harmonics of the transmit frequency through the 10th harmonic were measured with peak detector and 1MHz bandwidth.

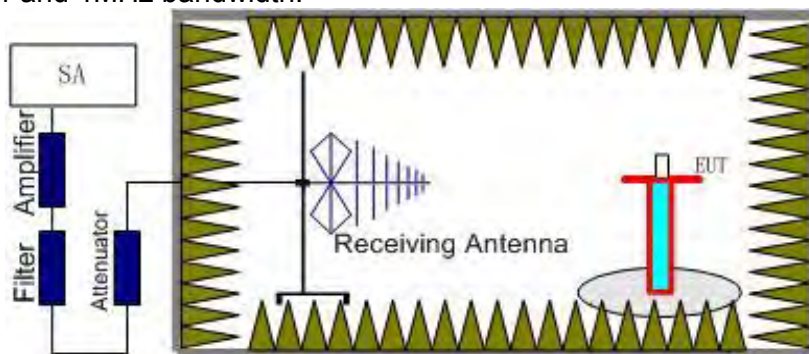



Radiated emissions measurements were made only at the upper, middle, and lower carrier frequencies. It was decided that measurements at these three carrier frequencies would be sufficient to demonstrate compliance with emissions limits because it was seen that all the significant spurs occur well outside the band and no radiation was seen from a carrier in one block of any band into any of the other blocks.

The substitution method is used. Substitution values at each frequency are measured before and saved to the test software. A "reference path loss" is established and the ARpl is the attenuation of "reference path loss", and including the gain of receive antenna, the gain of the preamplifier, the cable loss and the air loss. The measurement results are obtained as described below:  $Power = P_{Mea} + AR_{pl}$

### 5.1.3 TEST PROCEDURES

1. The testing follows FCC KDB 971168 v02r02 Section 5.6. and ANSI / TIA-603-C-2009 Section 2.2.17.
2. The EUT was placed on a non-conductive rotating platform 0.8 meters high in a semi-anechoic chamber. The radiated emission at the fundamental frequency was measured at 3 m with a test antenna and a spectrum analyzer with Peak detector.
3. During the measurement, the system simulator parameters were set to force the EUT transmitting at maximum output power. The maximum emission was recorded from analyzer power level (LVL) from the 360 degrees rotation of the turntable and the test antenna raised and lowered over a range from 1 to 4 meters in both horizontally and vertically polarized orientations.
4. Effective Isotropic Radiated Power (EIRP) was measured by substitution method according to TIA/EIA-603-C. The EUT was replaced by dipole antenna (substitution antenna) at same location, and then a known power from S.G. was applied into the dipole antenna through a Tx cable, and then recorded the maximum Analyzer reading through raised and lowered the test antenna. The correction factor (in dB) = S.G. - Tx Cable loss + Substitution antenna gain - Analyzer reading. Then the EUT's EIRP was calculated with the correction factor,  $EIRP = LVL + \text{Correction factor}$  and  $ERP = EIRP - 2.15$ .
5. RB Set greater than bandwidth, Vb Set spectrum analyzer Maximum support.



5.1.4 TEST RESULTS

**LTE Band 2**

LTE Band 2 / 1.4MHz					
Channel	Modulation	RB		Horizontal	Vertical
		Size	Offset	EIRP(dBm)	EIRP(dBm)
Lowest	QPSK	1	0	22.20	22.10
Middle		1	0	22.16	22.20
Highest		1	0	22.17	22.17
Lowest	16QAM	1	0	21.72	21.32
Middle		1	0	21.13	21.21
Highest		1	0	22.22	20.16
Limit	EIRP<2W=33dBm			Result	PASS

LTE Band 2 / 3MHz					
Channel	Modulation	RB		Horizontal	Vertical
		Size	Offset	EIRP(dBm)	EIRP(dBm)
Lowest	QPSK	1	0	22.32	22.04
Middle		1	0	22.32	22.21
Highest		1	0	22.31	22.46
Lowest	16QAM	1	0	22.13	22.17
Middle		1	0	22.32	22.26
Highest		1	0	22.26	22.17
Limit	EIRP<2W=33dBm			Result	PASS

LTE Band 2 / 5MHz					
Channel	Modulation	RB		Horizontal	Vertical
		Size	Offset	EIRP(dBm)	EIRP(dBm)
Lowest	QPSK	1	0	22.12	22.32
Middle		1	0	22.21	22.12
Highest		1	0	22.30	22.23
Lowest	16QAM	1	0	22.32	22.31
Middle		1	0	22.33	21.57
Highest		1	0	22.12	21.61
Limit	EIRP<2W=33dBm			Result	PASS





LTE Band 2 / 10MHz					
Channel	Modulation	RB		Horizontal	Vertical
		Size	Offset	EIRP(dBm)	EIRP(dBm)
Lowest	QPSK	1	0	22.23	22.21
Middle		1	0	22.09	22.32
Highest		1	0	22.20	22.43
Lowest	16QAM	1	0	22.53	22.21
Middle		1	0	22.23	22.32
Highest		1	0	22.32	22.21
Limit	EIRP<2W=33dBm			Result	PASS

LTE Band 2 / 15MHz					
Channel	Modulation	RB		Horizontal	Vertical
		Size	Offset	EIRP(dBm)	EIRP(dBm)
Lowest	QPSK	1	0	22.21	22.27
Middle		1	0	22.13	22.25
Highest		1	0	22.32	21.27
Lowest	16QAM	1	0	21.38	22.25
Middle		1	0	22.16	22.18
Highest		1	0	22.41	22.24
Limit	EIRP<2W=33dBm			Result	PASS

LTE Band 2 / 20MHz					
Channel	Modulation	RB		Horizontal	Vertical
		Size	Offset	EIRP(dBm)	EIRP(dBm)
Lowest	QPSK	1	0	21.27	21.00
Middle		1	0	21.19	21.30
Highest		1	0	21.16	21.23
Lowest	16QAM	1	0	20.06	20.13
Middle		1	0	20.25	20.34
Highest		1	0	20.27	20.16
Limit	EIRP<2W=33dBm			Result	PASS



**LTE Band 4**

LTE Band 4 / 1.4MHz					
Channel	Modulation	RB		Horizontal	Vertical
		Size	Offset	EIRP(dBm)	EIRP(dBm)
Lowest	QPSK	1	0	22.86	22.67
Middle		1	0	22.72	22.52
Highest		1	0	22.46	22.53
Lowest	16QAM	1	0	22.15	22.14
Middle		1	0	22.12	22.05
Highest		1	0	22.27	22.37
Limit	EIRP<1W=30dBm			Result	PASS

LTE Band 4 / 3MHz					
Channel	Modulation	RB		Horizontal	Vertical
		Size	Offset	EIRP(dBm)	EIRP(dBm)
Lowest	QPSK	1	0	22.25	22.67
Middle		1	0	22.18	22.60
Highest		1	0	22.22	22.61
Lowest	16QAM	1	0	21.00	21.10
Middle		1	0	21.16	21.13
Highest		1	0	21.13	21.-2
Limit	EIRP<1W=30dBm			Result	PASS

LTE Band 4 / 5MHz					
Channel	Modulation	RB		Horizontal	Vertical
		Size	Offset	EIRP(dBm)	EIRP(dBm)
Lowest	QPSK	1	0	23.36	23.16
Middle		1	0	23.27	23.02
Highest		1	0	22.43	22.19
Lowest	16QAM	1	0	22.01	22.05
Middle		1	0	22.07	22.00
Highest		1	0	22.00	22.03
Limit	EIRP<1W=30dBm			Result	PASS



LTE Band 4 / 10MHz					
Channel	Modulation	RB		Horizontal	Vertical
		Size	Offset	EIRP(dBm)	EIRP(dBm)
Lowest	QPSK	1	0	22.43	21.31
Middle		1	0	21.48	21.39
Highest		1	0	21.82	21.65
Lowest	16QAM	1	0	21.32	21.84
Middle		1	0	21.29	21.50
Highest		1	0	21.19	21.49
Limit	EIRP<1W=30dBm			Result	PASS

LTE Band 4 / 15MHz					
Channel	Modulation	RB		Horizontal	Vertical
		Size	Offset	EIRP(dBm)	EIRP(dBm)
Lowest	QPSK	1	0	23.11	23.99
Middle		1	0	23.07	23.00
Highest		1	0	23.29	23.21
Lowest	16QAM	1	0	22.23	22.22
Middle		1	0	22.18	22.17
Highest		1	0	22.22	22.10
Limit	EIRP<1W=30dBm			Result	PASS

LTE Band 4 / 20MHz					
Channel	Modulation	RB		Horizontal	Vertical
		Size	Offset	EIRP(dBm)	EIRP(dBm)
Lowest	QPSK	1	0	23.75	23.58
Middle		1	0	23.54	23.45
Highest		1	0	23.67	23.57
Lowest	16QAM	1	0	22.78	22.76
Middle		1	0	22.52	22.57
Highest		1	0	22.33	22.85
Limit	EIRP<1W=30dBm			Result	PASS



## LTE Band 7

LTE Band 7 / 5MHz					
Channel	Modulation	RB		Horizontal	Vertical
		Size	Offset	EIRP(dBm)	EIRP(dBm)
Lowest	QPSK	1	0	21.62	21.42
Middle		1	0	21.31	21.76
Highest		1	0	21.51	21.25
Lowest	16QAM	1	0	20.20	20.10
Middle		1	0	20.87	20.70
Highest		1	0	20.22	20.03
Limit	EIRP<1W=30dBm			Result	PASS

LTE Band 7 / 10MHz					
Channel	Modulation	RB		Horizontal	Vertical
		Size	Offset	EIRP(dBm)	EIRP(dBm)
Lowest	QPSK	1	0	21.66	21.54
Middle		1	0	21.62	21.50
Highest		1	0	21.23	21.49
Lowest	16QAM	1	0	21.02	20.84
Middle		1	0	21.29	21.50
Highest		1	0	21.19	20.69
Limit	EIRP<1W=30dBm			Result	PASS

LTE Band 7 / 15MHz					
Channel	Modulation	RB		Horizontal	Vertical
		Size	Offset	EIRP(dBm)	EIRP(dBm)
Lowest	QPSK	1	0	22.78	22.76
Middle		1	0	22.64	23.54
Highest		1	0	22.22	22.10
Lowest	16QAM	1	0	21.23	21.22
Middle		1	0	21.18	21.17
Highest		1	0	21.22	21.10
Limit	EIRP<1W=30dBm			Result	PASS



LTE Band 7 / 20MHz					
Channel	Modulation	RB		Horizontal	Vertical
		Size	Offset	EIRP(dBm)	EIRP(dBm)
Lowest	QPSK	1	0	21.78	21.76
Middle		1	0	21.55	21.57
Highest		1	0	21.27	21.85
Lowest	16QAM	1	0	21.28	21.56
Middle		1	0	21.55	21.57
Highest		1	0	21.27	21.25
Limit	EIRP<1W=30dBm			Result	PASS





**LTE Band 17**

LTE Band 17 / 5MHz					
Channel	Modulation	RB		Horizontal	Vertical
		Size	Offset	EIRP(dBm)	EIRP(dBm)
Lowest	QPSK	1	0	23.09	23.33
Middle		1	0	23.35	23.25
Highest		1	0	23.16	23.03
Lowest	16QAM	1	0	22.84	22.77
Middle		1	0	22.64	22.57
Highest		1	0	22.78	22.69
Limit	ERP<2W=34.77dBm			Result	PASS

LTE Band 17 / 10MHz					
Channel	Modulation	RB		Horizontal	Vertical
		Size	Offset	EIRP(dBm)	EIRP(dBm)
Lowest	QPSK	1	0	22.34	22.52
Middle		1	0	22.04	22.77
Highest		1	0	22.24	22.52
Lowest	16QAM	1	0	21.56	22.12
Middle		1	0	21.83	22.01
Highest		1	0	21.76	22.03
Limit	ERP<3W=34.77dBm			Result	PASS

## 6. OCCUPIED BANDWIDTH

### 6.1 DESCRIPTION OF OCCUPIED BANDWIDTH MEASUREMENT

#### 6.1.1 MEASUREMENT METHOD

1.The occupied bandwidth is the width of a frequency band such that, below the lower and above the upper frequency limits, the mean powers emitted are each equal to a specified percentage 0.5% of the total mean transmitted power.

2.The 26 db emission bandwidth is defined as the frequency range between two points, one above and one below the carrier frequency, at which the spectral density of the emission is attenuated 26 db below the maximum in-band spectral density of the modulated signal. spectral density (power per unit bandwidth) is to be measured with a detector of resolution bandwidth equal to approximately 1.0% of the emission bandwidth.

#### 6.1.2 TEST SETUP

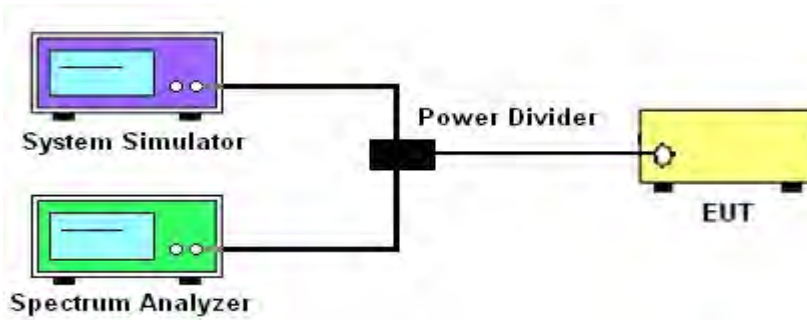

#### 6.1.3 TEST PROCEDURES

1. The testing follows FCC KDB 971168 v02r02 Section 4.1.and 4.2
2. The EUT was connected to spectrum and system simulator via a power divider
3. Select lowest, middle, and highest channels for each band and different modulation.
4. Set the test probe and measure the Occupied Bandwidth of the spectrum analyzer
5. Measure and record the Occupied Bandwidth from the Spectrum Analyzer.

	LTE					
LTE BW	1.4M	3M	5M	10M	15M	20M
Span	3MHz	6MHz	10MHz	20MHz	30MHz	40MHz
RBW	30kHz	100kHz	100kHz	300kHz	300kHz	300kHz
VBW	100kHz	300kHz	300kHz	1000kHz	1000kHz	1000kHz
Detector	PK	PK	PK	PK	PK	PK
Trace	Max	Max	Max	Max	Max	Max
Sweep Count	Auto	Auto	Auto	Auto	Auto	Auto



## 6.1.4 MEASUREMENT RESULT

## LTE BAND 2

LTE Band 2 Bandwidth [MHz]							
BW [MHz]	Mod	Lowest		Middle		Highest	
		26dB BW	99% BW	26dB BW	99% BW	26dB BW	99% BW
1.4	QPSK	1.291	1.0976	1.266	1.1044	1.323	1.1035
1.4	16-QAM	1.291	1.0989	1.262	1.1051	1.387	1.1020
3	QPSK	2.899	2.6805	2.891	2.6877	2.982	2.6853
3	16-QAM	2.909	2.6812	2.893	2.6820	2.919	2.6842
5	QPSK	4.906	4.4830	4.951	4.4837	4.910	4.4809
5	16-QAM	4.939	4.4831	4.975	4.4786	4.902	4.4793
10	QPSK	9.734	8.9478	9.638	8.9118	9.771	8.9326
10	16-QAM	9.755	8.9466	9.640	8.9209	9.813	8.9311
15	QPSK	14.58	13.430	14.50	13.371	14.65	13.418
15	16-QAM	14.56	13.433	14.44	13.384	14.61	13.421
20	QPSK	19.49	17.975	19.40	17.907	19.45	17.977
20	16-QAM	19.34	17.985	19.44	17.887	19.47	17.965

## LTE BAND 4

LTE Band 4 Bandwidth [MHz]							
BW [MHz]	Mod	Lowest		Middle		Highest	
		26dB BW	99% BW	26dB BW	99% BW	26dB BW	99% BW
1.4	QPSK	1.270	1.0956	1.283	1.0961	1.263	1.1043
1.4	16-QAM	1.260	1.0955	1.274	1.0983	1.259	1.1061
3	QPSK	2.888	2.6788	2.898	2.6890	2.912	2.6836
3	16-QAM	2.893	2.6820	2.902	2.6879	2.912	2.6840
5	QPSK	4.926	4.4838	4.971	4.4834	4.918	4.4831
5	16-QAM	4.928	4.4841	4.960	4.4847	4.943	4.4846
10	QPSK	9.778	8.9462	9.660	8.9311	9.665	8.9420
10	16-QAM	9.766	8.9462	9.668	8.9436	9.629	8.9299
15	QPSK	14.53	13.422	14.58	13.401	14.62	13.413
15	16-QAM	14.48	13.405	14.65	13.415	14.67	13.418
20	QPSK	19.33	17.943	19.55	17.966	19.41	17.900
20	16-QAM	19.23	17.952	19.42	17.971	19.31	17.918



**LTE BAND 7**

LTE Band 7 Bandwidth [MHz]							
BW [MHz]	Mod	Lowest		Middle		Highest	
		26dB BW	99% BW	26dB BW	99% BW	26dB BW	99% BW
5	QPSK	4.931	4.4846	4.939	4.4870	4.905	4.4810
5	16-QAM	4.913	4.4824	4.907	4.4850	4.930	4.4839
10	QPSK	9.714	8.9413	9.662	8.9291	9.723	8.9352
10	16-QAM	9.688	8.9354	9.667	8.9349	9.758	8.9411
15	QPSK	14.51	13.411	14.58	13.426	14.52	13.444
15	16-QAM	14.44	13.411	14.59	13.432	14.61	13.437
20	QPSK	19.43	17.905	19.49	17.953	19.41	17.905
20	16-QAM	19.34	17.920	19.53	17.936	19.31	17.912

**LTE BAND 17**

LTE Band XVII Bandwidth [MHz]							
BW [MHz]	Mod	Lowest		Middle		Highest	
		26dB BW	99% BW	26dB BW	99% BW	26dB BW	99% BW
5	QPSK	4.901	4.4765	4.899	4.4715	4.976	4.4903
5	16-QAM	4.902	4.4742	4.911	4.4825	4.983	4.4887
10	QPSK	9.560	8.9108	9.673	8.9419	9.678	8.9405
10	16-QAM	9.499	8.8950	9.693	8.9452	9.613	8.9415



LTE band 2

LTE band 2 (99% and -26 Bandwidth)

Lowest Channel / 1.4MHz / QPSK

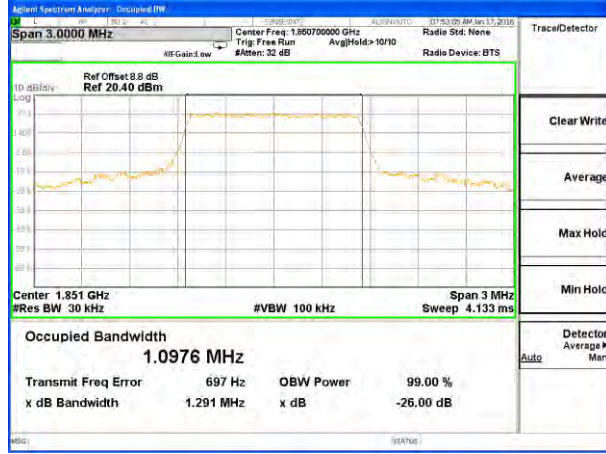

Lowest Channel / 1.4MHz / 16QAM

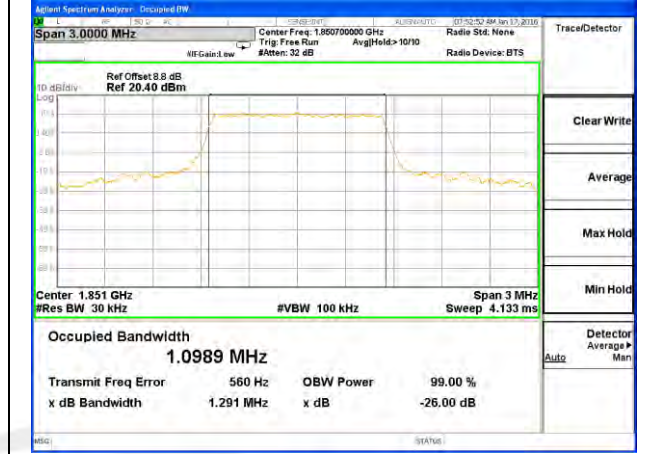

Middle Channel / 1.4MHz / QPSK

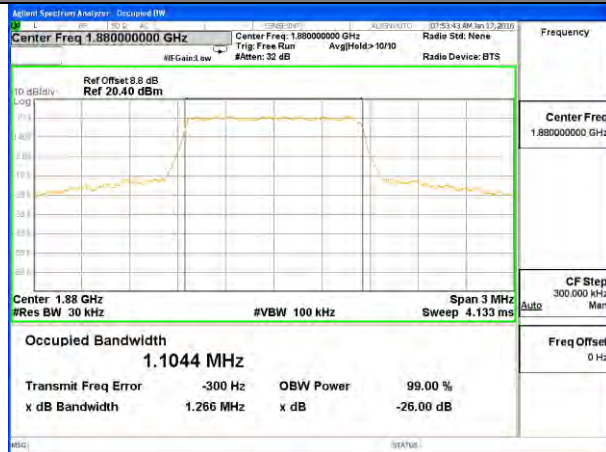

Middle Channel / 1.4MHz / 16QAM

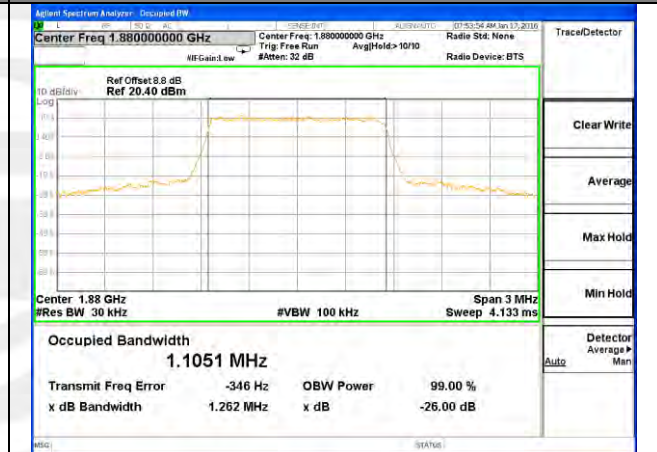

Highest Channel / 1.4MHz / QPSK

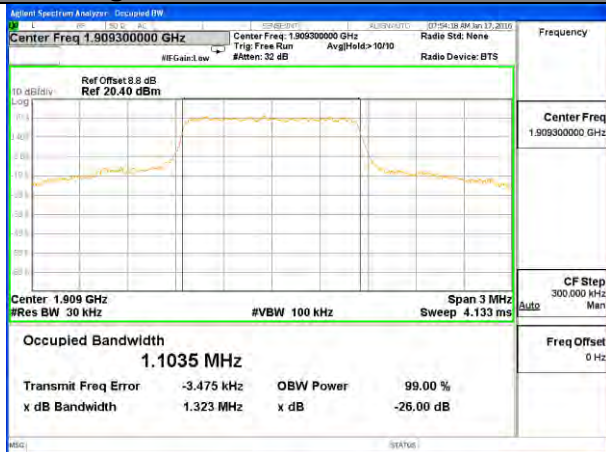

Highest Channel / 1.4MHz / 16QAM

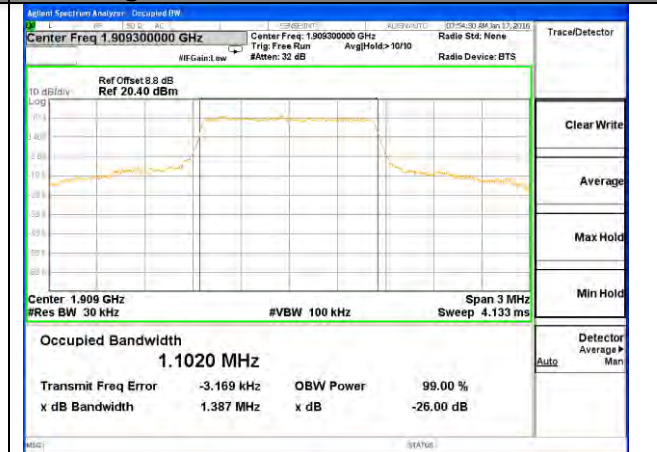



LTE band 2

LTE band 2 (99% and -26 Bandwidth)





LTE band 2

LTE band 2 (99% and -26 Bandwidth)





LTE band 2

LTE band 2 (99% and -26 Bandwidth)

Lowest Channel / 10MHz / QPSK

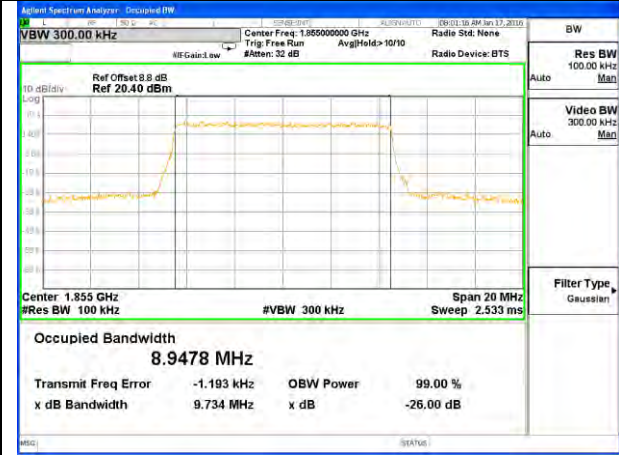

Lowest Channel / 10MHz / 16QAM



Middle Channel / 10MHz / QPSK

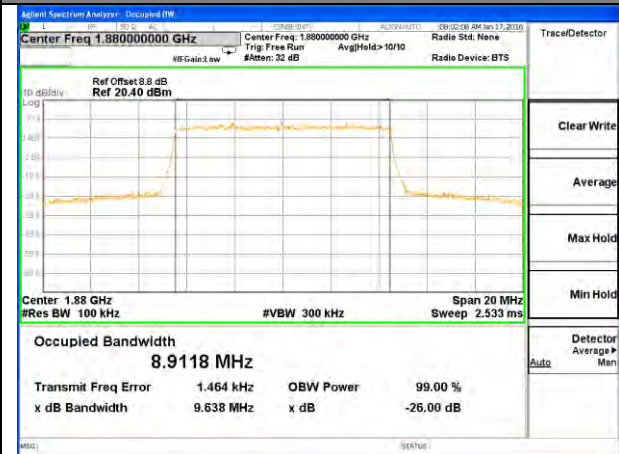

Middle Channel / 10MHz / 16QAM

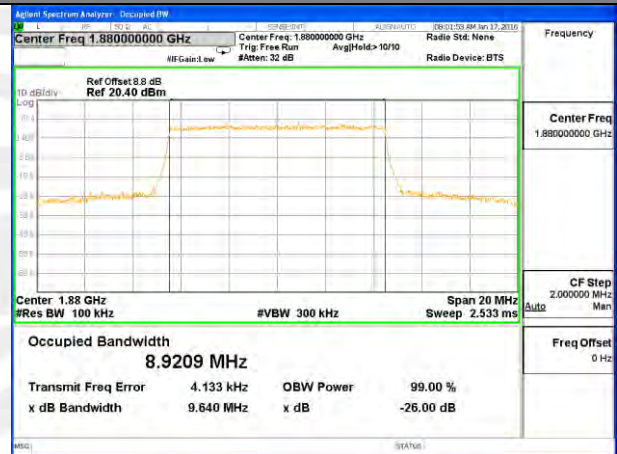

Highest Channel / 10MHz / QPSK

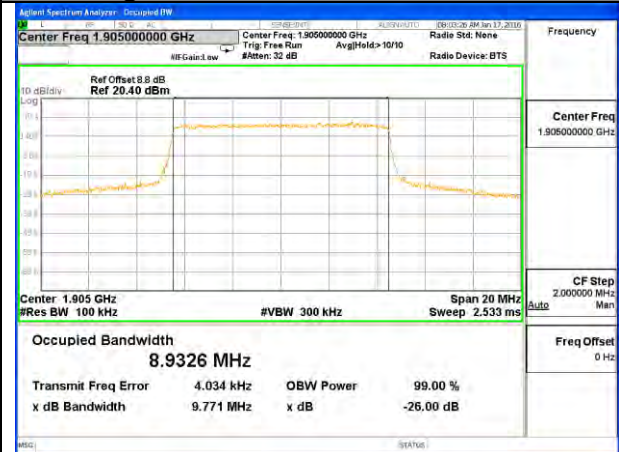

Highest Channel / 10MHz / 16QAM

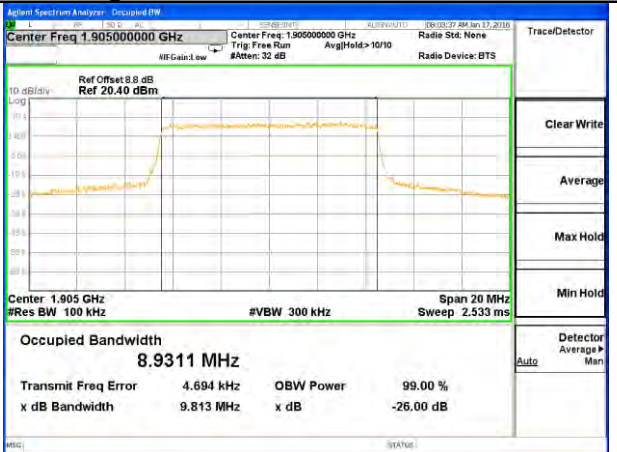



LTE band 2

LTE band 2 (99% and -26 Bandwidth)

Lowest Channel / 15MHz / QPSK

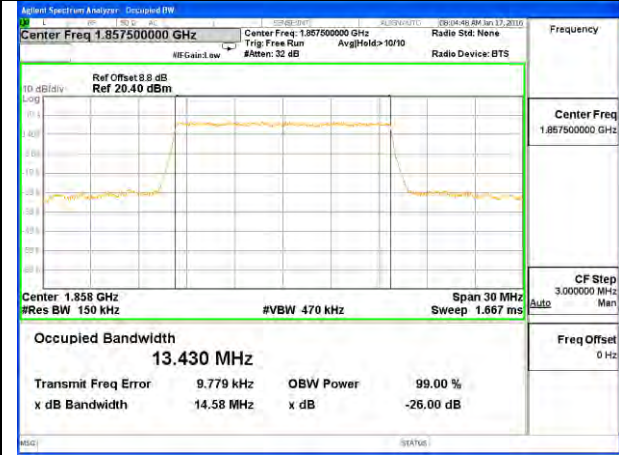

Lowest Channel / 15MHz / 16QAM

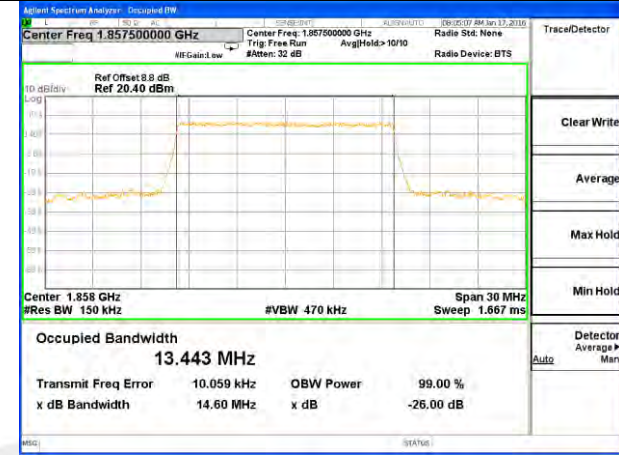

Middle Channel / 15MHz / QPSK

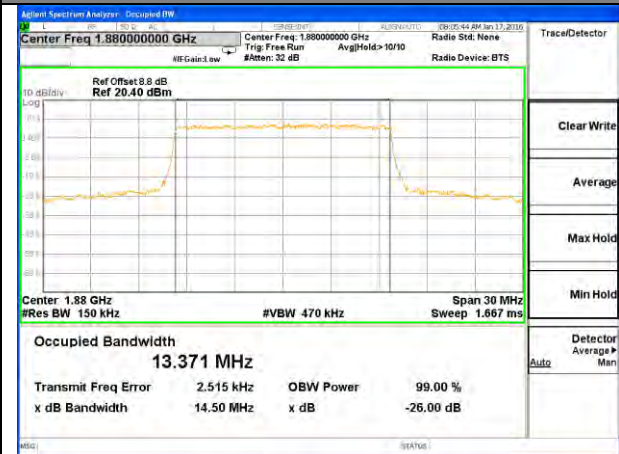

Middle Channel / 15MHz / 16QAM

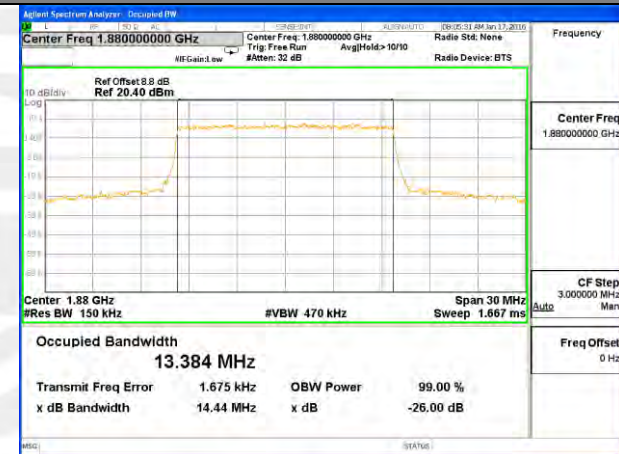

Highest Channel / 15MHz / QPSK

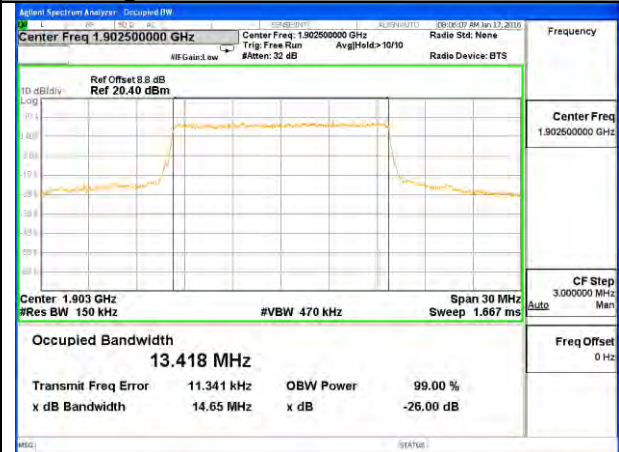

Highest Channel / 15MHz / 16QAM

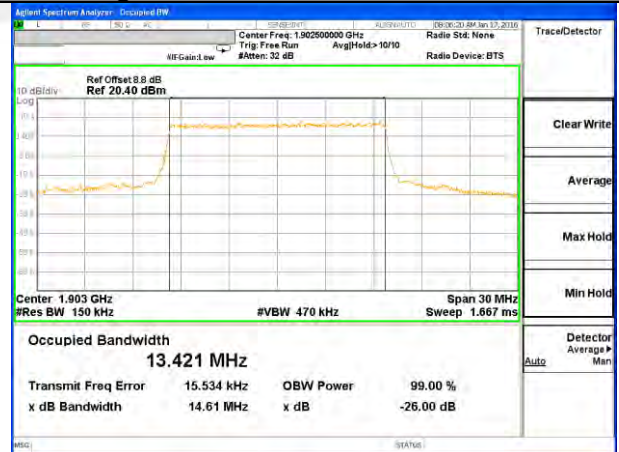



LTE band 2

LTE band 2 (99% and -26 Bandwidth)





LTE band 4

LTE band 4 (99% and -26 Bandwidth)

Lowest Channel / 1.4MHz / QPSK



Lowest Channel / 1.4MHz / 16QAM

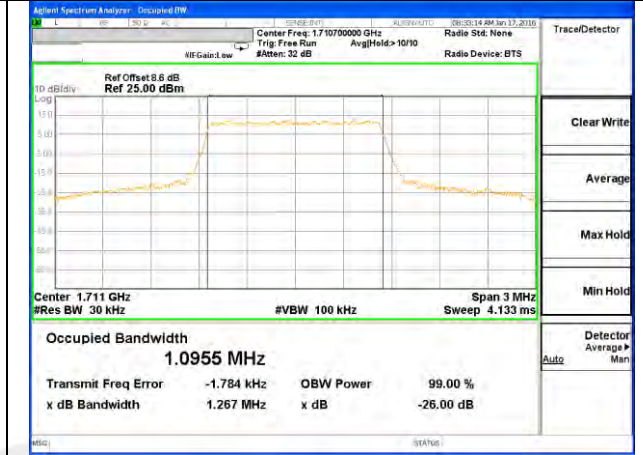

Middle Channel / 1.4MHz / QPSK

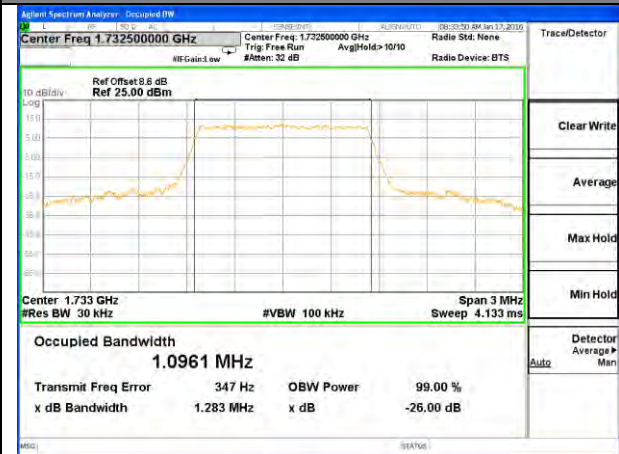

Middle Channel / 1.4MHz / 16QAM

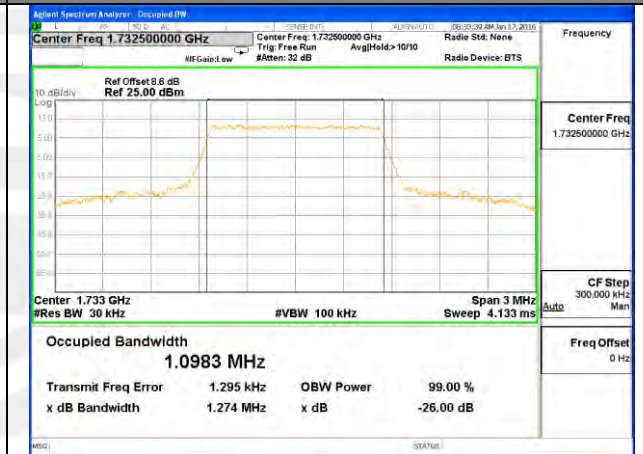

Highest Channel / 1.4MHz / QPSK

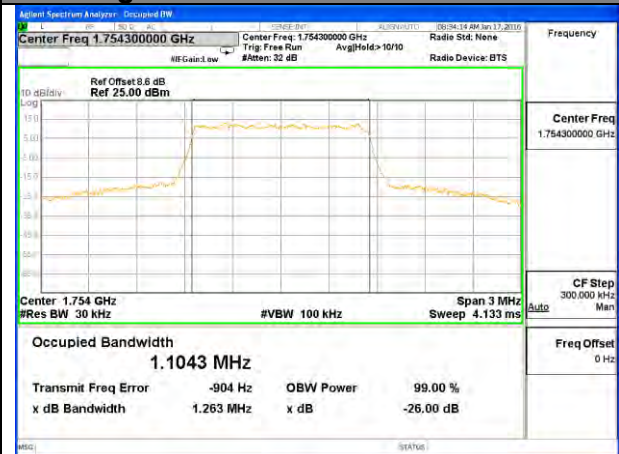

Highest Channel / 1.4MHz / 16QAM

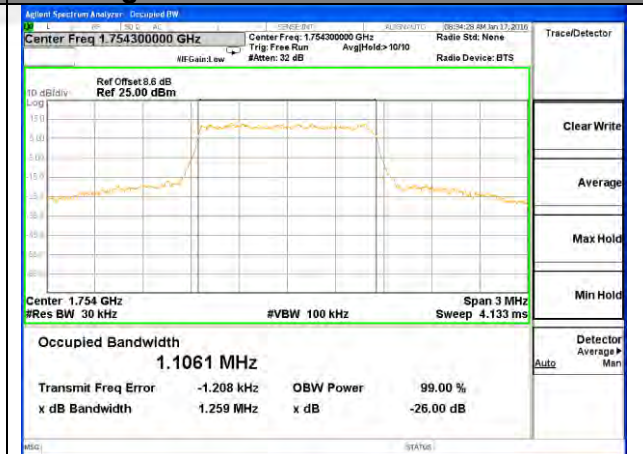





LTE band 4

LTE band 4 (99% and -26 Bandwidth)





LTE band 4

LTE band 4 (99% and -26 Bandwidth)

Lowest Channel / 5MHz / QPSK

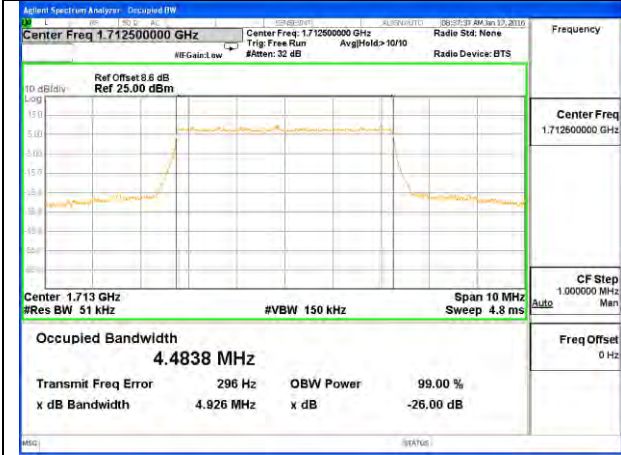

Lowest Channel / 5MHz / 16QAM

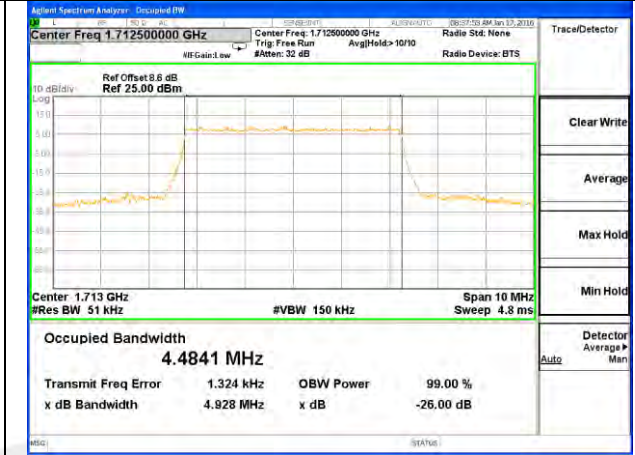

Middle Channel / 5MHz / QPSK



Middle Channel / 5MHz / 16QAM

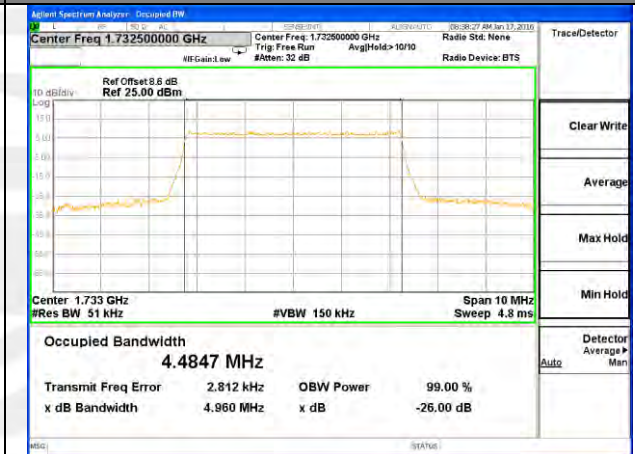

Highest Channel / 5MHz / QPSK

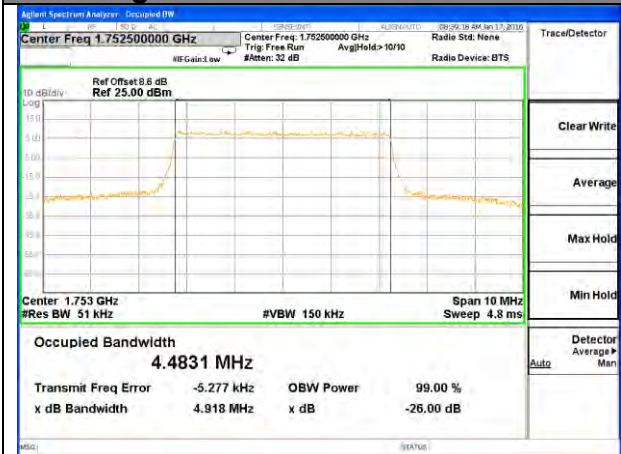

Highest Channel / 5MHz / 16QAM

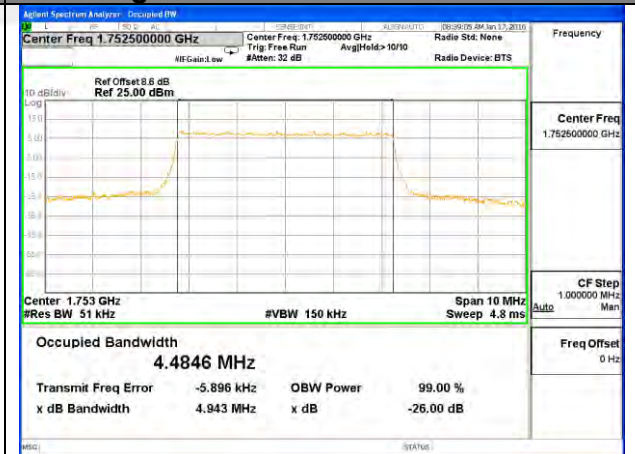



LTE band 4

LTE band 4 (99% and -26 Bandwidth)





LTE band 4

LTE band 4 (99% and -26 Bandwidth)

Lowest Channel / 15MHz / QPSK

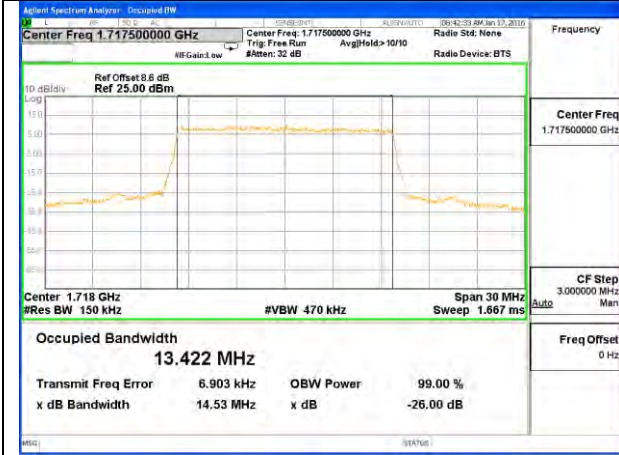

Lowest Channel / 15MHz / 16QAM

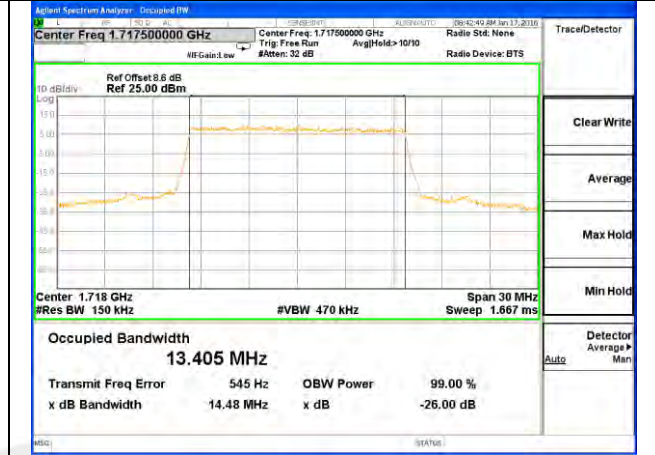

Middle Channel / 15MHz / QPSK

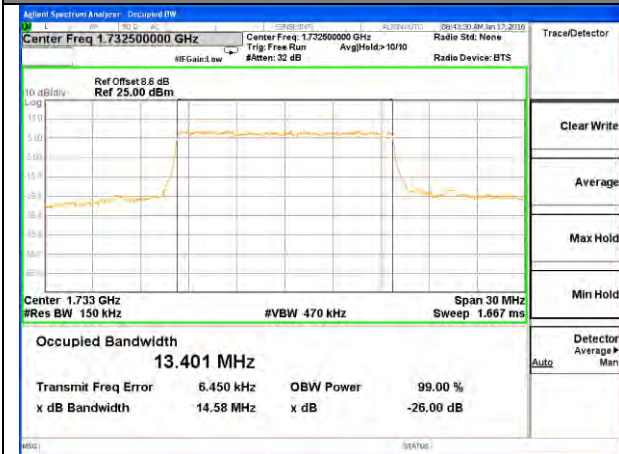

Middle Channel / 15MHz / 16QAM

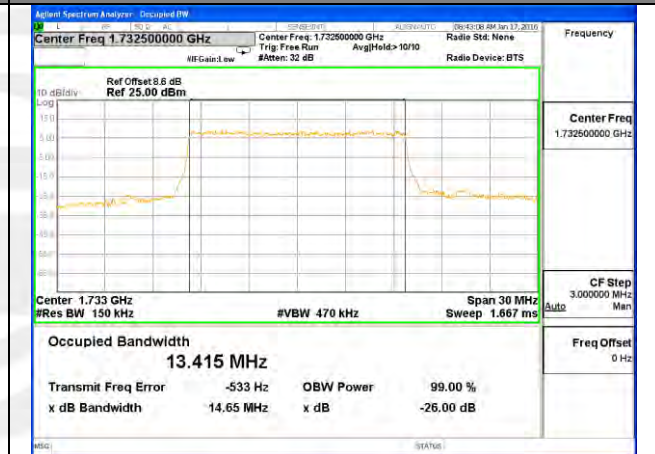

Highest Channel / 15MHz / QPSK

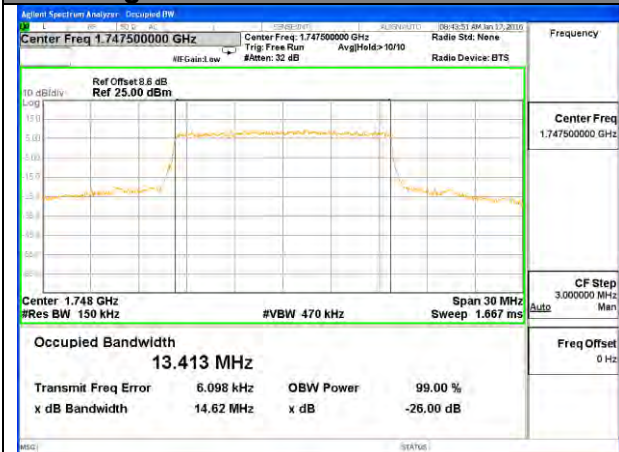

Highest Channel / 15MHz / 16QAM

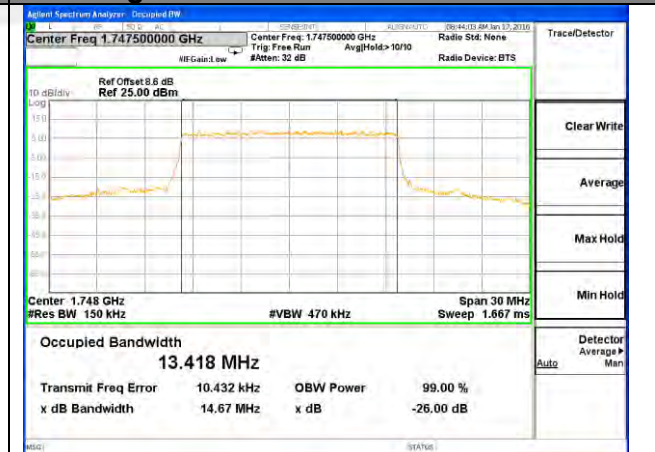



LTE band 4

LTE band 4 (99% and -26 Bandwidth)





LTE band 7

LTE band 7 (99% and -26 Bandwidth)





LTE band 7

LTE band 7 (99% and -26 Bandwidth)

Lowest Channel / 10MHz / QPSK



Lowest Channel / 10MHz / 16QAM



Middle Channel / 10MHz / QPSK



Middle Channel / 10MHz / 16QAM

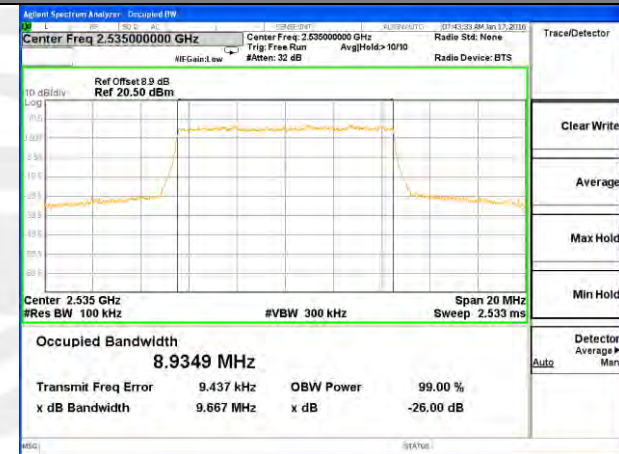

Highest Channel / 10MHz / QPSK



Highest Channel / 10MHz / 16QAM

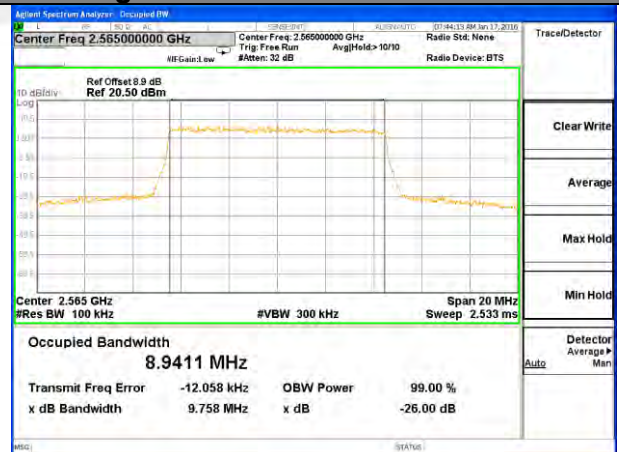



LTE band 7

LTE band 7 (99% and -26 Bandwidth)







LTE band 7

LTE band 7 (99% and -26 Bandwidth)

Lowest Channel / 20MHz / QPSK

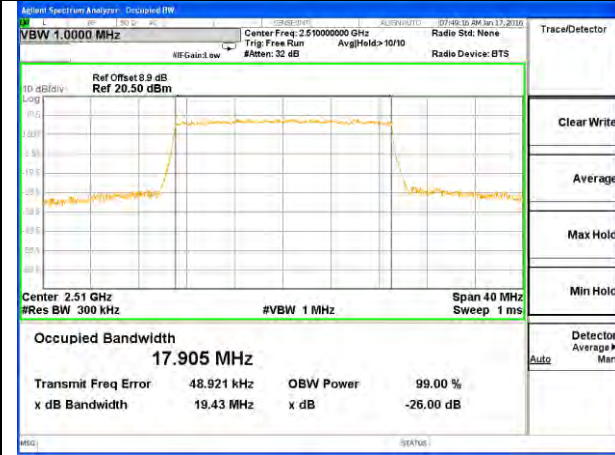

Lowest Channel / 20MHz / 16QAM

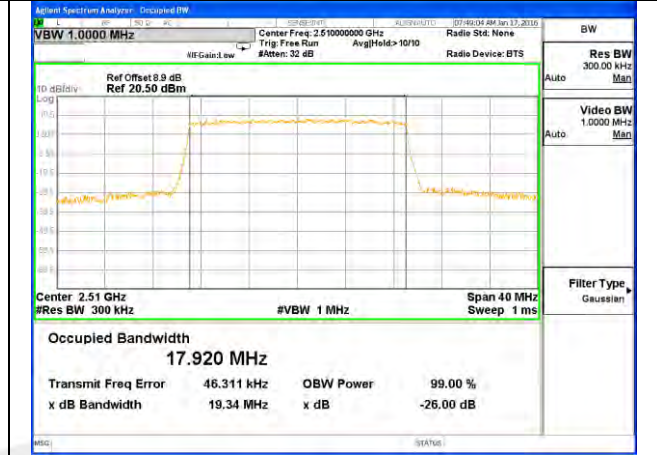

Middle Channel / 20MHz / QPSK

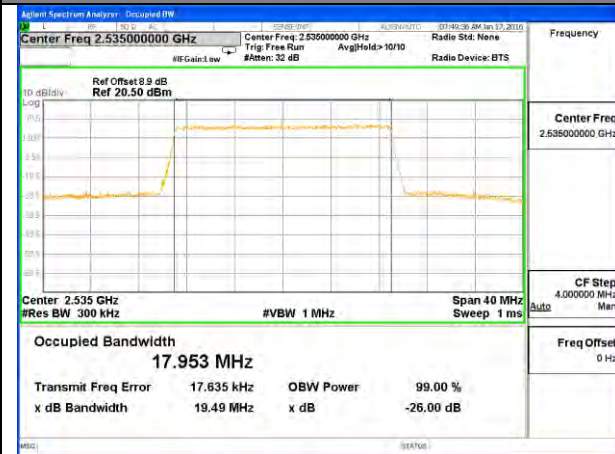

Middle Channel / 20MHz / 16QAM

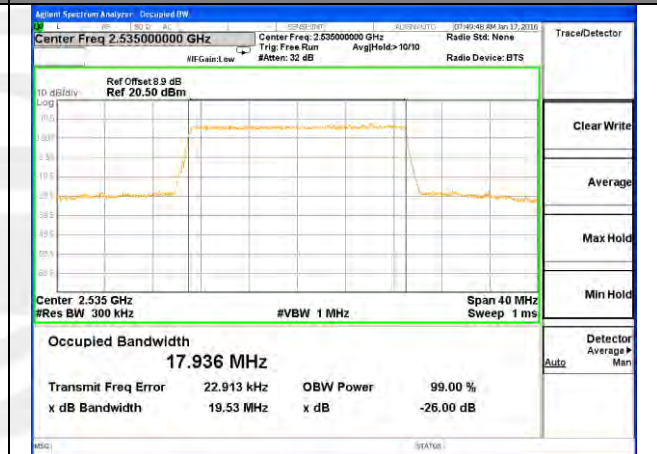

Highest Channel / 20MHz / QPSK

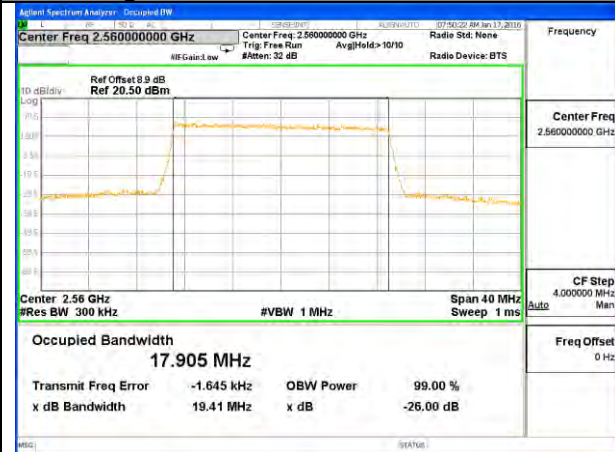

Highest Channel / 20MHz / 16QAM





LTE band 17

LTE band 17 (99% and -26 Bandwidth)

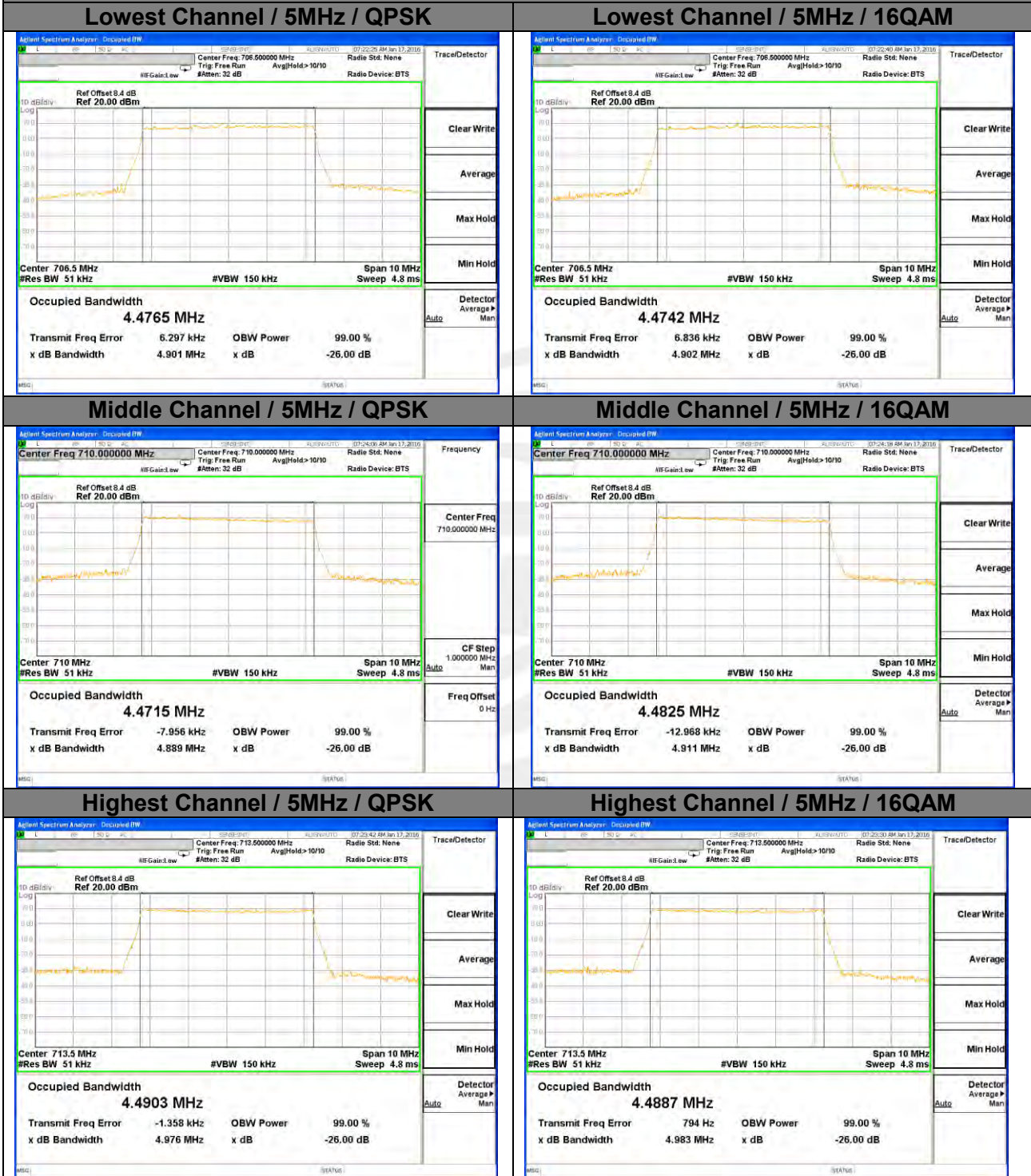



LTE band 17

LTE band 17 (99% and -26 Bandwidth)

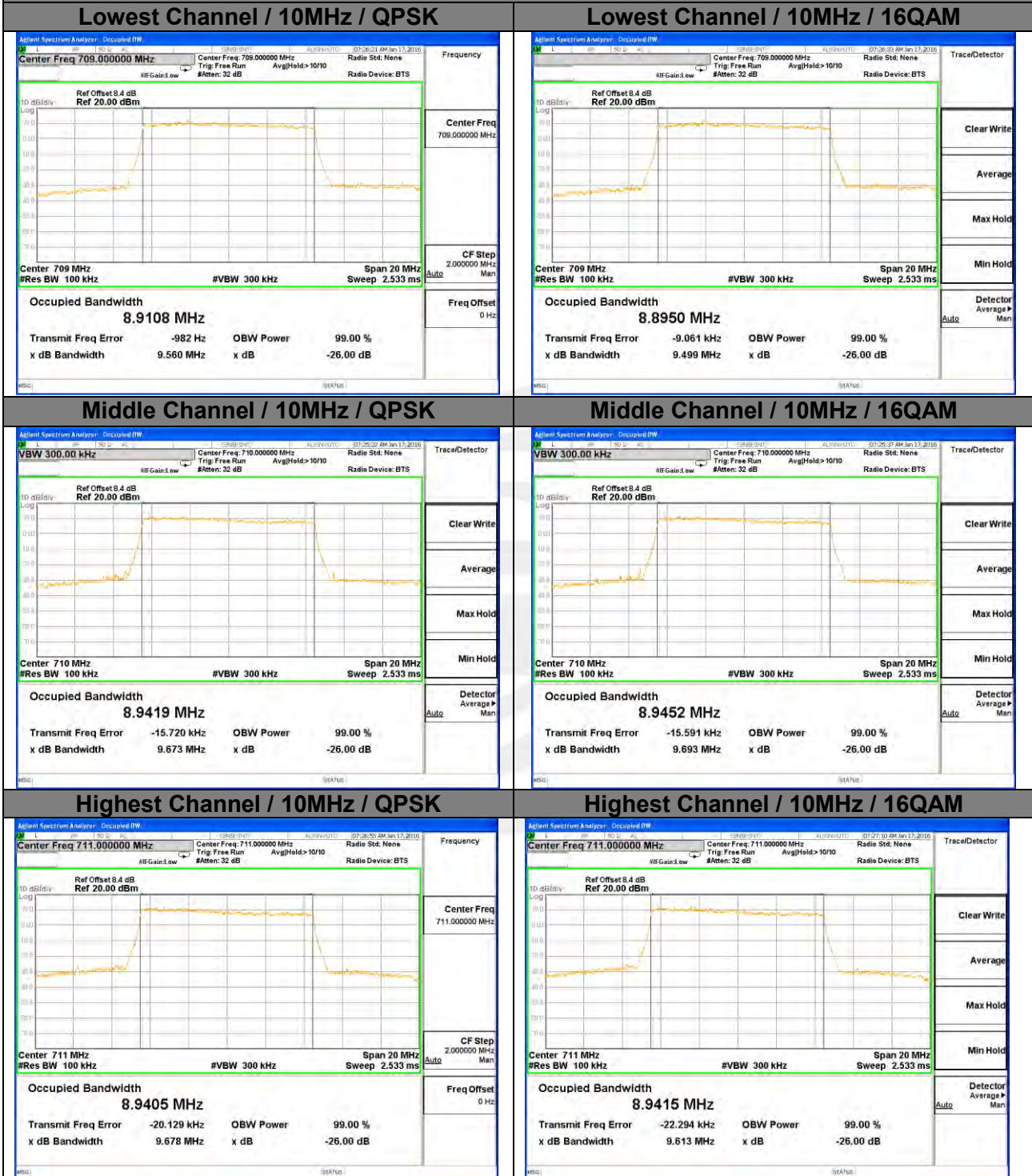



## 7. CONDUCTED BAND EDGE

### 7.1 DESCRIPTION OF CONDUCTED BAND EDGE MEASUREMENT

#### 7.1.1 MEASUREMENT METHOD

##### 1. §22.917(a)

For operations in the 824 – 849 MHz band, the FCC limit is  $43 + 10\log_{10}(P[\text{Watts}])$  dB below the transmitter power  $P(\text{Watts})$  in a 100kHz bandwidth. However, in the 1MHz bands immediately outside and adjacent to the licensee's frequency block, a resolution bandwidth of at least one percent of the emission bandwidth of the fundamental emission of the transmitter may be employed.

##### 2. §24.238 (a)

For operations in the 1850-1910 and 1930-1990 MHz band, the FCC limit is  $43 + 10\log_{10}(P[\text{Watts}])$  dB below the transmitter power  $P(\text{Watts})$  in a 1MHz bandwidth. However, in the 1 MHz bands immediately outside and adjacent to the frequency block a resolution bandwidth of at least one percent of the emission bandwidth of the fundamental emission of the transmitter may be employed

##### 3. §27.53 (h)

For operations in the 1710 – 1755 MHz band, the FCC limit is  $43 + 10\log_{10}(P[\text{Watts}])$  dB below the transmitter power  $P(\text{Watts})$  in a 1 MHz bandwidth. However, in the 1MHz bands immediately outside and adjacent to the licensee's frequency block, a resolution bandwidth of at least one percent of the emission bandwidth of the fundamental emission of the transmitter may be employed.

##### 4. §27.53(m)(4/6)

For operations in the 2502.5 MHz ~ 2567.5 MHz band this section, the attenuation factor shall be not less than  $40 + 10 \log (P)$  dB on all frequencies between the channel edge and 5 megahertz from the channel edge,  $43 + 10 \log (P)$  dB on all frequencies between 5 megahertz and X megahertz from the channel edge, and  $55 + 10 \log (P)$  dB on all frequencies more than X megahertz from the channel edge, where X is the greater of 6 megahertz or the actual emission bandwidth as defined in paragraph (m)(6) of this section. In addition, the attenuation factor shall not be less than  $43 + 10 \log (P)$  dB on all frequencies between 2490.5 MHz and 2496 MHz and  $55 + 10 \log (P)$  dB at or below 2490.5 MHz. Mobile Satellite Service licensees operating on frequencies below 2495 MHz may also submit a documented interference complaint against BRS licensees operating on channel BRS Channel 1 on the same terms and conditions as adjacent channel BRS or EBS licensees.

##### 5. §27.53 (g)

For operations in the 698 -746 MHz band, the FCC limit is  $43 + 10\log_{10}(P[\text{Watts}])$  dB below the transmitter power  $P(\text{Watts})$  in a 100 kHz bandwidth. However, in the 100 kilohertz bands immediately outside and adjacent to a licensee's frequency block, a resolution bandwidth of at least 30 kHz may be employed.

7.1.2 TEST SETUP

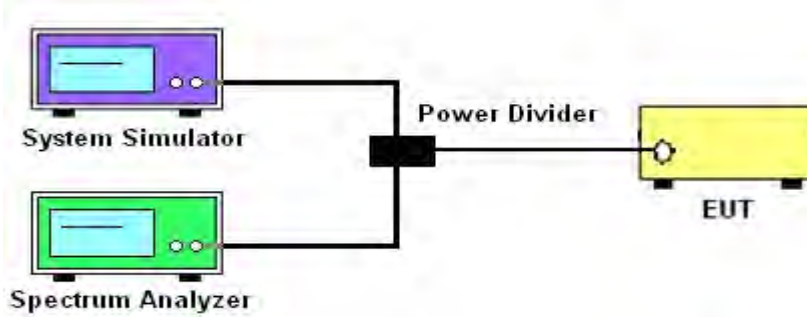

7.1.3 TEST PROCEDURES

1. The testing follows FCC KDB 971168 v02r02 Section 6.0.
2. The EUT was connected to spectrum analyzer and system simulator via a power divider.
3. The band edges of low and high channels for the highest RF powers were measured. Set RBW  $\geq 1\%$  EBW in the 1MHz band immediately outside and adjacent to the band edge.
4. Set spectrum analyzer with RMS/AVG detector
5. The RF fundamental frequency should be excluded against the limit line in the operating frequency band.
6. The limit line is derived from  $43 + 10\log(P)$  dB below the transmitter power P(Watts)  
 $= P(W) - [43 + 10\log(P)]$  (dB)  
 $= [30 + 10\log(P)]$  (dBm) -  $[43 + 10\log(P)]$  (dB)  
 $= -13$  dBm.

Band 7:  
 $= P(W) - [55 + 10\log(P)]$  (dB)  
 $= [30 + 10\log(P)]$  (dBm) -  $[55 + 10\log(P)]$  (dB)  
 $= -25$  dBm.

	LTE					
LTE BW	1.4M	3M	5M	10M	15M	20M
Span	12MHz	13MHz	15MHz	20MHz	25MHz	30MHz
RBW	30kHz	100kHz	100kHz	300kHz	300kHz	300kHz
VBW	100kHz	300kHz	300kHz	1000kHz	1000kHz	1000kHz
Detector	AVG	AVG	AVG	AVG	AVG	AVG
Trace	Max	Max	Max	Max	Max	Max
Sweep Count	Auto	Auto	Auto	Auto	Auto	Auto



7.1.4 MEASUREMENT RESULT

LTE band 2

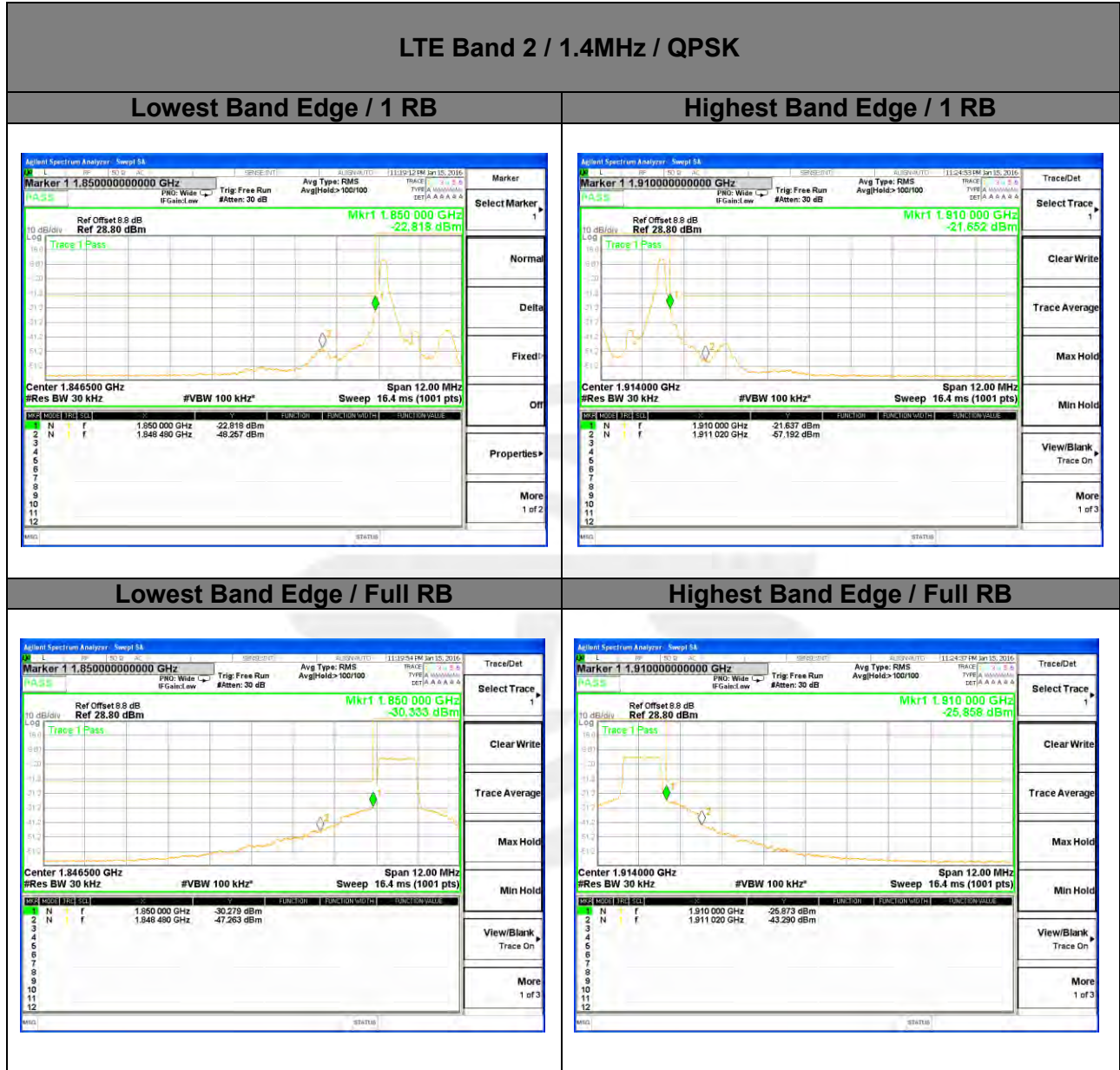



LTE band 2

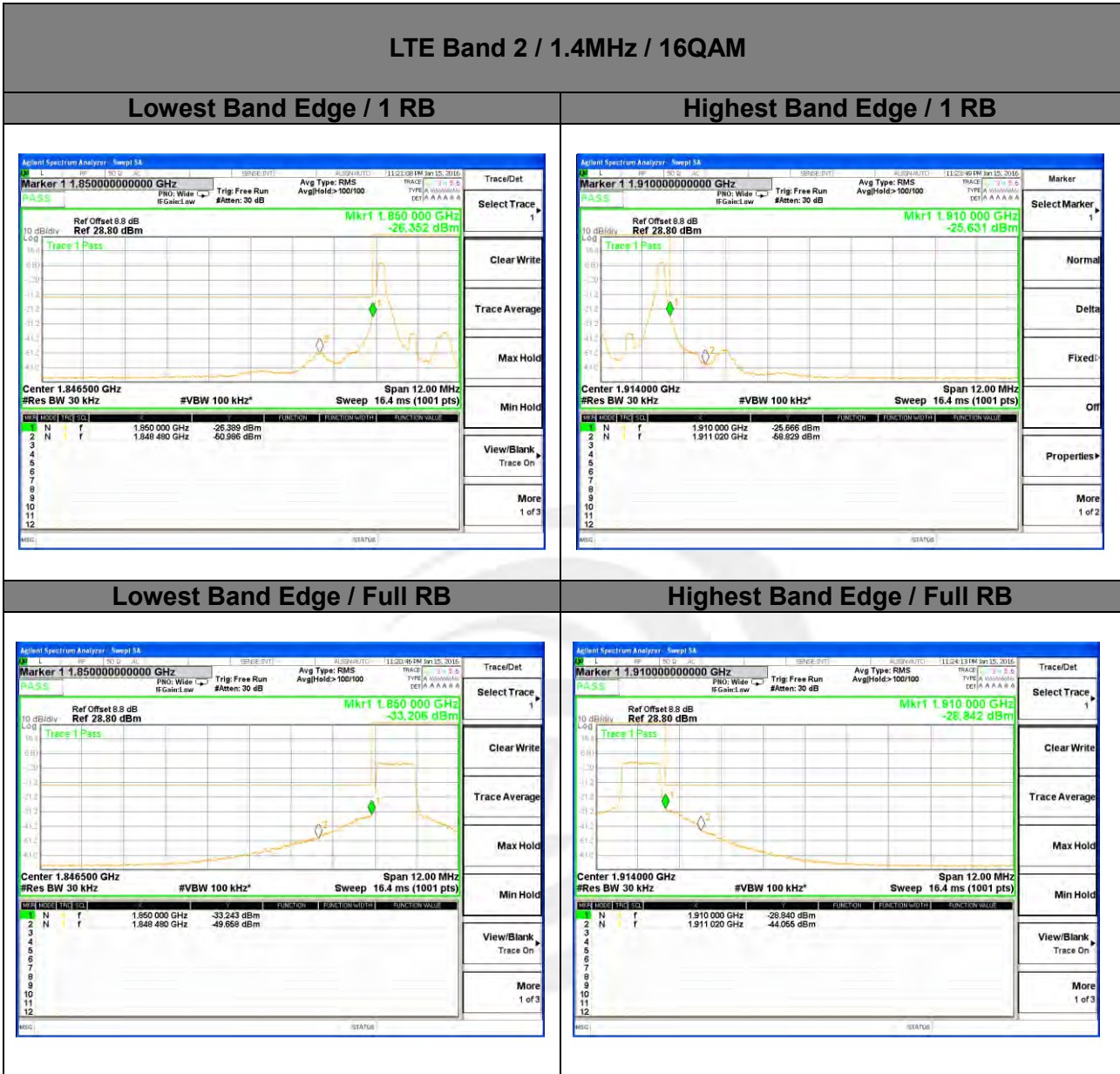



LTE band 2

LTE Band 2 / 3MHz / QPSK

Lowest Band Edge / 1 RB

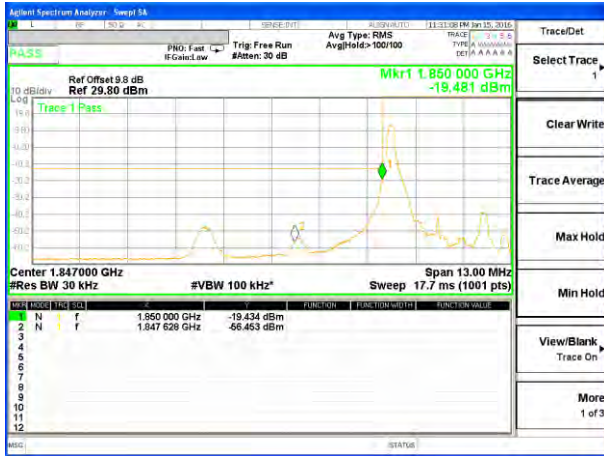

Highest Band Edge / 1 RB

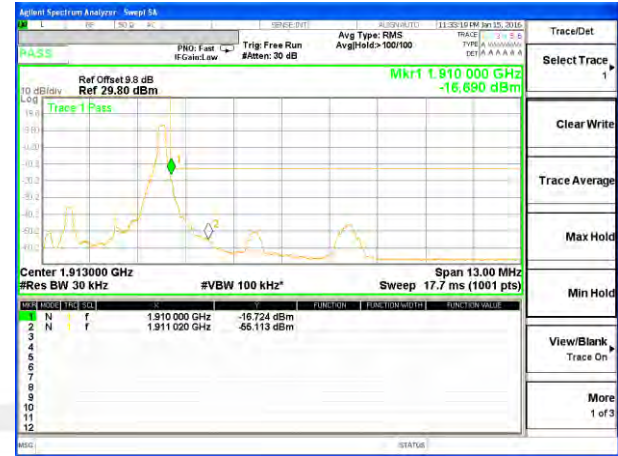

Lowest Band Edge / Full RB



Highest Band Edge / Full RB

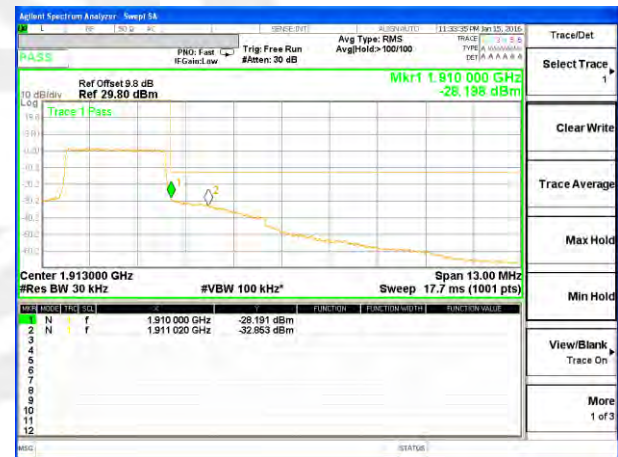





LTE band 2

LTE Band 2 / 3MHz / 16QAM

Lowest Band Edge / 1 RB

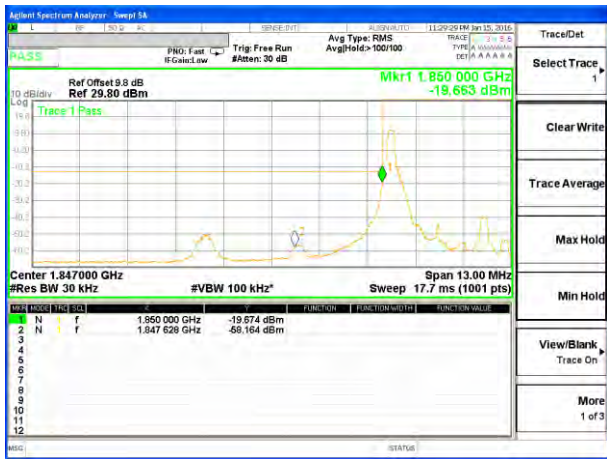

Highest Band Edge / 1 RB



Lowest Band Edge / Full RB

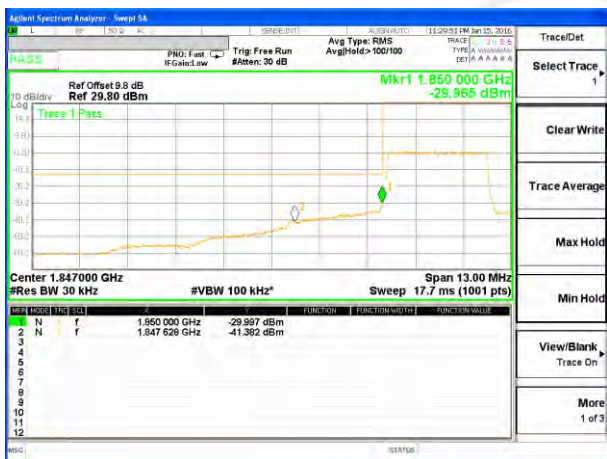

Highest Band Edge / Full RB





LTE band 2

LTE Band 2 / 5MHz / QPSK





LTE band 2

LTE Band 2 / 5MHz / 16QAM

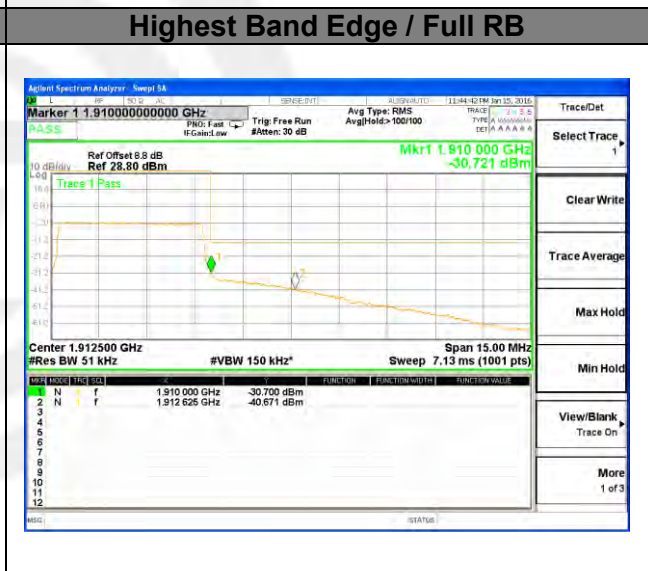
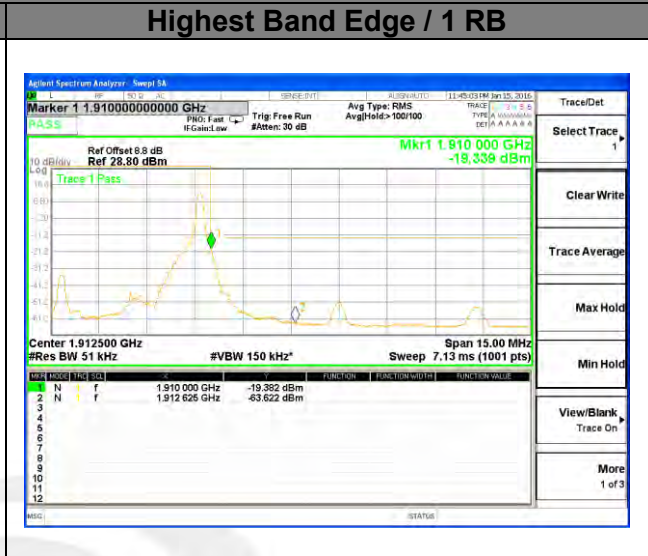
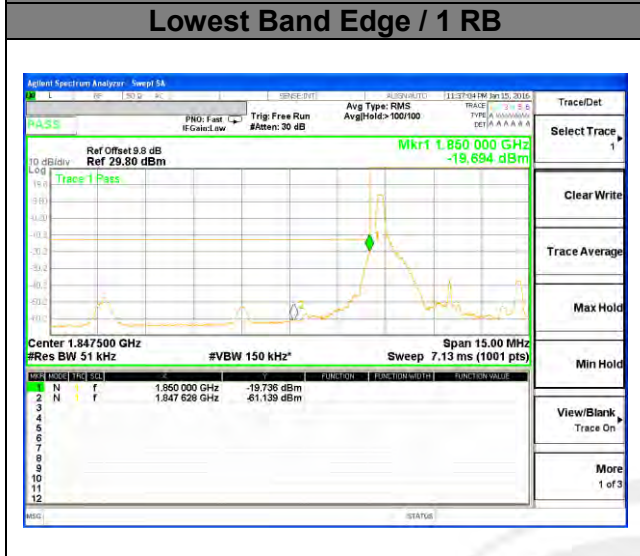



LTE band 2





LTE band 2

LTE Band 2 / 10MHz /16QAM

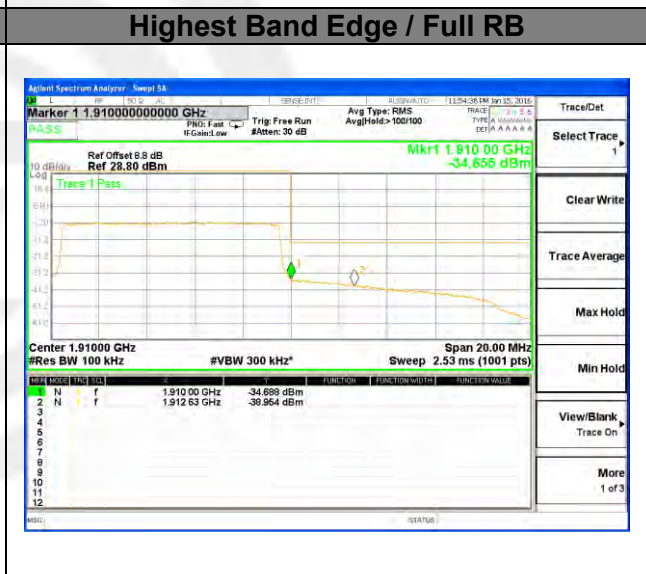
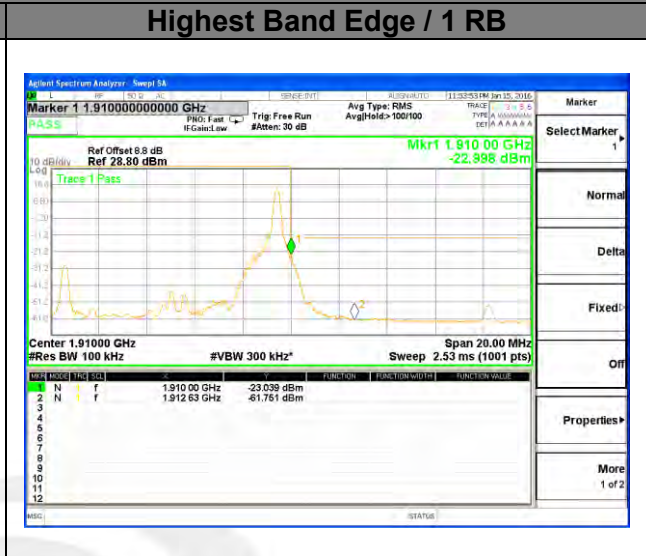
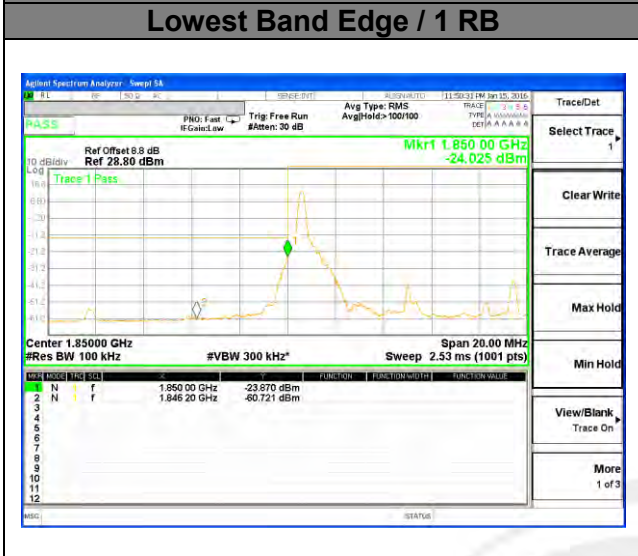



LTE band 2

LTE Band 2 / 15MHz /QPSK

Lowest Band Edge / 1 RB

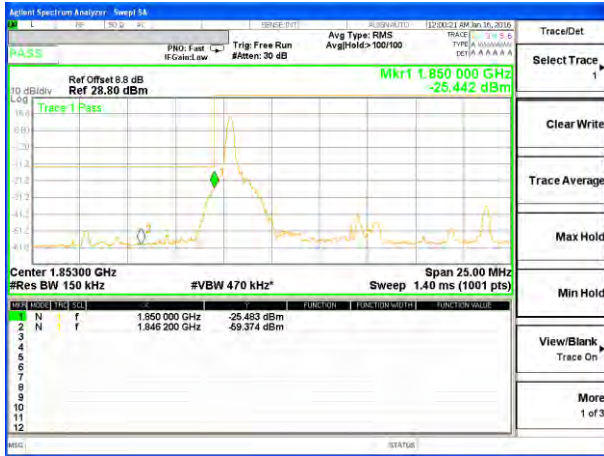

Highest Band Edge / 1 RB

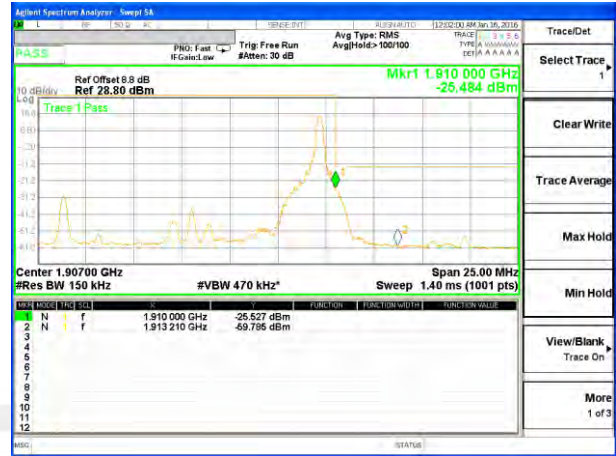

Lowest Band Edge / Full RB



Highest Band Edge / Full RB





LTE band 2

LTE Band 2 / 15MHz /16QAM

Lowest Band Edge / 1 RB

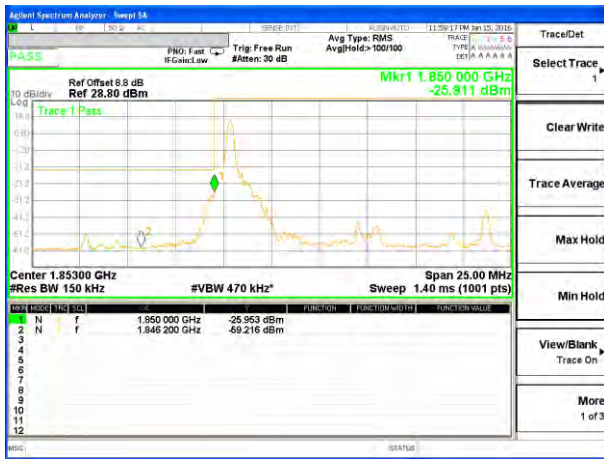

Highest Band Edge / 1 RB

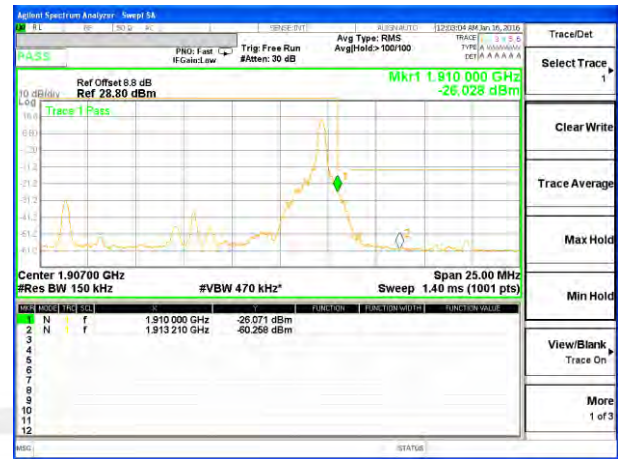

Lowest Band Edge / Full RB



Highest Band Edge / Full RB

