



MET Laboratories, Inc. *Safety Certification - EMI - Telecom Environmental Simulation*

914 WEST PATAPSCO AVENUE • BALTIMORE, MARYLAND 21230-3432 • PHONE (410) 354-3300 • FAX (410) 354-3313

33439 WESTERN AVENUE • UNION CITY, CALIFORNIA 94587 • PHONE (510) 489-6300 • FAX (510) 489-6372

3162 BELICK STREET • SANTA CLARA, CA 95054 • PHONE (408) 748-3585 • FAX (510) 489-6372

13301 MCCALLEN PASS • AUSTIN, TEXAS 78753 • PHONE (512) 287-2500 • FAX (512) 287-2513

March 6, 2014

Vuzix Corporation
2166 Brighton Henrietta Town Line Road
Rochester, NY 14623

Dear Shane Porzio,

Enclosed is the EMC Wireless test report for compliance testing of the Vuzix Corporation, Vuzix Smart Glasses, Model M100 as tested to the requirements of Title 47 of the CFR, Ch. 1 (10-1-06 ed.), Part 15 Subpart C and RSS-210, Issue 8, Dec. 2010 for Intentional Radiators.

Thank you for using the services of MET Laboratories, Inc. If you have any questions regarding these results or if MET can be of further service to you, please feel free to contact me.

Sincerely yours,
MET LABORATORIES, INC.

Jennifer Warnell
Documentation Department

Reference: (\\Vuzix Corporation\EMC40131B-FCC247 Rev. 1)

Certificates and reports shall not be reproduced except in full, without the written permission of MET Laboratories, Inc.

Electromagnetic Compatibility Criteria Test Report

for the

**Vuzix Corporation
Vuzix Smart Glasses, Model M100**

Tested under
the FCC Certification Rules
contained in
15.247 Subpart C & RSS-210, Issue 8, Dec. 2010
for Intentional Radiators

MET Report: EMC40131B-FCC247 Rev. 1

March 6, 2014

Prepared For:

**Vuzix Corporation
2166 Brighton Henrietta Town Line Road
Rochester, NY 14623**

Prepared By:
MET Laboratories, Inc.
914 W. Patapsco Ave.
Baltimore, MD 21230

Electromagnetic Compatibility Criteria Test Report

for the

Vuzix Corporation Vuzix Smart Glasses, Model M100

Tested under
the FCC Certification Rules
contained in
15.247 Subpart C & RSS-210, Issue 8, Dec. 2010
for Intentional Radiators



Surinder Singh, Project Engineer
Electromagnetic Compatibility Lab



Jennifer Warnell
Documentation Department

Engineering Statement: The measurements shown in this report were made in accordance with the procedures indicated, and the emissions from this equipment were found to be within the limits applicable. I assume full responsibility for the accuracy and completeness of these measurements, and for the qualifications of all persons taking them. It is further stated that upon the basis of the measurements made, the equipment tested is capable of operation in accordance with the requirements of the FCC Rules Parts 15.247 and Industry Canada standards RSS-210, Issue 8, Dec. 2010 under normal use and maintenance.



Asad Bajwa,
Director, Electromagnetic Compatibility Lab

Report Status Sheet

Revision	Report Date	Reason for Revision
∅	January 6, 2014	Initial Issue.
1	March 6, 2014	Revised to reflect engineer corrections.

Table of Contents

I.	Executive Summary	1
	A. Purpose of Test	2
	B. Executive Summary	2
II.	Equipment Configuration	3
	A. Overview.....	4
	B. References.....	5
	C. Test Site	5
	D. Description of Test Sample.....	6
	E. Equipment Configuration.....	6
	F. Support Equipment	7
	G. Ports and Cabling Information.....	7
	H. Mode of Operation.....	7
	I. Method of Monitoring EUT Operation	7
	J. Modifications	7
	a) Modifications to EUT.....	7
	b) Modifications to Test Standard.....	7
	K. Disposition of EUT	7
III.	Electromagnetic Compatibility Criteria for Intentional Radiators.....	8
	§ 15.203 Antenna Requirement.....	9
	§ 15.207(a) Conducted Emissions Limits.....	10
	§ 15.247(a)(1) 20 dB Occupied Bandwidth.....	24
	§ 15.247(a)(1) Average Time of Occupancy (Dwell Time)	33
	§ 15.247(a)(1) Number of RF Channels	40
	§ 15.247(a)(1) RF Channel Separation	43
	§ 15.247(b) Peak Power Output	45
	§ 15.247(d) Radiated Spurious Emissions Requirements and Band Edge.....	50
	§ 15.247(d) RF Conducted Spurious Emissions Requirements and Band Edge.....	67
IV.	Test Equipment	80
V.	Certification & User’s Manual Information	82
	A. Certification Information	83
	B. Label and User’s Manual Information	87
VI.	ICES-003 Procedural & Labeling Requirements.....	89

List of Tables

Table 1. Executive Summary of EMC Part 15.247 Compliance Testing	2
Table 2. EUT Summary Table.....	4
Table 3. References	5
Table 4. Equipment Configuration	6
Table 5. Support Equipment.....	7
Table 6. Ports and Cabling Information	7
Table 7. Antenna List	9
Table 8. Conducted Limits for Intentional Radiators from FCC Part 15 § 15.207(a)	10
Table 9. Conducted Emissions, 15.207(a), Test Results	11
Table 10. 20 dB Occupied Bandwidth, 8DPSK	25
Table 11. 20 dB Occupied Bandwidth, GFSK	25
Table 12. 20 dB Occupied Bandwidth, $\pi/4$ DQPSK	25
Table 13. 99% Bandwidth, 8DPSK	26
Table 14. 99% Bandwidth, GFSK	26
Table 15. 99% Bandwidth, $\pi/4$ DQPSK	26
Table 16. Average Time of Occupancy	33
Table 17. Peak Power Output, 8DPSK	46
Table 18. Peak Power Output, GFSK	46
Table 19. Peak Power Output, $\pi/4$ DQPSK	46
Table 20. Restricted Bands of Operation.....	50
Table 21. Radiated Emissions Limits Calculated from FCC Part 15, § 15.209 (a)	51
Table 22. Test Equipment List	81

List of Plots

Plot 1. Conducted Emissions, 15.207(a), Phase DHI Hopping, 8DPSK Modulation	12
Plot 2. Conducted Emissions, 15.207(a), Phase, Low Channel, 8DPSK Modulation	12
Plot 3. Conducted Emissions, 15.207(a), Phase, Mid Channel, 8DPSK Modulation	13
Plot 4. Conducted Emissions, 15.207(a), Phase, High Channel, 8DPSK Modulation	13
Plot 5. Conducted Emissions, 15.207(a), Phase DHI Hopping, GFSK Modulation	14
Plot 6. Conducted Emissions, 15.207(a), Phase, Low Channel, GFSK Modulation	14
Plot 7. Conducted Emissions, 15.207(a), Phase, Mid Channel, GFSK Modulation	15
Plot 8. Conducted Emissions, 15.207(a), Phase, High Channel, GFSK Modulation	15
Plot 9. Conducted Emissions, 15.207(a), Phase DHI Hopping, $\pi/4$ DQPSK Modulation	16
Plot 10. Conducted Emissions, 15.207(a), Phase, Low Channel, $\pi/4$ DQPSK Modulation	16
Plot 11. Conducted Emissions, 15.207(a), Phase, Mid Channel, $\pi/4$ DQPSK Modulation	17
Plot 12. Conducted Emissions, 15.207(a), Phase, High Channel, $\pi/4$ DQPSK Modulation	17
Plot 13. Conducted Emissions, 15.207(a), Neutral DHI Hopping, 8DPSK Modulation	18
Plot 14. Conducted Emissions, 15.207(a), Neutral, Low Channel, 8DPSK Modulation	18
Plot 15. Conducted Emissions, 15.207(a), Neutral, Mid Channel, 8DPSK Modulation	19
Plot 16. Conducted Emissions, 15.207(a), Neutral, High Channel, 8DPSK Modulation	19
Plot 17. Conducted Emissions, 15.207(a), Neutral DHI Hopping, GFSK Modulation	20
Plot 18. Conducted Emissions, 15.207(a), Neutral, Low Channel, GFSK Modulation	20
Plot 19. Conducted Emissions, 15.207(a), Neutral, Mid Channel, GFSK Modulation	21
Plot 20. Conducted Emissions, 15.207(a), Neutral, High Channel, GFSK Modulation	21
Plot 21. Conducted Emissions, 15.207(a), Neutral DHI Hopping, $\pi/4$ DQPSK Modulation	22
Plot 22. Conducted Emissions, 15.207(a), Neutral, Low Channel, $\pi/4$ DQPSK Modulation	22
Plot 23. Conducted Emissions, 15.207(a), Neutral, Mid Channel, $\pi/4$ DQPSK Modulation	23
Plot 24. Conducted Emissions, 15.207(a), Neutral, High Channel, $\pi/4$ DQPSK Modulation	23
Plot 25. 20 dB Occupied Bandwidth, Low Channel, 8DPSK	27

Plot 26. 20 dB Occupied Bandwidth, Mid Channel, 8DPSK	27
Plot 27. 20 dB Occupied Bandwidth, High Channel, 8DPSK	27
Plot 28. 20 dB Occupied Bandwidth, Low Channel, GFSK	28
Plot 29. 20 dB Occupied Bandwidth, Mid Channel, GFSK	28
Plot 30. 20 dB Occupied Bandwidth, High Channel, GFSK	28
Plot 31. 20 dB Occupied Bandwidth, Low Channel, Pi by 4 DQPSK	29
Plot 32. 20 dB Occupied Bandwidth, Mid Channel, Pi by 4 DQPSK	29
Plot 33. 20 dB Occupied Bandwidth, High Channel, Pi by 4 DQPSK	29
Plot 34. 99% Occupied Bandwidth, Low Channel, 8DPSK	30
Plot 35. 99% Occupied Bandwidth, Mid Channel, 8DPSK	30
Plot 36. 99% Occupied Bandwidth, High Channel, 8DPSK	30
Plot 37. 99% Occupied Bandwidth, Low Channel, GFSK	31
Plot 38. 99% Occupied Bandwidth, Mid Channel, GFSK	31
Plot 39. 99% Occupied Bandwidth, High Channel, GFSK	31
Plot 40. 99% Occupied Bandwidth, Low Channel, Pi by 4 DQPSK	32
Plot 41. 99% Occupied Bandwidth, Mid Channel, Pi by 4 DQPSK	32
Plot 42. 99% Occupied Bandwidth, High Channel, Pi by 4 DQPSK	32
Plot 43. Dwell Time, Pulse Width, 8DPSK, DH1	34
Plot 44. Dwell Time, Pulse Width, 8DPSK, DH3	34
Plot 45. Dwell Time, Pulse Width, 8DPSK, DH5	34
Plot 46. Dwell Time, Pulse Width, GFSK, DH1	35
Plot 47. Dwell Time, Pulse Width, GFSK, DH3	35
Plot 48. Dwell Time, Pulse Width, GFSK, DH5	35
Plot 49. Dwell Time, Pulse Width, Pi by 4 DQPSK, DH1	36
Plot 50. Dwell Time, Pulse Width, Pi by 4 DQPSK, DH3	36
Plot 51. Dwell Time, Pulse Width, Pi by 4 DQPSK, DH5	36
Plot 52. Number of Pulses, 8DPSK, DH1	37
Plot 53. Number of Pulses, 8DPSK, DH3	37
Plot 54. Number of Pulses, 8DPSK, DH5	37
Plot 55. Number of Pulses, GFSK, DH1	38
Plot 56. Number of Pulses, GFSK, DH3	38
Plot 57. Number of Pulses, GFSK, DH5	38
Plot 58. Number of Pulses, Pi by 4 DQPSK, DH1	39
Plot 59. Number of Pulses, Pi by 4 DQPSK, DH3	39
Plot 60. Number of Pulses, Pi by 4 DQPSK, DH5	39
Plot 61. Number of Channels, 8DQPSK, 2400 MHz – 2437 MHz	40
Plot 62. Number of Channels, 8DQPSK, 2437 MHz – 2483.5 MHz	40
Plot 63. Number of Channels, GFSK, 2400 MHz – 2437 MHz	41
Plot 64. Number of Channels, GFSK, 2437 MHz – 2483.5 MHz	41
Plot 65. Number of Channels, Pi by 4 DQPSK, 2400 MHz – 2437 MHz	42
Plot 66. Number of Channels, Pi by 4 DQPSK, 2437 MHz – 2483.5 MHz	42
Plot 67. Channel Separation, 8DPSK	43
Plot 68. Channel Separation, GFSK	44
Plot 69. Channel Separation, Pi by 4 DQPSK	44
Plot 70. Peak Power Output, Low Channel, 8DPSK	47
Plot 71. Peak Power Output, Mid Channel, 8DPSK	47
Plot 72. Peak Power Output, High Channel, 8DPSK	47
Plot 73. Peak Power Output, Low Channel, GFSK	48
Plot 74. Peak Power Output, Mid Channel, GFSK	48
Plot 75. Peak Power Output, High Channel, GFSK	48
Plot 76. Peak Power Output, Low Channel, Pi by 4 DQPSK	49
Plot 77. Peak Power Output, Mid Channel, Pi by 4 DQPSK	49
Plot 78. Peak Power Output, High Channel, Pi by 4 DQPSK	49

Plot 79. Radiated Spurious Emissions, DH1, Hopping Channel, 8DPSK, 30 MHz – 1 GHz	52
Plot 80. Radiated Spurious Emissions, DH1, Hopping Channel, 8DPSK, 1 GHz – 18 GHz	52
Plot 81. Radiated Spurious Emissions, Low Channel, 8DPSK, 30 MHz – 1 GHz	53
Plot 82. Radiated Spurious Emissions, Low Channel, 8DPSK, 1 GHz – 18 GHz	53
Plot 83. Radiated Spurious Emissions, Mid Channel, 8DPSK, 30 MHz – 1 GHz	54
Plot 84. Radiated Spurious Emissions, Mid Channel, 8DPSK, 1 GHz – 18 GHz	54
Plot 85. Radiated Spurious Emissions, Mid Channel, 8DPSK, 9.764 GHz	54
Plot 86. Radiated Spurious Emissions, High Channel, 8DPSK, 30 MHz – 1 GHz	55
Plot 87. Radiated Spurious Emissions, High Channel, 8DPSK, 1 GHz – 18 GHz	55
Plot 88. Radiated Spurious Emissions, High Channel, 8DPSK, 9.92 GHz	55
Plot 89. Radiated Spurious Emissions, DH1, Hopping Channel, GFSK, 30 MHz – 1 GHz	56
Plot 90. Radiated Spurious Emissions, DH1, Hopping Channel, GFSK, 1 GHz – 18 GHz	56
Plot 91. Radiated Spurious Emissions, Low Channel, GFSK, 30 MHz – 1 GHz	57
Plot 92. Radiated Spurious Emissions, Low Channel, GFSK, 1 GHz – 18 GHz	57
Plot 93. Radiated Spurious Emissions, Low Channel, GFSK, 1.852 GHz	57
Plot 94. Radiated Spurious Emissions, Mid Channel, GFSK, 30 MHz – 1 GHz	58
Plot 95. Radiated Spurious Emissions, Mid Channel, GFSK, 1 GHz – 18 GHz	58
Plot 96. Radiated Spurious Emissions, Mid Channel, GFSK, 9.764 GHz	58
Plot 97. Radiated Spurious Emissions, High Channel, GFSK, 30 MHz – 1 GHz	59
Plot 98. Radiated Spurious Emissions, High Channel, GFSK, 1 GHz – 18 GHz	59
Plot 99. Radiated Spurious Emissions, High Channel, GFSK, 9.92 GHz	59
Plot 100. Radiated Spurious Emissions, DH1, Hopping Channel, Pi by 4 DQPSK, 30 MHz – 1 GHz	60
Plot 101. Radiated Spurious Emissions, DH1, Hopping Channel, Pi by 4 DQPSK, 1 GHz – 18 GHz	60
Plot 102. Radiated Spurious Emissions, Low Channel, Pi by 4 DQPSK, 30 MHz – 1 GHz	61
Plot 103. Radiated Spurious Emissions, Low Channel, Pi by 4 DQPSK, 1 GHz – 18 GHz	61
Plot 104. Radiated Spurious Emissions, Mid Channel, Pi by 4 DQPSK, 30 MHz – 1 GHz	62
Plot 105. Radiated Spurious Emissions, Mid Channel, Pi by 4 DQPSK, 1 GHz – 18 GHz	62
Plot 106. Radiated Spurious Emissions, Mid Channel, Pi by 4 DQPSK, 9.764 GHz	62
Plot 107. Radiated Spurious Emissions, High Channel, Pi by 4 DQPSK, 30 MHz – 1 GHz	63
Plot 108. Radiated Spurious Emissions, High Channel, Pi by 4 DQPSK, 1 GHz – 18 GHz	63
Plot 109. Radiated Spurious Emissions, High Channel, Pi by 4 DQPSK, 9.92 GHz	63
Plot 110. Radiated Restricted Band Edge, Low Channel, 8DPSK	64
Plot 111. Radiated Restricted Band Edge, High Channel, 8DPSK	64
Plot 112. Radiated Restricted Band Edge, Low Channel, GFSK	65
Plot 113. Radiated Restricted Band Edge, High Channel, GFSK	65
Plot 114. Radiated Restricted Band Edge, Low Channel, Pi by 4 DQPSK	66
Plot 115. Radiated Restricted Band Edge, High Channel, Pi by 4 DQPSK	66
Plot 116. Conducted Spurious Emissions, 8DPSK, 30 MHz – 25 GHz, Hopping Mode	68
Plot 117. Conducted Spurious Emissions, 8DPSK, 30 MHz – 25 GHz, Low Channel	68
Plot 118. Conducted Spurious Emissions, 8DPSK, 30 MHz – 25 GHz, Mid Channel	69
Plot 119. Conducted Spurious Emissions, 8DPSK, 30 MHz – 25 GHz, High Channel	69
Plot 120. Conducted Spurious Emissions, GFSK, 30 MHz – 25 GHz, Hopping Mode	70
Plot 121. Conducted Spurious Emissions, GFSK, 30 MHz – 25 GHz, Low Channel	70
Plot 122. Conducted Spurious Emissions, GFSK, 30 MHz – 25 GHz, Mid Channel	71
Plot 123. Conducted Spurious Emissions, GFSK, 30 MHz – 25 GHz, High Channel	71
Plot 124. Conducted Spurious Emissions, Pi by 4 DQPSK, 30 MHz – 25 GHz, Hopping Mode	72
Plot 125. Conducted Spurious Emissions, Pi by 4 DQPSK, 30 MHz – 25 GHz, Low Channel	72
Plot 126. Conducted Spurious Emissions, Pi by 4 DQPSK, 30 MHz – 25 GHz, Mid Channel	73
Plot 127. Conducted Spurious Emissions, Pi by 4 DQPSK, 30 MHz – 25 GHz, High Channel	73
Plot 128. Conducted Band Edge, Low Channel, 8DPSK, Hopping Mode	74
Plot 129. Conducted Band Edge, High Channel, 8DPSK, Hopping Mode	74
Plot 130. Conducted Band Edge, Low Channel, 8DPSK	75
Plot 131. Conducted Band Edge, High Channel, 8DPSK	75

Plot 132. Conducted Band Edge, Low Channel, GFSK, Hopping Mode	76
Plot 133. Conducted Band Edge, High Channel, GFSK, Hopping Mode	76
Plot 134. Conducted Band Edge, Low Channel, GFSK	77
Plot 135. Conducted Band Edge, High Channel, GFSK	77
Plot 136. Conducted Band Edge, Low Channel, Pi by 4 DQPSK, Hopping Mode	78
Plot 137. Conducted Band Edge, High Channel, Pi by 4 DQPSK, Hopping Mode	78
Plot 138. Conducted Band Edge, Low Channel, Pi by 4 DQPSK	79
Plot 139. Conducted Band Edge, High Channel, Pi by 4 DQPSK	79

List of Figures

Figure 1. Block Diagram of Test Configuration.....	6
Figure 2. Block Diagram, Occupied Bandwidth Test Setup.....	24
Figure 3. Peak Power Output Test Setup.....	45
Figure 4. Block Diagram, Conducted Spurious Emissions Test Setup.....	67

List of Terms and Abbreviations

AC	Alternating Current
ACF	Antenna Correction Factor
Cal	Calibration
<i>d</i>	Measurement Distance
dB	Decibels
dB μ A	Decibels above one microamp
dB μ V	Decibels above one microvolt
dB μ A/m	Decibels above one microamp per meter
dB μ V/m	Decibels above one microvolt per meter
DC	Direct Current
E	Electric Field
DSL	Digital Subscriber Line
ESD	Electrostatic Discharge
EUT	Equipment Under Test
<i>f</i>	Frequency
FCC	Federal Communications Commission
GRP	Ground Reference Plane
H	Magnetic Field
HCP	Horizontal Coupling Plane
Hz	Hertz
IEC	International Electrotechnical Commission
kHz	kilohertz
kPa	kilopascal
kV	kilovolt
LISN	Line Impedance Stabilization Network
MHz	Megahertz
μ H	microhenry
μ	microfarad
μ s	microseconds
NEBS	Network Equipment-Building System
PRF	Pulse Repetition Frequency
RF	Radio Frequency
RMS	Root-Mean-Square
TWT	Traveling Wave Tube
V/m	Volts per meter
VCP	Vertical Coupling Plane

I. Executive Summary

A. Purpose of Test

An EMC evaluation was performed to determine compliance of the Vuzix Corporation Vuzix Smart Glasses, Model M100, with the requirements of Part 15, §15.247. All references are to the most current version of Title 47 of the Code of Federal Regulations in effect. In accordance with §2.1033, the following data is presented in support of the Certification of the Vuzix Smart Glasses, Model M100. Vuzix Corporation should retain a copy of this document which should be kept on file for at least two years after the manufacturing of the Vuzix Smart Glasses, Model M100, has been **permanently** discontinued.

B. Executive Summary

The following tests were conducted on a sample of the equipment for the purpose of demonstrating compliance with Part 15, §15.247, in accordance with Vuzix Corporation, purchase order number 505201. All tests were conducted using measurement procedure ANSI C63.4-2003.

FCC Reference 47 CFR Part 15.247:2005	IC Reference RSS-210 Issue 8: 2010; RSS-GEN Issues 3: 2010	Description	Compliance
Title 47 of the CFR, Part 15 §15.203	N/A	Antenna Requirement	Compliant
Title 47 of the CFR, Part 15 §15.207(a)	RSS-GEN (7.2.4)	Conducted Emission Limits	Compliant
Title 47 of the CFR, Part 15 §15.247(a)(1)	RSS-Gen(4.6)	20 dB Occupied Bandwidth	Compliant
		99% Occupied Bandwidth	Compliant
Title 47 of the CFR, Part 15 §15.247(a)(1)	RSS-210(A8.1)	Average Time of Occupancy (Dwell Time)	Compliant
Title 47 of the CFR, Part 15 §15.247(a)(1)	RSS-210(A8.1)	Number of RF Channels	Compliant
Title 47 of the CFR, Part 15 §15.247(a)(1)	RSS-210(A8.1)	RF Channel Separation	Compliant
Title 47 of the CFR, Part 15 §15.247(b)	RSS-210(A8.4)	Peak Power Output	Compliant
Title 47 of the CFR, Part 15 §15.247(d); §15.209; §15.205	RSS-210(A8.5)	Radiated Spurious Emissions	Compliant
Title 47 of the CFR, Part 15 §15.247(d)	RSS-210(A8.5)	Spurious Conducted Emissions	Compliant
Title 47 of the CFR, Part 15 §15.247(g) & (h)	RSS-210(A8.1)	Declaration Statements for FHSS	Compliant per customer declaration

Table 1. Executive Summary of EMC Part 15.247 Compliance Testing

II. Equipment Configuration

A. Overview

MET Laboratories, Inc. was contracted by Vuzix Corporation to perform testing on the Vuzix Smart Glasses, Model M100, under Vuzix Corporation's purchase order number 505201.

This document describes the test setups, test methods, required test equipment, and the test limit criteria used to perform compliance testing of the Vuzix Corporation, Vuzix Smart Glasses, Model M100.

The results obtained relate only to the item(s) tested.

Model(s) Tested:	Vuzix Smart Glasses, Model M100	
Model(s) Covered:	Vuzix Smart Glasses, Model M100	
EUT Specifications:	Primary Power: 120 VAC, 60 Hz	
	FCC ID: 2AA9D-425 IC: 11503A-425	
	Equipment Code:	DSS
	Peak RF Output Power:	9.577dBm
	EUT Frequency Ranges:	2402-2480MHz
Analysis:	The results obtained relate only to the item(s) tested.	
Environmental Test Conditions:	Temperature: 15-35° C	
	Relative Humidity: 30-60%	
	Barometric Pressure: 860-1060 mbar	
Evaluated by:	Surinder Singh	
Report Date(s):	March 6, 2014	

Table 2. EUT Summary Table

B. References

CFR 47, Part 15, Subpart C	Federal Communication Commission, Code of Federal Regulations, Title 47, Part 15: General Rules and Regulations, Allocation, Assignment, and Use of Radio Frequencies
RSS-210, Issue 8, Dec. 2010	Low-power Licence-exempt Radiocommunications Devices (All Frequency Bands): Category I Equipment
RSS-GEN, Issue 3, Dec. 2010	General Requirements and Information for the Certification of Radio Apparatus
ANSI C63.4:2003	Methods and Measurements of Radio-Noise Emissions from Low-Voltage Electrical And Electronic Equipment in the Range of 9 kHz to 40 GHz
ISO/IEC 17025:2005	General Requirements for the Competence of Testing and Calibration Laboratories
ANSI C63.10-2009	American National Standard for Testing Unlicensed Wireless Devices

Table 3. References

C. Test Site

All testing was performed at MET Laboratories, Inc., 914 W. Patapsco Ave., Baltimore, MD 21230. All equipment used in making physical determinations is accurate and bears recent traceability to the National Institute of Standards and Technology.

Radiated Emissions measurements were performed in a 3 meter semi-anechoic chamber (equivalent to an Open Area Test Site). In accordance with §2.948(a)(3), a complete site description is contained at MET Laboratories.

D. Description of Test Sample

The Vuzix Corporation Vuzix Smart Glasses, Model M100, Equipment Under Test (EUT), is a smart wearable display that allows users to perform many of the jobs of a cell phone hands free as well as many stand-alone Augmented Reality applications.

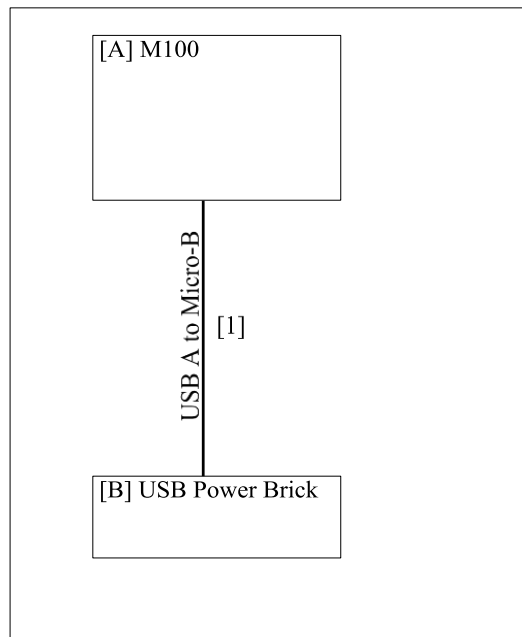

Figure 1. Block Diagram of Test Configuration

E. Equipment Configuration

The EUT was set up as outlined in Figure 1, Block Diagram of Test Setup. All cards, racks, etc., incorporated as part of the EUT is included in the following list.

Ref. ID	Slot #	Name / Description	Model Number	Part Number	Rev. #
A	1	Smart Glasses	M100	425T0P011	1

Table 4. Equipment Configuration

F. Support Equipment

Support equipment necessary for the operation and testing of the EUT is included in the following list.

Ref. ID	Name / Description	Manufacturer	Model Number
B	USB Power Brick	--	--

Table 5. Support Equipment

G. Ports and Cabling Information

Ref. ID	Port Name on EUT	Cable Description	Qty.	Length (m)	Shielded (Y/N)	Termination Point
1	USB	USB A to Micro-B	1	2	Yes	B.USB

Table 6. Ports and Cabling Information

H. Mode of Operation

Non-Wireless Test Mode: The M100 will operate all of its non-wireless peripheral functions including: camera capture, accelerometer, gyroscope, magnetometer, and proximity sensor polling, battery charging, video display, audio playback, audio capture via a test application that once started will operate indefinitely.

Bluetooth Test Mode: The M100 will be configurable to continuously transmit in either normal mode or hop mode via a test application.

WiFi Test Mode: The M100 will be configurable to continuously transmit with modulation applied with the ability to change channels as well as changing between B, G, and N modes via a test application.

I. Method of Monitoring EUT Operation

1. The unit will continue to display the camera feed and show the sensor readouts in the display.
2. Any other condition or sensor readout saying FAIL.

J. Modifications

- a) **Modifications to EUT**
No modifications were made to the EUT.
- b) **Modifications to Test Standard**
No modifications were made to the test standard.

K. Disposition of EUT

The test sample including all support equipment submitted to the Electro-Magnetic Compatibility Lab for testing was returned to Vuzix Corporation upon completion of testing.

III. Electromagnetic Compatibility Criteria for Intentional Radiators

Electromagnetic Compatibility Criteria for Intentional Radiators

§ 15.203 Antenna Requirement

Test Requirement: § 15.203: An intentional radiator shall be designed to ensure that no antenna other than that furnished by the responsible party shall be used with the device. The use of a permanently attached antenna or of an antenna that uses a unique coupling to the intentional radiator shall be considered sufficient to comply with the provisions of this section. The manufacturer may design the unit so that a broken antenna can be replaced by the user, but the use of a standard antenna jack or electrical connector is prohibited.

The structure and application of the EUT were analyzed to determine compliance with Section 15.203 of the Rules. Section 15.203 states that the subject device must meet at least one of the following criteria:

- a.) Antenna must be permanently attached to the unit.
- b.) Antenna must use a unique type of connector to attach to the EUT.
- c.) Unit must be professionally installed. Installer shall be responsible for verifying that the correct antenna is employed with the unit.

Results: The EUT as tested is not applicable to the criteria of §15.203. The EUT has integral antenna.

Test Engineer(s): Surinder Singh

Test Date(s): 11/26/2013

Gain (dBi)	Type
0	Ceramic Multilayer Chip Antenna

Table 7. Antenna List

Electromagnetic Compatibility Criteria for Intentional Radiators

§ 15.207(a) Conducted Emissions Limits

Test Requirement(s): § 15.207 (a): For an intentional radiator that is designed to be connected to the public utility (AC) power line, the radio frequency voltage that is conducted back onto the AC power line on any frequency or frequencies, within the band 150 kHz to 30MHz, shall not exceed the limits in the following table, as measured using a 50 μ H/50 Σ line impedance stabilization network (LISN). Compliance with the provisions of this paragraph shall be based on the measurement of the radio frequency voltage between each power line and ground at the power terminal. The lower limit applies at the boundary between the frequency ranges.

Frequency range (MHz)	§ 15.207(a), Conducted Limit (dB μ V)	
	Quasi-Peak	Average
* 0.15- 0.45	66 - 56	56 - 46
0.45 - 0.5	56	46
0.5 - 30	60	50

Table 8. Conducted Limits for Intentional Radiators from FCC Part 15 § 15.207(a)

Test Procedure: The EUT was placed on a 0.8 m-high wooden table inside a screen room. The EUT was situated such that the back of the EUT was 0.4 m from one wall of the vertical ground plane, and the remaining sides of the EUT were no closer than 0.8 m from any other conductive surface. The EUT was powered from a 50 Ω /50 μ H Line Impedance Stabilization Network (LISN). The EMC receiver scanned the frequency range from 150 kHz to 30 MHz. Conducted Emissions measurements were made in accordance with *ANSI C63.4-2003 "Methods and Measurements of Radio-Noise Emissions from Low-Voltage Electrical and Electronic Equipment in the Range of 9kHz to 40 GHz"*. The measurements were performed over the frequency range of 0.15 MHz to 30 MHz using a 50 Ω /50 μ H LISN as the input transducer to an EMC/field intensity meter. For the purpose of this testing, the transmitter was turned on. Scans were performed with the transmitter on.

Test Results: The EUT was compliant with this requirement. Measured emissions were below applicable limits.

Test Engineer(s): Surinder Singh

Test Date(s): 11/26/13

15.207(a) Conducted Emissions Test Results

FHSS								
Quasi Peak and Average measurement for data point that were failing during Pre-scan of Conducted Emission Test								
Line	Device Channel/Mode	Frequency (MHz)	Quasi Peak	Average Peak	Quasi Peak Limit	Average Peak Limit	Margin QP	Margin Avg
Phase	low ch 8DPSK	0.16	22.91	13.29	65.46	55.46	-42.55	-42.17
Phase	low ch Pi by 4 DQPSK	0.18	19.83	9.28	64.49	54.49	-44.66	-45.21
Phase	mid ch Pi by 4 DQPSK	0.18	20.92	11.46	64.49	54.49	-43.57	-43.03
Phase	mid ch GFSK	0.18	19.38	10.47	64.49	54.49	-45.11	-44.02
Neutral	high ch GFSK	0.18	18.37	10.45	64.49	54.49	-46.12	-44.04
Neutral	high ch GFSK	0.36	20.73	11.72	58.73	48.73	-38.00	-37.01
Neutral	high ch Pi by 4 DQPSK	0.17	23.87	10.94	64.96	54.96	-41.09	-44.02
Neutral	low ch 8DPSK	0.17	20.46	13.03	64.96	54.96	-44.5	-41.93
Neutral	low ch GFSK	0.16	17.32	7.31	65.46	55.46	-48.14	-48.15
Neutral	low ch Pi by 4 DQPSK	0.18	20.28	9.99	64.49	54.49	-44.21	-44.50
Neutral	mid 8DPSK	0.26	18.45	11.39	61.43	51.43	-42.98	-40.04
Neutral	mid ch Pi by 4 DQPSK	0.18	19.21	9.89	64.49	54.49	-45.28	-44.6
Neutral	mid ch Pi by 4 DQPSK	0.27	23.09	11.8	61.12	51.12	38.03	39.32
Neutral	mid ch Pi by 4 DQPSK	0.32	22.12	13.07	59.71	49.71	37.59	36.64
Neutral	mid ch Pi by 4 DQPSK	0.45	23.08	12.67	56.88	46.88	33.8	34.21

Table 9. Conducted Emissions, 15.207(a), Test Results

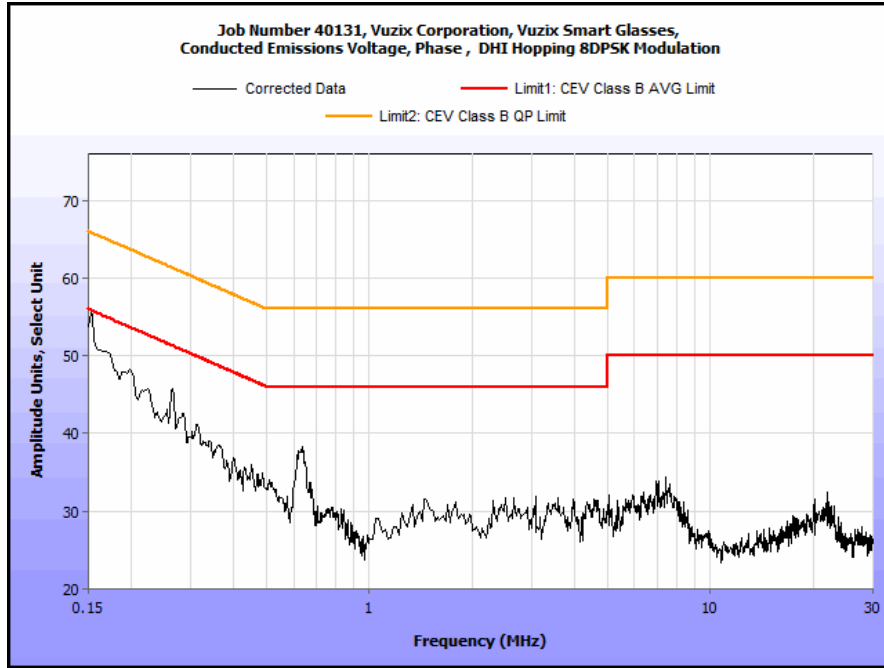

Plot 1. Conducted Emissions, 15.207(a), Phase DHI Hopping, 8DPSK Modulation

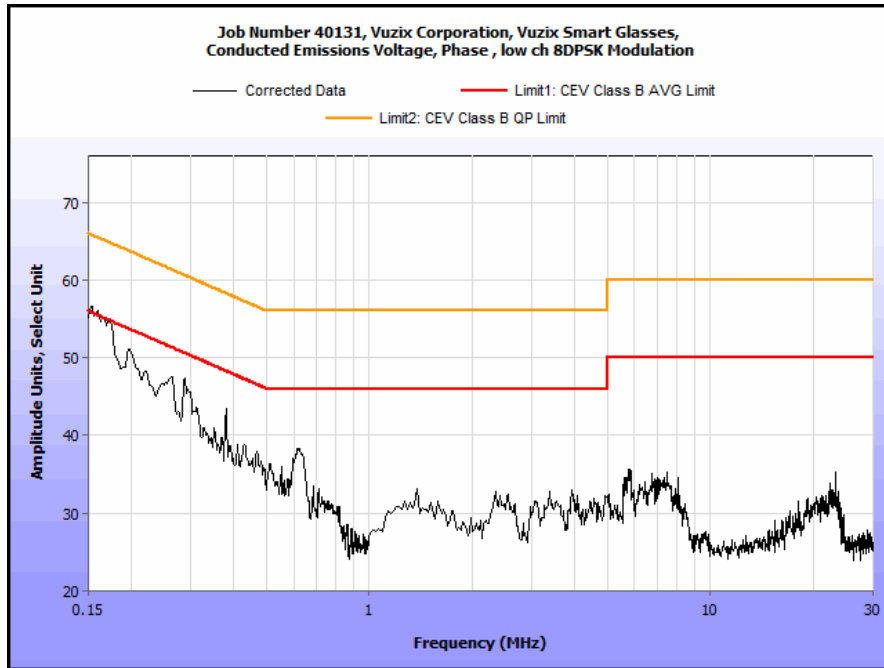

Plot 2. Conducted Emissions, 15.207(a), Phase, Low Channel, 8DPSK Modulation

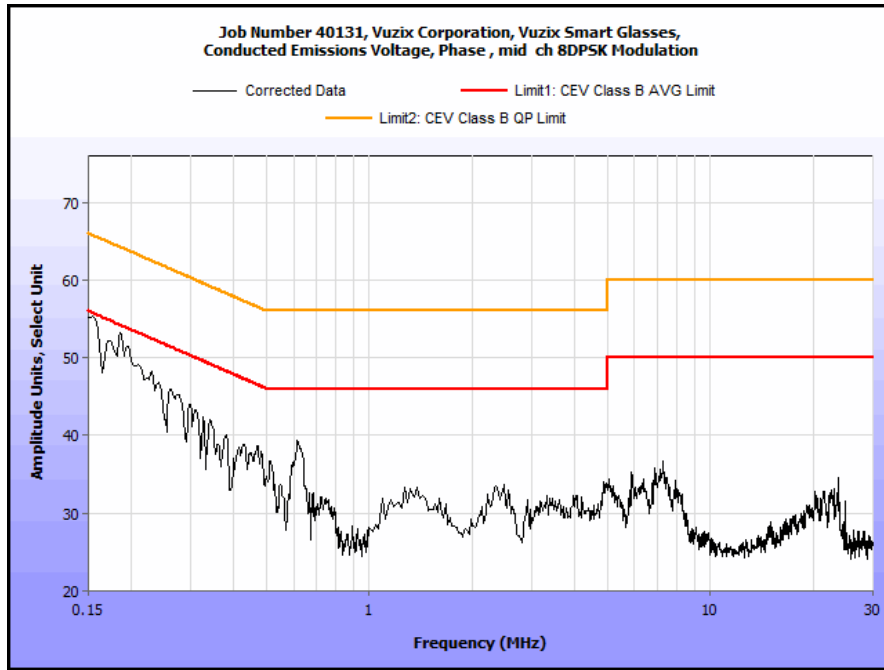

Plot 3. Conducted Emissions, 15.207(a), Phase, Mid Channel, 8DPSK Modulation

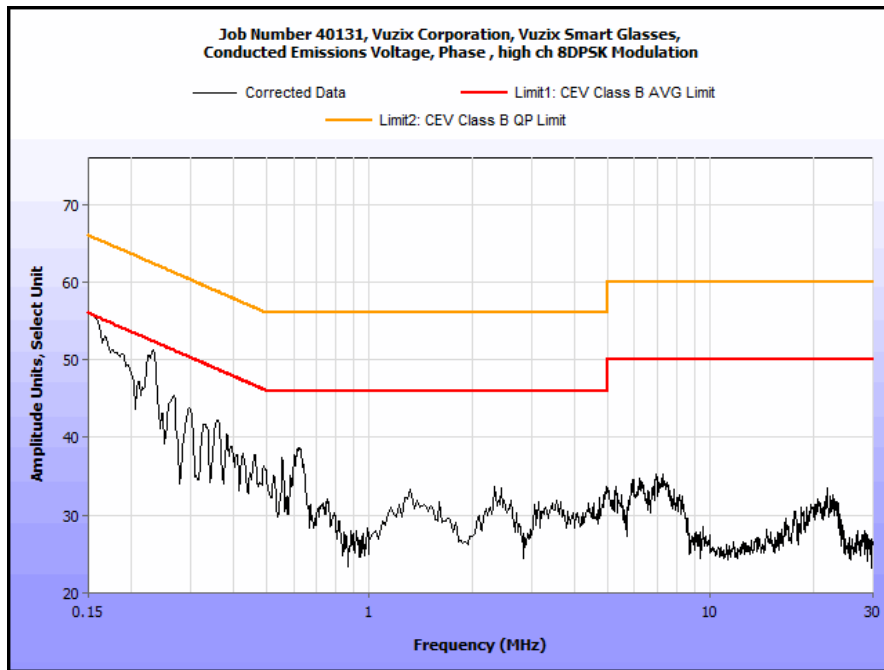

Plot 4. Conducted Emissions, 15.207(a), Phase, High Channel, 8DPSK Modulation

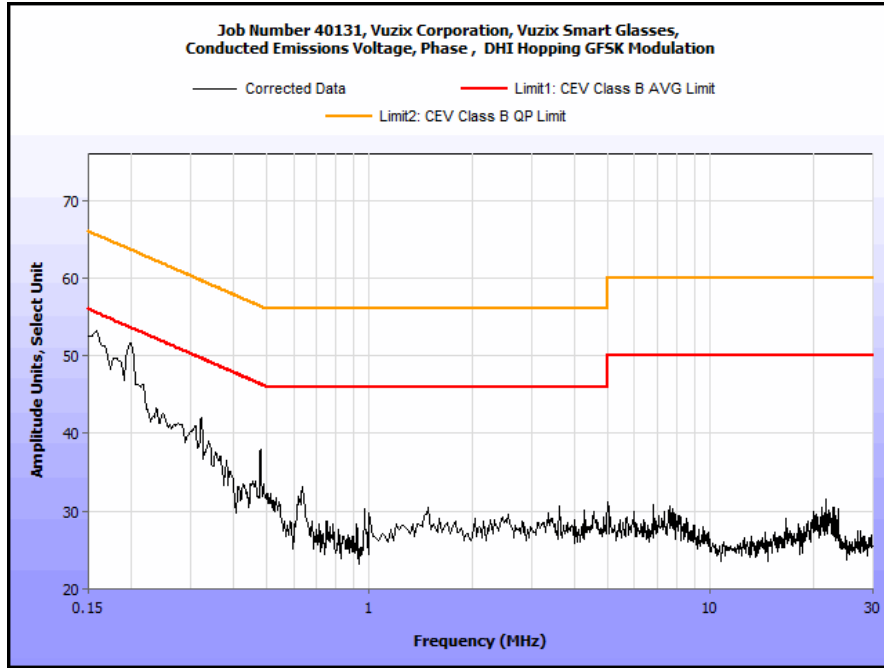

Plot 5. Conducted Emissions, 15.207(a), Phase DHI Hopping, GFSK Modulation

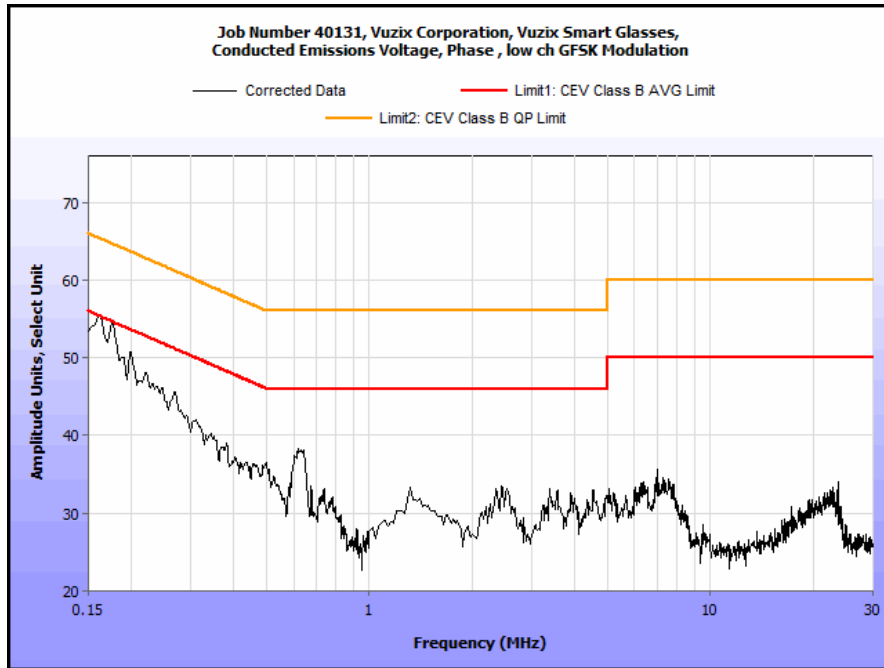

Plot 6. Conducted Emissions, 15.207(a), Phase, Low Channel, GFSK Modulation

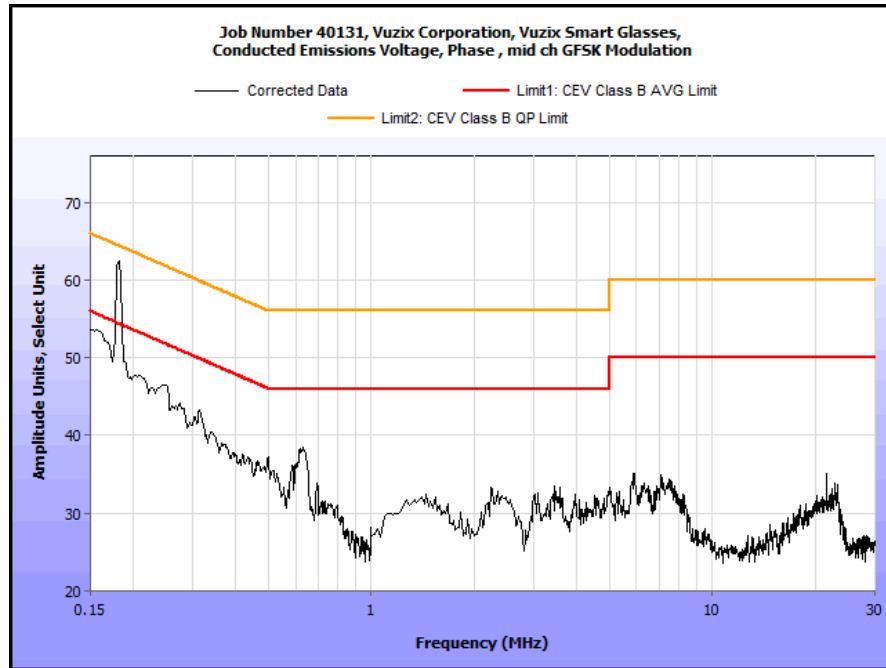

Plot 7. Conducted Emissions, 15.207(a), Phase, Mid Channel, GFSK Modulation

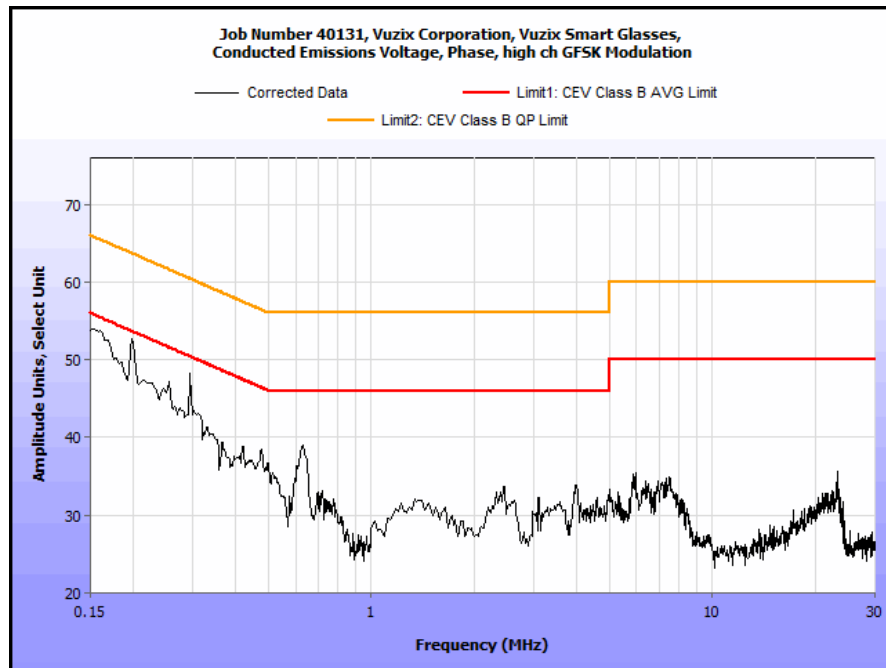

Plot 8. Conducted Emissions, 15.207(a), Phase, High Channel, GFSK Modulation

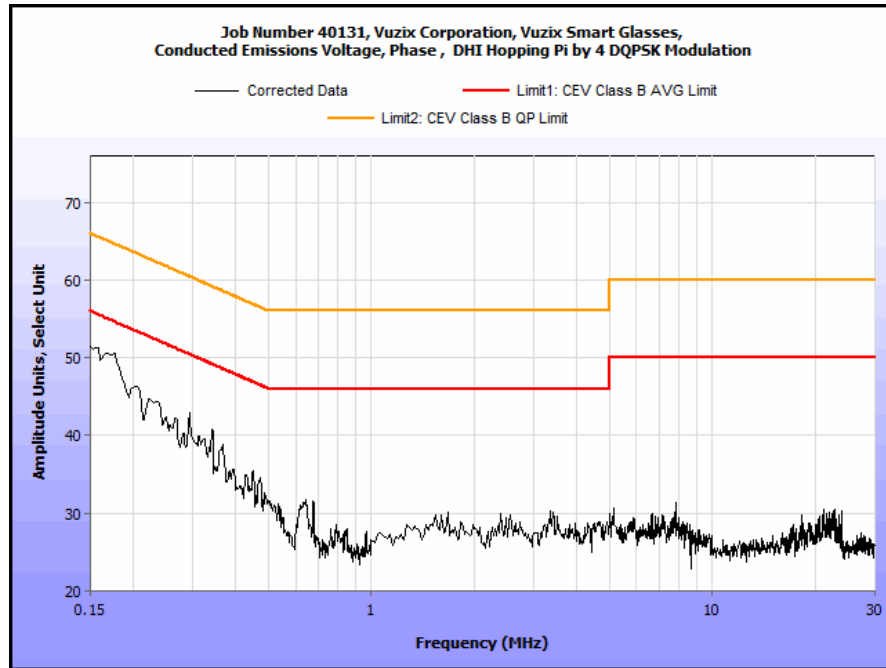

Plot 9. Conducted Emissions, 15.207(a), Phase DHI Hopping, Pi by 4 DQPSK Modulation

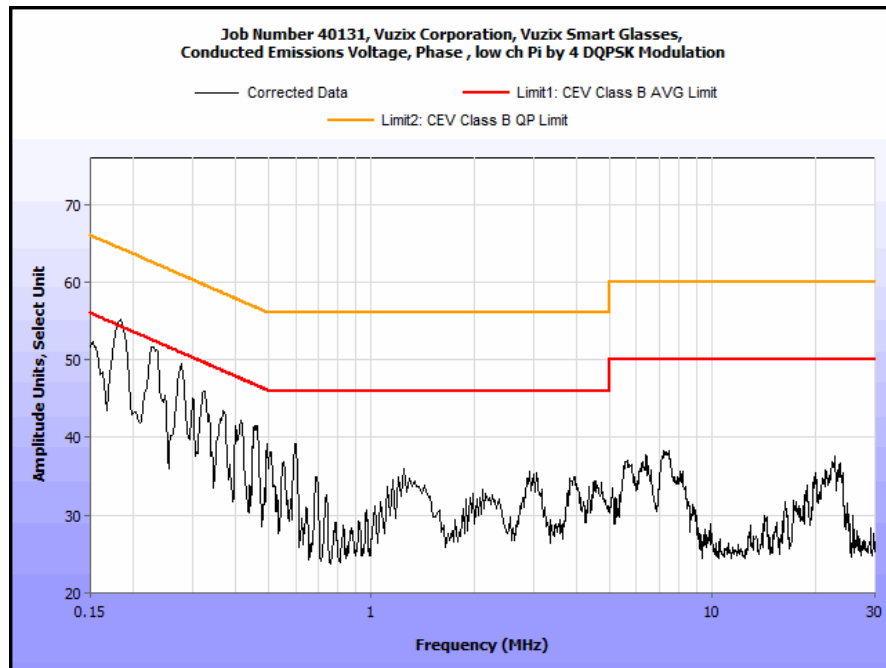

Plot 10. Conducted Emissions, 15.207(a), Phase, Low Channel, Pi by 4 DQPSK Modulation

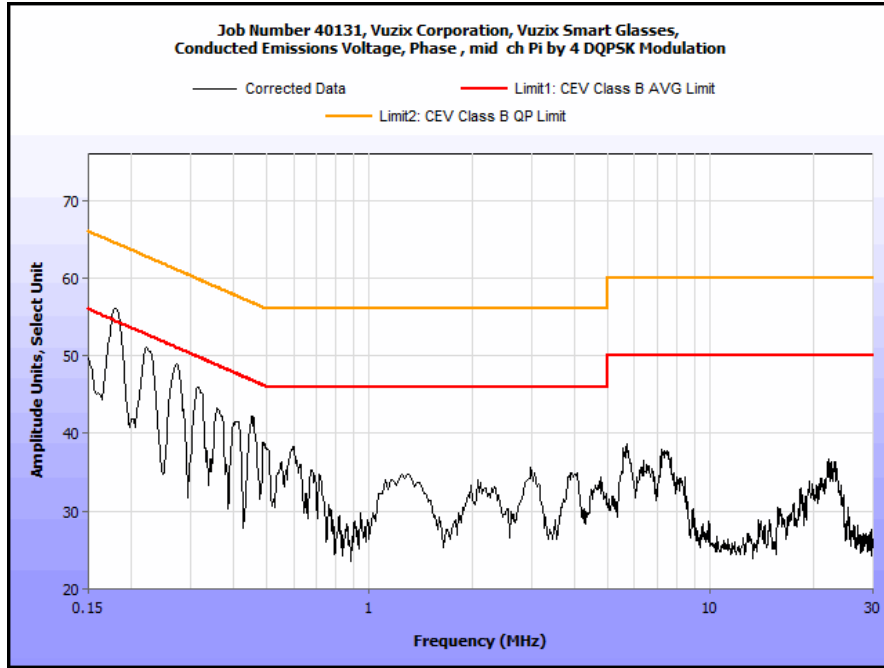

Plot 11. Conducted Emissions, 15.207(a), Phase, Mid Channel, Pi by 4 DQPSK Modulation

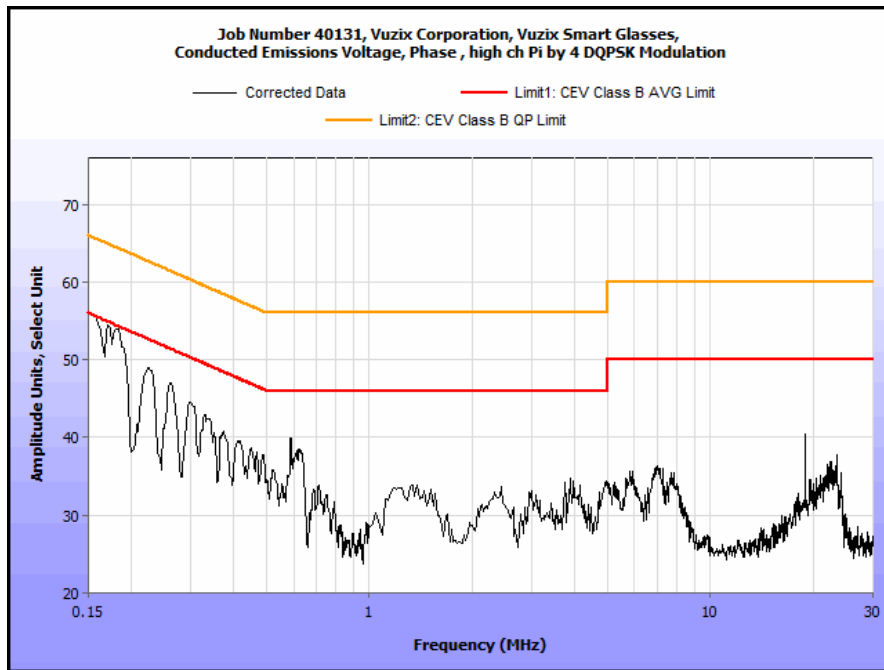

Plot 12. Conducted Emissions, 15.207(a), Phase, High Channel, Pi by 4 DQPSK Modulation

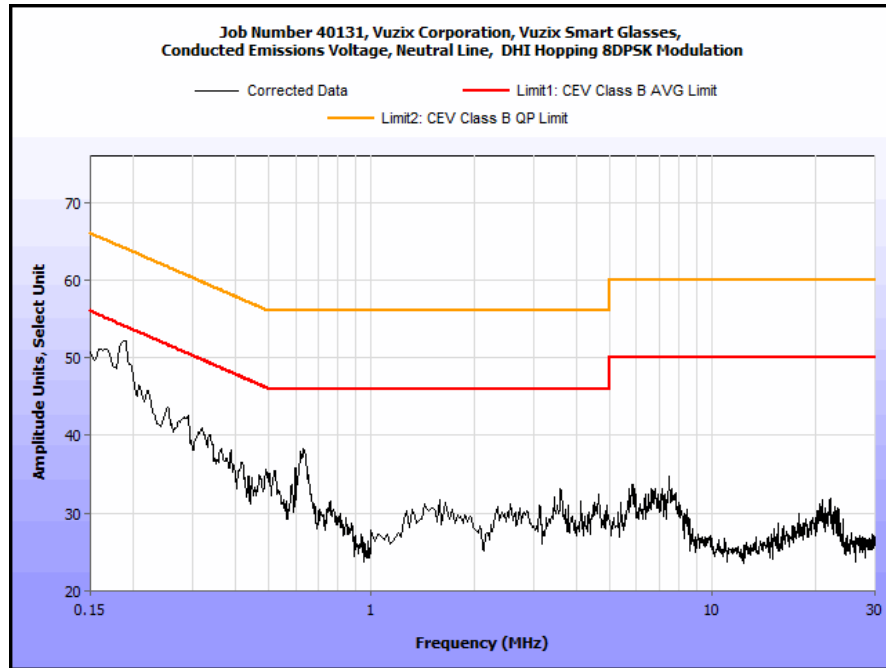

Plot 13. Conducted Emissions, 15.207(a), Neutral DHI Hopping, 8DPSK Modulation

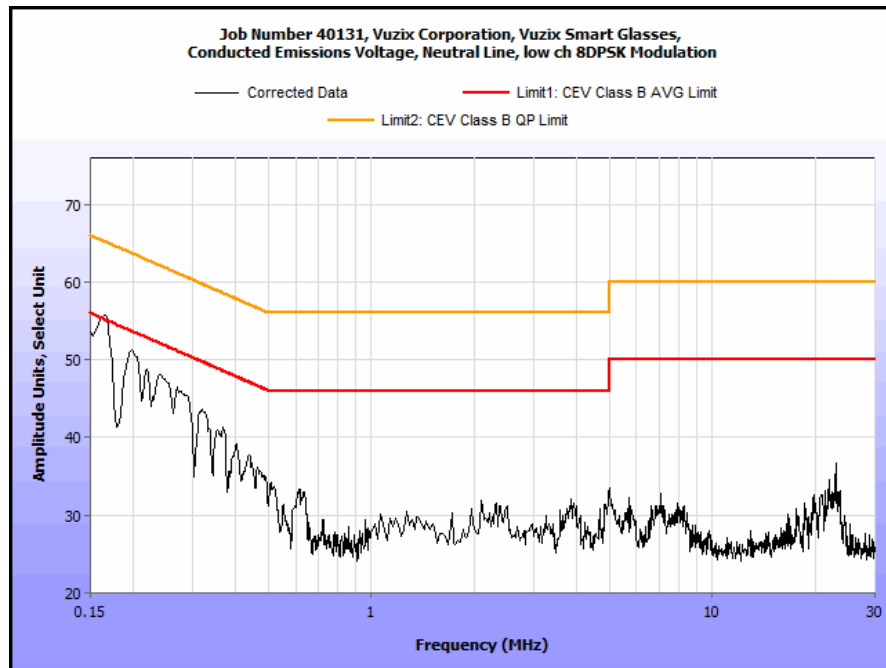

Plot 14. Conducted Emissions, 15.207(a), Neutral, Low Channel, 8DPSK Modulation

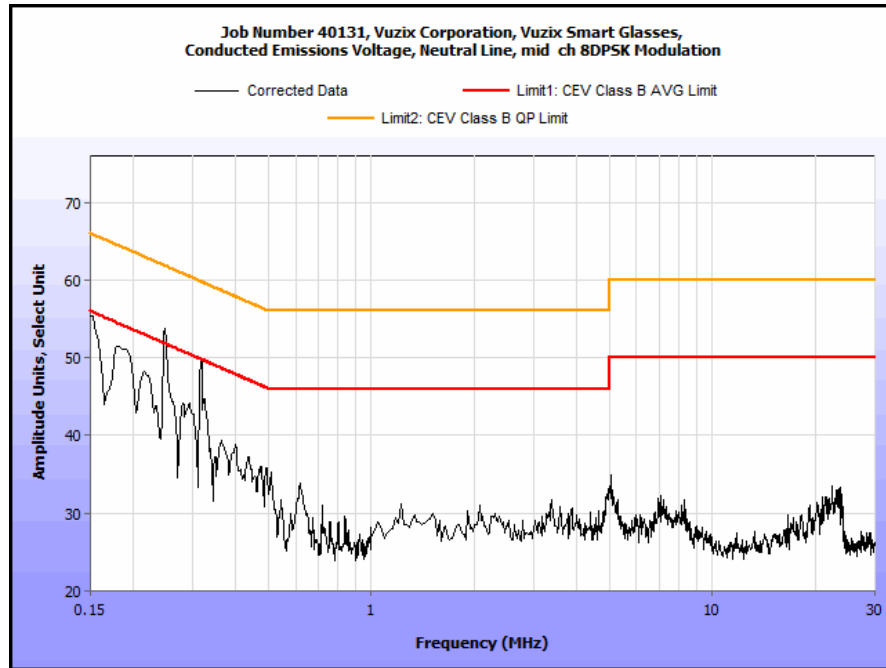

Plot 15. Conducted Emissions, 15.207(a), Neutral, Mid Channel, 8DPSK Modulation

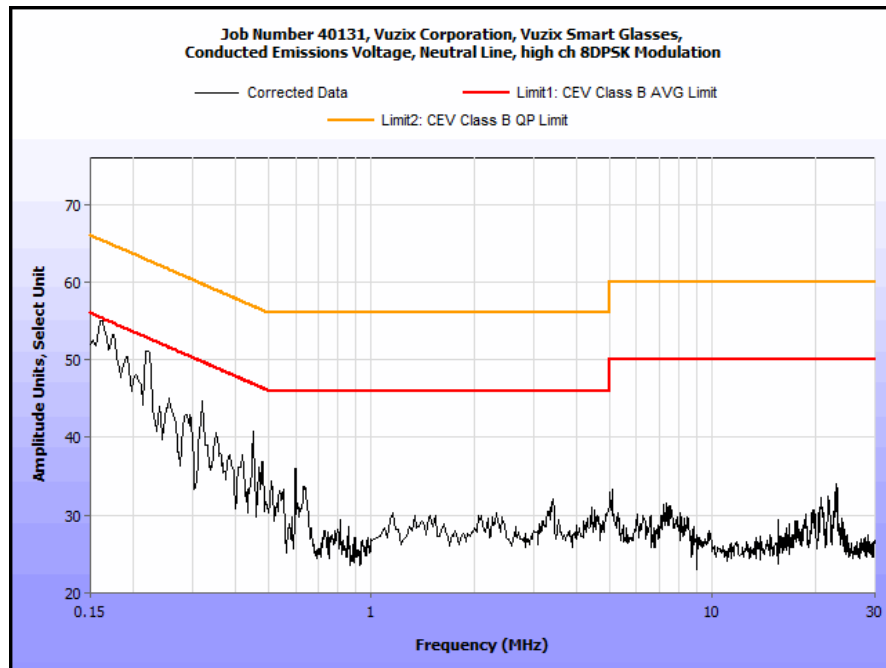

Plot 16. Conducted Emissions, 15.207(a), Neutral, High Channel, 8DPSK Modulation

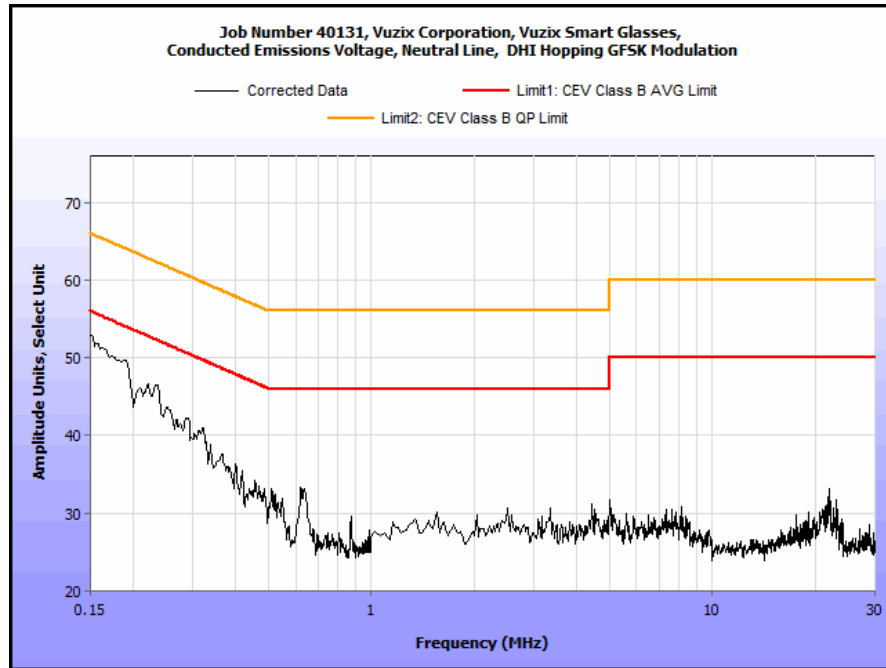

Plot 17. Conducted Emissions, 15.207(a), Neutral DHI Hopping, GFSK Modulation

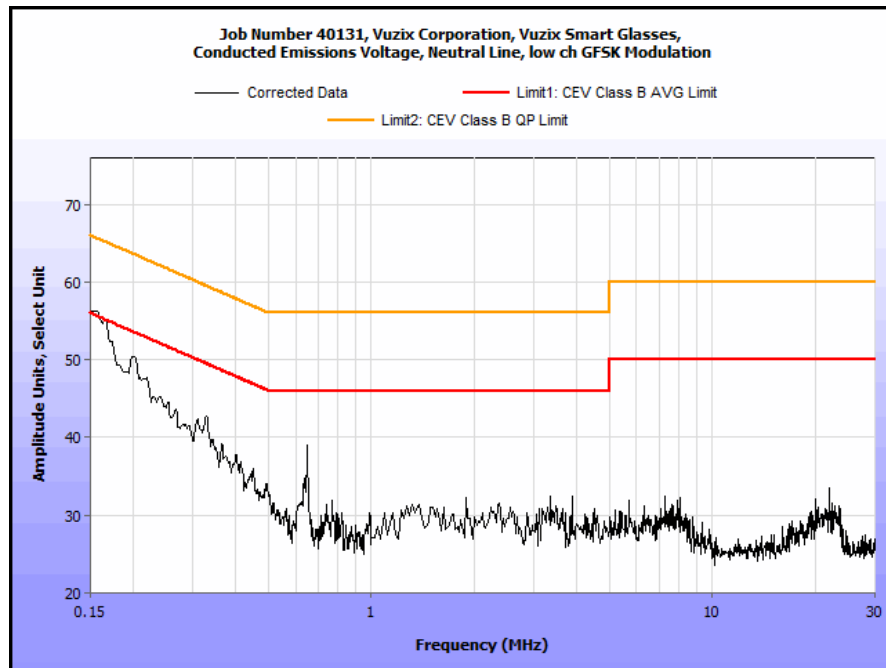

Plot 18. Conducted Emissions, 15.207(a), Neutral, Low Channel, GFSK Modulation

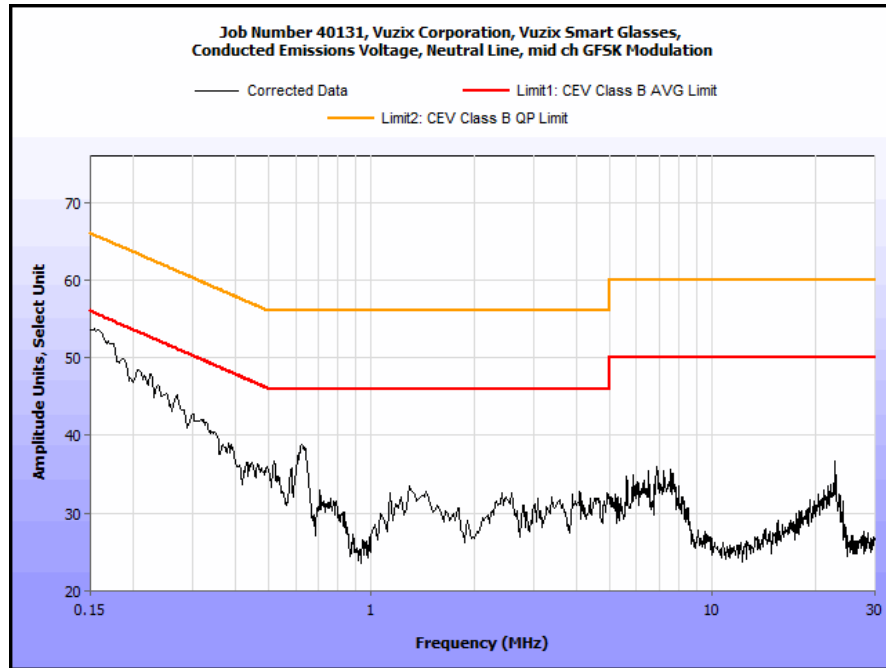

Plot 19. Conducted Emissions, 15.207(a), Neutral, Mid Channel, GFSK Modulation

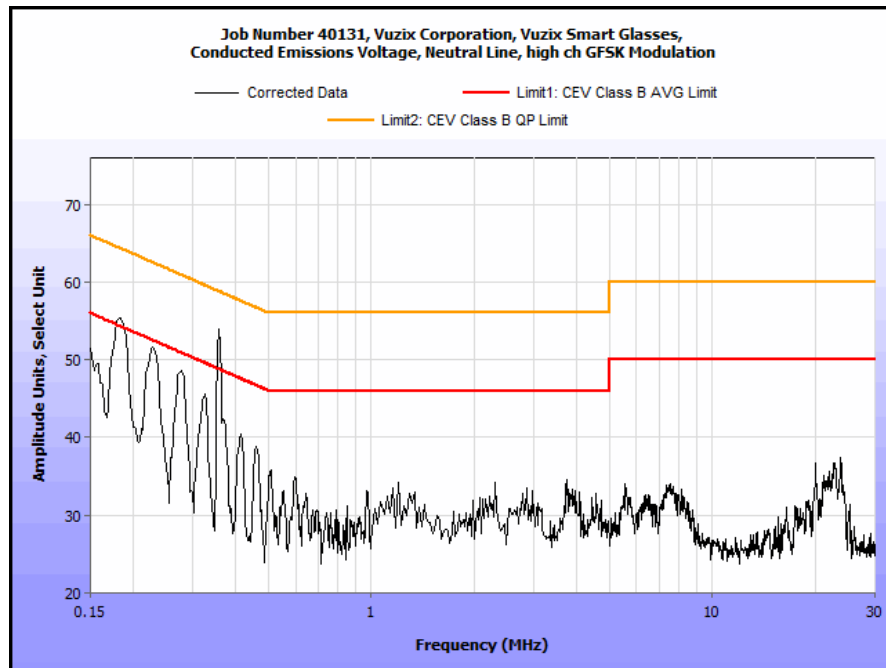

Plot 20. Conducted Emissions, 15.207(a), Neutral, High Channel, GFSK Modulation

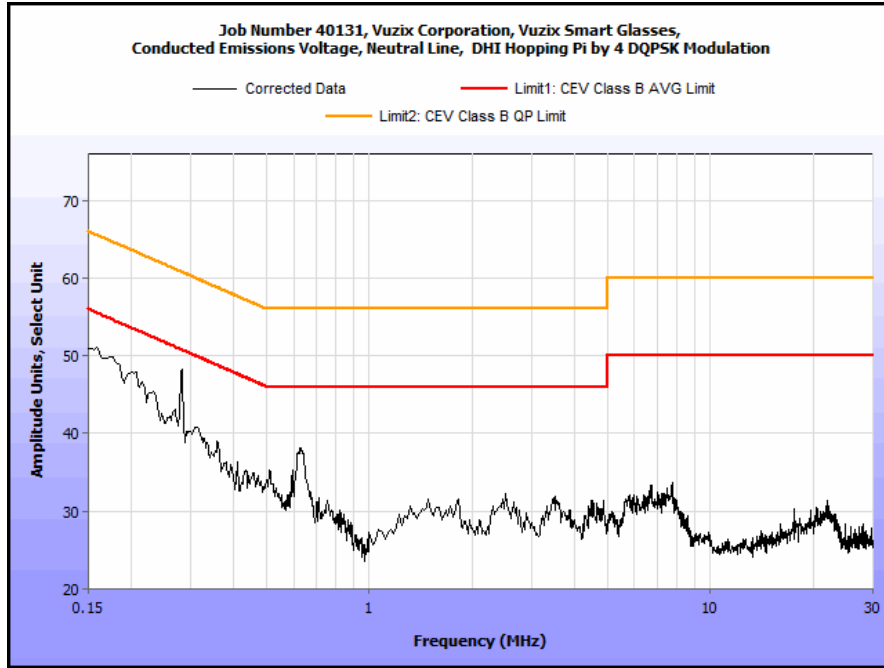

Plot 21. Conducted Emissions, 15.207(a), Neutral DHI Hopping, Pi by 4 DQPSK Modulation

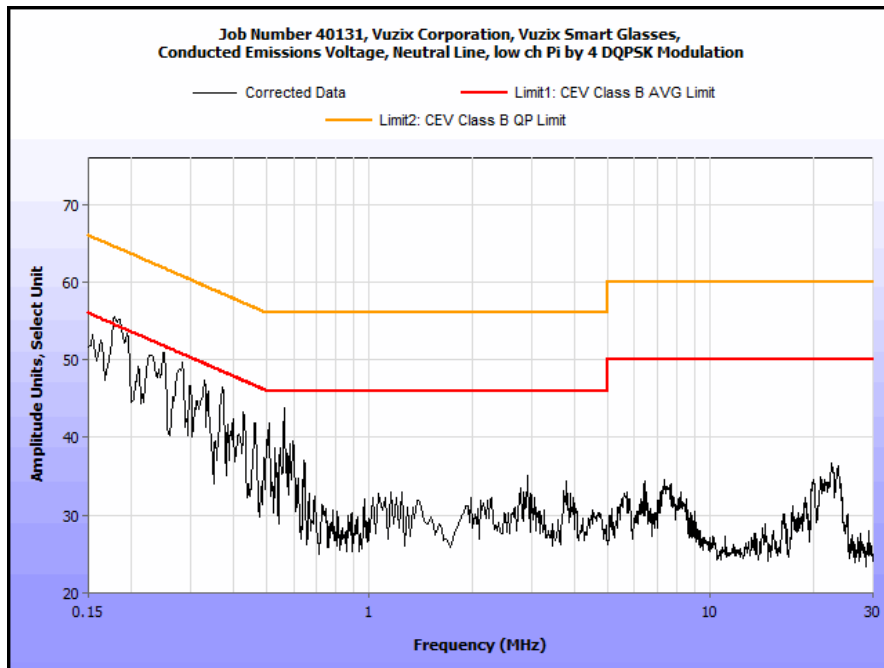

Plot 22. Conducted Emissions, 15.207(a), Neutral, Low Channel, Pi by 4 DQPSK Modulation

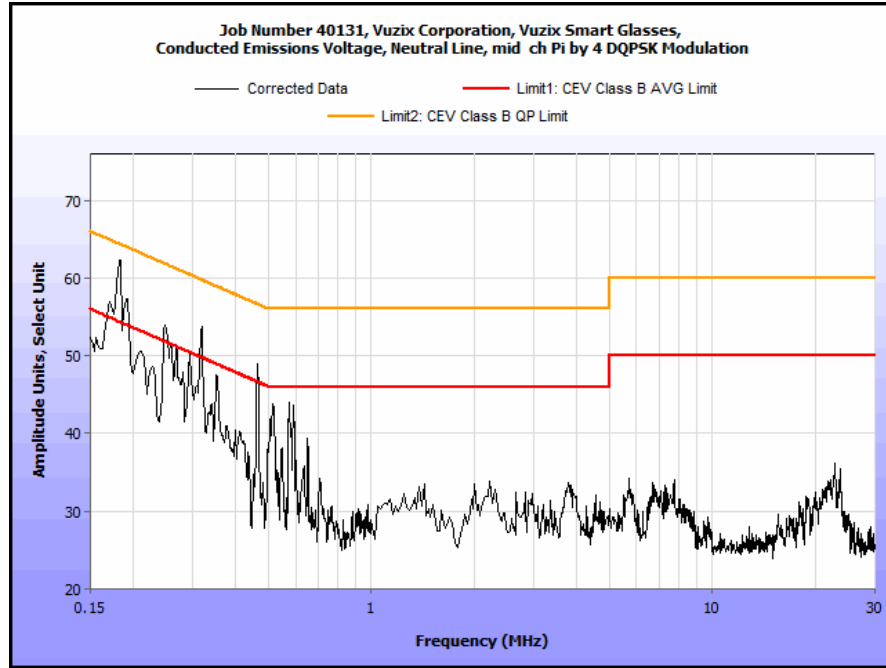

Plot 23. Conducted Emissions, 15.207(a), Neutral, Mid Channel, Pi by 4 DQPSK Modulation

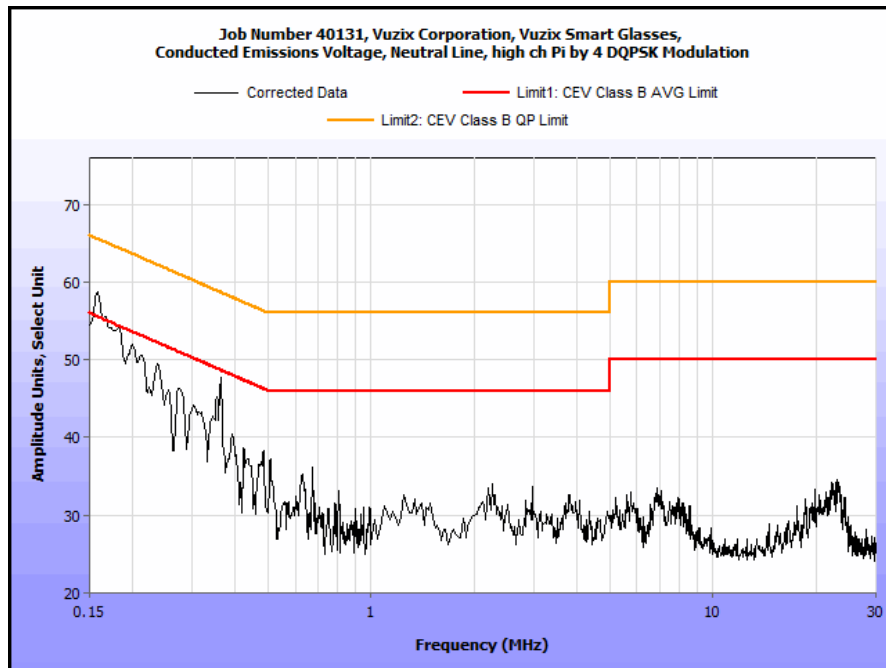

Plot 24. Conducted Emissions, 15.207(a), Neutral, High Channel, Pi by 4 DQPSK Modulation

Electromagnetic Compatibility Criteria for Intentional Radiators

§ 15.247(a)(1) 20 dB Occupied Bandwidth

Test Requirements: § 15.247(a): Operation under the provisions of this section is limited to frequency hopping and digitally modulated intentional radiators that comply with the following provisions:

For systems using digital modulation techniques, the EUT may operate in the 902-928 MHz, 2400-2483.5 MHz and 5725-5850 MHz bands. For DTS, the minimum 6 dB bandwidth shall be at least 500 kHz. For frequency hopping systems, the EUT shall have hopping channel carrier frequencies separated by a minimum of 25 kHz or the 20 dB bandwidth of the hopping channel, whichever is greater.

Test Procedure: The bandwidth of the fundamental frequency was measured with the spectrum analyzer using a RBW approximately equal to 1% of the total emission bandwidth. The 20 dB bandwidth was measured and recorded.

Test Results The EUT was compliant with § 15.247 (a)(2).

Test Engineer(s): Shawn McMillen

Test Date(s): 11/06/13

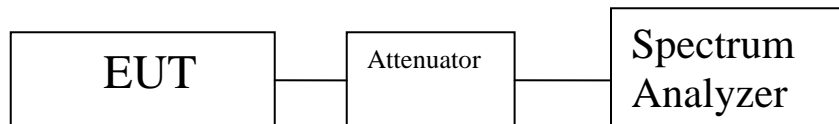

Figure 2. Block Diagram, Occupied Bandwidth Test Setup

20dB Bandwidth 8DPSK		
Carrier Channel	Frequency (MHz)	Measured 20dB Occupied Bandwidth (MHz)
Low	2.402	1.2414
Mid	2.441	1.2429
High	2.480	1.2328

Table 10. 20 dB Occupied Bandwidth, 8DPSK

20dB Bandwidth GFSK		
Carrier Channel	Frequency (MHz)	Measured 20dB Occupied Bandwidth (MHz)
Low	2.402	0.846
Mid	2.441	0.852
High	2.480	0.859

Table 11. 20 dB Occupied Bandwidth, GFSK

20dB Bandwidth $\pi/4$ DQPSK		
Carrier Channel	Frequency (MHz)	Measured 20dB Occupied Bandwidth (MHz)
Low	2.402	1.2672
Mid	2.441	1.2528
High	2.480	1.2422

Table 12. 20 dB Occupied Bandwidth, $\pi/4$ DQPSK

99% Bandwidth 8DPSK		
Carrier Channel	Frequency (MHz)	Measured 99% Occupied Bandwidth (MHz)
Low	2.402	1.2243
Mid	2.441	1.2607
High	2.48	1.223

Table 13. 99% Bandwidth, 8DPSK

99% Bandwidth GFSK		
Carrier Channel	Frequency (MHz)	Measured 99% Occupied Bandwidth (MHz)
Low	2.402	0.778
Mid	2.441	0.781
High	2.48	0.856

Table 14. 99% Bandwidth, GFSK

99% Bandwidth $\pi/4$ DQPSK		
Carrier Channel	Frequency (MHz)	Measured 99% Occupied Bandwidth (MHz)
Low	2.402	1.2625
Mid	2.441	1.1674
High	2.48	1.2299

Table 15. 99% Bandwidth, $\pi/4$ DQPSK

20 dB Occupied Bandwidth Test Results

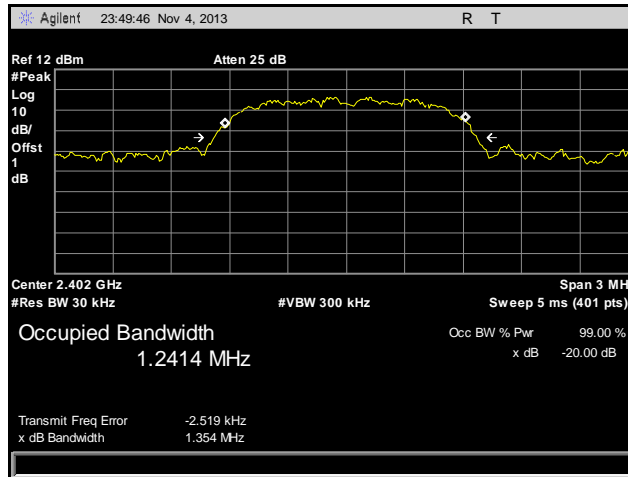

Plot 25. 20 dB Occupied Bandwidth, Low Channel, 8DPSK

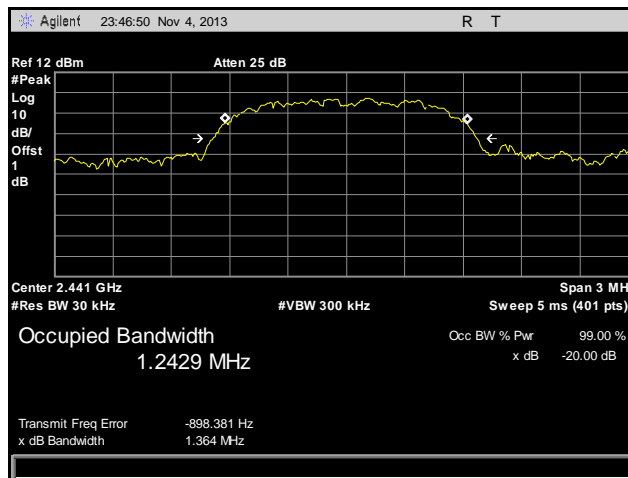

Plot 26. 20 dB Occupied Bandwidth, Mid Channel, 8DPSK

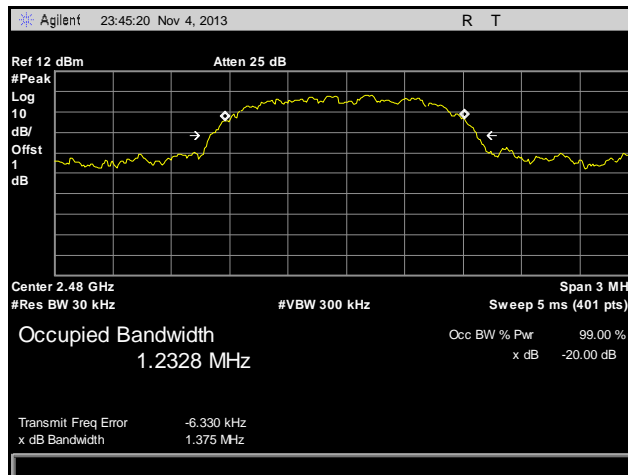

Plot 27. 20 dB Occupied Bandwidth, High Channel, 8DPSK

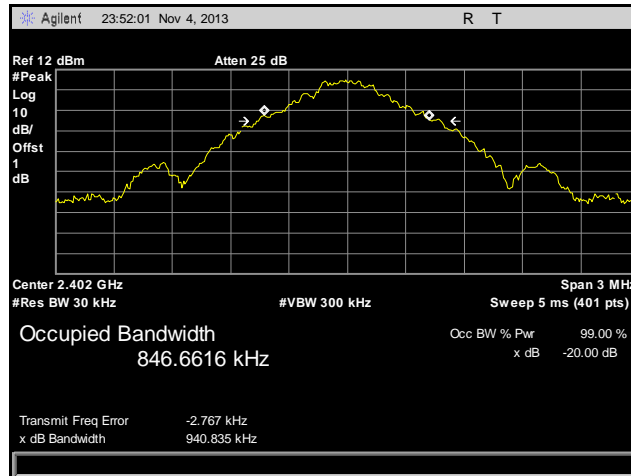

Plot 28. 20 dB Occupied Bandwidth, Low Channel, GFSK

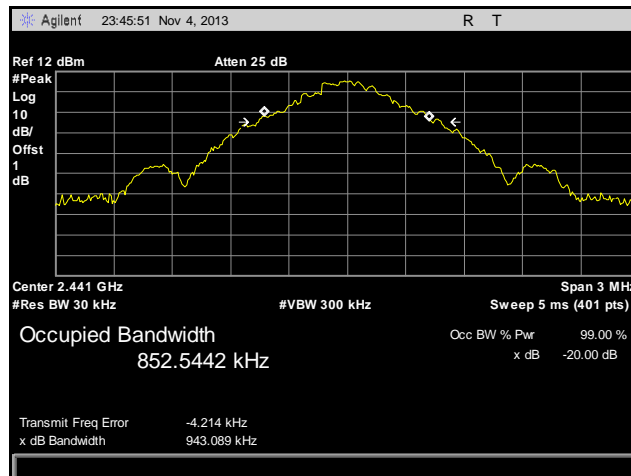

Plot 29. 20 dB Occupied Bandwidth, Mid Channel, GFSK

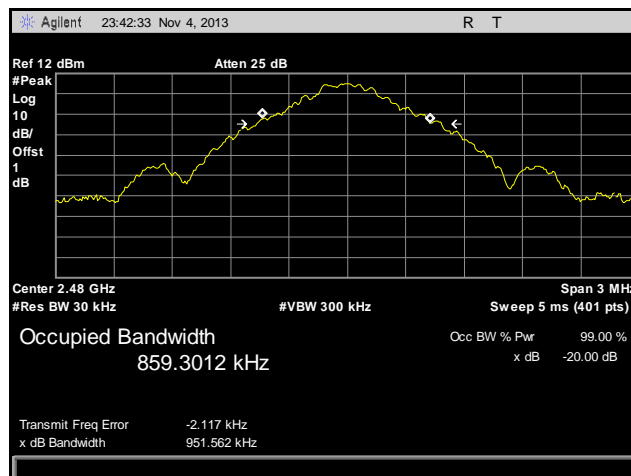

Plot 30. 20 dB Occupied Bandwidth, High Channel, GFSK

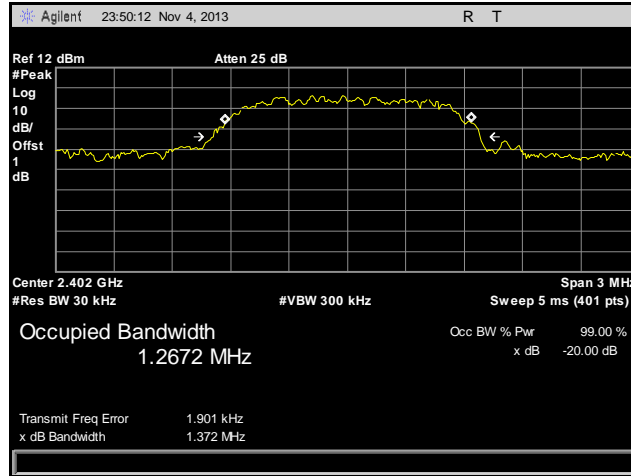

Plot 31. 20 dB Occupied Bandwidth, Low Channel, Pi by 4 DQPKD

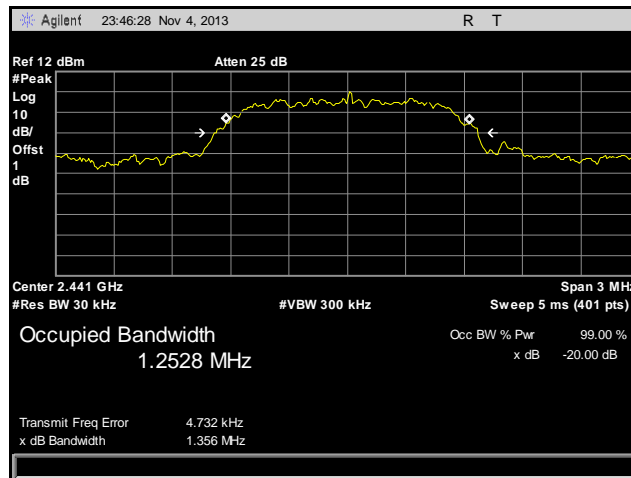

Plot 32. 20 dB Occupied Bandwidth, Mid Channel, Pi by 4 DQPKD

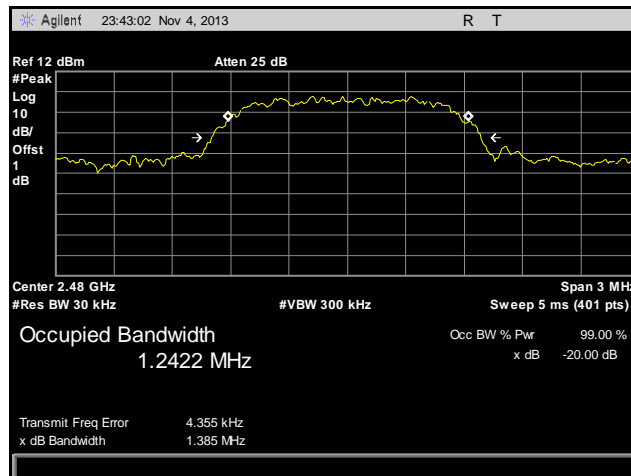

Plot 33. 20 dB Occupied Bandwidth, High Channel, Pi by 4 DQPKD

99% Occupied Bandwidth Test Results

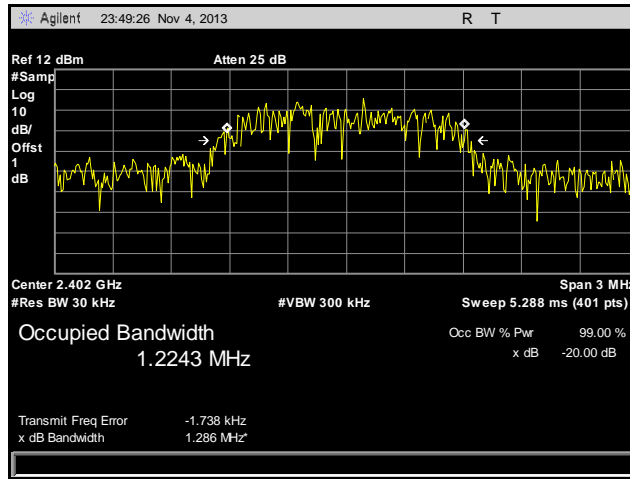

Plot 34. 99% Occupied Bandwidth, Low Channel, 8DPSK

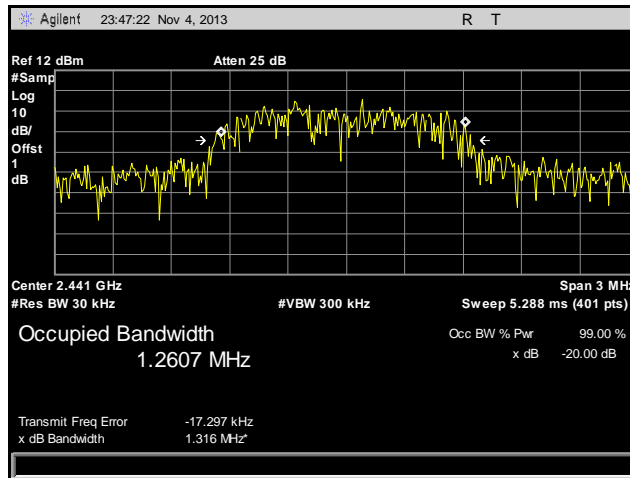

Plot 35. 99% Occupied Bandwidth, Mid Channel, 8DPSK

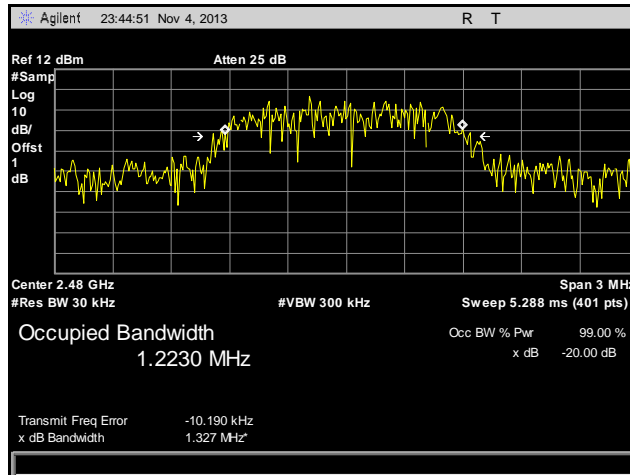

Plot 36. 99% Occupied Bandwidth, High Channel, 8DPSK

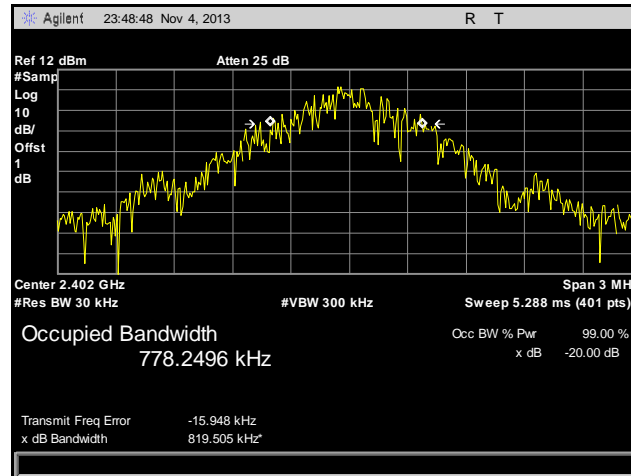

Plot 37. 99% Occupied Bandwidth, Low Channel, GFSK

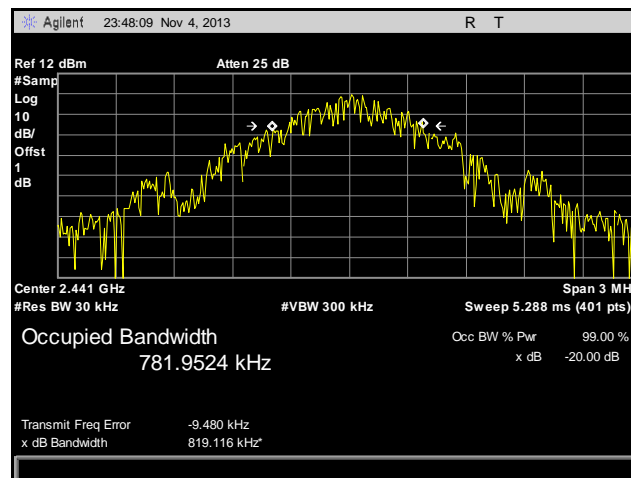

Plot 38. 99% Occupied Bandwidth, Mid Channel, GFSK

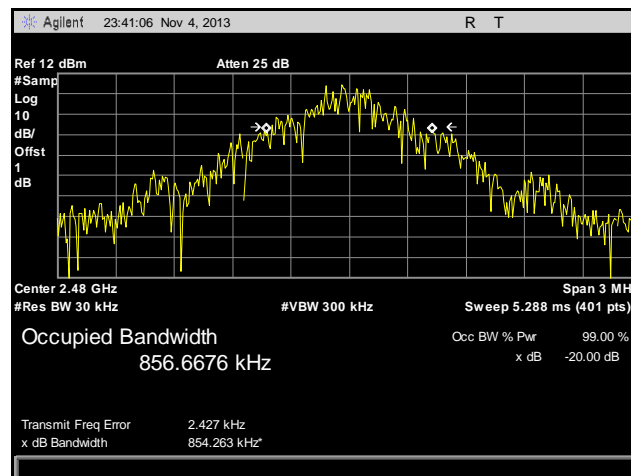

Plot 39. 99% Occupied Bandwidth, High Channel, GFSK

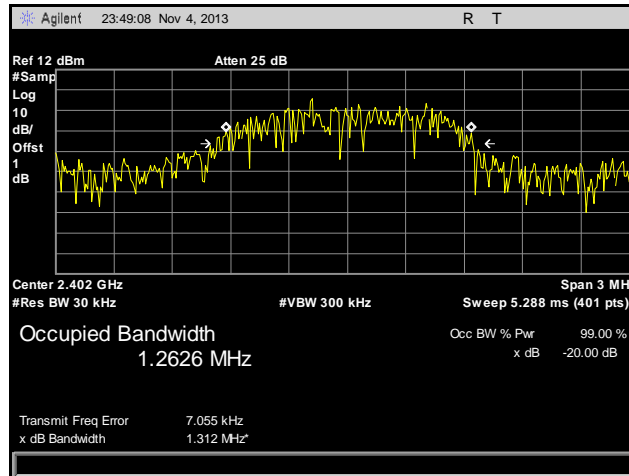

Plot 40. 99% Occupied Bandwidth, Low Channel, Pi by 4 DQPKD

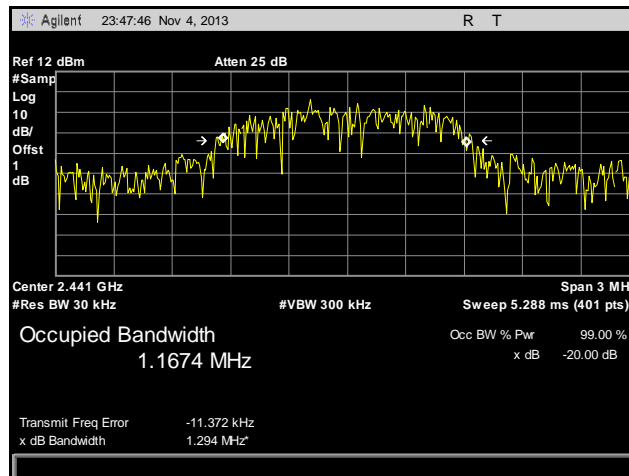

Plot 41. 99% Occupied Bandwidth, Mid Channel, Pi by 4 DQPKD

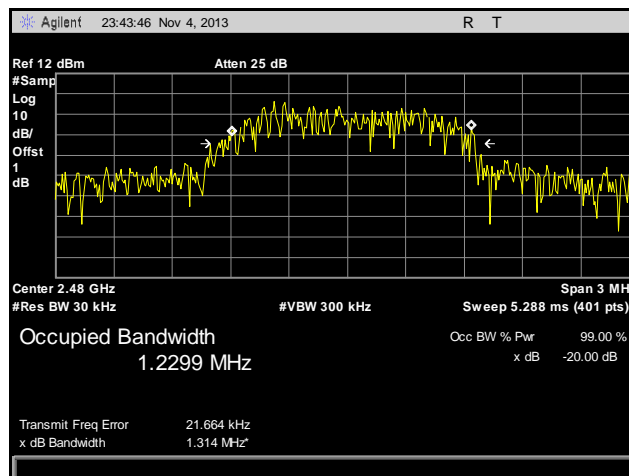

Plot 42. 99% Occupied Bandwidth, High Channel, Pi by 4 DQPKD

Electromagnetic Compatibility Criteria for Intentional Radiators

§ 15.247(a)(1) Average Time of Occupancy (Dwell Time)

Remarks: The average time of occupancy on any frequency shall not be greater than 0.4 seconds within a 20 second period.

Total hopping channels is 79 for all three Modulation 8DPSK, GFSK and $\pi/4$ DQPSK. The EUT meets the specifications of Section 15.247(a) (1) (iii) for Number of Hopping Channels.

Modulation	Packet Type	# of Channels	Dwell Time	# of pulses in 31.6 Seconds (Pulses*10)	Average Time of Occupancy in 31.6 Seconds	Limit	Margin
			ms		seconds	seconds	seconds
8DPSK	DH1	79	0.390	31	0.120	0.4	-0.28
	DH3	79	1.625	16	0.260	0.4	-0.14
	DH5	79	2.85	13	0.370	0.4	-0.03
GFSK	DH1	79	0.382	32	0.122	0.4	-0.278
	DH3	79	1.625	19	0.300	0.4	-0.1
	DH5	79	2.875	11	0.310	0.4	-0.09
$\pi/4$ DQPSK	DH1	79	0.385	32	0.123	0.4	-0.277
	DH3	79	1.638	17	0.278	0.4	-0.122
	DH5	79	2.869	9	0.258	0.4	-0.142

Table 16. Average Time of Occupancy

Dwell Time

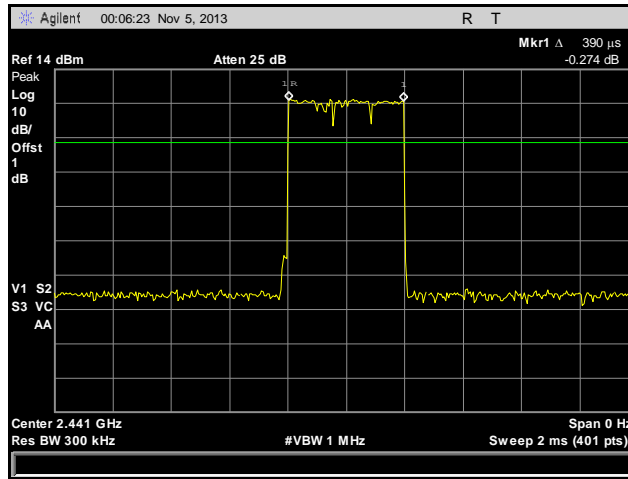

Plot 43. Dwell Time, Pulse Width, 8DPSK, DH1

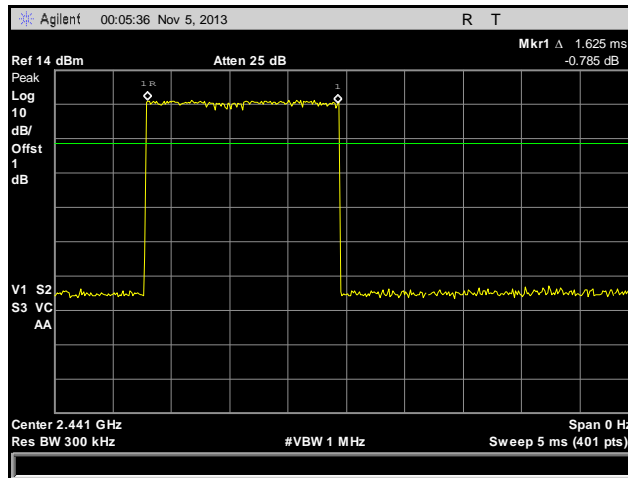

Plot 44. Dwell Time, Pulse Width, 8DPSK, DH3

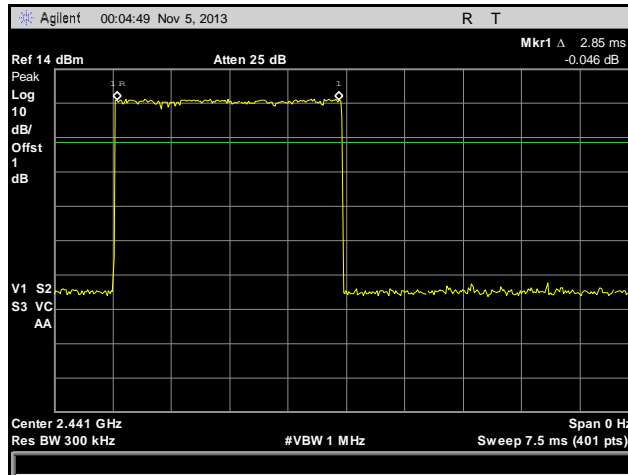

Plot 45. Dwell Time, Pulse Width, 8DPSK, DH5

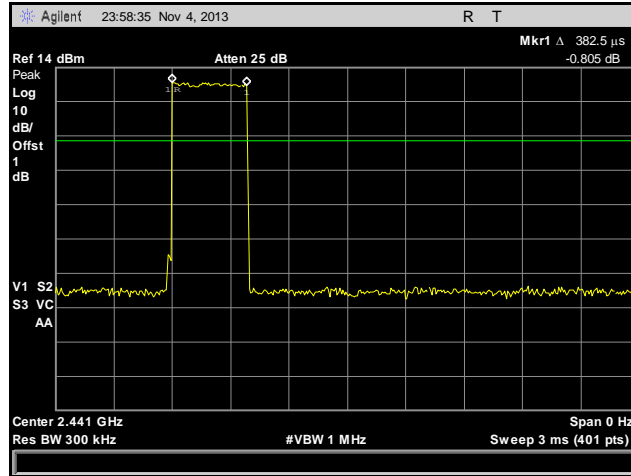

Plot 46. Dwell Time, Pulse Width, GFSK, DH1

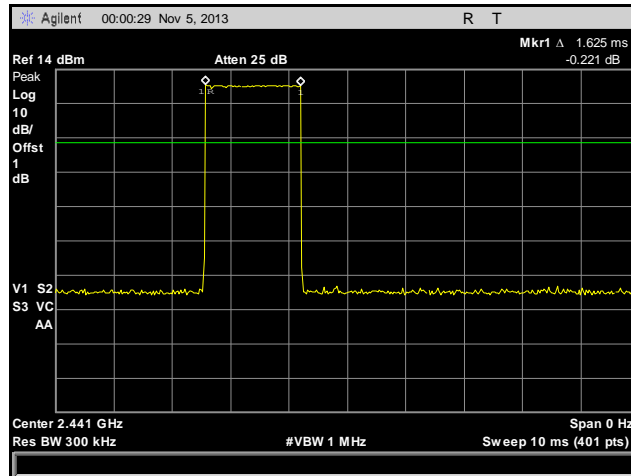

Plot 47. Dwell Time, Pulse Width, GFSK, DH3

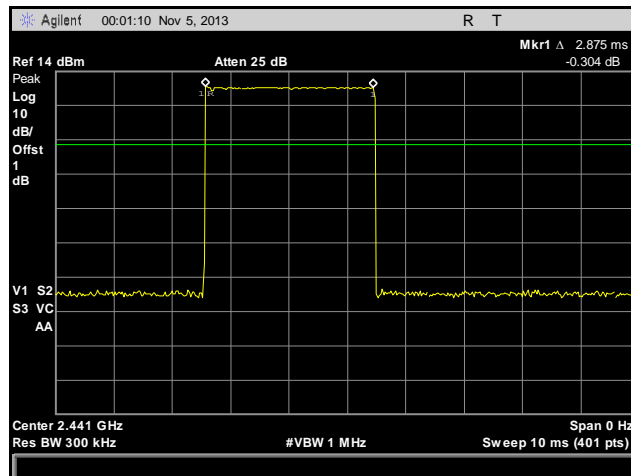

Plot 48. Dwell Time, Pulse Width, GFSK, DH5

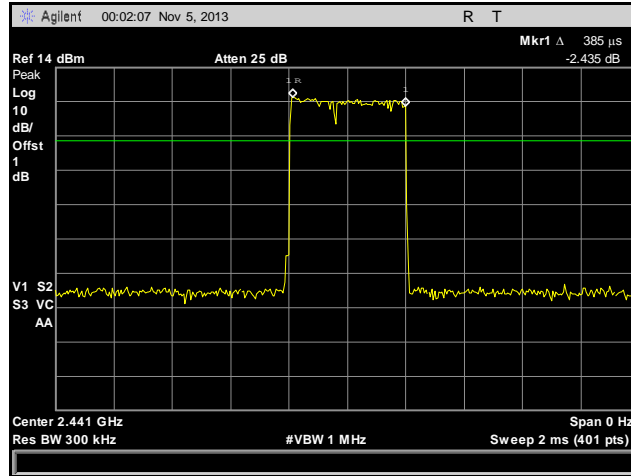

Plot 49. Dwell Time, Pulse Width, Pi by 4 DQPSK, DH1

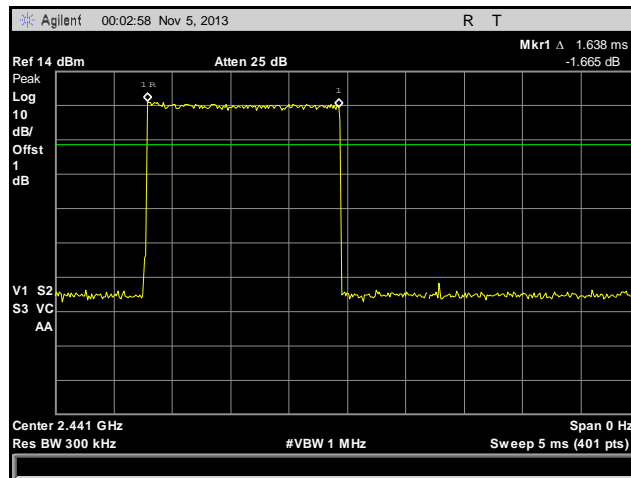

Plot 50. Dwell Time, Pulse Width, Pi by 4 DQPSK, DH3

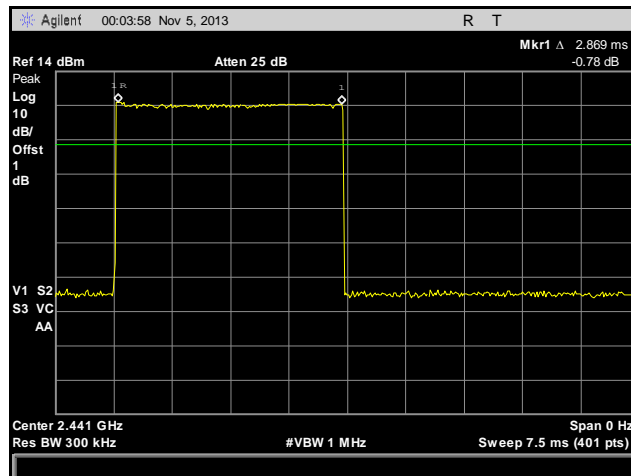

Plot 51. Dwell Time, Pulse Width, Pi by 4 DQPSK, DH5

Number of Pulses

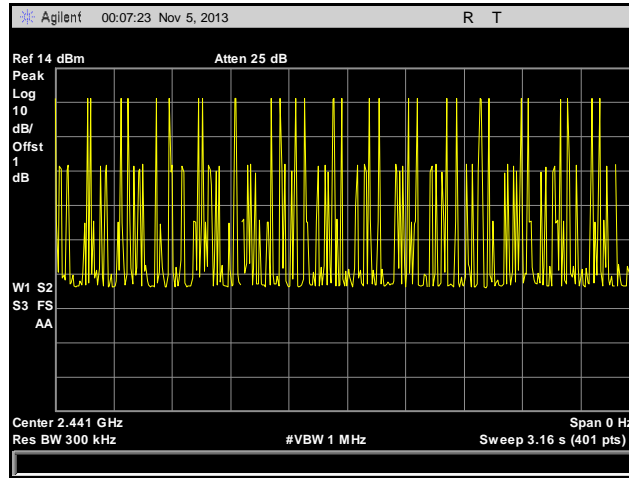

Plot 52. Number of Pulses, 8DPSK, DH1

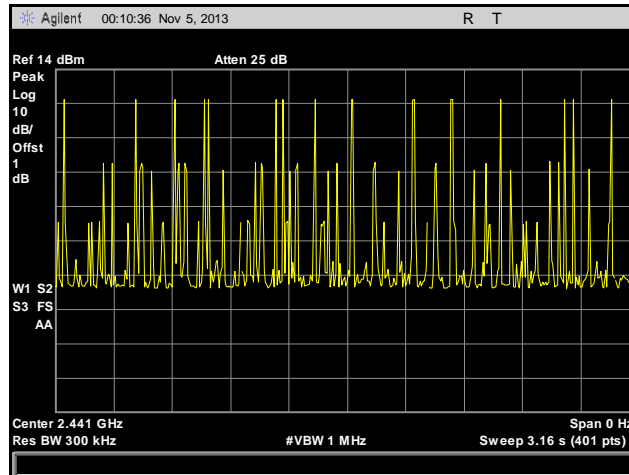

Plot 53. Number of Pulses, 8DPSK, DH3

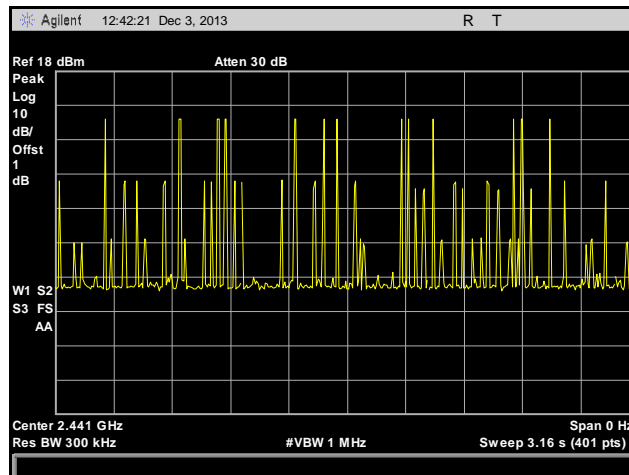

Plot 54. Number of Pulses, 8DPSK, DH5

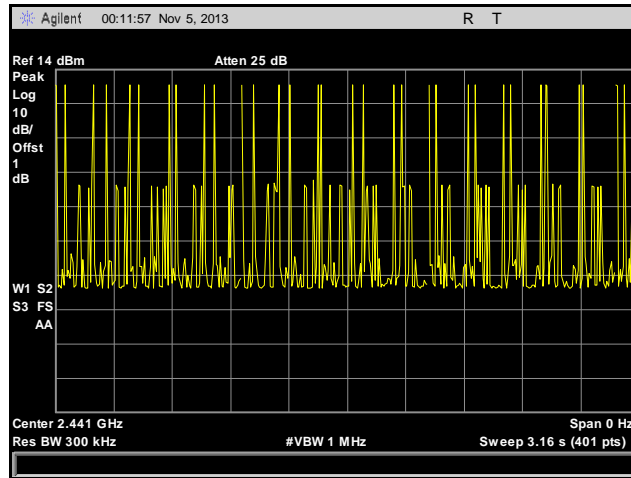

Plot 55. Number of Pulses, GFSK, DH1

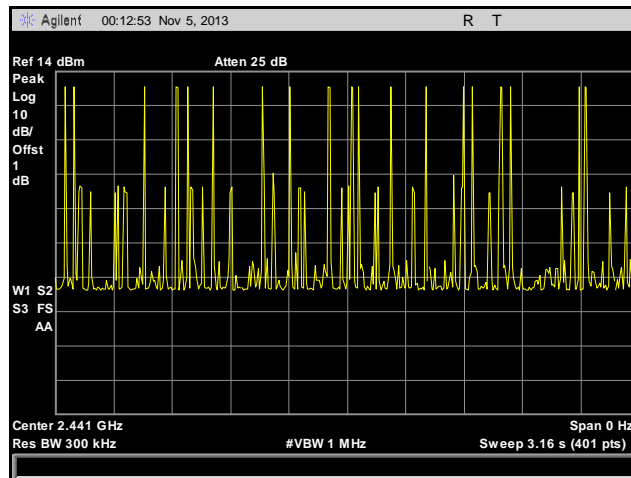

Plot 56. Number of Pulses, GFSK, DH3

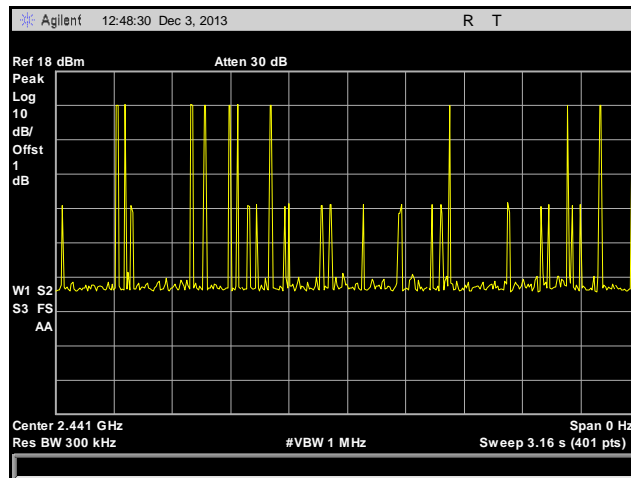

Plot 57. Number of Pulses, GFSK, DH5

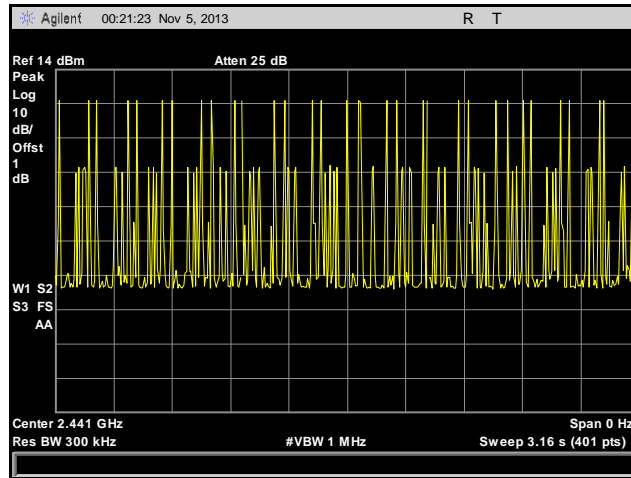

Plot 58. Number of Pulses, Pi by 4 DQPSDK, DH1

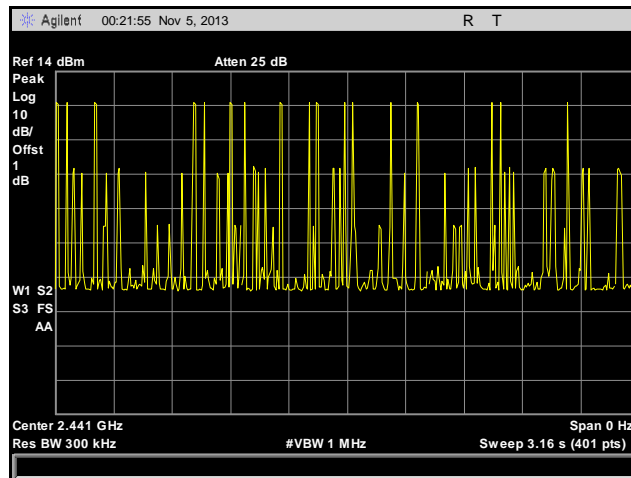

Plot 59. Number of Pulses, Pi by 4 DQPSDK, DH3

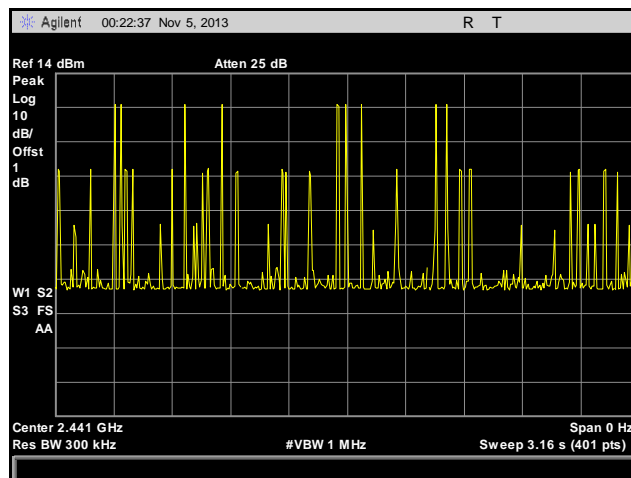

Plot 60. Number of Pulses, Pi by 4 DQPSDK, DH5

Electromagnetic Compatibility Criteria for Intentional Radiators

§ 15.247(a)(1) Number of RF Channels

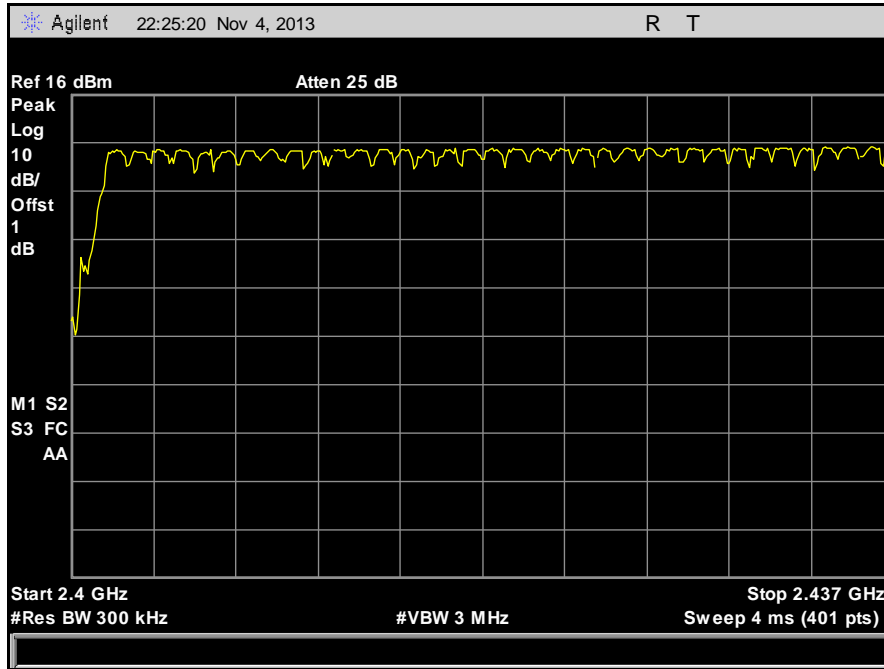

Plot 61. Number of Channels, 8DQPSK, 2400 MHz – 2437 MHz

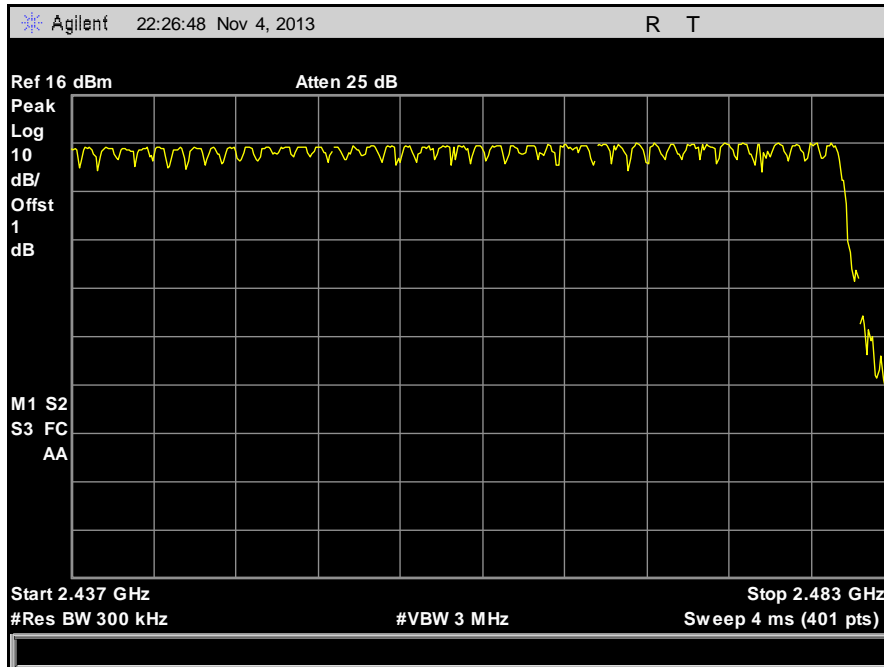

Plot 62. Number of Channels, 8DQPSK, 2437 MHz – 2483.5 MHz

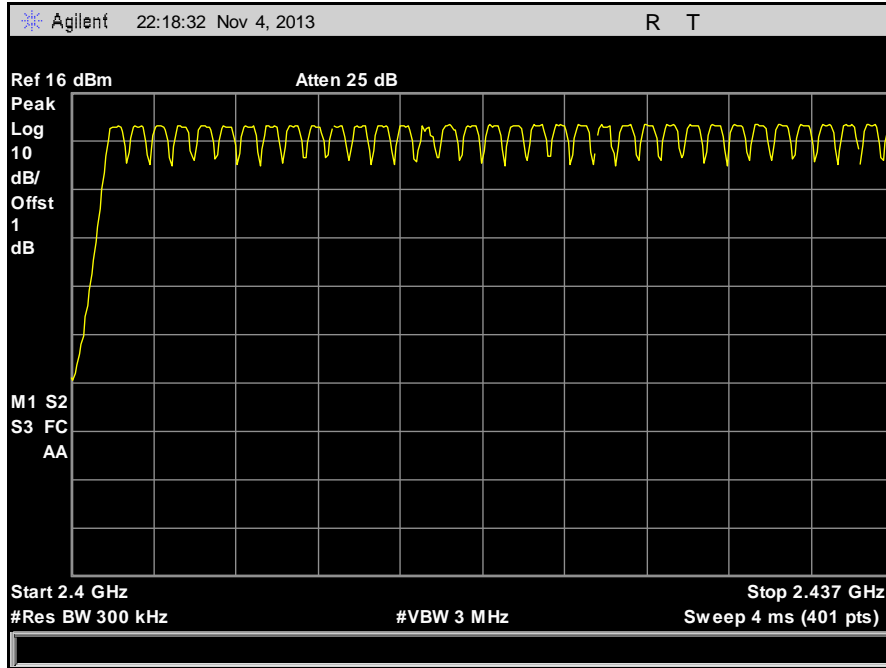

Plot 63. Number of Channels, GFSK, 2400 MHz – 2437 MHz

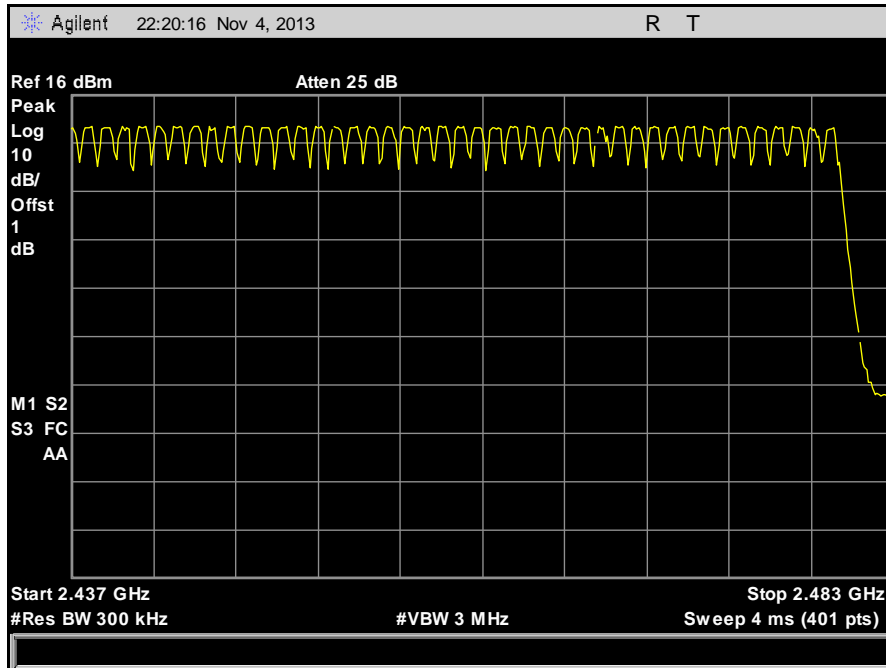

Plot 64. Number of Channels, GFSK, 2437 MHz – 2483.5 MHz

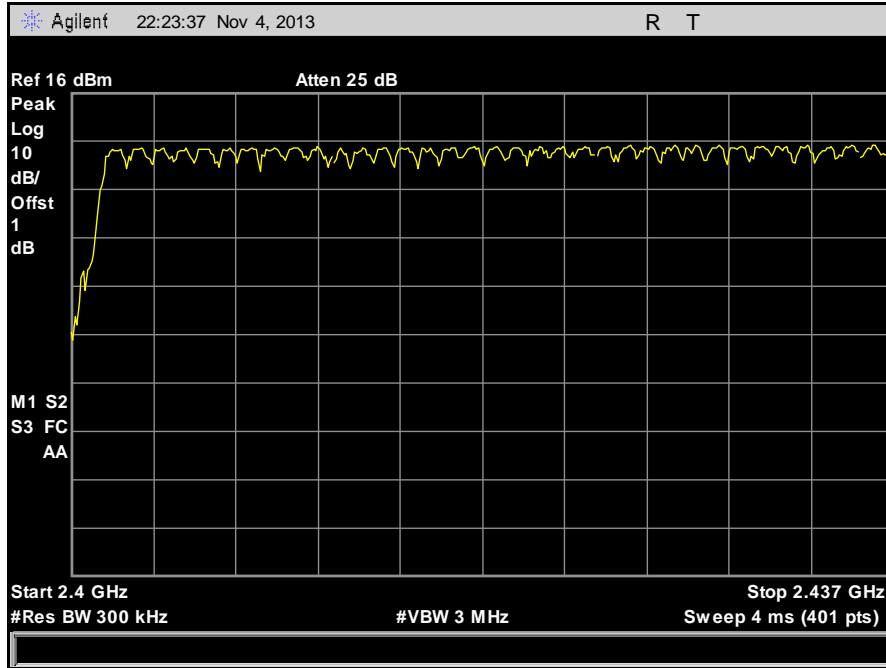

Plot 65. Number of Channels, Pi by 4 DQPSK, 2400 MHz – 2437 MHz

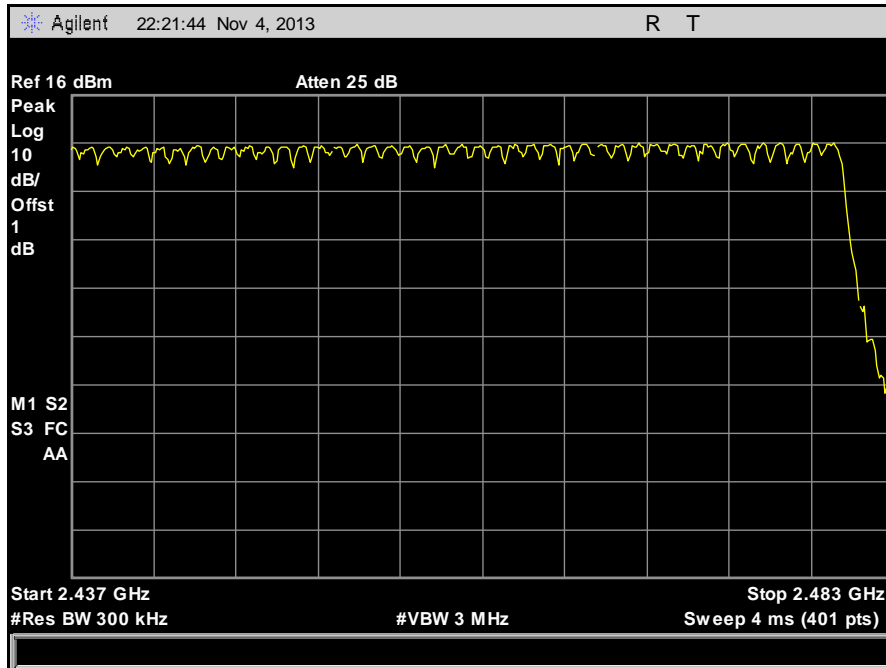

Plot 66. Number of Channels, Pi by 4 DQPSK, 2437 MHz – 2483.5 MHz

Electromagnetic Compatibility Criteria for Intentional Radiators

§ 15.247(a)(1) RF Channel Separation

Requirement: Frequency hopping systems shall have hopping channel carrier frequencies separated by a minimum of 25 kHz or the 20 dB bandwidth of the hopping channel, whichever is greater. Alternatively, frequency hopping systems operating in the 2400–2483.5 MHz band may have hopping channel carrier frequencies that are separated by 25 kHz or two-thirds of the 20 dB bandwidth of the hopping channel, whichever is greater, provided the systems operate with an output power no greater than 125 mW.

Remarks: EUT operates below 125mW (20dBm). Channels are separated by more than two thirds of the -20dB Bandwidth.

$$\text{EDR} - 2/3 * 1.393 \text{ MHz (20dB Bandwidth)} = 929 \text{ kHz Minimum Separation Distance}$$

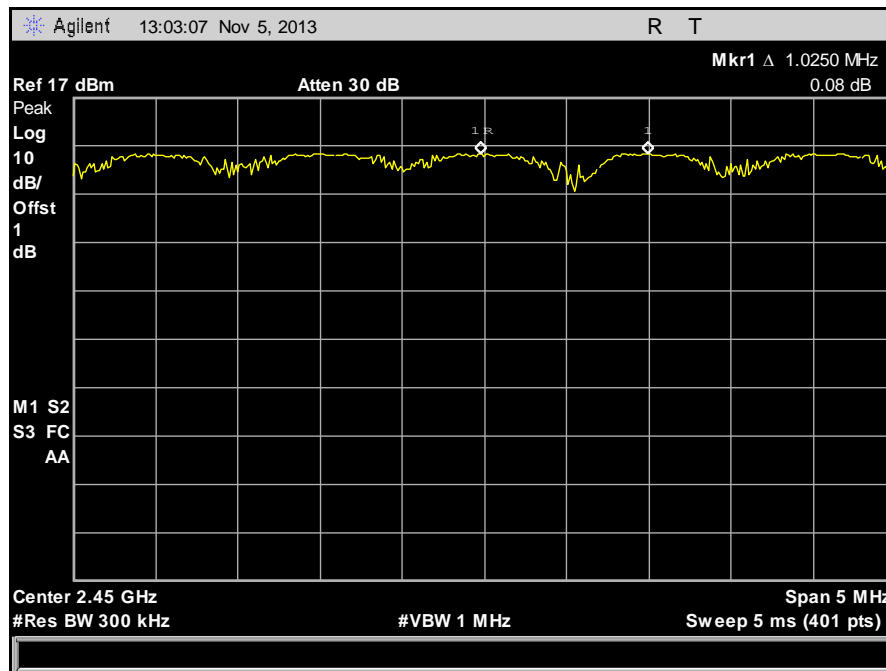

Plot 67. Channel Separation, 8DPSK

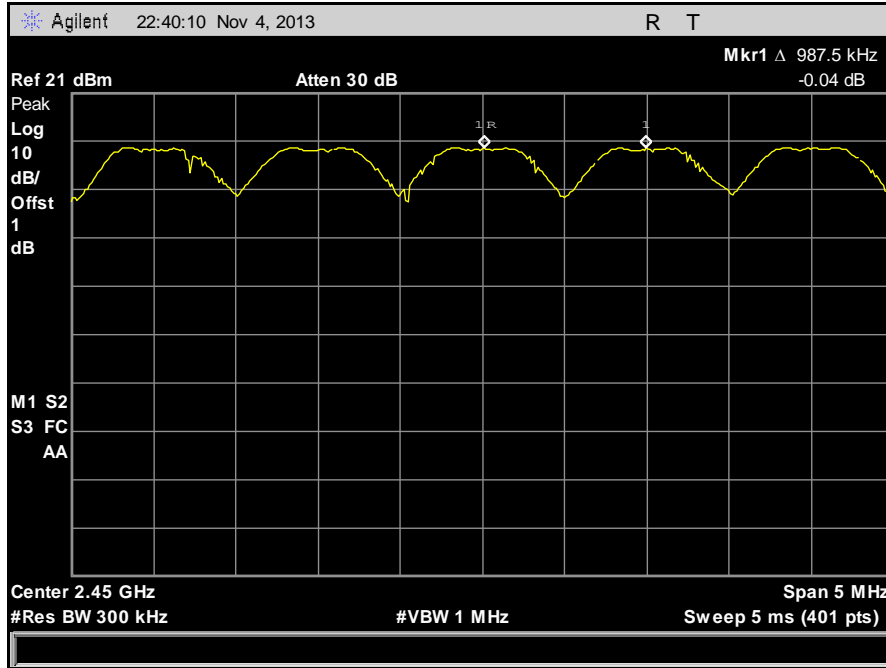

Plot 68. Channel Separation, GFSK

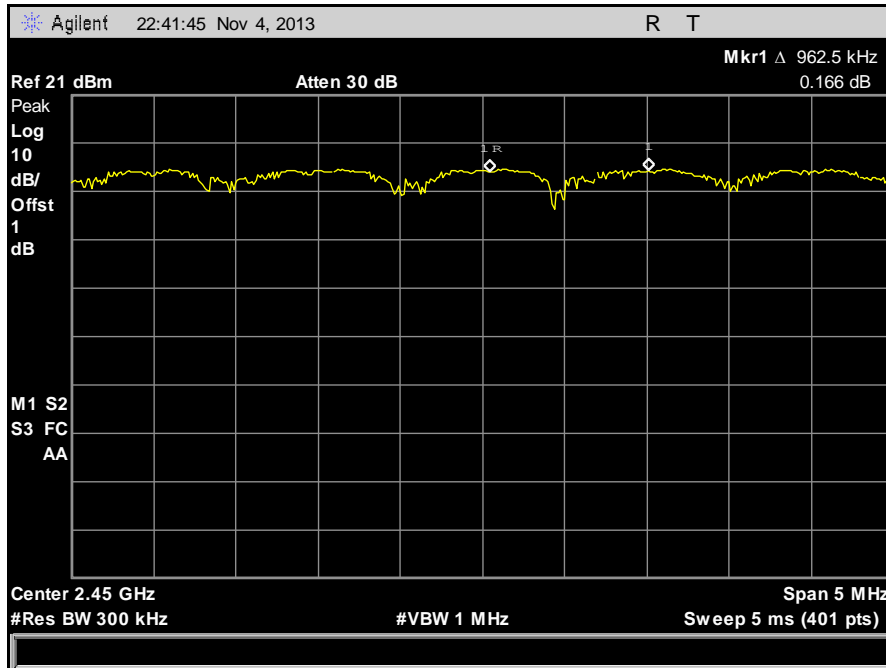

Plot 69. Channel Separation, Pi by 4 DQPSK

Electromagnetic Compatibility Criteria for Intentional Radiators

§ 15.247(b) Peak Power Output

Test Requirements: §15.247(b)(1): The maximum peak output power of the intentional radiator shall not exceed 0.125 Watts for frequency hopping systems operating in the 2400-2483.5 MHz band. .

§15.247(c): if transmitting antennas of directional gain greater than 6 dBi are used the peak output power from the intentional radiator shall be reduced below the stated values, as appropriate, by the amount in dB that the directional gain of the antenna exceeds 6 dBi.

Systems operating in the 2400 – 2483.5 MHz band and using a point to point application may employ transmitting antennas with directional gain greater than 6 dBi provided the maximum peak output power of the intentional radiator is reduced by 1 dB for every 3 dB that the directional gain of the antenna exceeds 6 dBi.

Systems operating in the 5725 – 5850 MHz band that are used exclusively for fixed, point-to-point operations may employ transmitting antennas with directional gain greater than 6 dBi without any corresponding reduction in transmitter peak output power.

Fixed, point-to-point operation excludes the use of point-to-multipoint systems, omnidirectional applications, and multiple co-located intentional radiators transmitting the same information. The operator of the spread spectrum intentional radiator or, if the equipment is professionally installed, the installer is responsible for ensuring that the system is used exclusively for fixed, point-to-point operations. The instruction manual furnished with the intentional radiator shall contain language in the installation instructions informing the operator and the installer of this responsibility.

Test Procedure: The transmitter was connected to a calibrated spectrum analyzer. The EUT was measured at the low, mid and high channels of each band. The EUT was utilizes a 3dBi Omni Antenna, so the maximum power allowed is 30dBm.

Test Results: The EUT was compliant with the Peak Power Output limits of §15.247(b).

Test Engineer(s): Shawn McMillen

Test Date(s): 11/06/13

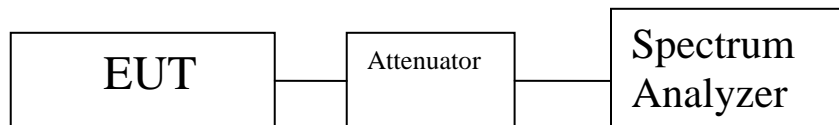

Figure 3. Peak Power Output Test Setup

Peak Conducted Output Power 8DPSK		
Carrier Channel	Frequency (MHz)	Measured Peak Output Power dBm
Low	2.402	7.929
Mid	2.441	8.588
High	2.48	8.538

Table 17. Peak Power Output, 8DPSK

Peak Conducted Output Power GFSK		
Carrier Channel	Frequency (MHz)	Measured Peak Output Power dBm
Low	2.402	8.989
Mid	2.441	9.577
High	2.48	9.41

Table 18. Peak Power Output, GFSK

Peak Conducted Output Power $\pi/4$ DQPSK		
Carrier Channel	Frequency (MHz)	Measured Peak Output Power dBm
Low	2.402	7.087
Mid	2.441	7.738
High	2.48	8.055

Table 19. Peak Power Output, $\pi/4$ DQPSK

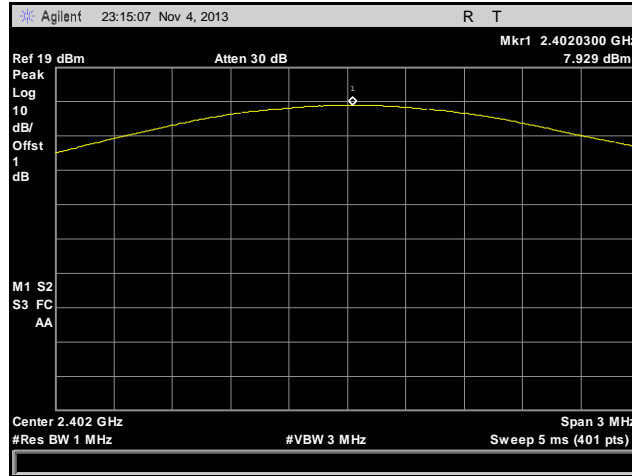

Plot 70. Peak Power Output, Low Channel, 8DPSK

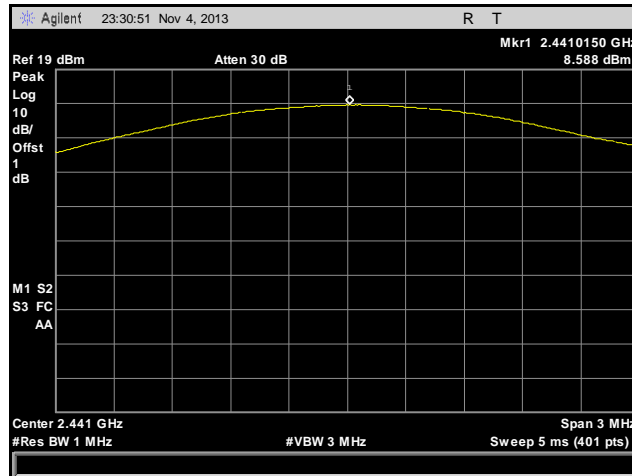

Plot 71. Peak Power Output, Mid Channel, 8DPSK

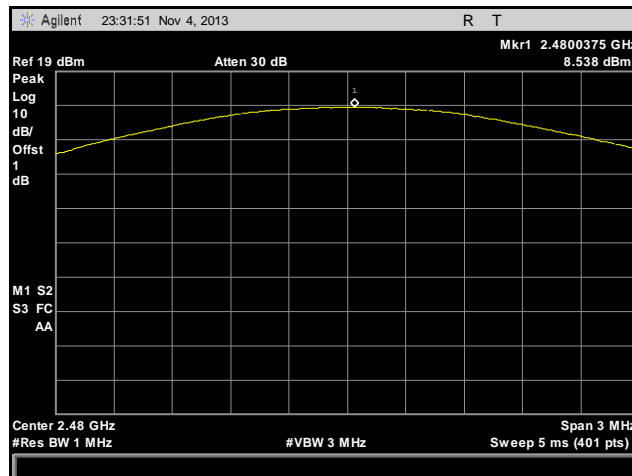

Plot 72. Peak Power Output, High Channel, 8DPSK

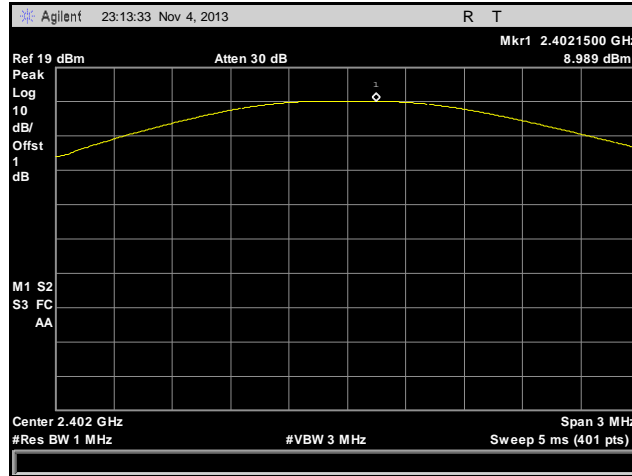

Plot 73. Peak Power Output, Low Channel, GFSK

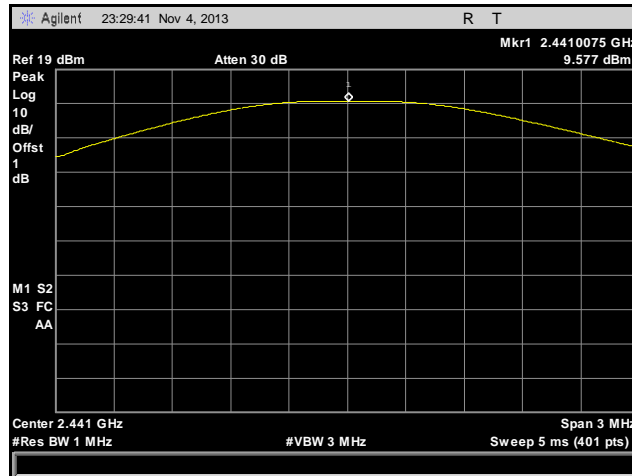

Plot 74. Peak Power Output, Mid Channel, GFSK

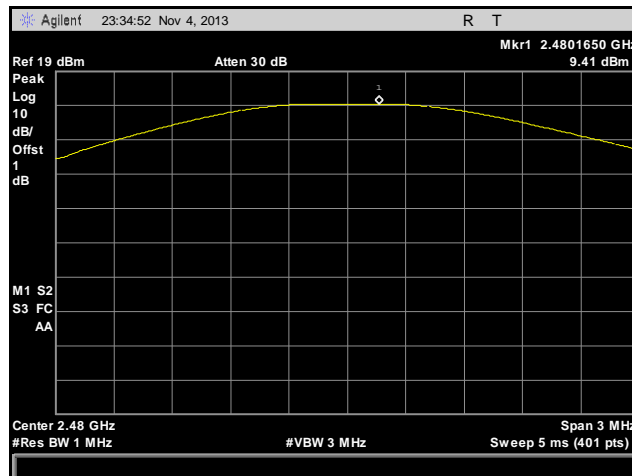

Plot 75. Peak Power Output, High Channel, GFSK

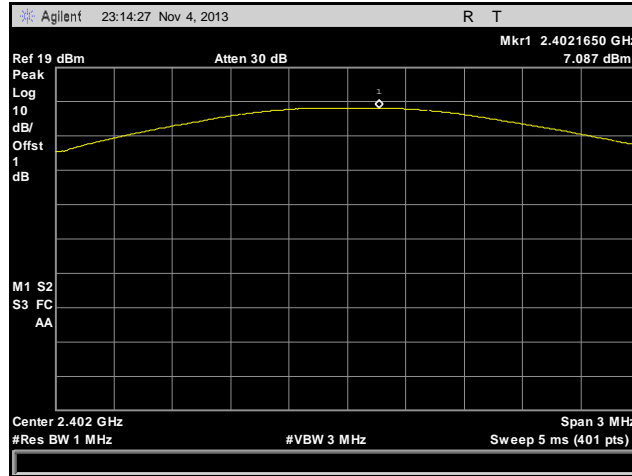

Plot 76. Peak Power Output, Low Channel, Pi by 4 DQPSK

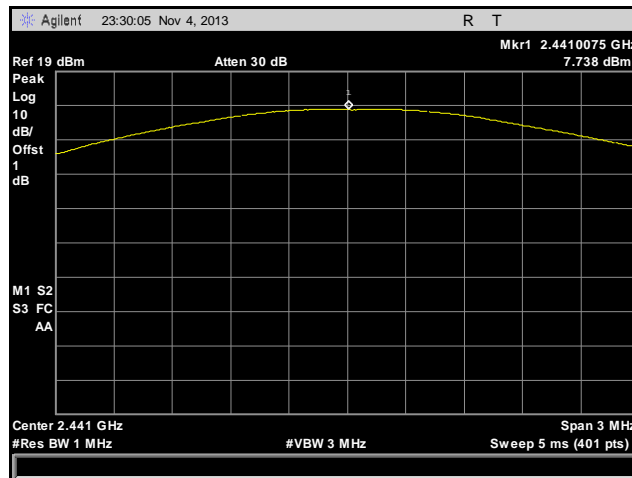

Plot 77. Peak Power Output, Mid Channel, Pi by 4 DQPSK

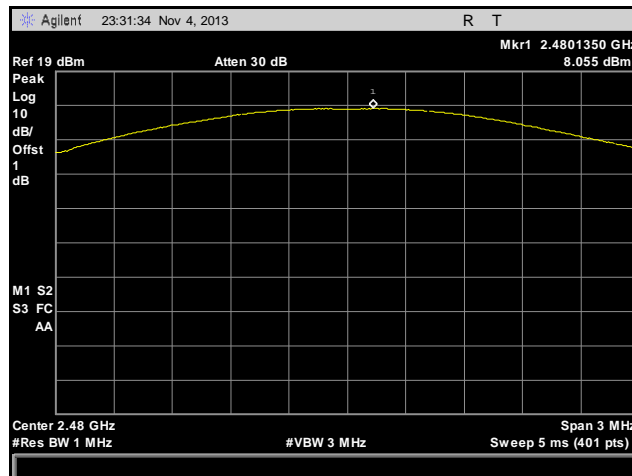

Plot 78. Peak Power Output, High Channel, Pi by 4 DQPSK

Electromagnetic Compatibility Criteria for Intentional Radiators

§ 15.247(d) Radiated Spurious Emissions Requirements and Band Edge

Test Requirements: §15.247(d); §15.205: Emissions outside the frequency band.

§15.247(d): In any 100 kHz bandwidth outside the frequency band in which the spread spectrum or digitally modulated intentional radiator is operating, the radio frequency power that is produced by the intentional radiator shall be at least 20 dB below that in the 100 kHz bandwidth within the band that contains the highest level of the desired power, based on either an RF conducted or a radiated measurement. Attenuation below the general limits specified in § 15.209(a) is not required. In addition, radiated emissions which fall in the restricted bands, as defined in § 15.205(a), must also comply with the radiated emission limits specified in § 15.209(a).

§15.205(a): Except as shown in paragraph (d) of this section, only spurious emissions are permitted in any of the frequency bands listed below:

MHz	MHz	MHz	GHz
0.090–0.110-----	16.42–16.423	399.9–410	4.5–5.15
¹ 0.495–0.505-----	16.69475–16.69525	608–614	5.35–5.46
2.1735–2.1905-----	16.80425–16.80475	960–1240	7.25–7.75
4.125–4.128-----	25.5–25.67	1300–1427	8.025–8.5
4.17725–4.17775-----	37.5–38.25	1435–1626.5	9.0–9.2
4.20725–4.20775-----	73–74.6	1645.5–1646.5	9.3–9.5
6.215–6.218-----	74.8–75.2	1660–1710	10.6–12.7
6.26775–6.26825-----	108–121.94	1718.8–1722.2	13.25–13.4
6.31175–6.31225-----	123–138	2200–2300	14.47–14.5
8.291–8.294-----	149.9–150.05	2310–2390	15.35–16.2
8.362–8.366-----	156.52475–156.52525	2483.5–2500	17.7–21.4
8.37625–8.38675-----	156.7–156.9	2655–2900	22.01–23.12
8.41425–8.41475-----	162.0125–167.17	3260–3267	23.6–24.0
12.29–12.293-----	167.72–173.2	3332–3339	31.2–31.8
12.51975–12.52025-----	240–285	3345.8–3358.36	43–36.5
12.57675–12.57725-----	322–335.4	3600–4400	(²)

Table 20. Restricted Bands of Operation

¹ Until February 1, 1999, this restricted band shall be 0.490 – 0.510 MHz.

² Above 38.6

Test Requirement(s): § 15.209 (a): Except as provided elsewhere in this subpart, the emissions from an intentional radiator shall not exceed the field strength levels specified in Table 21.

Frequency (MHz)	§ 15.209(a), Radiated Emission Limits (dBµV) @ 3m
30 - 88	40.00
88 - 216	43.50
216 - 960	46.00
Above 960	54.00

Table 21. Radiated Emissions Limits Calculated from FCC Part 15, § 15.209 (a)

Test Procedure: The transmitter was set to the mid channel at the highest output power and placed on a 0.8 m high wooden table inside in a semi-anechoic chamber. Measurements were performed with the EUT rotated 360 degrees and varying the adjustable antenna mast with 1 m to 4 m height to determine worst case orientation for maximum emissions. Measurement were repeated the measurement at the low and highest channels.

For frequencies from 30 MHz to 1 GHz, measurements were made using a quasi-peak detector with a 120 kHz bandwidth.

For intentional radiators with a digital device portion which operates below 10 GHz, the spectrum was investigated as per §15.33(a)(1) and §15.33(a)(4); i.e., the lowest RF signal generated or used in the device up to the 10th harmonic of the highest fundamental frequency or to 40 GHz, whichever is lower.

In accordance with §15.35(b) the limit on the radio frequency emissions as measured using instrumentation with a peak detector function shall be 20 dB above the maximum permitted average limit for the frequency being investigated unless a different peak emission limit is otherwise specified in the rules.

EUT Field Strength Final Amplitude = Raw Amplitude – Preamp gain + Antenna Factor + Cable Loss – Distance Correction Factor

Test Results: The EUT was compliant with the Radiated Spurious Emission limits of §15.247(d).

Test Engineer(s): Surinder Singh

Test Date(s): 11/23/13

Radiated Spurious Emissions Test Results

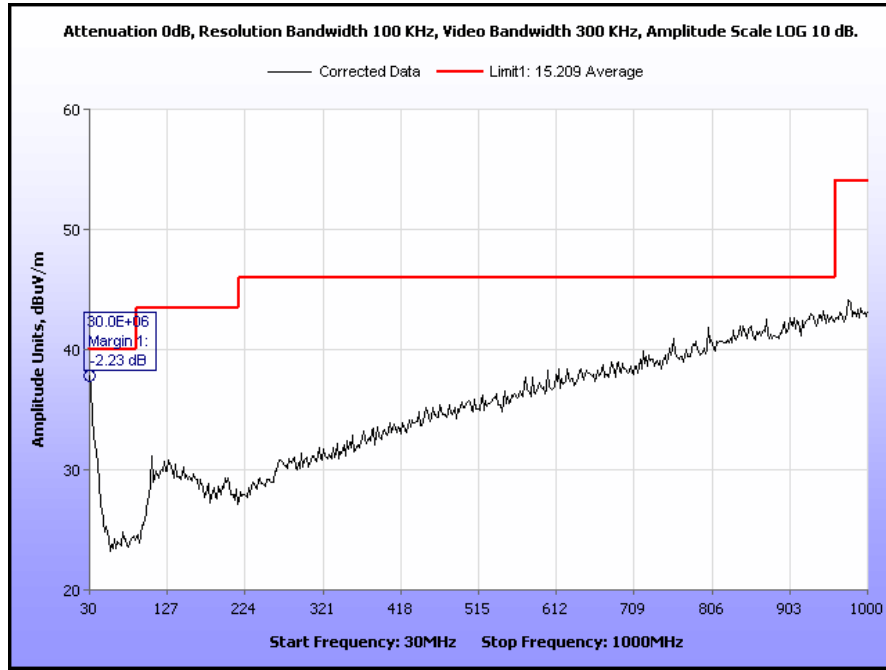

Plot 79. Radiated Spurious Emissions, DH1, Hopping Channel, 8DPSK, 30 MHz – 1 GHz

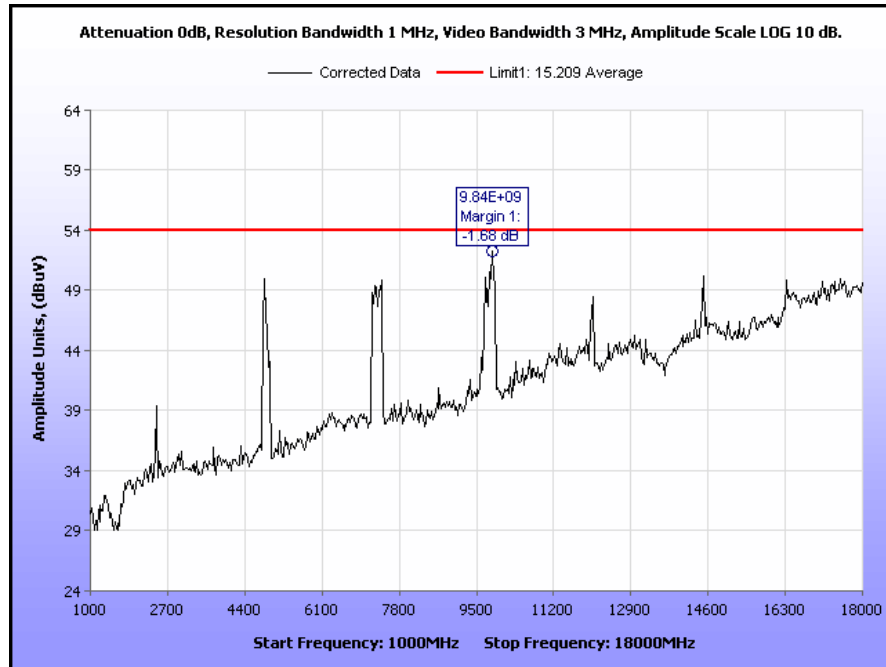

Plot 80. Radiated Spurious Emissions, DH1, Hopping Channel, 8DPSK, 1 GHz – 18 GHz

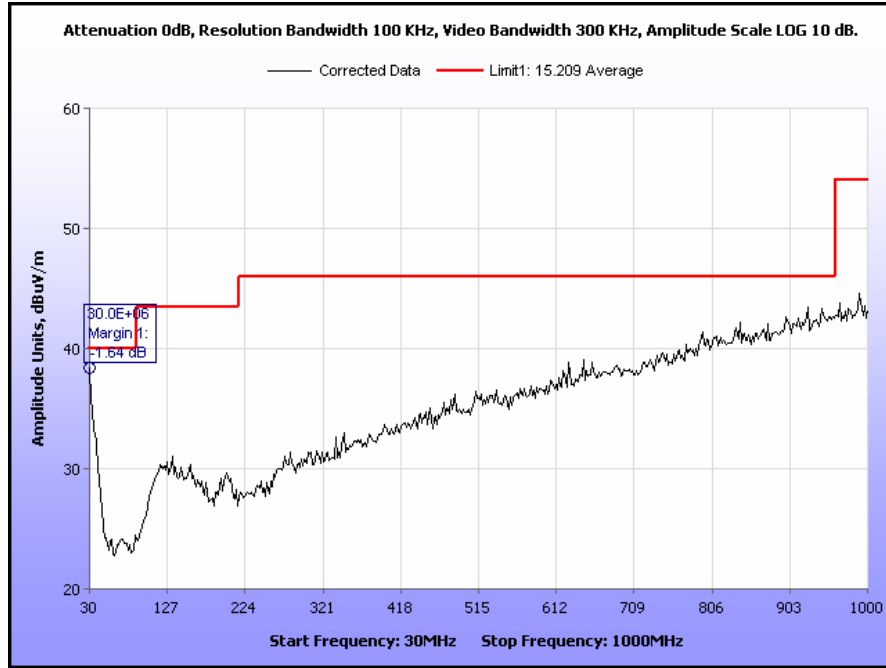

Plot 81. Radiated Spurious Emissions, Low Channel, 8DPSK, 30 MHz – 1 GHz

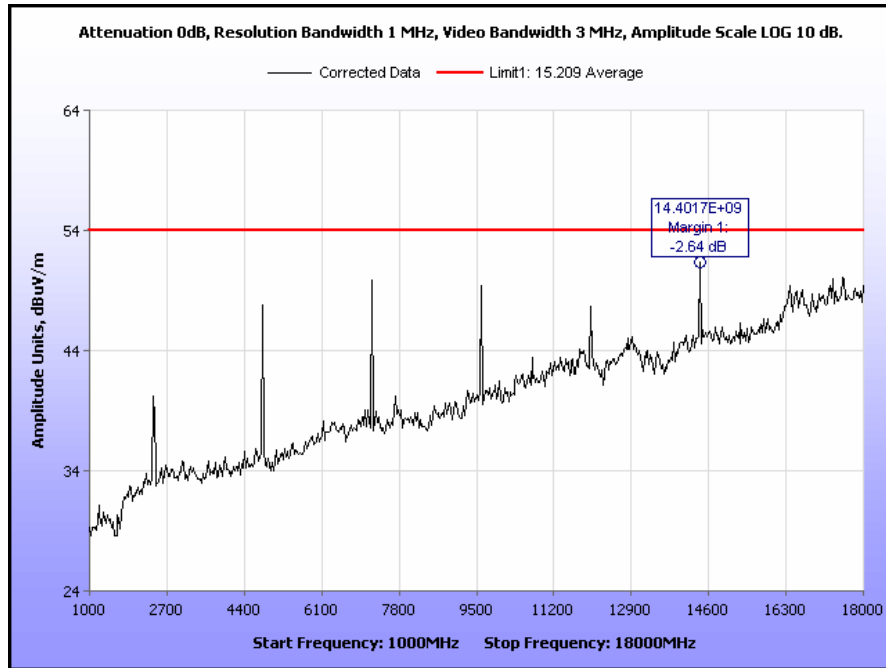

Plot 82. Radiated Spurious Emissions, Low Channel, 8DPSK, 1 GHz – 18 GHz

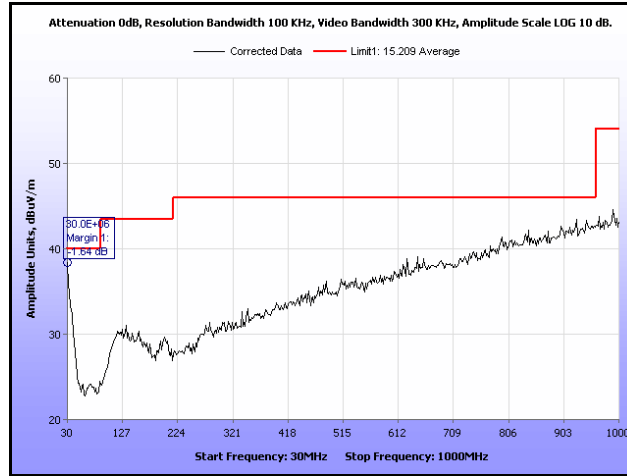

Plot 83. Radiated Spurious Emissions, Mid Channel, 8DPSK, 30 MHz – 1 GHz

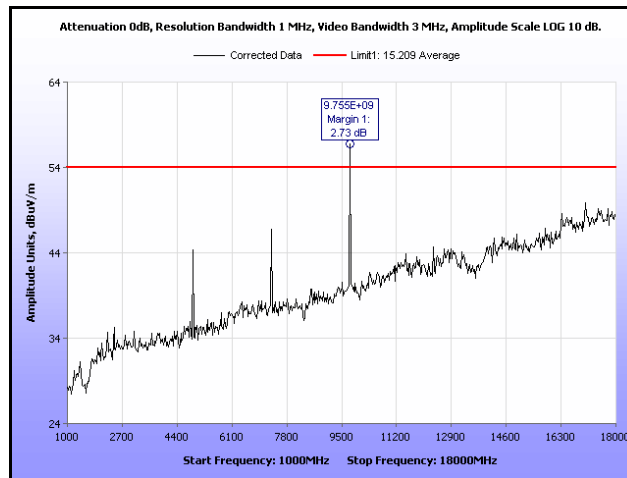

Plot 84. Radiated Spurious Emissions, Mid Channel, 8DPSK, 1 GHz – 18 GHz

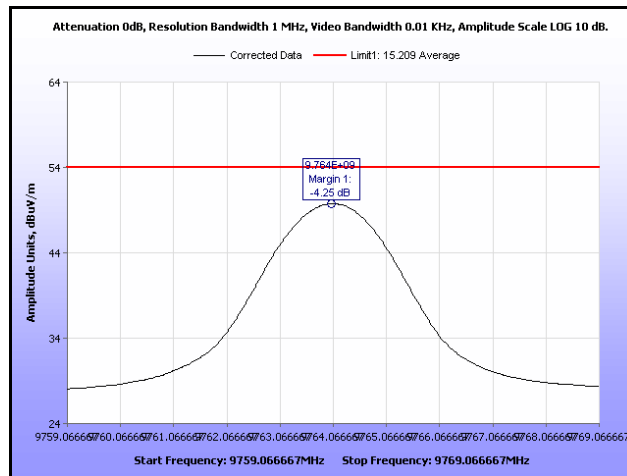

Plot 85. Radiated Spurious Emissions, Mid Channel, 8DPSK, 9.764 GHz

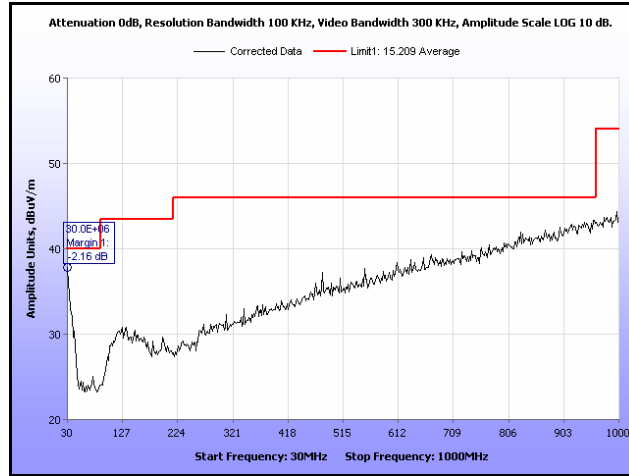

Plot 86. Radiated Spurious Emissions, High Channel, 8DPSK, 30 MHz – 1 GHz

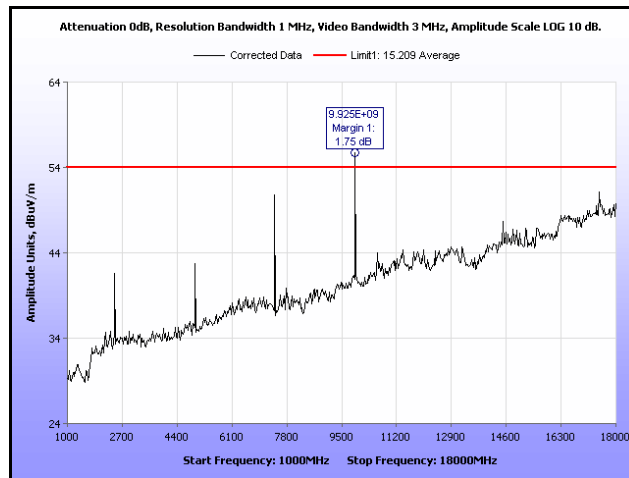

Plot 87. Radiated Spurious Emissions, High Channel, 8DPSK, 1 GHz – 18 GHz

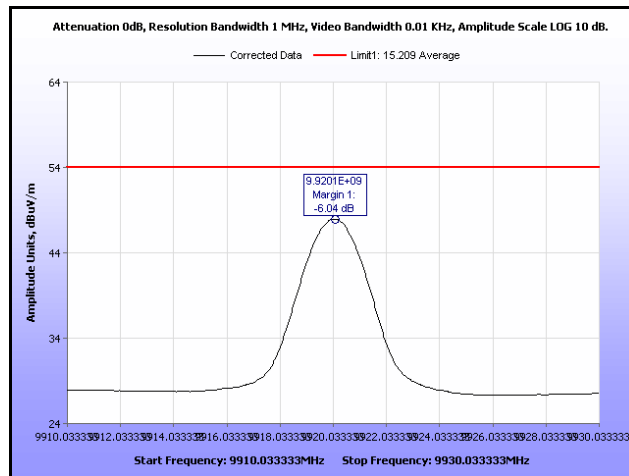

Plot 88. Radiated Spurious Emissions, High Channel, 8DPSK, 9.92 GHz

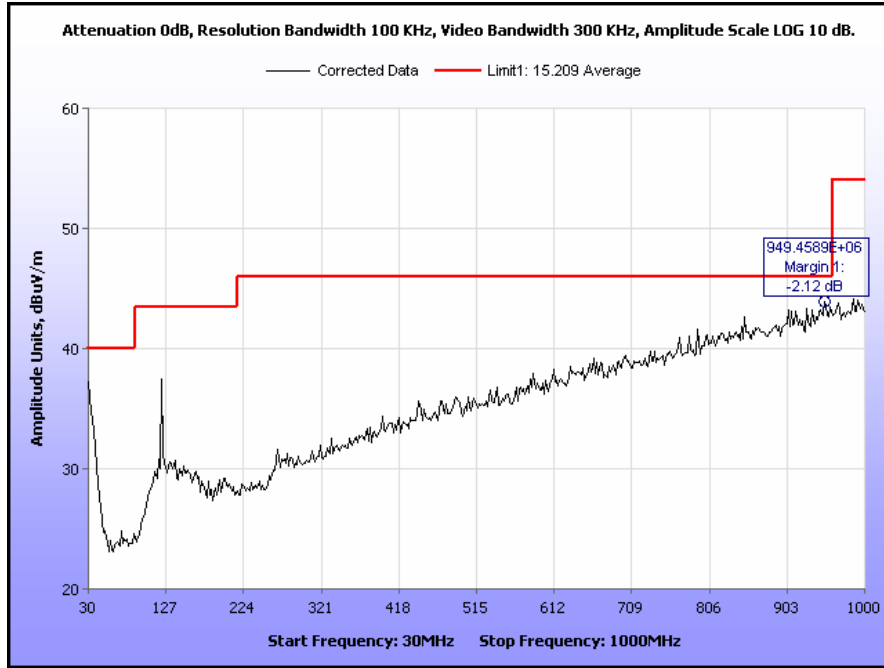

Plot 89. Radiated Spurious Emissions, DH1, Hopping Channel, GFSK, 30 MHz – 1 GHz

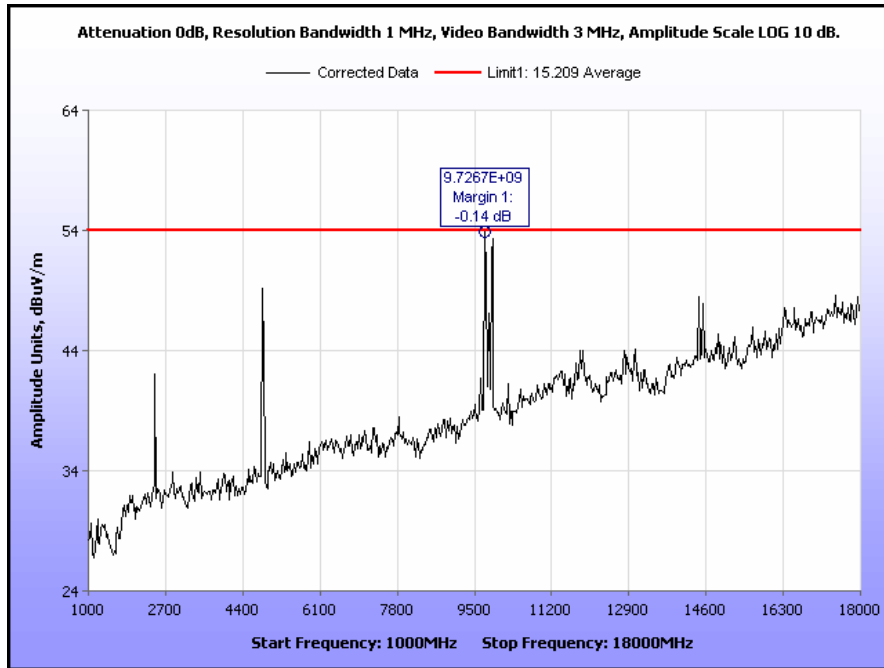

Plot 90. Radiated Spurious Emissions, DH1, Hopping Channel, GFSK, 1 GHz – 18 GHz

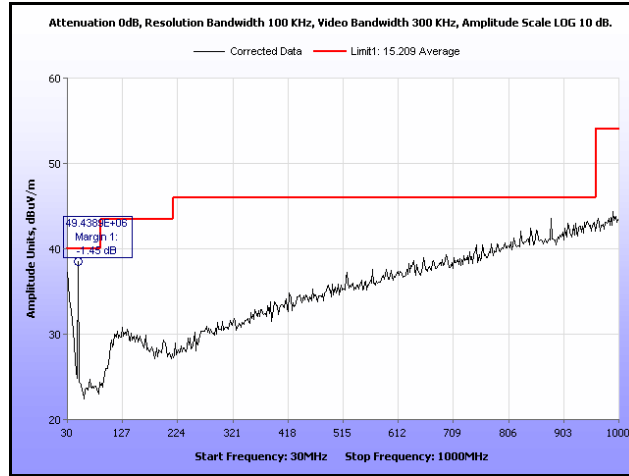

Plot 91. Radiated Spurious Emissions, Low Channel, GFSK, 30 MHz – 1 GHz

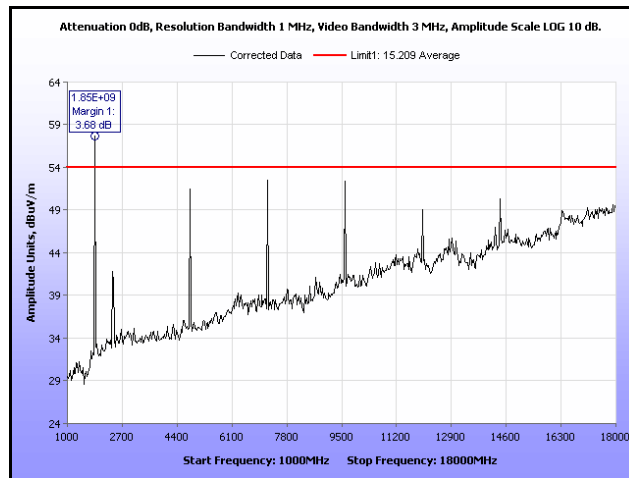

Plot 92. Radiated Spurious Emissions, Low Channel, GFSK, 1 GHz – 18 GHz

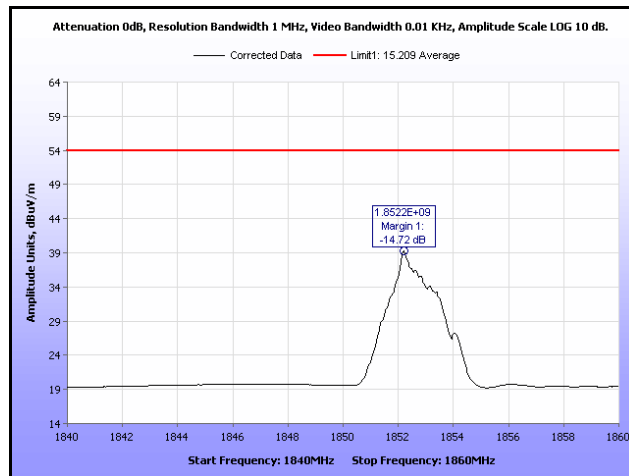

Plot 93. Radiated Spurious Emissions, Low Channel, GFSK, 1.852 GHz

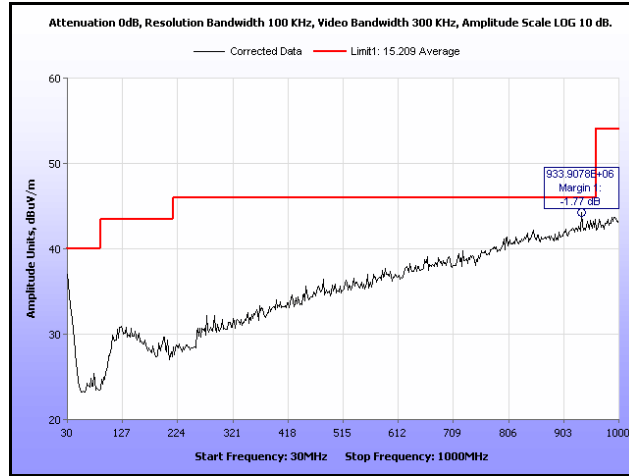

Plot 94. Radiated Spurious Emissions, Mid Channel, GFSK, 30 MHz – 1 GHz

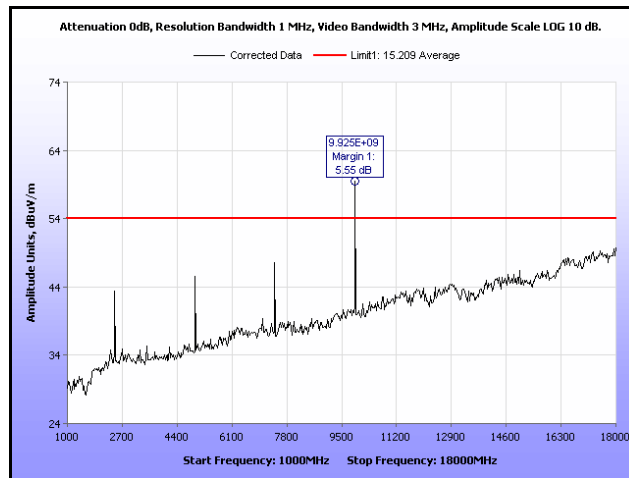

Plot 95. Radiated Spurious Emissions, Mid Channel, GFSK, 1 GHz – 18 GHz

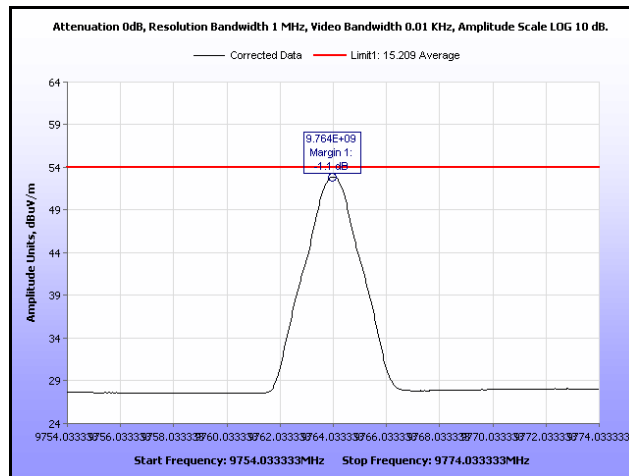

Plot 96. Radiated Spurious Emissions, Mid Channel, GFSK, 9.764 GHz

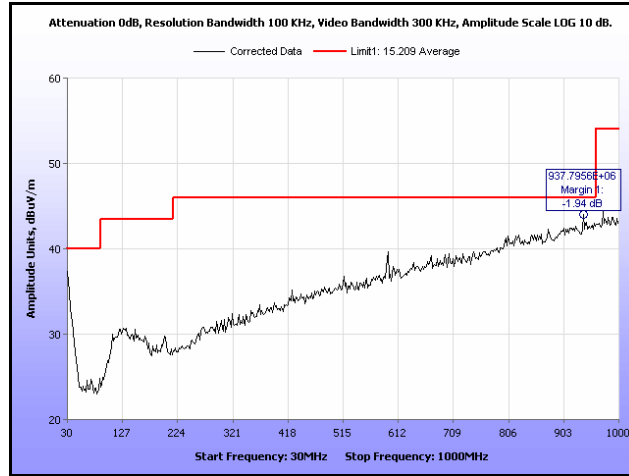

Plot 97. Radiated Spurious Emissions, High Channel, GFSK, 30 MHz – 1 GHz

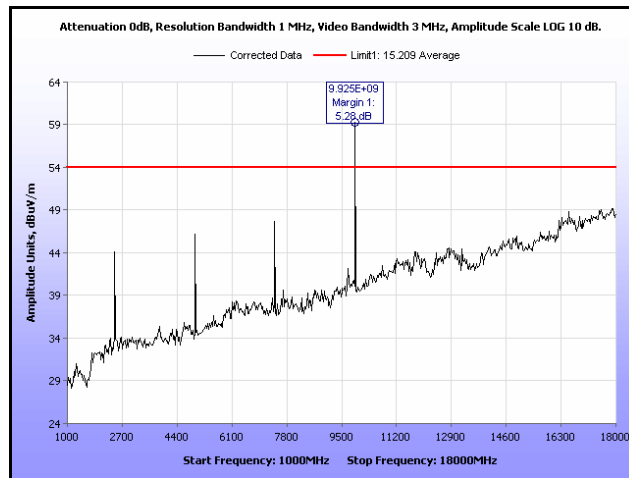

Plot 98. Radiated Spurious Emissions, High Channel, GFSK, 1 GHz – 18 GHz

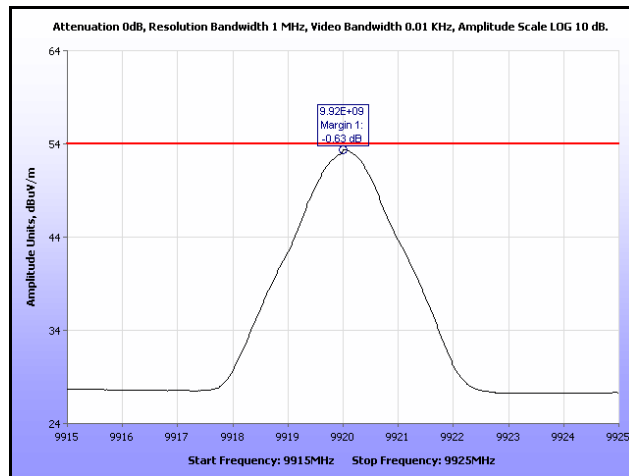

Plot 99. Radiated Spurious Emissions, High Channel, GFSK, 9.92 GHz

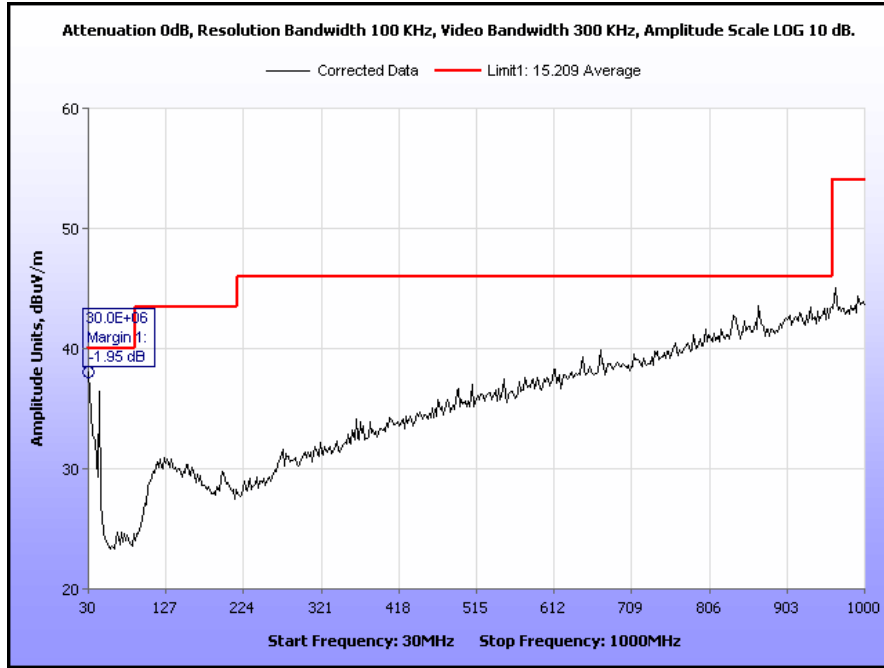

Plot 100. Radiated Spurious Emissions, DH1, Hopping Channel, Pi by 4 DQPSK, 30 MHz – 1 GHz

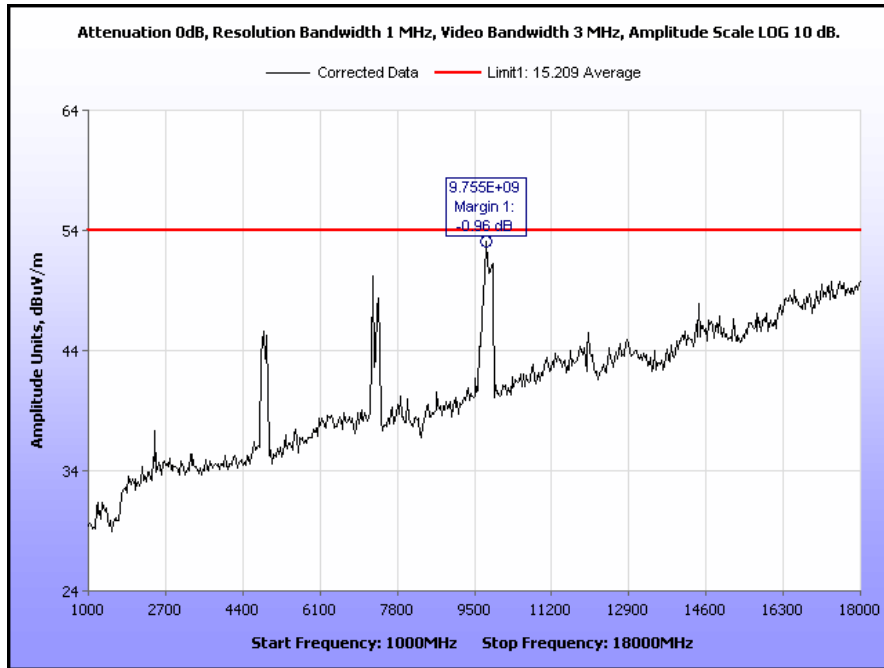

Plot 101. Radiated Spurious Emissions, DH1, Hopping Channel, Pi by 4 DQPSK, 1 GHz – 18 GHz

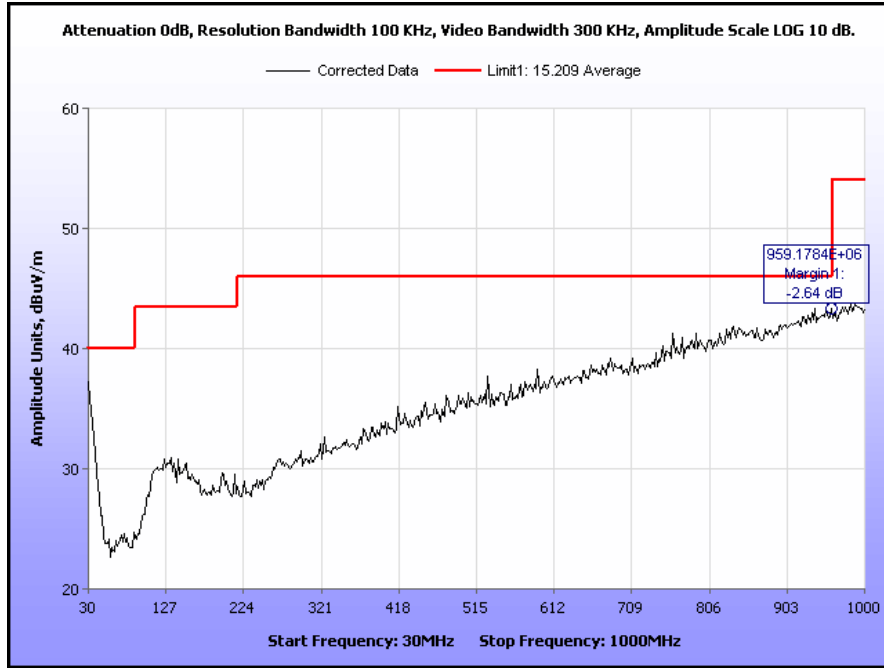

Plot 102. Radiated Spurious Emissions, Low Channel, Pi by 4 DQPSK, 30 MHz – 1 GHz

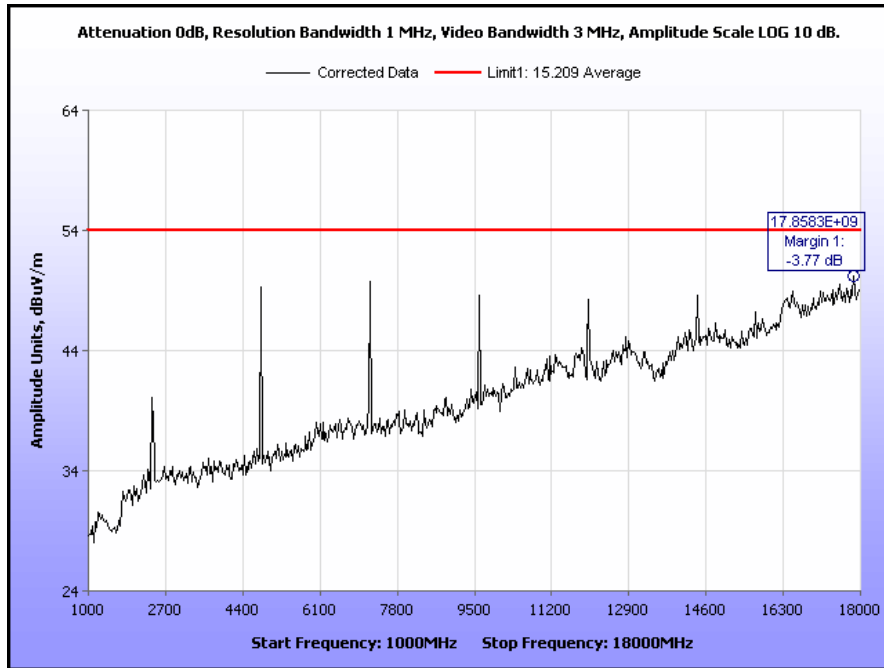

Plot 103. Radiated Spurious Emissions, Low Channel, Pi by 4 DQPSK, 1 GHz – 18 GHz

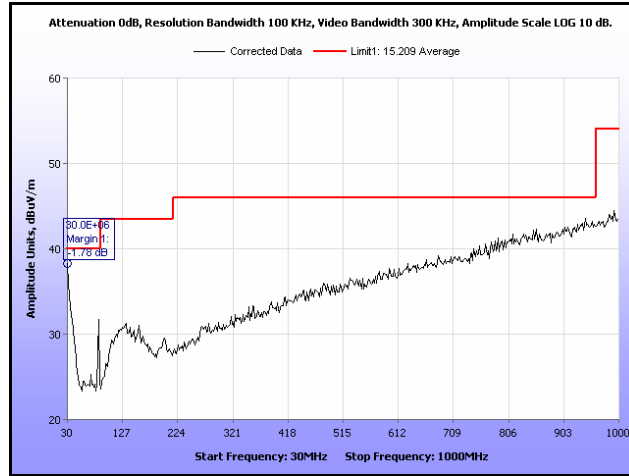

Plot 104. Radiated Spurious Emissions, Mid Channel, Pi by 4 DQPSK, 30 MHz – 1 GHz

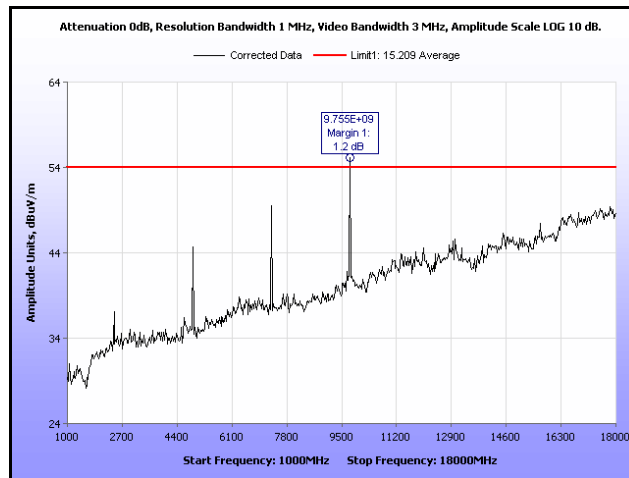

Plot 105. Radiated Spurious Emissions, Mid Channel, Pi by 4 DQPSK, 1 GHz – 18 GHz

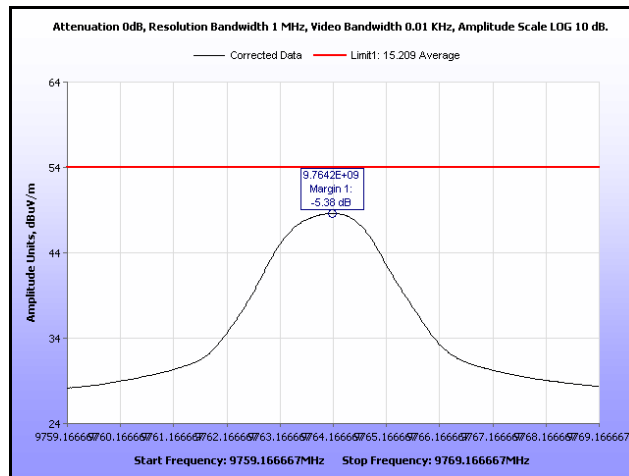

Plot 106. Radiated Spurious Emissions, Mid Channel, Pi by 4 DQPSK, 9.764 GHz

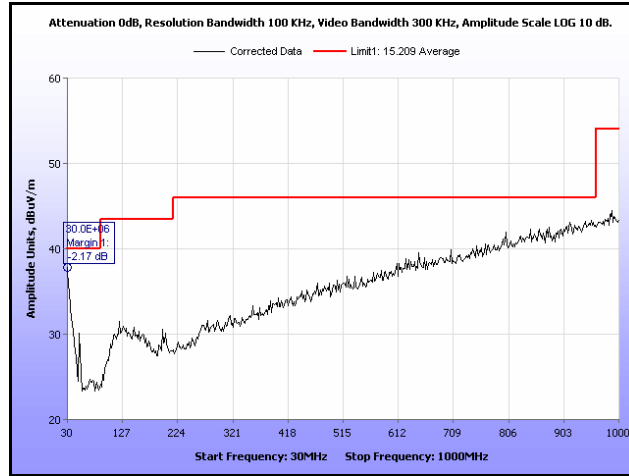

Plot 107. Radiated Spurious Emissions, High Channel, Pi by 4 DQPSK, 30 MHz – 1 GHz

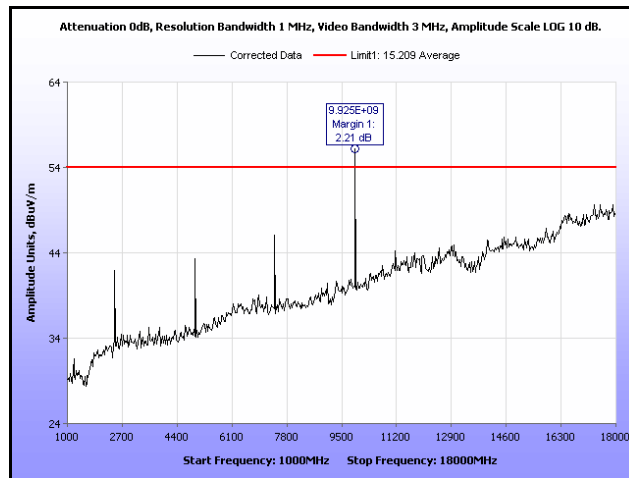

Plot 108. Radiated Spurious Emissions, High Channel, Pi by 4 DQPSK, 1 GHz – 18 GHz

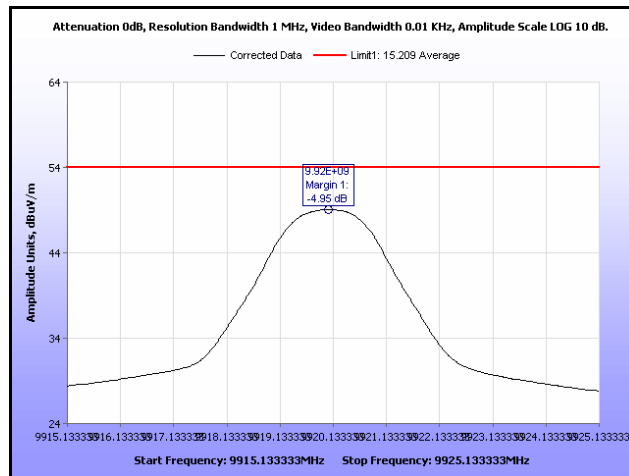

Plot 109. Radiated Spurious Emissions, High Channel, Pi by 4 DQPSK, 9.92 GHz

Radiated Band Edge Measurements

Test Procedures: The transmitter was turned. Measurements were performed of the low and high Channels. The EUT was rotated orthogonally through all three axes. Plots shown are corrected for both antenna correction factor and distance.

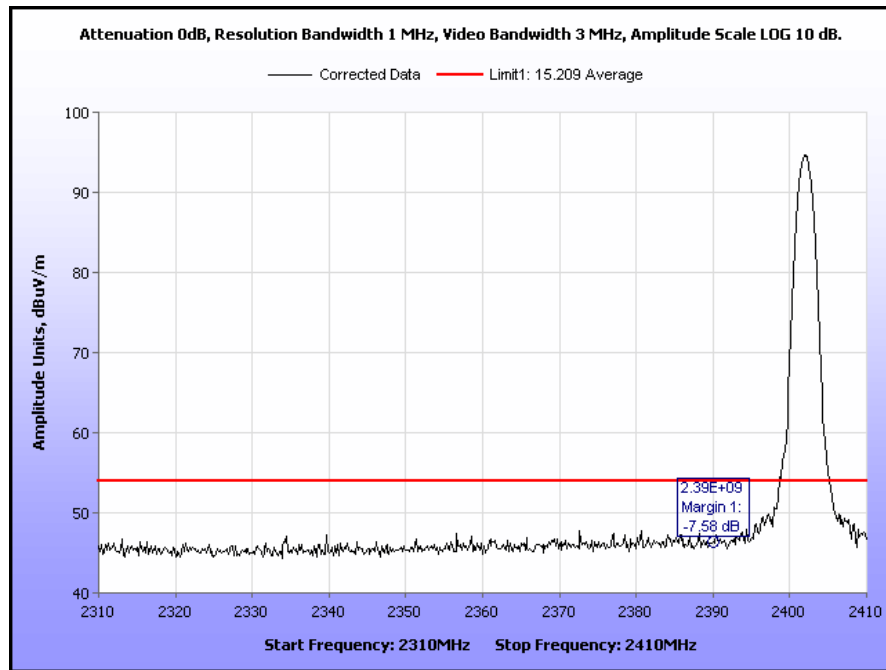

Plot 110. Radiated Restricted Band Edge, Low Channel, 8DPSK

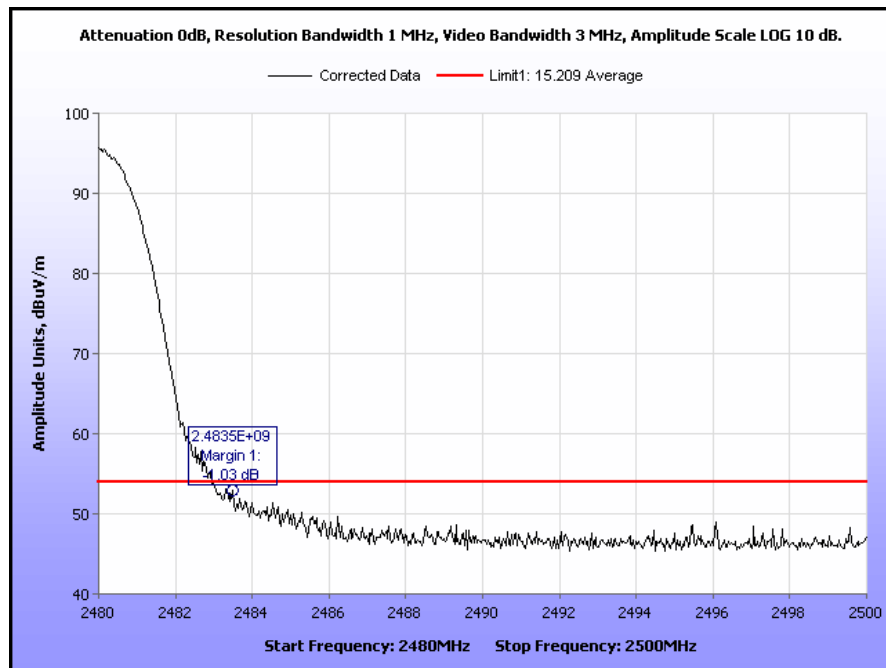

Plot 111. Radiated Restricted Band Edge, High Channel, 8DPSK

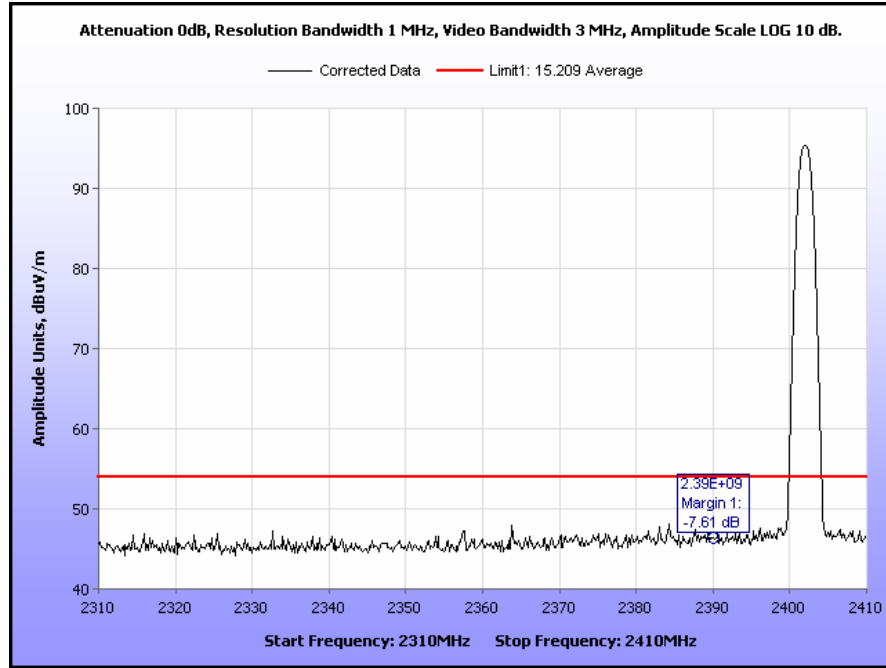

Plot 112. Radiated Restricted Band Edge, Low Channel, GFSK

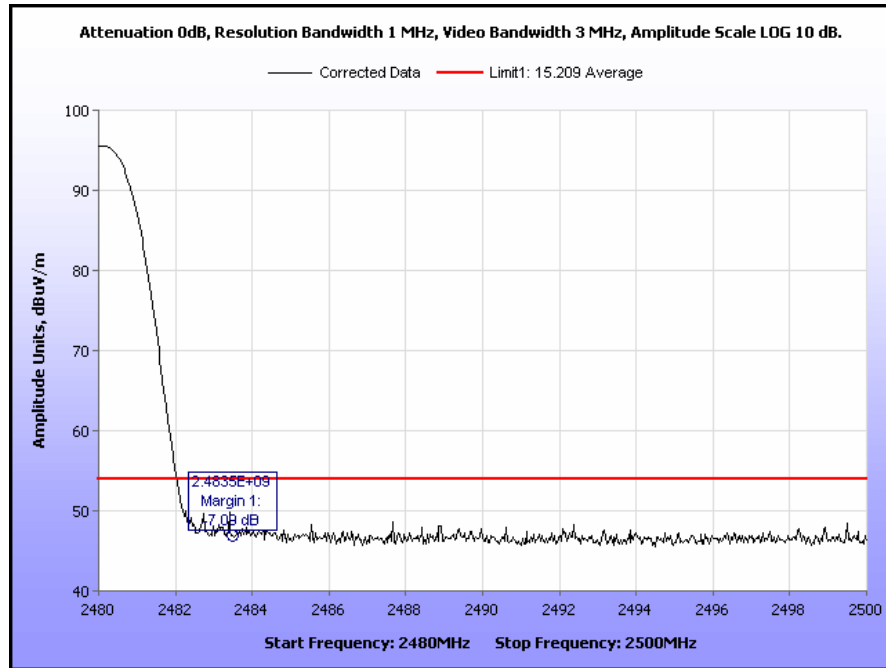

Plot 113. Radiated Restricted Band Edge, High Channel, GFSK

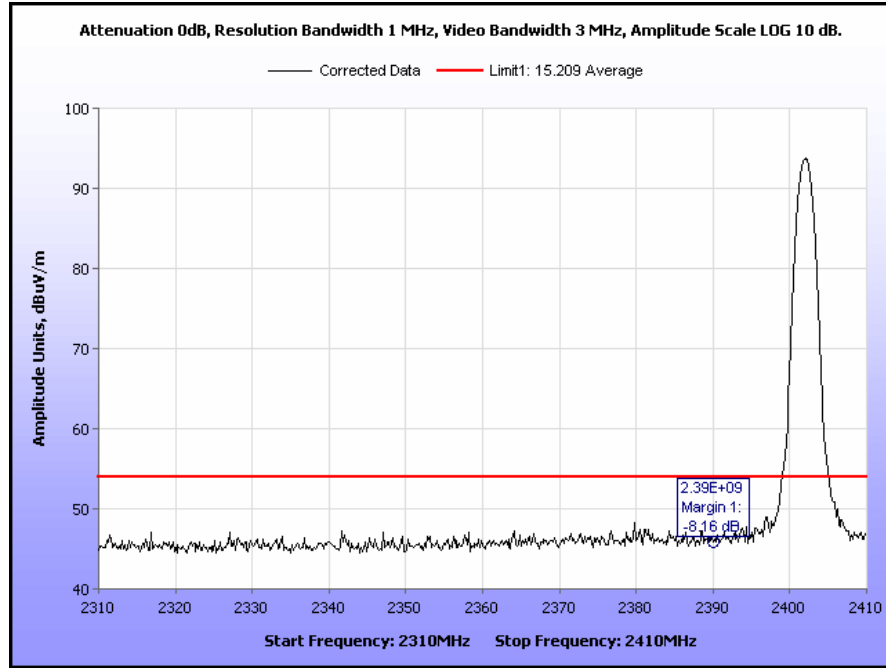

Plot 114. Radiated Restricted Band Edge, Low Channel, Pi by 4 DQPSK

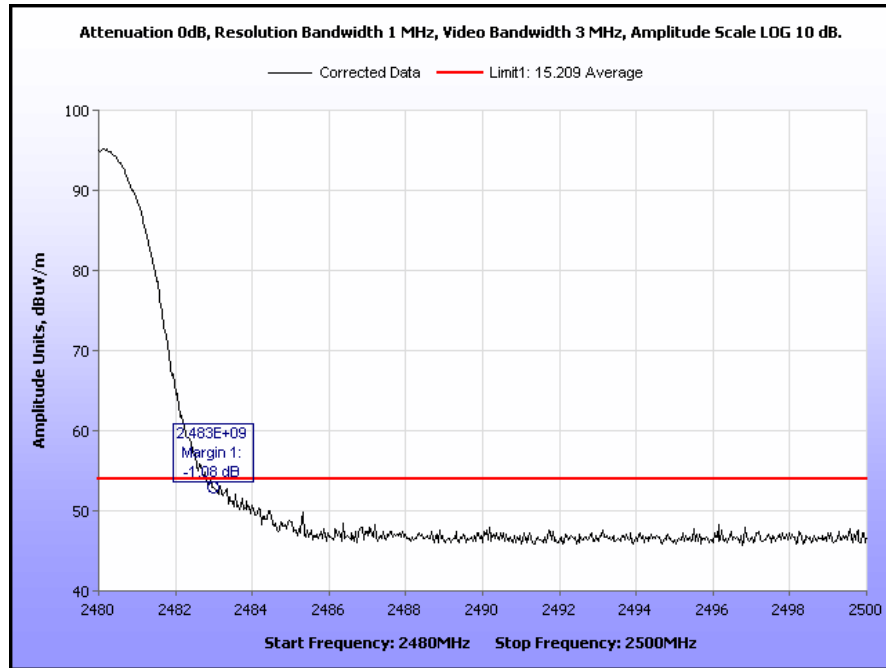

Plot 115. Radiated Restricted Band Edge, High Channel, Pi by 4 DQPSK

Electromagnetic Compatibility Criteria for Intentional Radiators

§ 15.247(d) RF Conducted Spurious Emissions Requirements and Band Edge

Test Requirement: **15.247(d)** In any 100 kHz bandwidth outside the frequency band in which the spread spectrum or digitally modulated intentional radiator is operating, the radio frequency power that is produced by the intentional radiator shall be at least 20 dB below that in the 100 kHz bandwidth within the band that contains the highest level of the desired power, based on either an RF conducted or a radiated measurement, provided the transmitter demonstrates compliance with the peak conducted power limits. If the transmitter complies with the conducted power limits based on the use of RMS averaging over a time interval, as permitted under paragraph (b)(3) of this section, the attenuation required under this paragraph shall be 30 dB instead of 20 dB.

Test Procedure: For intentional radiators with a digital device portion which operates below 10 GHz, the spectrum was investigated as per §15.33(a)(1) and §15.33(a)(4); i.e., the lowest RF signal generated or used in the device up to the 10th harmonic of the highest fundamental frequency or to 40 GHz, whichever is lower.

Since the EUT had an integral antenna, conducted measurements could not be performed. Measurements needed to be taken radiated. An antenna was located 3 m away from the EUT and plots were taken. The EUT was rotated through all three orthogonal axes. The plots were corrected for both antenna correction factor and cable loss.

See following pages for detailed test results with RF Conducted Spurious Emissions.

Test Results: The EUT was compliant with the Conducted Spurious Emission limits of §15.247(d).

Test Engineer(s): Surinder Singh

Test Date(s): 11/27/13

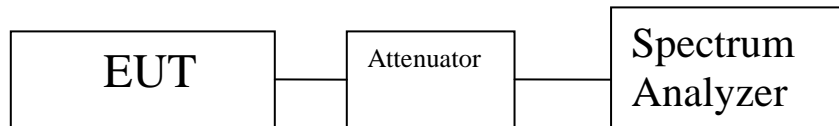
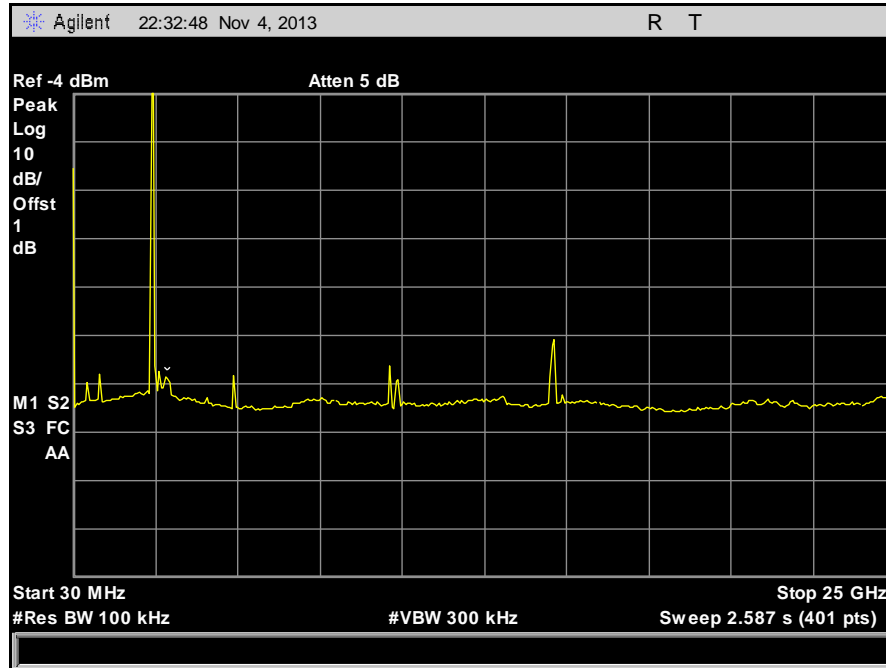
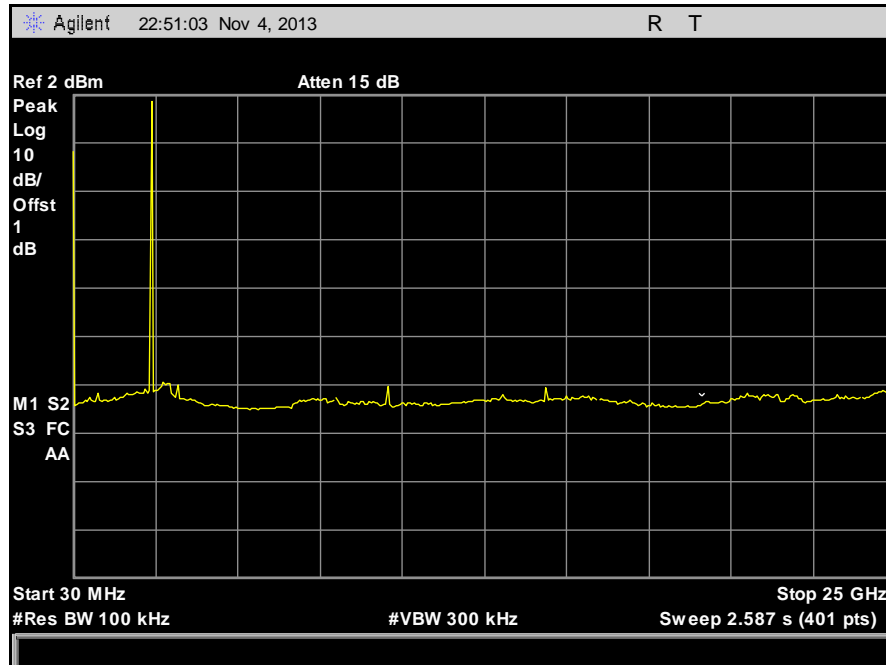

Figure 4. Block Diagram, Conducted Spurious Emissions Test Setup

Conducted Spurious Emissions Test Results



Plot 116. Conducted Spurious Emissions, 8DPSK, 30 MHz – 25 GHz, Hopping Mode



Plot 117. Conducted Spurious Emissions, 8DPSK, 30 MHz – 25 GHz, Low Channel

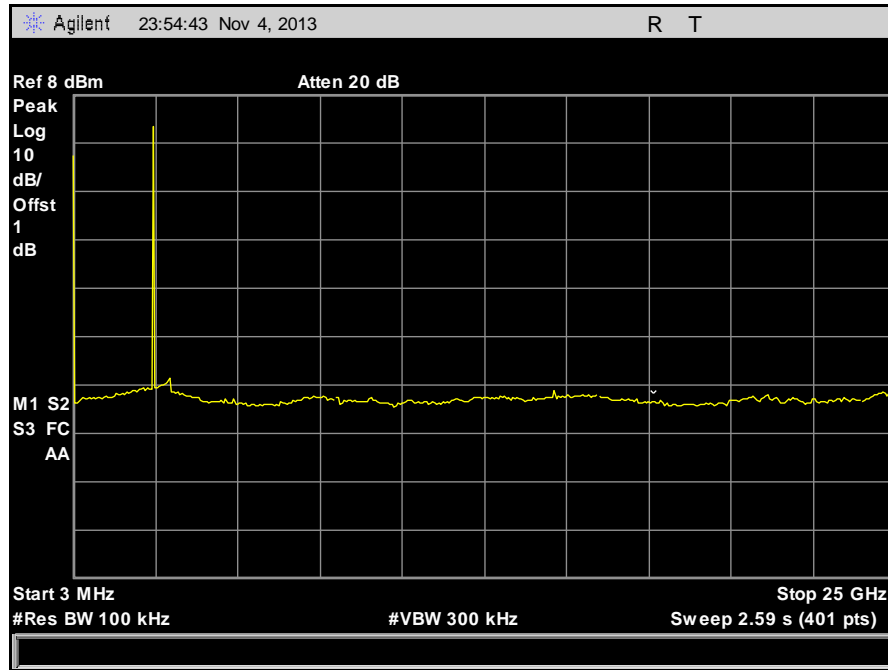

Plot 118. Conducted Spurious Emissions, 8DPSK, 30 MHz – 25 GHz, Mid Channel

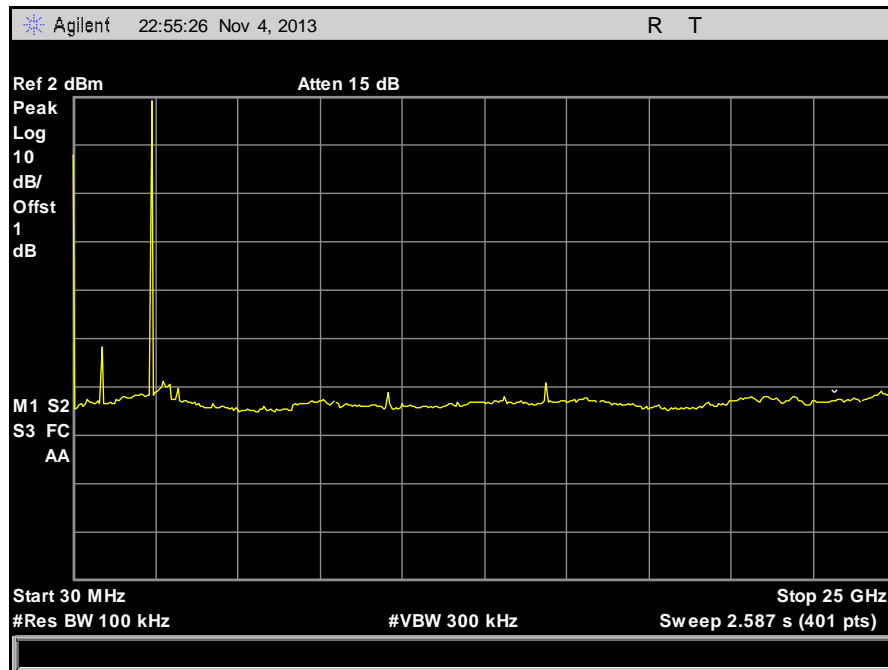

Plot 119. Conducted Spurious Emissions, 8DPSK, 30 MHz – 25 GHz, High Channel

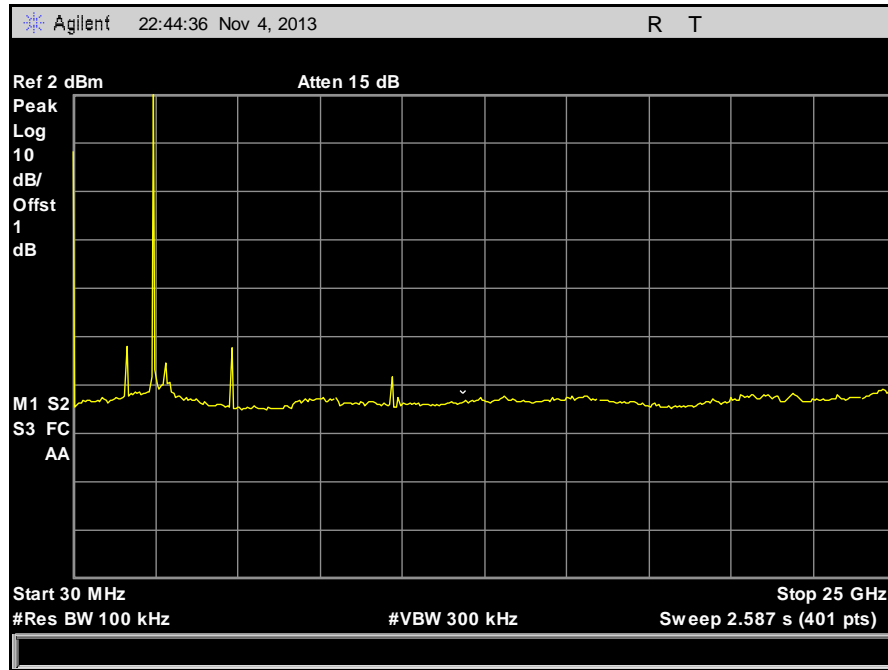

Plot 120. Conducted Spurious Emissions, GFSK, 30 MHz – 25 GHz, Hopping Mode

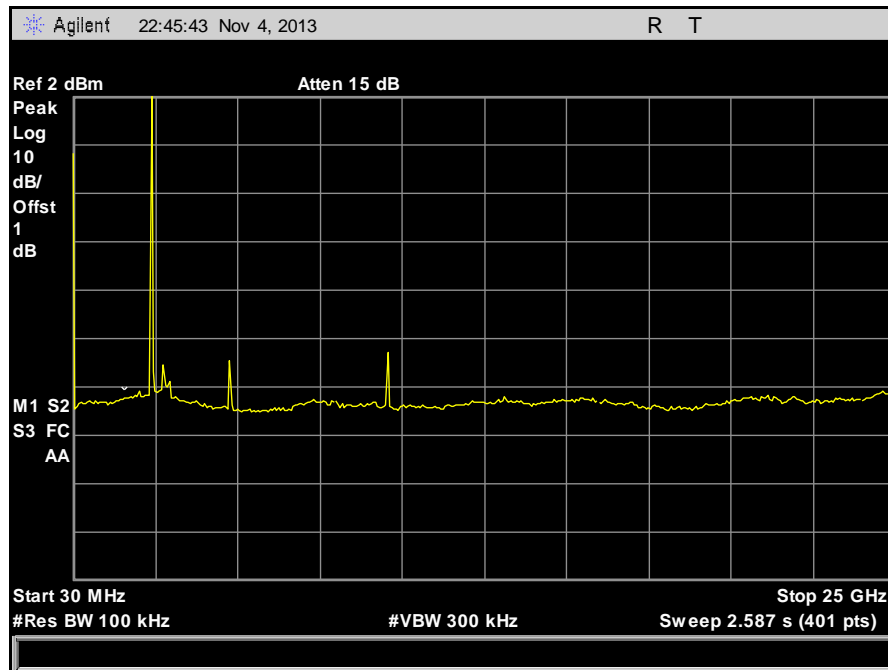

Plot 121. Conducted Spurious Emissions, GFSK, 30 MHz – 25 GHz, Low Channel

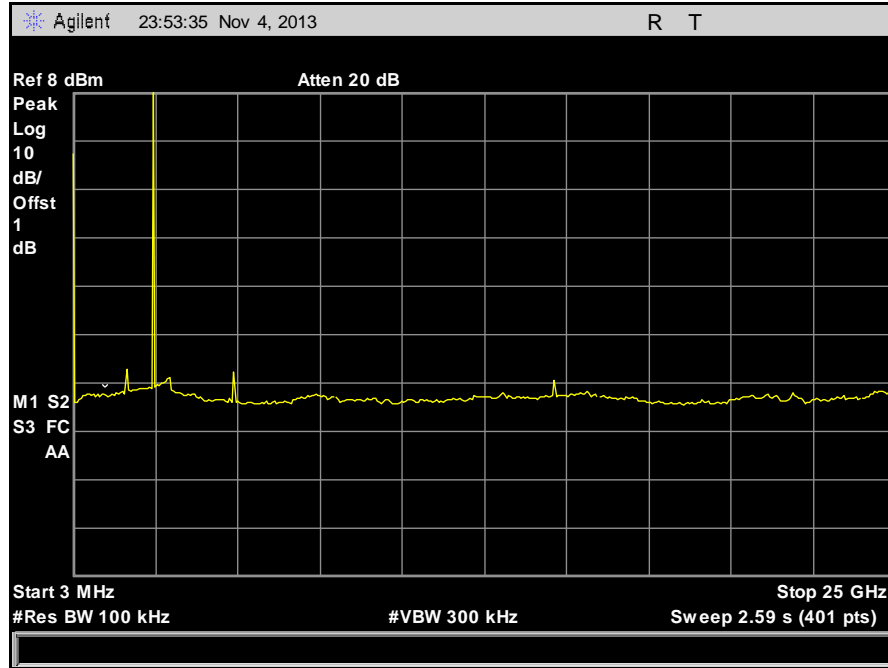

Plot 122. Conducted Spurious Emissions, GFSK, 30 MHz – 25 GHz, Mid Channel

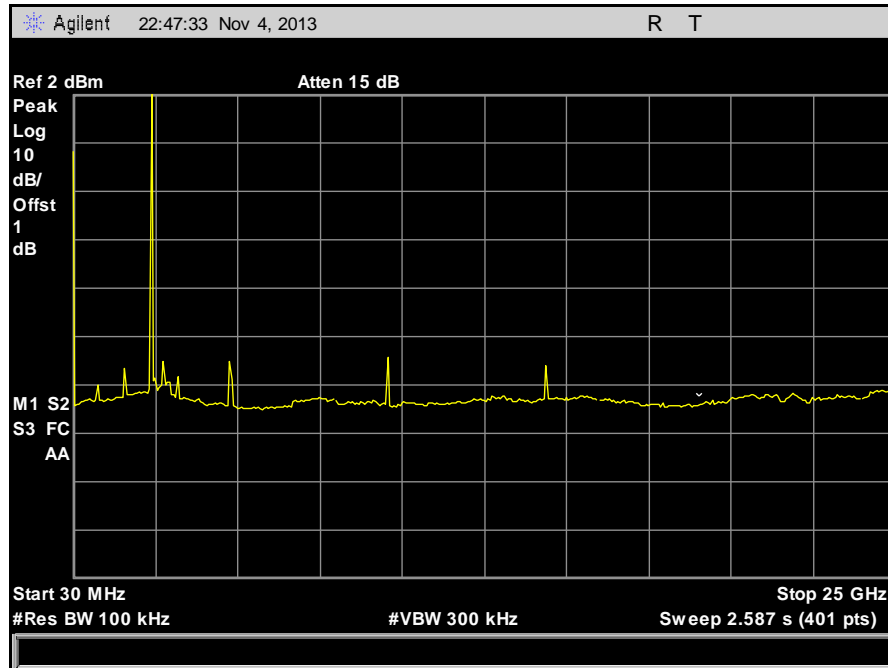

Plot 123. Conducted Spurious Emissions, GFSK, 30 MHz – 25 GHz, High Channel

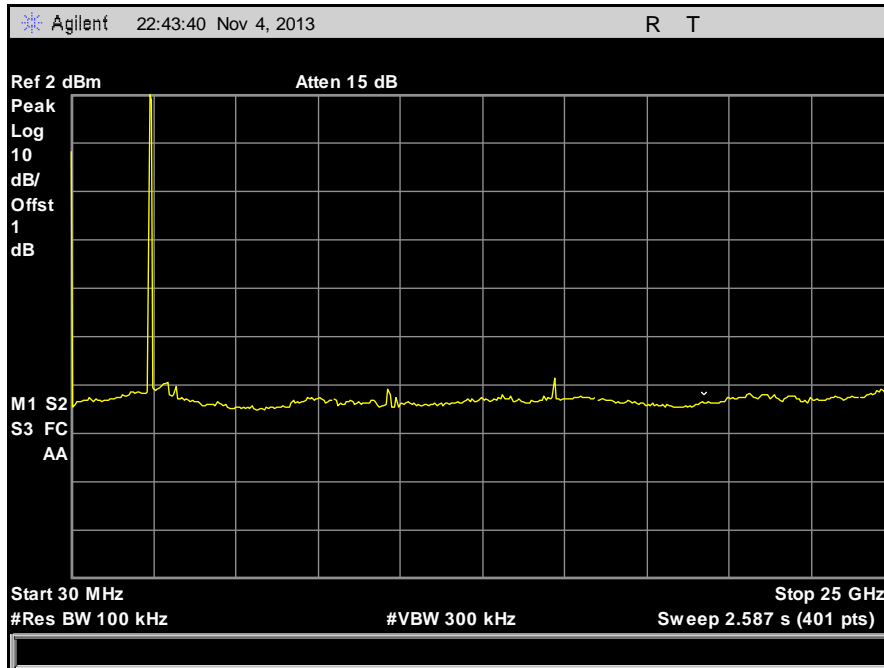

Plot 124. Conducted Spurious Emissions, Pi by 4 DQPSK, 30 MHz – 25 GHz, Hopping Mode

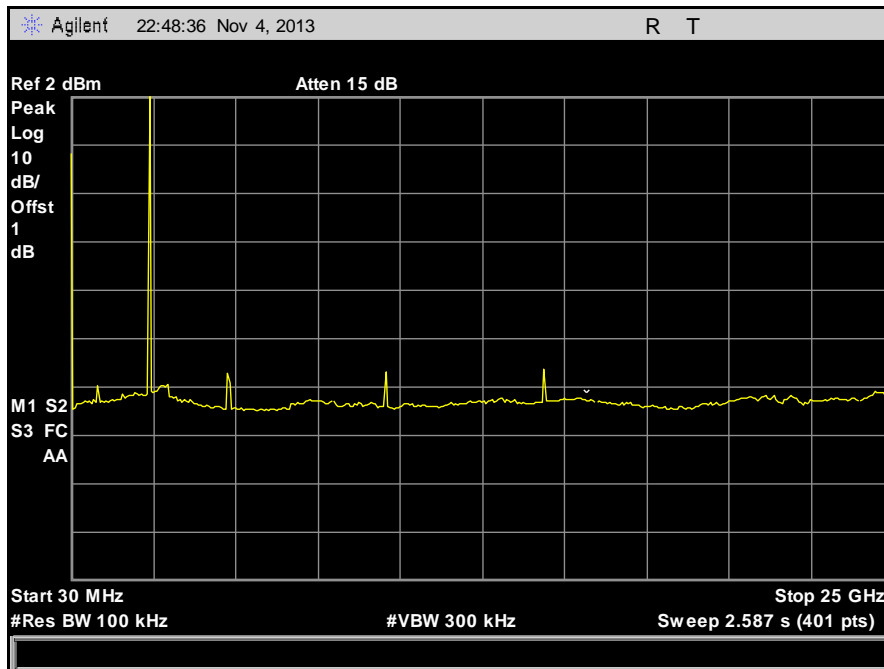

Plot 125. Conducted Spurious Emissions, Pi by 4 DQPSK, 30 MHz – 25 GHz, Low Channel

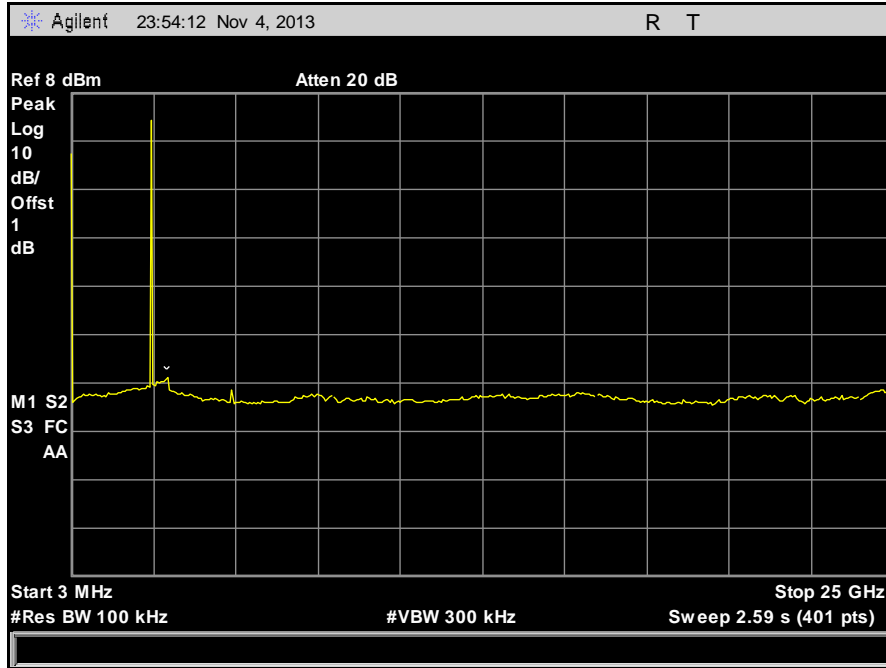

Plot 126. Conducted Spurious Emissions, Pi by 4 DQPSK, 30 MHz – 25 GHz, Mid Channel

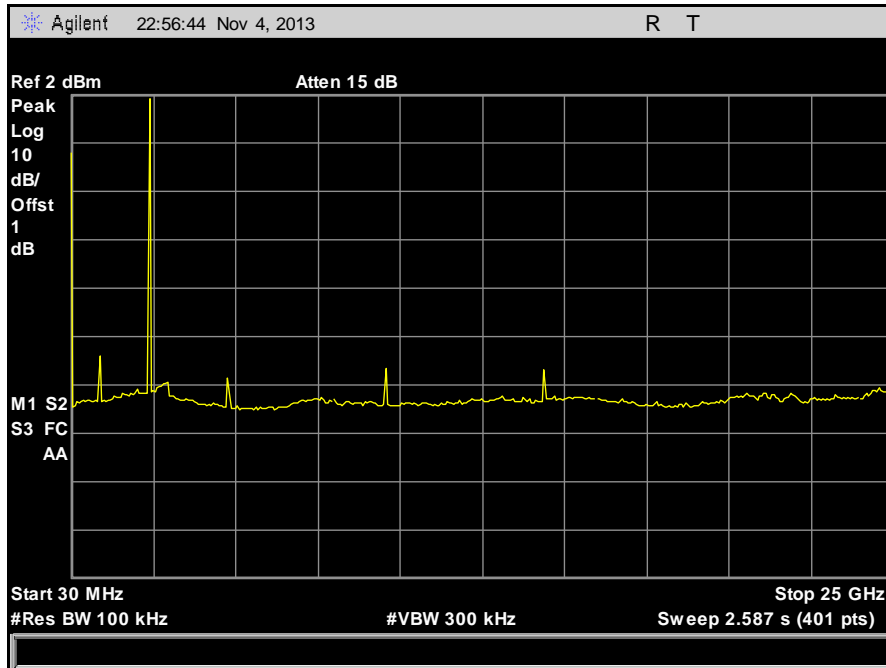

Plot 127. Conducted Spurious Emissions, Pi by 4 DQPSK, 30 MHz – 25 GHz, High Channel

Conducted Band Edge Test Results

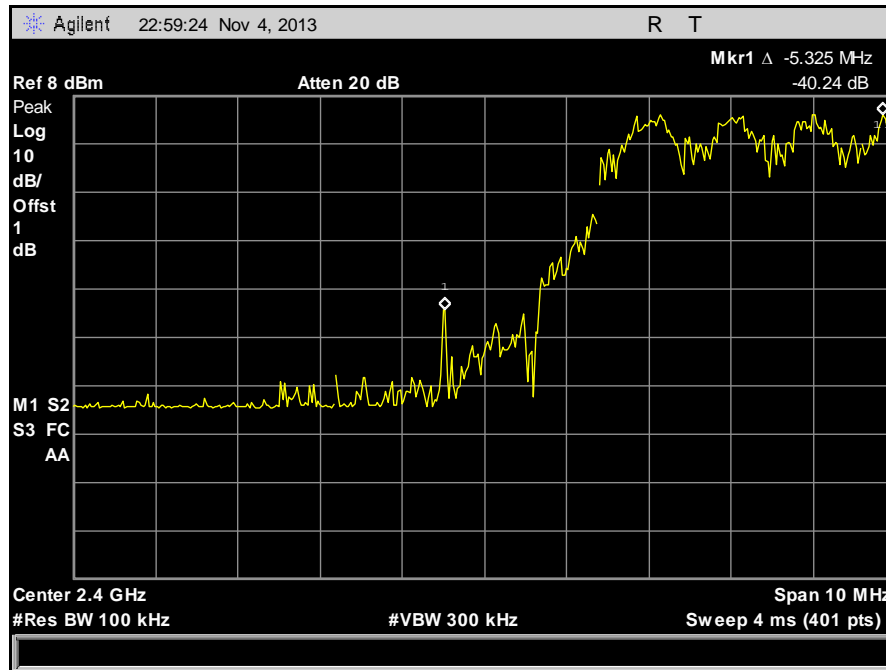

Plot 128. Conducted Band Edge, Low Channel, 8DPSK, Hopping Mode

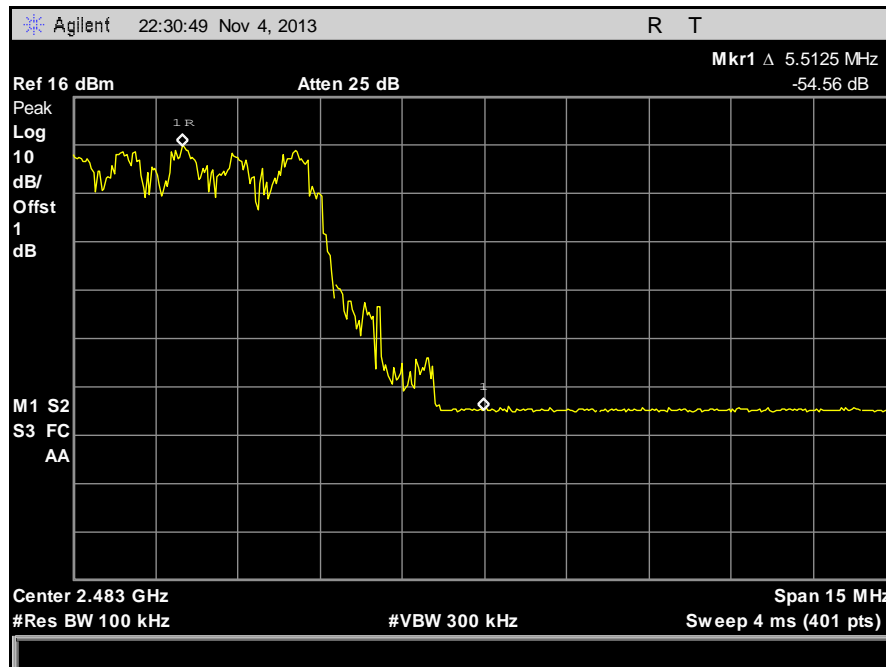

Plot 129. Conducted Band Edge, High Channel, 8DPSK, Hopping Mode

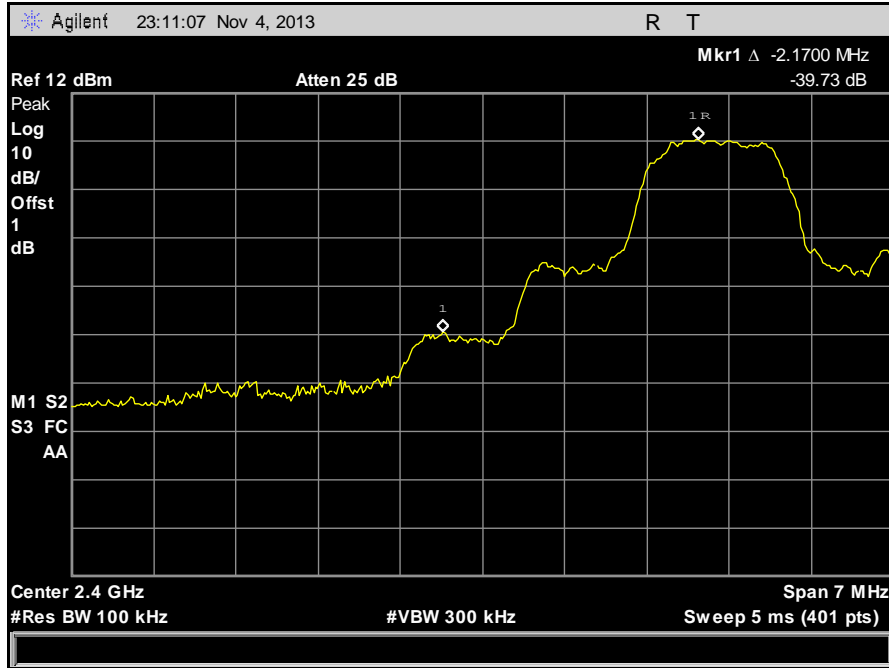

Plot 130. Conducted Band Edge, Low Channel, 8DPSK

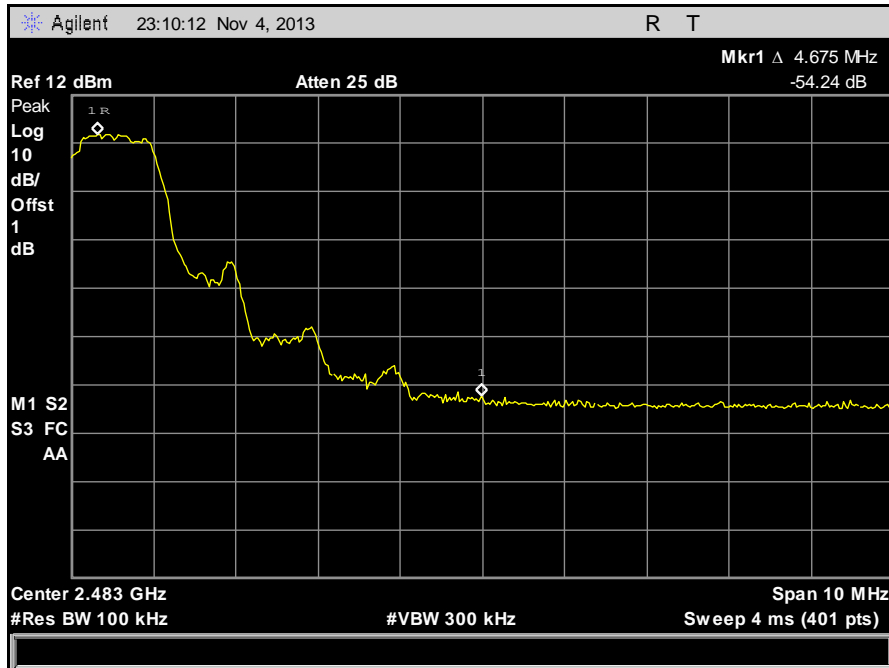

Plot 131. Conducted Band Edge, High Channel, 8DPSK

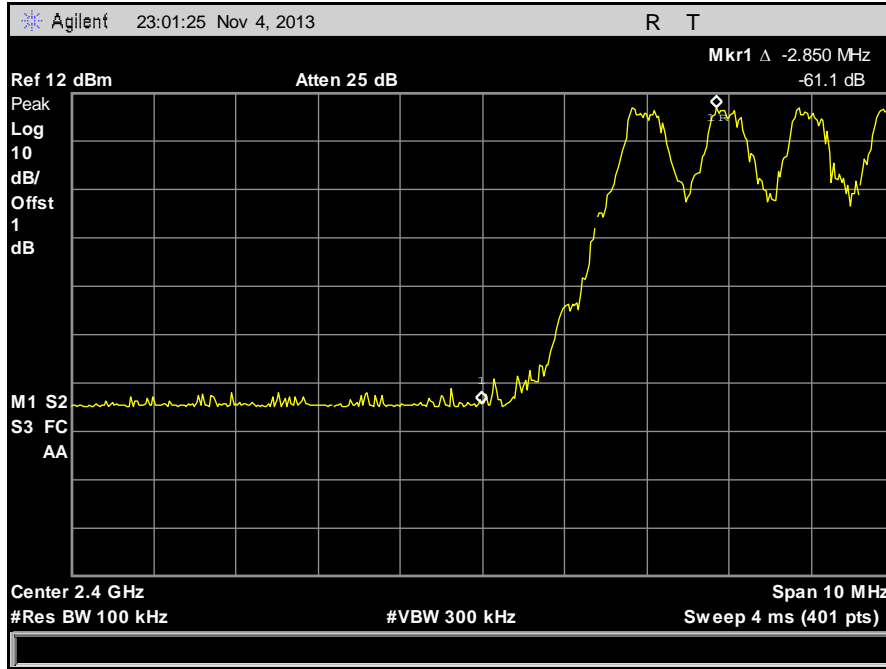

Plot 132. Conducted Band Edge, Low Channel, GFSK, Hopping Mode

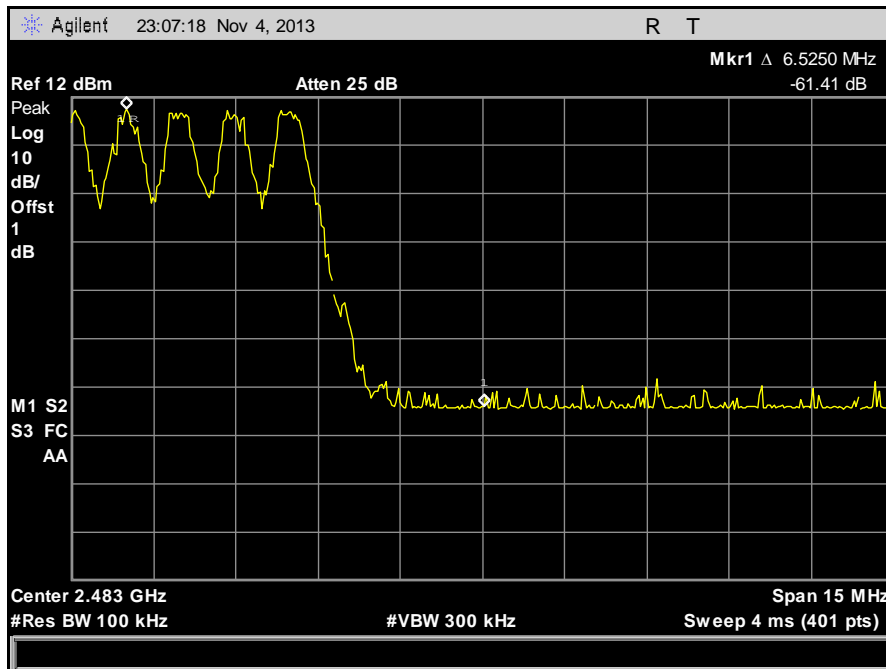

Plot 133. Conducted Band Edge, High Channel, GFSK, Hopping Mode

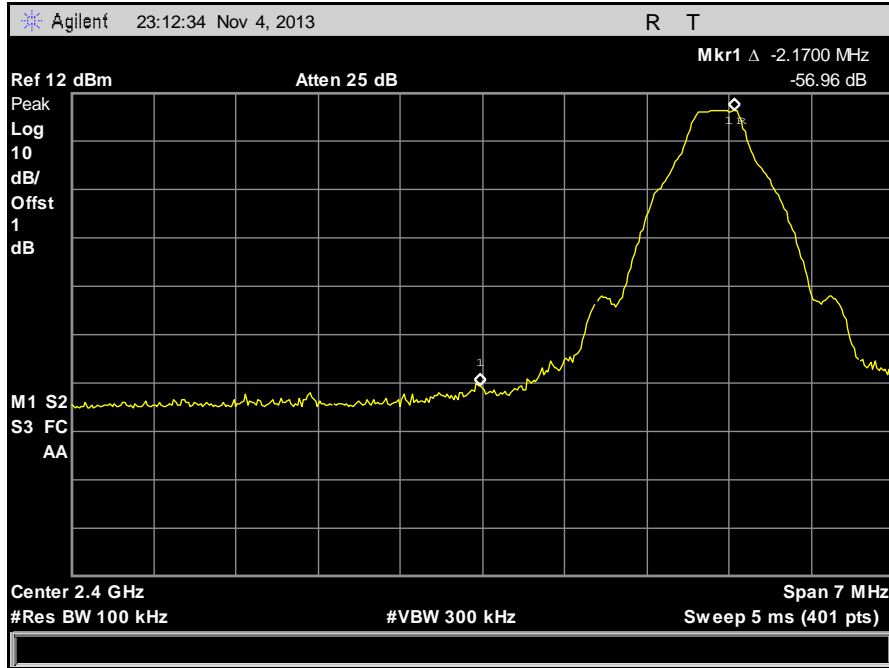

Plot 134. Conducted Band Edge, Low Channel, GFSK

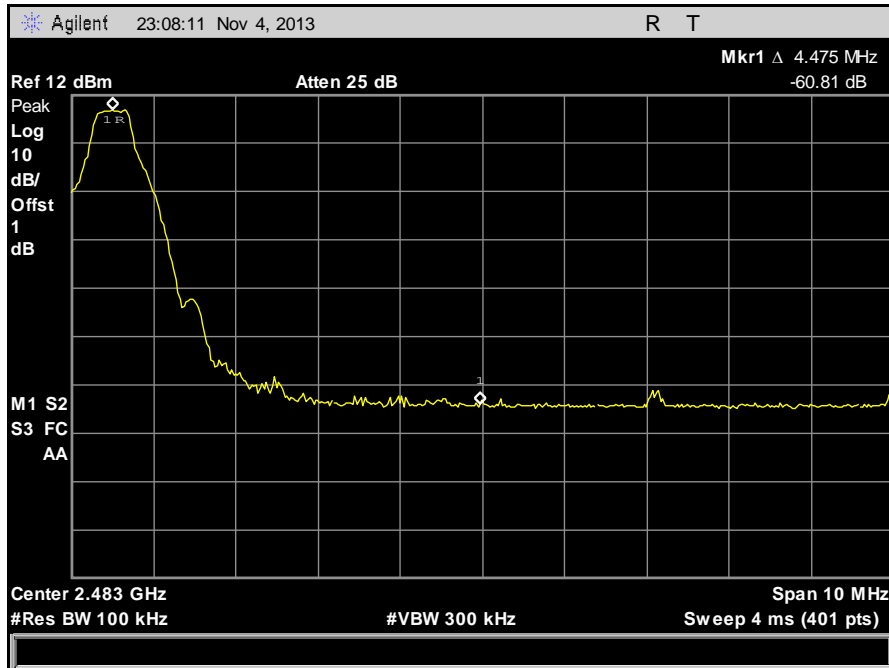

Plot 135. Conducted Band Edge, High Channel, GFSK

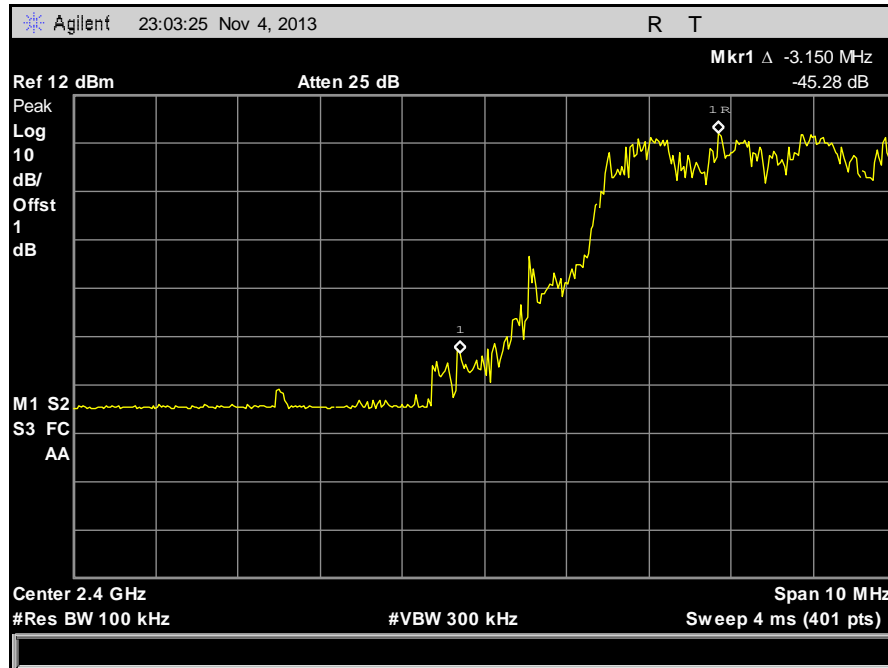

Plot 136. Conducted Band Edge, Low Channel, Pi by 4 DQPSK, Hopping Mode

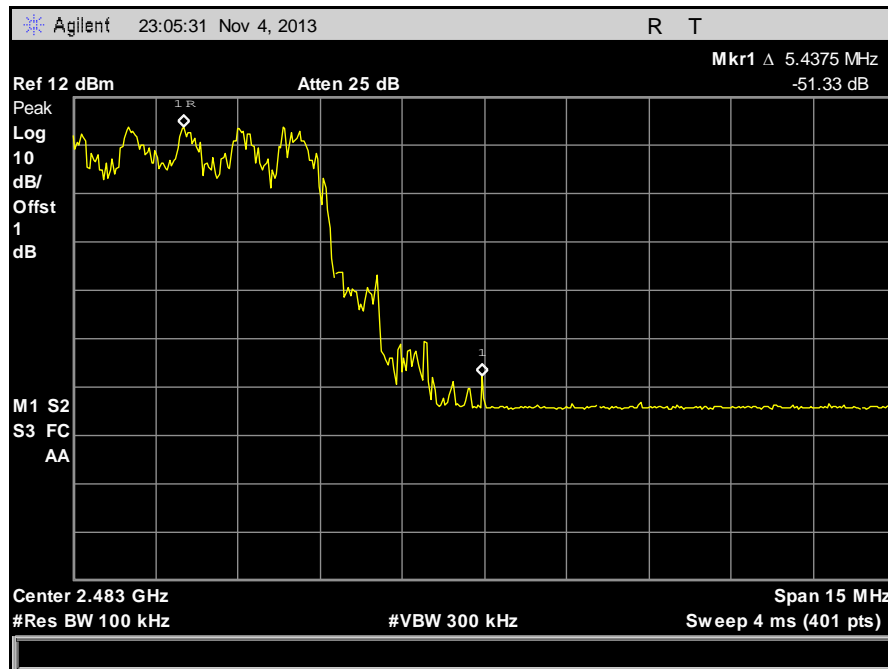

Plot 137. Conducted Band Edge, High Channel, Pi by 4 DQPSK, Hopping Mode

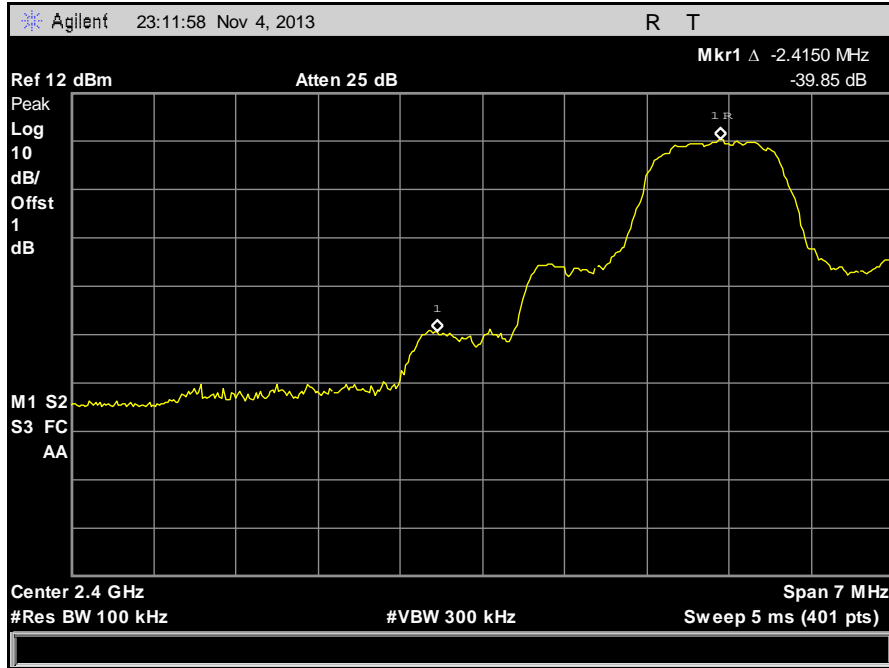

Plot 138. Conducted Band Edge, Low Channel, Pi by 4 DQPSK

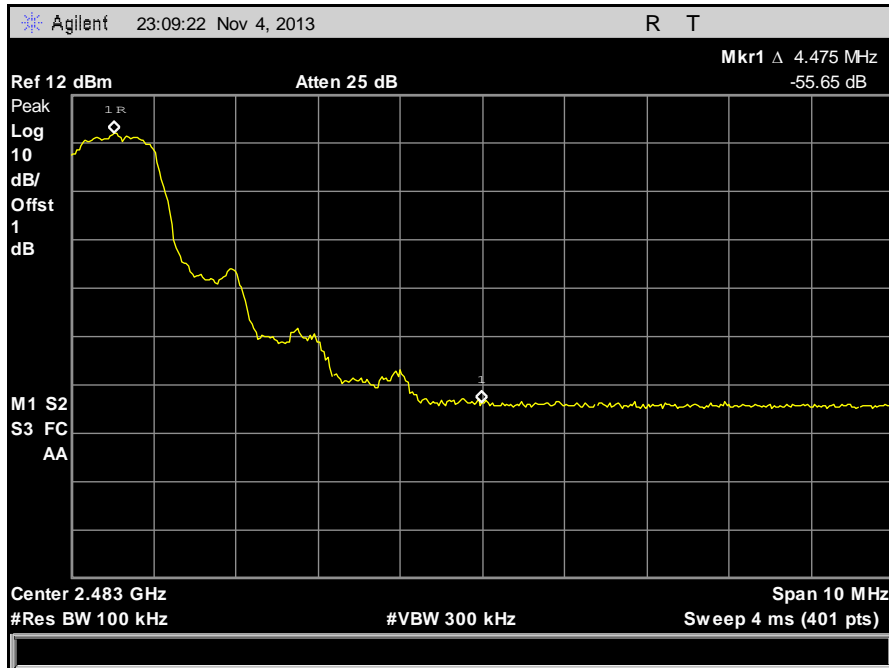

Plot 139. Conducted Band Edge, High Channel, Pi by 4 DQPSK

IV. Test Equipment

Test Equipment

Calibrated test equipment utilized during testing was maintained in a current state of calibration per the requirements of ISO/IEC 17025:2005.

MET Asset #	Equipment	Manufacturer	Model	Last Cal Date	Cal Due Date
1T4818	COMB GENERATOR	COM-POWER	CGO-520	SEE NOTE	
1T4751	ANTENNA - BILOG	SUNOL SCIENCES	JB6	01/08/2013	07/08/2014
1T4483	ANTENNA; HORN	ETS-LINDGREN	3117	08/06/2012	02/06/2014
1T4771	PSA SPECTRUM ANALYZER	AGILENT TECHNOLOGIES	E4446A	02/15/2013	08/15/2014
1T4409	EMI RECEIVER	ROHDE & SCHWARZ	ESIB7	07/16/2012	07/16/2014
1T4442	PRE-AMPLIFIER, MICROWAVE	MITEQ	AFS42-01001800-30-10P	SEE NOTE	
1T2511	ANTENNA; HORN	EMCO	3115	03/28/2013	09/28/2014
1T4300	SEMI-ANECHOIC CHAMBER # 1	EMC TEST SYSTEMS	NONE	07/24/2012	01/24/2014

Table 22. Test Equipment List

Note: Functionally tested equipment is verified using calibrated instrumentation at the time of testing.

V. Certification & User's Manual Information

Certification & User's Manual Information

A. Certification Information

The following is extracted from Title 47 of the Code of Federal Regulations, Part 2, Subpart I — Marketing of Radio frequency devices:

§ 2.801 Radio-frequency device defined.

As used in this part, a radio-frequency device is any device which in its operation is capable of Emitting radio-frequency energy by radiation, conduction, or other means. Radio- frequency devices include, but are not limited to:

- (a) The various types of radio communication transmitting devices described throughout this chapter.
- (b) *The incidental, unintentional and intentional radiators defined in Part 15 of this chapter.*
- (c) The industrial, scientific, and medical equipment described in Part 18 of this chapter.
- (d) Any part or component thereof which in use emits radio-frequency energy by radiation, conduction, or other means.

§ 2.803 Marketing of radio frequency devices prior to equipment authorization.

- (a) Except as provided elsewhere in this chapter, no person shall sell or lease, or offer for sale or lease (including advertising for sale or lease), or import, ship or distribute for the purpose of selling or leasing or offering for sale or lease, any radio frequency device unless:
 - (1) In the case of a device subject to certification, such device has been authorized by the Commission in accordance with the rules in this chapter and is properly identified and labeled as required by §2.925 and other relevant sections in this chapter; or
 - (2) In the case of a device that is not required to have a grant of equipment authorization issued by the Commission, but which must comply with the specified technical standards prior to use, such device also complies with all applicable administrative (including verification of the equipment or authorization under a Declaration of Conformity, where required), technical, labeling and identification requirements specified in this chapter.
- (d) Notwithstanding the provisions of paragraph (a) of this section, the offer for sale solely to business, commercial, industrial, scientific or medical users (but not an offer for sale to other parties or to end users located in a residential environment) of a radio frequency device that is in the conceptual, developmental, design or pre-production stage is permitted prior to equipment authorization or, for devices not subject to the equipment authorization requirements, prior to a determination of compliance with the applicable technical requirements *provided* that the prospective buyer is advised in writing at the time of the offer for sale that the equipment is subject to the FCC rules and that the equipment will comply with the appropriate rules before delivery to the buyer or to centers of distribution.

- (e)(1) Notwithstanding the provisions of paragraph (a) of this section, prior to equipment authorization or determination of compliance with the applicable technical requirements any radio frequency device may be operated, but not marketed, for the following purposes and under the following conditions:
- (i) *Compliance testing*;
 - (ii) Demonstrations at a trade show provided the notice contained in paragraph (c) of this section is displayed in a conspicuous location on, or immediately adjacent to, the device;
 - (iii) Demonstrations at an exhibition conducted at a business, commercial, industrial, scientific or medical location, but excluding locations in a residential environment, provided the notice contained in paragraphs (c) or (d) of this section, as appropriate, is displayed in a conspicuous location on, or immediately adjacent to, the device;
 - (iv) Evaluation of product performance and determination of customer acceptability, provided such operation takes place at the manufacturer's facilities during developmental, design or pre-production states; or
 - (v) Evaluation of product performance and determination of customer acceptability where customer acceptability of a radio frequency device cannot be determined at the manufacturer's facilities because of size or unique capability of the device, provided the device is operated at a business, commercial, industrial, scientific or medical user's site, but not at a residential site, during the development, design or pre-production stages.
- (e)(2) For the purpose of paragraphs (e)(1)(iv) and (e)(1)(v) of this section, the term *manufacturer's facilities* includes the facilities of the party responsible for compliance with the regulations and the manufacturer's premises, as well as the facilities of other entities working under the authorization of the responsible party in connection with the development and manufacture, but not the marketing, of the equipment.
- (f) For radio frequency devices subject to verification and sold solely to business, commercial, industrial, scientific and medical users (excluding products sold to other parties or for operation in a residential environment), parties responsible for verification of the devices shall have the option of ensuring compliance with the applicable technical specifications of this chapter at each end user's location after installation, provided that the purchase or lease agreement includes a proviso that such a determination of compliance be made and is the responsibility of the party responsible for verification of the equipment.

Certification & User's Manual Information

The following is extracted from Title 47 of the Code of Federal Regulations, Part 2, Subpart J — Equipment Authorization Procedures:

§ 2.901 Basis and Purpose

- (a) In order to carry out its responsibilities under the Communications Act and the various treaties and international regulations, and in order to promote efficient use of the radio spectrum, the Commission has developed technical standards for radio frequency equipment and parts or components thereof. The technical standards applicable to individual types of equipment are found in that part of the rules governing the service wherein the equipment is to be operated.¹ *In addition to the technical standards provided, the rules governing the service may require that such equipment be verified by the manufacturer or importer, be authorized under a Declaration of Conformity, or receive an equipment authorization from the Commission by one of the following procedures: certification or registration.*
- (b) The following sections describe the verification procedure, the procedure for a Declaration of Conformity, and the procedures to be followed in obtaining certification from the Commission and the conditions attendant to such a grant.

§ 2.907 Certification.

- (a) Certification is an equipment authorization issued by the Commission, based on representation and test data submitted by the applicant.
- (b) Certification attaches to all units subsequently marketed by the grantee which are identical (see Section 2.908) to the sample tested except for permissive changes or other variations authorized by the Commission pursuant to Section 2.1043.

¹ In this case, the equipment is subject to the rules of Part 15. More specifically, the equipment falls under Subpart B (of Part 15), which deals with unintentional radiators.

Certification & User's Manual Information

§ 2.948 Description of measurement facilities.

- (a) Each party making measurements of equipment that is subject to an equipment authorization under Part 15 or Part 18 of this chapter, regardless of whether the measurements are filed with the Commission or kept on file by the party responsible for compliance of equipment marketed within the U.S. or its possessions, shall compile a description of the measurement facilities employed.
- (1) If the measured equipment is subject to the verification procedure, the description of the measurement facilities shall be retained by the party responsible for verification of the equipment.
- (i) *If the equipment is verified through measurements performed by an independent laboratory, it is acceptable for the party responsible for verification of the equipment to rely upon the description of the measurement facilities retained by or placed on file with the Commission by that laboratory. In this situation, the party responsible for the verification of the equipment is not required to retain a duplicate copy of the description of the measurement facilities.*
- (ii) If the equipment is verified based on measurements performed at the installation site of the equipment, no specific site calibration data is required. It is acceptable to retain the description of the measurement facilities at the site at which the measurements were performed.
- (2) If the equipment is to be authorized by the Commission under the certification procedure, the description of the measurement facilities shall be filed with the Commission's Laboratory in Columbia, Maryland. The data describing the measurement facilities need only be filed once but must be updated as changes are made to the measurement facilities or as otherwise described in this section. At least every three years, the organization responsible for filing the data with the Commission shall certify that the data on file is current.

Certification & User's Manual Information

1. Label and User's Manual Information

The following is extracted from Title 47 of the Code of Federal Regulations, Part 15, Subpart A — General:

§ 15.19 Labeling requirements.

(a) *In addition to the requirements in Part 2 of this chapter, a device subject to certification or verification shall be labeled as follows:*

- (1) Receivers associated with the operation of a licensed radio service, e.g., FM broadcast under Part 73 of this chapter, land mobile operation under Part 90, etc., shall bear the following statement in a conspicuous location on the device:

This device complies with Part 15 of the FCC Rules. Operation is subject to the condition that this device does not cause harmful interference.

- (2) A stand-alone cable input selector switch, shall bear the following statement in a conspicuous location on the device:

This device is verified to comply with Part 15 of the FCC Rules for use with cable television service.

- (3) All other devices shall bear the following statement in a conspicuous location on the device:

This device complies with Part 15 of the FCC Rules. Operation is subject to the following two conditions: (1) This device may not cause harmful interference, and (2) this device must accept any interference received, including interference that may cause undesired operation.

- (4) Where a device is constructed in two or more sections connected by wires and marketed together, the statement specified under paragraph (a) of this section is required to be affixed only to the main control unit.

- (5) When the device is so small or for such use that it is not practicable to place the statement specified under paragraph (a) of this section on it, the information required by this paragraph shall be placed in a prominent location in the instruction manual or pamphlet supplied to the user or, alternatively, shall be placed on the container in which the device is marketed. However, the FCC identifier or the unique identifier, as appropriate, must be displayed on the device.

§ 15.21 Information to user.

The users manual or instruction manual for an intentional or unintentional radiator shall caution the user that changes or modifications not expressly approved by the party responsible for compliance could void the user's authority to operate the equipment.

Verification & User's Manual Information

The following is extracted from Title 47 of the Code of Federal Regulations, Part 15, Subpart B — Unintentional Radiators:

§ 15.105 Information to the user.

- (a) For a Class A digital device or peripheral, the instructions furnished the user shall include the following or similar statement, placed in a prominent location in the text of the manual:

Note: This equipment has been tested and found to comply with the limits for a Class A digital device, pursuant to Part 15 of the FCC Rules. These limits are designed to provide reasonable protection against harmful interference when the equipment is operated in a commercial environment. This equipment generates, uses, and can radiate radio frequency energy and, if not installed and used in accordance with the instruction manual, may cause harmful interference to radio communications. Operation of this equipment in a residential area is likely to cause harmful interference in which case the user will be required to correct the interference at own expense.

- (b) For a Class B digital device or peripheral, the instructions furnished the user shall include the following or similar statement, placed in a prominent location in the text of the manual:

Note: This equipment has been tested and found to comply with the limits for a Class B digital device, pursuant to Part 15 of the FCC Rules. These limits are designed to provide reasonable protection against harmful interference when the equipment is operated in a residential environment. This equipment generates, uses, and can radiate radio frequency energy and, if not installed and used in accordance with the instruction manual, may cause harmful interference to radio communications. However, there is no guarantee that interference will not occur in a particular installation. If this equipment does cause harmful interference to radio or television reception, which can be determined by turning the equipment off and on, the user is encouraged to try to correct the interference by one or more of the following measures:

- Reorient or relocate the receiving antenna.
- Increase the separation between the equipment and receiver.
- Connect the equipment into an outlet on a circuit different from that to which the receiver is connected.
- Consult the dealer or an experienced radio/TV technician for help.

ICES-003 Procedural & Labeling Requirements

From the Industry Canada Electromagnetic Compatibility Advisory Bulletin entitled, "Implementation and Interpretation of the Interference-Causing Equipment Standard for Digital Apparatus, ICES-003" (EMCAB-3, Issue 2, July 1995):

"At present, CISPR 22: 2002 and ICES technical requirements are essentially equivalent. Therefore, if you have CISPR 22: 2002 approval by meeting CISPR Publication 22, the only additional requirements are: to attach a note to the report of the test results for compliance, indicating that these results are deemed satisfactory evidence of compliance with ICES-003 of the Canadian Interference-Causing Equipment Regulations; to maintain these records on file for the requisite five year period; and to provide the device with a notice of compliance in accordance with ICES-003."

Procedural Requirements:

According to Industry Canada's Interference Causing Equipment Standard for Digital Apparatus ICES-003 Issue 4, February 2004:

- Section 6.1: A record of the measurements and results, showing the date that the measurements were completed, shall be retained by the manufacturer or importer for a period of at least five years from the date shown in the record and made available for examination on the request of the Minister.
- Section 6.2: A written notice indicating compliance must accompany each unit of digital apparatus to the end user. The notice shall be in the form of a label that is affixed to the apparatus. Where because of insufficient space or other constraints it is not feasible to affix a label to the apparatus, the notice may be in the form of a statement in the user's manual.

Labeling Requirements:

The suggested text for the notice, in English and in French, is provided below, from the Annex of ICES-003:

This Class [²] digital apparatus complies with Canadian ICES-003.

Cet appareil numérique de la classe [¹] est conforme à la norme NMB-003 du Canada.

² Insert either A or B but not both as appropriate for the equipment requirements.

End of Report