



**CENTRE OF TESTING SERVICE
INTERNATIONAL**

OPERATE ACCORDING TO ISO/IEC 17025

FCC ID/IC TEST REPORT

TEST REPORT NUMBER : CGZ3170413-00597-EFI



CENTRE OF TESTING SERVICE CO., LTD.

A101, No.65, Zhuji Highway, Tianhe District, Guangzhou, China



TEST REPORT For FCC ID/IC 47 CFR PART 15 OCT, 2016 RSS-247 Issue 2	
Report Reference No.	CGZ3170413-00597-EFI
Date of issue	21 June 2017
Testing Laboratory Name CENTRE OF TESTING SERVICE CO., LTD.	
Address	A101, No.65, Zhuji Highway, Tianhe District, Guangzhou, China
Testing location/ procedure	Full application of Harmonised standards <input checked="" type="checkbox"/> Partial application of Harmonised standards <input type="checkbox"/> Other standard testing method <input type="checkbox"/>
Applicant's name Rigado, Inc.	
Address	3950 Fariview Industrial Dr SE, Suite 100, Salem, OR USA, 97302
Test specification	
Standard	RSS-247 Issue 2; RSS-Gen Issue 4 47 CFR PART 15 OCT, 2016; ANSI C63.10:2013
Test Report Form No. CTSEMC-1.0	
TRF Originator	CENTRE OF TESTING SERVICE CO., LTD.
Master TRF	Dated 2009-01
CENTRE OF TESTING SERVICE CO., LTD. All rights reserved.	
This publication may be reproduced in whole or in part for non-commercial purposes as long as the CENTRE OF TESTING SERVICE CO., LTD. is acknowledged as copyright owner and source of the material. CENTRE OF TESTING SERVICE CO., LTD takes no responsibility for and will not assume liability for damages resulting from the reader's interpretation of the reproduced material due to its placement and context.	
Test item description : QCA6234	
Trade Mark	Rigado
Manufacturer	Rigado, Inc.
Model/Type reference	QCA6234
Ratings	DC 3.6V
Operating Frequency	2402.0 MHz~2480.0 MHz
Result	Positive

Compiled by:

Kate zhang / Fileadministrators

Supervised by:

Duke yang / Technique principal

Approved by:

Vincent yao / Manager

Copyright of this report is owned by Centre of Testing Service and may not be reproduced other than in full except with the written approval of the issuing Company.

CENTRE OF TESTING SERVICE CO., LTD.

A101, No.65, Zhuji Highway, Tianhe District, Guangzhou, China

Tel: +86-20-85543113 (32 lines)

Fax: +86-20-38780406

Complaint line: +86-20-85533471

E-mail: cts@cts-lab.com.cn

See Reverse For Terms And Conditions of Service



FCC ID/IC -- TEST REPORT

Test Report No. : CGZ3170413-00597-EFI	<u>21 June 2017</u> Date of issue
---	--------------------------------------

Type / Model.....	QCA6234
EUT.....	QCA6234
Applicant.....	Rigado, Inc.
Address.....	3950 Fariview Industrial Dr SE, Suite 100, Salem, OR USA, 97302
Telephone.....	+1-971-208-9857
Fax.....	+1-971-208-9869
Contact.....	Cam Nichols
Manufacturer.....	Rigado, Inc.
Address.....	3950 Fariview Industrial Dr SE, Suite 100, Salem, OR USA, 97302
Telephone.....	+1-971-208-9857
Fax.....	+1-971-208-9869
Contact.....	Cam Nichols
Factory.....	Rigado, Inc.
Address.....	3950 Fariview Industrial Dr SE, Suite 100, Salem, OR USA, 97302
Telephone.....	+1-971-208-9857
Fax.....	+1-971-208-9869
Contact.....	Cam Nichols

Test Result according to the standards on page 1: **PASSED**

The test report merely corresponds to the test sample.
 It is not permitted to copy extracts of these test result without the written permission of the test laboratory.

Copyright of this report is owned by Centre of Testing Service and may not be reproduced other than in full except with the written approval of the issuing Company.



TABLE OF CONTENTS

Description	Page
1.0 TEST STANDARDS	5
2.0 SUMMARY	5
2.1 GENERAL REMARKS	5
2.2 FINAL ASSESSMENT	5
3.0 EQUIPMENT UNDER TEST	5
3.1 POWER SUPPLY SYSTEM UTILISED	5
3.2 SHORT DESCRIPTION OF THE EQUIPMENT UNDER TEST (EUT)	5
3.3 EUT OPERATION MODE	5
3.4 EUT CONFIGURATION	6
4.0 TEST ENVIRONMENT	7
4.1 ADDRESS OF THE TEST LABORATORY	7
4.2 TEST FACILITY	7
4.3 ENVIRONMENTAL CONDITIONS	7
4.4 DEFINITIONS OF SYMBOLS USED IN THIS TEST REPORT	7
4.5 STATEMENT OF THE MEASUREMENT UNCERTAINTY	7
4.6 MEASUREMENT UNCERTAINTY	8
5.0 SUMMARY OF STANDARDS AND RESULTS	8
5.1.DESCRPTION OF STANDARDS AND RESULTS	8
6.0 POWER LINE CONDUCTED EMISSION TEST	9
6.1.TEST EQUIPMENT	9
6.2. BLOCK DIAGRAM OF TEST SETUP	9
6.3. POWER LINE CONDUCTED EMISSION TEST LIMITS	9
6.4.TEST PROCEDURE	9
6.5. POWER LINE CONDUCTED EMISSION TEST RESULTS	9
7.0 6DB BANDWIDTH MEASUREMENT	12
7.1 LIMITS	12
7.2 MEASUREMENT EQUIPMENT USED	12
7.3 TEST CONFIGURATION	12
7.4 TEST PROCEDURE	12
7.5 TEST RESULTS	13
8.0 OUTPUT POWER	16
8.1 LIMIT	16
8.2 MEASUREMENT EQUIPMENT USED	16
8.3 TEST CONDIGURATION	16

Copyright of this report is owned by Centre of Testing Service and may not be reproduced other than in full except with the written approval of the issuing Company.

CENTRE OF TESTING SERVICE CO., LTD.

A101, No.65, Zhuji Highway, Tianhe District, Guangzhou, China

Tel: +86-20-85543113 (32 lines)

Fax: +86-20-38780406

Complaint line: +86-20-85533471

E-mail: cts@cts-lab.com.cn

See Reverse For Terms And Conditions of Service



8.4 TEST PROCEDURE	16
8.5 TEST RESULTS	17
9.0 PEAK POWER SPECTRAL DENSITY	18
9.1 LIMIT.....	18
9.2 MEASUREMENT EQUIPMENT USED.....	18
9.3 TEST CONFIGURATION	18
9.4 TEST PROCEDURE.....	18
9.5 TEST RESULTS	18
10.0 BAND EDGES MEASUREMENT	22
10.1 LIMIT.....	22
10.2 MEASUREMENT EQUIPMENT USED	22
10.3 TEST CONFIGURATION	22
10.4 TEST PROCEDURE.....	22
10.5 TEST RESULTS	22
11.0 SPURIOUS EMISSIONS.....	25
11.1 LIMIT.....	25
11.2 TEST EQUIPMENT.....	25
11.3 TEST CONFIGURATION	26
11.4 TEST PROCEDURE.....	27
11.5 TEST RESULTS	27
12.0 RECEIVER SUPRIOUS EMISSION.....	33
12.1 LIMIT.....	33
12.2 TEST EQUIPMENT	33
12.3 TEST CONFIGURATION	34
12.4 TEST PROCEDURE.....	34
12.5 TEST RESULTS	34
13. 99% OCCUPIED BANDWIDTH.....	39
13.1 TEST PROCEDUR	39
13.2. TEST EQUIPMENT	39
13.3 TEST CONFIGURATION	39
13.4 TEST PROCEDURE.....	39
13.5 TEST RESULTS	39
14.0 ANTENNA REQUIREMENTS	43
14.1 STANDARD APPLICABLE	43
14.2 ANTENNA CONSTRUCTION AND DIRECTIONAL GAIN.....	43
15.0 DEVIATION TO TEST SPECIFICATIONS	43

Copyright of this report is owned by Centre of Testing Service and may not be reproduced other than in full except with the written approval of the issuing Company.

CENTRE OF TESTING SERVICE CO., LTD.

A101, No.65, Zhuji Highway, Tianhe District, Guangzhou, China

Tel: +86-20-85543113 (32 lines)

Fax: +86-20-38780406

Complaint line: +86-20-85533471

E-mail: cts@cts-lab.com.cn

See Reverse For Terms And Conditions of Service



1.0 TEST STANDARDS

The tests were performed according to following standards:

- 47 CFR PART 15 OCT, 2016
- RSS-247 Issue 2
- RSS-Gen Issue 4
- ANSI C63.10:2013

2.0 SUMMARY

2.1 GENERAL REMARKS

Date of receipt of test sample	13 April 2017
Testing commenced on	13 April ~21 June 2017
Testing concluded on	21 June 2017

2.2 FINAL ASSESSMENT

The FCC/IC requirements pertaining to the technical standards and tested operation modes are

- - fulfilled.
- - **not** fulfilled.

The equipment under test

- - fulfils the FCC ID/IC requirements cited on page 1.
- - **does not** fulfil the FCC ID/IC requirements cited on page 1.

3.0 EQUIPMENT UNDER TEST

3.1 Power supply system utilised

Power supply voltage : ■ DC 3.6V by Jig, Jig DC 5V Power supply by Adapter

3.2 Short description of the Equipment under Test (EUT)

Number of tested samples: 1
Serial number: Prototype

3.3 EUT operation mode

The equipment under test was operated during the measurement under the following conditions:

- TX- Y position
- TX- Z position
- TX- X position (Worst case)

Operation mode 1:TX-X Position Low (2402MHz) , TX-X Position Middle (2440MHz) ,
TX-X Position High (2480MHz)

Note:Operation mode 1 TX -X position of EUT is the radiated test worst case; so only these test results be recorded in the test report.



3.4 EUT configuration

3.4.1. Description of configuration (EUT)

Description	:	QCA6234
Model Number	:	QCA6234
Operation frequency	:	2402~ 2480 MHz ISM Band
Modulation Technology	:	BT 4.0/GFSK Modulation
Antenna	:	PCB Antenna, 0dBi

3.4.2. Tested Supporting System Details

N/A

Copyright of this report is owned by Centre of Testing Service and may not be reproduced other than in full except with the written approval of the issuing Company.

CENTRE OF TESTING SERVICE CO., LTD.

A101, No.65, Zhuji Highway, Tianhe District, Guangzhou, China

Tel: +86-20-85543113 (32 lines)

Fax: +86-20-38780406

Complaint line: +86-20-85533471

E-mail: cts@cts-lab.com.cn

See Reverse For Terms And Conditions of Service

4.0 TEST ENVIRONMENT

4.1 Address of the test laboratory

A101, No.65, Zhuji Highway, Tianhe District, Guangzhou, China

Tel: +86-20-85543113 (32 lines)

Fax: +86-20-38780406

4.2 Test facility

The test facility is recognized, certified, or accredited by the following organizations:

CNAS-Lab Code: L3394

CENTRE OF TESTING SERVICE CO., LTD has been assessed and proved to be in compliance with CNAS-CL01: 2006 Accreditation Criteria for Testing and Calibration Laboratories (identical to ISO/IEC 17025: 2005 General Requirements) for the Competence of Testing and Calibration Laboratories.

IC-Registration No.: 8374A

The 3m Alternate Test Site of CENTRE OF TESTING SERVICE CO., LTD has been registered by Certification and Engineering Bureau of Industry Canada for the performance of radiated measurements with Registration No. 8374A on May 22, 2014.

FCC-Registration No.: 971995

CENTRE OF TESTING SERVICE CO., LTD, EMC Laboratory has been registered and fully described in a report filed with the FCC (Federal Communications Commission). The acceptance letter from the FCC is maintained in our files. Registration No.791995, July 13,2012.

4.3 Environmental conditions

During the measurement the environmental conditions were within the listed ranges:

Temperature:	15~35 ° C
Humidity:	25~75 %
Atmospheric pressure:	86~106 kPa

4.4 Definitions of symbols used in this test report

- - The black square indicates that the listed condition, standard or equipment is applicable for this report.
- - The empty square indicates that the listed condition, standard or equipment is **not** applicable for this report.

4.5 Statement of the measurement uncertainty

The data and results referenced in this document are true and accurate. The reader is cautioned that there may be errors within the calibration limits of the equipment and facilities. The measurement uncertainty was calculated for all measurements listed in this test report acc. to CISPR 16 - 4 "Specification for radio disturbance and immunity measuring apparatus and methods – Part 4: Uncertainty in EMC Measurements" and is documented in the CTS quality system acc. to DIN EN ISO/IEC 17025. Furthermore, component and process variability of devices similar to that tested may result in additional deviation. The manufacturer has the sole responsibility of continued compliance of the device.



4.6 Measurement Uncertainty

Test Item	Frequency Range	Uncertainty	Note
Conduction disturbance	150kHz~30MHz	±1.22dB	(1)
Power disturbance	30MHz~300MHz	±1.38dB	(1)
Radiation emission (3m)	30MHz~300MHz	±3.14dB	(1)
	300MHz~1000MHz	±3.18dB	(1)
	1GHz~26.5GHz	±3.54dB	(1)

(1). This uncertainty represents an expanded uncertainty expressed at approximately the 95% confidence level using a coverage factor of k=2.

5.0 Summary of standards and results

5.1. Description of Standards and Results

The EUT have been tested according to the applicable standards as referenced below.

EMISSION		
Description of Test Item	Standard	Results
Conducted Emission Test	FCC Part 15 : 15.207 RSS-Gen Issue 4§ 7.2.4 ANSI C63.10:2013	PASSED
6dB Bandwidth Measurement	FCC Part 15.247(a)(2) RSS-247 Issue 2§ 5.2(1) ANSI C63.10:2013	PASSED
Output Power	FCC Part 15.247(b)(3)(4) RSS-247 Issue 2§ 5.4(4) ANSI C63.10:2013	PASSED
Peak Power Spectral Density	FCC Part 15.247(e) RSS-247 Issue 2§ 5.2(2) ANSI C63.10:2013	PASSED
Band edges measurement	FCC Part 15.247(d) RSS-247 Issue 2§ 5.5 ANSI C63.10:2013	PASSED
Spurious Emissions	FCC Part 15: 15.209 RSS-Gen Issue 4§ 7.2 ANSI C63.10:2013	PASSED
Receiver Spurious Emissions	RSS-Gen Issue 4§ 4.10 ANSI C63.10:2013	PASSED
99% Bandwidth	RSS-Gen Issue 4 § 6.6 ANSI C63.10:2013	PASSED
Antenna Requirements	FCC Part 15: 15.203 ANSI C63.10:2013	PASSED
N/A is an abbreviation for Not Applicable.		

Copyright of this report is owned by Centre of Testing Service and may not be reproduced other than in full except with the written approval of the issuing Company.

CENTRE OF TESTING SERVICE CO., LTD.

A101, No.65, Zhuji Highway, Tianhe District, Guangzhou, China
 Tel: +86-20-85543113 (32 lines) Fax: +86-20-38780406
 Complaint line: +86-20-85533471 E-mail: cts@cts-lab.com.cn

See Reverse For Terms And Conditions of Service

6.0 Power Line Conducted Emission Test

6.1. Test Equipment

Conducted Disturbance					
Item	Test Equipment	Manufacturer	Model No.	Serial No.	Last Cal.
1	EMI Test Receiver	ROHDE & SCHWARZ	ESHS10	842884/012	2016/11
2	Artificial Mains	ROHDE & SCHWARZ	ESH3-Z5	832479/025	2016/11
3	Artificial Mains	ROHDE & SCHWARZ	ESH3-Z5	832479/026	2016/11
4	Pulse Limiter	ROHDE & SCHWARZ	ESHSZ2	100301	2016/11
5	EMI Test Software	EZ-EMC	Farad	N/A	N/A

6.2. Block Diagram of Test Setup

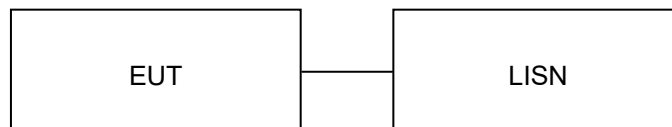

(EUT: QCA6234)

6.3. Power Line Conducted Emission Test Limits

Standard: FCC Part 15 : 15.207, ANSI C63.10-2013

Frequency	Maximum RF Line Voltage	
	Quasi-Peak Level dB(μV)	Average Level dB(μV)
150kHz ~ 500kHz	66 ~ 56*	56 ~ 46*
500kHz ~ 5MHz	56	46
5MHz ~ 30MHz	60	50

- Notes: 1. * Decreasing linearly with logarithm of frequency.
 2. The lower limit shall apply at the transition frequencies.

6.4. Test Procedure

The Adapter Power connected to the power mains through a line impedance stabilization network (L.I.S.N.#2). This provides a 50 ohm coupling impedance for the EUT. Please refer the block diagram of the test setup and photographs. The other peripheral devices power cord connected to the power mains through a line impedance stabilization network (L.I.S.N.#1). Power on the PC and let it work normally, we use a keyboard test soft ware, let EUT working in test mode, then test it. Both sides of AC line are checked to find out the maximum conducted emission. In order to find the maximum emission levels, the relative positions of equipment and all of the interface cables shall be changed according to FCC Part 15C on Conducted Emission Test.

6.5. Power Line Conducted Emission Test Results



Test point	L	Result:	<input checked="" type="checkbox"/> - passed <input type="checkbox"/> - not passed
Operation mode	TX		
Remarks:			

EUT	QCA6234
MODEL NO.	QCA6234
Operating Condition	AC 120V/60Hz
Test Condition	Ambient Temperature: 24°C Humidity: 56%
Operator	Duke

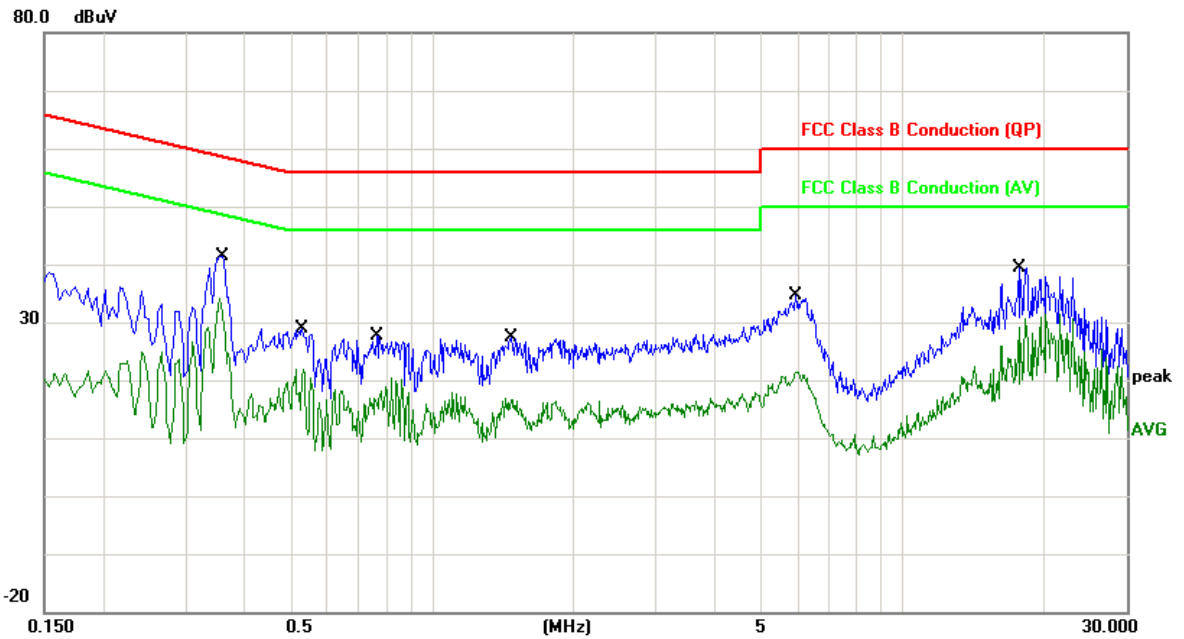

No.	Frequency (MHz)	Factor (dB)	Reading (dBuV)	Level (dBuV)	Limit (dBuV)	Margin (dB)	Detector
1	0.3580	10.20	28.71	38.91	58.77	-19.86	QP
2	0.3580	10.20	20.96	31.16	48.77	-17.61	AVG
3	0.5300	10.21	16.26	26.47	56.00	-29.53	QP
4	0.5300	10.21	9.98	20.19	46.00	-25.81	AVG
5	0.7660	10.26	12.92	23.18	56.00	-32.82	QP
6	0.7660	10.26	5.36	15.62	46.00	-30.38	AVG
7	1.4780	10.36	11.19	21.55	56.00	-34.45	QP
8	1.4780	10.36	4.70	15.06	46.00	-30.94	AVG
9	5.9540	10.84	18.78	29.62	60.00	-30.38	QP
10	5.9540	10.84	9.81	20.65	50.00	-29.35	AVG
11	17.6940	11.19	24.91	36.10	60.00	-23.90	QP
12	17.6940	11.19	17.90	29.09	50.00	-20.91	AVG

Copyright of this report is owned by Centre of Testing Service and may not be reproduced other than in full except with the written approval of the issuing Company.

CENTRE OF TESTING SERVICE CO., LTD.

A101, No.65, Zhuji Highway, Tianhe District, Guangzhou, China
 Tel: +86-20-85543113 (32 lines) Fax: +86-20-38780406
 Complaint line: +86-20-85533471 E-mail: cts@cts-lab.com.cn

See Reverse For Terms And Conditions of Service



Test point:	N	Result:	■ - passed
Operation mode	TX		□ - not passed
Remarks:			

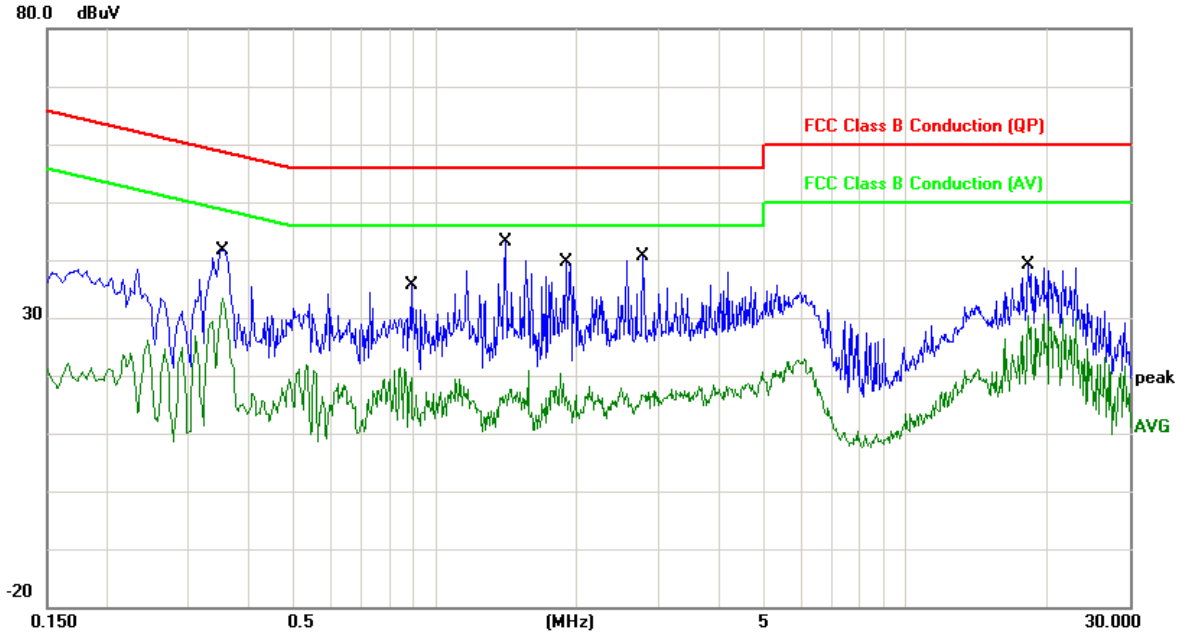

No.	Frequency (MHz)	Factor (dB)	Reading (dBuV)	Level (dBuV)	Limit (dBuV)	Margin (dB)	Detector
1	0.3540	10.31	30.01	40.32	58.87	-18.55	QP
2	0.3540	10.31	22.36	32.67	48.87	-16.20	AVG
3	0.8900	10.40	15.39	25.79	56.00	-30.21	QP
4	0.8900	10.40	7.69	18.09	46.00	-27.91	AVG
5	1.4180	10.47	16.38	26.85	56.00	-29.15	QP
6	1.4180	10.47	5.35	15.82	46.00	-30.18	AVG
7	1.9020	10.51	16.04	26.55	56.00	-29.45	QP
8	1.9020	10.51	4.80	15.31	46.00	-30.69	AVG
9	2.7740	10.59	13.64	24.23	56.00	-31.77	QP
10	2.7740	10.59	5.15	15.74	46.00	-30.26	AVG
11	18.2419	11.47	25.27	36.74	60.00	-23.26	QP
12	18.2419	11.47	18.06	29.53	50.00	-20.47	AVG

Note: Level=Reading+Factor. Margin= Level - Limit

Copyright of this report is owned by Centre of Testing Service and may not be reproduced other than in full except with the written approval of the issuing Company.

CENTRE OF TESTING SERVICE CO., LTD.

A101, No.65, Zhuji Highway, Tianhe District, Guangzhou, China

Tel: +86-20-85543113 (32 lines)

Fax: +86-20-38780406

Complaint line: +86-20-85533471

E-mail: cts@cts-lab.com.cn

See Reverse For Terms And Conditions of Service

7.0 6dB BANDWIDTH MEASUREMENT

7.1 LIMITS

According to §15.247(a)(2), RSS-247 Issue 2§ 5.2(1), systems using digital modulation techniques may operate in the 902 - 928 MHz, 2400 - 2483.5 MHz, and 5725 - 5850 MHz bands. The minimum 6dB bandwidth shall be at least 500 kHz.

7.2 MEASUREMENT EQUIPMENT USED

20dB Bandwidth					
Item	Test Equipment	Manufacturer	Model No.	Serial No.	Last Cal.
1	Signal analyzer	ROHDE & SCHWARZ	FSIQ26	100311	2017/03

7.3 TEST CONFIGURATION

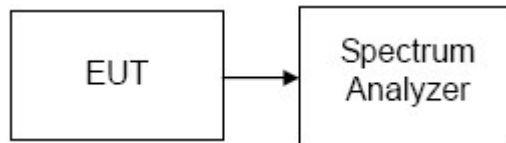

7.4 TEST PROCEDURE

1. Place the EUT on the table and set it in the transmitting mode.
2. Remove the antenna from the EUT and then connect a low loss RF cable from the antenna port to the spectrum analyzer.
3. Set the spectrum analyzer as RBW = 100kHz, VBW = 300kHz, Span = 1.5 times of bandwidth, Sweep = auto.
4. Mark the peak frequency and -6dB (upper and lower) frequency.
5. Repeat until all the rest channels are investigated



7.5 TEST RESULTS

Modulation Standard	Channel	Frequency (MHz)	Bandwidth (KHz)	Limit (KHz)	Result
GFSK	Low	2402	660	>500	PASSED
	Middle	2440	664		PASSED
	High	2480	664		PASSED
Remark: The Bandwidth is Delta 2 of following the graph. And the Delta 2 is Marker 2 subtract Marker 1.					

Copyright of this report is owned by Centre of Testing Service and may not be reproduced other than in full except with the written approval of the issuing Company.

CENTRE OF TESTING SERVICE CO., LTD.

A101, No.65, Zhuji Highway, Tianhe District, Guangzhou, China

Tel: +86-20-85543113 (32 lines)

Fax: +86-20-38780406

Complaint line: +86-20-85533471

E-mail: cts@cts-lab.com.cn

See Reverse For Terms And Conditions of Service

Test Plot:

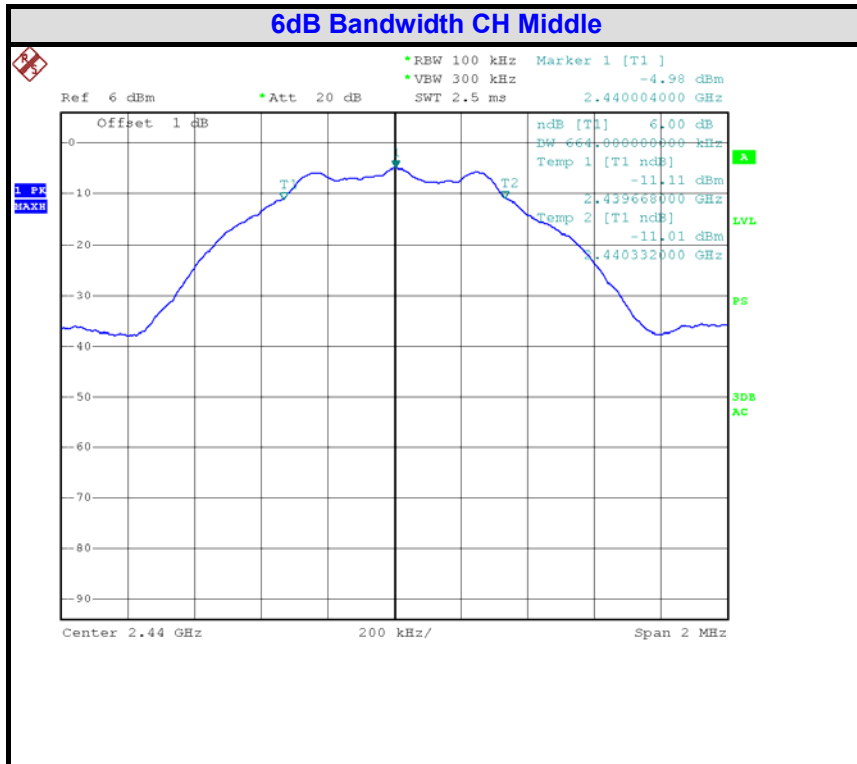
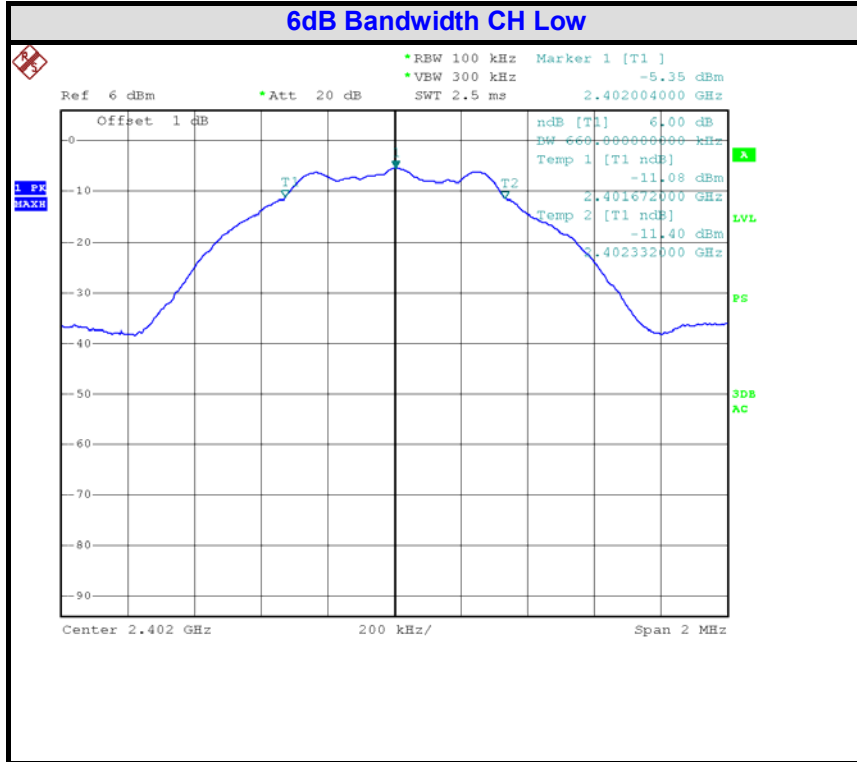

Copyright of this report is owned by Centre of Testing Service and may not be reproduced other than in full except with the written approval of the issuing Company.

CENTRE OF TESTING SERVICE CO., LTD.

A101, No.65, Zhuji Highway, Tianhe District, Guangzhou, China
 Tel: +86-20-85543113 (32 lines) Fax: +86-20-38780406
 Complaint line: +86-20-85533471 E-mail: cts@cts-lab.com.cn

See Reverse For Terms And Conditions of Service

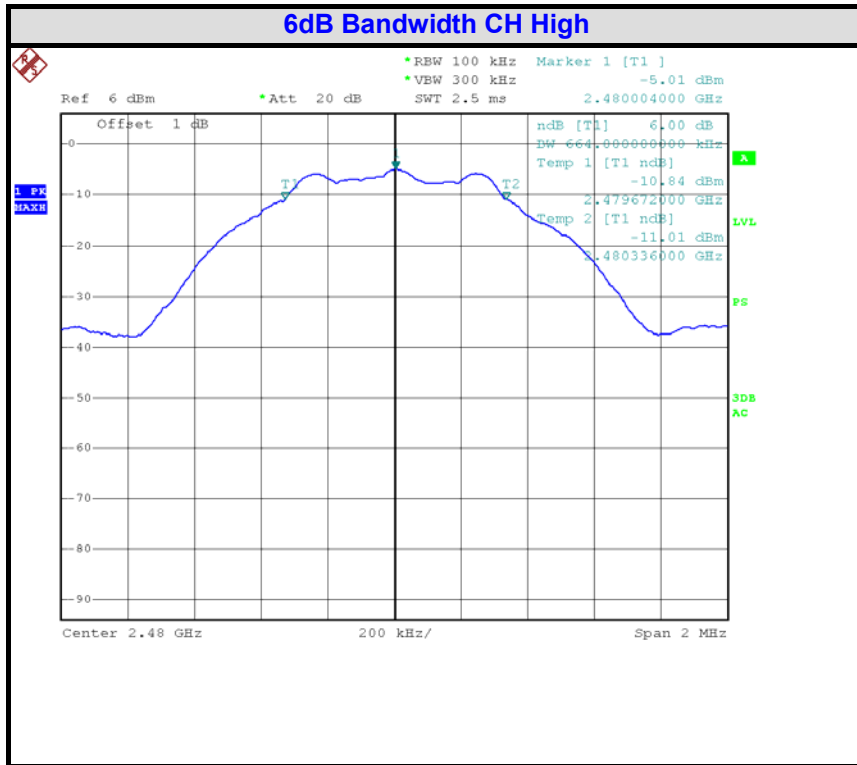

Copyright of this report is owned by Centre of Testing Service and may not be reproduced other than in full except with the written approval of the issuing Company.

CENTRE OF TESTING SERVICE CO., LTD.

A101, No.65, Zhuji Highway, Tianhe District, Guangzhou, China
 Tel: +86-20-85543113 (32 lines) Fax: +86-20-38780406
 Complaint line: +86-20-85533471 E-mail: cts@cts-lab.com.cn

See Reverse For Terms And Conditions of Service

8.0 OUTPUT POWER

8.1 LIMIT

The maximum output power of the intentional radiator shall not exceed the following:

1. According to §15.247(b)(3), RSS-247 Issue 2§ 5.4(4), for systems using digital modulation in the bands of 902-928 MHz, 2400-2483.5 MHz, and 5725-5850 MHz: 1 Watt.
2. According to §15.247(b)(4), the conducted output power limit specified in paragraph (b) of this section is based on the use of antennas with directional gains that do not exceed 6 dBi. Except as shown in paragraph (c) of this section, if transmitting antennas of directional gain greater than 6 dBi are used, the conducted output power from the intentional radiator shall be reduced below the stated values in paragraphs (b)(1), (b)(2), and (b)(3) of this section, as appropriate, by the amount in dB that the directional gain of the antenna exceeds 6 dBi.

8.2 MEASUREMENT EQUIPMENT USED

Peak Power					
Item	Test Equipment	Manufacturer	Model No.	Serial No.	Last Cal.
1	Power meter	ROHDE & SCHWARZ	NRVS	842856/049	2017/03
2	Power Sensor	ROHDE & SCHWARZ	NRP-Z21	1137.6000.02	2017/03

8.3 TEST CONDIGURATION

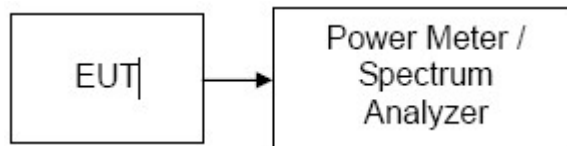

8.4 TEST PROCEDURE

1. According to KDB 558074 D01 Setup the Power Sensor on Average mode.
2. Set the EUT on transmit continuously mode.



8.5 TEST RESULTS

Passed Test Data

Modulation Standard	Channel	Frequency (MHz)	Average Output Power (dBm)	Limit (dBm)	Result
GFSK	Low	2402	-4.76	30dBm	PASSED
	Middle	2440	-4.34		PASSED
	High	2480	-4.38		PASSED

Copyright of this report is owned by Centre of Testing Service and may not be reproduced other than in full except with the written approval of the issuing Company.

CENTRE OF TESTING SERVICE CO., LTD.

A101, No.65, Zhuji Highway, Tianhe District, Guangzhou, China

Tel: +86-20-85543113 (32 lines)

Fax: +86-20-38780406

Complaint line: +86-20-85533471

E-mail: cts@cts-lab.com.cn

See Reverse For Terms And Conditions of Service

9.0 PEAK POWER SPECTRAL DENSITY

9.1 LIMIT

1. According to §15.247(e), RSS-247 Issue 2 § 5.2(2), For DTSs include systems that employ digital modulation techniques resulting in spectral characteristics similar to direct sequence systems. The following applies to the bands 902-928 MHz and 2400-2483.5 MHz:

The transmitter power spectral density conducted from the transmitter to the antenna shall not be greater than 8 dBm in any 3 kHz band during any time interval of continuous transmission. This power spectral density shall be determined in accordance with the provisions of Section 5.4(4), (i.e. the power spectral density shall be determined using the same method as is used to determine the conducted output power).

9.2 MEASUREMENT EQUIPMENT USED

Peak Power Spectral Density					
Item	Test Equipment	Manufacturer	Model No.	Serial No.	Last Cal.
1	Signal analyzer	ROHDE & SCHWARZ	FSIQ26	100311	2017/03

9.3 TEST CONFIGURATION

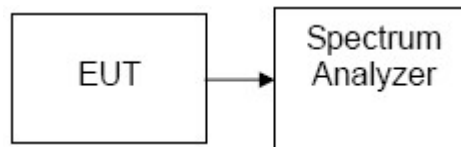

9.4 TEST PROCEDURE

1. Place the EUT on the table and set it in transmitting mode.
2. Remove the antenna from the EUT and then connect a low loss RF cable from the antenna port to the spectrum analyzer.
3. Set the spectrum analyzer as RBW = 10kHz, VBW = 30kHz, Span = 1.5 times the bandwidth, Sweep=Auto couple
4. Record the max. reading.
5. Repeat the above procedure until the measurements for all frequencies are completed.

9.5 TEST RESULTS

PASSED



Test Data

Modulation Standard	Channel	Frequency (MHz)	PPSD (dBm/3KHz)	Limit (dBm/3KHz)	Result
GFSK	Low	2402	-20.01	8	PASSED
	Middle	2440	-19.77		PASSED
	High	2480	-19.58		PASSED

Copyright of this report is owned by Centre of Testing Service and may not be reproduced other than in full except with the written approval of the issuing Company.

CENTRE OF TESTING SERVICE CO., LTD.

A101, No.65, Zhuji Highway, Tianhe District, Guangzhou, China

Tel: +86-20-85543113 (32 lines)

Fax: +86-20-38780406

Complaint line: +86-20-85533471

E-mail: cts@cts-lab.com.cn

See Reverse For Terms And Conditions of Service

Test Plot

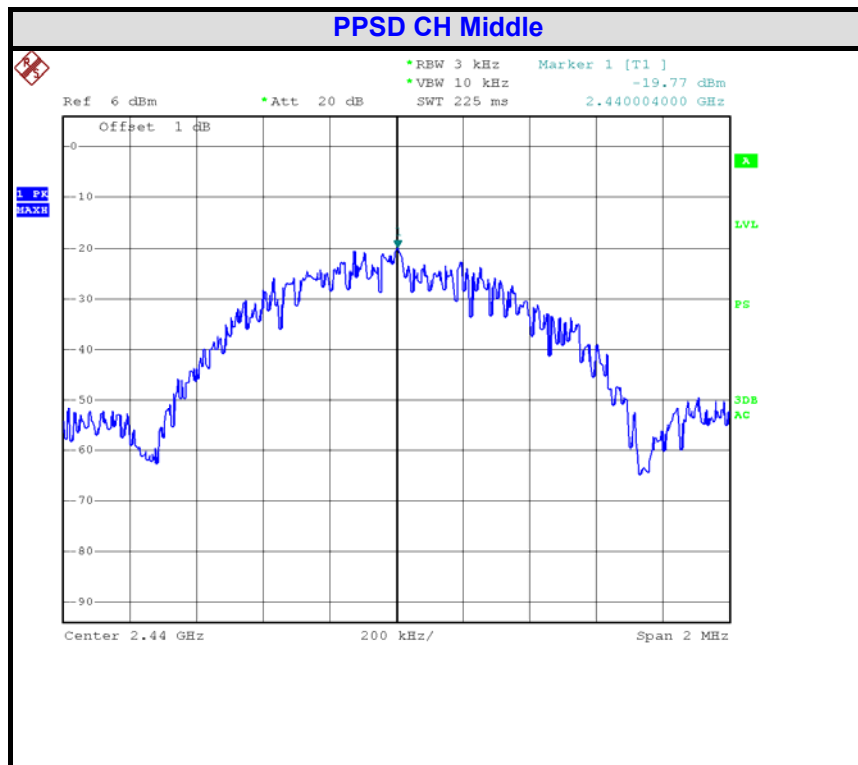
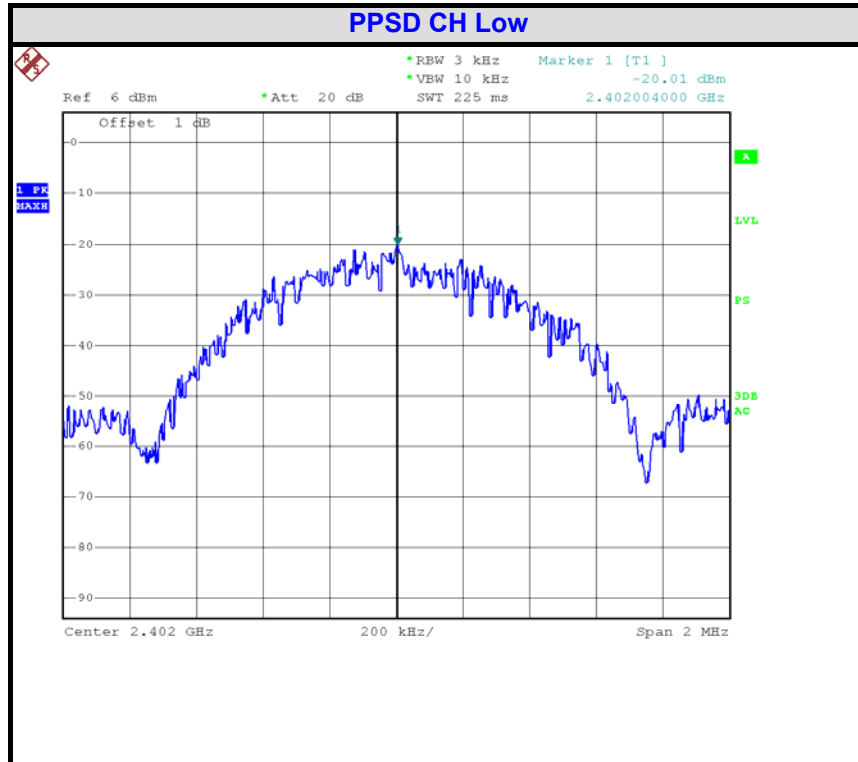

Copyright of this report is owned by Centre of Testing Service and may not be reproduced other than in full except with the written approval of the issuing Company.

CENTRE OF TESTING SERVICE CO., LTD.

A101, No.65, Zhuji Highway, Tianhe District, Guangzhou, China

Tel: +86-20-85543113 (32 lines)

Fax: +86-20-38780406

Complaint line: +86-20-85533471

E-mail: cts@cts-lab.com.cn

See Reverse For Terms And Conditions of Service

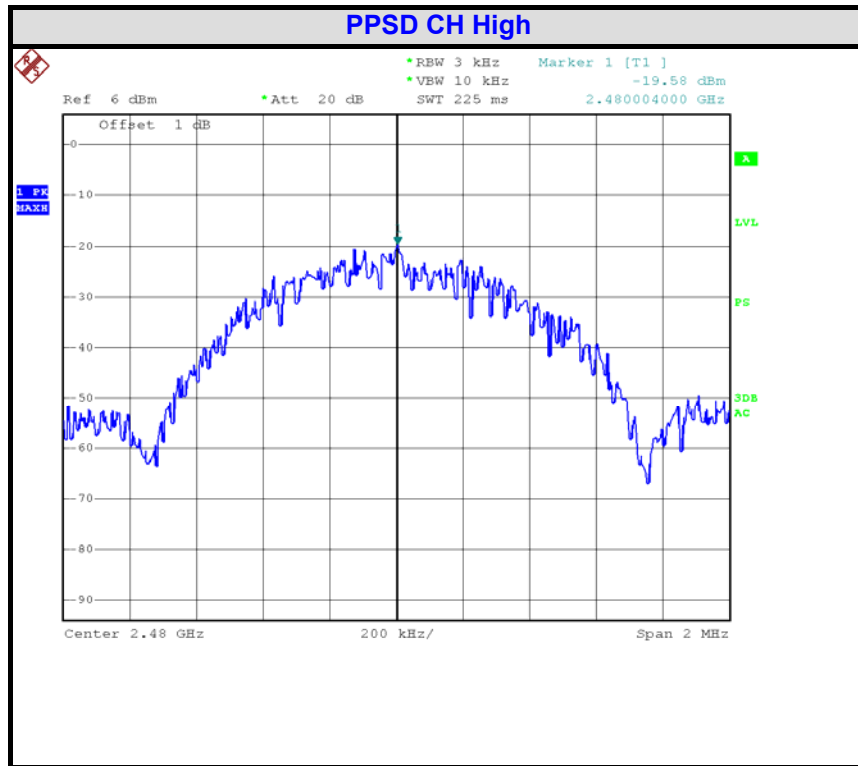

Copyright of this report is owned by Centre of Testing Service and may not be reproduced other than in full except with the written approval of the issuing Company.

CENTRE OF TESTING SERVICE CO., LTD.

A101, No.65, Zhuji Highway, Tianhe District, Guangzhou, China

Tel: +86-20-85543113 (32 lines)

Fax: +86-20-38780406

Complaint line: +86-20-85533471

E-mail: cts@cts-lab.com.cn

See Reverse For Terms And Conditions of Service

10.0 BAND EDGES MEASUREMENT

10.1 LIMIT

According to §15.247(d), RSS-247 Issue 2 § 5.2(2) In any 100 kHz bandwidth outside the frequency band in which the spread spectrum or digitally modulated device is operating, the RF power that is produced shall be at least 20 dB below that in the 100 kHz bandwidth within the band that contains the highest level of the desired power, based on either an RF conducted or a radiated measurement, provided that the transmitter demonstrates compliance with the peak conducted power limits. If the transmitter complies with the conducted power limits based on the use of root-mean-square averaging over a time interval, as permitted under Section 5.4(4), the attenuation required shall be 30 dB instead of 20 dB. Attenuation below the general field strength limits specified in RSS-Gen is not required..

10.2 MEASUREMENT EQUIPMENT USED

Radiated disturbance (electric field)					
Item	Test Equipment	Manufacturer	Model No.	Serial No.	Last Cal.
1	Signal analyzer	ROHDE & SCHWARZ	FSIQ26	100311	2017/03

10.3 Test Configuration

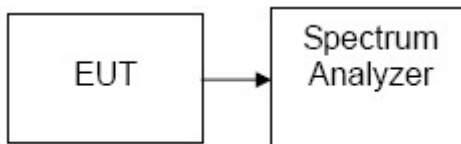

10.4 TEST PROCEDURE

1. Place the EUT on the table and set it in transmitting mode.
2. Remove the antenna from the EUT and then connect a low loss RF cable from the antenna port to the spectrum analyzer.
3. Set the spectrum analyzer as RBW = 100kHz, VBW = 300kHz, Sweep=Auto couple
4. Record the max. reading.
5. Repeat the above procedure until the measurements for all frequencies are

10.5 TEST RESULTS

Refer to attach spectrum analyzer data chart.

Test Polt:

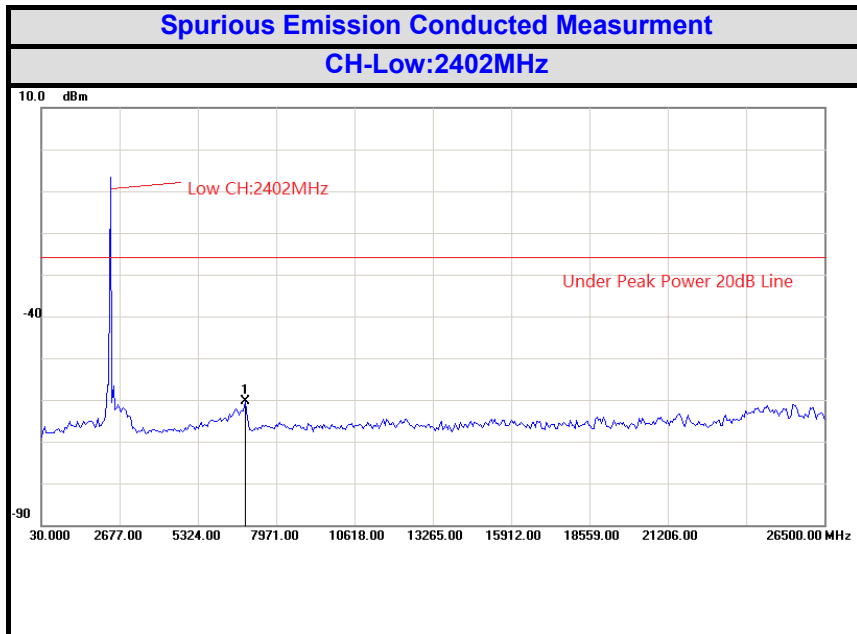
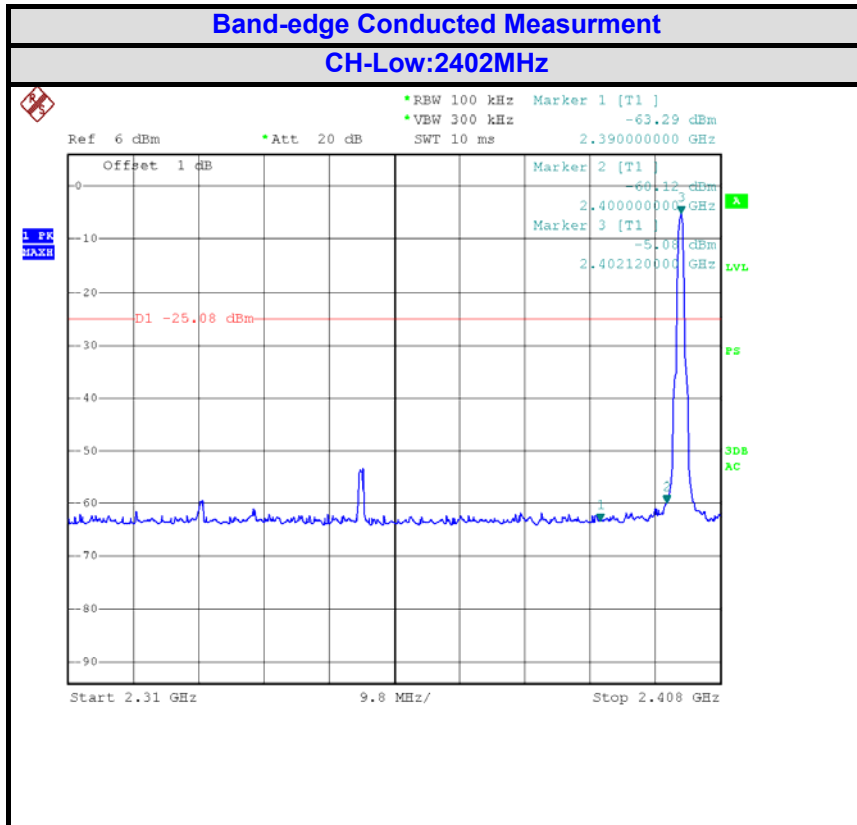

Copyright of this report is owned by Centre of Testing Service and may not be reproduced other than in full except with the written approval of the issuing Company.

CENTRE OF TESTING SERVICE CO., LTD.

A101, No.65, Zhuji Highway, Tianhe District, Guangzhou, China
 Tel: +86-20-85543113 (32 lines) Fax: +86-20-38780406
 Complaint line: +86-20-85533471 E-mail: cts@cts-lab.com.cn

See Reverse For Terms And Conditions of Service

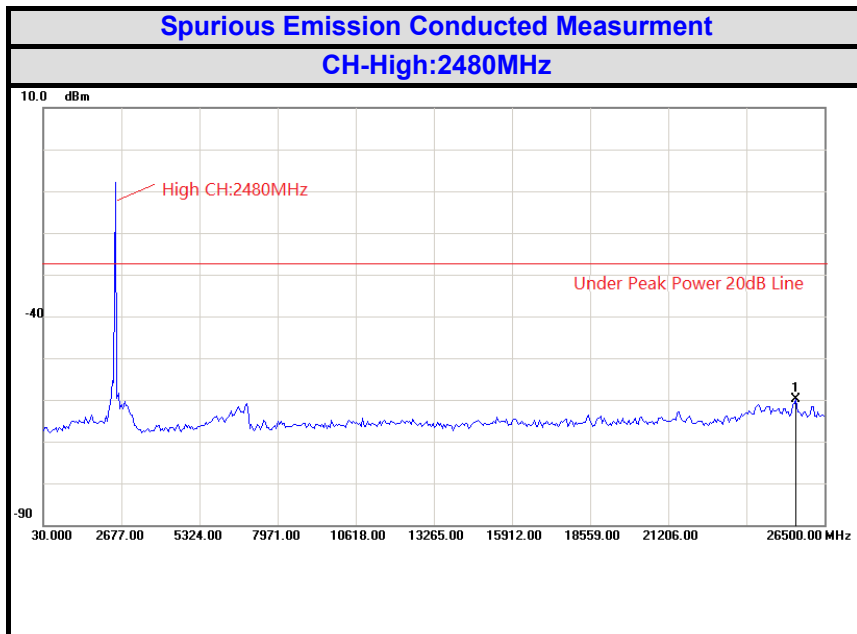
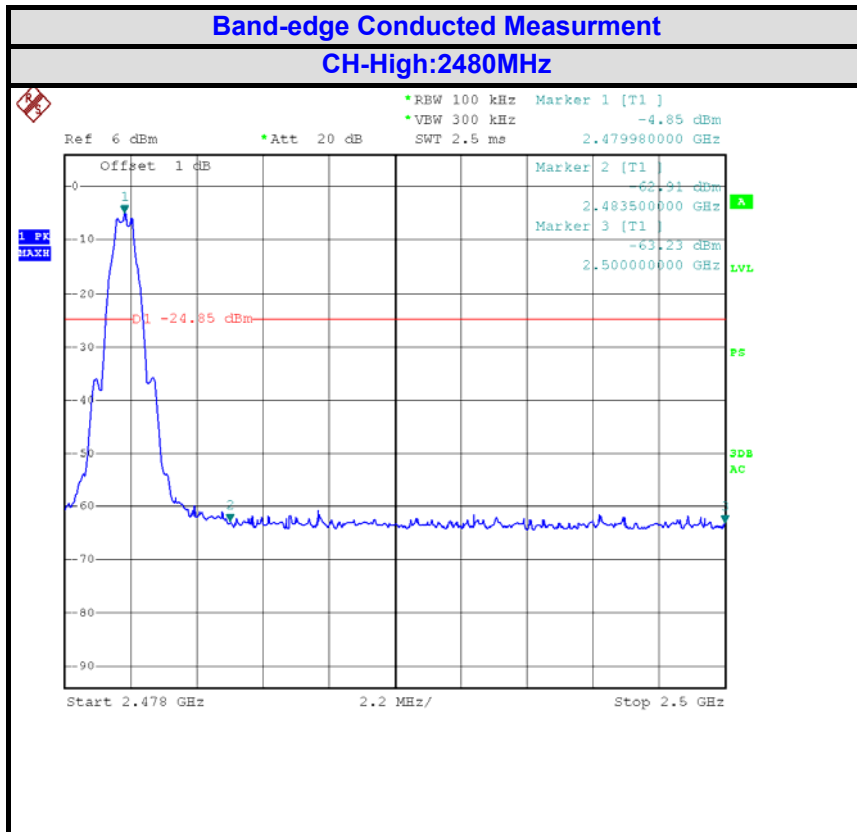

Copyright of this report is owned by Centre of Testing Service and may not be reproduced other than in full except with the written approval of the issuing Company.

CENTRE OF TESTING SERVICE CO., LTD.

A101, No.65, Zhuji Highway, Tianhe District, Guangzhou, China
 Tel: +86-20-85543113 (32 lines) Fax: +86-20-38780406
 Complaint line: +86-20-85533471 E-mail: cts@cts-lab.com.cn

See Reverse For Terms And Conditions of Service

11.0 SPURIOUS EMISSIONS

11.1 LIMIT

Except as provided elsewhere in this Subpart, the emissions from an intentional radiator shall not exceed the field strength levels specified in the following table:

FREQUENCY MHz	DISTANCE Meters	FIELD STRENGTHS LIMIT	
		$\mu\text{V}/\text{m}$	$\text{dB}(\mu\text{V})/\text{m}$
0.009 ~ 0.490	300	2400/F(kHz)	---
0.490 ~ 1.705	30	24000/F(kHz)	---
1.705 ~ 30	30	30	---
30 ~ 88	3	100	40.0
88 ~ 216	3	150	43.5
216 ~ 960	3	200	46.0
960 ~ 1000	3	500	54.0
Above 1000	3	Other:74.0 dB(μV)/m (Peak) 54.0 dB(μV)/m (Average)	

Note: Except as provided in paragraph (g), fundamental emissions from intentional radiators operating under this Section shall not be located in the frequency bands 54-72 MHz, 76-88 MHz, 174-216 MHz or 470-806 MHz. However, operation within these frequency bands is permitted under other sections of this Part, e.g.

11.2 Test Equipment

Radiated disturbance (electric field)					
Item	Test Equipment	Manufacturer	Model No.	Serial No.	Last Cal.
1	EMI Test Receiver	ROHDE & SCHWARZ	ESCI	100868	2016/11
2	Biconical Antenna	ROHDE & SCHWARZ	HK116	100221	2017/03
3	Log per Antenna	ROHDE & SCHWARZ	HL223	100226	2017/03
4	Log per Antenna	ROHDE & SCHWARZ	HL050	100186	2017/03
5	Signal analyzer	ROHDE & SCHWARZ	FSIQ26	100311	2017/03
6	Loop Antenna	A.R.A	PLA-1030/B	1030	2016/11
7	EMI Test Software	EZ-EMC	Farad	N/A	N/A

Copyright of this report is owned by Centre of Testing Service and may not be reproduced other than in full except with the written approval of the issuing Company.

CENTRE OF TESTING SERVICE CO., LTD.

A101, No.65, Zhuji Highway, Tianhe District, Guangzhou, China

Tel: +86-20-85543113 (32 lines)

Fax: +86-20-38780406

Complaint line: +86-20-85533471

E-mail: cts@cts-lab.com.cn

See Reverse For Terms And Conditions of Service

11.3 TEST CONFIGURATION

Below 30MHz

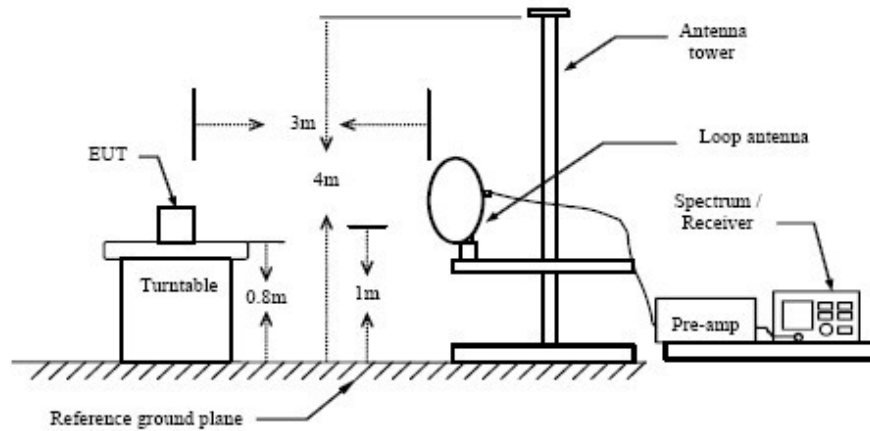

Below 1 GHz

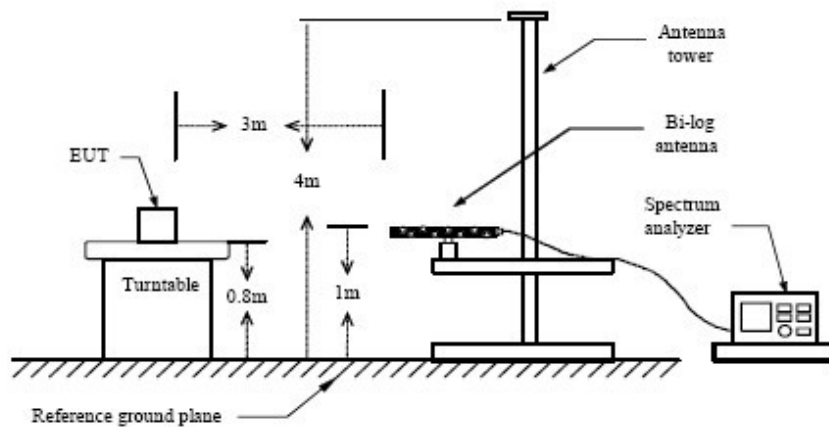

Above 1 GHz

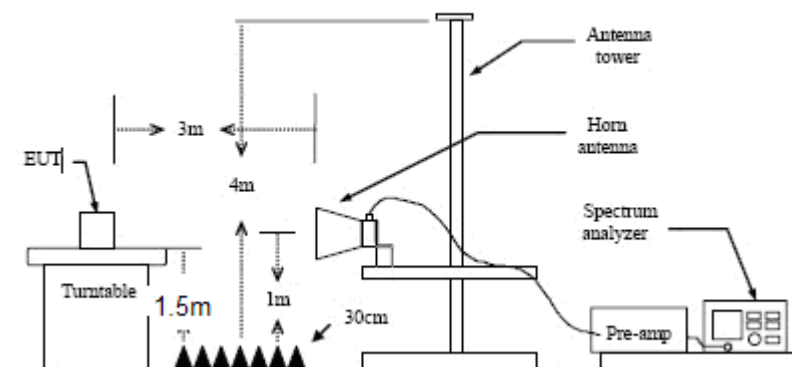

Copyright of this report is owned by Centre of Testing Service and may not be reproduced other than in full except with the written approval of the issuing Company.

CENTRE OF TESTING SERVICE CO., LTD.

A101, No.65, Zhuji Highway, Tianhe District, Guangzhou, China
 Tel: +86-20-85543113 (32 lines) Fax: +86-20-38780406
 Complaint line: +86-20-85533471 E-mail: cts@cts-lab.com.cn

See Reverse For Terms And Conditions of Service



11.4 TEST PROCEDURE

1. The EUT is placed on a turntable, which is 0.8m for below 1GHz (1.5m for above 1GHz) above ground plane.
2. The turntable shall be rotated for 360 degrees to determine the position of maximum emission level.
3. EUT is set 3m away from the receiving antenna, which is varied from 1m to 4m to find out the highest emissions.
4. Maximum procedure was performed on the six highest emissions to ensure EUT compliance.
5. And also, each emission was to be maximized by changing the polarization of receiving antenna both horizontal and vertical.
6. Repeat above procedures until the measurements for all frequencies are complete.

11.5 TEST RESULTS

The frequency range from 9KHz~30MHz, 30MHz to 230MHz, 230MHz to 1000MHz and above 1GHz. is investigated. Please see the following pages.

Copyright of this report is owned by Centre of Testing Service and may not be reproduced other than in full except with the written approval of the issuing Company.

CENTRE OF TESTING SERVICE CO., LTD.

A101, No.65, Zhuji Highway, Tianhe District, Guangzhou, China

Tel: +86-20-85543113 (32 lines)

Fax: +86-20-38780406

Complaint line: +86-20-85533471

E-mail: cts@cts-lab.com.cn

See Reverse For Terms And Conditions of Service



Test Mode:	TX -X Position Mode	Result:	<input checked="" type="checkbox"/> - passed
Frequency range:	9KHz~30MHz		<input type="checkbox"/> - not passed

No.	Frequency (MHz)	Factor (dB)	Reading (dBuV)	Level (dBuV/m)	Limit (dBuV/m)	Margin (dB)	Det.
Remark: The test result reading value is to low, margin all > 20dB of the limit.							

Copyright of this report is owned by Centre of Testing Service and may not be reproduced other than in full except with the written approval of the issuing Company.

CENTRE OF TESTING SERVICE CO., LTD.

A101, No.65, Zhuji Highway, Tianhe District, Guangzhou, China

Tel: +86-20-85543113 (32 lines)

Fax: +86-20-38780406

Complaint line: +86-20-85533471

E-mail: cts@cts-lab.com.cn

See Reverse For Terms And Conditions of Service



EUT	QCA6234
Operating Condition	DC 3.6V
Test Condition	Ambient Temperature: 25°C Humidity: 56%
Test distance	3 Meter
Test Date:	13 April ~21 June 2017
Operator	Duke
MODEL NO	QCA6234

Channel:	TX -X Position	Result:	■ - passed
Test point:	Horizontal		□ - not passed
Frequency range:	30MHz-1GHz		

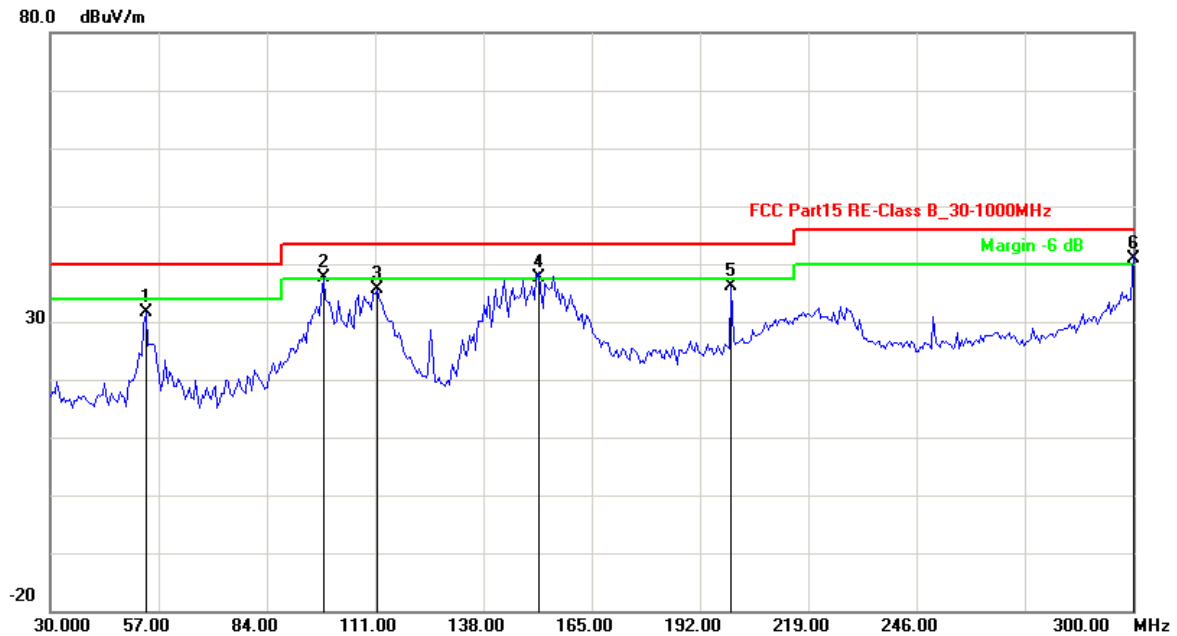

No.	Frequency (MHz)	Factor (dB)	Reading (dBuV)	Level (dBuV/m)	Limit (dBuV/m)	Margin (dB)	Det.
1	53.8076	-18.17	49.84	31.67	40.00	-8.33	QP
2	98.1763	-17.68	55.20	37.52	43.50	-5.98	QP
3	111.7034	-16.59	52.17	35.58	43.50	-7.92	QP
4	151.7434	-15.30	52.98	37.68	43.50	-5.82	QP
5	199.8997	-11.74	47.88	36.14	43.50	-7.36	QP
6	300.0000	-1.13	42.08	40.95	46.00	-5.05	QP

Remark: Other frequency mini margin all >6 dB of Limit

Copyright of this report is owned by Centre of Testing Service and may not be reproduced other than in full except with the written approval of the issuing Company.

CENTRE OF TESTING SERVICE CO., LTD.

A101, No.65, Zhuji Highway, Tianhe District, Guangzhou, China
 Tel: +86-20-85543113 (32 lines) Fax: +86-20-38780406
 Complaint line: +86-20-85533471 E-mail: cts@cts-lab.com.cn

See Reverse For Terms And Conditions of Service

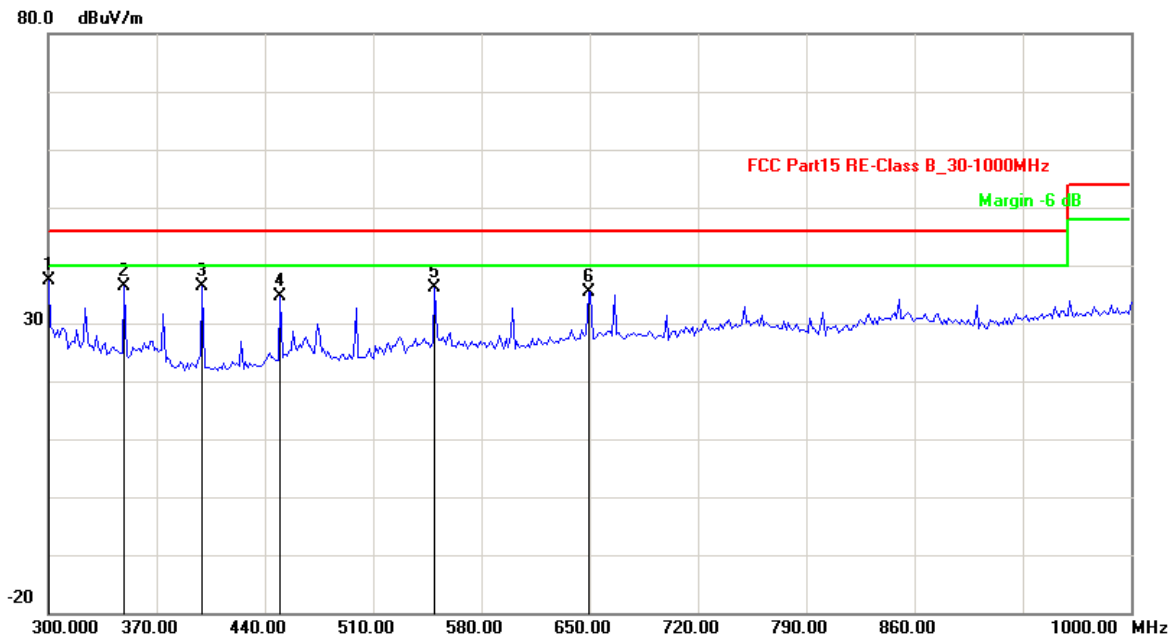

No.	Frequency (MHz)	Factor (dB)	Reading (dBuV)	Level (dBuV/m)	Limit (dBuV/m)	Margin (dB)	Det.
1	300.0000	-13.13	50.61	37.48	46.00	-8.52	QP
2	349.0981	-11.08	47.44	36.36	46.00	-9.64	QP
3	399.5991	-10.29	46.71	36.42	46.00	-9.58	QP
4	450.1001	-8.21	42.79	34.58	46.00	-11.42	QP
5	549.6993	-5.51	41.67	36.16	46.00	-9.84	QP
6	649.2985	-3.18	38.62	35.44	46.00	-10.56	QP

Remark: Other frequency mini margin all >6 dB of Limit

Copyright of this report is owned by Centre of Testing Service and may not be reproduced other than in full except with the written approval of the issuing Company.

CENTRE OF TESTING SERVICE CO., LTD.

A101, No.65, Zhuji Highway, Tianhe District, Guangzhou, China

Tel: +86-20-85543113 (32 lines)

Fax: +86-20-38780406

Complaint line: +86-20-85533471

E-mail: cts@cts-lab.com.cn

See Reverse For Terms And Conditions of Service



Channel:	Low Channel	Result: <input checked="" type="checkbox"/> - passed <input type="checkbox"/> - not passed
Test point:	Horizontal	
Frequency range:	1GHz-26.5GHz	

No.	Frequency (MHz)	Factor (dB)	Reading (dBuV)	Level (dBuV/m)	Limit (dBuV/m)	Margin (dB)	Det.
1	1727.455	3.14	40.14	43.28	74.00	-30.72	peak
2	1727.455	3.14	28.33	31.47	54.00	-22.53	AVG
3	5474.950	7.33	38.30	45.63	74.00	-28.37	peak
4	5474.950	7.33	26.19	33.52	54.00	-20.48	AVG

Remark: Other frequency mini margin all >20 dB of Limit

Channel:	Middle Channel	Result: <input checked="" type="checkbox"/> - passed <input type="checkbox"/> - not passed
Test point:	Horizontal	
Frequency range:	1GHz-26.5GHz	

No.	Frequency (MHz)	Factor (dB)	Reading (dBuV)	Level (dBuV/m)	Limit (dBuV/m)	Margin (dB)	Det.
1	1529.058	1.99	39.71	41.70	74.00	-32.30	peak
2	1529.058	1.99	26.60	28.59	54.00	-25.41	AVG
3	4923.848	5.67	37.29	42.96	74.00	-31.04	peak
4	4923.848	5.67	24.80	30.47	54.00	-23.53	AVG

Remark: Other frequency mini margin all >20 dB of Limit

Channel:	High Channel	Result: <input checked="" type="checkbox"/> - passed <input type="checkbox"/> - not passed
Test point:	Horizontal	
Frequency range:	1GHz-26.5GHz	

No.	Frequency (MHz)	Factor (dB)	Reading (dBuV)	Level (dBuV/m)	Limit (dBuV/m)	Margin (dB)	Det.
1	1749.499	3.27	39.69	42.96	74.00	-31.04	peak
2	1749.499	3.27	27.20	30.47	54.00	-23.53	AVG
3	5519.038	7.46	39.35	46.81	74.00	-27.19	peak
4	5519.038	7.46	27.12	34.58	54.00	-19.42	AVG

Remark: Other frequency mini margin all >20 dB of Limit

Copyright of this report is owned by Centre of Testing Service and may not be reproduced other than in full except with the written approval of the issuing Company.

CENTRE OF TESTING SERVICE CO., LTD.

A101, No.65, Zhuji Highway, Tianhe District, Guangzhou, China
 Tel: +86-20-85543113 (32 lines) Fax: +86-20-38780406
 Complaint line: +86-20-85533471 E-mail: cts@cts-lab.com.cn

See Reverse For Terms And Conditions of Service



Channel:	Low Channel	Result: <input checked="" type="checkbox"/> - passed <input type="checkbox"/> - not passed
Test point:	Horizontal	
Frequency range:	1GHz-26.5GHz	

No.	Frequency (MHz)	Factor (dB)	Reading (dBuV)	Level (dBuV/m)	Limit (dBuV/m)	Margin (dB)	Det.
1	3248.497	4.10	37.13	41.23	74.00	-32.77	peak
2	3248.497	4.10	25.00	29.10	54.00	-24.90	AVG
3	5585.170	7.66	39.79	47.45	74.00	-26.55	peak
4	5585.170	7.66	27.98	35.64	54.00	-18.36	AVG

Remark: Other frequency mini margin all >20 dB of Limit

Channel:	Middle Channel	Result: <input checked="" type="checkbox"/> - passed <input type="checkbox"/> - not passed
Test point:	Horizontal	
Frequency range:	1GHz-26.5GHz	

No.	Frequency (MHz)	Factor (dB)	Reading (dBuV)	Level (dBuV/m)	Limit (dBuV/m)	Margin (dB)	Det.
1	3292.585	4.01	35.47	39.48	74.00	-34.52	peak
2	3292.585	4.01	23.40	27.41	54.00	-26.59	AVG
3	6334.669	9.73	38.97	48.70	74.00	-25.30	peak
4	6334.669	9.73	26.85	36.58	54.00	-17.42	AVG

Remark: Other frequency mini margin all >20 dB of Limit

Channel:	High Channel	Result: <input checked="" type="checkbox"/> - passed <input type="checkbox"/> - not passed
Test point:	Horizontal	
Frequency range:	1GHz-26.5GHz	

No.	Frequency (MHz)	Factor (dB)	Reading (dBuV)	Level (dBuV/m)	Limit (dBuV/m)	Margin (dB)	Det.
1	1727.455	3.14	41.48	44.62	74.00	-29.38	peak
2	1727.455	3.14	29.60	32.74	54.00	-21.26	AVG
3	5496.994	7.40	39.38	46.78	74.00	-27.22	peak
4	5496.994	7.40	26.45	33.85	54.00	-20.15	AVG

Remark: Other frequency mini margin all >20 dB of Limit

Copyright of this report is owned by Centre of Testing Service and may not be reproduced other than in full except with the written approval of the issuing Company.

CENTRE OF TESTING SERVICE CO., LTD.

A101, No.65, Zhuji Highway, Tianhe District, Guangzhou, China
 Tel: +86-20-85543113 (32 lines) Fax: +86-20-38780406
 Complaint line: +86-20-85533471 E-mail: cts@cts-lab.com.cn

See Reverse For Terms And Conditions of Service



12.0 RECEIVER SUPRIIOUS EMISSION

12.1 LIMIT

According to RSS-Gen Issue 4§7.0.Except as provided elsewhere in this Subpart, the emissions from an intentional radiator shall not exceed the field strength levels specified in the following table:

FREQUENCY MHz	DISTANCE Meters	FIELD STRENGTHS LIMIT	
		$\mu\text{V}/\text{m}$	$\text{dB}(\mu\text{V})/\text{m}$
30 ~ 88	3	100	40.0
88 ~ 216	3	150	43.5
216 ~ 960	3	200	46.0
960 ~ 1000	3	500	54.0
Above 1000	3	Other:74.0 $\text{dB}(\mu\text{V})/\text{m}$ (Peak) 54.0 $\text{dB}(\mu\text{V})/\text{m}$ (Average)	

12.2 TEST EQUIPMENT

Radiated disturbance (electric field)					
Item	Test Equipment	Manufacturer	Model No.	Serial No.	Last Cal.
1	EMI Test Receiver	ROHDE & SCHWARZ	ESCI	100868	2015/10
2	Biconical Antenna	ROHDE & SCHWARZ	HK116	100221	2017/03
3	Log per Antenna	ROHDE & SCHWARZ	HL223	100226	2017/03
4	Log per Antenna	ROHDE & SCHWARZ	HL050	100186	2017/03
5	Signal analyzer	ROHDE & SCHWARZ	FSIQ26	100311	2017/03
6	Loop Antenna	A.R.A	PLA-1030/B	1030	2015/10
7	EMI Test Software	EZ-EMC	Farad	N/A	N/A

Copyright of this report is owned by Centre of Testing Service and may not be reproduced other than in full except with the written approval of the issuing Company.

CENTRE OF TESTING SERVICE CO., LTD.

A101, No.65, Zhuji Highway, Tianhe District, Guangzhou, China

Tel: +86-20-85543113 (32 lines)

Fax: +86-20-38780406

Complaint line: +86-20-85533471

E-mail: cts@cts-lab.com.cn

See Reverse For Terms And Conditions of Service

12.3 TEST CONFIGURATION

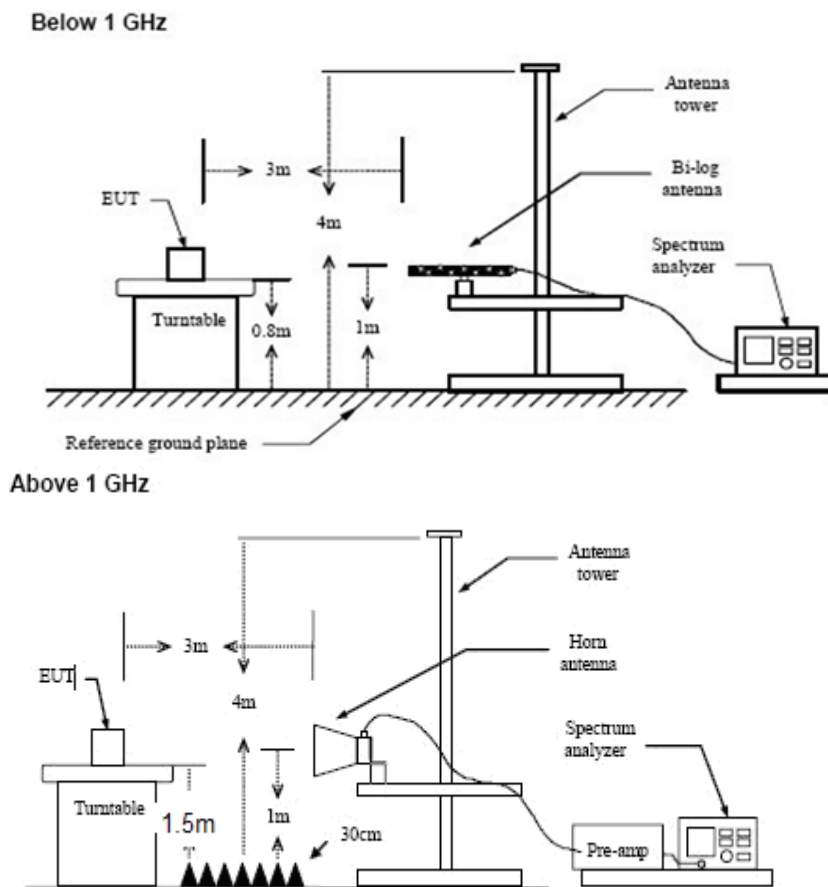

12.4 TEST PROCEDURE

1. The EUT is placed on a turntable, which is 0.8m for below 1GHz (1.5m for above 1GHz) above ground plane.
2. The turntable shall be rotated for 360 degrees to determine the position of maximum emission level.
3. EUT is set 3m away from the receiving antenna, which is varied from 1m to 4m to find out the highest emissions.
4. Maximum procedure was performed on the six highest emissions to ensure EUT compliance.
5. And also, each emission was to be maximized by changing the polarization of receiving antenna both horizontal and vertical.
6. Repeat above procedures until the measurements for all frequencies are complete.

12.5 TEST RESULTS

The frequency range from 30MHz to 230MHz, 230MHz to 1000MHz and above 1GHz. is investigated. Please see the following pages.

Copyright of this report is owned by Centre of Testing Service and may not be reproduced other than in full except with the written approval of the issuing Company.

CENTRE OF TESTING SERVICE CO., LTD.

A101, No.65, Zhuji Highway, Tianhe District, Guangzhou, China

Tel: +86-20-85543113 (32 lines)

Fax: +86-20-38780406

Complaint line: +86-20-85533471

E-mail: cts@cts-lab.com.cn

See Reverse For Terms And Conditions of Service



EUT	QCA6234
Operating Condition	DC 3.6V
Test Condition	Ambient Temperature: 25°C Humidity: 56%
Test distance	3 Meter
Test Date:	13 April ~21 June 2017
Operator	Duke
MODEL NO	QCA6234

Channel:	RX	Result:	■ - passed
Test point:	Horizontal		□ - not passed
Frequency range:	30MHz-1GHz		

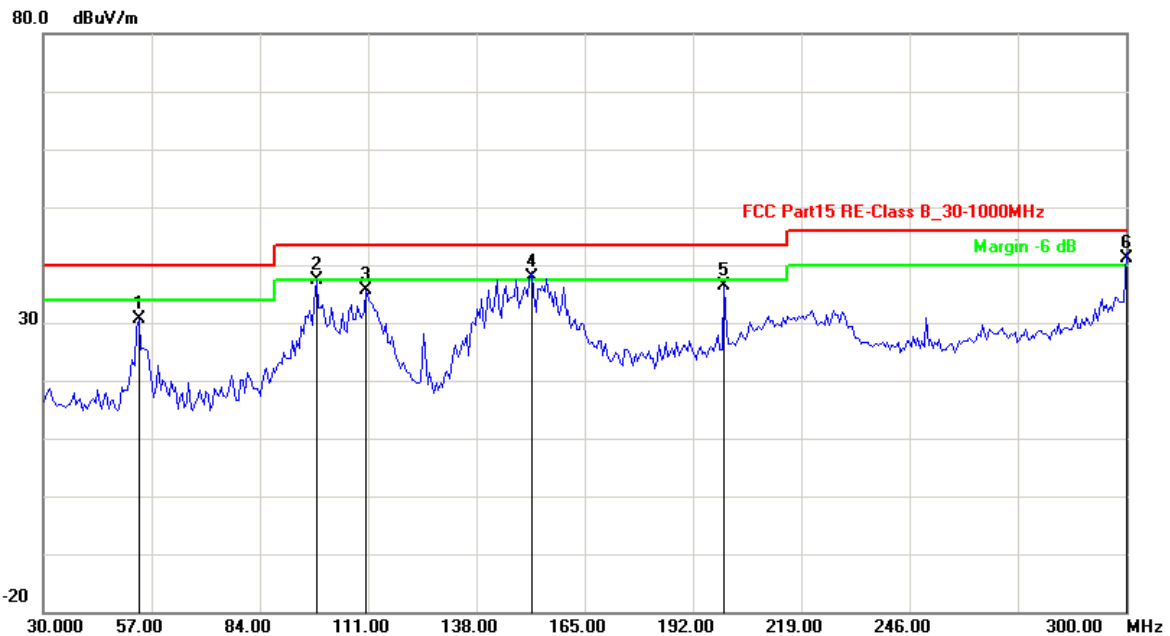

No.	Frequency (MHz)	Factor (dB)	Reading (dBuV)	Level (dBuV/m)	Limit (dBuV/m)	Margin (dB)	Det.
1	53.8076	-18.17	48.71	30.54	40.00	-9.46	QP
2	98.1764	-17.68	55.11	37.43	43.50	-6.07	QP
3	110.6212	-16.65	52.25	35.60	43.50	-7.90	QP
4	151.7434	-15.30	53.15	37.85	43.50	-5.65	QP
5	199.8998	-11.74	48.16	36.42	43.50	-7.08	QP
6	300.0000	-1.13	42.18	41.05	46.00	-4.95	QP

Remark: Other frequency mini margin all >6 dB of Limit

Copyright of this report is owned by Centre of Testing Service and may not be reproduced other than in full except with the written approval of the issuing Company.

CENTRE OF TESTING SERVICE CO., LTD.

A101, No.65, Zhuji Highway, Tianhe District, Guangzhou, China
 Tel: +86-20-85543113 (32 lines) Fax: +86-20-38780406
 Complaint line: +86-20-85533471 E-mail: cts@cts-lab.com.cn

See Reverse For Terms And Conditions of Service

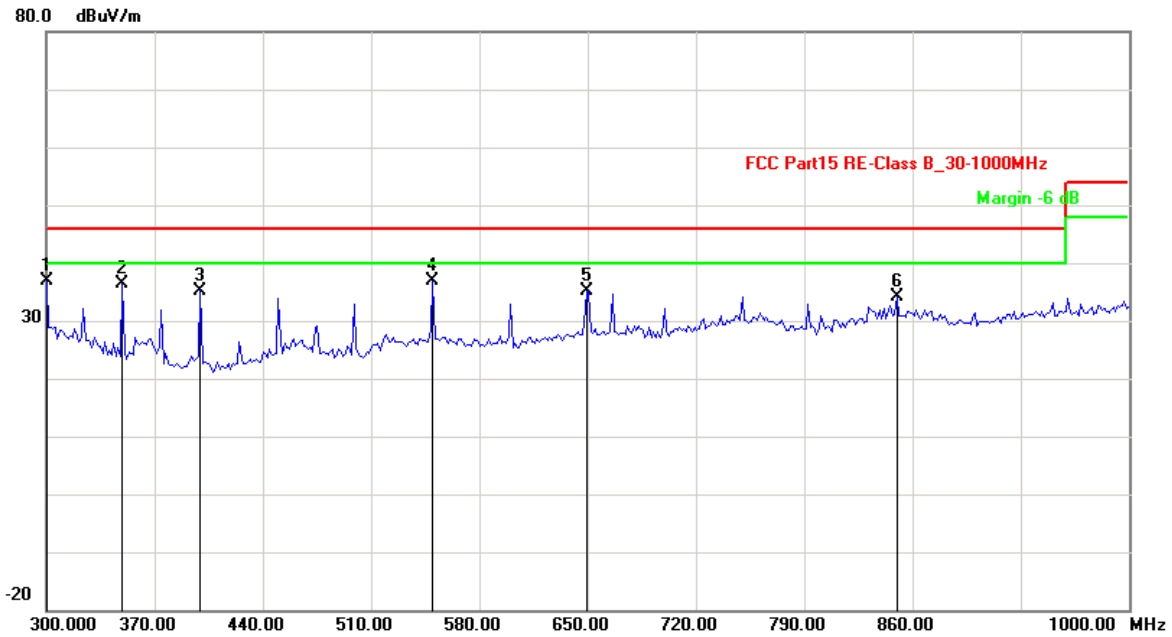

No.	Frequency (MHz)	Factor (dB)	Reading (dBuV)	Level (dBuV/m)	Limit (dBuV/m)	Margin (dB)	Det.
1	300.0000	-13.13	49.92	36.79	46.00	-9.21	QP
2	349.0981	-11.08	47.46	36.38	46.00	-9.62	QP
3	399.5991	-10.29	45.54	35.25	46.00	-10.75	QP
4	549.6993	-5.51	42.28	36.77	46.00	-9.23	QP
5	649.2985	-3.18	38.39	35.21	46.00	-10.79	QP
6	849.8998	-0.14	34.16	34.02	46.00	-11.98	QP

Remark: Other frequency mini margin all >6 dB of Limit

Channel:	RX	Result:	<input checked="" type="checkbox"/> - passed
Test point:	Horizontal		<input type="checkbox"/> - not passed
Frequency range:	1GHz-26.5GHz		

No.	Frequency (MHz)	Factor (dB)	Reading (dBuV)	Level (dBuV/m)	Limit (dBuV/m)	Margin (dB)	Det.
1	1617.234	2.50	38.24	40.74	74.00	-33.26	peak
2	1617.234	2.50	26.09	28.59	54.00	-25.41	AVG
3	5166.333	6.42	37.20	43.62	74.00	-30.38	peak
4	5166.333	6.42	25.32	31.74	54.00	-22.26	AVG

Remark: Other frequency mini margin all >20 dB of Limit

Copyright of this report is owned by Centre of Testing Service and may not be reproduced other than in full except with the written approval of the issuing Company.

CENTRE OF TESTING SERVICE CO., LTD.

A101, No.65, Zhuji Highway, Tianhe District, Guangzhou, China

Tel: +86-20-85543113 (32 lines)

Fax: +86-20-38780406

Complaint line: +86-20-85533471

E-mail: cts@cts-lab.com.cn

See Reverse For Terms And Conditions of Service



Channel:	RX	Result:	■ - passed
Test point:	Vertical		□ - not passed
Frequency range:	30MHz-1GHz		

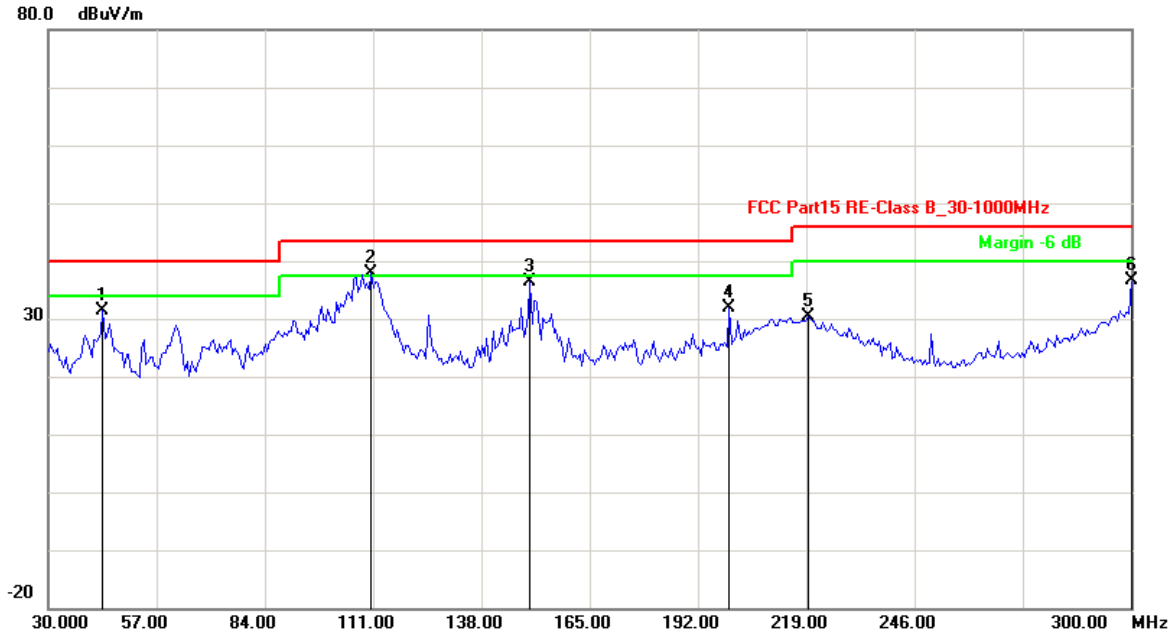

No.	Frequency (MHz)	Factor (dB)	Reading (dBuV)	Level (dBuV/m)	Limit (dBuV/m)	Margin (dB)	Det.
1	43.5270	-16.91	48.17	31.26	40.00	-8.74	QP
2	110.6212	-16.65	54.49	37.84	43.50	-5.66	QP
3	150.1202	-15.29	51.70	36.41	43.50	-7.09	QP
4	199.8997	-11.74	43.67	31.93	43.50	-11.57	QP
5	219.3787	-10.37	40.63	30.26	46.00	-15.74	QP
6	300.0000	-1.13	37.84	36.71	46.00	-9.29	QP

Remark: Other frequency mini margin all >6 dB of Limit

Copyright of this report is owned by Centre of Testing Service and may not be reproduced other than in full except with the written approval of the issuing Company.

CENTRE OF TESTING SERVICE CO., LTD.

A101, No.65, Zhuji Highway, Tianhe District, Guangzhou, China
 Tel: +86-20-85543113 (32 lines) Fax: +86-20-38780406
 Complaint line: +86-20-85533471 E-mail: cts@cts-lab.com.cn

See Reverse For Terms And Conditions of Service

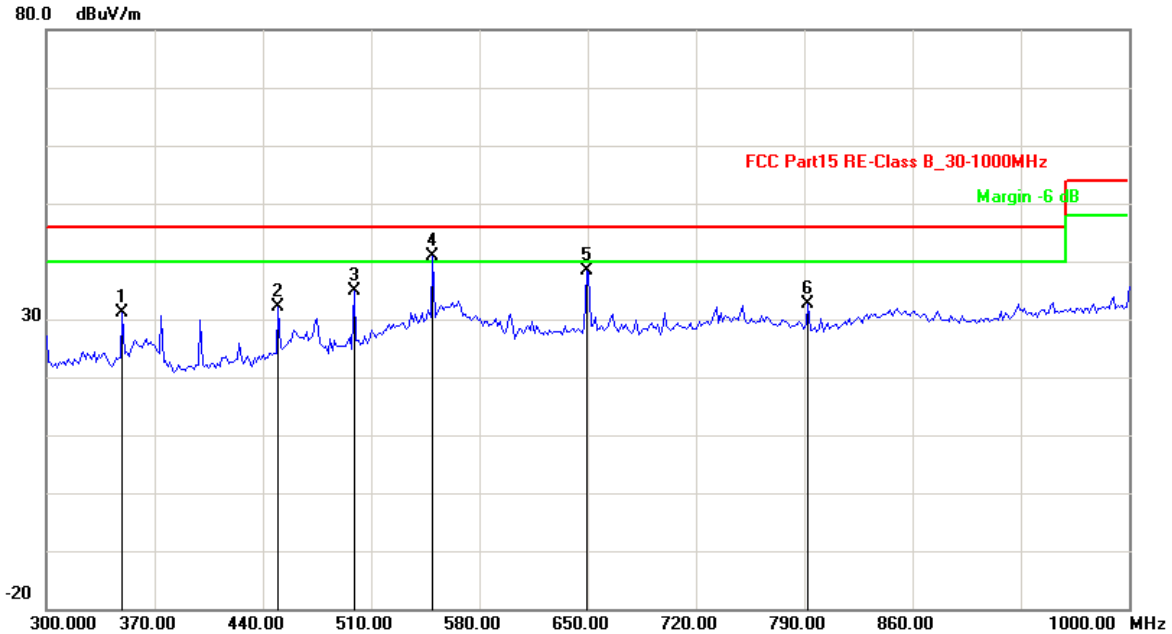

No.	Frequency (MHz)	Factor (dB)	Reading (dBuV)	Level (dBuV/m)	Limit (dBuV/m)	Margin (dB)	Det.
1	349.0982	-11.08	42.20	31.12	46.00	-14.88	QP
2	450.1002	-8.21	40.28	32.07	46.00	-13.93	QP
3	499.1984	-7.68	42.66	34.98	46.00	-11.02	QP
4	549.6994	-5.51	46.33	40.82	46.00	-5.18	QP
5	649.2986	-3.18	41.46	38.28	46.00	-7.72	QP
6	792.3848	-2.71	35.44	32.73	46.00	-13.27	QP

Remark: Other frequency mini margin all >6 dB of Limit

Channel:	RX	Result:	<input checked="" type="checkbox"/> - passed
Test point:	Horizontal		<input type="checkbox"/> - not passed
Frequency range:	1GHz-26.5GHz		

No.	Frequency (MHz)	Factor (dB)	Reading (dBuV)	Level (dBuV/m)	Limit (dBuV/m)	Margin (dB)	Det.
1	3623.246	3.33	35.70	39.03	74.00	-34.97	peak
2	3623.246	3.33	24.08	27.41	54.00	-26.59	AVG
3	5739.479	8.11	38.47	46.58	74.00	-27.42	peak
4	5739.479	8.11	26.47	34.58	54.00	-19.42	AVG

Remark: Other frequency mini margin all >20 dB of Limit

Note: Level=Reading+Factor. Margin= Level-Limit

13. 99% OCCUPIED BANDWIDTH

13.1 TEST PROCEDUR

According to RSS-Gen 6.6 The EUT RF output is connected to the spectrum analyzer. The resolution bandwidth shall be set to as close to 1% of the selected span as is possible without being below 1%. The video bandwidth shall be set to 3 times the resolution bandwidth. Video averaging is not permitted. Where practical, a sampling detector shall be used given that a peak or peak hold may produce a wider bandwidth than actual. The sweep time is coupled.

13.2. TEST EQUIPMENT

Band Edge Compliance test					
Item	Test Equipment	Manufacturer	Model No.	Serial No.	Last Cal.
1	Log per Antenna	ROHDE & SCHWARZ	HL050	100186	2017/03
2	Signal analyzer	ROHDE & SCHWARZ	FSIQ26	100311	2017/03

13.3 TEST CONFIGURATION

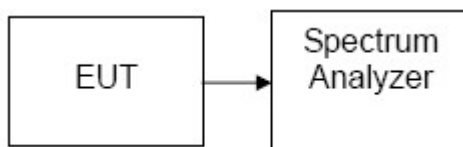

13.4 TEST PROCEDURE

1. Place the EUT on the table and set it in the transmitting mode.
2. Remove the antenna from the EUT, then connect a low loss RF cable from antenna port to the spectrum analyzer.
3. Set the spectrum analyzer as RBW=100kHz, VBW=300kHz, Span=2MHz, Sweep = auto.
4. Mark the peak frequency and set 99% occupied bandwidth function on spectrum.
5. Repeat until all the test channels are investigated.

13.5 TEST RESULTS

Copyright of this report is owned by Centre of Testing Service and may not be reproduced other than in full except with the written approval of the issuing Company.

CENTRE OF TESTING SERVICE CO., LTD.

A101, No.65, Zhuji Highway, Tianhe District, Guangzhou, China
 Tel: +86-20-85543113 (32 lines) Fax: +86-20-38780406
 Complaint line: +86-20-85533471 E-mail: cts@cts-lab.com.cn

See Reverse For Terms And Conditions of Service



Modulation Standard	Channel	Frequency (MHz)	99% Bandwidth (MHz)	Limit (MHz)	Result
GFSK	Low	2402	1.06	----	PASSED
	Middle	2440	1.06		PASSED
	High	2480	1.06		PASSED
Remark: The Bandwidth is Delta 2 of following the graph. And the Delta 2 is Marker 2 subtract Marker 1.					

Copyright of this report is owned by Centre of Testing Service and may not be reproduced other than in full except with the written approval of the issuing Company.

CENTRE OF TESTING SERVICE CO., LTD.

A101, No.65, Zhuji Highway, Tianhe District, Guangzhou, China

Tel: +86-20-85543113 (32 lines)

Fax: +86-20-38780406

Complaint line: +86-20-85533471

E-mail: cts@cts-lab.com.cn

See Reverse For Terms And Conditions of Service

Test Plot:

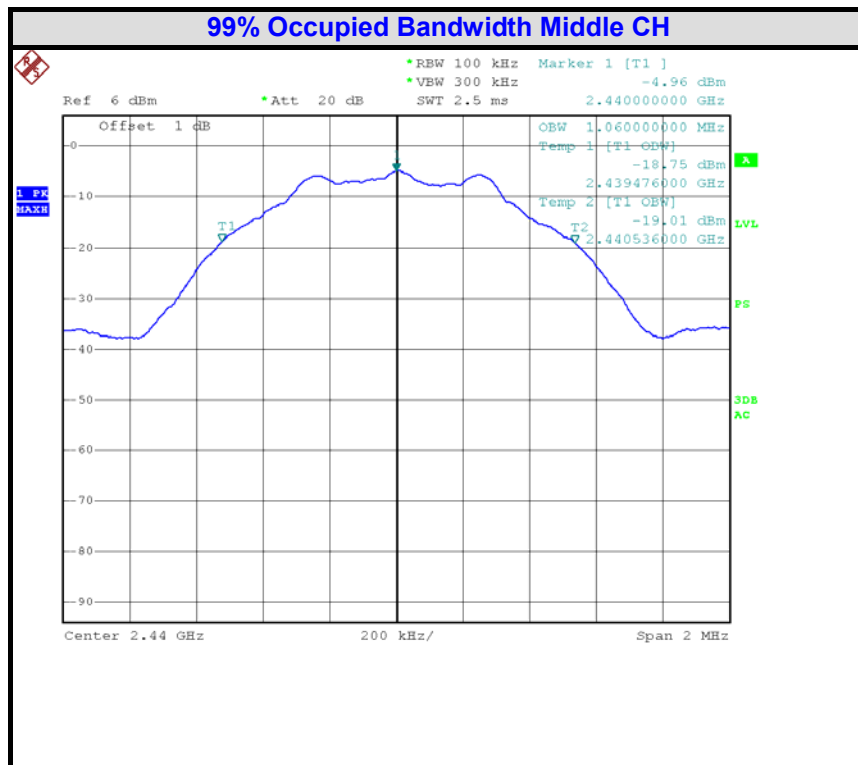
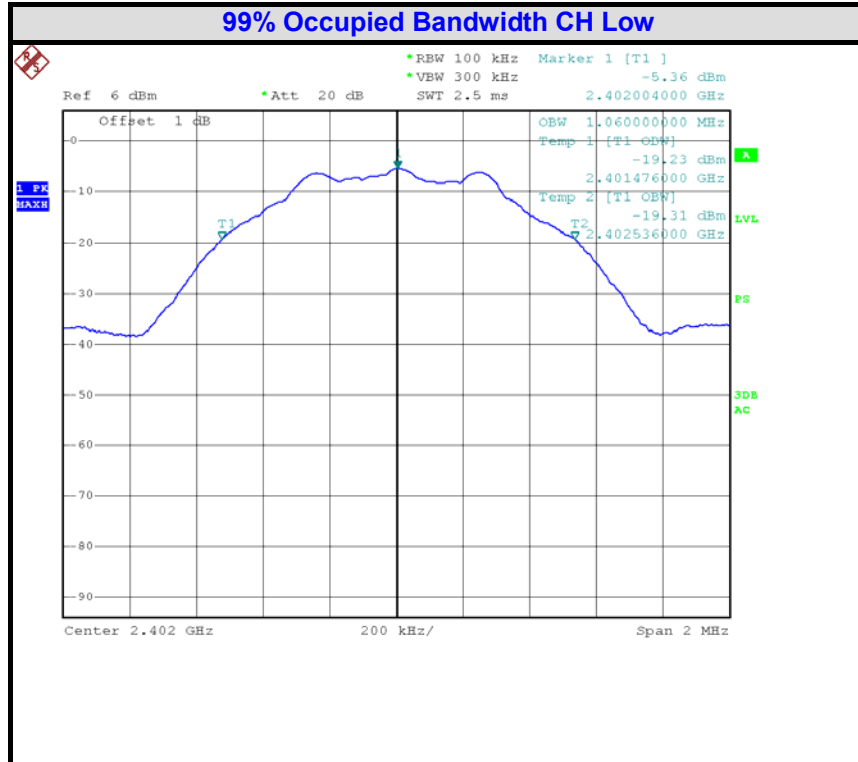

Copyright of this report is owned by Centre of Testing Service and may not be reproduced other than in full except with the written approval of the issuing Company.

CENTRE OF TESTING SERVICE CO., LTD.

A101, No.65, Zhuji Highway, Tianhe District, Guangzhou, China
 Tel: +86-20-85543113 (32 lines) Fax: +86-20-38780406
 Complaint line: +86-20-85533471 E-mail: cts@cts-lab.com.cn

See Reverse For Terms And Conditions of Service

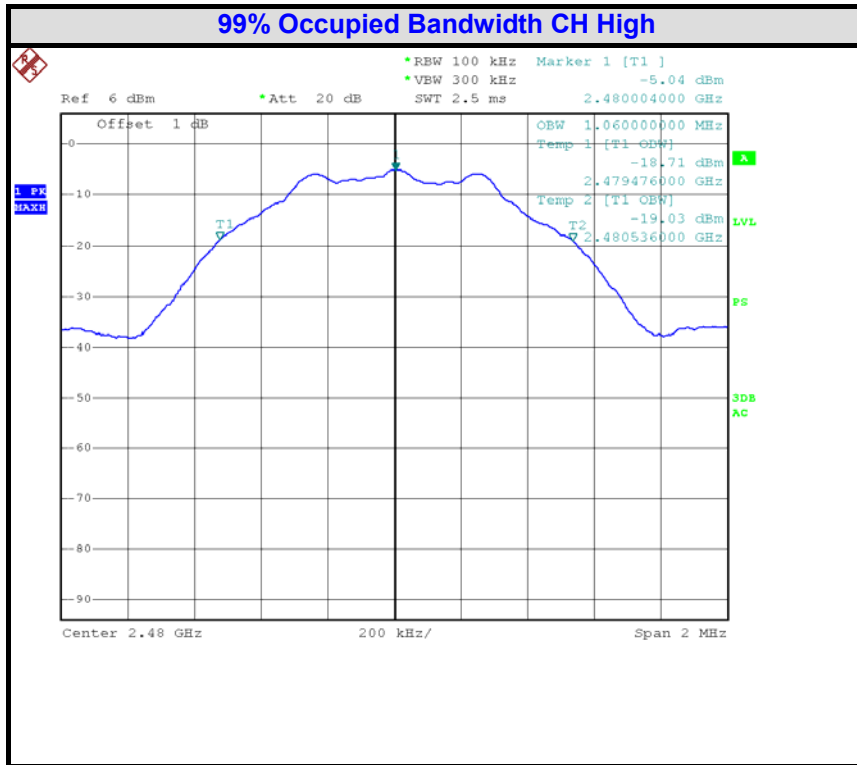

Copyright of this report is owned by Centre of Testing Service and may not be reproduced other than in full except with the written approval of the issuing Company.

CENTRE OF TESTING SERVICE CO., LTD.

A101, No.65, Zhuji Highway, Tianhe District, Guangzhou, China
 Tel: +86-20-85543113 (32 lines) Fax: +86-20-38780406
 Complaint line: +86-20-85533471 E-mail: cts@cts-lab.com.cn

See Reverse For Terms And Conditions of Service



14.0 Antenna Requirements

14.1 Standard Applicable

For intentional device, according to FCC 47 CFR Section 15.203, an intentional radiator shall be designed to ensure that no antenna other than that furnished by the responsible party shall be used with the device.

And according to FCC 47 CFR Section 15.247 (b), if transmitting antennas of directional gain greater than 6dBi are used, the power shall be reduced by the amount in dB that the directional gain of the antenna exceeds 6dBi.

14.2 Antenna Construction and Directional Gain

Antenna type:PCB antenna

Antenna Gain: 0dBi

15.0 Deviation to test specifications

The following identical model(s):

N/A

Belong to the tested device:

Product description: **QCA6234**

Model name: **QCA6234**