

# User's Manual

Model: BTS-73 (US)

Bluetooth Kitchen Clock Speaker

With

PLL FM Radio

Dual Alarm

Cooking Timer

**(Draft for function sample)**



# 1. Cautions

## Don'ts

- Do not place naked flames, such as lighted candles on or near the product.
- Do not place objects filled with liquids, such as vases on or near the product.
- Do not use or store this product in a place where it is subject to direct sunlight, heat, excessive dust or vibration.
- Do not keep or store this product in wet conditions for long period.
- Do not clean this product with water or other liquids.
- Do not block or cover the slots and holes in the product.
- Do not push foreign objects into the slots or holes in the product.
- Do not attempt to open this product yourself. There are no user serviceable parts inside.
- Do not allow children access to plastic bags.

## Safety Instructions

Before using this product, read and follow all warnings and instructions.

- This product is not intended for use by young children. Young children should be properly supervised.
- This product is intended for household use only and not for commercial or industrial use.
- Do not expose to dripping or splashing.
- No naked flame sources, such as lighted candles, should be placed on the product.
- Ventilation should not be impeded by covering ventilation openings with items such as newspapers, table cloths, curtains and the like.
- Make sure the unit is adjusted to a stable position. Damage caused by using this product in an unstable position or by failure to follow any other warning or precaution contained within this user manual will not be covered by warranty.
- Use only the AC-DC Power Adapter / Power Supply listed in this User Manual.

We, suggest retaining the package in case for future transport of the product.

## Warnings



- Never remove the casing of this apparatus.
- Never place this apparatus on the other electrical equipment.

## 2. Outlook and Controls

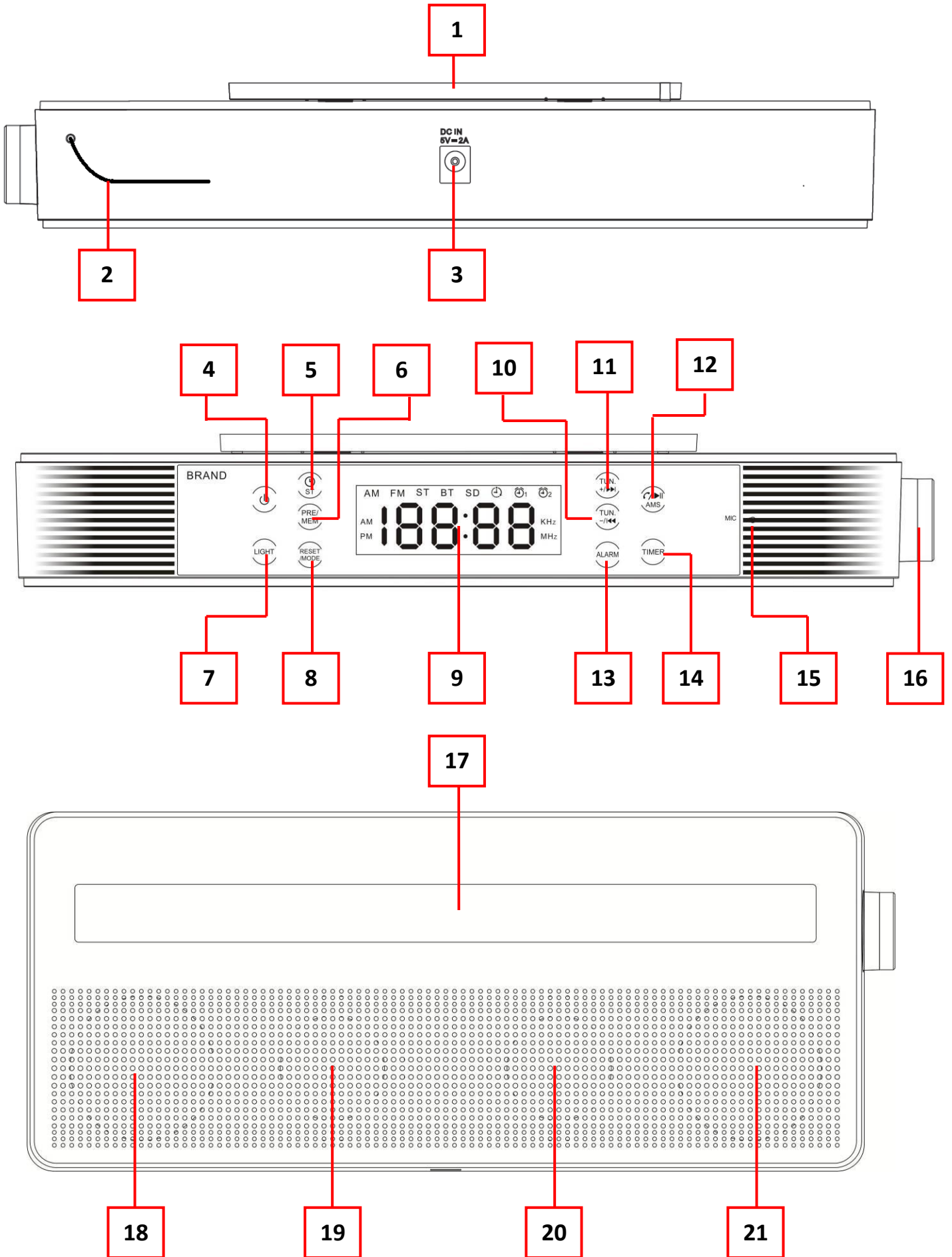

Item	Description
1	<b>Bracket Mounting Slot</b> (for Slide Unit Into Under Kitchen Bracket)
2	<b>FM Wire Antenna</b>
3	<b>DC INPUT Socket</b> (for DC 5V 2A Power Input)
4	<b>⏻ Button</b> (Power ON / OFF)
5	<b>🕒 / ST Button</b> (Clock Set / FM Stereo On/Off)
6	<b>PRE / MEM Button</b> (Preset Station / Memory Station)
7	<b>LIGHT Button</b> (Light On/Off)
8	<b>RESET/MODE Button</b> (FM / Bluetooth, Reset)
9	<b>LED Segments Display</b>
10	<b>TUN- / ⏪ Button</b>
11	<b>TUN+ / ⏩ Button</b>
12	<b>⏮ / ⏭ / AMS Button</b> (Play/Pause, Pick up/Hang up call/Last dialed, Auto Memory Stations)
13	<b>ALARM Button</b> (Set for Alarm 1/2)
14	<b>TIMER Button</b> (Set for Clocking Timer)
15	<b>MIC Position</b> (for hand-free)
16	<b>Adjustment Button</b> (-/+ , Enter/Snooze)
17	<b>LED Light Bar</b> (White LED x 9)
18	<b>Left Loud Speaker</b>
19	<b>Left Bass Radiator</b>
20	<b>Right Bass Radiator</b>
21	<b>Right Loud Speaker</b>

### 3. First Time Connect to AC - DC Power Adapter

#### a. Use only original AC to DC power adapter:

Manufacturer: QI XIN TECHNOLOGY (HONGKONG) CO LTD

Model: YNQX12G05200UL

INPUT: 100-240~50 / 60Hz 0.3A

OUPUT: 5V === 2A

*Note: ~ Symbol is AC Voltage and === Symbol is DC Voltage.*

#### b. Connect DC power from AC to DC power adaptor:

- This device require 5V === 2A at least DC input from AC – DC power adapter.
- Plug the 5.5mm DC plug of provided AC to DC power adapter into “**DC INPUT Socket (3)**” which located on back of Bluetooth Kitchen clock device;

#### c. Device first time initializing: (system defaulted)

- Since the device have design with “**Auto Clock Time Sync**” function from received RDS station(s) which included CT signal when power is connected to the device each time;
- So that, the device will be started automatically initialization when

you every time to plug and unplug the power adaptor's 5V 2A output plug at the device's **"DC Input Socket (3)";** *(Including AC power temporary suspended from power supply station which may happen)*

- When the device is in the initializing stage, then you will see the LED segments to display as animation below show:



- This stage should keep for about 2 ~ 3 minutes to complete;
- Then the clock time will be showed on LED segment display for view. (CT sync and automatically adjusted)



Or



- The clock time may not be adjusted if those background received FM station(s) have no RDS's CT signal provided or RDS signal's strength is too low. (In this case the clock should show **"00:00"**)
- Then manual clock time adjustment is required in this case. (see below adjustment steps)

#### d. **Manual clock set adjustment methods:**

- Short press the **"⌚/ST (5)"** button to entry time format set;
- The LED display will show blinking **"24H"** or **"12H"** for 6 seconds; (factory defaulted is **"24H"**)
- Rotates the **"Adjustment (16)"** button to **"—"** or **"+"** for selects the desired time format;



- Short press the **"Adjustment (16)"** button to confirm the time format set and go for hour set, the number of hour will be blinking;
- Rotates again the **"Adjustment (16)"** button to **"—"** or **"+"** for selects the hour time as current time;
- Short press again the **"Adjustment (16)"** button to confirm the hour time set and go for Minute set. The number of minute will be blinking;
- Rotates again the **"Adjustment (16)"** button to **"—"** or **"+"** for selects the minute time as current time and short press the **"Adjustment (16)"** button to confirm the minute time set and go for CT on/off set, the **"Ct On"** or **"Ct OF"** will be blinking;

- Rotates again the “**Adjustment (16)**” button to “—” or “+” for selects the “**Ct On**” or “**Ct OF**” as you desired;
- Short press again the “**Adjustment (16)**” button to confirm.
- The clock set adjustment is completed and clock time is showing on LED display.

### Information for CT on/off function:

- By design, the Bluetooth Kitchen Clock Speaker will be sync once the clock time at 2:00 (AM) by every mid night. This function is for keeping the clock time is up-to-date.
- The CT function for clock’s time sync can be turn off and on as you desired, however clock’s time cannot be sync and update when it is in disabled mode.

## 4. Set Alarm 1 / Alarm 2 and Wake-Up function

### a. Alarm time set:

- Short press the “**ALARM (13)**” button to entry the set alarm function, first the Alarm 1 symbol (🕒<sub>1</sub>) will blinking;
- Then short press the “**ALARM (13)**” button again can switch to 🕒<sub>2</sub> when you want; (Short press this button can switch in between 🕒<sub>1</sub> and 🕒<sub>2</sub> repeatedly)

### Set Alarm 1 for example:

- Short press the “**ALARM (13)**” button to choose 🕒<sub>1</sub>;
- Then short press the “**Adjustment (16)**” button to confirm and go for set alarm’s hour, and the number of alarm hour will blinking;
- Rotates the “**Adjustment (16)**” button to “—” or “+” for selects the desired hour of Alarm 1. Short press the “**Adjustment (16)**” button to confirm and go for set minute of Alarm 1. The number of minute will blinking;
- Then again, rotates the “**Adjustment (16)**” button to “—” or “+” for selects the desired minute of Alarm 1 and short press the “**Adjustment (16)**” button to confirm and go for choose wake-up source. The “**bU**” letter will blinking on LED segments display;
- Rotates the “**Adjustment (16)**” button to position “—” or “+” for choose “**bU**” or “**tU**” which as want. The wake-up source could switch from “**bU**” to “**tU**” repeatedly if continually rotates it button to “—/+”;

### Wake-up source

 = Buzz (Beeps)

 = Tuner (Current selected FM Radio station)

- Short press the “**Adjustment (16)**” button to confirm once “**bU**” or “**tU**” is selected.
- The Alarm 1 settings are completed and  icon is showing on LED display.
- Use the same methods for set the Alarm 2 function if you want.

**b. Wake-Up Function:**

**Wake to Buzz**

- At the selected Alarm time, the wake-up beeps will turn on for 5 minutes. To stop the Alarm, short press the “**Alarm (13)**” button.

**Wake to Radio**

- At the selected Alarm time, the FM radio will automatically turn on itself. To stop the FM radio, short press the “**⏻ (4)**” button to turn off the device.

**c. Dual Alarm time set:**



- Repeat the above mentioned set Alarm 1 methods to set Alarm 2 for dual alarm function if you want.

**d. Use Snooze:**

- At the time of wake-up beeps in sound, you can short press the “**Adjustment (16)**” button for approximately 9 minutes extra for sleep if you want. The “**Zz**” icon will appear as identify.
- And this snooze function can repeat 3 times if you use it.

*Remark: When turn on the device by  button will disable the snooze function if snooze is in using.*

**e. To disable the Alarm 1 and or Alarm 2 function:**

- Short press the “**ALARM (13)**” button to call alarm function, the Alarm 1 symbol () will blinking;
- Short press “**ALARM (13)**” button again to choose which alarm to disable;
- In  or  blinking status, long press the “**ALARM (13)**” button to disable the chosen Alarm.
- Disable alarm function will work only when the Alarm 1 and/or Alarm 2 have been set and in used.

**f. To enable the disabled Alarm 1 and or Alarm 2:**

**For Alarm 1:**

- Short press the “**ALARM (13)**” button to call alarm function, the  symbol will blinking and the previous time set will display at the same time;
- Then long press the “**ALARM (13)**” button to enable the Alarm 1 function which has disabled.

**For Alarm 2:**



- Short press the “**ALARM (13)**” button to call alarm function, the symbol  will blinking;
- Then short press the “**ALARM (13)**” button again to switch to



Alarm 2, the  symbol will be blinking and the previous time set will display at the same time;

- Then long press the “**ALARM (13)**” button to enable the Alarm 2 function which has been disabled.

## 5. Set Cooking Timer

- Short press the “**Timer (14)**” button to enter the countdown timer mode, the LED display switches from current mode to timer display mode, the timer symbol  will be blinking and show “05” minutes on LED display; (*5 minutes is system default running time when timer is chosen*)
- Then rotate the “**Adjustment (16)**” button to “—” or “+” for setting your desired time for cooking timer; (01 ~ 300 minutes can be set)
- Short press the “**Timer (14)**” or “**Adjustment (16)**” button to confirm and the display will switch back to previous current mode screen. The Timer symbol () is appearing for indication, the Cooking Timer is activated.
- The last 30 seconds of setting time will be countdown on display with beep every second until time's up.
- The remaining time of the timer will be circulating display by “time -> radio frequency -> timer time” repeatedly on LED screen.

### To disable the Timer function:

- Then long press the “**Timer (14)**” button to disable function and the  symbol will disappear on LED screen.

## 6. Kitchen Light ON/OFF

- Short press the “**Light (7)**” button to turn on the kitchen light bar when necessary.
- Short press the “**Light (7)**” button again to turn off the kitchen light bar.

### Information for Kitchen light function:

- For food demonstration.
- It is not suitable for household room illumination.

## 7. Power ON/OFF

### a. Power ON and OFF:

- Short press the “**Power (4)**” button to power on the device and use FM radio from clock display mode; (The FM radio mode will start first as system default)
- In power on mode, short press the “**Power (4)**” button to power off.

### b. Use FM Stereo Radio:

- Make sure that the FM wire antenna is well adjusted and fixed at good position; it will increase for radio reception.



### Adjust Volume Level

- Rotates the “**Adjustment (16)**” button to “—” for decreases volume.
- Rotates the “**Adjustment (16)**” button to “+” for increases volume.

### FM Mute

- In you want to mute the radio sound for a while, short press the “**⏸/▶ (12)**” button, the sound will mute and the FM radio frequency is blinking as identify.
- Short press the “**⏸/▶ (12)**” button to resume.

### FM Station

- The first time use the FM radio function; the frequency 87.5MHz will show on LED segments display and wait for tuning radio stations;
- However, last used radio channel frequency being recall for FM radio, when you switch mode in-between the FM mode and Bluetooth mode, or power off and on the device.

#### **c. Manual Tune Radio Frequency:**

- In FM radio mode;
- Press the “**TUN- / ◀◀ (10)**” or “**TUN+ / ▶▶ (11)**” button for steps frequency down or up to receive next station, each press will step down or up the frequency by 0.1MHz.
- Press the “**TUN- / ◀◀ (10)**” or “**TUN+ / ▶▶ (11)**” button quickly until to your desired radio frequency of radio station. Or;
- Long press the “**TUN- / ◀◀ (10)**” or “**TUN+ / ▶▶ (11)**” button for 2 seconds to entry into manual searching mode. This mode allows keeping tuning down / up and being stop until next radio station frequency is received.

#### **d. Manual Store for Tuned Radio Frequency into Preset Memory:**

- After the above mentioned manual tune radio frequency, the tuned current station’s frequency can be stored by;
- Long press the “**PRE/MEM (6)**” button, the preset “**P01**” will appear and blinking on display;
- Then short press the “**TUN- / ◀◀ (10)**” or “**TUN+ / ▶▶ (11)**” button to choose your desired preset number (**P--**) where to store the tuned radio’s frequency;
- Choose “**P30**” for example, and then short press again the “**PRE/MEM (6)**” button to confirm the storage and the screen will switch back to current radio’s frequency from preset mode.

#### **e. Auto Memory Stations (AMS):**

- In FM receive mode;
- Long press the “**AMS (12)**” button to entry auto memory stations function;
- The FM radio will turn into AMS mode and searching up from

current receiving radio frequency (example; 90.3MHz) to until a circle of FM frequency range, from 90.4MHz ~ 108.0MHz then 87.5 ~ 90.2MHz, those seeks and received FM station's frequencies will be memory and programed into preset list;

- As the design, the current receiving radio frequency (90.3MHz) will become preset "P01" and still as current receiving radio station for continue uses.

**Note:**

- All previous preset radio frequencies will be erased when every time you using the **AMS** function.
- The AMS function will be stop automatically if preset number "P01 ~ P40" are renew and fully programed.

**f. Recall and Change Preset Number:**

- In current receiving radio frequency;
- Short press the "PRE/MEM (6)" button, the current radio frequency preset number will be recalled for 3 seconds;
- Then short press the "TUN- / ◀◀ (10)" or "TUN+ / ▶▶ (11)" button to choose your desired preset number (P01 – P40) for radio listening;
- The LED display will switch back from preset screen to chosen radio frequency screen.
- Choose the desired preset number at any time you want by the above mentioned steps.

**g. Turn FM Stereo Function OFF and ON:**

- In some cases; the receiving FM radio station may have FM stereo switching noise due to poor reception or strong interferences;
- Turn off the FM stereo function to improve this issue when it happen;
- When the receiving FM station is in provided FM stereo broadcasting, then the "ST" indicator should appear at the top line of LED segments display. (see below picture)
- To turn off the FM stereo function, short press the "⌚/ST (5)" button and the "ST" icon will disappear.
- Short press it again to turn on the FM stereo function, the FM stereo function will turn on and the "ST" symbol will appear in 2 seconds.



## 8. Use Bluetooth Mode

### a. Switch in-between Bluetooth and FM mode:

- Power on the device, or in FM radio mode;
- Short press the “**MODE (8)**” button to change from FM to Bluetooth mode, the screen will switch to Bluetooth mode and the “**BT**” icon appears.
- Short press the “**MODE (8)**” button can switch in-between from Bluetooth and FM mode at any time as your desired.

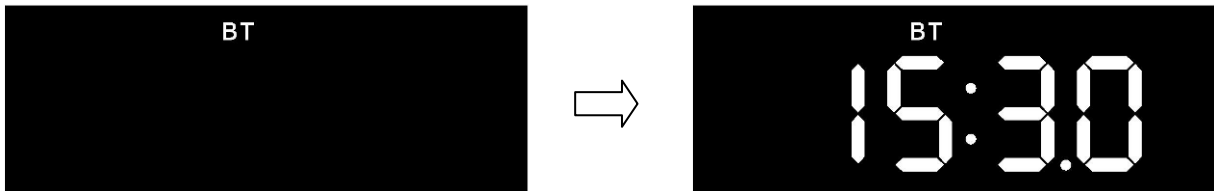

### b. Bluetooth device Pairing:

- When switched to Bluetooth mode, the device will go for reconnect/pairing mode automatically;
- Then, activate the Bluetooth function in your Bluetooth device (such as Mobile Phone or Personal Computer); the device will enter to Bluetooth searching mode automatically, if not, tap the related selection to manually enter to searching mode. (refer to your device’s manual when necessary)
- Your mobile device should show “**KR-140**” in Bluetooth list, and then select it for pairing. Waiting for some seconds and will see connected message as shown on your mobile device. (For some Bluetooth devices. You may need to input “**0000**” as pairing password)
- If pairing is successful, a beep will sound, the “**BT**” icon light change to solid from blinking.
- Now, you can start to music play from the mobile device by its music player program.

### c. Disconnect from paired device

- To disconnect with paired device and for better result;
- Long press the “**⏪/▶ (12)**” button to disconnect directly and a series of tones will sound as identify;
- Or, you can choose “Disconnect” from Bluetooth paired device list on your mobile device;
- In this case; the Bluetooth Kitchen Clock Speaker will turn back into “**Searching / Pairing**” mode in seconds, a series of tones will sound and the “**BT**” icon will turn to blinking again from solid.
- Now, you can process for new mobile device pair or power Off the

Bluetooth Speaker if you wanted.

**d. Disconnect from paired device**

- Every time you turn On the device and switch to Bluetooth mode;
- it will firstly searching for the mobile device which has been paired previously and still in record;
- The device will reconnect this mobile device as priority if it in Bluetooth searching device mode and in connection range.
- If no device found in some seconds, the device will automatically turn into pairing mode.
- Now you can process for new mobile device pair.

**e. Switch to new pairing from connected mode**

- In Bluetooth connected mode, you can switch the Device into Bluetooth searching mode for paring with the new device at any time you desired;
- Long press the “/▶ (12)” button to disconnect directly, a series of tones will sound as identify and the “BT” icon turn to blinking from solid.
- Now you can process for new mobile device pair.

**f. Bluetooth Music Playing Controls**

**On your Mobile Device**

- Switch to music player menu and choose a music to start the play from playlist or by using “◀ / ▶” button/icon. Play/Pause the playing music by using “▶ / ▶” button or icon.
- Adjust the volume level by using the device’s volume control “Down / Up” button/icon on your Bluetooth device. (Refer to your mobile device user’s manual when necessary)

**On Bluetooth Speaker**

- In playing music;
- Press the “/▶ (12)” button to pause the playing music. To resume the music press it again.
- Rotates the “Adjustment (16)” button to “—” for decreases volume.
- Rotates the “Adjustment (16)” button to “+” for increases volume.
- The volume controls range can be used from “U00” minimum to “U30” maximum.
- Press the “TUN—/◀ (10)” button to play previous music.
- Press the “TUN+/▶ (11)” button to play next music.

**g. Hand Free Function**

- When there is an incoming call during Bluetooth music playing mode;
- The ringing sound will up and the playing music will pause automatically;

- Long press the “**📞/▶ (12)**” button to reject the call if you want. Or,
- Short press the “**📞/▶ (12)**” button to pick up the call;
- Now you are in hand free function with the Bluetooth Kitchen Clock Speaker.
- Short press the “**📞/▶ (12)**” button again to hang up the call when finished. And the paused music will resume automatically.

**Tip:** speak to the “**MIC (15)**” hole direct with distance in 30 ~ 60cm to get the best speakerphone performance when necessary.

#### **h. Redial Last Call Function**

- To redial for last called number by the Bluetooth Kitchen Clock Speaker, even it is in Bluetooth music playing mode.
- Short press the “**📞/▶ (12)**” button twice to enter into redial function, the playing music will pause and switch to hand free function for redial.
- Short press the “**📞/▶ (12)**” button again can hang up the calling.
- Make sure that your mobile phone has have last dial call used, if not, the redial for last call function cannot be activated.

## **9. Reset the Device**

In some circumstances the device’s function may hanging and need to reset. To reset the device;

- Long press the “**RESET/MODE (8)**” button for 8 seconds to reset the device;
- The LED segments display will show “**F001 (example)**” as identify and the device is in reset process, all previous setup will be erased and back to factory default;
- Then the device will go into system initializing stage. And the LED segments to display as animation below show:

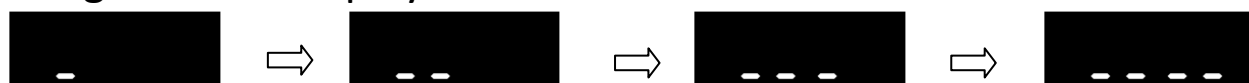

- The device is in reset process, waiting for about 2 ~ 3 minutes to complete;
- Then, the device will be turned back to clock time display mode, the device is reset. All previous setup will be erased and back to factory default. Including all previous preset FM stations are clean-up too, use AMS function to regenerates the preset station list.

## 10. Install the Under Kitchen Mounting Bracket

Please use the provided mounting screws (4 pcs in bag) and install the Bracket and Main Unit as the following pictures illustration:

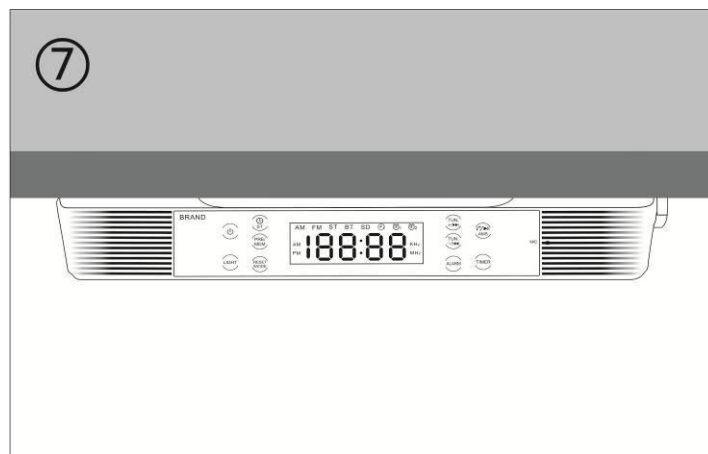
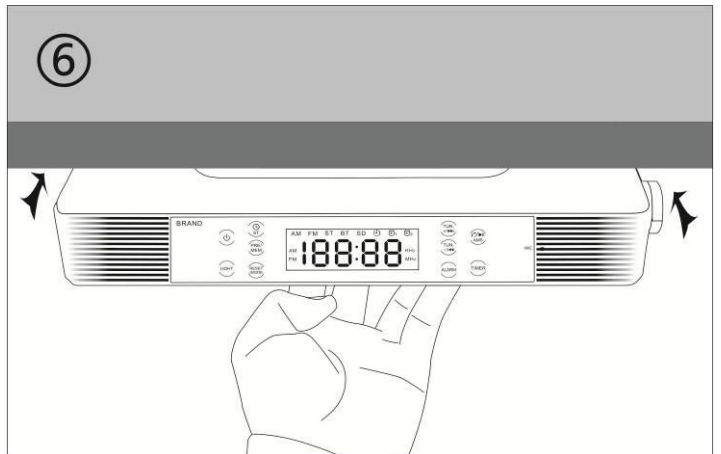
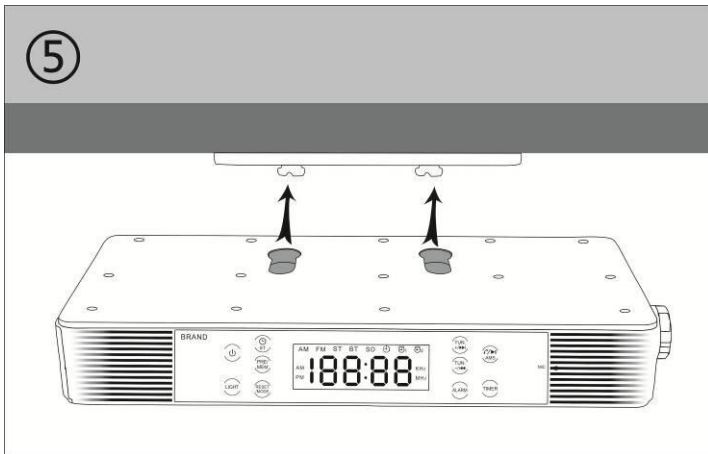
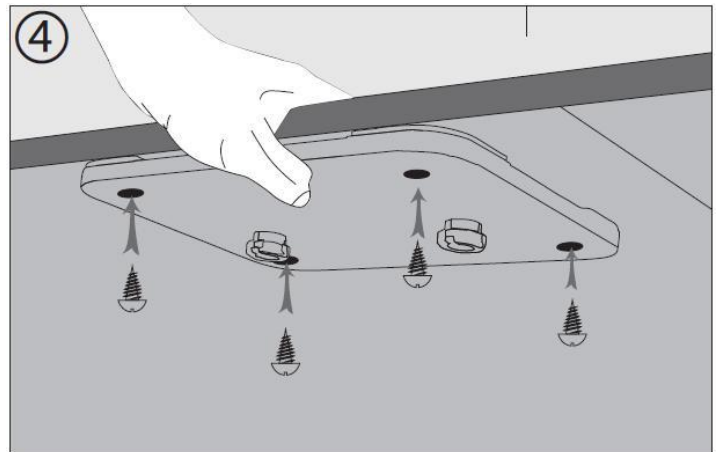
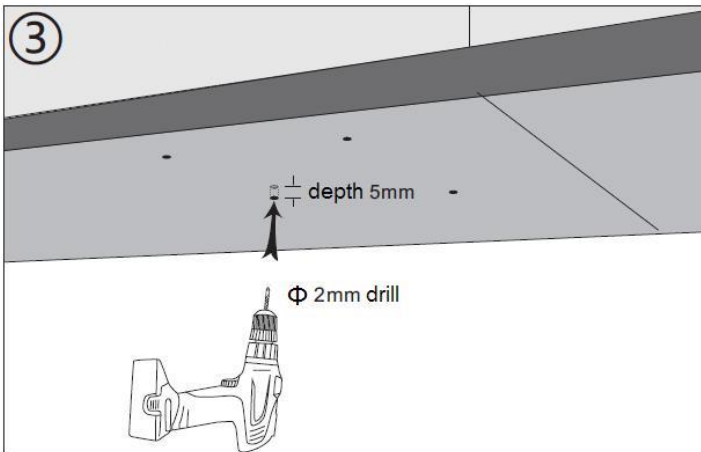
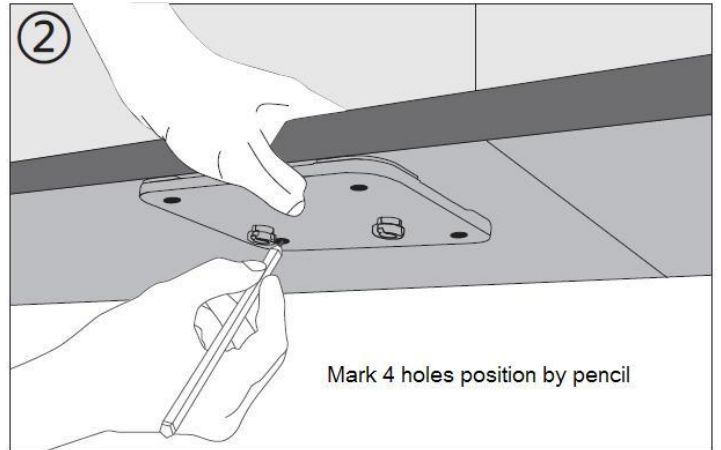
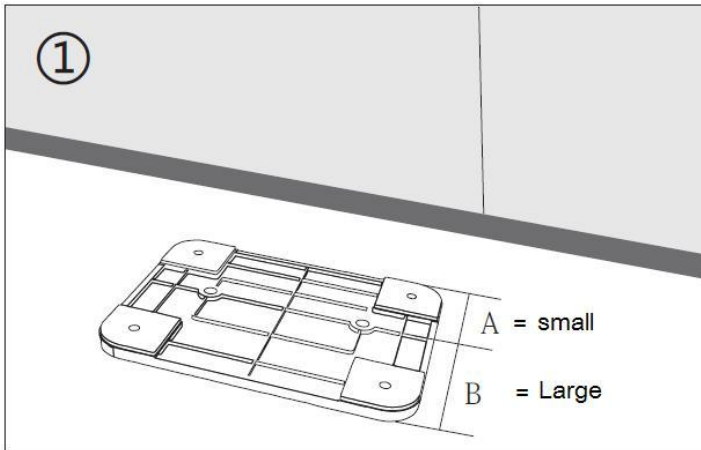



## 11. Trouble Shooting

No power	<ul style="list-style-type: none"> <li>• Check whether DC plug of AC to DC adaptor is it firmly plugged into DC jack of main unit.</li> <li>• Check whether the AC to DC power adaptor is it firmly plugged into AC outlet.</li> </ul>
No sound	<ul style="list-style-type: none"> <li>• Check whether volume level is in lower position on your main unit or and mobile device.</li> <li>• Check if you have selected the correct mode source.</li> <li>• Make sure that your Bluetooth device is within the effective operation range.</li> <li>• Check whether the Bluetooth device is paired on your mobile device.</li> <li>• Check whether the Bluetooth device show connected on your mobile device.</li> </ul>
No radio station	<ul style="list-style-type: none"> <li>• Check whether the FM station's is tuned in correct frequency and programed.</li> </ul>
No response from speaker	<ul style="list-style-type: none"> <li>• Restart the speaker by power Off and On.</li> </ul>

## 12. Technical Specification

Unit Dimension	270mm(L) x 112mm(D) x 48mm(H) Main Unit (with Bracket)	
Unit Weight	576g (approx.)	
Clock	Alarm 1, Alarm 2	
	Wake-up by: Beeps or FM radio	
Cooking Timer	0 ~ 300 minutes (Counter-down)	
	Alarm by: Beeps	
Bluetooth	Specification	V2.1 + EDR
	Supported Profile	A2DP, AVRCP, HSP
	Connection Distance	In 10 meters (open area)
	Power	Class II
FM Radio	Tuning Range	87.5MHz – 108MHz
	Stereo / Mono	Selectable
	RDS	CT function only
	Preset Memory	40 stations (max.)
	Antenna	Wire type
Power Source Input	6mm DC Socket for 5.5mm DC plug	
	DC Input 5V $\pm$ 2A	
Audio	Output Power	3W (RMS) x 2 (4 Ohm)
	Freq. Responses	80Hz to 18,000Hz
Operating Temperature	0 to 40°C	



## **13. Disclaimer**

Updates to Firmware and/or hardware components are made regularly. Therefore some of the instruction, specifications and pictures in this documentation may differ slightly from your particular situation. All items described in this guide for illustration purposes only and may not apply to particular situation. No legal right or entitlements may be obtained from the description made in this manual.

### **FCC Statement**

This equipment has been tested and found to comply with the limits for a Class B digital device, pursuant to Part 15 of the FCC Rules. These limits are designed to provide reasonable protection against harmful interference in a residential installation. This equipment generates uses and can radiate radio frequency energy and, if not installed and used in accordance with the instructions, may cause harmful interference to radio communications. However, there is no guarantee that interference will not occur in a particular installation. If this equipment does cause harmful interference to radio or television reception, which can be determined by turning the equipment off and on, the user is encouraged to try to correct the interference by one or more of the following measures:

- Reorient or relocate the receiving antenna.
- Increase the separation between the equipment and receiver.
- Connect the equipment into an outlet on a circuit different from that to which the receiver is connected.
- Consult the dealer or an experienced radio/TV technician for help.

Changes or modifications not expressly approved by the party responsible for compliance could void the user's authority to operate the equipment.