



America

Certification Test Report

FCC ID: 2AA7KSATURN-26000

IC: 20068-SATURN26000

FCC Rule Part: Part 90 Subpart M
ISED Canada Radio Standards Specification: RSS-137

TÜV SÜD Report Number: RD72138283.102

Manufacturer: Star Systems International Limited
Model: HRD26000

Test Begin Date: May 08, 2018

Test End Date: May 10, 2018

Report Issue Date: June 07, 2018



FOR THE SCOPE OF ACCREDITATION UNDER LAB Code AT-1921

This report must not be used by the client to claim product certification, approval, or endorsement by ANAB, ANSI, or any agency of the Federal Government.

Prepared by:

Jean Tezil
EMC Engineer
TÜV SÜD America, Inc.

Reviewed by:

Randle Sherian
EMC Manager
TÜV SÜD America, Inc.

This test report shall not be reproduced except in full. This report may be reproduced in part with prior written consent of TÜV SÜD America Inc. The results contained in this report are representative of the sample(s) submitted for evaluation.

TABLE OF CONTENTS

1	GENERAL	3
1.1	PURPOSE.....	3
1.2	PRODUCT DESCRIPTION	3
1.3	TEST METHODOLOGY AND CONSIDERATIONS	4
2	TEST FACILITIES.....	5
2.1	LOCATION	5
2.2	LABORATORY ACCREDITATIONS/RECOGNITIONS/CERTIFICATIONS	5
2.3	RADIATED EMISSIONS TEST SITE DESCRIPTION	6
2.3.1	<i>Semi-Anechoic Chamber Test Site</i>	6
2.4	CONDUCTED EMISSIONS TEST SITE DESCRIPTION	7
3	APPLICABLE STANDARD REFERENCES.....	8
4	LIST OF TEST EQUIPMENT.....	9
5	SUPPORT EQUIPMENT.....	10
6	EQUIPMENT UNDER TEST SETUP BLOCK DIAGRAM	10
7	SUMMARY OF TESTS.....	11
7.1	RF POWER OUTPUT – FCC 90.205, RSS 137.....	11
7.1.1	<i>Measurement Procedure</i>	11
7.1.2	<i>Measurement Results - FCC Part 90.205; ISED Canada RSS-137</i>	11
7.2	OCCUPIED BANDWIDTH (EMISSION LIMITS) – FCC 90.209, RSS 137	12
7.2.1	<i>Measurement Procedure (ANSI 63.26: 2015 Section 5.4.4)</i>	12
7.2.2	<i>Measurement Results - ISED Canada RSS-GEN 6.6, ISED Canada RSS-137</i>	12
7.3	SPURIOUS EMISSIONS AT ANTENNA TERMINALS	15
7.3.1	<i>Measurement Procedure</i>	15
7.3.2	<i>Measurement Results - FCC Part 90.210(k); ISED Canada RSS-137</i>	15
7.4	FIELD STRENGTH OF SPURIOUS EMISSIONS	24
7.4.1	<i>Measurement Procedure</i>	24
7.4.2	<i>Measurement Results - FCC Part 90.210(d); ISED Canada RSS-137</i>	24
8	MEASUREMENT UNCERTAINTY.....	29
9	CONCLUSION.....	29

1 GENERAL

1.1 Purpose

The purpose of this report is to demonstrate compliance with Part 90 Subpart M of the FCC's Code of Federal Regulations and ISED Canada's Radio Standards Specification RSS-137 Certification.

1.2 Product description

Saturn is a radio frequency identification (RFID) reader. Specifically, Saturn provides wireless air interface access to read and write passive and battery assisted passive (BAP) RFID tags conforming to the standards ISO-18000 6C, ISO-18000 6B, and TDM (also known as IAG or PS111). Applications of the Saturn Reader include tolling, parking and access control, and logistics.

The Saturn Reader is powered by 802.3at (PoE+) or by an auxiliary DC power supply ranging from 12 volts to 57 volts. Saturn's primary use interface is through Ethernet, but there is also the option for RS-232. Saturn provides 2 optically isolated inputs and 2 open collector outputs.

Saturn has 2 antenna ports. One antenna port is connected to an integrated antenna through an SMA connector, while the second port may be used to connect an optional external antenna. Only one antenna is connected to the transmitter and receiver at any given time.

Technical Information:

Mode of Operation	Frequency Range (MHz)	Number of Channels	Channel Separation (kHz)	Data Rates Supported (kbps)
C1G2_MODE_640_MILLER2	911.75 - 919.25	16	500	111.1
ISOB_160_FM0_95P	911.75 - 919.75	17	500	40
ISO10374_MANCH_FSK	902.75 - 903.25 910.75 - 920.75	23	500	N/A
PS111_MANCHESTER	913.75 - 916.25	6	500	500

Antenna Type / Gain:

Integrated Antenna: MTI 263005/S/E / 13 dBi

optional external antenna: MTI MT-263005/N / 13 dBi

Operating Voltage:

Power Supply: 12-57 VDC, tested on 24VDC

POE: 37-57 VDC

Manufacturer Information:

Star Systems International Limited

Unit 04, 12/F Vanta Industrial Centre, 21-33 Tai Lin Pai Road

Kwai Chung, New Territories, Hong Kong.

EUT Serial Numbers: Radiated Emissions: 086007, RF conducted Emissions: 086009

Test Sample Condition: The test samples were provided in good working order with no visible defects.

1.3 Test Methodology and Considerations

The EUT dedicated to RF conducted measurements had 2 antenna ports. The internal antenna was disconnected, and the coax connection was routed outside the chassis for testing purposes. The second port was the optional external antenna port. Both ports were checked for RF output power measurement, and the port producing the highest amplitude, namely RF2 port, was used for the entire evaluation. The power levels on both antenna ports were within the 1dB tolerance of the rated power.

Based on the requirements set forth in accordance 47 CFR 2.1046-2.1057 as stated above, the methodology in selecting the places to test in the available bands of operation is outlined in the following table.

Protocol	Low Band (902.75 MHz-903.25 MHz)			High Band (910.75 MHz-920.75 MHz)		
	Low	Mid	High	Low	Mid	High
C1G2_MODE_640_MILLER2	n/a	n/a	n/a	911.75	n/a	919.25
ISOB_160_FM0_95P	n/a	n/a	n/a	911.75	n/a	919.75
ISO10374_MANCH_FSK	902.75	n/a	n/a	910.75	n/a	920.75
PS111_MANCHESTER	n/a	n/a	n/a	913.75	n/a	916.25

The radiated emissions evaluation was performed with the EUT in the orientation of typical installation. Both power sources, notably power supply and POE, were tested. Where applicable, the final data collected under the power source producing the worst-case emissions is presented in this document.

A software interface was provided by the manufacturer to control the EUT over an ethernet IP access, allowing to select the protocol, the frequency, the desired port of transmission, and the power level. All testing was conducted using the highest power rating of 33dBm, entered in the software in the format "3300".

2 TEST FACILITIES

2.1 Location

The radiated and conducted emissions test sites are located at the following address:

TÜV SÜD America Inc.
2320 Presidential Drive, Suite 101
Durham, NC 27703
Phone: (919) 381-4235

2.2 Laboratory Accreditations/Recognitions/Certifications

TÜV SÜD America Inc. is accredited to ISO/IEC 17025 by ANSI-ASQ National Accreditation Board under their ANAB program and has been issued certificate number AT-1921 in recognition of this accreditation. Unless otherwise specified, all test methods described within this report are covered under the ISO/IEC 17025 scope of accreditation.

The Semi-Anechoic Chamber Test Site and Conducted Emissions Site have been fully described, submitted to, and accepted by the FCC and Innovation, Science and Economic Development (ISED) Canada.

FCC Registered Test Site Number: 637011
ISED Canada Test Site Registration Number: 20446

2.3 Radiated Emissions Test Site Description

2.3.1 Semi-Anechoic Chamber Test Site

The Semi-Anechoic Chamber Test Site consists of a 18' x 28' x 18' shielded enclosure. The chamber is lined with Samwha Electronics Co. LTD Ferrite Absorber, model number SFA300 (HSN-1). The ferrite tile is 10cm x 10 cm and weighs approximately 1.4lbs. These tiles are mounted on steel panels and installed directly on the inner walls of the chamber. On top of the ferrite tiles is DMAS HT-45 (Dutch Microwave Absorber Solutions) hybrid absorber on all walls except the wall behind the antenna mast which has a shorter DMAS HT-25 absorber.

The turntable is 1.50m in diameter and is located 150cm from the back wall of the chamber. The chamber is grounded via 1 - 8' copper ground rod, installed at the center of the back wall, it is bound to the ground plane using short #6 copper wire. The turntable is all steel, flush mounted table installed in an all steel frame. The table is remotely operated from inside the control room located 25' from the turntable. The turntable is electrically bonded to the surrounding ground plane via steel fingers installed on the edge of the turn table. The steel fingers make constant contact with the ground plane.

Behind the turntable is a 2' x 6' x 1.5' deep shielded pit used for support equipment if necessary. The pit is equipped with 2 - 4" PVC chase from the turntable to the pit that allow for cabling to the EUT if necessary. The underside of the turntable can be accessed from the pit so cables can be supplied to the EUT from the pit.

A diagram of the Semi-Anechoic Chamber Test Site is shown in Figure 2.3-1 below:

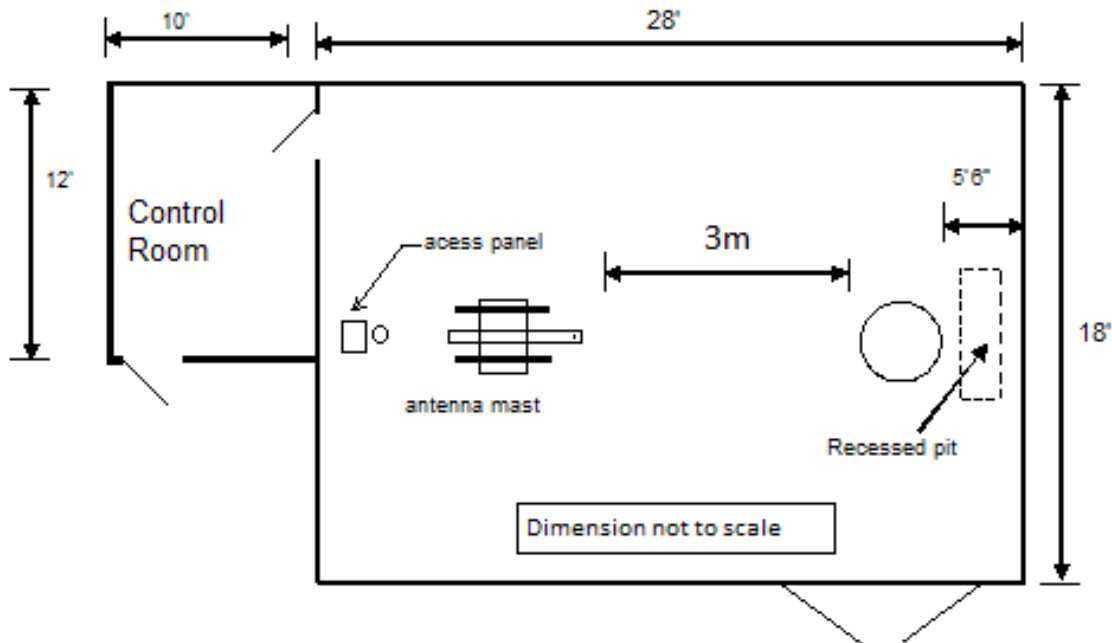

Figure 2.3-1: Semi-Anechoic Chamber Test Site

2.4 Conducted Emissions Test Site Description

The AC mains conducted EMI site is located in the main EMC lab. It consists of an 8' x 10' sheet galvanized steel horizontal ground reference plane (GRP) bonded every 6" to an 8' X 8' aluminum vertical ground plane.

A diagram of the room is shown below in figure 2.4-1:

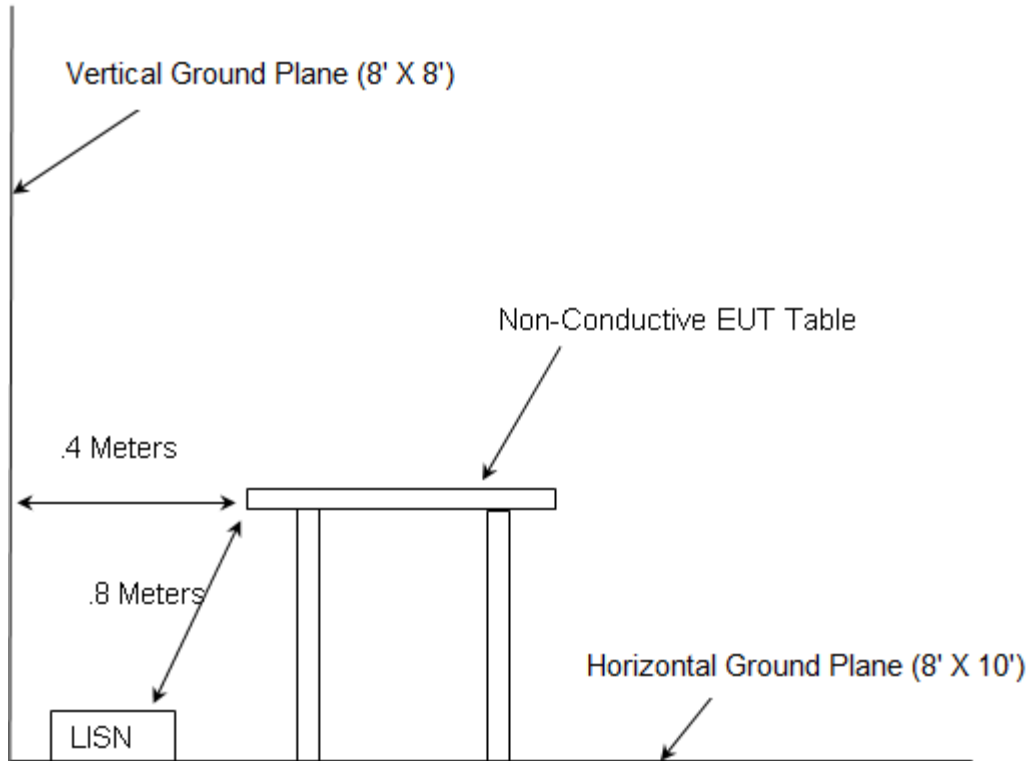

Figure 2.4-1: AC Mains Conducted EMI Site

3 APPLICABLE STANDARD REFERENCES

The following standards were used:

- ❖ ANSI C63.4-2014: American National Standard for Methods of Measurement of Radio-Noise Emissions from low-voltage electrical and electronic equipment in the range of 9kHz to 40 GHz.
- ❖ ANSI C63.26-2015: American National Standard of Procedures for Compliance Testing of Transmitters Used in Licensed Radio Services
- ❖ US Code of Federal Regulations (CFR): Title 47, Part 2, Subpart J: Equipment Authorization Procedures, 2017
- ❖ US Code of Federal Regulations (CFR): Title 47, Part 90, Subpart M: Intelligent Transportation Systems Radio Service, 2017
- ❖ ISED Canada Radio Standards Specification: RSS-137 - Location and Monitoring Service in the Band 902-928 MHz, Issue 2 February 2009
- ❖ ISED Canada Radio Standards Specification: RSS-GEN – General Requirements for Compliance of Radio Apparatus, Issue 4, Nov 2014

4 LIST OF TEST EQUIPMENT

The calibration interval of test equipment is annually or the manufacturer's recommendations. Where the calibration interval deviates from the annual cycle based on the instrument manufacturer's recommendations, it shall be stated below.

Table 4-1: Test Equipment

Asset ID	Manufacturer	Model #	Equipment Type	Serial #	Last Calibration Date	Calibration Due Date
DEMC0277	EMCO	93146	Antennas	9904-5199	9/12/2016	9/12/2018
DEMC0499	EMCO	3146	Antennas	1108	5/3/2017	5/3/2019
DEMC0626	EMCO	3110B	Antennas	9411-1945	3/21/2017	3/21/2019
DEMC3002	Rohde & Schwarz	ESU40	Receiver	100346	7/24/2017	7/24/2018
DEMC3006	Rohde & Schwarz	TS-PR18	Amplifiers	122006	1/10/2018	1/10/2019
DEMC3008	Rohde & Schwarz	NRP2	Meter	103131	2/15/2018	2/15/2019
DEMC3009	Rohde & Schwarz	NRP-Z81	Meter	102397	2/15/2018	2/15/2019
DEMC3011	Rohde & Schwarz	ENV216	LISN	3011	1/10/2018	1/10/2019
DEMC3012	Rohde & Schwarz	EMC32-EB	Software	100731	NCR	NCR
DEMC3014	EMCO	3115	Antennas	9901-5653	3/3/2017	3/3/2019
DEMC3016	Fei Teng Wireless Technology	HA-07M18G-NF	Antennas	2013120203	2/7/2018	2/7/2020
DEMC3020	Rohde & Schwarz	SMB100A	Signal Generators	175943	1/11/2019	1/11/2019
DEMC3029	Micro-Tronics	HPM50108	Filter	134	1/7/2018	1/7/2019
DEMC3031	Hasco, Inc.	HLL335-S1-S1-96	Cables	3074	8/29/2017	8/29/2018
DEMC3038	Florida RF Labs	NMSE-290AW-60.0-NMSE	Cable Set	1448	1/5/2018	1/5/2019
DEMC3039	Florida RF Labs	NMSE-290AW-396.0-NMSE	Cable Set	1447	1/5/2018	1/5/2019
DEMC3045	Aeroflex Inmet	18N10W-20	Attenuator	1437	1/8/2018	1/8/2019
DEMC3051	Mountain View Cable	BMS-RG400-264.0-BMS	Cables	3051	1/8/2018	1/8/2019
DEMC3055	Rohde & Schwarz	3005	Cables	3055	1/8/2018	1/8/2019
DEMC3060	Weinschel Corp.	47-20-33	Attenuator	BJ0583	8/29/2017	8/29/2018
DEMC3065	Huber & Suhner	Succoflex104	Cables	120233/4	8/28/2017	8/28/2018
DEMC3085	Rohde & Schwarz	FSW43	Spectrum Analyzer	103997	3/15/2018	3/15/2019

NCR = No Calibration Required

Asset DEMC3002: Firmware Version: ESU40 is 4.73 SP4

Asset DEMC3012: Software Version: EMC32-B is 9.15

Asset DEMC3020: Firmware Rev: 2.20.382.113

Asset DEMC3085: Instrument Firmware 2.90 SP1

5 SUPPORT EQUIPMENT

Table 5-1: Support Equipment

Item #	Type Device	Manufacturer	Model/Part #	Serial #
1	EUT	Star Systems International Limited	Saturn HRD26000	RE: 086007 RF CE: 086009 AC CE: 086005
2	Power Supply	Phihong	PSAC30U-24026	155202493A2
3	Laptop	Lenovo	ThinkPad W530	N/A
4	Ethernet Switch	Netgear	FS105 v2	1D52113E0167 A

Table 5-2: Cable Description

Cable #	Cable Type	Length	Shield	Termination
A	Power cable	3.54 m	No	1 to 2
B	Power Cord	1.8 m	No	2 to AC
C	Ethernet	1 m	No	3 to 4
D	Ethernet	8 m	No	1 to 4
E	GPIO	1.8 m	No	Resistive load

6 EQUIPMENT UNDER TEST SETUP BLOCK DIAGRAM

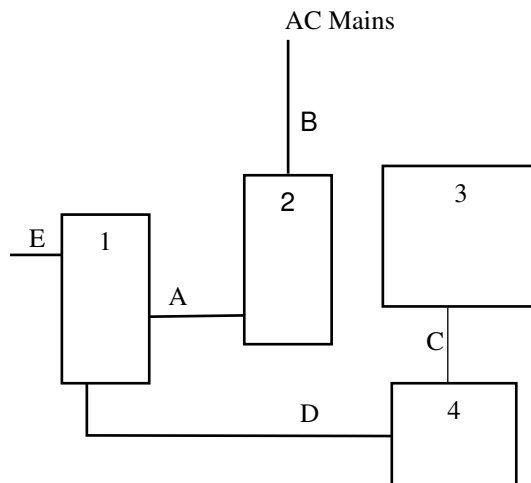

Figure 6-1: Test Setup Block Diagram

7 SUMMARY OF TESTS

Along with the tabular data shown below, plots were taken of all signals deemed important enough to document.

Note: The EUT is a fixed non-multilateration transmitter whose lowest and highest channels are 40kHz or more away from the sub-band edges. Therefore, frequency stability was not evaluated due to no frequency tolerance restrictions per FCC 90.213 Note 13.

7.1 RF Power Output – FCC 90.205, RSS 137

7.1.1 Measurement Procedure

The RF output of the equipment under test was directly connected to the input of a wide band RF power meter through 40 dB of passive attenuation. The results are shown below.

7.1.2 Measurement Results - FCC Part 90.205; ISED Canada RSS-137

Performed by Jean Tezil

Table 7.1.2-1: Peak Output Power

Protocol	Frequency (MHz)	Output Power (dBm)	ERP (dBm)	ERP (W)	ERP Limits (W)
C1G2_MODE_640_MILLER2	911.75	32.38	43.23	21.04	30
	919.25	32.17	43.02	20.04	30
ISOB_160_FM0_95P	919.75	32.56	43.41	21.93	30
ISO10374_MANCH_FSK	902.75	32.31	43.16	20.70	30
	910.75	32.13	42.98	19.86	30
	920.75	32.21	43.06	20.23	30
PS111_MANCHESTER	913.75	32.56	43.41	21.93	30
	916.25	32.32	43.17	20.75	30

7.2 Occupied Bandwidth (Emission Limits) – FCC 90.209, RSS 137

7.2.1 Measurement Procedure (ANSI 63.26: 2015 Section 5.4.4)

The RF output of the equipment under test was directly connected to the input of the Spectrum Analyzer through 40 dB of passive attenuation. The internal correction factors of the spectrum analyzer were employed to correct for any cable and attenuator losses.

The spectrum analyzer center frequency is set to the nominal EUT channel center frequency. The frequency span for the spectrum analyzer shall be set wide enough to capture all modulation products including the emission skirts. The nominal IF filter 3 dB bandwidth (RBW) is in the range of 1% to 5% of the OBW, and the VBW was set $\geq 3 \times$ RBW. The reference level was set to prevent the signal amplitude from exceeding the maximum spectrum analyzer input mixer level for linear operation. The measurements were made using the spectrum analyzer’s 99% BW function.

7.2.2 Measurement Results - ISED Canada RSS-GEN 6.6, ISED Canada RSS-137

Performed by Jean Tezil

Table 7.2.2-1: Occupied Bandwidth

Frequency (MHz)	ISED Canada Rule Part	Mode of Operation	99% Bandwidth (kHz)
911.75	RSS-137	C1G2_MODE_640_MILLER2	349.15
919.25	RSS-137	C1G2_MODE_640_MILLER2	347.83
911.75	RSS-137	ISOB_160_FM0_95P	240.59
919.75	RSS-137	ISOB_160_FM0_95P	239.63
902.75	RSS-137	ISO10374_MANCH_FSK	0.215
910.75	RSS-137	ISO10374_MANCH_FSK	0.212
920.75	RSS-137	ISO10374_MANCH_FSK	0.212
913.75	RSS-137	PS111_MANCHESTER	303.70
916.25	RSS-137	PS111_MANCHESTER	303.81

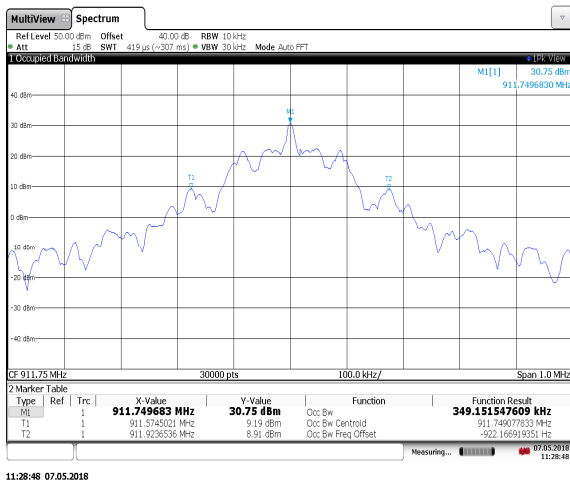

11:28:48 07.05.2018

Figure 7.2.2-1: 911.75 MHz – C1G2

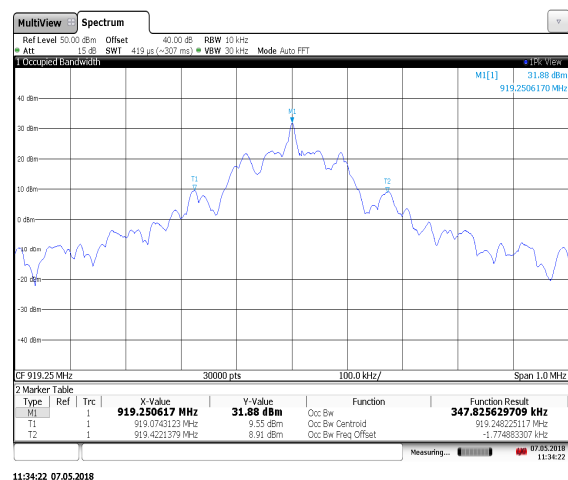

11:34:22 07.05.2018

Figure 7.2.2-2: 919.25 MHz – C1G2

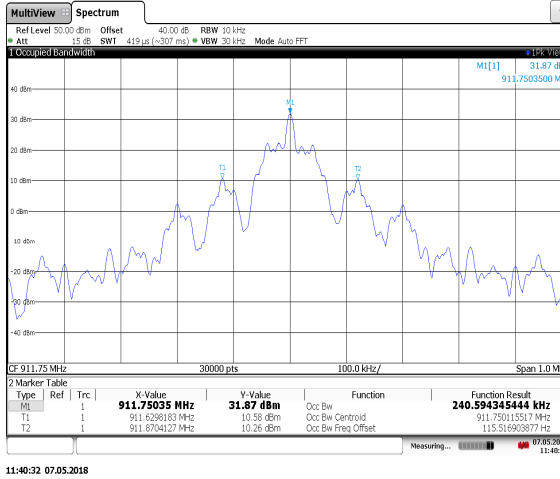

Figure 7.2.2-3: 911.75 MHz – IS0B

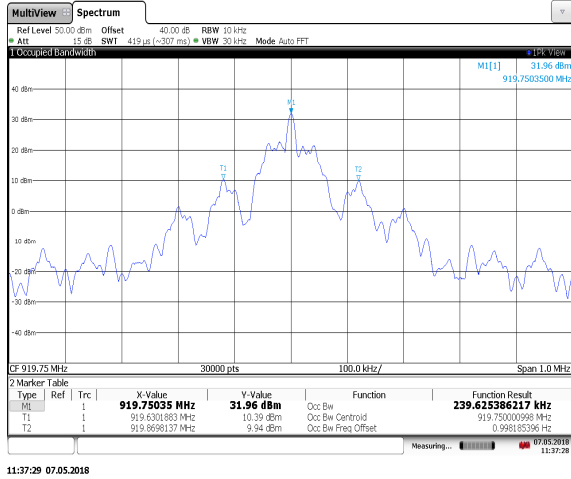

Figure 7.2.2-4: 919.25 MHz – IS0B

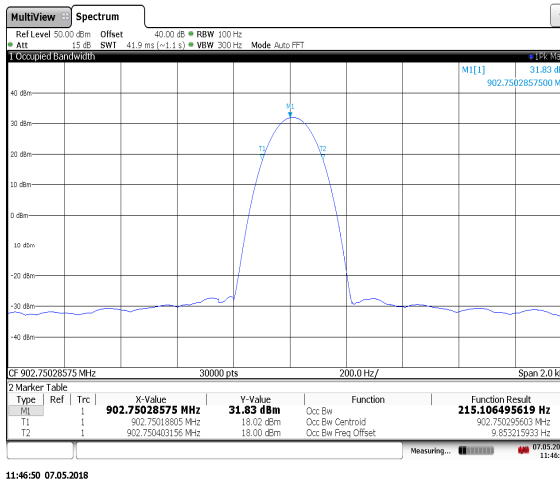

Figure 7.2.2-5: 902.75 MHz – IS0-10374

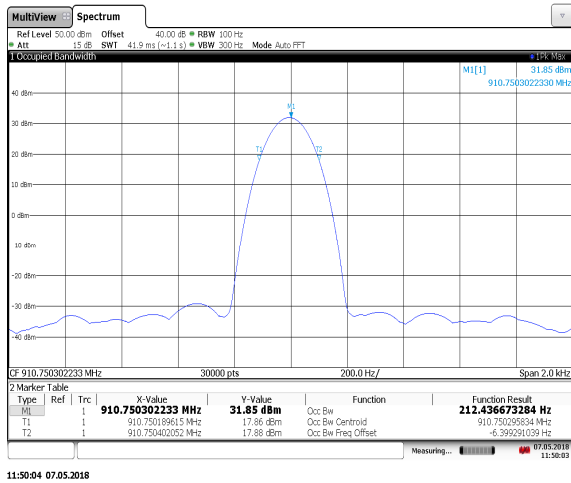

Figure 7.2.2-6: 910.75 MHz – IS0-10374

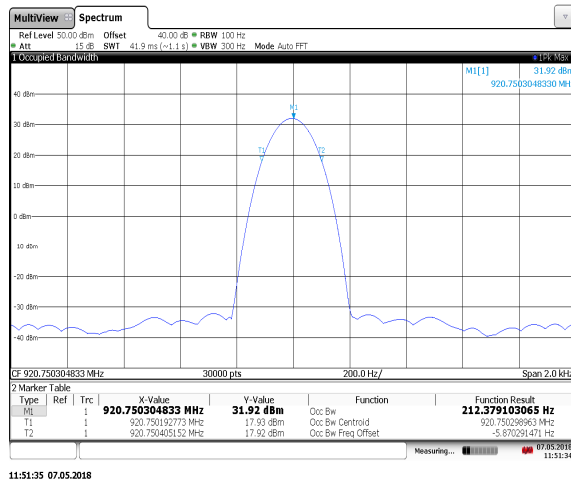

Figure 7.2.2-7: 920.75 MHz – IS0-10374

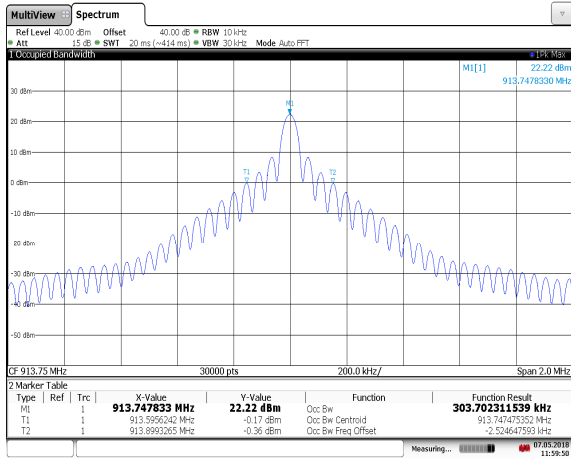

Figure 7.2.2-8: 902.75 MHz – PS111

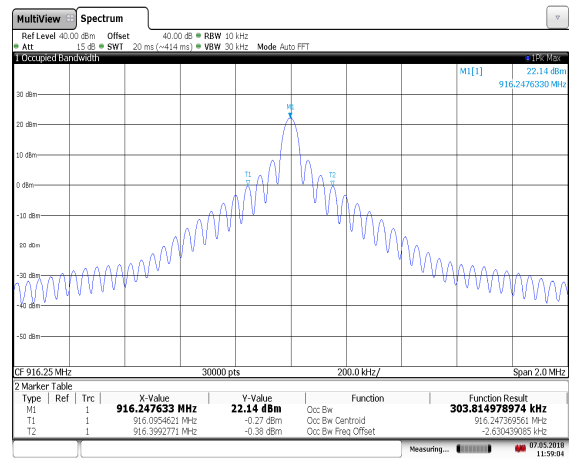

Figure 7.2.2-9: 910.75 MHz – PS111

7.3 Spurious Emissions at Antenna Terminals

7.3.1 Measurement Procedure

The RF output of the equipment under test was directly connected to the input of the Spectrum Analyzer through 40 dB of passive attenuation. The spectrum analyzer resolution bandwidth was set to 100 kHz below 1000 MHz and 1 MHz above 1000 MHz. The internal correction factors of the spectrum analyzer were employed to correct for any cable, attenuator or filter losses. The spectrum was investigated in accordance to CFR 47 Part 2.1057. Results are shown below.

7.3.2 Measurement Results - FCC Part 90.210(k); ISED Canada RSS-137

Performed by Jean Tezil

Protocol C1G2_MODE_640_MILLER2

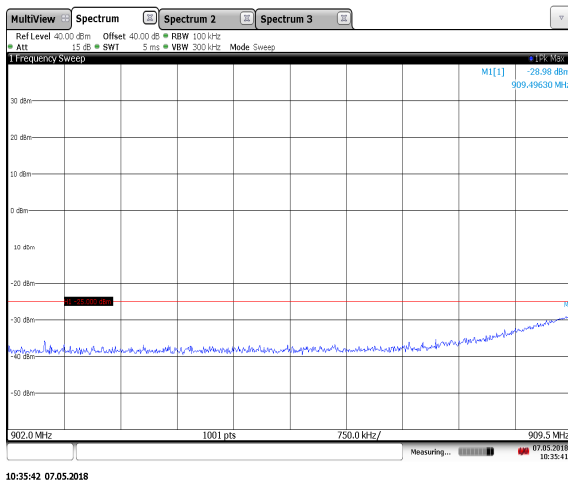

10:35:42 07.05.2018

Figure 7.3.2-1: 911.75 MHz – C1G2 - Low Edge

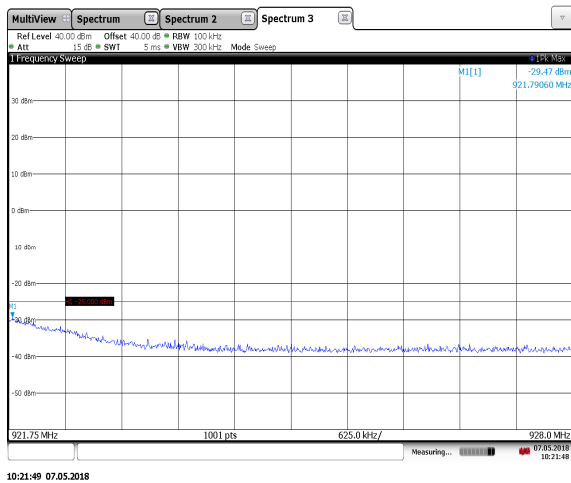

10:21:49 07.05.2018

Figure 7.3.2-2: 919.25 MHz – C1G2 – High Edge

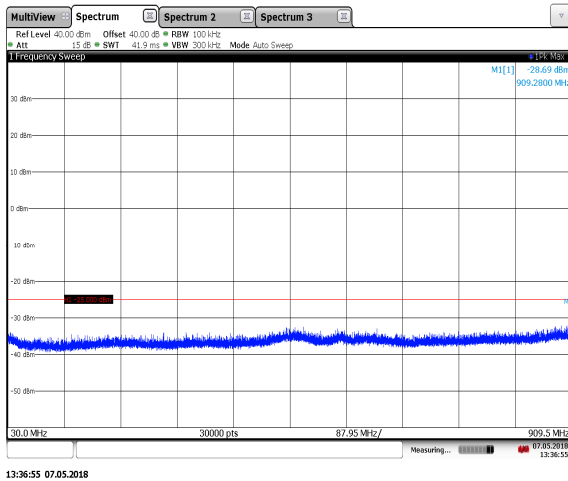

13:36:55 07.05.2018

Figure 7.3.2-3: 911.75 MHz – C1G2 - 30MHz to Edge

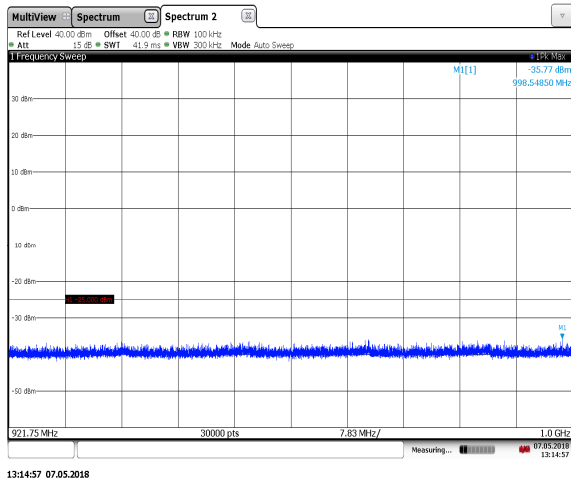

13:14:37 07.05.2018

Figure 7.3.2-4: 911.75 MHz – C1G2 – Edge to 1GHz

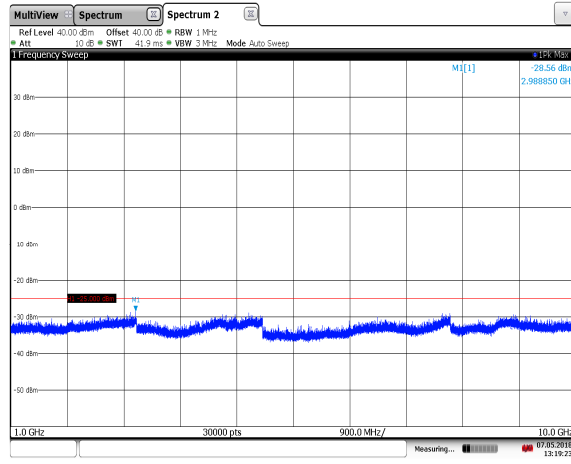

Figure 7.3.2-5: 911.75 MHz – C1G2 - 1 GHz – 10GHz

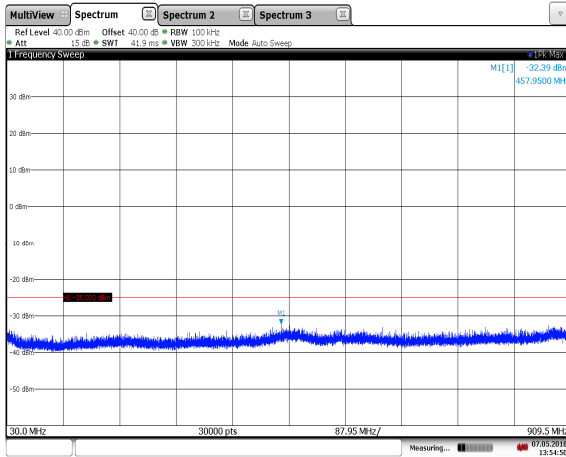

Figure 7.3.2-6: 919.25 MHz – C1G2 - 30MHz to Edge

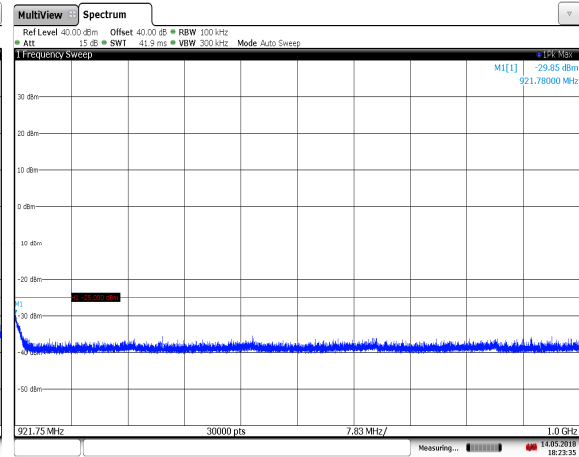

Figure 7.3.2-7: 919.25 MHz – C1G2 – Edge to 1GHz

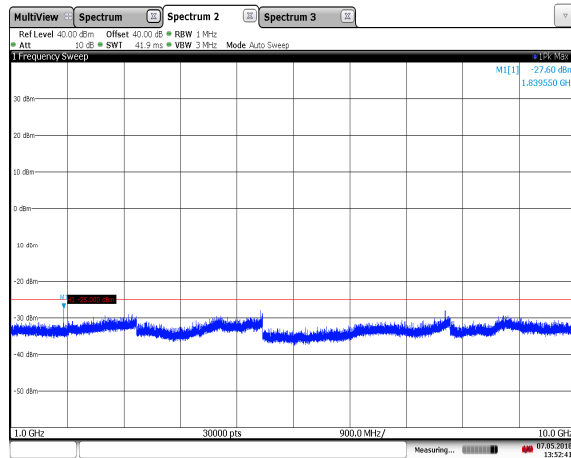
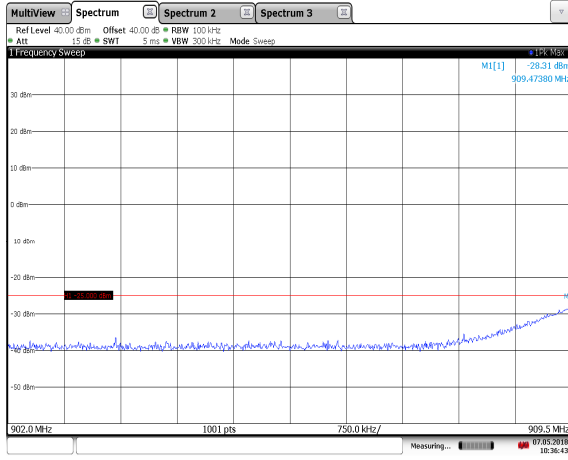

Figure 7.3.2-8: 919.25 MHz – C1G2 - 1 GHz – 10GHz

Protocol: ISOB_160_FM0_95P



10:36:44 07.05.2018

Figure 7.3.2-9: 911.75 MHz – ISOB - Low Edge

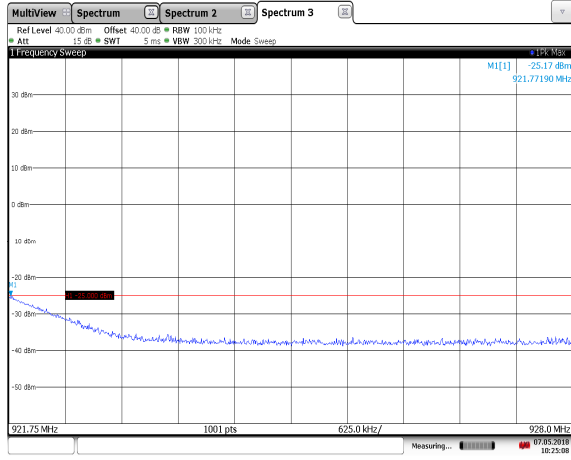

10:25:09 07.05.2018

Figure 7.3.2-10: 919.75 MHz – ISOB – High Edge

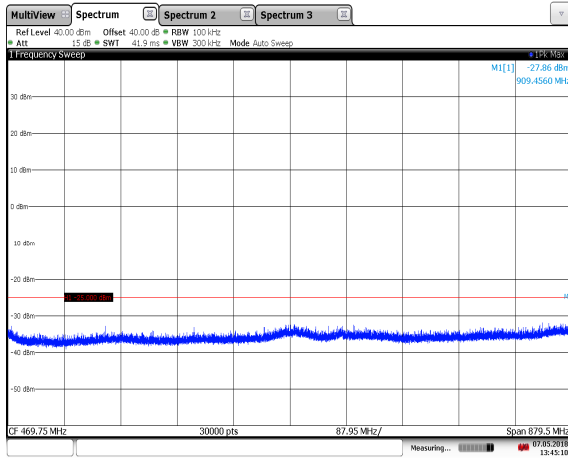

13:45:10 07.05.2018

Figure 7.3.2-11: 911.75 MHz – ISOB - 30MHz to Edge

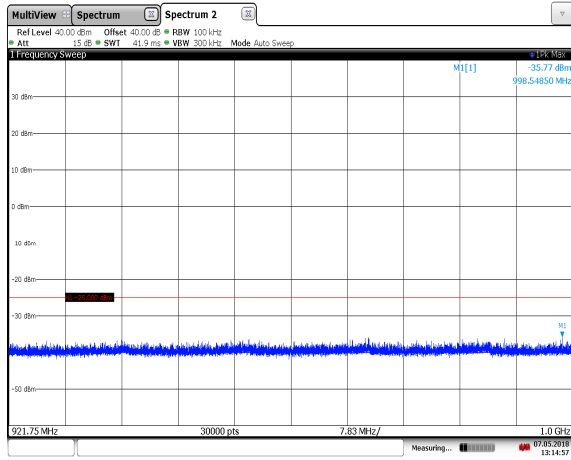

13:14:57 07.05.2018

Figure 7.3.2-12: 911.75 MHz – ISOB – Edge to 1GHz

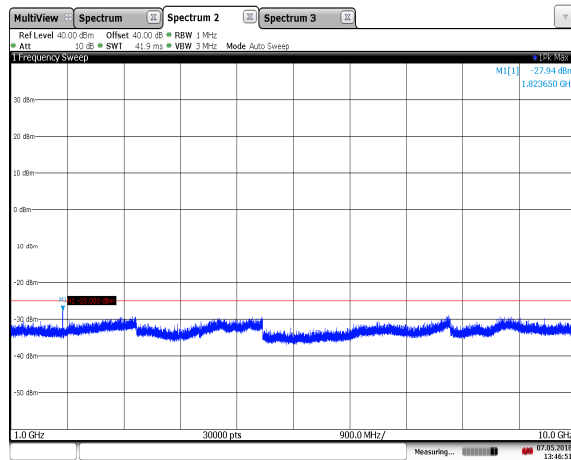

13:46:52 07.05.2018

Figure 7.3.2-13: 911.75 MHz – ISOB - 1 GHz – 10GHz

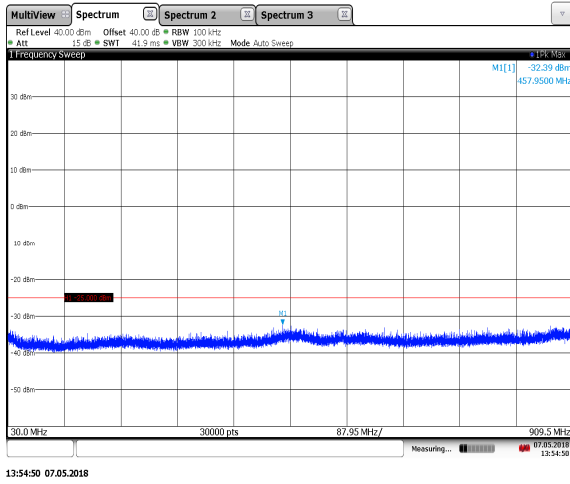

Figure 7.3.2-14: 919.75 MHz – ISOB - 30MHz to Edge

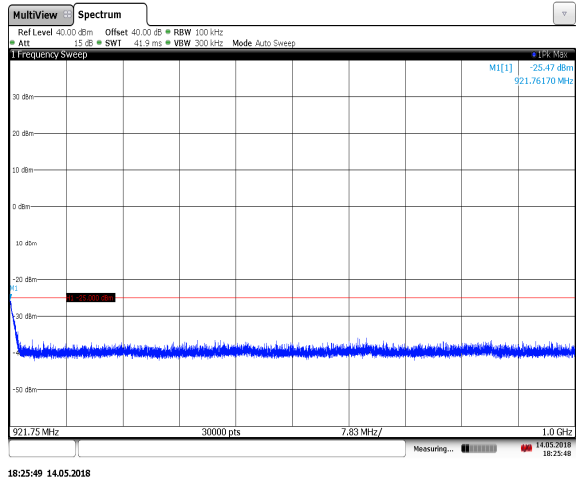

Figure 7.3.2-15: 919.75 MHz – ISOB – Edge to 1GHz

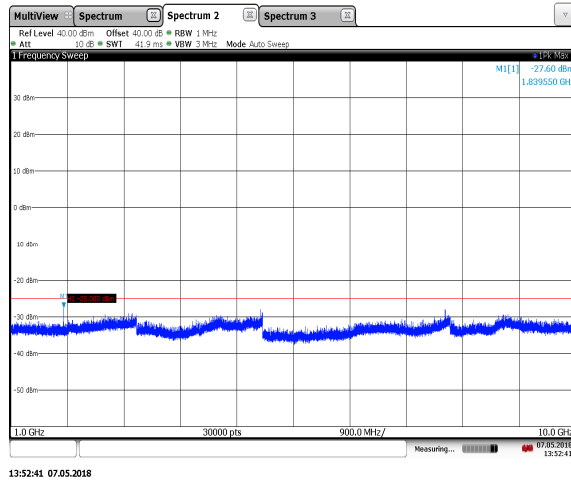
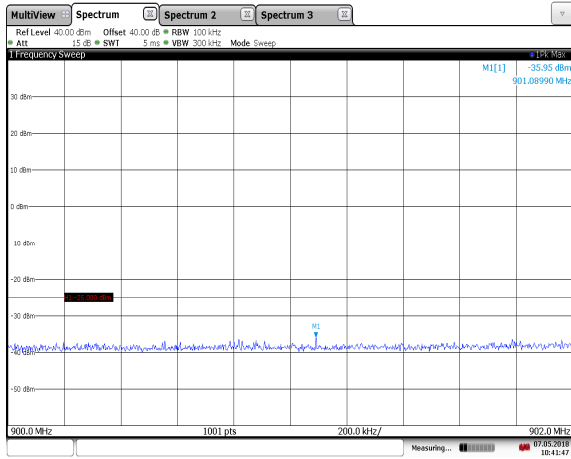
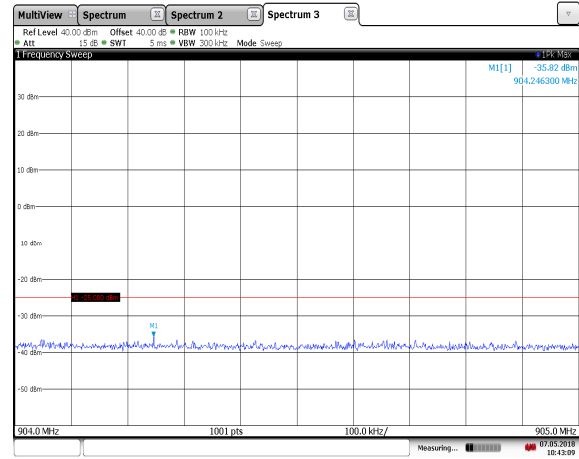

Figure 7.3.2-16: 919.75 MHz – ISOB - 1 GHz – 10GHz

Protocol: ISO10374_MANCH_FSK



10:41:47 07.05.2018
Figure 7.3.2-17: 902.75 MHz – ISO10374 - Low Edge



10:43:09 07.05.2018
Figure 7.3.2-18: 903.25 MHz – ISO10374 – High Edge

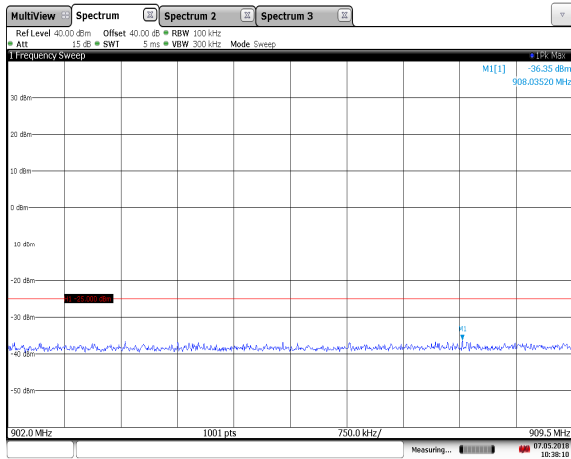

10:38:10 07.05.2018
Figure 7.3.2-19: 910.75 MHz – ISO10374 - Low Edge

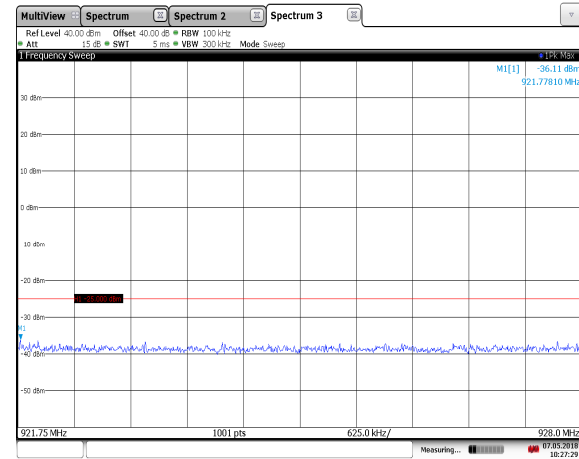

10:27:30 07.05.2018
Figure 7.3.2-20: 920.75 MHz – ISO10374 – High Edge

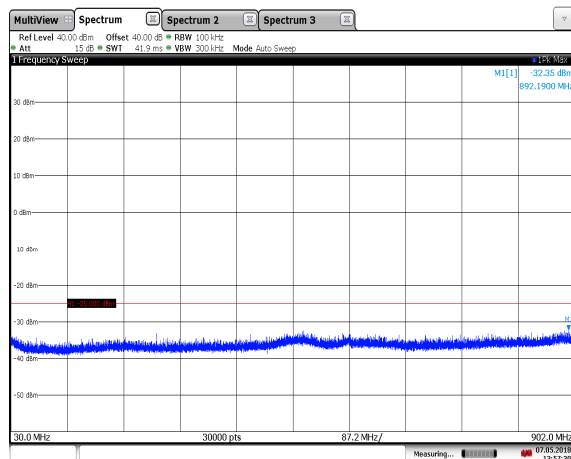

13:57:30 07.05.2018
Figure 7.3.2-21: 902.75 MHz – ISO-10374 - 30MHz to Edge

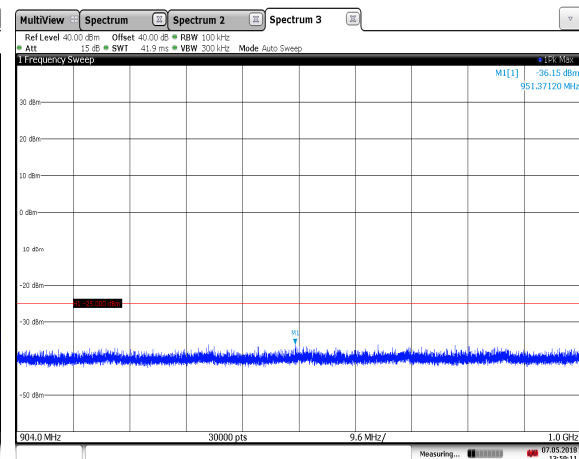

13:59:11 07.05.2018
Figure 7.3.2-22: 902.75 MHz – ISO-10374 – Edge to 1GHz

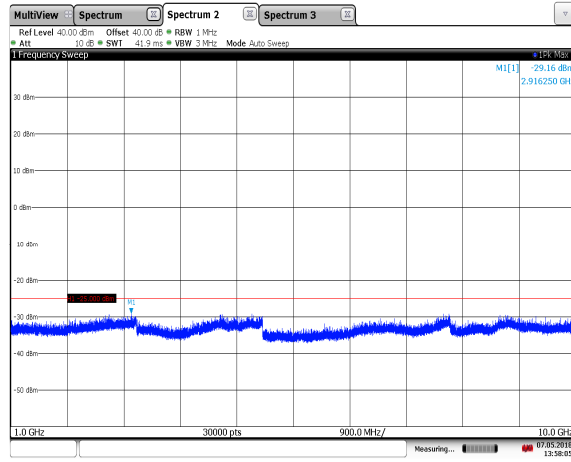
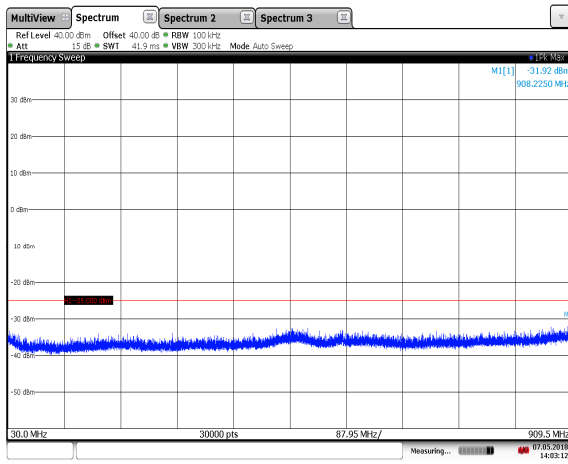
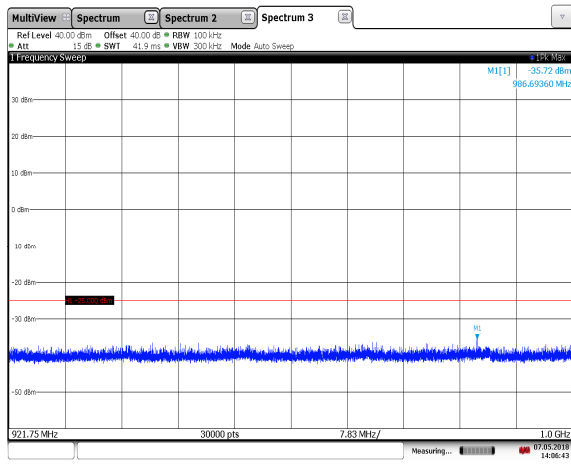

Figure 7.3.2-23: 902.75 MHz – ISO-10374 - 1 GHz – 10GHz



14:03:12 07.05.2018



14:06:44 07.05.2018

Figure 7.3.2-24: 910.75 MHz – ISO-10374 - 30MHz to Edge Figure 7.3.2-25: 910.75 MHz – ISO-10374 – Edge to 1GHz

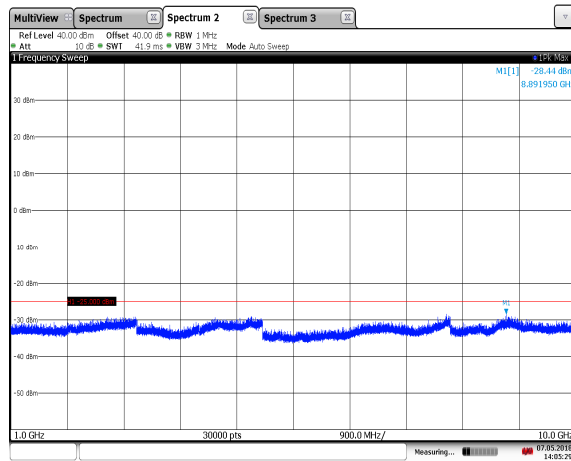

14:05:29 07.05.2018

Figure 7.3.2-26: 910.75 MHz – ISO-10374 - 1 GHz – 10GHz

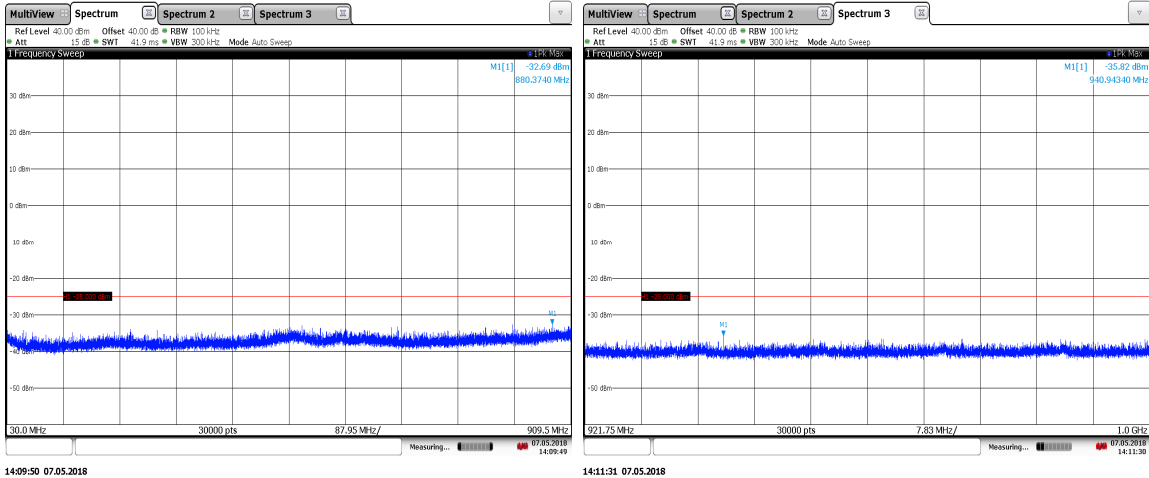

Figure 7.3.2-27: 920.75 MHz – ISO-10374 - 30MHz to Edge Figure 7.3.2-28: 920.75 MHz – ISO-10374 – Edge to 1GHz

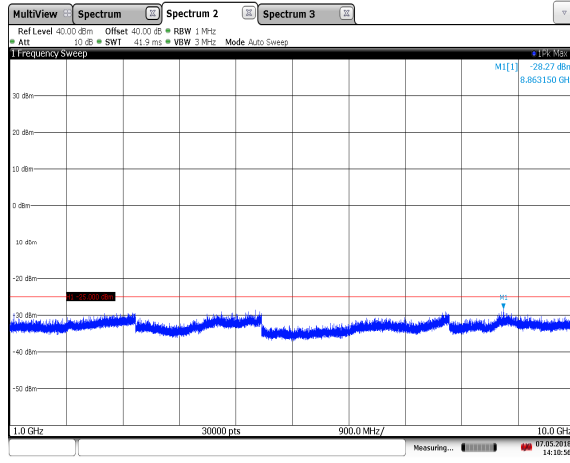
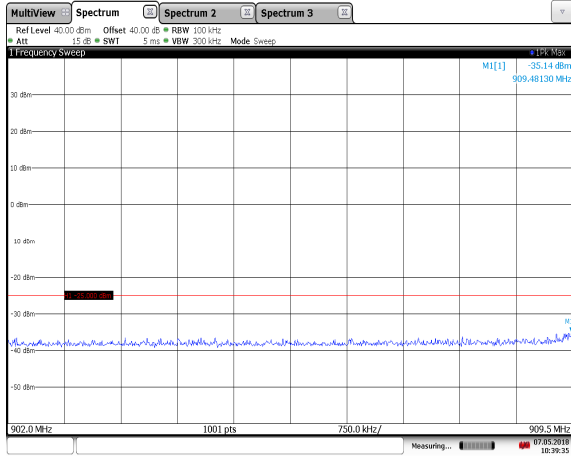

Figure 7.3.2-29: 920.75 MHz – ISO-10374 - 1 GHz – 10GHz

Protocol: PS111_MANCHESTER



10:39:35 07.05.2018

Figure 7.3.2-30: 913.75 MHz – PS111 - Low Edge

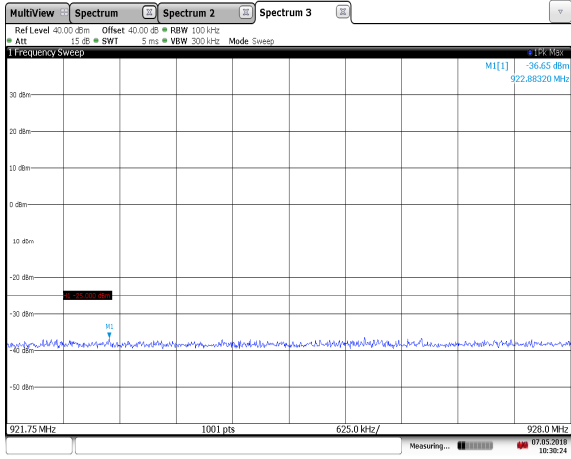

10:39:25 07.05.2018

Figure 7.3.2-31: 916.25 MHz – PS111– High Edge

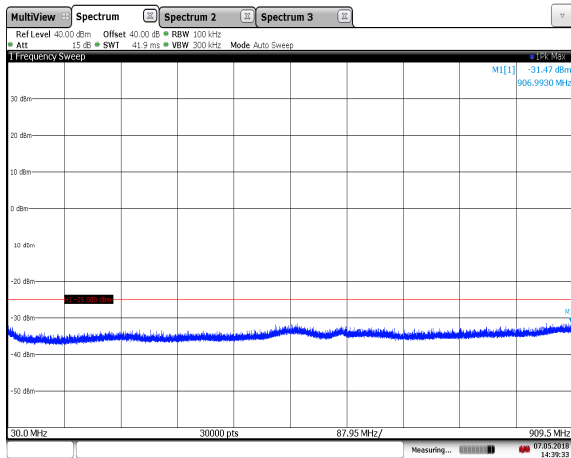

14:39:34 07.05.2018

Figure 7.3.2-32: 913.75 MHz – PS111 - 30MHz to Edge

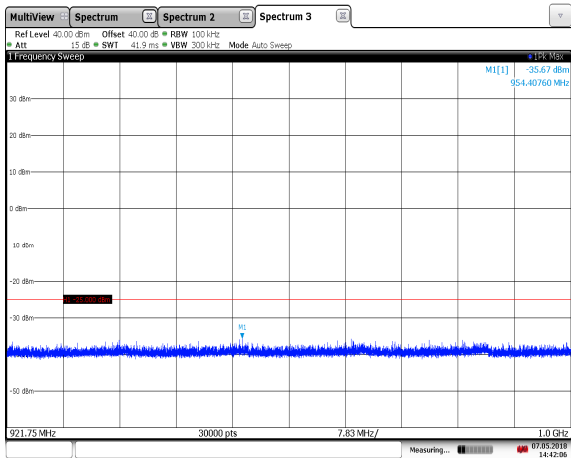

14:42:06 07.05.2018

Figure 7.3.2-33: 913.75 MHz – PS111 – Edge to 1GHz

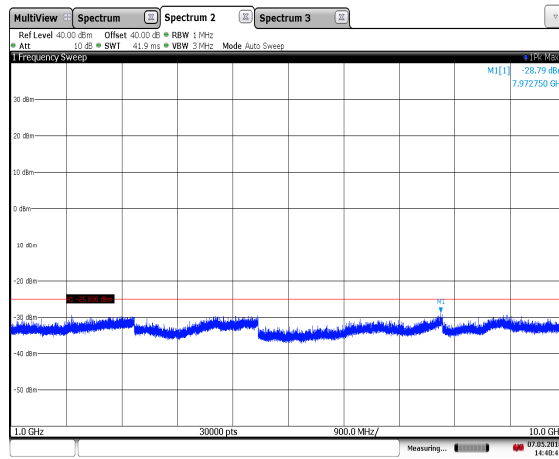

14:40:45 07.05.2018

Figure 7.3.2-34: 913.75 MHz – PS111 - 1 GHz – 10GHz

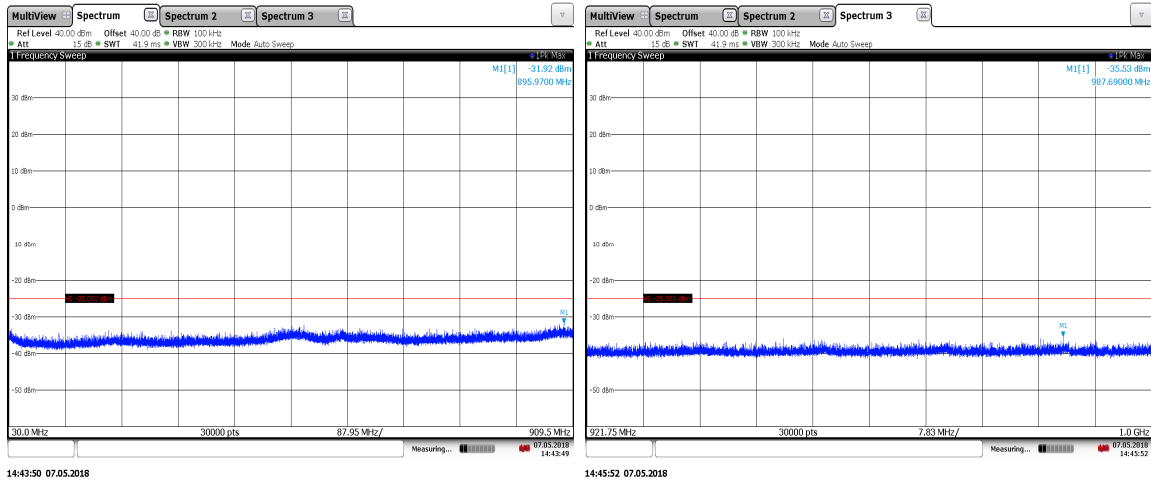

Figure 7.3.2-35: 916.25 MHz – PS111 - 30MHz to Edge

Figure 7.3.2-36: 916.25 MHz – PS111 – Edge to 1GHz

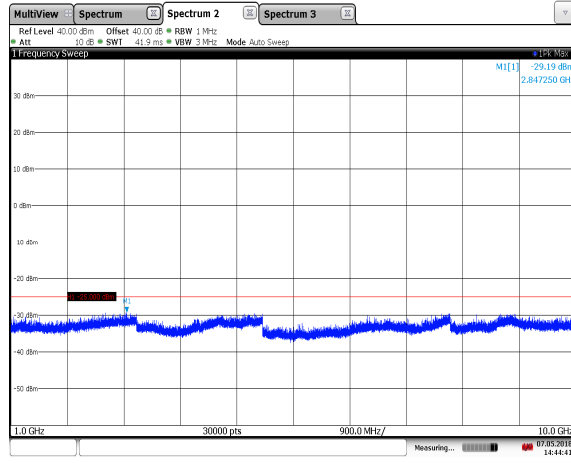

Figure 7.3.2-37: 916.25 MHz – PS111 - 1 GHz – 10GHz

7.4 Field Strength of Spurious Emissions

7.4.1 Measurement Procedure

The equipment under test is placed in the Semi-Anechoic Chamber (described in section 2.3.1) on a wooden table at the turntable center. For each spurious emission, the antenna mast is raised and lowered from one (1) to four (4) meters and the turntable is rotated 360° and the maximum reading on the spectrum analyzer is recorded. This was repeated for both horizontal and vertical polarizations of the receive antenna.

The equipment under test is then replaced with a substitution antenna fed by a signal generator. The signal generator's frequency is set to that of the spurious emission recorded from the equipment under test. The antenna mast is raised and lowered from one (1) to four (4) meters to obtain a maximum reading on the spectrum analyzer. The output of the signal generator is then adjusted until the reading on the spectrum analyzer matches that obtained from the equipment under test. The signal generator level is recorded. The power in dBm of each spurious emission is calculated by correcting the signal generator level for the cable loss and gain of the substitution antenna referenced to a dipole. The spectrum was investigated in accordance to CFR 47 Part 2.1057.

The magnitude of all spurious emissions not reported were attenuated below the noise floor of the measurement system and therefore not specified in this report. Results are shown below.

7.4.2 Measurement Results - FCC Part 90.210(d); ISED Canada RSS-137

Performed by Jean Tezil and Charles Callis

Table 7.4.2-1: Field Strength of Spurious Emissions – C1G2 – 911.75 MHz

Frequency (MHz)	Spectrum Analyzer Level (dB μ V/m)	Antenna Polarity (H/V)	Spurious ERP (dBm)	Limit (dBm)	Margin (dB)
1823.5	53.30	H	-52.39	-25.00	27.39
1823.5	54.60	V	-49.69	-25.00	24.69
2735.25	46.30	H	-58.77	-25.00	33.77
2735.25	50.20	V	-52.87	-25.00	27.87
3647	43.90	H	-63.49	-25.00	38.49
3647	47.60	V	-56.39	-25.00	31.39
4558.75	47.30	H	-53.07	-25.00	28.07
4558.75	52.50	V	-46.57	-25.00	21.57
5470.5	43.80	H	-61.40	-25.00	36.40
5470.5	45.10	V	-59.40	-25.00	34.40
7294	43.90	H	-57.57	-25.00	32.57
7294	45.20	V	-55.17	-25.00	30.17
9117.5	43.00	V	-61.11	-25.00	36.11

NOTE: All frequencies not listed were below the noise floor of the spectrum analyzer.

Table 7.4.2-2: Field Strength of Spurious Emissions – C1G2 – 919.25 MHz

Frequency (MHz)	Spectrum Analyzer Level (dB μ V/m)	Antenna Polarity (H/V)	Spurious ERP (dBm)	Limit (dBm)	Margin (dB)
1838.5	52.70	H	-52.79	-25.00	27.79
1838.5	55.2	V	-48.59	-25.00	23.59
2757.75	45.1	H	-61.28	-25.00	36.28
2757.75	49.2	V	-53.68	-25.00	28.68
3677	44.2	H	-64.19	-25.00	39.19
3677	45.1	V	-62.89	-25.00	37.89
4596.25	49.2	H	-48.57	-25.00	23.57
4596.25	53.2	V	-44.77	-25.00	19.77
5515.5	43.5	H	-61.38	-25.00	36.38
5515.5	44.3	V	-60.38	-25.00	35.38
6434.75	45.6	H	-53.95	-25.00	28.95
6434.75	47.7	V	-50.05	-25.00	25.05
7354	44.9	H	-54.65	-25.00	29.65
7354	46.9	V	-50.85	-25.00	25.85
9192.5	44.1	V	-54.30	-25.00	29.30

NOTE: All frequencies not listed were below the noise floor of the spectrum analyzer.

Table 7.4.2-3: Field Strength of Spurious Emissions – ISOB – 911.75 MHz

Frequency (MHz)	Spectrum Analyzer Level (dB μ V/m)	Antenna Polarity (H/V)	Spurious ERP (dBm)	Limit (dBm)	Margin (dB)
1823.5	58.00	H	-46.99	-25.00	21.99
1823.5	57.10	V	-46.69	-25.00	21.69
2735.25	44.50	H	-62.57	-25.00	37.57
2735.25	48.00	V	-55.57	-25.00	30.57
3647	44.00	H	-63.49	-25.00	38.49
3647	46.60	V	-58.49	-25.00	33.49
4558.75	46.20	H	-54.07	-25.00	29.07
4558.75	49.30	V	-51.07	-25.00	26.07
5470.5	58.00	V	-63.10	-25.00	38.10
6382.25	44.00	H	-57.82	-25.00	32.82
6382.25	44.30	V	-51.82	-25.00	26.82
7294	47.00	H	-57.17	-25.00	32.17
7294	44.40	V	-52.27	-25.00	27.27
8205.75	46.10	H	-60.33	-25.00	35.33
8205.75	42.70	V	-58.73	-25.00	33.73
9117.5	43.00	V	-61.11	-25.00	36.11

NOTE: All frequencies not listed were below the noise floor of the spectrum analyzer.

Table 7.4.2-4: Field Strength of Spurious Emissions – ISOB – 919.75 MHz

Frequency (MHz)	Spectrum Analyzer Level (dB μ V/m)	Antenna Polarity (H/V)	Spurious ERP (dBm)	Limit (dBm)	Margin (dB)
1839.5	50.30	H	-55.99	-25.00	30.99
1839.5	53.5	V	-50.79	-25.00	25.79
2759.25	44.7	H	-61.38	-25.00	36.38
2759.25	48.1	V	-55.68	-25.00	30.68
3679	44.2	H	-64.19	-25.00	39.19
3679	45.2	V	-62.39	-25.00	37.39
4598.75	49.5	H	-48.58	-25.00	23.58
4598.75	52.1	V	-46.48	-25.00	21.48
5518.5	43.2	H	-61.38	-25.00	36.38
5518.5	44.2	V	-60.38	-25.00	35.38
6438.25	46.3	H	-53.54	-25.00	28.54
6438.25	47.4	V	-50.44	-25.00	25.44
7358	43.8	H	-57.66	-25.00	32.66
7358	44.4	V	-57.56	-25.00	32.56
9197.5	44.2	V	-54.20	-25.00	29.20

NOTE: All frequencies not listed were below the noise floor of the spectrum analyzer.

Table 7.4.2-5: Field Strength of Spurious Emissions - ISO10374 – 902.75 MHz

Frequency (MHz)	Spectrum Analyzer Level (dB μ V/m)	Antenna Polarity (H/V)	Spurious ERP (dBm)	Limit (dBm)	Margin (dB)
1805.5	54.80	H	-49.98	-25.00	24.98
1805.5	57.50	V	-47.68	-25.00	22.68
2708.25	46.30	H	-58.45	-25.00	33.45
2708.25	48.70	V	-55.85	-25.00	30.85
3611	44.00	H	-66.28	-25.00	41.28
3611	47.50	V	-63.48	-25.00	38.48
4513.75	45.40	H	-57.85	-25.00	32.85
4513.75	49.20	V	-54.65	-25.00	29.65
5416.5	44.20	H	-60.48	-25.00	35.48
5416.5	47.00	V	-58.28	-25.00	33.28
6319.25	42.80	H	-63.81	-25.00	38.81
6319.25	44.10	V	-62.44	-25.00	37.44
7222	43.90	H	-55.86	-25.00	30.86
7222	45.40	V	-54.63	-25.00	29.63
8124.75	42.80	H	-62.95	-25.00	37.95
8124.75	43.90	V	-61.95	-25.00	36.95
9027.5	42.80	V	-55.31	-25.00	30.31

NOTE: All frequencies not listed were below the noise floor of the spectrum analyzer.

Table 7.4.2-6: Field Strength of Spurious Emissions - ISO10374 – 910.75 MHz

Frequency (MHz)	Spectrum Analyzer Level (dB μ V/m)	Antenna Polarity (H/V)	Spurious ERP (dBm)	Limit (dBm)	Margin (dB)
1821.5	53.10	H	-52.68	-25.00	27.68
1821.5	56.80	V	-49.98	-25.00	24.98
2732.25	46.70	H	-58.17	-25.00	33.17
2732.25	49.10	V	-55.47	-25.00	30.47
3643	45.00	H	-60.79	-25.00	35.79
3643	47.60	V	-59.59	-25.00	34.59
4553.75	46.40	H	-55.46	-25.00	30.46
4553.75	49.70	V	-53.96	-25.00	28.96
5464.5	42.70	H	-67.39	-25.00	42.39
5464.5	46.10	V	-64.59	-25.00	39.59
6375.25	44.00	H	-59.13	-25.00	34.13
6375.25	47.50	V	-56.33	-25.00	31.33
7286	50.00	H	-45.05	-25.00	20.05
7286	46.50	V	-49.95	-25.00	24.95
9107.5	43.30	V	-59.40	-25.00	34.40

NOTE: All frequencies not listed were below the noise floor of the spectrum analyzer.

Table 7.4.2-7: Field Strength of Spurious Emissions - ISO10374 – 920.75 MHz

Frequency (MHz)	Spectrum Analyzer Level (dB μ V/m)	Antenna Polarity (H/V)	Spurious ERP (dBm)	Limit (dBm)	Margin (dB)
1841.5	51.50	H	-54.29	-25.00	29.29
1841.5	56.50	V	-48.09	-25.00	23.09
2762.25	45.60	H	-59.98	-25.00	34.98
2762.25	48.90	V	-55.48	-25.00	30.48
3683	43.70	H	-66.39	-25.00	41.39
3683	46.30	V	-63.39	-25.00	38.39
4603.75	48.30	H	-50.69	-25.00	25.69
4603.75	52.00	V	-48.49	-25.00	23.49
5524.5	43.00	H	-66.57	-25.00	41.57
5524.5	45.60	V	-64.97	-25.00	39.97
6445.25	46.90	H	-52.13	-25.00	27.13
6445.25	48.10	V	-51.13	-25.00	26.13
7366	43.20	H	-59.87	-25.00	34.87
7366	43.80	V	-59.17	-25.00	34.17
9207.5	43.00	H	-55.12	-25.00	30.12
9207.5	44.30	V	-53.22	-25.00	28.22

NOTE: All frequencies not listed were below the noise floor of the spectrum analyzer.

Table 7.4.2-8: Field Strength of Spurious Emissions - PS111 – 913.75 MHz

Frequency (MHz)	Spectrum Analyzer Level (dB μ V/m)	Antenna Polarity (H/V)	Spurious ERP (dBm)	Limit (dBm)	Margin (dB)
1827.5	54.80	H	-50.89	-25.00	25.89
1827.5	56.70	V	-49.09	-25.00	24.09

NOTE: All frequencies not listed were below the noise floor of the spectrum analyzer.

Table 7.5.2-9: Field Strength of Spurious Emissions - PS111 – 916.75 MHz

Frequency (MHz)	Spectrum Analyzer Level (dB μ V/m)	Antenna Polarity (H/V)	Spurious ERP (dBm)	Limit (dBm)	Margin (dB)
1832.5	55.20	H	-49.89	-25.00	24.89
1832.5	58.30	V	-47.29	-25.00	22.29

NOTE: All frequencies not listed were below the noise floor of the spectrum analyzer.

8 MEASUREMENT UNCERTAINTY

The expanded laboratory measurement uncertainty figures (U_{Lab}) provided below correspond to an expansion factor (coverage factor) $k = 1.96$ which provide confidence levels of 95%.

Parameter	U_{lab}
Occupied Channel Bandwidth	$\pm 0.004\%$
RF Conducted Output Power	$\pm 0.689 \text{ dB}$
Power Spectral Density	$\pm 0.5 \text{ dB}$
Antenna Port Conducted Emissions	$\pm 2.717 \text{ dB}$
Radiated Emissions	$\pm 5.877 \text{ dB}$
Temperature	$\pm 0.860 \text{ }^\circ\text{C}$
Radio Frequency	$\pm 2.832 \times 10^{-8}$
AC Power Line Conducted Emissions	± 2.85

9 CONCLUSION

In the opinion of TÜV SÜD America Inc. the HRD26000, manufactured by Star Systems International Limited, meets the requirements of FCC Part 90 subpart M and ISED Canada's Radio Standards Specification RSS-137 for the tests documented herein.

END REPORT