



RF Test Report

Issued Date: Sep. 23, 2019

Applicant : KRONOZ
 Product Type : Smart Watch
 Trade Name : MYKRONOZ
 Model Number : ZeNeo
 FCC ID : 2AA7D-ZNEO
 EUT Rated Voltage : DC 5 V, 0.5 A
 Test Voltage : 120 Vac / 60 Hz
 Receive Date : Jun. 11, 2019
 Test Period : Sep. 03 ~ Sep. 12, 2019
 Applicable Standard : FCC 47 CFR PART 15 SUBPART C
 ANSI C63.10:2013
 Test Result : Complied

Testing Laboratory

A Test Lab Techno Corp.

101-104, 1F, A building, Safflower ridge industrial area,
 Taoyuan street, Nanshan district, Shenzhen
 Tel : +86-755-23987770 / Fax : +86-755-26637771
<http://www.atl-lab.com.tw/e-index.htm>



American Association for Laboratory Accreditation number: 3464.02
 Test Firm MRA designation number: CN1168

Note: This report shall not be reproduced except in full, without the written approval of A Test Lab Techno Corp. This document may be altered or revised by A Test Lab Techno Corp. personnel only and shall be noted in the revision section of the document. The client should not use it to claim product endorsement by A2LA, or any government agencies. The test results in the report only apply to the tested sample.

Approved By : Jet Lu Reviewed By : Louis Shen
 (Manager) (Jet Lu) (Testing Engineer) (Louis Shen)



Revision History

Rev.	Issue Date	Revisions
00	Sep. 23, 2019	Initial Issue

TABLE OF CONTENTS

1	General Information	4
	1.1. Summary of Test Result.....	4
	1.2. Measurement Uncertainty.....	5
2	EUT Description	6
3	Test Methodology	7
	3.1. Mode of Operation.....	7
	3.2. EUT Exercise Software.....	8
	3.3. Configuration of Test System Details.....	9
	3.4. Test Instruments.....	10
	3.5. Test Site Environment.....	11
4	Measurement Procedure	12
	4.1. Maximum Conducted Output Power Measurement.....	12
	4.2. AC Power Line Conducted Emission Measurement.....	13
	4.3. Radiated Emission Measurement.....	15
	4.4. 20dB RF Bandwidth Measurement.....	18
	4.5. Carrier Frequency Separation Measurement.....	19
	4.6. Number of Hopping Measurement.....	20
	4.7. Time of Occupancy (Dwell Time) Measurement.....	21
	4.8. Out of Band Conducted Emissions Measurement.....	22
	4.9. Antenna Measurement.....	22
5	Test Results	23
	Annex A. Conducted Emission.....	23
	Annex B. Conducted Test Results.....	25
	Annex C. Radiated Emission Measurement.....	43



1 General Information

1.1. Summary of Test Result

FCC Standard	Item	Result	Remark
15.207	AC Power Conducted Emission	PASS	-----
15.203	Antenna Requirement	PASS	-----
15.247(b)(1)	Max. Output Power	PASS	-----
15.247(d)	Transmitter Radiated Emissions	PASS	-----
15.247(a)(1)	20dB RF Bandwidth	PASS	-----
15.247(a)(1)	Carrier Frequency Separation	PASS	-----
15.247(a)(1)(iii)	Number of Hopping	PASS	-----
15.247(a)(1)(iii)	Time of Occupancy (Dwell Time)	PASS	-----
15.247(d)	Out of Band Conducted Spurious Emission	PASS	-----

Standard	Description
CFR47, Part 15, Subpart C §15.247	Intentional Radiators
ANSI C63. 10: 2013	American National Standard of Procedures for Compliance Testing of Unlicensed Wireless Devices
ANSI C63. 4: 2014	American National Standard for methods of measurement of radio – noise emissions from low-voltage electrical and electronic equipment in the range of 9 kHz to 40 GHz
DA 00-705	Filing and Measurement Guidelines for Frequency Hopping Spread Spectrum Systems
KDB558074 D01 v05r02	GUIDANCE FOR COMPLIANCE MEASUREMENTS ON DIGITAL TRANSMISSION SYSTEM, FREQUENCY HOPPING SPREAD SPECTRUM SYSTEM, AND HYBRID SYSTEM DEVICES OPERATING UNDER SECTION 15.247 OF THE FCC RULES

The test results of this report relate only to the tested sample(s) identified in this report. Manufacturer or whom it may concern should recognize the pass or fail of the test result.



A Test Lab Techno Corp. tested the above equipment under the requirements outlined in the above standards. All indications of Pass/Fail in this report are opinions expressed by A Test Lab Techno Corp. Based on interpretations and/or observations of test results. Measurement Uncertainties were not taken into account and are published for informational purposes only. The test results show that the equipment tested is capable of demonstrating compliance with the requirements as documented in this report.

A Test Lab Techno Corp. will not be liable for any loss or damage resulting from false, inaccurate, inappropriate or incomplete product information provided by the customer.

This test report is electronically signed and valid without handwriting signature. For verification of the electronic signatures, the public keys can be requested at the testing laboratory.

1.2. Measurement Uncertainty

Test Item	Frequency Range	Uncertainty (dB)
Conducted Emission	9kHz ~ 150kHz	2.7
	150kHz ~ 30MHz	2.7
Radiated Emission	9kHz ~ 30MHz	1.7
	30MHz ~ 1000MHz	5.7
	1000MHz ~ 18000MHz	5.5
	18000MHz ~ 26500MHz	4.8
	26500MHz ~ 40000MHz	4.8
Conducted Output Power	+0.27 dB / -0.28 dB	
RF Bandwidth	4.96%	
Power Spectral Density	+0.71 dB / -0.77 dB	

2 EUT Description

Applicant	KRONOZ ROUTE DE VALAVRAN 96, GENTHOD, 1294, Switzerland	
Manufacturer	KRONOZ ROUTE DE VALAVRAN 96, GENTHOD, 1294, Switzerland	
Product	Smart Watch	
Trade Name	MYKRONOZ	
Model Number	ZeNeo	
FCC ID	2AA7D-ZNEO	
Frequency Range	2402 ~ 2480 MHz	
Modulation Type	GFSK for 1Mbps	
	$\pi/4$ -DQPSK for 2Mbps	
	8DPSK for 3Mbps	
Operate Temp. Range	-10 ~ +60°C	
Antenna information	Type	Max. Gain (dBi)
	FPC Antenna	-1.12
RF Output Power (Conducted)	GFSK for 1Mbps	0.00322 W
	$\pi/4$ -DQPSK for 2Mbps	0.00547 W
	8DPSK for 3Mbps	0.00548 W

3 Test Methodology

3.1. Mode of Operation

Decision of Test ATL has verified the construction and function in typical operation. All the test modes were carried out with the EUT in normal operation, which was shown in this test report and defined as:

Pre-Test Mode
Mode 1: Transmit mode
Mode 2: GFSK Continuous TX mode
Mode 3: $\pi/4$ -DQPSK Continuous TX mode
Mode 4: 8DPSK Continuous TX mode

After verification, all tests were carried out with the worst case test modes as shown below except radiated spurious emission below 1GHz and power line conducted emissions below 30MHz, which worst case was in TX mode only. By preliminary testing and verifying three axis (X, Y and Z) position of EUT transmitted status, it was found that "X axis" position was the worst, then the final test was executed the worst condition and test data were recorded in this report.

Final-Test Mode
Mode 1: Transmit mode
Mode 2: GFSK Continuous TX mode
Mode 4: 8DPSK Continuous TX mode

Description of Test Modes

Preliminary tests were performed in different modulation to find the worst case. The modulation has shown the worst-case in section 4.5. Investigation has been done on all the possible configurations for searching the worst cases.



3.2. EUT Exercise Software

1	Setup the EUT shown on "Configuration of Test System Details."
2	Turn on the power of all equipment.
3	Turn on TX function
4	EUT run test program.

Measurement Software	
1	EZ-EMC Ver. ATL-03A1-1
2	EZ-EMC Ver ATL-ITC-3A1-1 (for Conducted Emission)

3.3. Configuration of Test System Details

Conducted Emission

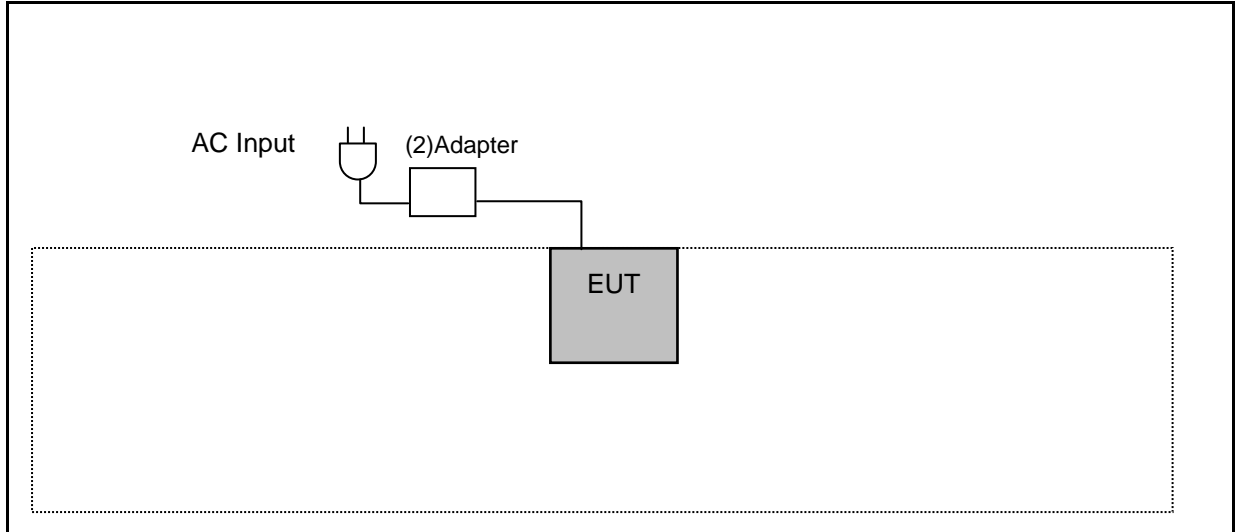

Radiated Emissions

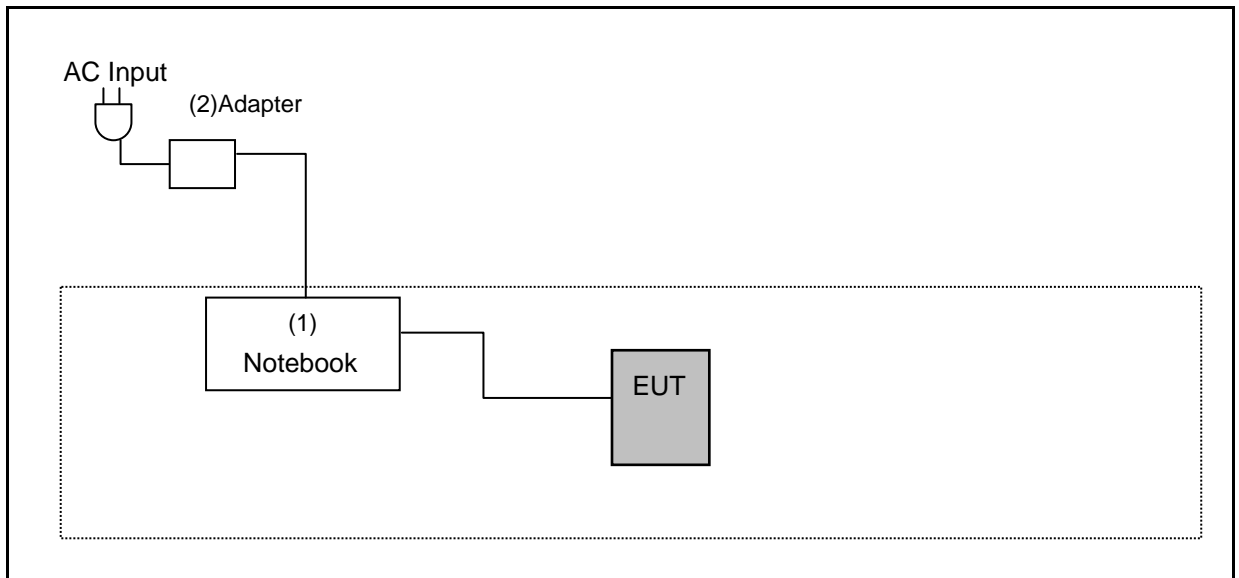

Devices Description					
	Product	Manufacturer	Model Number	Serial Number	Power Cord
(1)	Notebook	Lenovo	ThinkPad E560	2015AP4354	Non-Shielded,0.8 m
(2)	AC Adapter	Chicony	ADLX65NOC3A	---	INPUT: AC 100 V to 240 V, 50 Hz / 60Hz,0.3A OUTPUT: DC 20 V, 3.25 A



3.4. Test Instruments

For Conducted Emission

Test Period: Sep. 03, 2019

Equipment	Manufacturer	Model Number	Serial Number	Cal. Date	Cal. Period
Test Receiver	R&S	ESR3	101923	09/18/2018	1 year
LISN	R&S	ENV216	101942	09/18/2018	1 year
LISN	R&S	ENV216	101943	09/18/2018	1 year
RF Cable	EMCI	EMCCFD400	433LFC	09/18/2018	1 year
Test Site	ATL	CE	CE	N.C.R.	-----

For Radiated Emissions

Test Period: Sep. 03 ~ Sep. 12, 2019

Equipment	Manufacturer	Model Number	Serial Number	Cal. Date	Cal. Period
Preamplifier (10 kHz~3 GHz)	EMCI	EMC001330	980300	09/18/2018	1 year
Preamplifier (0.1 GHz~26.5 GHz)	EMCI	EMC012645SE	980318	09/18/2018	1 year
Bilog Antenna (30 MHz~1.4 GHz)	Schwarzbeck	VULB 9168	672	11/21/2018	1 year
Horn Antenna (1 GHz~18 GHz)	ETS	3117	00204949	11/05/2018	1 year
Horn Antenna (18 GHz~26.5 GHz)	ETS	3160-09	00202549	11/05/2018	1 year
Receiver (3 Hz~26.5 GHz)	Keysight	N9038A	MY51210179	09/18/2018	1 year
Spectrum Analyzer (3 Hz~43 GHz)	Keysight	N9030A	MY55410268	09/18/2018	1 year
Cable (30 MHz~1 GHz)	EMCI	N/A	1066LFC	09/18/2018	1 year
Cable (1 GHz~18 GHz)	EMCI	N/A	160719	09/18/2018	1 year
Cable (1 GHz~18 GHz)	EMCI	N/A	160324	09/18/2018	1 year
Cable (1 GHz~18 GHz)	EMCI	N/A	160322	09/18/2018	1 year
Loop Antenna	EMCI	LPA600	272	02/21/2019	1 year
Test Site	OuHeng	MFAC3M	RE-026	02/14/2019	1 year

Note: N.C.R. = No Calibration Request.



For Conducted

Test Period: Sep. 03 ~ Sep. 12, 2019

Equipment	Manufacturer	Model Number	Serial Number	Cal. Date	Cal. Period
Power Sensor	Anritsu	U2021XA	SG54130003	09/18/2018	1 year
Power Sensor	Anritsu	U2021XA	SG54130004	09/18/2018	1 year
Spectrum Analyzer (10Hz~26.5GHz)	Agilent	N9020A	MY53420615	09/18/2018	1 year
Programmable temp &humi chamber	ETAI	9712A	647	11/15/2018	1 year
Signal Generator	Agilent	E8257D	MY53400659	09/18/2018	1 year
Signal Generator	Agilent	N5182B	MY53050940	09/18/2018	1 year
Test Site	ATL	RF	RF	N.C.R.	-----

Note: N.C.R. = No Calibration Request.

3.5. Test Site Environment

Items	Required (IEC 60068-1)	Actual
Temperature (°C)	15-35	26
Humidity (%RH)	25-75	60
Barometric pressure (mbar)	860-1060	950

4 Measurement Procedure

4.1. Maximum Conducted Output Power Measurement

■ Limit

For frequency hopping systems operating in the 2400–2483.5 MHz band employing at least 75 non-overlapping hopping channels < 0.125 watt.

■ Test Setup

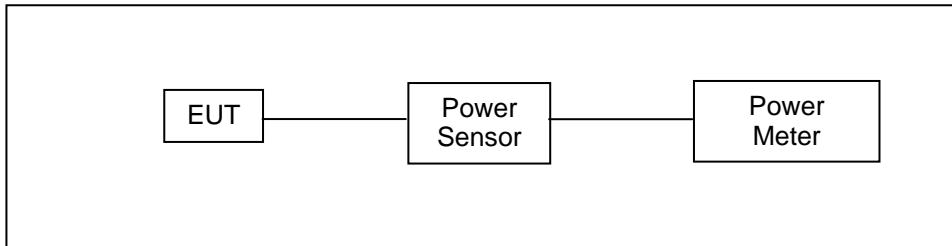

■ Test Procedure

Testing must be done according to this procedure, FCC Public Notice DA 00-705 - Filing and Measurement Guidelines for Frequency Hopping Spread Spectrum Systems. This is the only method recognized by the FCC. The tests below are run with the EUT's transmitter set at high power in TX mode. The EUT is needed to force selection of output power level and channel number. While testing, EUT was set to transmit continuously. Remove the Subjective device's antenna and connect the RF output port to power sensor. The maximum peak output power shall not exceed 1 watt.

Use a direct connection between the antenna port of transmitter and the power sensor, for prevent the power sensor input attenuation 40-50 dB. Set the RBW Bandwidth of the emission or use a channel power meter mode. For antennas with gains of 6 dBi or less, maximum allowed transmitter output is 1 watt (+30 dBm). For antennas with gains greater than 6 dBi, transmitter output level must be decreased by an amount equal to $(\text{GAIN} - 6)/3$ dBm. The antenna port of the EUT was connected to the input of a power sensor. Power was read directly and cable loss correction was added to the reading to obtain power at the EUT antenna terminals.

4.2. AC Power Line Conducted Emission Measurement

■ Limit

Frequency (MHz)	Quasi-peak	Average
0.15 - 0.5	66 to 56	56 to 46
0.50 - 5.0	56	46
5.0 - 30.0	60	50

■ Test Setup

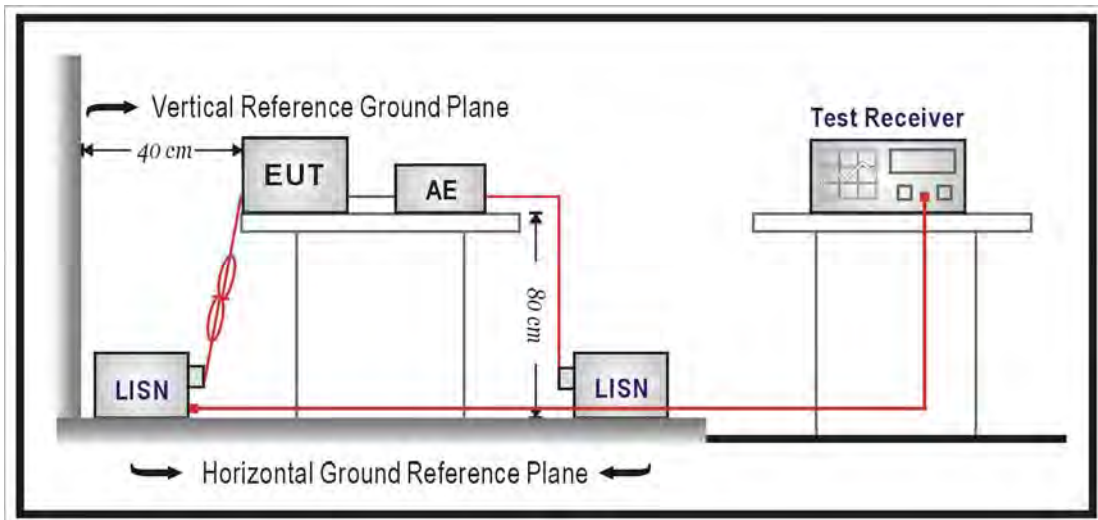

■ Test Procedure

The EUT and simulators are connected to the main power through a line impedance stabilization network (L.I.S.N.). This provides a $50\Omega//50\mu\text{H}$ coupling impedance for the measuring equipment. The peripheral devices are also connected to the main power through a LISN that provides a $50\Omega//50\mu\text{H}$ coupling impedance with 50Ω termination.

Tabletop device shall be placed on a non-conducting platform, of nominal size 1 m by 1.5 m, raised 80 cm above the reference ground plane. The wall of screened room shall be located 40cm to the rear of the EUT. Other surfaces of tabletop or floor standing EUT shall be at least 80cm from any other ground conducting surface including one or more LISNs. For floor-standing device shall be placed under the EUT with a 12mm insulating material.

Conducted emissions were investigated over the frequency range from 0.15 MHz to 30 MHz using a resolution bandwidth of 9 kHz. The equipment under test (EUT) shall be meet the limits in section 4.1, as applicable, including the average limit and the quasi-peak limit when using respectively, an average detector and quasi-peak detector measured in accordance with the methods described of related standard. When all of peak value were complied with quasi-peak and average limit from 150kHz to 30MHz then quasi-peak and average measurement was unnecessary.

The AMN shall be placed 0,8 m from the boundary of the unit under test and bonded to a ground reference plane for AMNs mounted on top of the ground reference plane. This distance is between the closest points of the AMN and the EUT. All other units of the EUT and associated equipment shall be at least 0,8 m from the AMN. If the mains power cable is longer than 1m then the cable shall be folded back and forth at the centre of the lead to form a bundle no longer than 0.4m. All of interconnecting cables that hang closer than 40cm to the ground plane shall be folded back and forth in the center forming a bundle 30 cm to 40 cm long. All of EUT and AE shall be separate place more than 0.1m. All 50Ω ports of the LISN shall be resistively terminated into 50Ω loads when not connected to the measuring instrument.

If the reading of the measuring receiver shows fluctuations close to the limit, the reading shall be observed for at least 15 s at each measurement frequency; the higher reading shall be recorded with the exception of any brief isolated high reading which shall be ignored.

4.3. Radiated Emission Measurement

■ Limit

According to §15.209(a), except as provided elsewhere in this subpart, the emissions from an intentional radiator shall not exceed the field strength levels specified in the following table:

Frequency (MHz)	Field Strength ($\mu\text{V}/\text{m}$ at meter)	Measurement Distance (meters)
0.009 – 0.490	$2400 / F$ (kHz)	300
0.490 – 1.705	$24000 / F$ (kHz)	30
1.705 – 30.0	30	30
30 - 88	100^{**}	3
88-216	150^{**}	3
216-960	200^{**}	3
Above 960	500	3

** Except as provided in paragraph (g), fundamental emissions from intentional radiators operating under this Section shall not be located in the frequency bands 54-72 MHz, 76-88 MHz, 174-216 MHz or 470-806 MHz. However, operation within these frequency bands is permitted under other sections of this Part, e.g., Sections 15.231 and 15.241.

■ Setup

9kHz ~ 30MHz

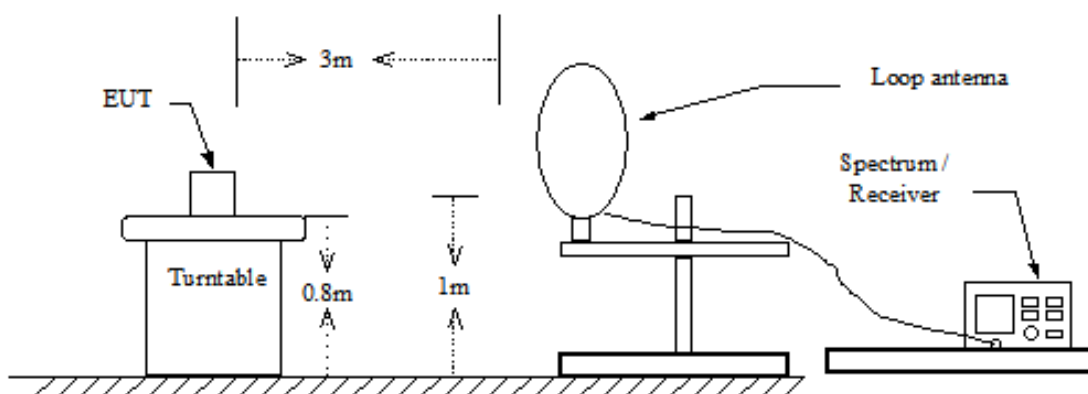

Below 1GHz

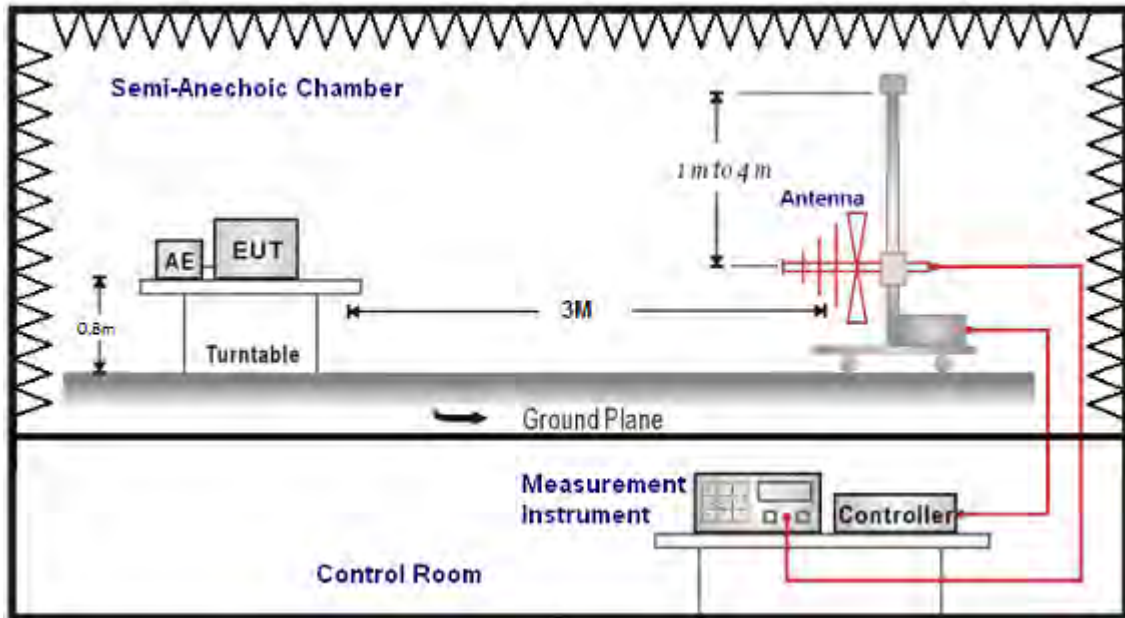

Above 1GHz

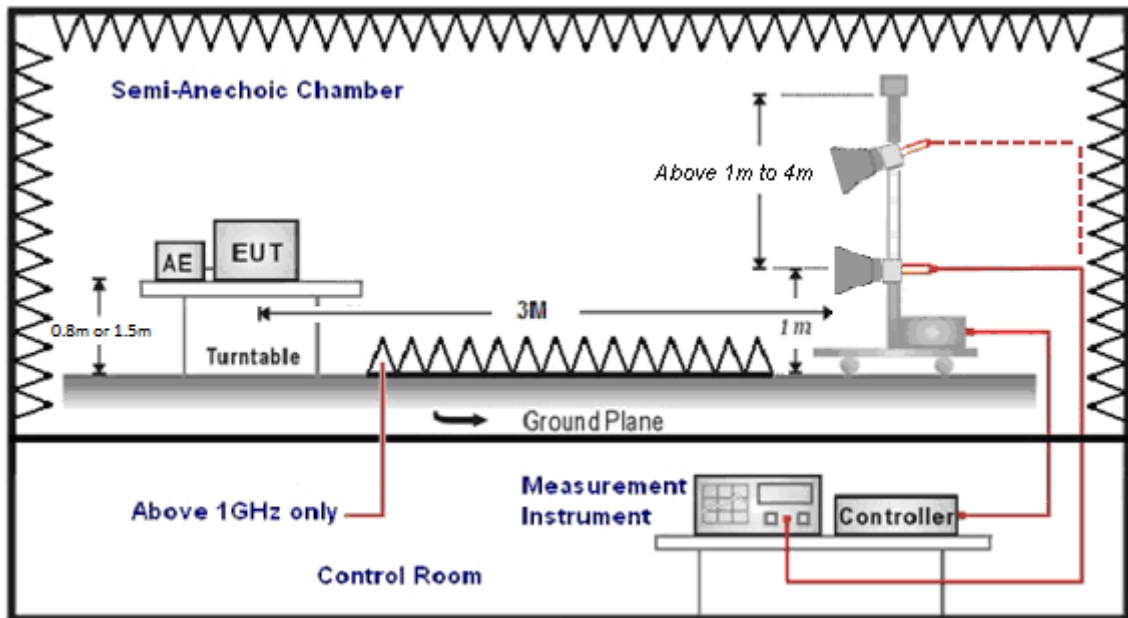

■ Test Procedure

Final radiation measurements were made on a three-meter, Semi Anechoic Chamber. The EUT system was placed on a nonconductive turntable which is 0.8 or 1.5 meters height, top surface 1.0 x 1.5 meter. The spectrum was examined from 250 MHz to 2.5 GHz in order to cover the whole spectrum below 10th harmonic which could generate from the EUT. During the test, EUT was set to transmit continuously & Measurements spectrum range from 9 kHz to 26.5 GHz is investigated.

For measurements below 1 GHz the resolution bandwidth is set to 100 kHz for peak detection measurements or 120 kHz for quasi-peak detection measurements. Peak detection is used unless otherwise noted as quasi-peak.

For measurements above 1 GHz the resolution bandwidth is set to 1 MHz, and then the video bandwidth is set to 1 MHz for peak measurements and 10 Hz for average measurements.

A nonconductive material surrounded the EUT to supporting the EUT for standing on three orthogonal planes. At each condition, the EUT was rotated 360 degrees, and the antenna was raised and lowered from one to four meters to find the maximum emission levels. Measurements were taken using both horizontal and vertical antenna polarization.

SCHWARZBECK MESS-ELEKTRONIK Biconilog Antenna at 3 Meter and the SCHWARZBECK Double Ridged Guide Antenna was used in frequencies 1 – 26.5 GHz at a distance of 1 meter. All test results were extrapolated to equivalent signal at 3 meters utilizing an inverse linear distance extrapolation Factor (20dB/decade).

For testing above 1GHz, the emission level of the EUT in peak mode was 20dB lower than average limit (that means the emission level in peak mode also complies with the limit in average mode), then testing will be stopped and peak values of EUT will be reported, otherwise, the emissions will be measured in average mode again and reported.

Appropriate preamplifiers were used for improving sensitivity and precautions were taken to avoid overloading or desensitizing the spectrum analyzer. No post – detector video filters were used in the test.

The spectrum analyzer's 6 dB bandwidth was set to 1 MHz, and the analyzer was operated in the peak detection mode, for frequencies both below and up 1 GHz. The average levels were obtained by subtracting the duty cycle correction factor from the peak readings.

The following procedures were used to convert the emission levels measured in decibels referenced to 1 microvolt (dBuV) into field intensity in micro volts pre meter (uV/m).

The actual field intensity in decibels referenced to 1 microvolt in to field intensity in micro volts per meter (dBuV/m).

The actual field intensity in referenced to 1 microvolt per meter (dBuV/m) is determined by algebraically adding the measured reading in dBuV, the antenna factor (dB), and cable loss (dB) and Subtracting the gain of preamplifier (dB) is auto calculate in spectrum analyzer.

$$(1) \text{ Amplitude (dBuV/m) = FI (dBuV) +AF (dBuV) +CL (dBuV)-Gain (dB)}$$

FI= Reading of the field intensity.

AF= Antenna factor.

CL= Cable loss.

P.S Amplitude is auto calculate in spectrum analyzer.

$$(2) \text{ Actual Amplitude (dBuV/m) = Amplitude (dBuV)-Dis(dB)}$$

The FCC specified emission limits were calculated according the EUT operating frequency and by following linear interpolation equations:

(a) For fundamental frequency : Transmitter Output < +30dBm

(b) For spurious frequency : Spurious emission limits = fundamental emission limit /10

Data of measurement within this frequency range without mark in the table above means the reading of emissions are attenuated more than 20dB below the permissible limits or the field strength is too small to be measured.

4.4. 20dB RF Bandwidth Measurement

■ **Limit**

N/A

■ **Test Setup**

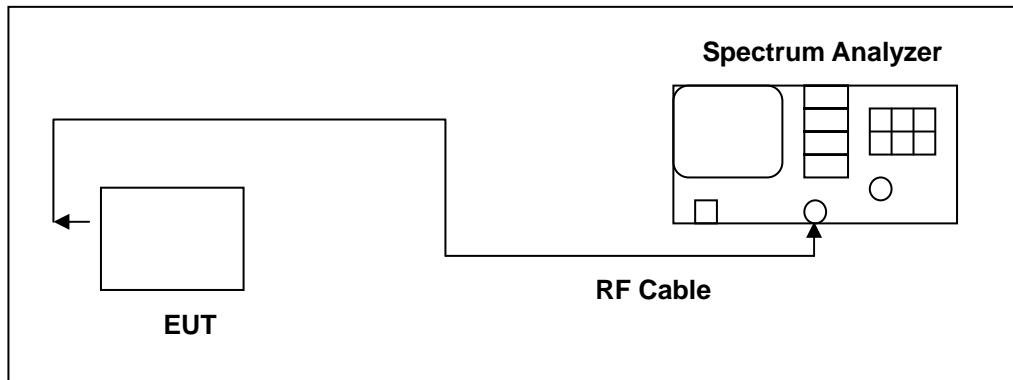

■ **Test Procedure**

Testing must be done according to this procedure, FCC Public Notice DA 00-705 - Filing and Measurement Guidelines for Frequency Hopping Spread Spectrum Systems. This is the only method recognized by the FCC. The RF output port of the Equipment-Under-Test is directly coupled to the input of the EMC analyzer through a specialized RF connector and a 10dB passive attenuator. A fully charged battery was used for the supply voltage. The Bluetooth frequency hopping function of the EUT was enabled. The spectrum analyzer used the following settings:

1. Span = approx. 2 to 3 times the 20dB bandwidth, centered on a hopping frequency
2. RBW \geq 1% of the 20dB span
3. VBW \geq RBW
4. Sweep = auto
5. Detector function = peak
6. Trace = max hold

The trace was allowed to stabilize. The EUT was transmitting at its maximum data rate. The marker-to-peak function was used to set the marker to the peak of the emission. The marker-delta function was used to measure 20dB down one side of the emission. The marker-delta function and marker was moved to the other side of the emission until it was even with the reference marker. The marker-delta reading at this point was the 20dB bandwidth of the emission.

4.5. Carrier Frequency Separation Measurement

■ Limit

Title 47 of the CFR, Part 15 Subpart (c) 15.247(a)(1) requires the measurement of the bandwidth of the transmission between the -20 dB points on the transmitted spectrum. The results of this test determine the limits for channel spacing. The channel spacing shall be a minimum of 25 kHz or the 20 dB bandwidth, whichever is greater. Alternatively, frequency hopping systems operating in the 2400-2483.5 MHz band may have hopping channel carrier frequencies that are separated by 25 kHz or two-thirds of the 20 dB bandwidth of the hopping channel.

■ Test Setup

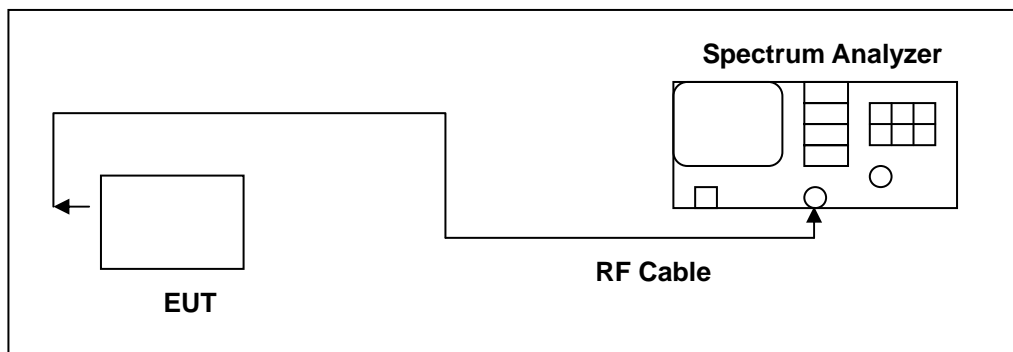

■ Test Procedure

Testing must be done according to this procedure, FCC Public Notice DA 00-705 - Filing and Measurement Guidelines for Frequency Hopping Spread Spectrum Systems. This is the only method recognized by the FCC. The RF output port of the Equipment-Under-Test is directly coupled to the input of the EMC analyzer through a specialized RF connector and a 10dB passive attenuator. A fully charged battery was used for the supply voltage. The Bluetooth frequency hopping function of the EUT was enabled. The following spectrum analyzer settings were used:

1. Span = wide enough to capture the peaks of two adjacent channels
2. Resolution (or IF) Bandwidth (RBW) \geq 1% of the span
3. Video (or Average) Bandwidth (VBW) \geq RBW
4. Sweep = auto
5. Detector function = peak
6. Trace = max hold

The trace was allowed to stabilize. The marker-delta function was used to determine the separation between the peaks of the adjacent channels.

4.6. Number of Hopping Measurement

■ Limit

Frequency hopping systems in the 2400–2483.5 MHz band shall use at least 15 channels.

■ Test Setup

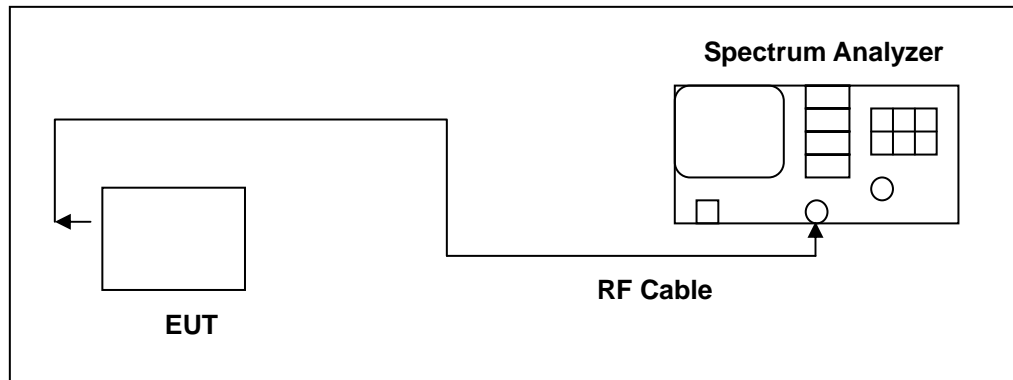

■ Test Procedure

Testing must be done according to this procedure, FCC Public Notice DA 00-705 - Filing and Measurement Guidelines for Frequency Hopping Spread Spectrum Systems. This is the only method recognized by the FCC. The RF output port of the Equipment-Under-Test is directly coupled to the input of the EMC analyzer through a specialized RF connector and a 10dB passive attenuator. A fully charged battery was used for the supply voltage. The Bluetooth frequency hopping function of the EUT was enabled. The spectrum analyzer used the following settings:

1. Span = the frequency band of operation
2. RBW \geq 1% of the span
3. VBW \geq RBW
4. Sweep = auto
5. Detector function = peak
6. Trace = max hold

The trace was allowed to stabilize.

4.7. Time of Occupancy (Dwell Time) Measurement

■ Limit

The average time of occupancy on any channel shall not be greater than 0.4 seconds within a period of 0.4 seconds multiplied by the number of hopping channels employed.

■ Test Setup

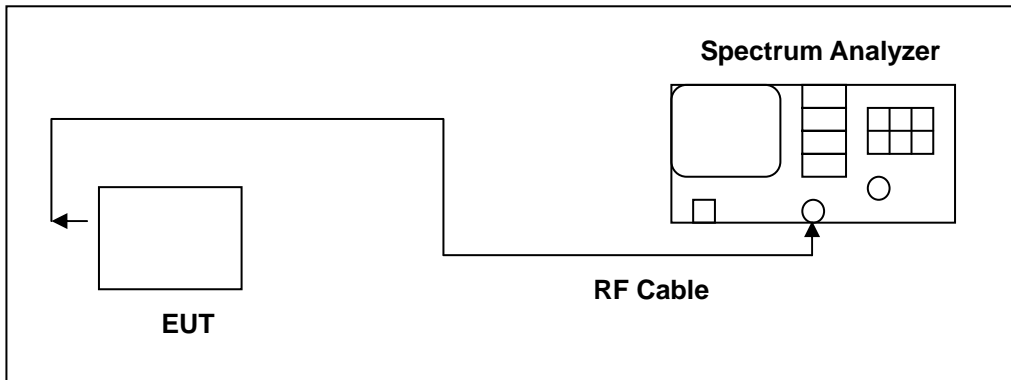

■ Test Procedure

Testing must be done according to this procedure, FCC Public Notice DA 00-705 - Filing and Measurement Guidelines for Frequency Hopping Spread Spectrum Systems. This is the only method recognized by the FCC. The RF output port of the Equipment-Under-Test is directly coupled to the input of the spectrum through a specialized RF connector and a 10dB passive attenuator. A fully charged battery was used for the supply voltage. The Bluetooth hopping function of the EUT was enabled. The following spectrum analyzer settings were used:

1. Span = zero span, centered on a hopping channel
2. RBW = 1 MHz
3. VBW \geq RBW
4. Sweep = as necessary to capture the entire dwell time per hopping channel
5. Detector function = peak
6. Trace = max hold

The marker-delta function was used to determine the dwell time.

4.8. Out of Band Conducted Emissions Measurement

■ Limit

In any 100 kHz bandwidth outside the frequency band in which the spread spectrum or digitally modulated intentional radiator is operating, the radio frequency power that is produced by the intentional radiator shall be at least 20 dB below that in the 100 kHz bandwidth within the band that contains the highest level of the desired power

■ Test Setup

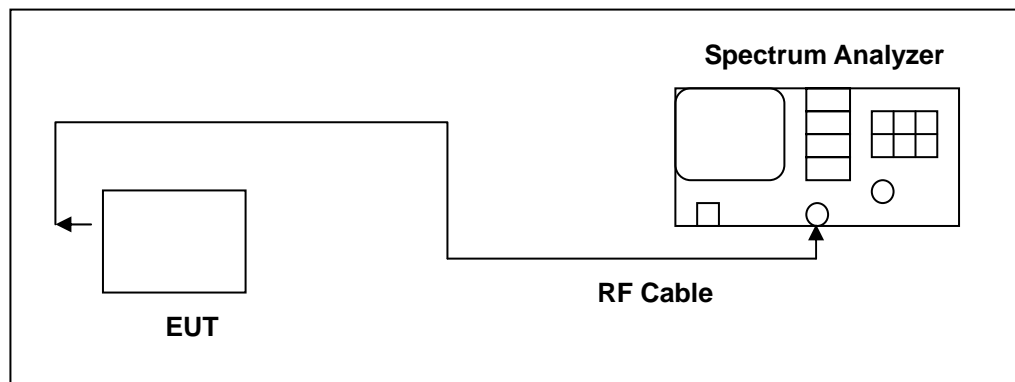

■ Test Procedure

Testing must be done according to this procedure, FCC Public Notice DA 00-705 - Filing and Measurement Guidelines for Frequency Hopping Spread Spectrum Systems. This is the only method recognized by the FCC. In any 100 kHz bandwidth outside the EUT pass band, the RF power produced by the modulation products of the spreading sequence, the information sequence, and the carrier frequency shall be at least 20 dB below that of the maximum in-band 100 kHz emission, antenna output of the EUT was coupled directly to spectrum analyzer; if an external attenuator and/or cable was used, these losses are compensated for with the analyzer OFFSET function. All other types of emissions from the EUT shall meet the general limits for radiated frequencies outside the pass band. The test was performed at 3 channels (Channel 0, 39, 78)

4.9. Antenna Measurement

■ Limit

For intentional device, according to 15.203, an intentional radiator shall be designed to ensure that no antenna other than that furnished by the responsible party shall be used with the device.

And According to 15.247 (b)(4), if transmitting antennas of directional gain greater than 6 dBi are used, the power shall be reduced by the amount in dB that the directional gain of the antenna exceeds 6dBi.

■ Antenna Connector Construction

See section 2 – antenna information.

5 Test Results

Annex A. Conducted Emission

Standard:	FCC Part 15.247	Line:	L1
Test item:	Conducted Emission	Power:	AC 120 V/60 Hz
Test Mode:	Mode 1	Temp.(°C)/Hum.(%RH):	26(°C)/60 %RH
Description:			

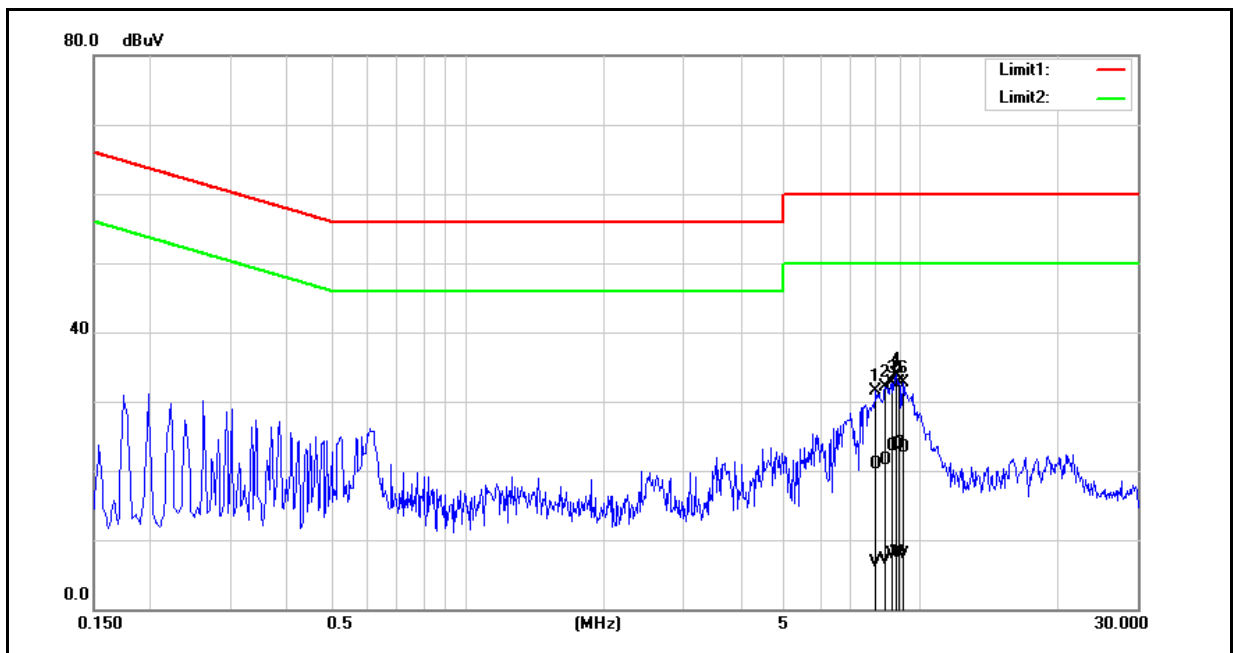

No.	Frequency (MHz)	QP reading (dBuV)	AVG reading (dBuV)	Correction factor (dB)	QP result (dBuV)	AVG result (dBuV)	QP limit (dBuV)	AVG limit (dBuV)	QP margin (dB)	AVG margin (dB)	Remark
1	7.9740	10.88	-3.34	10.01	20.89	6.67	60.00	50.00	-39.11	-43.33	Pass
2	8.3300	11.43	-2.91	10.02	21.45	7.11	60.00	50.00	-38.55	-42.89	Pass
3	8.6300	13.37	-2.20	10.04	23.41	7.84	60.00	50.00	-36.59	-42.16	Pass
4	8.8340	13.60	-2.04	10.05	23.65	8.01	60.00	50.00	-36.35	-41.99	Pass
5	8.9420	13.79	-2.01	10.05	23.84	8.04	60.00	50.00	-36.16	-41.96	Pass
6	9.1220	13.28	-2.20	10.05	23.33	7.85	60.00	50.00	-36.67	-42.15	Pass

Note: 1. Result (dBuV/m) = Correct Factor (dB/m) + Reading(dBuV).

2. Correction factor (dB) = Cable loss (dB) + L.I.S.N. factor (dB).



Standard:	FCC Part 15.247	Line:	N
Test item:	Conducted Emission	Power:	AC 120 V/60 Hz
Test Mode:	Mode 1	Temp.(°C)/Hum.(%RH):	26(°C)/60 %RH
Description:			

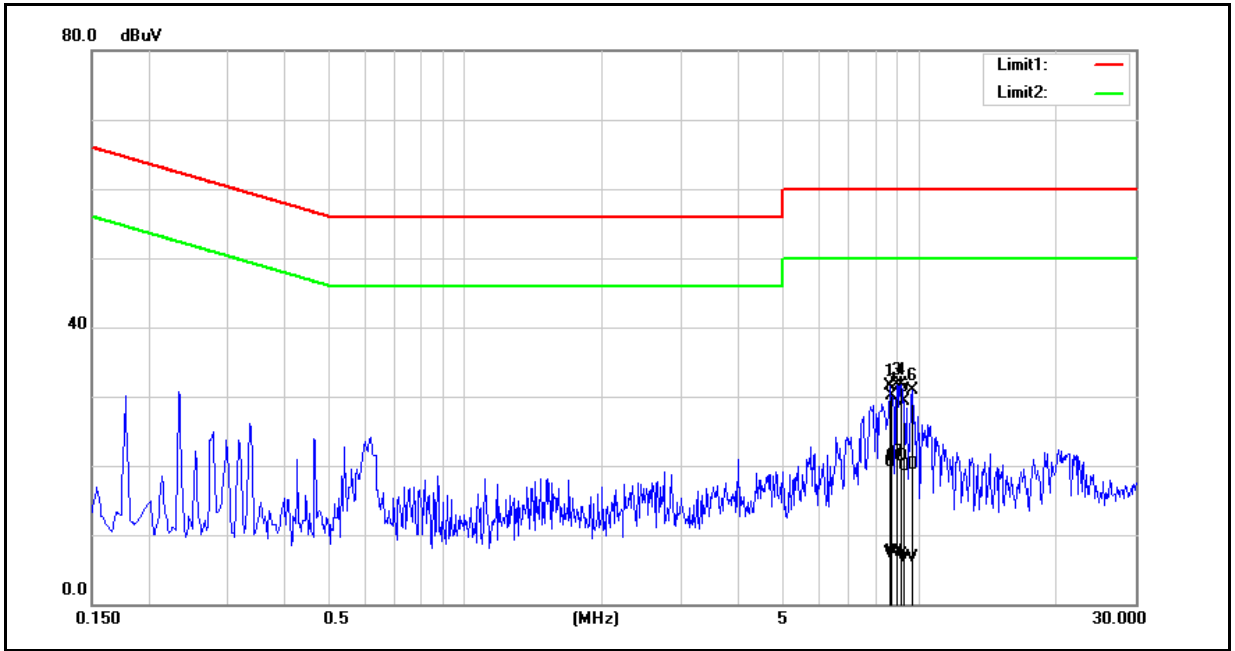

No.	Frequency (MHz)	QP reading (dBuV)	AVG reading (dBuV)	Correction factor (dB)	QP result (dBuV)	AVG result (dBuV)	QP limit (dBuV)	AVG limit (dBuV)	QP margin (dB)	AVG margin (dB)	Remark
1	8.5980	10.39	-2.82	10.11	20.50	7.29	60.00	50.00	-39.50	-42.71	Pass
2	8.7020	11.22	-2.64	10.11	21.33	7.47	60.00	50.00	-38.67	-42.53	Pass
3	8.9260	11.82	-2.61	10.12	21.94	7.51	60.00	50.00	-38.06	-42.49	Pass
4	9.1180	11.14	-3.00	10.12	21.26	7.12	60.00	50.00	-38.74	-42.88	Pass
5	9.3020	9.82	-3.36	10.13	19.95	6.77	60.00	50.00	-40.05	-43.23	Pass
6	9.6580	9.86	-3.38	10.15	20.01	6.77	60.00	50.00	-39.99	-43.23	Pass

Note: 1. Result (dBuV/m) = Correct Factor (dB/m) + Reading(dBuV).

2. Correction factor (dB) = Cable loss (dB) + L.I.S.N. factor (dB).

Annex B. Conducted Test Results

Maximum Conducted Output Power Measurement

Test Mode	Frequency (MHz)	Packet Type	Average Power		Peak Power		Limit (W)
			(dBm)	(W)	(dBm)	(W)	
Mode 2	2402	DH1	3.93	0.00247	5.02	0.00318	< 0.125
		DH3	3.96	0.00249	5.05	0.00320	< 0.125
		DH5	3.99	0.00251	5.08	0.00322	< 0.125
	2441	DH1	3.62	0.00230	4.72	0.00296	< 0.125
		DH3	3.65	0.00232	4.75	0.00299	< 0.125
		DH5	3.68	0.00233	4.78	0.00301	< 0.125
	2480	DH1	3.33	0.00215	4.38	0.00274	< 0.125
		DH3	3.36	0.00217	4.41	0.00276	< 0.125
		DH5	3.39	0.00218	4.44	0.00278	< 0.125
Mode 3	2402	2DH1	4.71	0.00296	7.32	0.00540	< 0.125
		2DH3	4.74	0.00298	7.35	0.00543	< 0.125
		2DH5	4.77	0.00300	7.38	0.00547	< 0.125
	2441	2DH1	4.46	0.00279	7.01	0.00502	< 0.125
		2DH3	4.49	0.00281	7.04	0.00506	< 0.125
		2DH5	4.52	0.00283	7.07	0.00509	< 0.125
	2480	2DH1	4.19	0.00262	6.77	0.00475	< 0.125
		2DH3	4.22	0.00264	6.80	0.00479	< 0.125
		2DH5	4.25	0.00266	6.83	0.00482	< 0.125
Mode 4	2402	3DH1	4.74	0.00298	7.33	0.00541	< 0.125
		3DH3	4.77	0.00300	7.36	0.00545	< 0.125
		3DH5	4.80	0.00302	7.39	0.00548	< 0.125
	2441	3DH1	4.47	0.00280	7.04	0.00506	< 0.125
		3DH3	4.50	0.00282	7.07	0.00509	< 0.125
		3DH5	4.53	0.00284	7.10	0.00513	< 0.125
	2480	3DH1	4.22	0.00264	6.80	0.00479	< 0.125
		3DH3	4.25	0.00266	6.83	0.00482	< 0.125
		3DH5	4.28	0.00268	6.86	0.00485	< 0.125

Note: The relevant measured result has the offset with cable loss already.



20dB RF Bandwidth Measurement

Test Mode	Frequency (MHz)	Measurement Results (MHz)
Mode 2	2402	0.958
	2441	0.955
	2480	0.955
Mode 4	2402	1.304
	2441	1.306
	2480	1.288



■ Test Graphs

Mode 2: GFSK Continuous TX mode													
2402 MHz	<p>Center Freq: 2.40200000 GHz #Res BW: 30 kHz #VBW: 100 kHz Span: 3 MHz Sweep: 3.2 ms</p> <table border="1"> <tr> <td>Occupied Bandwidth</td> <td>893.68 kHz</td> <td>Total Power</td> <td>11.1 dBm</td> </tr> <tr> <td>Transmit Freq Error</td> <td>1.316 kHz</td> <td>% of OBW Power</td> <td>99.00 %</td> </tr> <tr> <td>x dB Bandwidth</td> <td>957.9 kHz</td> <td>x dB</td> <td>-20.00 dB</td> </tr> </table>	Occupied Bandwidth	893.68 kHz	Total Power	11.1 dBm	Transmit Freq Error	1.316 kHz	% of OBW Power	99.00 %	x dB Bandwidth	957.9 kHz	x dB	-20.00 dB
Occupied Bandwidth	893.68 kHz	Total Power	11.1 dBm										
Transmit Freq Error	1.316 kHz	% of OBW Power	99.00 %										
x dB Bandwidth	957.9 kHz	x dB	-20.00 dB										
2441 MHz	<p>Center Freq: 2.441000000 GHz #Res BW: 30 kHz #VBW: 100 kHz Span: 3 MHz Sweep: 3.2 ms</p> <table border="1"> <tr> <td>Occupied Bandwidth</td> <td>891.04 kHz</td> <td>Total Power</td> <td>10.8 dBm</td> </tr> <tr> <td>Transmit Freq Error</td> <td>1.268 kHz</td> <td>% of OBW Power</td> <td>99.00 %</td> </tr> <tr> <td>x dB Bandwidth</td> <td>954.8 kHz</td> <td>x dB</td> <td>-20.00 dB</td> </tr> </table>	Occupied Bandwidth	891.04 kHz	Total Power	10.8 dBm	Transmit Freq Error	1.268 kHz	% of OBW Power	99.00 %	x dB Bandwidth	954.8 kHz	x dB	-20.00 dB
Occupied Bandwidth	891.04 kHz	Total Power	10.8 dBm										
Transmit Freq Error	1.268 kHz	% of OBW Power	99.00 %										
x dB Bandwidth	954.8 kHz	x dB	-20.00 dB										
2480 MHz	<p>Center Freq: 2.480000000 GHz #Res BW: 30 kHz #VBW: 100 kHz Span: 3 MHz Sweep: 3.2 ms</p> <table border="1"> <tr> <td>Occupied Bandwidth</td> <td>891.90 kHz</td> <td>Total Power</td> <td>10.4 dBm</td> </tr> <tr> <td>Transmit Freq Error</td> <td>906 Hz</td> <td>% of OBW Power</td> <td>99.00 %</td> </tr> <tr> <td>x dB Bandwidth</td> <td>954.6 kHz</td> <td>x dB</td> <td>-20.00 dB</td> </tr> </table>	Occupied Bandwidth	891.90 kHz	Total Power	10.4 dBm	Transmit Freq Error	906 Hz	% of OBW Power	99.00 %	x dB Bandwidth	954.6 kHz	x dB	-20.00 dB
Occupied Bandwidth	891.90 kHz	Total Power	10.4 dBm										
Transmit Freq Error	906 Hz	% of OBW Power	99.00 %										
x dB Bandwidth	954.6 kHz	x dB	-20.00 dB										



Mode 4: 8DPSK Continuous TX mode													
<p>2402 MHz</p>	<p>Center Freq: 2.40200000 GHz #Res BW: 30 kHz #VBW: 100 kHz Span: 3 MHz Sweep: 3.2 ms</p> <table border="1"> <tr> <td>Occupied Bandwidth</td> <td>1.1941 MHz</td> <td>Total Power</td> <td>12.9 dBm</td> </tr> <tr> <td>Transmit Freq Error</td> <td>18 Hz</td> <td>% of OBW Power</td> <td>99.00 %</td> </tr> <tr> <td>x dB Bandwidth</td> <td>1.304 MHz</td> <td>x dB</td> <td>-20.00 dB</td> </tr> </table>	Occupied Bandwidth	1.1941 MHz	Total Power	12.9 dBm	Transmit Freq Error	18 Hz	% of OBW Power	99.00 %	x dB Bandwidth	1.304 MHz	x dB	-20.00 dB
Occupied Bandwidth	1.1941 MHz	Total Power	12.9 dBm										
Transmit Freq Error	18 Hz	% of OBW Power	99.00 %										
x dB Bandwidth	1.304 MHz	x dB	-20.00 dB										
<p>2441 MHz</p>	<p>Center Freq: 2.441000000 GHz #Res BW: 30 kHz #VBW: 100 kHz Span: 3 MHz Sweep: 3.2 ms</p> <table border="1"> <tr> <td>Occupied Bandwidth</td> <td>1.2030 MHz</td> <td>Total Power</td> <td>12.2 dBm</td> </tr> <tr> <td>Transmit Freq Error</td> <td>-1.595 kHz</td> <td>% of OBW Power</td> <td>99.00 %</td> </tr> <tr> <td>x dB Bandwidth</td> <td>1.306 MHz</td> <td>x dB</td> <td>-20.00 dB</td> </tr> </table>	Occupied Bandwidth	1.2030 MHz	Total Power	12.2 dBm	Transmit Freq Error	-1.595 kHz	% of OBW Power	99.00 %	x dB Bandwidth	1.306 MHz	x dB	-20.00 dB
Occupied Bandwidth	1.2030 MHz	Total Power	12.2 dBm										
Transmit Freq Error	-1.595 kHz	% of OBW Power	99.00 %										
x dB Bandwidth	1.306 MHz	x dB	-20.00 dB										
<p>2480 MHz</p>	<p>Center Freq: 2.480000000 GHz #Res BW: 30 kHz #VBW: 100 kHz Span: 3 MHz Sweep: 3.2 ms</p> <table border="1"> <tr> <td>Occupied Bandwidth</td> <td>1.1841 MHz</td> <td>Total Power</td> <td>12.5 dBm</td> </tr> <tr> <td>Transmit Freq Error</td> <td>1.646 kHz</td> <td>% of OBW Power</td> <td>99.00 %</td> </tr> <tr> <td>x dB Bandwidth</td> <td>1.288 MHz</td> <td>x dB</td> <td>-20.00 dB</td> </tr> </table>	Occupied Bandwidth	1.1841 MHz	Total Power	12.5 dBm	Transmit Freq Error	1.646 kHz	% of OBW Power	99.00 %	x dB Bandwidth	1.288 MHz	x dB	-20.00 dB
Occupied Bandwidth	1.1841 MHz	Total Power	12.5 dBm										
Transmit Freq Error	1.646 kHz	% of OBW Power	99.00 %										
x dB Bandwidth	1.288 MHz	x dB	-20.00 dB										



Carrier Frequency Separation Measurement

Test Mode	Frequency (MHz)	Measurement Results (MHz)	Limit (MHz)
Mode 2	2402	1.000	> 0.639
	2441	1.000	> 0.637
	2480	1.000	> 0.636
Mode 4	2402	1.000	> 0.869
	2441	1.000	> 0.871
	2480	1.000	> 0.859



■ Test Graphs

Mode 2: GFSK Continuous TX mode																																					
2402 MHz	<table border="1"> <thead> <tr> <th>MNR</th> <th>MODE</th> <th>TRC</th> <th>SCL</th> <th>X</th> <th>Y</th> <th>FUNCTION</th> <th>FUNCTION WIDTH</th> <th>FUNCTION VALUE</th> </tr> </thead> <tbody> <tr> <td>1</td> <td>N</td> <td>1</td> <td>T</td> <td>2.401 983 GHz</td> <td>2.818 dBm</td> <td></td> <td></td> <td></td> </tr> <tr> <td>2</td> <td>N</td> <td>1</td> <td>f</td> <td>2.402 983 GHz</td> <td>2.994 dBm</td> <td></td> <td></td> <td></td> </tr> <tr> <td>3</td> <td>N</td> <td>1</td> <td>f</td> <td>2.403 983 GHz</td> <td>3.002 dBm</td> <td></td> <td></td> <td></td> </tr> </tbody> </table>	MNR	MODE	TRC	SCL	X	Y	FUNCTION	FUNCTION WIDTH	FUNCTION VALUE	1	N	1	T	2.401 983 GHz	2.818 dBm				2	N	1	f	2.402 983 GHz	2.994 dBm				3	N	1	f	2.403 983 GHz	3.002 dBm			
MNR	MODE	TRC	SCL	X	Y	FUNCTION	FUNCTION WIDTH	FUNCTION VALUE																													
1	N	1	T	2.401 983 GHz	2.818 dBm																																
2	N	1	f	2.402 983 GHz	2.994 dBm																																
3	N	1	f	2.403 983 GHz	3.002 dBm																																
2441 MHz	<table border="1"> <thead> <tr> <th>MNR</th> <th>MODE</th> <th>TRC</th> <th>SCL</th> <th>X</th> <th>Y</th> <th>FUNCTION</th> <th>FUNCTION WIDTH</th> <th>FUNCTION VALUE</th> </tr> </thead> <tbody> <tr> <td>1</td> <td>N</td> <td>1</td> <td>T</td> <td>2.439 983 GHz</td> <td>4.193 dBm</td> <td></td> <td></td> <td></td> </tr> <tr> <td>2</td> <td>N</td> <td>1</td> <td>f</td> <td>2.440 983 GHz</td> <td>3.148 dBm</td> <td></td> <td></td> <td></td> </tr> <tr> <td>3</td> <td>N</td> <td>1</td> <td>f</td> <td>2.441 983 GHz</td> <td>3.416 dBm</td> <td></td> <td></td> <td></td> </tr> </tbody> </table>	MNR	MODE	TRC	SCL	X	Y	FUNCTION	FUNCTION WIDTH	FUNCTION VALUE	1	N	1	T	2.439 983 GHz	4.193 dBm				2	N	1	f	2.440 983 GHz	3.148 dBm				3	N	1	f	2.441 983 GHz	3.416 dBm			
MNR	MODE	TRC	SCL	X	Y	FUNCTION	FUNCTION WIDTH	FUNCTION VALUE																													
1	N	1	T	2.439 983 GHz	4.193 dBm																																
2	N	1	f	2.440 983 GHz	3.148 dBm																																
3	N	1	f	2.441 983 GHz	3.416 dBm																																
2480 MHz	<table border="1"> <thead> <tr> <th>MNR</th> <th>MODE</th> <th>TRC</th> <th>SCL</th> <th>X</th> <th>Y</th> <th>FUNCTION</th> <th>FUNCTION WIDTH</th> <th>FUNCTION VALUE</th> </tr> </thead> <tbody> <tr> <td>1</td> <td>N</td> <td>1</td> <td>T</td> <td>2.477 983 GHz</td> <td>3.589 dBm</td> <td></td> <td></td> <td></td> </tr> <tr> <td>2</td> <td>N</td> <td>1</td> <td>f</td> <td>2.478 983 GHz</td> <td>3.100 dBm</td> <td></td> <td></td> <td></td> </tr> <tr> <td>3</td> <td>N</td> <td>1</td> <td>f</td> <td>2.479 983 GHz</td> <td>3.303 dBm</td> <td></td> <td></td> <td></td> </tr> </tbody> </table>	MNR	MODE	TRC	SCL	X	Y	FUNCTION	FUNCTION WIDTH	FUNCTION VALUE	1	N	1	T	2.477 983 GHz	3.589 dBm				2	N	1	f	2.478 983 GHz	3.100 dBm				3	N	1	f	2.479 983 GHz	3.303 dBm			
MNR	MODE	TRC	SCL	X	Y	FUNCTION	FUNCTION WIDTH	FUNCTION VALUE																													
1	N	1	T	2.477 983 GHz	3.589 dBm																																
2	N	1	f	2.478 983 GHz	3.100 dBm																																
3	N	1	f	2.479 983 GHz	3.303 dBm																																

Mode 4: 8DPSK Continuous TX mode																																					
2402 MHz	<table border="1"> <thead> <tr> <th>MNR</th> <th>MODE</th> <th>TRG</th> <th>SCL</th> <th>X</th> <th>Y</th> <th>FUNCTION</th> <th>FUNCTION WIDTH</th> <th>FUNCTION VALUE</th> </tr> </thead> <tbody> <tr> <td>1</td> <td>N</td> <td>1</td> <td>f</td> <td>2.402 013 GHz</td> <td>2.289 dBm</td> <td></td> <td></td> <td></td> </tr> <tr> <td>2</td> <td>N</td> <td>1</td> <td>f</td> <td>2.403 013 GHz</td> <td>2.231 dBm</td> <td></td> <td></td> <td></td> </tr> <tr> <td>3</td> <td>N</td> <td>1</td> <td>f</td> <td>2.404 013 GHz</td> <td>2.104 dBm</td> <td></td> <td></td> <td></td> </tr> </tbody> </table>	MNR	MODE	TRG	SCL	X	Y	FUNCTION	FUNCTION WIDTH	FUNCTION VALUE	1	N	1	f	2.402 013 GHz	2.289 dBm				2	N	1	f	2.403 013 GHz	2.231 dBm				3	N	1	f	2.404 013 GHz	2.104 dBm			
MNR	MODE	TRG	SCL	X	Y	FUNCTION	FUNCTION WIDTH	FUNCTION VALUE																													
1	N	1	f	2.402 013 GHz	2.289 dBm																																
2	N	1	f	2.403 013 GHz	2.231 dBm																																
3	N	1	f	2.404 013 GHz	2.104 dBm																																
2441 MHz	<table border="1"> <thead> <tr> <th>MNR</th> <th>MODE</th> <th>TRG</th> <th>SCL</th> <th>X</th> <th>Y</th> <th>FUNCTION</th> <th>FUNCTION WIDTH</th> <th>FUNCTION VALUE</th> </tr> </thead> <tbody> <tr> <td>1</td> <td>N</td> <td>1</td> <td>f</td> <td>2.440 013 GHz</td> <td>2.085 dBm</td> <td></td> <td></td> <td></td> </tr> <tr> <td>2</td> <td>N</td> <td>1</td> <td>f</td> <td>2.441 013 GHz</td> <td>2.002 dBm</td> <td></td> <td></td> <td></td> </tr> <tr> <td>3</td> <td>N</td> <td>1</td> <td>f</td> <td>2.442 013 GHz</td> <td>2.035 dBm</td> <td></td> <td></td> <td></td> </tr> </tbody> </table>	MNR	MODE	TRG	SCL	X	Y	FUNCTION	FUNCTION WIDTH	FUNCTION VALUE	1	N	1	f	2.440 013 GHz	2.085 dBm				2	N	1	f	2.441 013 GHz	2.002 dBm				3	N	1	f	2.442 013 GHz	2.035 dBm			
MNR	MODE	TRG	SCL	X	Y	FUNCTION	FUNCTION WIDTH	FUNCTION VALUE																													
1	N	1	f	2.440 013 GHz	2.085 dBm																																
2	N	1	f	2.441 013 GHz	2.002 dBm																																
3	N	1	f	2.442 013 GHz	2.035 dBm																																
2480 MHz	<table border="1"> <thead> <tr> <th>MNR</th> <th>MODE</th> <th>TRG</th> <th>SCL</th> <th>X</th> <th>Y</th> <th>FUNCTION</th> <th>FUNCTION WIDTH</th> <th>FUNCTION VALUE</th> </tr> </thead> <tbody> <tr> <td>1</td> <td>N</td> <td>1</td> <td>f</td> <td>2.478 013 GHz</td> <td>1.831 dBm</td> <td></td> <td></td> <td></td> </tr> <tr> <td>2</td> <td>N</td> <td>1</td> <td>f</td> <td>2.479 013 GHz</td> <td>1.044 dBm</td> <td></td> <td></td> <td></td> </tr> <tr> <td>3</td> <td>N</td> <td>1</td> <td>f</td> <td>2.480 013 GHz</td> <td>1.479 dBm</td> <td></td> <td></td> <td></td> </tr> </tbody> </table>	MNR	MODE	TRG	SCL	X	Y	FUNCTION	FUNCTION WIDTH	FUNCTION VALUE	1	N	1	f	2.478 013 GHz	1.831 dBm				2	N	1	f	2.479 013 GHz	1.044 dBm				3	N	1	f	2.480 013 GHz	1.479 dBm			
MNR	MODE	TRG	SCL	X	Y	FUNCTION	FUNCTION WIDTH	FUNCTION VALUE																													
1	N	1	f	2.478 013 GHz	1.831 dBm																																
2	N	1	f	2.479 013 GHz	1.044 dBm																																
3	N	1	f	2.480 013 GHz	1.479 dBm																																



Number of Hopping Measurement

Test Mode	Frequency Range (MHz)	Measurement Results (Ch)	Limit (ch)
Mode 2	2402 - 2480	79	> 15
Mode 3	2402 - 2480	79	> 15
Mode 4	2402 - 2480	79	> 15



■ Test Graphs

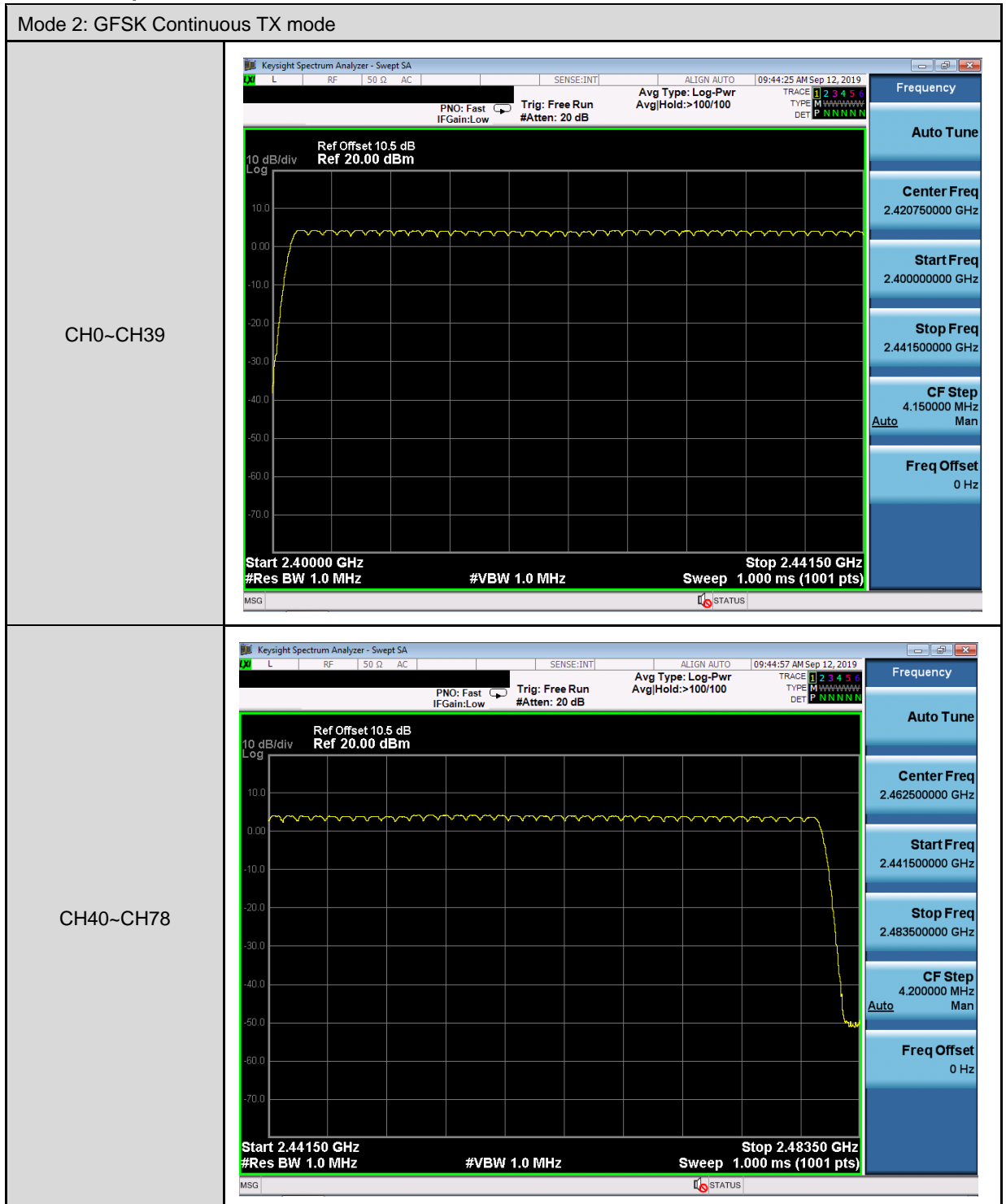

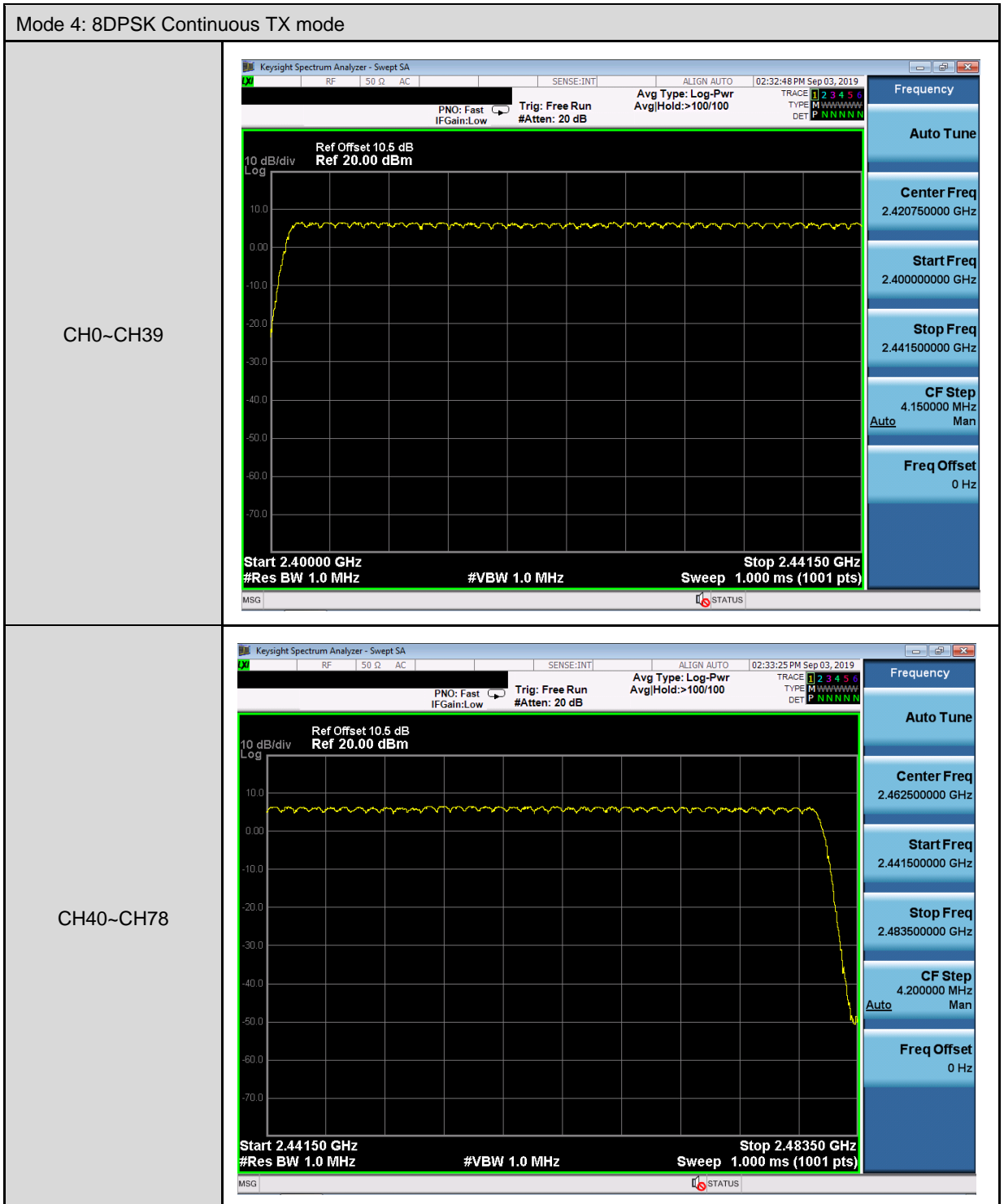



Time of Occupancy (Dwell Time) Measurement

Mode 2: GFSK Continuous TX mode	
DH1	
Cycle Calculate	$79CH * 0.4 = 31.6 \text{ (sec)}$
The EUT Hopping Number per Sec	1600 times/sec
Each Channel Dwell Times per Sec	$800/79CH = 10.13(\text{times/sec})$
Each Channel Dwell Times on Cycle(1)	$31.6 * 10.13 = 320.108(\text{times})$
Each Channel Dwell Times (2)	0.420 ms (sec)
Dwell Times on Cycle (1) * (2)	134.445 ms (sec)
LIMIT(msec)	$< = 400$
DH3	
Cycle Calculate	$79CH * 0.4 = 31.6 \text{ (sec)}$
The EUT Hopping Number per Sec	1600 times/sec
Each Channel Dwell Times per Sec	$400/79CH = 5.1(\text{times/sec})$
Each Channel Dwell Times on Cycle(1)	$31.6 * 5.1 = 161.16(\text{times})$
Each Channel Dwell Times (2)	1.670 ms (sec)
Dwell Times on Cycle (1) * (2)	267.026 ms (sec)
LIMIT(msec)	$< = 400$
DH5	
Cycle Calculate	$79CH * 0.4 = 31.6 \text{ (sec)}$
The EUT Hopping Number per Sec	1600 times/sec
Each Channel Dwell Times per Sec	$266.7/79CH = 3.37(\text{times/sec})$
Each Channel Dwell Times on Cycle(1)	$31.6 * 3.37 = 106.492(\text{times})$
Each Channel Dwell Times (2)	2.920 ms (sec)
Dwell Times on Cycle (1) * (2)	311.879 ms (sec)
LIMIT(msec)	$< = 400$



Mode 4: 8DPSK Continuous TX mode	
3DH1	
Cycle Calculate	$79CH * 0.4 = 31.6 \text{ (sec)}$
The EUT Hopping Number per Sec	1600 times/sec
Each Channel Dwell Times per Sec	$800/79CH = 10.13 \text{ (times/sec)}$
Each Channel Dwell Times on Cycle(1)	$31.6 * 10.13 = 320.108 \text{ (times)}$
Each Channel Dwell Times (2)	0.420 ms (sec)
Dwell Times on Cycle (1) * (2)	134.445 ms (sec)
LIMIT(msec)	$< = 400$
3DH3	
Cycle Calculate	$79CH * 0.4 = 31.6 \text{ (sec)}$
The EUT Hopping Number per Sec	1600 times/sec
Each Channel Dwell Times per Sec	$400/79CH = 5.1 \text{ (times/sec)}$
Each Channel Dwell Times on Cycle(1)	$31.6 * 5.1 = 161.16 \text{ (times)}$
Each Channel Dwell Times (2)	1.670 ms (sec)
Dwell Times on Cycle (1) * (2)	267.026 ms (sec)
LIMIT(msec)	$< = 400$
3DH5	
Cycle Calculate	$79CH * 0.4 = 31.6 \text{ (sec)}$
The EUT Hopping Number per Sec	1600 times/sec
Each Channel Dwell Times per Sec	$266.7/79CH = 3.37 \text{ (times/sec)}$
Each Channel Dwell Times on Cycle(1)	$31.6 * 3.37 = 106.492 \text{ (times)}$
Each Channel Dwell Times (2)	2.920 ms (sec)
Dwell Times on Cycle (1) * (2)	311.879 ms (sec)
LIMIT(msec)	$< = 400$

■ Test Graphs

Mode 2: GFSK Continuous TX mode	
DH1	<p>Key parameters from screenshot: ΔMkr1 420.0 μs -0.61 dB Center 2.402000000 GHz Res BW 1.0 MHz Sweep 10.00 ms (1001 pts)</p>
DH3	<p>Key parameters from screenshot: ΔMkr1 1.670 ms 0.49 dB Center 2.402000000 GHz Res BW 1.0 MHz Sweep 10.00 ms (1001 pts)</p>
DH5	<p>Key parameters from screenshot: ΔMkr1 2.920 ms 0.63 dB Center 2.402000000 GHz Res BW 1.0 MHz Sweep 10.00 ms (1001 pts)</p>

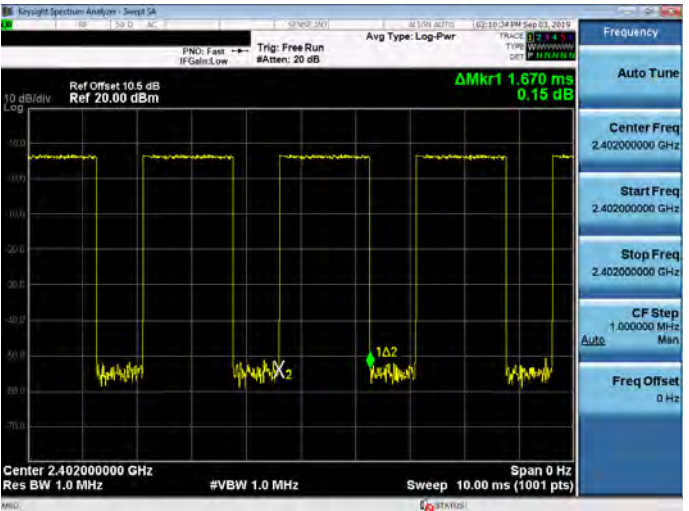
Mode 4: 8DPSK Continuous TX mode	
3DH1	 <p>Key parameters from the screenshot:</p> <ul style="list-style-type: none"> Center Freq: 2.402000000 GHz Start Freq: 2.402000000 GHz Stop Freq: 2.402000000 GHz CF Step: 1.000000 MHz Freq Offset: 0 Hz Center Freq: 2.402000000 GHz Res BW: 1.0 MHz #VBW: 1.0 MHz Sweep: 10.00 ms (1001 pts) ΔMkr1: 420.0 μs 0.43 dB
3DH3	 <p>Key parameters from the screenshot:</p> <ul style="list-style-type: none"> Center Freq: 2.402000000 GHz Start Freq: 2.402000000 GHz Stop Freq: 2.402000000 GHz CF Step: 1.000000 MHz Freq Offset: 0 Hz Center Freq: 2.402000000 GHz Res BW: 1.0 MHz #VBW: 1.0 MHz Sweep: 10.00 ms (1001 pts) ΔMkr1: 1.670 ms 0.15 dB
3DH5	 <p>Key parameters from the screenshot:</p> <ul style="list-style-type: none"> Center Freq: 2.402000000 GHz Start Freq: 2.402000000 GHz Stop Freq: 2.402000000 GHz CF Step: 1.000000 MHz Freq Offset: 0 Hz Center Freq: 2.402000000 GHz Res BW: 1.0 MHz #VBW: 1.0 MHz Sweep: 10.00 ms (1001 pts) ΔMkr1: 2.920 ms 1.34 dB

Out of Band Conducted Emissions Measurement

■ Test Graphs

Mode 2: GFSK Continuous TX mode																												
2402 MHz	<table border="1"> <thead> <tr> <th>MNR</th> <th>MODE</th> <th>TRC</th> <th>SCL</th> <th>X</th> <th>Y</th> <th>FUNCTION</th> <th>FUNCTION WIDTH</th> <th>FUNCTION VALUE</th> </tr> </thead> <tbody> <tr> <td>1</td> <td>N</td> <td>1</td> <td>f</td> <td>2402.4 GHz</td> <td>3.679 dBm</td> <td></td> <td></td> <td></td> </tr> <tr> <td>2</td> <td>N</td> <td>1</td> <td>f</td> <td>26.3673 GHz</td> <td>-43.739 dBm</td> <td></td> <td></td> <td></td> </tr> </tbody> </table>	MNR	MODE	TRC	SCL	X	Y	FUNCTION	FUNCTION WIDTH	FUNCTION VALUE	1	N	1	f	2402.4 GHz	3.679 dBm				2	N	1	f	26.3673 GHz	-43.739 dBm			
MNR	MODE	TRC	SCL	X	Y	FUNCTION	FUNCTION WIDTH	FUNCTION VALUE																				
1	N	1	f	2402.4 GHz	3.679 dBm																							
2	N	1	f	26.3673 GHz	-43.739 dBm																							
2441 MHz	<table border="1"> <thead> <tr> <th>MNR</th> <th>MODE</th> <th>TRC</th> <th>SCL</th> <th>X</th> <th>Y</th> <th>FUNCTION</th> <th>FUNCTION WIDTH</th> <th>FUNCTION VALUE</th> </tr> </thead> <tbody> <tr> <td>1</td> <td>N</td> <td>1</td> <td>f</td> <td>2441.4 GHz</td> <td>3.332 dBm</td> <td></td> <td></td> <td></td> </tr> <tr> <td>2</td> <td>N</td> <td>1</td> <td>f</td> <td>25.7324 GHz</td> <td>-43.777 dBm</td> <td></td> <td></td> <td></td> </tr> </tbody> </table>	MNR	MODE	TRC	SCL	X	Y	FUNCTION	FUNCTION WIDTH	FUNCTION VALUE	1	N	1	f	2441.4 GHz	3.332 dBm				2	N	1	f	25.7324 GHz	-43.777 dBm			
MNR	MODE	TRC	SCL	X	Y	FUNCTION	FUNCTION WIDTH	FUNCTION VALUE																				
1	N	1	f	2441.4 GHz	3.332 dBm																							
2	N	1	f	25.7324 GHz	-43.777 dBm																							
2480 MHz	<table border="1"> <thead> <tr> <th>MNR</th> <th>MODE</th> <th>TRC</th> <th>SCL</th> <th>X</th> <th>Y</th> <th>FUNCTION</th> <th>FUNCTION WIDTH</th> <th>FUNCTION VALUE</th> </tr> </thead> <tbody> <tr> <td>1</td> <td>N</td> <td>1</td> <td>f</td> <td>2480.5 GHz</td> <td>2.956 dBm</td> <td></td> <td></td> <td></td> </tr> <tr> <td>2</td> <td>N</td> <td>1</td> <td>f</td> <td>25.7595 GHz</td> <td>-42.801 dBm</td> <td></td> <td></td> <td></td> </tr> </tbody> </table>	MNR	MODE	TRC	SCL	X	Y	FUNCTION	FUNCTION WIDTH	FUNCTION VALUE	1	N	1	f	2480.5 GHz	2.956 dBm				2	N	1	f	25.7595 GHz	-42.801 dBm			
MNR	MODE	TRC	SCL	X	Y	FUNCTION	FUNCTION WIDTH	FUNCTION VALUE																				
1	N	1	f	2480.5 GHz	2.956 dBm																							
2	N	1	f	25.7595 GHz	-42.801 dBm																							



Mode 4: 8DPSK Continuous TX mode																												
2402 MHz	<table border="1"> <thead> <tr> <th>MNR</th> <th>MODE</th> <th>TRG</th> <th>SCN</th> <th>X</th> <th>Y</th> <th>FUNCTION</th> <th>FUNCTION WIDTH</th> <th>FUNCTION VALUE</th> </tr> </thead> <tbody> <tr> <td>1</td> <td>N</td> <td>1</td> <td>f</td> <td>2402.4 GHz</td> <td>5.599 dBm</td> <td></td> <td></td> <td></td> </tr> <tr> <td>2</td> <td>N</td> <td>1</td> <td>f</td> <td>25.7092 GHz</td> <td>-43.387 dBm</td> <td></td> <td></td> <td></td> </tr> </tbody> </table>	MNR	MODE	TRG	SCN	X	Y	FUNCTION	FUNCTION WIDTH	FUNCTION VALUE	1	N	1	f	2402.4 GHz	5.599 dBm				2	N	1	f	25.7092 GHz	-43.387 dBm			
MNR	MODE	TRG	SCN	X	Y	FUNCTION	FUNCTION WIDTH	FUNCTION VALUE																				
1	N	1	f	2402.4 GHz	5.599 dBm																							
2	N	1	f	25.7092 GHz	-43.387 dBm																							
2441 MHz	<table border="1"> <thead> <tr> <th>MNR</th> <th>MODE</th> <th>TRG</th> <th>SCN</th> <th>X</th> <th>Y</th> <th>FUNCTION</th> <th>FUNCTION WIDTH</th> <th>FUNCTION VALUE</th> </tr> </thead> <tbody> <tr> <td>1</td> <td>N</td> <td>1</td> <td>f</td> <td>2441.4 GHz</td> <td>6.171 dBm</td> <td></td> <td></td> <td></td> </tr> <tr> <td>2</td> <td>N</td> <td>1</td> <td>f</td> <td>25.1481 GHz</td> <td>-44.512 dBm</td> <td></td> <td></td> <td></td> </tr> </tbody> </table>	MNR	MODE	TRG	SCN	X	Y	FUNCTION	FUNCTION WIDTH	FUNCTION VALUE	1	N	1	f	2441.4 GHz	6.171 dBm				2	N	1	f	25.1481 GHz	-44.512 dBm			
MNR	MODE	TRG	SCN	X	Y	FUNCTION	FUNCTION WIDTH	FUNCTION VALUE																				
1	N	1	f	2441.4 GHz	6.171 dBm																							
2	N	1	f	25.1481 GHz	-44.512 dBm																							
2480 MHz	<table border="1"> <thead> <tr> <th>MNR</th> <th>MODE</th> <th>TRG</th> <th>SCN</th> <th>X</th> <th>Y</th> <th>FUNCTION</th> <th>FUNCTION WIDTH</th> <th>FUNCTION VALUE</th> </tr> </thead> <tbody> <tr> <td>1</td> <td>N</td> <td>1</td> <td>f</td> <td>2480.5 GHz</td> <td>5.078 dBm</td> <td></td> <td></td> <td></td> </tr> <tr> <td>2</td> <td>N</td> <td>1</td> <td>f</td> <td>25.7337 GHz</td> <td>-44.192 dBm</td> <td></td> <td></td> <td></td> </tr> </tbody> </table>	MNR	MODE	TRG	SCN	X	Y	FUNCTION	FUNCTION WIDTH	FUNCTION VALUE	1	N	1	f	2480.5 GHz	5.078 dBm				2	N	1	f	25.7337 GHz	-44.192 dBm			
MNR	MODE	TRG	SCN	X	Y	FUNCTION	FUNCTION WIDTH	FUNCTION VALUE																				
1	N	1	f	2480.5 GHz	5.078 dBm																							
2	N	1	f	25.7337 GHz	-44.192 dBm																							

Mode 2: GFSK Continuous TX mode _ Un-hopping

2402 MHz

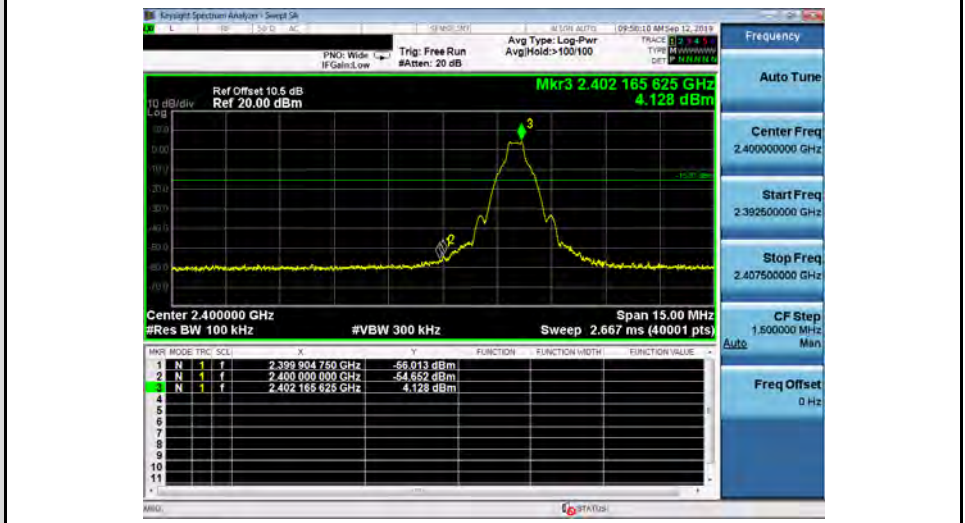

2480 MHz

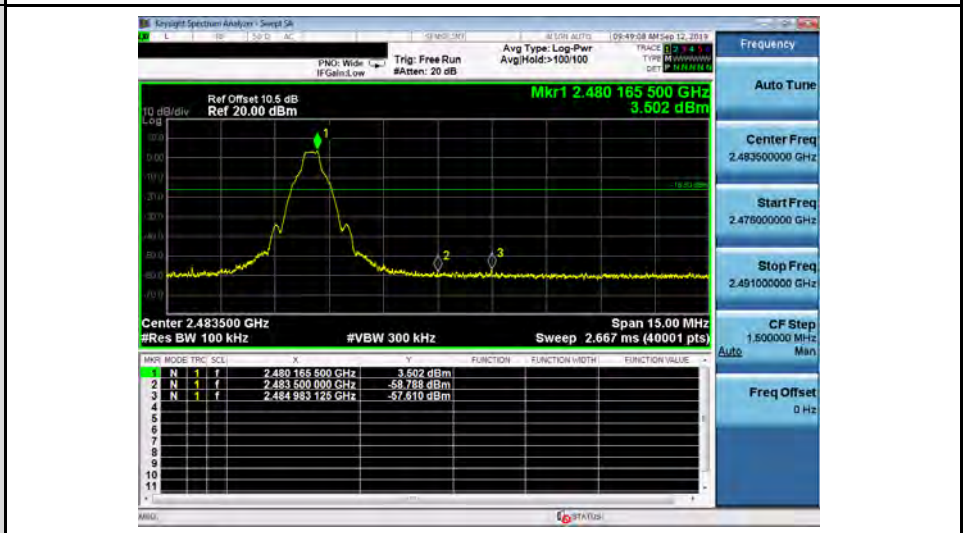

Mode 2: GFSK Continuous TX mode _ Hopping

2402 ~ 2480 MHz

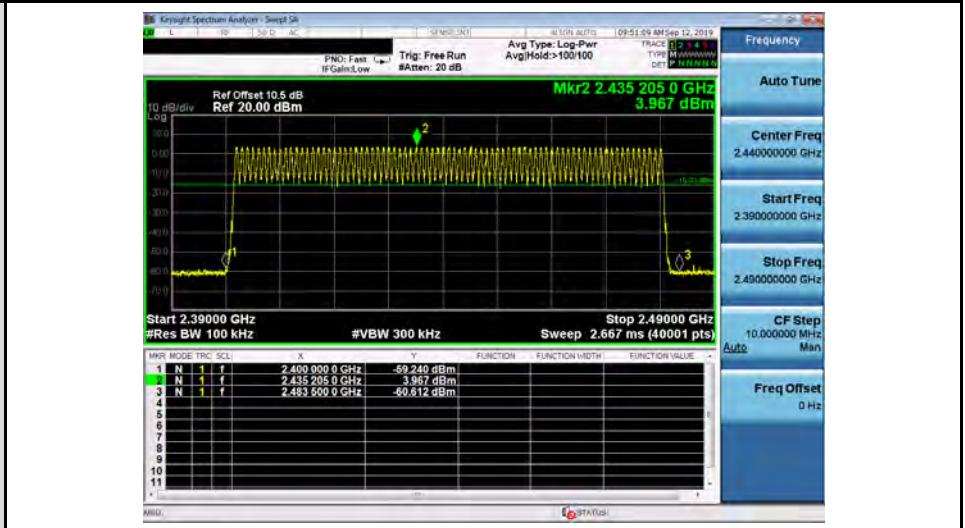

Mode 4: 8DPSK Continuous TX mode _ Un-hopping

2402 MHz

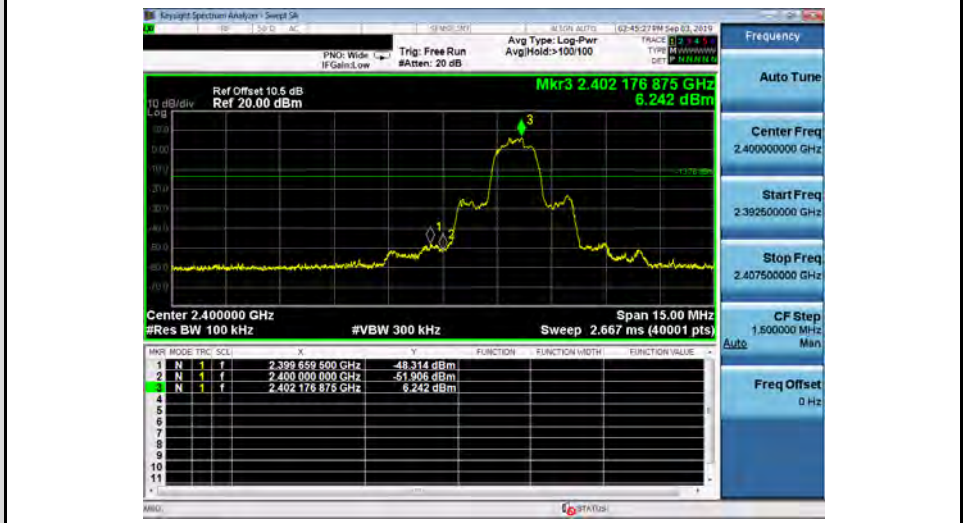

2480 MHz

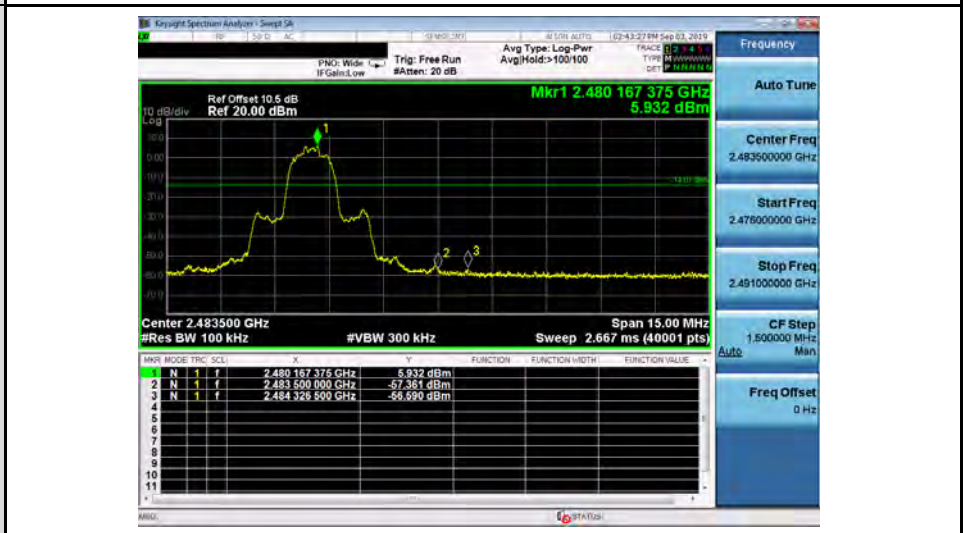

Mode 4: 8DPSK Continuous TX mode _ Hopping

2402 ~ 2480 MHz

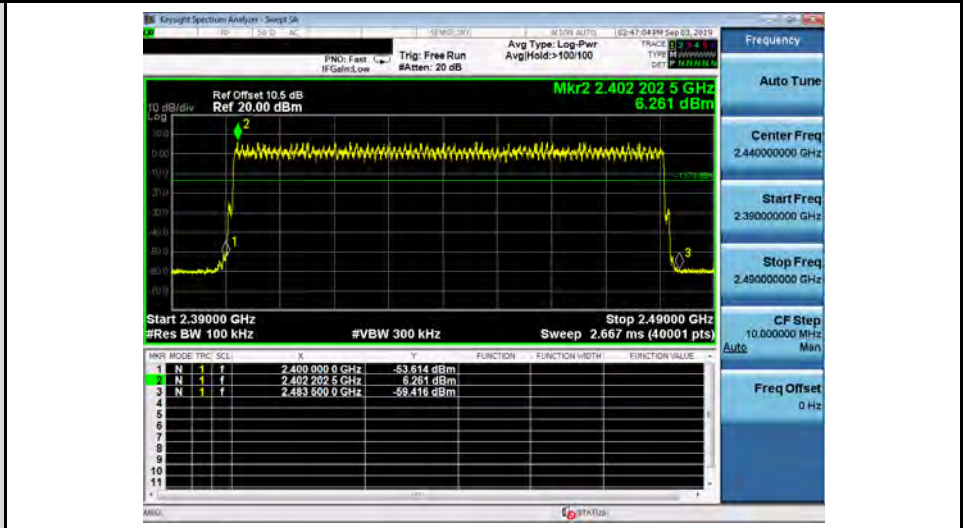



Annex C. Radiated Emission Measurement

Harmonic

Below 1GHz

Standard:		FCC Part 15.247		Test Distance:		3 m	
Test item:		Harmonic		Power:		AC 120 V/60 Hz	
Test Mode:		Mode 1		Temp.(°C)/Hum.(%RH):		26(°C)/60 %RH	
Frequency (MHz)	Reading (dBUV)	Correct Factor (dB/m)	Result (dBUV/m)	Limit (dBUV/m)	Margin (dB)	Remark	Ant.Polar. H / V
100.8100	45.29	-15.97	29.32	43.50	-14.18	QP	H
175.5000	38.70	-12.49	26.21	43.50	-17.29	QP	H
200.7200	44.15	-14.66	29.49	43.50	-14.01	QP	H
215.2700	44.74	-14.87	29.87	43.50	-13.63	QP	H
361.7400	39.67	-9.40	30.27	46.00	-15.73	QP	H
404.4200	39.33	-8.37	30.96	46.00	-15.04	QP	H
99.8400	49.04	-16.07	32.97	43.50	-10.53	QP	V
123.1200	41.70	-13.77	27.93	43.50	-15.57	QP	V
174.5300	39.96	-12.42	27.54	43.50	-15.96	QP	V
200.7200	44.43	-14.66	29.77	43.50	-13.73	QP	V
299.6600	37.36	-10.78	26.58	46.00	-19.42	QP	V
404.4200	38.44	-8.37	30.07	46.00	-15.93	QP	V

Note:1.Result (dBUV/m) = Correct Factor (dB/m) + Reading(dBUV).

2.Correction factor (dB/m) = Antenna Factor (dB/m) + Cable loss (dB) – Pre-Amplifier gain (dB).

3.When the peak results are less than average limit, so not need to evaluate the average.



Above 1GHz

Standard:	FCC Part 15.247	Test Distance:	3 m
Test item:	Harmonic	Power:	AC 120 V/60 Hz
Frequency:	2402 MHz	Temp.(°C)/Hum.(%RH):	26(°C)/60 %RH
Mode:	Mode 2		
Ant.Polar.:	Horizontal		

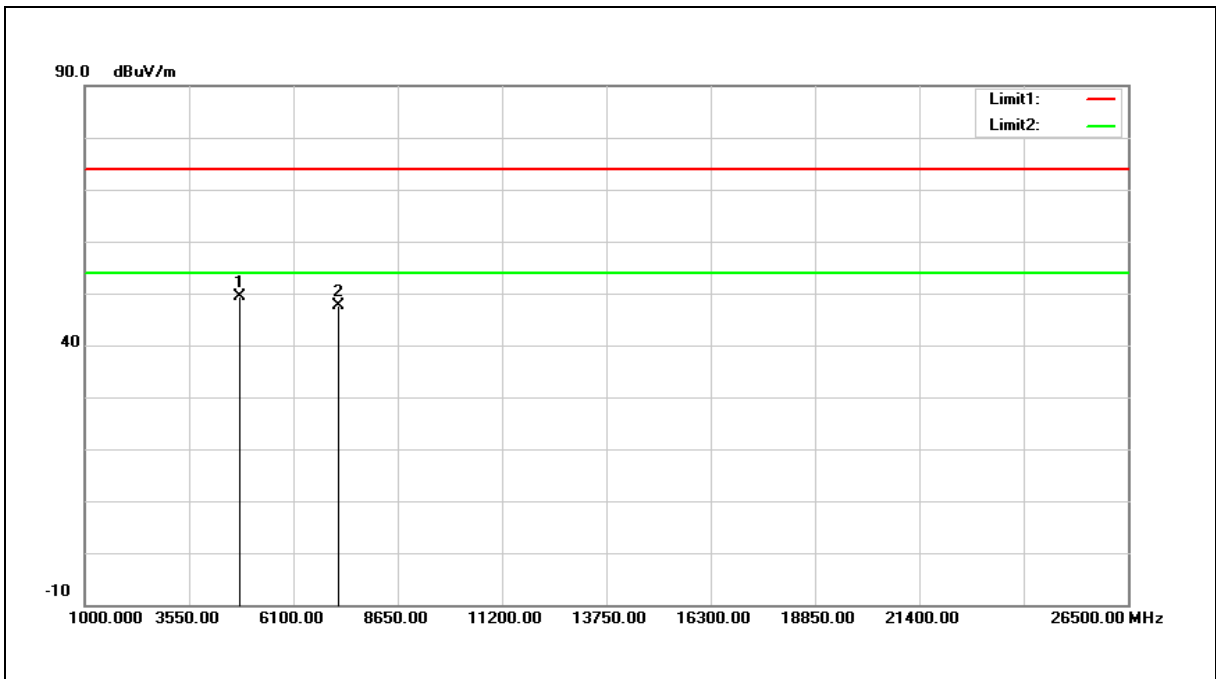

No.	Frequency (MHz)	Reading (dBuV)	Correct Factor (dB/m)	Result (dBuV/m)	Limit (dBuV/m)	Margin (dB)	Remark
1	4804.000	54.40	-5.03	49.37	74.00	-24.63	peak
2	7206.000	48.69	-0.97	47.72	74.00	-26.28	peak

Note:1.Result (dBuV/m) = Correct Factor (dB/m) + Reading(dBuV).

2.Correction factor (dB/m) = Antenna Factor (dB/m) + Cable loss (dB) – Pre-Amplifier gain (dB).

3. When the peak results are less than average limit, so not need to evaluate the average.



Standard:	FCC Part 15.247	Test Distance:	3 m
Test item:	Harmonic	Power:	AC 120 V/60 Hz
Frequency:	2402 MHz	Temp.(°C)/Hum.(%RH):	26(°C)/60 %RH
Mode:	Mode 2		
Ant.Polar.:	Vertical		

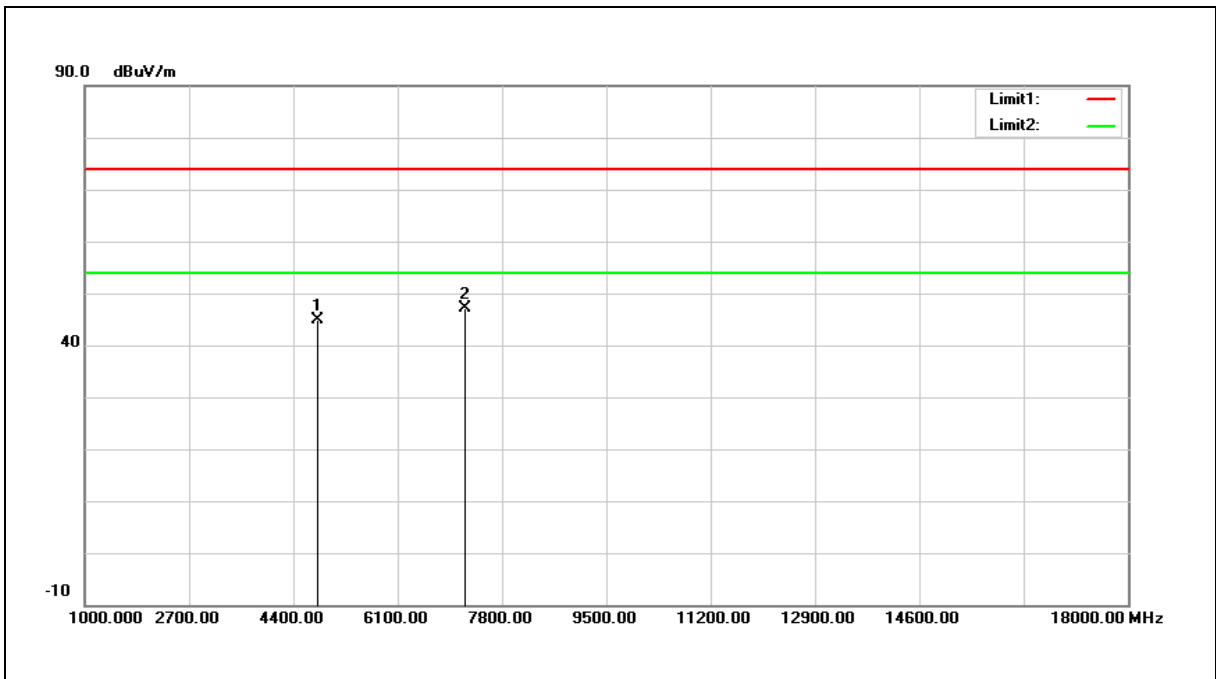

No.	Frequency (MHz)	Reading (dBuV)	Correct Factor (dB/m)	Result (dBuV/m)	Limit (dBuV/m)	Margin (dB)	Remark
1	4804.000	49.83	-5.03	44.80	74.00	-29.20	peak
2	7206.000	47.99	-0.97	47.02	74.00	-26.98	peak

Note:1.Result (dBuV/m) = Correct Factor (dB/m) + Reading(dBuV).

2.Correction factor (dB/m) = Antenna Factor (dB/m) + Cable loss (dB) – Pre-Amplifier gain (dB).

3. When the peak results are less than average limit, so not need to evaluate the average.



Standard:	FCC Part 15.247	Test Distance:	3 m
Test item:	Harmonic	Power:	AC 120 V/60 Hz
Frequency:	2441MHz	Temp.(°C)/Hum.(%RH):	26(°C)/60 %RH
Mode:	Mode 2		
Ant.Polar.:	Horizontal		

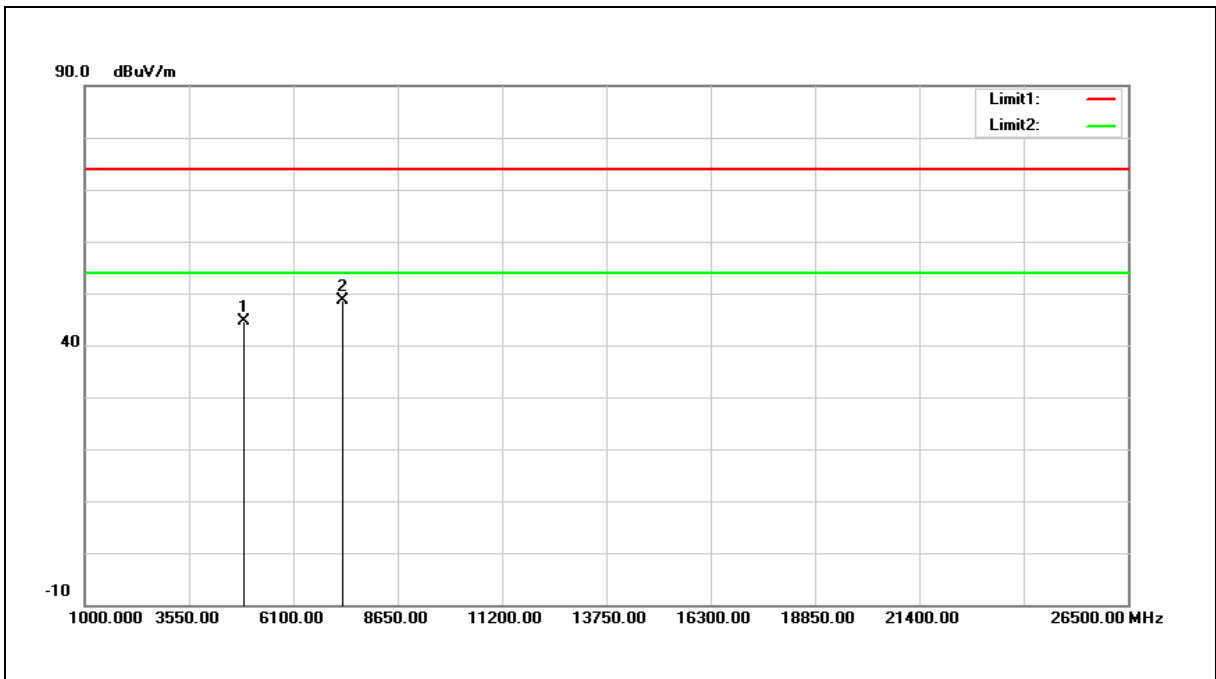

No.	Frequency (MHz)	Reading (dBuV)	Correct Factor (dB/m)	Result (dBuV/m)	Limit (dBuV/m)	Margin (dB)	Remark
1	4882.000	49.74	-5.10	44.64	74.00	-29.36	peak
2	7323.000	49.35	-0.63	48.72	74.00	-25.28	peak

Note:1.Result (dBuV/m) = Correct Factor (dB/m) + Reading(dBuV).

2.Correction factor (dB/m) = Antenna Factor (dB/m) + Cable loss (dB) – Pre-Amplifier gain (dB).

3. When the peak results are less than average limit, so not need to evaluate the average.

Standard:	FCC Part 15.247	Test Distance:	3 m
Test item:	Harmonic	Power:	AC 120 V/60 Hz
Frequency:	2441MHz	Temp.(°C)/Hum.(%RH):	26(°C)/60 %RH
Mode:	Mode 2		
Ant.Polar.:	Vertical		

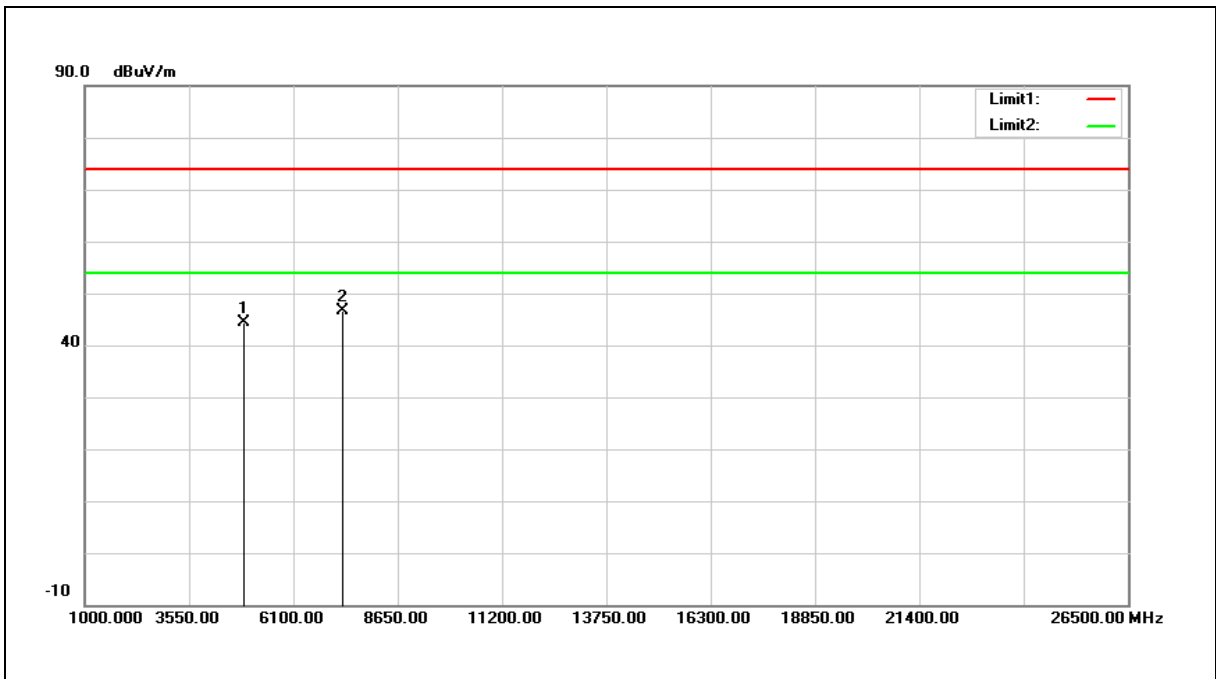

No.	Frequency (MHz)	Reading (dBuV)	Correct Factor (dB/m)	Result (dBuV/m)	Limit (dBuV/m)	Margin (dB)	Remark
1	4882.000	49.40	-5.10	44.30	74.00	-29.70	peak
2	7323.000	47.30	-0.63	46.67	74.00	-27.33	peak

Note:1.Result (dBuV/m) = Correct Factor (dB/m) + Reading(dBuV).

2.Correction factor (dB/m) = Antenna Factor (dB/m) + Cable loss (dB) – Pre-Amplifier gain (dB).

3. When the peak results are less than average limit, so not need to evaluate the average.



Standard:	FCC Part 15.247	Test Distance:	3 m
Test item:	Harmonic	Power:	AC 120 V/60 Hz
Frequency:	2480 MHz	Temp.(°C)/Hum.(%RH):	26(°C)/60 %RH
Mode:	Mode 2		
Ant.Polar.:	Horizontal		

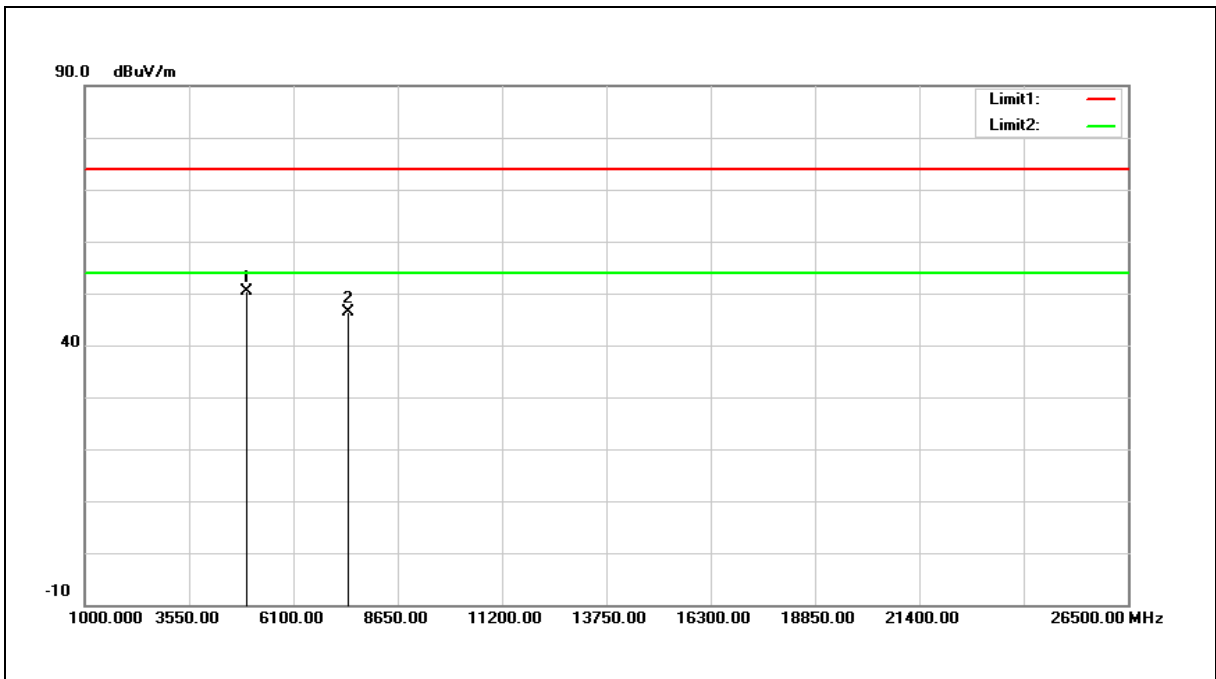

No.	Frequency (MHz)	Reading (dBuV)	Correct Factor (dB/m)	Result (dBuV/m)	Limit (dBuV/m)	Margin (dB)	Remark
1	4960.000	55.52	-5.17	50.35	74.00	-23.65	peak
2	7440.000	46.66	-0.35	46.31	74.00	-27.69	peak

Note:1.Result (dBuV/m) = Correct Factor (dB/m) + Reading(dBuV).

2.Correction factor (dB/m) = Antenna Factor (dB/m) + Cable loss (dB) – Pre-Amplifier gain (dB).

3. When the peak results are less than average limit, so not need to evaluate the average.



Standard:	FCC Part 15.247	Test Distance:	3 m
Test item:	Harmonic	Power:	AC 120 V/60 Hz
Frequency:	2480 MHz	Temp.(°C)/Hum.(%RH):	26(°C)/60 %RH
Mode:	Mode 2		
Ant.Polar.:	Vertical		

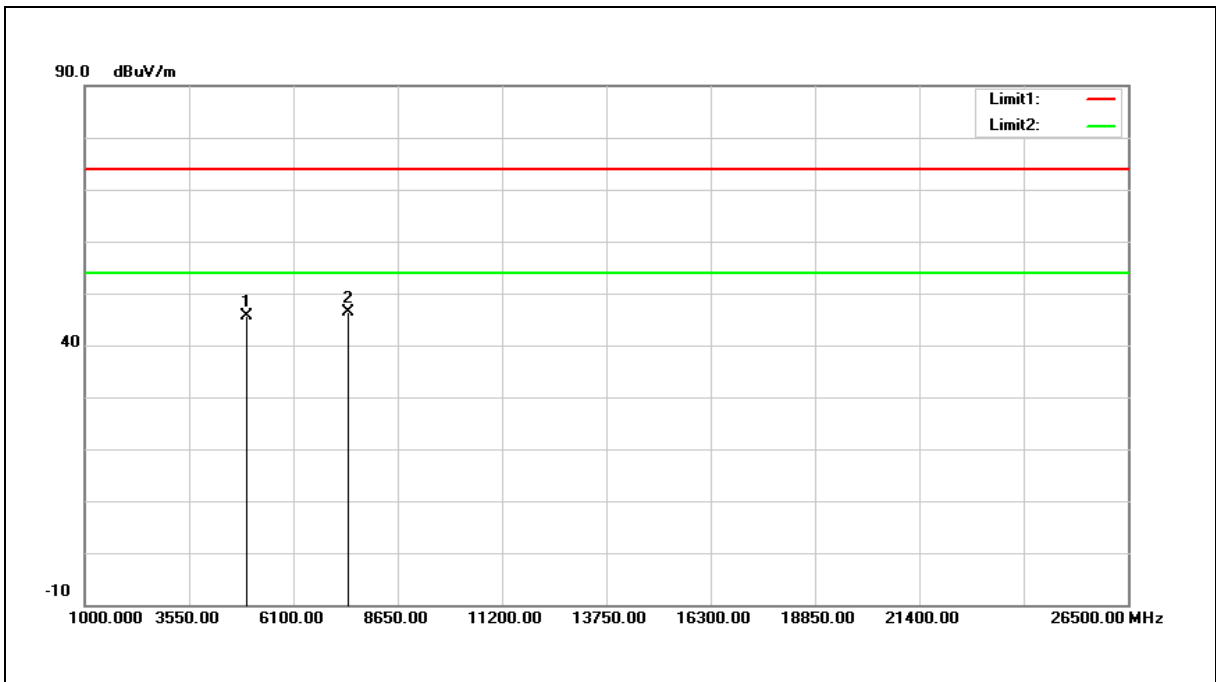

No.	Frequency (MHz)	Reading (dBuV)	Correct Factor (dB/m)	Result (dBuV/m)	Limit (dBuV/m)	Margin (dB)	Remark
1	4960.000	50.87	-5.17	45.70	74.00	-28.30	peak
2	7440.000	46.83	-0.35	46.48	74.00	-27.52	peak

Note:1.Result (dBuV/m) = Correct Factor (dB/m) + Reading(dBuV).

2.Correction factor (dB/m) = Antenna Factor (dB/m) + Cable loss (dB) – Pre-Amplifier gain (dB).

3. When the peak results are less than average limit, so not need to evaluate the average.



Standard:	FCC Part 15.247	Test Distance:	3 m
Test item:	Harmonic	Power:	AC 120 V/60 Hz
Frequency:	2402 MHz	Temp.(°C)/Hum.(%RH):	26(°C)/60 %RH
Mode:	Mode 4		
Ant.Polar.:	Horizontal		

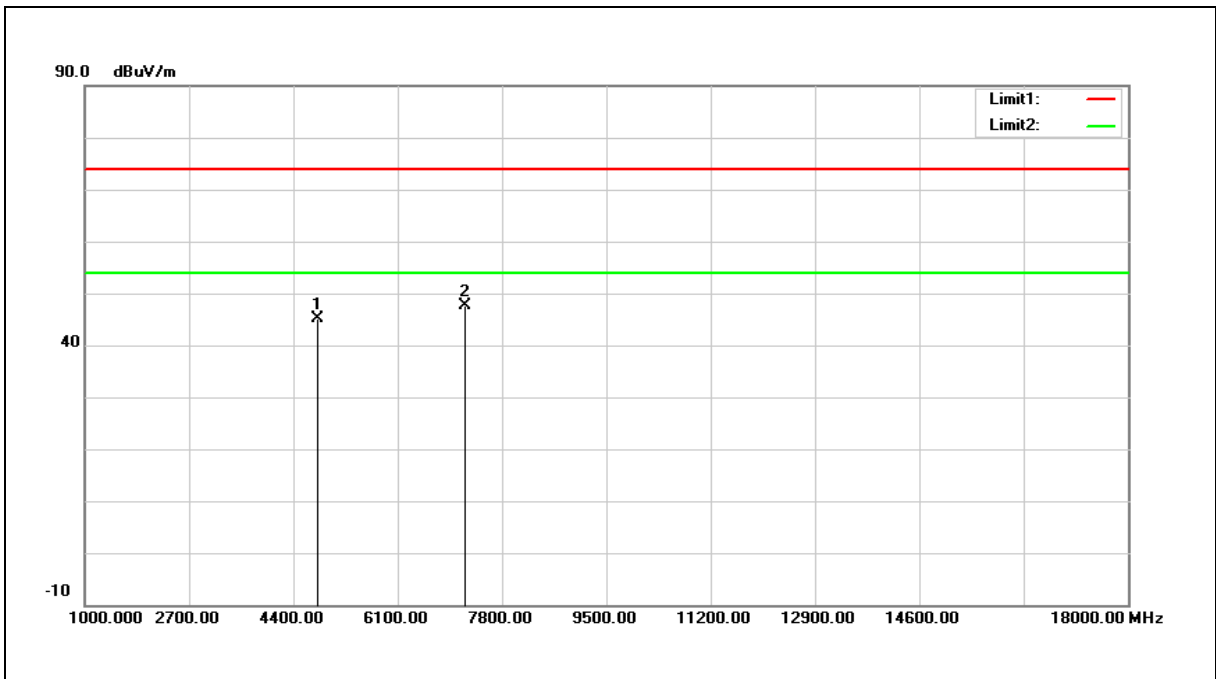

No.	Frequency (MHz)	Reading (dBuV)	Correct Factor (dB/m)	Result (dBuV/m)	Limit (dBuV/m)	Margin (dB)	Remark
1	4804.000	50.05	-5.03	45.02	74.00	-28.98	peak
2	7206.000	48.60	-0.97	47.63	74.00	-26.37	peak

Note:1.Result (dBuV/m) = Correct Factor (dB/m) + Reading(dBuV).

2.Correction factor (dB/m) = Antenna Factor (dB/m) + Cable loss (dB) – Pre-Amplifier gain (dB).

3. When the peak results are less than average limit, so not need to evaluate the average.



Standard:	FCC Part 15.247	Test Distance:	3 m
Test item:	Harmonic	Power:	AC 120 V/60 Hz
Frequency:	2402 MHz	Temp.(°C)/Hum.(%RH):	26(°C)/60 %RH
Mode:	Mode 4		
Ant.Polar.:	Vertical		

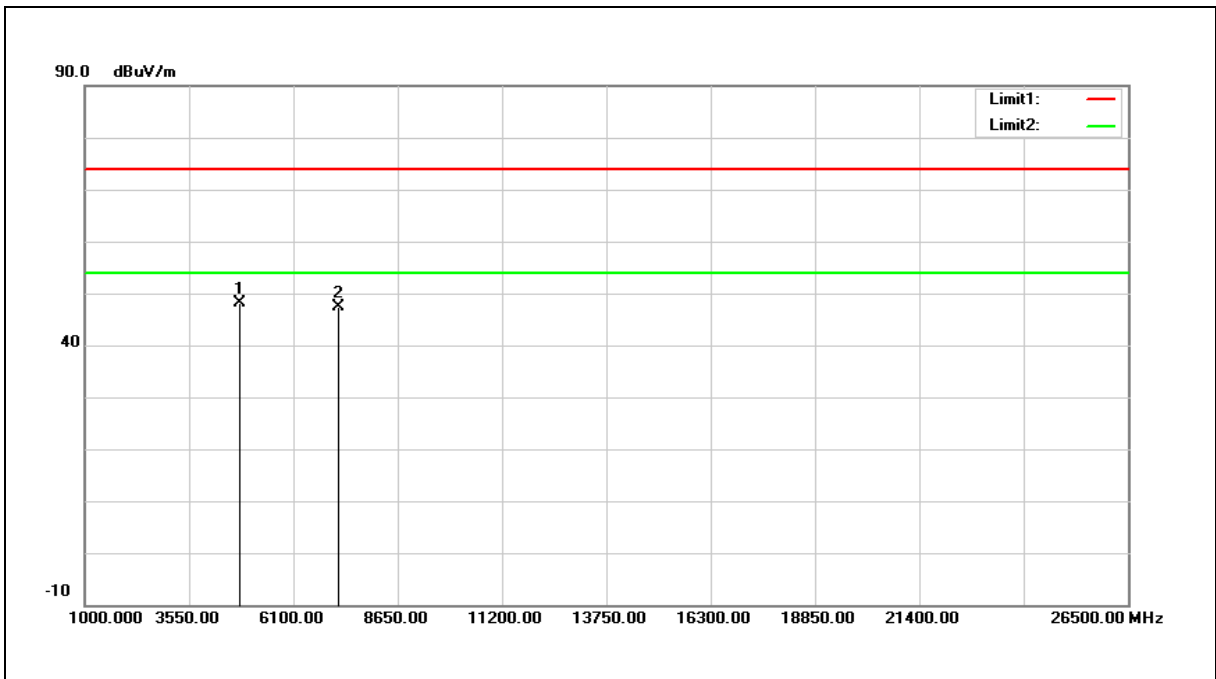

No.	Frequency (MHz)	Reading (dBuV)	Correct Factor (dB/m)	Result (dBuV/m)	Limit (dBuV/m)	Margin (dB)	Remark
1	4804.000	53.16	-5.03	48.13	74.00	-25.87	peak
2	7206.000	48.25	-0.97	47.28	74.00	-26.72	peak

Note:1.Result (dBuV/m) = Correct Factor (dB/m) + Reading(dBuV).

2.Correction factor (dB/m) = Antenna Factor (dB/m) + Cable loss (dB) – Pre-Amplifier gain (dB).

3. When the peak results are less than average limit, so not need to evaluate the average.



Standard:	FCC Part 15.247	Test Distance:	3 m
Test item:	Harmonic	Power:	AC 120 V/60 Hz
Frequency:	2441MHz	Temp.(°C)/Hum.(%RH):	26(°C)/60 %RH
Mode:	Mode 4		
Ant.Polar.:	Horizontal		

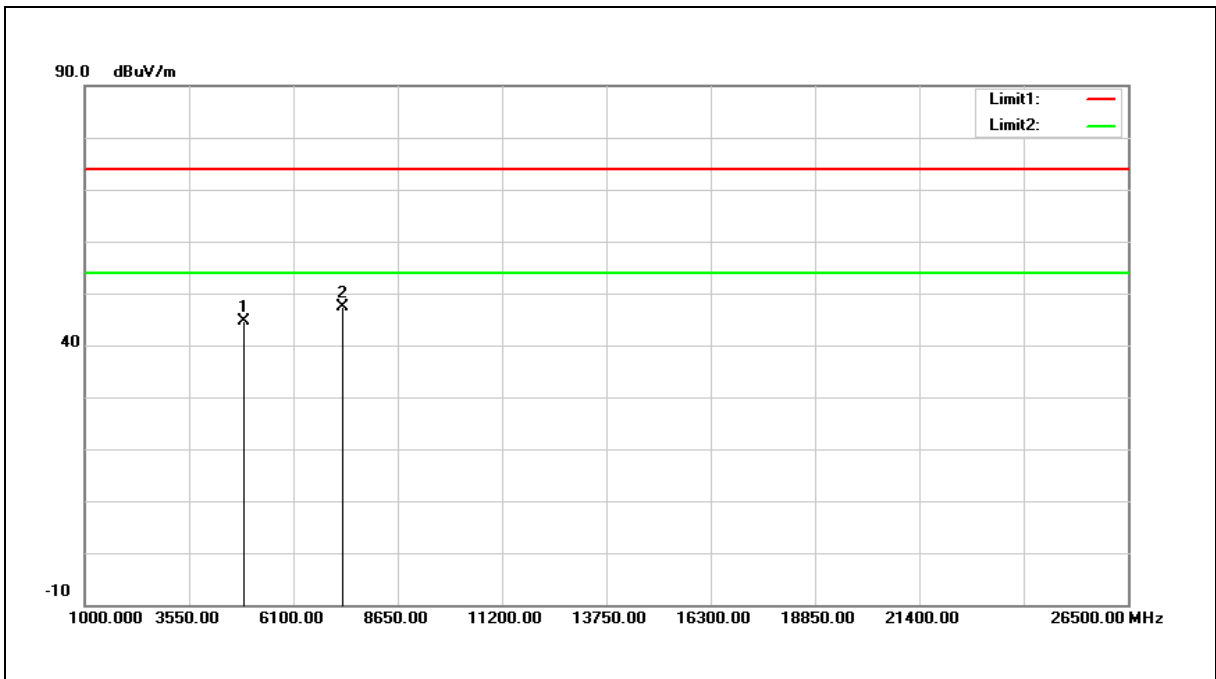

No.	Frequency (MHz)	Reading (dBuV)	Correct Factor (dB/m)	Result (dBuV/m)	Limit (dBuV/m)	Margin (dB)	Remark
1	4882.000	49.77	-5.10	44.67	74.00	-29.33	peak
2	7323.000	47.98	-0.63	47.35	74.00	-26.65	peak

Note:1.Result (dBuV/m) = Correct Factor (dB/m) + Reading(dBuV).

2.Correction factor (dB/m) = Antenna Factor (dB/m) + Cable loss (dB) – Pre-Amplifier gain (dB).

3. When the peak results are less than average limit, so not need to evaluate the average.



Standard:	FCC Part 15.247	Test Distance:	3 m
Test item:	Harmonic	Power:	AC 120 V/60 Hz
Frequency:	2441MHz	Temp.(°C)/Hum.(%RH):	26(°C)/60 %RH
Mode:	Mode 4		
Ant.Polar.:	Vertical		

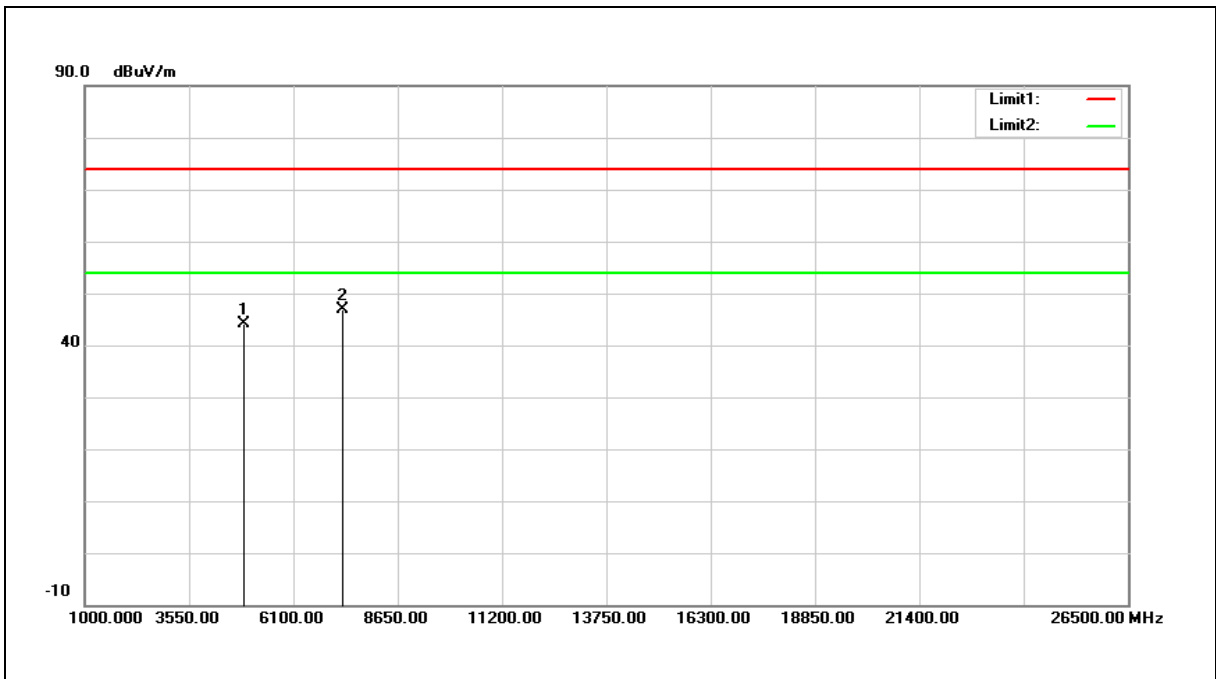

No.	Frequency (MHz)	Reading (dBuV)	Correct Factor (dB/m)	Result (dBuV/m)	Limit (dBuV/m)	Margin (dB)	Remark
1	4882.000	49.35	-5.10	44.25	74.00	-29.75	peak
2	7323.000	47.49	-0.63	46.86	74.00	-27.14	peak

Note:1.Result (dBuV/m) = Correct Factor (dB/m) + Reading(dBuV).

2.Correction factor (dB/m) = Antenna Factor (dB/m) + Cable loss (dB) – Pre-Amplifier gain (dB).

3. When the peak results are less than average limit, so not need to evaluate the average.



Standard:	FCC Part 15.247	Test Distance:	3 m
Test item:	Harmonic	Power:	AC 120 V/60 Hz
Frequency:	2480 MHz	Temp.(°C)/Hum.(%RH):	26(°C)/60 %RH
Mode:	Mode 4		
Ant.Polar.:	Horizontal		

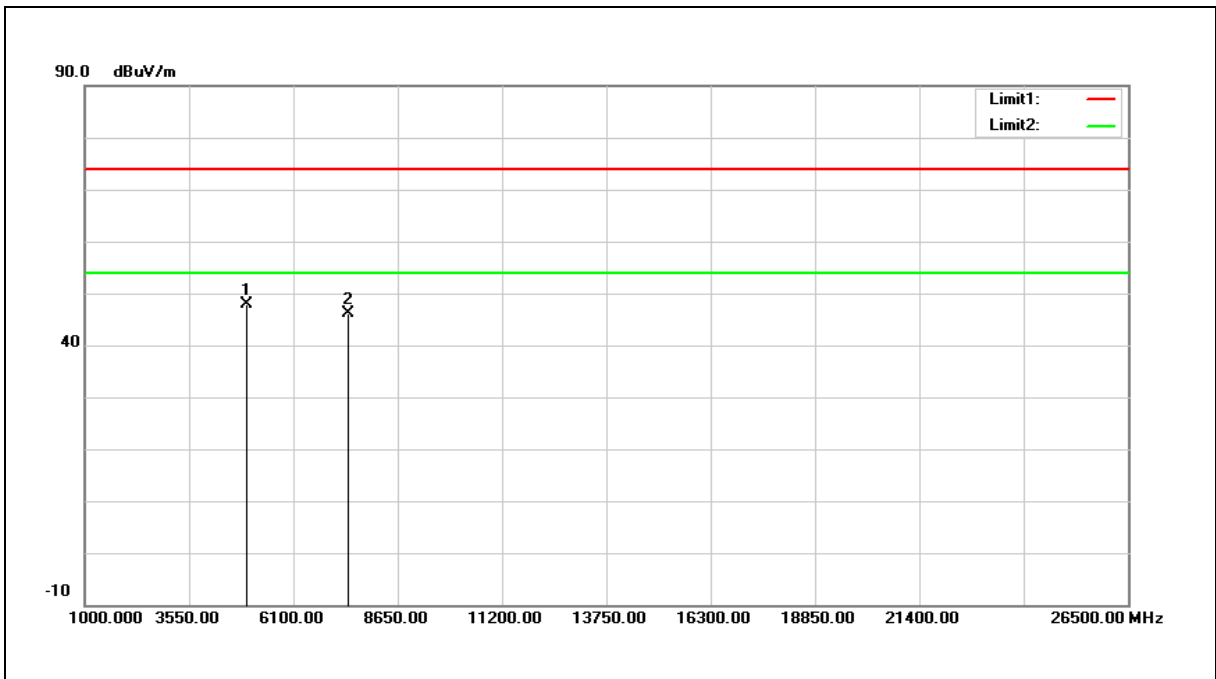

No.	Frequency (MHz)	Reading (dBuV)	Correct Factor (dB/m)	Result (dBuV/m)	Limit (dBuV/m)	Margin (dB)	Remark
1	4960.000	53.14	-5.17	47.97	74.00	-26.03	peak
2	7440.000	46.46	-0.35	46.11	74.00	-27.89	peak

Note:1.Result (dBuV/m) = Correct Factor (dB/m) + Reading(dBuV).

2.Correction factor (dB/m) = Antenna Factor (dB/m) + Cable loss (dB) – Pre-Amplifier gain (dB).

3. When the peak results are less than average limit, so not need to evaluate the average.



Standard:	FCC Part 15.247	Test Distance:	3 m
Test item:	Harmonic	Power:	AC 120 V/60 Hz
Frequency:	2480 MHz	Temp.(°C)/Hum.(%RH):	26(°C)/60 %RH
Mode:	Mode 4		
Ant.Polar.:	Vertical		

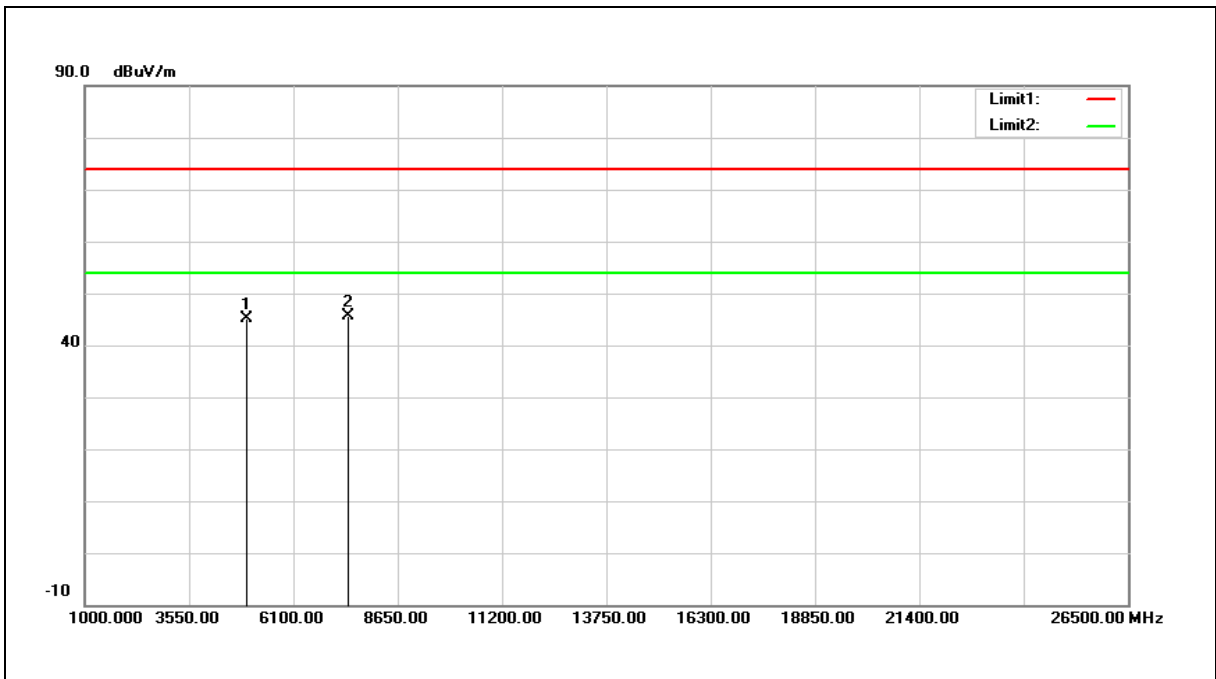

No.	Frequency (MHz)	Reading (dBuV)	Correct Factor (dB/m)	Result (dBuV/m)	Limit (dBuV/m)	Margin (dB)	Remark
1	4960.000	50.38	-5.17	45.21	74.00	-28.79	peak
2	7440.000	46.06	-0.35	45.71	74.00	-28.29	peak

Note:1.Result (dBuV/m) = Correct Factor (dB/m) + Reading(dBuV).

2.Correction factor (dB/m) = Antenna Factor (dB/m) + Cable loss (dB) – Pre-Amplifier gain (dB).

3. When the peak results are less than average limit, so not need to evaluate the average.

Band Edge

Standard:	FCC Part 15.247	Test Distance:	3 m
Test item:	Band edge	Power:	AC 120 V/60 Hz
Frequency:	2402 MHz	Temp.(°C)/Hum.(%RH):	26(°C)/60 %RH
Mode:	Mode 2		
Ant.Polar.:	Horizontal		

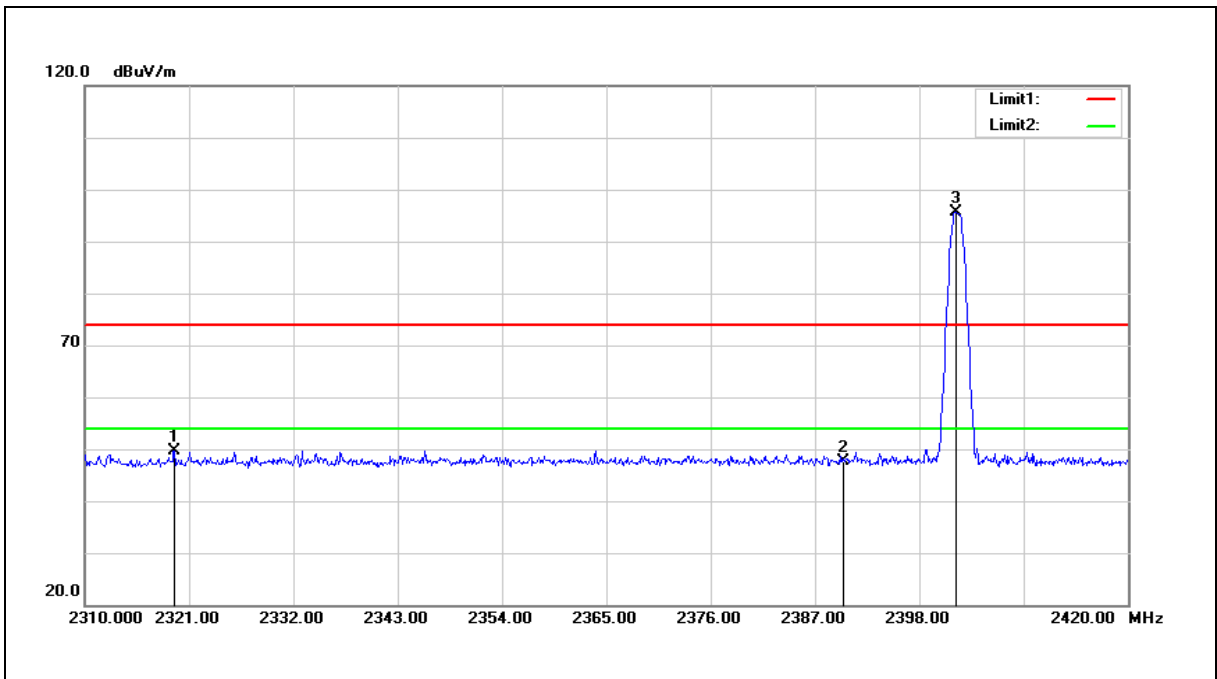

No.	Frequency (MHz)	Reading (dBuV)	Correct Factor (dB/m)	Result (dBuV/m)	Limit (dBuV/m)	Margin (dB)	Remark
1	2319.460	59.71	-10.00	49.71	74.00	-24.29	peak
2	2390.000	57.44	-9.78	47.66	74.00	-26.34	peak
3	2401.850	105.29	-9.75	95.54	---	---	peak

Note:1.Result (dBuV/m) = Correct Factor (dB/m) + Reading(dBuV).

2.Correction factor (dB/m) = Antenna Factor (dB/m) + Cable loss (dB) – Pre-Amplifier gain (dB).

3. When the peak results are less than average limit, so not need to evaluate the average.



Standard:	FCC Part 15.247	Test Distance:	3 m
Test item:	Band edge	Power:	AC 120 V/60 Hz
Frequency:	2402 MHz	Temp.(°C)/Hum.(%RH):	26(°C)/60 %RH
Mode:	Mode 2		
Ant.Polar.:	Vertical		

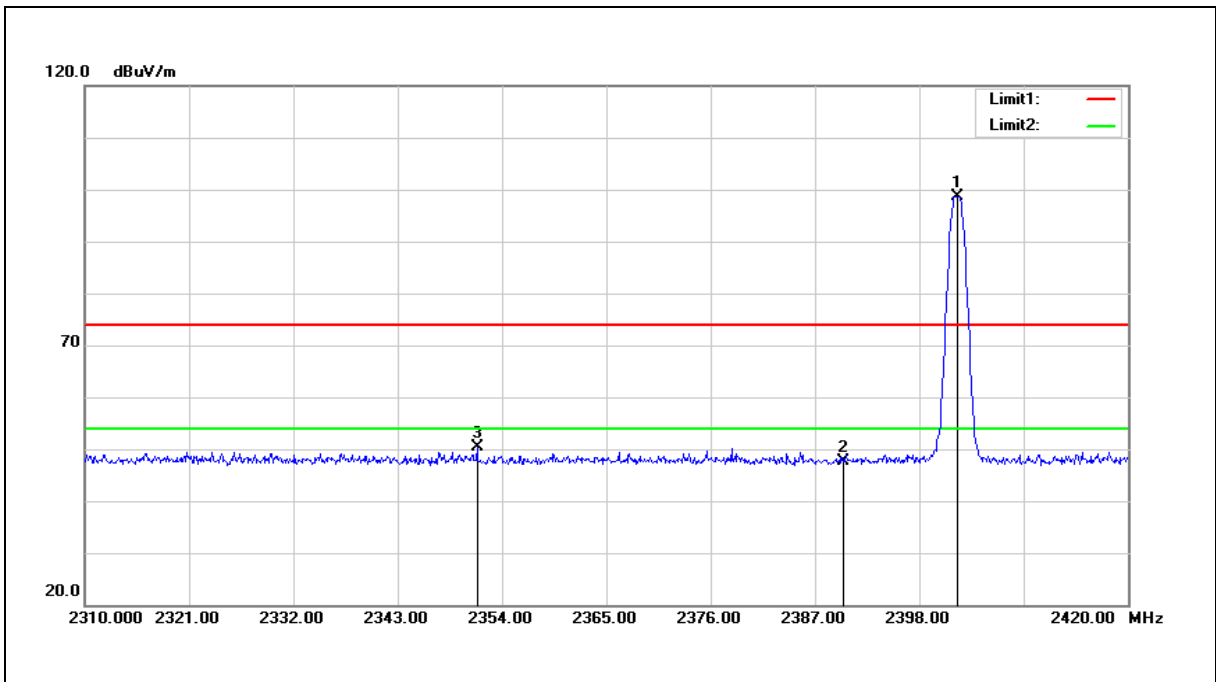

No.	Frequency (MHz)	Reading (dBuV)	Correct Factor (dB/m)	Result (dBuV/m)	Limit (dBuV/m)	Margin (dB)	Remark
1	2402.070	108.41	-9.75	98.66	---	---	peak
2	2390.000	57.50	-9.78	47.72	74.00	-26.28	peak
3	2351.360	60.22	-9.91	50.31	74.00	-23.69	peak

Note:1.Result (dBuV/m) = Correct Factor (dB/m) + Reading(dBuV).

2.Correction factor (dB/m) = Antenna Factor (dB/m) + Cable loss (dB) – Pre-Amplifier gain (dB).

3. When the peak results are less than average limit, so not need to evaluate the average.



Standard:	FCC Part 15.247	Test Distance:	3 m
Test item:	Band edge	Power:	AC 120 V/60 Hz
Frequency:	2480 MHz	Temp.(°C)/Hum.(%RH):	26(°C)/60 %RH
Mode:	Mode 2		
Ant.Polar.:	Horizontal		

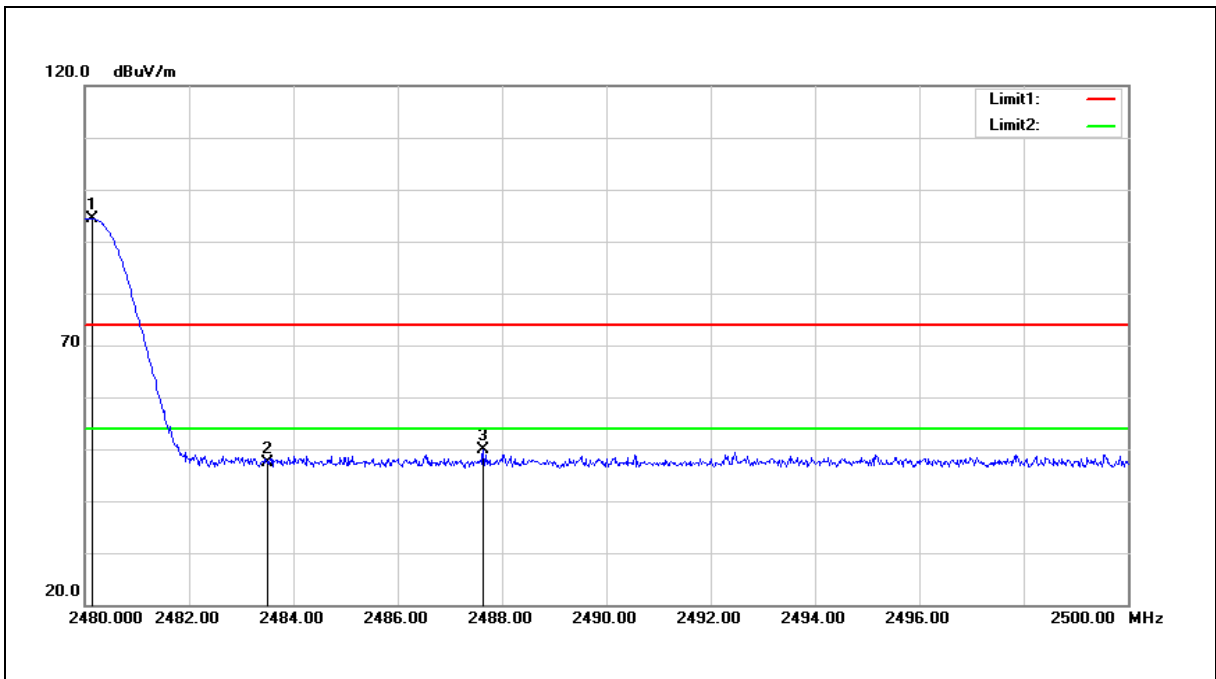

No.	Frequency (MHz)	Reading (dBuV)	Correct Factor (dB/m)	Result (dBuV/m)	Limit (dBuV/m)	Margin (dB)	Remark
1	2480.140	103.97	-9.58	94.39	---	---	peak
2	2483.500	57.06	-9.56	47.50	74.00	-26.50	peak
3	2487.640	59.51	-9.56	49.95	74.00	-24.05	peak

Note:1.Result (dBuV/m) = Correct Factor (dB/m) + Reading(dBuV).

2.Correction factor (dB/m) = Antenna Factor (dB/m) + Cable loss (dB) – Pre-Amplifier gain (dB).

3. When the peak results are less than average limit, so not need to evaluate the average.

Standard:	FCC Part 15.247	Test Distance:	3 m
Test item:	Band edge	Power:	AC 120 V/60 Hz
Frequency:	2480 MHz	Temp.(°C)/Hum.(%RH):	26(°C)/60 %RH
Mode:	Mode 2		
Ant.Polar.:	Vertical		

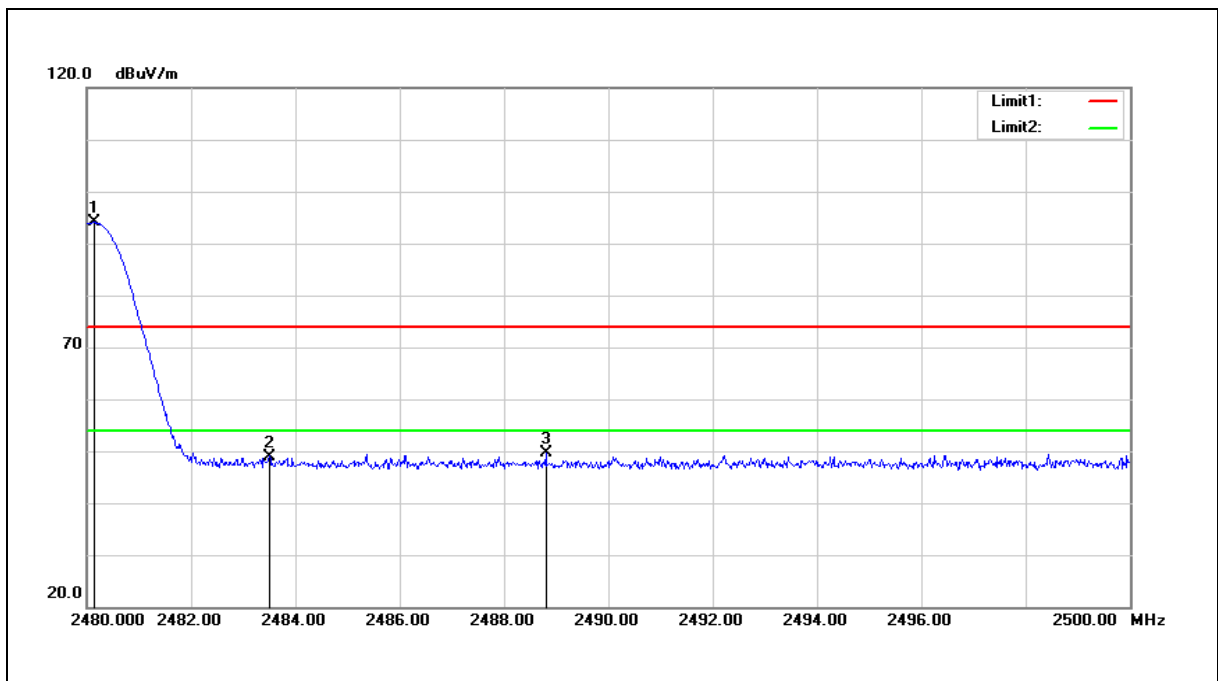

No.	Frequency (MHz)	Reading (dBuV)	Correct Factor (dB/m)	Result (dBuV/m)	Limit (dBuV/m)	Margin (dB)	Remark
1	2480.140	103.59	-9.58	94.01	---	---	peak
2	2483.500	58.56	-9.56	49.00	74.00	-25.00	peak
3	2488.800	59.22	-9.56	49.66	74.00	-24.34	peak

Note:1.Result (dBuV/m) = Correct Factor (dB/m) + Reading(dBuV).

2.Correction factor (dB/m) = Antenna Factor (dB/m) + Cable loss (dB) – Pre-Amplifier gain (dB).

3. When the peak results are less than average limit, so not need to evaluate the average.



Standard:	FCC Part 15.247	Test Distance:	3 m
Test item:	Band edge	Power:	AC 120 V/60 Hz
Frequency:	hopping	Temp.(°C)/Hum.(%RH):	26(°C)/60 %RH
Mode:	Mode 2		
Ant.Polar.:	Horizontal		

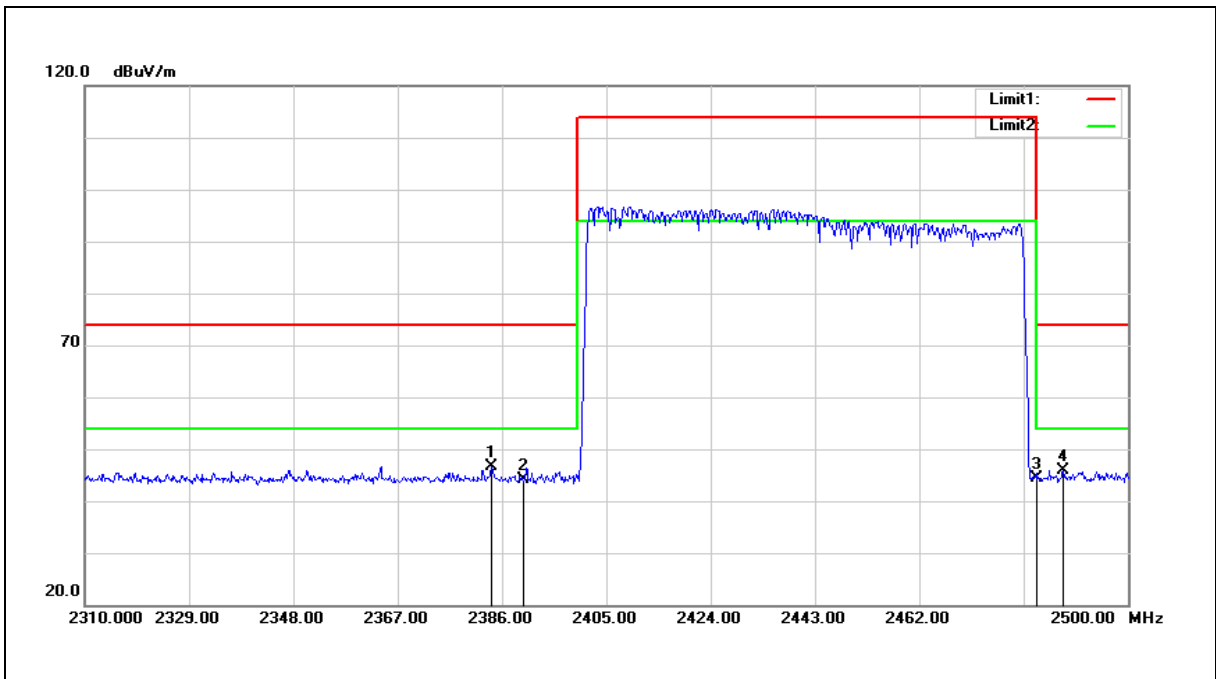

No.	Frequency (MHz)	Reading (dBuV)	Correct Factor (dB/m)	Result (dBuV/m)	Limit (dBuV/m)	Margin (dB)	Remark
1	2384.100	57.43	-10.85	46.58	74.00	-27.42	peak
2	2390.000	55.05	-10.85	44.20	74.00	-29.80	peak
3	2483.500	55.01	-10.65	44.36	74.00	-29.64	peak
4	2488.220	56.46	-10.64	45.82	74.00	-28.18	peak

Note:1.Result (dBuV/m) = Correct Factor (dB/m) + Reading(dBuV).

2.Correction factor (dB/m) = Antenna Factor (dB/m) + Cable loss (dB) – Pre-Amplifier gain (dB).

3. When the peak results are less than average limit, so not need to evaluate the average.

Standard:	FCC Part 15.247	Test Distance:	3 m
Test item:	Band edge	Power:	AC 120 V/60 Hz
Frequency:	hopping	Temp.(°C)/Hum.(%RH):	26(°C)/60 %RH
Mode:	Mode 2		
Ant.Polar.:	Vertical		

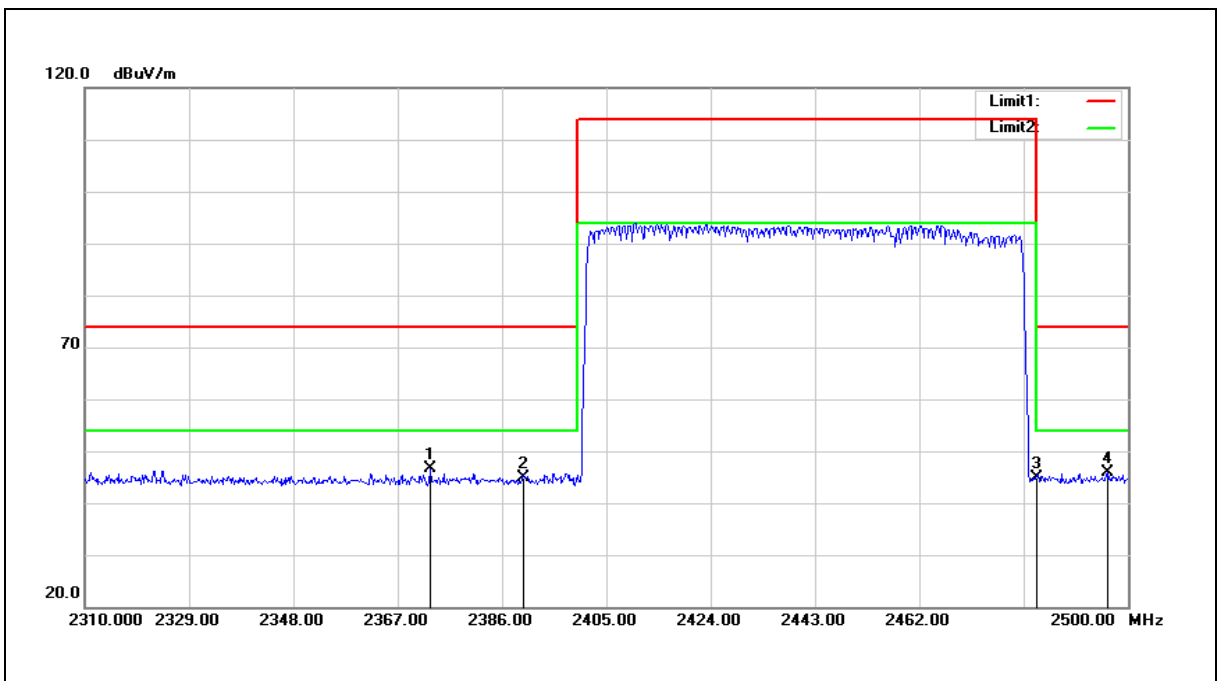

No.	Frequency (MHz)	Reading (dBuV)	Correct Factor (dB/m)	Result (dBuV/m)	Limit (dBuV/m)	Margin (dB)	Remark
1	2372.890	57.47	-10.88	46.59	74.00	-27.41	peak
2	2390.000	55.73	-10.85	44.88	74.00	-29.12	peak
3	2483.500	55.53	-10.65	44.88	74.00	-29.12	peak
4	2496.390	56.38	-10.62	45.76	74.00	-28.24	peak

Note:1.Result (dBuV/m) = Correct Factor (dB/m) + Reading(dBuV).

2.Correction factor (dB/m) = Antenna Factor (dB/m) + Cable loss (dB) – Pre-Amplifier gain (dB).

3. When the peak results are less than average limit, so not need to evaluate the average.

Standard:	FCC Part 15.247	Test Distance:	3 m
Test item:	Band edge	Power:	AC 120 V/60 Hz
Frequency:	2402 MHz	Temp.(°C)/Hum.(%RH):	26(°C)/60 %RH
Mode:	Mode 4		
Ant.Polar.:	Horizontal		

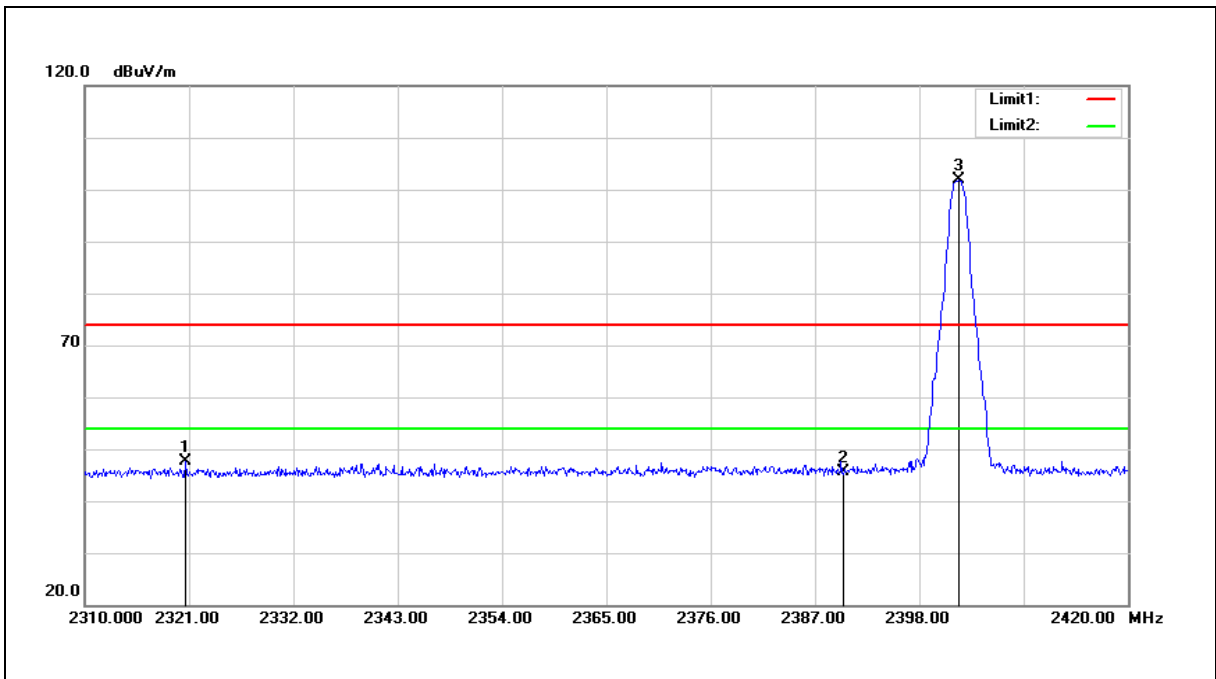

No.	Frequency (MHz)	Reading (dBuV)	Correct Factor (dB/m)	Result (dBuV/m)	Limit (dBuV/m)	Margin (dB)	Remark
1	2320.670	57.63	-10.00	47.63	74.00	-26.37	peak
2	2390.000	55.34	-9.78	45.56	74.00	-28.44	peak
3	2402.180	111.58	-9.75	101.83	---	---	peak

Note:1.Result (dBuV/m) = Correct Factor (dB/m) + Reading(dBuV).

2.Correction factor (dB/m) = Antenna Factor (dB/m) + Cable loss (dB) – Pre-Amplifier gain (dB).

3. When the peak results are less than average limit, so not need to evaluate the average.

Standard:	FCC Part 15.247	Test Distance:	3 m
Test item:	Band edge	Power:	AC 120 V/60 Hz
Frequency:	2402 MHz	Temp.(°C)/Hum.(%RH):	26(°C)/60 %RH
Mode:	Mode 4		
Ant.Polar.:	Vertical		

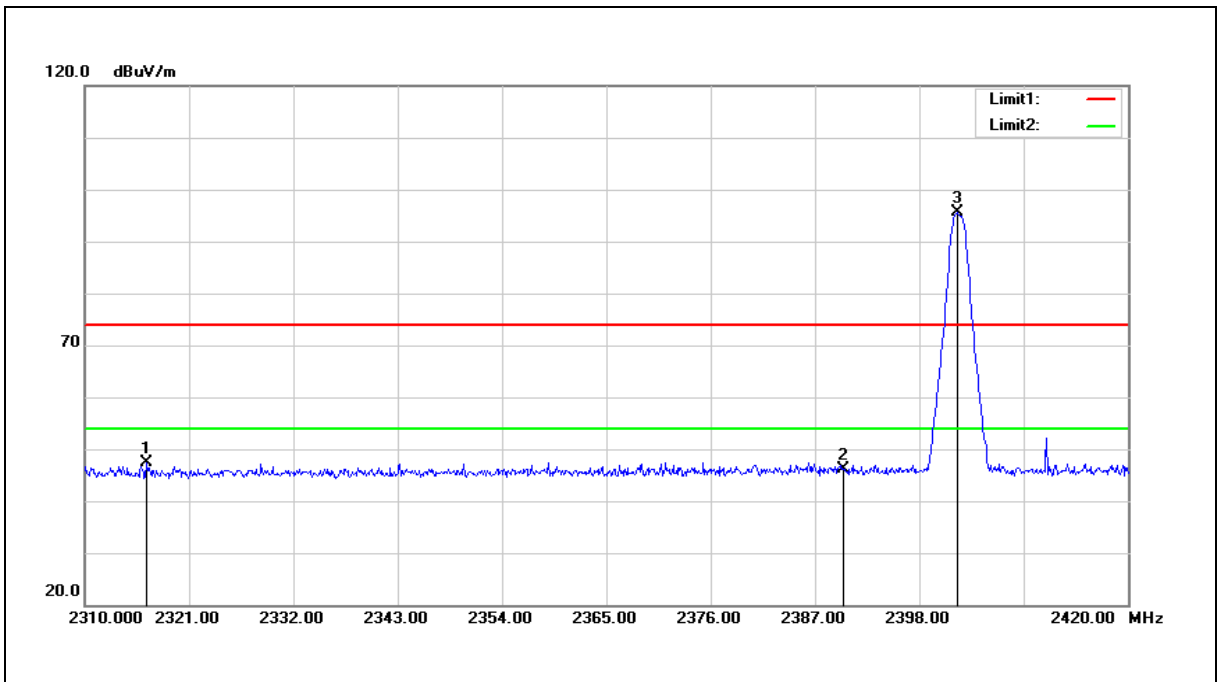

No.	Frequency (MHz)	Reading (dBuV)	Correct Factor (dB/m)	Result (dBuV/m)	Limit (dBuV/m)	Margin (dB)	Remark
1	2316.490	57.42	-10.02	47.40	74.00	-26.60	peak
2	2390.000	55.97	-9.78	46.19	74.00	-27.81	peak
3	2401.960	105.26	-9.75	95.51	---	---	peak

Note:1.Result (dBuV/m) = Correct Factor (dB/m) + Reading(dBuV).

2.Correction factor (dB/m) = Antenna Factor (dB/m) + Cable loss (dB) – Pre-Amplifier gain (dB).

3. When the peak results are less than average limit, so not need to evaluate the average.



Standard:	FCC Part 15.247	Test Distance:	3 m
Test item:	Band edge	Power:	AC 120 V/60 Hz
Frequency:	2480 MHz	Temp.(°C)/Hum.(%RH):	26(°C)/60 %RH
Mode:	Mode 4		
Ant.Polar.:	Horizontal		

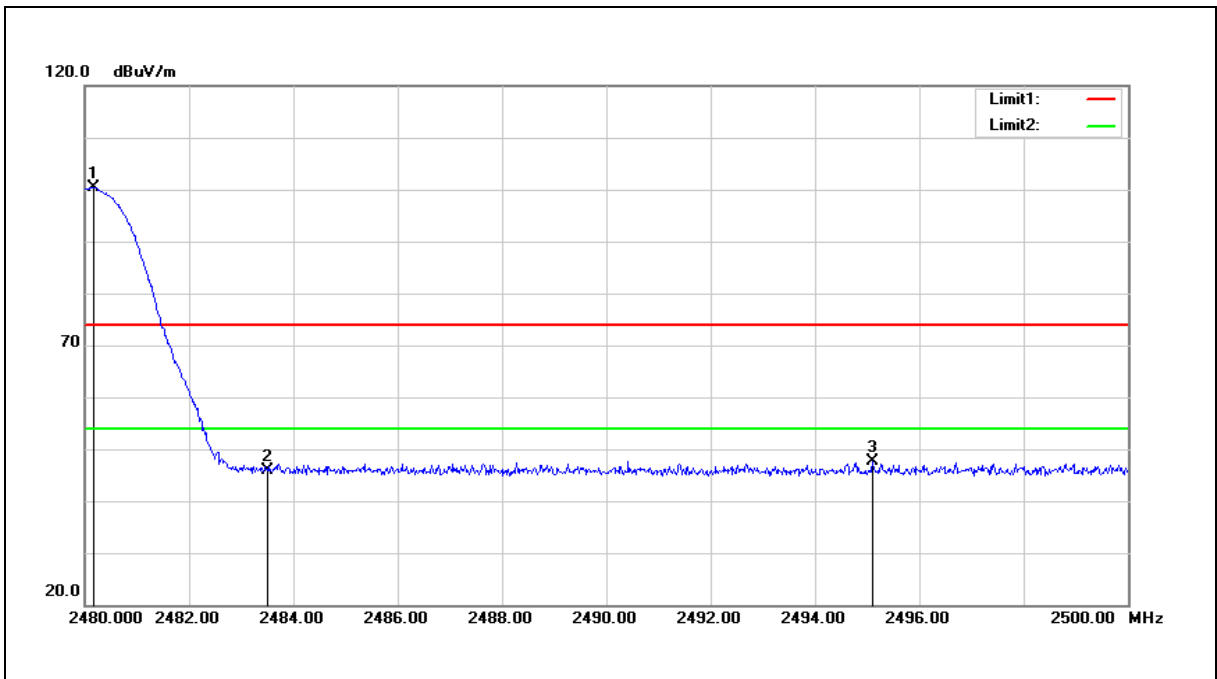

No.	Frequency (MHz)	Reading (dBuV)	Correct Factor (dB/m)	Result (dBuV/m)	Limit (dBuV/m)	Margin (dB)	Remark
1	2480.180	110.00	-9.58	100.42	---	---	peak
2	2483.500	55.54	-9.56	45.98	74.00	-28.02	peak
3	2495.100	57.18	-9.54	47.64	74.00	-26.36	peak

Note:1.Result (dBuV/m) = Correct Factor (dB/m) + Reading(dBuV).

2.Correction factor (dB/m) = Antenna Factor (dB/m) + Cable loss (dB) – Pre-Amplifier gain (dB).

3. When the peak results are less than average limit, so not need to evaluate the average.



Standard:	FCC Part 15.247	Test Distance:	3 m
Test item:	Band edge	Power:	AC 120 V/60 Hz
Frequency:	2480 MHz	Temp.(°C)/Hum.(%RH):	26(°C)/60 %RH
Mode:	Mode 4		
Ant.Polar.:	Vertical		

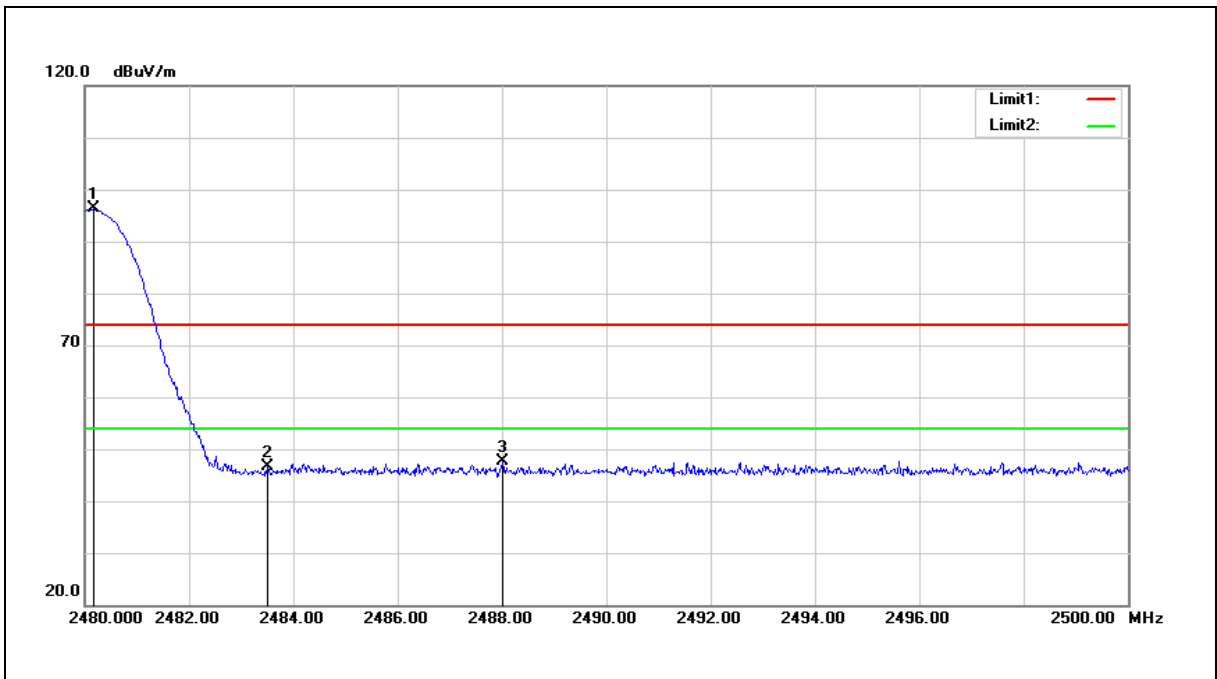

No.	Frequency (MHz)	Reading (dBuV)	Correct Factor (dB/m)	Result (dBuV/m)	Limit (dBuV/m)	Margin (dB)	Remark
1	2480.180	105.87	-9.58	96.29	---	---	peak
2	2483.500	56.17	-9.56	46.61	74.00	-27.39	peak
3	2488.000	57.30	-9.56	47.74	74.00	-26.26	peak

Note:1.Result (dBuV/m) = Correct Factor (dB/m) + Reading(dBuV).

2.Correction factor (dB/m) = Antenna Factor (dB/m) + Cable loss (dB) – Pre-Amplifier gain (dB).

3. When the peak results are less than average limit, so not need to evaluate the average.

Standard:	FCC Part 15.247	Test Distance:	3 m
Test item:	Band edge	Power:	AC 120 V/60 Hz
Frequency:	hopping	Temp.(°C)/Hum.(%RH):	26(°C)/60 %RH
Mode:	Mode 4		
Ant.Polar.:	Horizontal		

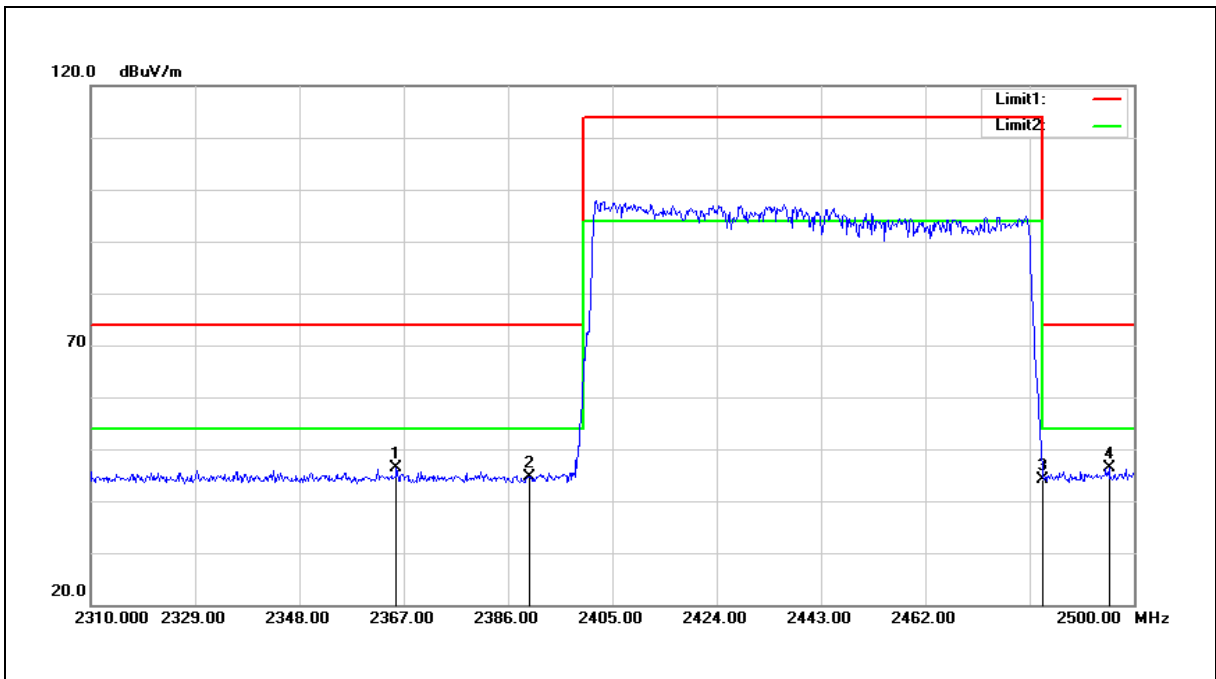

No.	Frequency (MHz)	Reading (dBuV)	Correct Factor (dB/m)	Result (dBuV/m)	Limit (dBuV/m)	Margin (dB)	Remark
1	2365.670	57.37	-10.90	46.47	74.00	-27.53	peak
2	2390.000	55.39	-10.85	44.54	74.00	-29.46	peak
3	2483.500	54.83	-10.65	44.18	74.00	-29.82	peak
4	2495.440	56.90	-10.63	46.27	74.00	-27.73	peak

Note:1.Result (dBuV/m) = Correct Factor (dB/m) + Reading(dBuV).

2.Correction factor (dB/m) = Antenna Factor (dB/m) + Cable loss (dB) – Pre-Amplifier gain (dB).

3. When the peak results are less than average limit, so not need to evaluate the average.

Standard:	FCC Part 15.247	Test Distance:	3 m
Test item:	Band edge	Power:	AC 120 V/60 Hz
Frequency:	hopping	Temp.(°C)/Hum.(%RH):	26(°C)/60 %RH
Mode:	Mode 4		
Ant.Polar.:	Vertical		

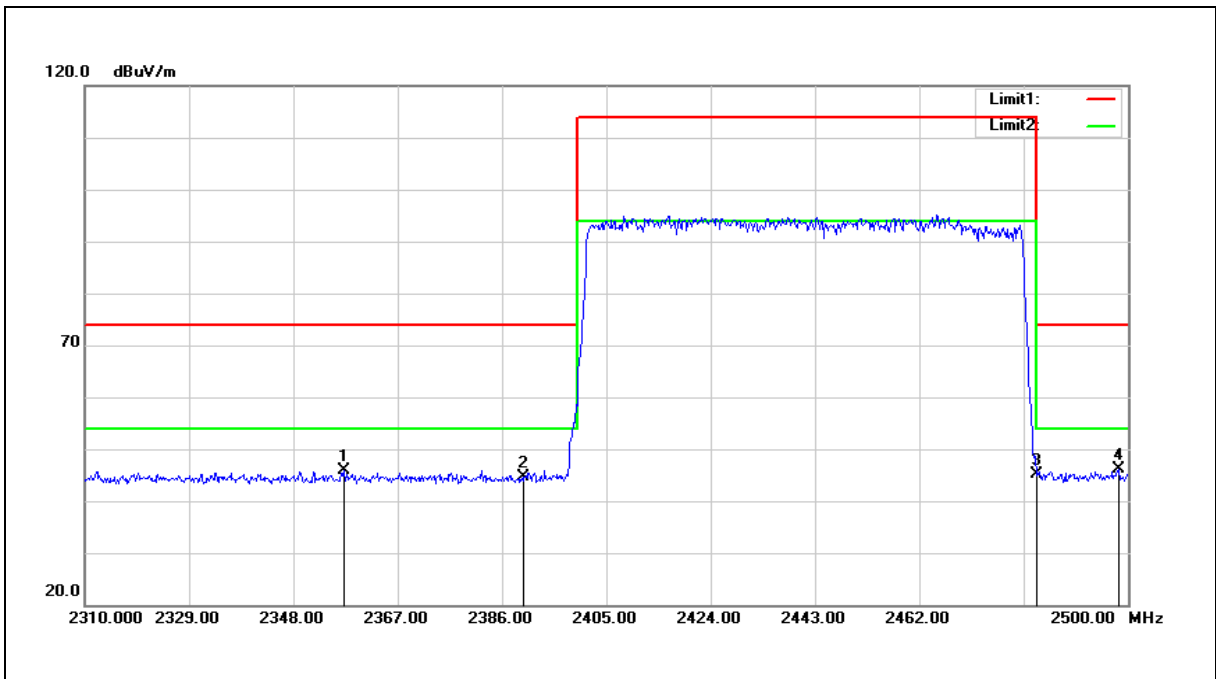

No.	Frequency (MHz)	Reading (dBuV)	Correct Factor (dB/m)	Result (dBuV/m)	Limit (dBuV/m)	Margin (dB)	Remark
1	2357.120	56.79	-10.91	45.88	74.00	-28.12	peak
2	2390.000	55.48	-10.85	44.63	74.00	-29.37	peak
3	2483.500	55.81	-10.65	45.16	74.00	-28.84	peak
4	2498.290	56.71	-10.62	46.09	74.00	-27.91	peak

Note:1.Result (dBuV/m) = Correct Factor (dB/m) + Reading(dBuV).

2.Correction factor (dB/m) = Antenna Factor (dB/m) + Cable loss (dB) – Pre-Amplifier gain (dB).

3. When the peak results are less than average limit, so not need to evaluate the average.