

Manual for

TPS-500

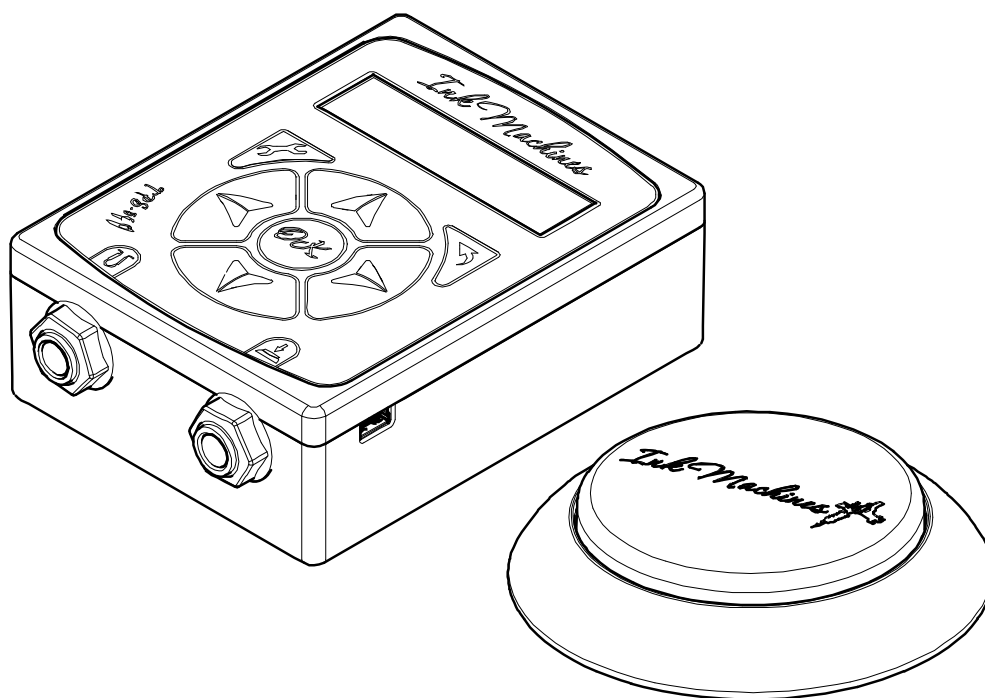

Original instructions

Manufacturer: InkMachines Sweden AB
Grusåsvägen 8
352 42 VÄXJÖ, Sweden



Table of Content

Table of Content	1
Document history.....	2
Introduction	3
Intended use.....	3
Document information.....	3
Description	4
Main unit.....	5
Powerpack.....	5
Foot switch.....	5
Neorail.....	5
Charger.....	6
Approvals	7
Identification labels.....	7
Safety	8
Regulations.....	8
Product.....	8
Customer.....	8
Instruction	9
Delivery.....	9
Unpacking.....	9
Getting started.....	11
Connection	18
Wires.....	18
User interface	19
Display.....	20
Settings.....	22
Pairing.....	23
Active Powerpack.....	24
Run mode settings for Powerpack and Rotary mode for cable.....	24
Run mode display window for Coil machines.....	24
Cleaning and hygienic	25
Cleaning.....	25
Preparation.....	25
Service and maintenance	27
Software upgrades.....	27
Exchange of foot switch battery.....	27
Reset Powerpack.....	28
Waste	29
Trouble shooting	30
Technical specification	33

Main unit, *TPS-500* © 33
 Powerpack for *Scorpion* © 33
 Powerpack for *Stingray* and *Dragonfly* © 33
 Foot switch WFS © 34

App.

Declaration of Conformity for FCC and CE

Warranty

Certificate Electromagnetic compatibility

Document history

Date (YY- MM-DD)	Changes	Revision
2017-09-25	Released	1.0
2018-02-19	Updated	2.0
2018-05-25	Updated	3.0

Introduction

We are proud to present the *TPS-500* wireless power supply designed with the tattoo artist in focus and manufactured with the highest quality materials and components available.

Working without cords gives the Tattoo artist flexibility and freedom to perform otherwise difficult movements. It also provides a better environment regarding hygienic as the lack of cords reduce the risk of cross contamination

Intended use

The *TPS-500* is designed and developed solely for tattooing of humans for the use by professional tattoo artists only. The *TPS-500* can be used wirelessly with the products **Scorpion**, **Stingray** and **Dragonfly** and with other tattoo machines by wire.

Document information

Information in this document is subject to change without notice. InkMachines assumes no responsibility for any errors that may appear in this document

Stylistic conventions

In this manual all references texts are shown in the text font *italic*.

Cautions and Notes are shown as below

Text

Document producer

This document has been produced by InkMachines Sweden AB.

Description

The *TPS-500* wireless power supply is a power supply designed to allow the freedom of tattooing without any cords to the tattoo machine or the foot switch. Once the machines are rigged with Powerpacks (max 6 machines) the main unit will sense which machine you pick up and recall the volt settings.

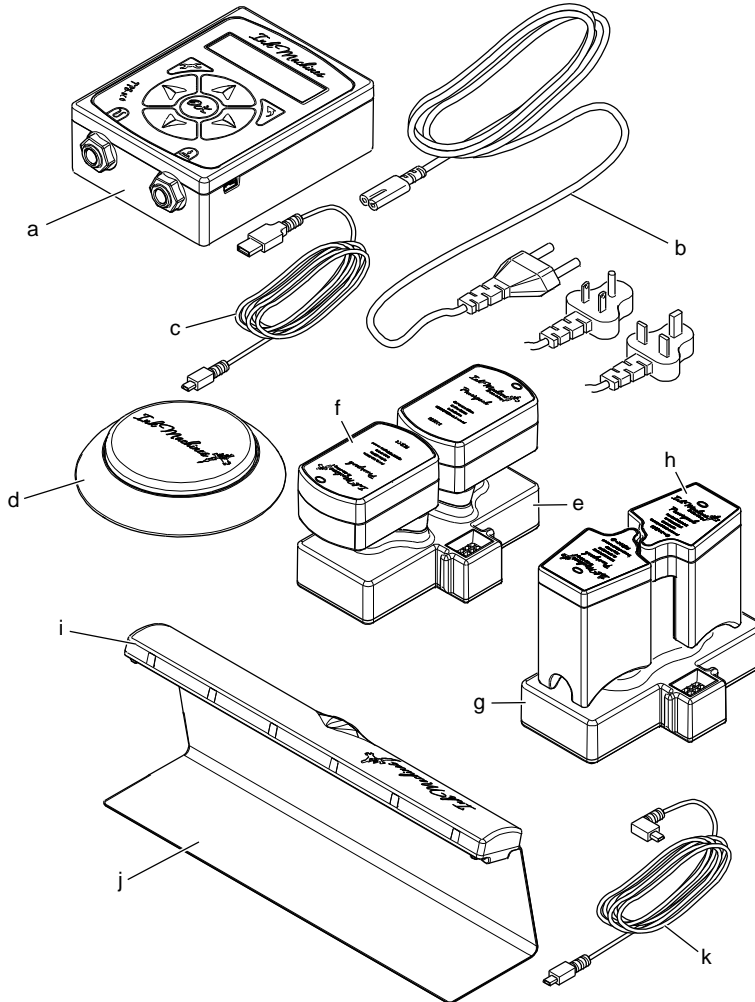

- | | |
|--|---|
| a. Main unit | g. Charger for Stingray and Dragonfly (optional) |
| b. Power cord (different depending on country)
(Included in delivery of a.) | h. Powerpack for Stingray and Dragonfly
(optional) |
| c. USB cable (Included in delivery of a.) | i. Neorail (optional) |
| d. Foot switch (optional) | j. Stand (optional)
(Included in delivery of g.) |
| e. Charger for Scorpion (optional) | k. USB cable (optional)
(Included in delivery of g.) |
| f. Powerpack for Scorpion (optional) | |

Main unit

The Main unit (a.) is equipped with an LCD display that makes it possible to view status and make settings to connected Powerpacks (f.). Communications between the units are by radio for optimal reliability and performance. The *TPS-500* can handle up to 6 active Powerpacks and charge 2.

The Main unit is also equipped with regular ¼" Phono plugs and can handle other tattoo machines and foot switches by wire for full compatibility. There is also a USB connection for future software upgrades and for connection of the Neorail.

The USB cable (c.) should ONLY be used for software upgrades to the Main unit.

The main unit is not equipped with any power switch, instead the sleep mode is automatic activated if the unit is not touched for a few minutes. This will put the unit in standby mode. Sleep mode will dim the display and use less power. If there is Powerpacks in the charger they will go on charging. The sleep mode will also pause the total time when activated. To deactivate just tilt the tattoo machine, push a button or the footswitch.

User interface – Control panel and Display

The User interface gives you the possibility to control the voltage and the settings, and to view time left and status of the active Powerpack. The User interface is equipped with a Display and a Control panel. The Display will show the status of the Active Powerpack and the Control panel will make it possible to choose different selections and change settings.

All the touching normally takes place on the Control panel during the session - for the hygienic barrier, see Cleaning and hygienic *on page 25*. There is normally no need to touch the Powerpacks during session.

Powerpack

The battery packs or Powerpacks (f.) are made with leading edge battery technology weighing only 70 grams each. The normal RCA or clip cord from the machine to the floor weighs about 50 grams, so the actual weight difference from a normal corded setup is about 20 grams.

The Powerpacks are designed to avoid interfere with the hand as little as possible. The high capacity batteries allow about 5 hours of effective running under normal circumstances (the time can vary depending on setup).

Note! The Powerpack batteries will not take damage from constant charging or irregular charging cycles. Store the Powerpacks in the charger when not used.

Foot switch

The simple round design makes it easy to activate from all angles the electronics is designed with a magnetic switch which ensures optimal service life. Standard changeable button cell battery easy to replace by user, see Exchange of foot switch battery *on page 27*. The Foot switch (d.) communicates with the Main unit by radio for optimal reliability and performance.

Neorail

The Neorail (g.) should be used together with the supplied stand (h.) and USB cable (i.).

It is made to handle tattoo needles of type Neo-Cartridges. Neorail can handle up to six Neo-Cartridges. The Neo-Cartridges are held magnetically to the Neorail which makes it both hygienic and easy to work with. When used, it takes over the setting of voltage from the Powerpack(s) and each Neo-Cartridge have their own setting of voltage. Only one Neo-Cartridge can be used at a time and the rest should remain on the Neorail when working.

At every needle position on the Neorail there is a LED light. This light will change color depending on if the Neo-Cartridge is in place or not. White is working light, blue indicates that a Neo-Cartridge is in place and red indicates position for the Neo-Cartridge which is currently active.

Description

Charger

The charger is used together with the Main unit. It is connected to the Main unit and can charge two Powerpacks at a time.

Approvals

This product is approved and tested to the US requirements of the Federal Communications Commission, Title 47 Code of Federal Regulations Part 15 - Radio Frequency Devices.

The product also complies with the Europe requirements for CE-marking towards the RE-D Directive, 2014/53/EC

See Declaration of conformity in the end of the manual.

Identification labels

The product is labelled according to below;

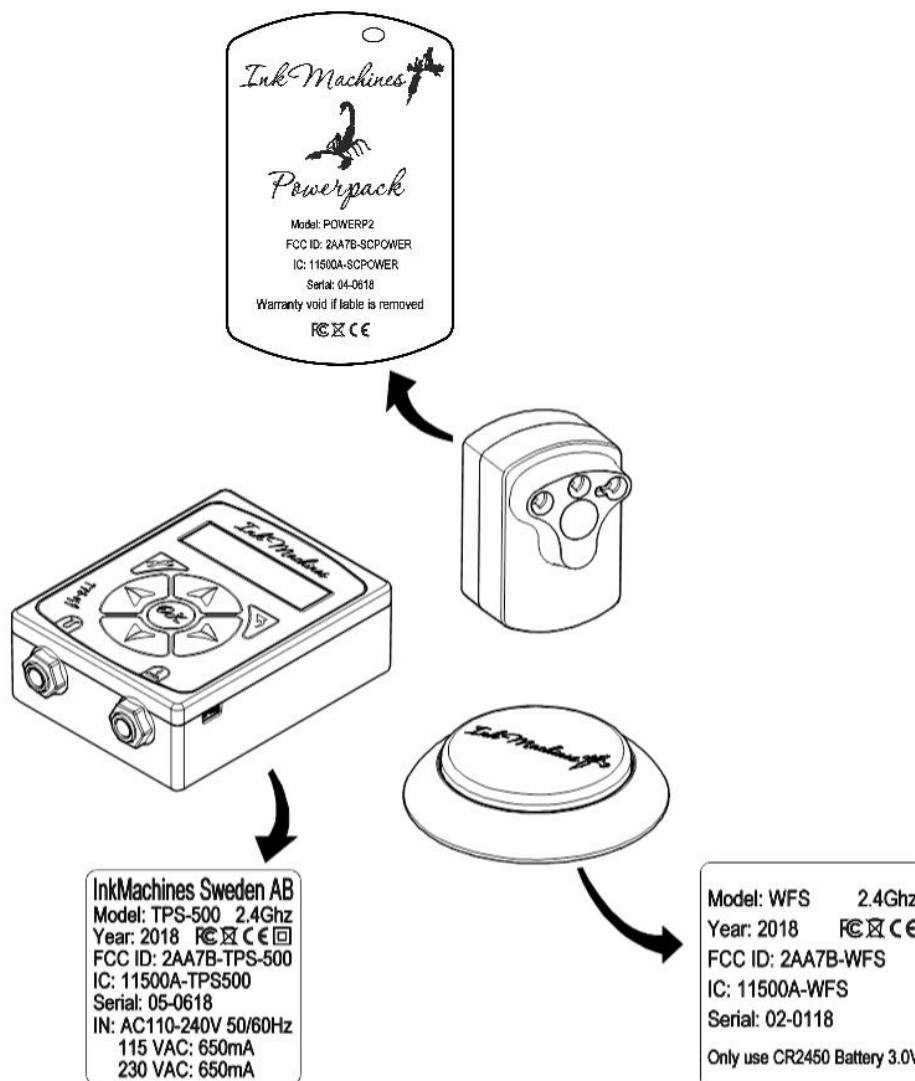

Safety

Regulations

Always follow local regulations concerning the tattoo operation. It is the operations responsibility to follow regulations and to provide a reliable environment for their customers.

The manufacturer does not have responsibility for any kind of material or personal damage or infection caused by the operation. Negligence or misuse of the machine or the components attached to the machine is the operations responsibility.

The manufacturer does not have responsibility for contamination or infection.

Product

To keep your product in good shape handle it with care!

The product should not under any circumstances come in direct contact with fluids. If fluids will get in contact with the electronic it can damage the product.

Do not connect any other power adapter than the ones intended to use with the *TPS-500* (see chapter Instruction on page 9).

Keep the product away from warm places.

Customer

InkMachines only provide products for professional tattoo artists and the product may only be used by professionals with knowledge about diseases and how to maintain a clean working environment and a sterile equipment.

Always use:

- sterile tubes, grips, tips and needles
- rubber gloves
- plastic bags and wraps for tattoo equipment; around the power supply and the machine with the Powerpack or the power cord

Always keep your equipment clean! See chapter Cleaning and hygienic on page 25 for further instruction.

Instruction

Delivery

When your package arrives please check that:

- there are no transport damages
- everything is delivered accordingly.

Unpacking



Note! Before unpacking make sure the area is cleaned!

Standard parts delivered:

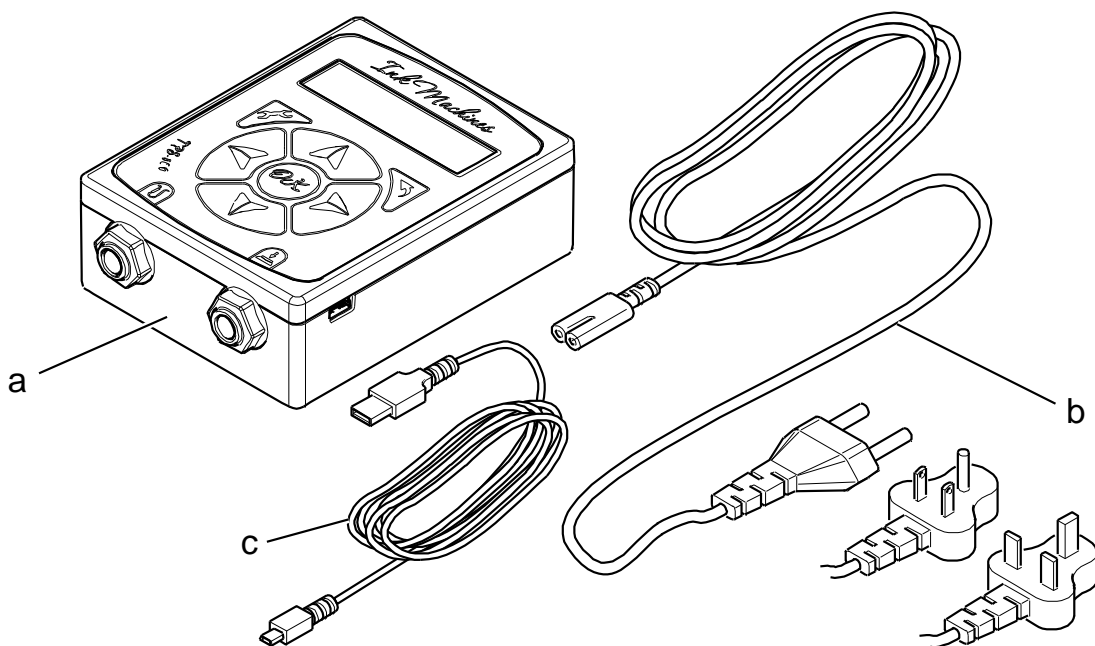

- a. 1 power supply (Main unit)
- b. 1 power cord
- c. 1 USB cable

Instruction

The following are optional to the power supply unit and may be included in the delivery.

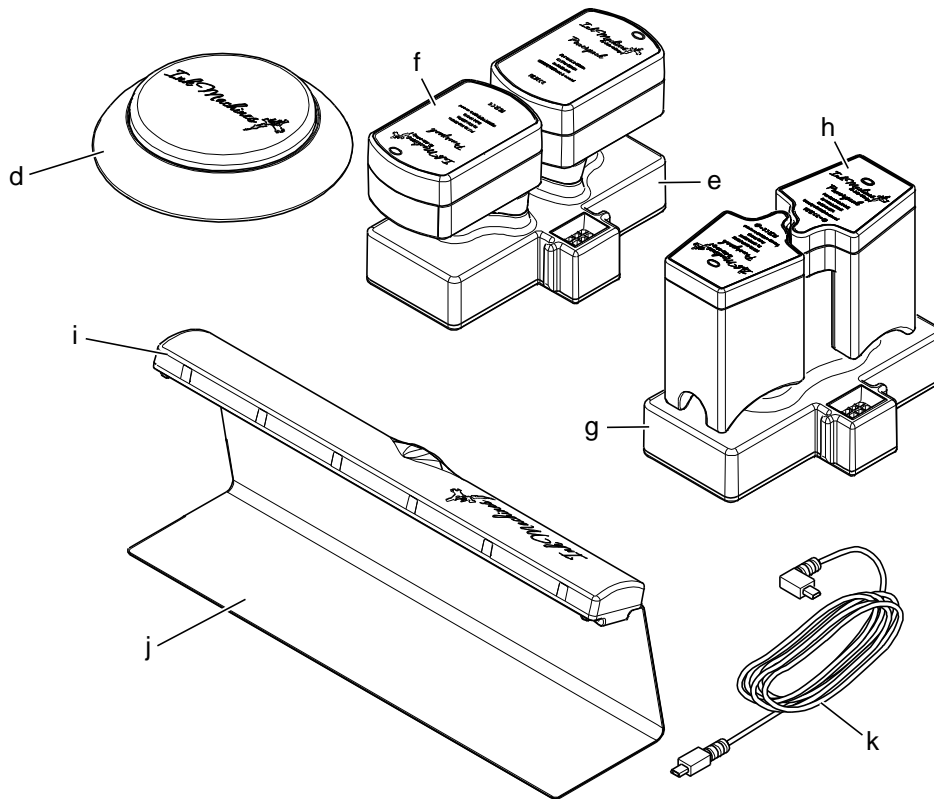

- | | | | |
|----|--|-------|---|
| d. | Footswitch | h. | Powerpack for Stingray and Dragonfly |
| e. | Charger for Scorpion | i./j. | Neorail with stand
(1 piece of USB cable for Neorail included in delivery) |
| f. | Powerpack for Scorpion | k. | USB cable for Neorail |
| g. | Charger for Stingray and Dragonfly | | |

Getting started

Caution! Make sure you have the right power cord for your country.

Note! The product is not equipped with a power on button.

To get the Powerpack and the tattoo machine up running follow the steps below:

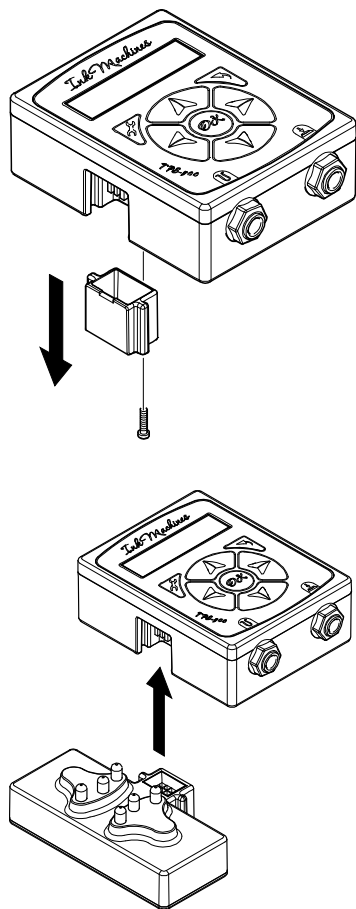

If powerpacks are to be used:

1. Remove the cover over the connection for the charger. Use a screwdriver, Torx T7, to remove the screw that holds the cover.

If powerpacks are to be used:

2. Connect the charger to the main unit.

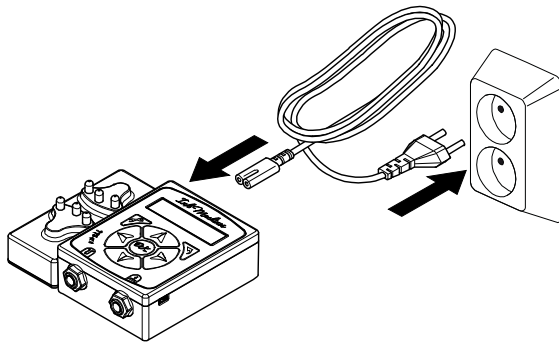

3. Connect the power cord to the main unit (see Connection on page 18) and to a regular wall power outlet.

Caution! The equipment must be installed near the socket outlet used. The socket outlet shall be easily accessible.



4. The display will power up. (Firmware version is displayed in the lower left corner.)

Note! UNIT UPDATE might be displayed in the lower part of the display at start up.

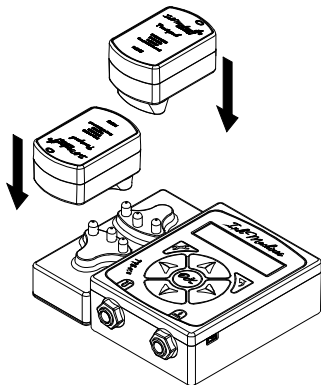

If powerpacks are to be used:

5. Place the Powerpacks on to the charger to begin the charging.

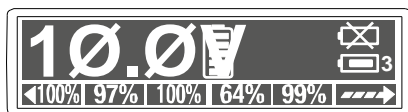

The appearance of the display when one Powerpack is placed in the charger

If powerpacks are to be used:

6. The charging begins. The Powerpacks will automatically pair to the main unit.

Note! It might take a couple of minutes for the correct charging to be displayed.

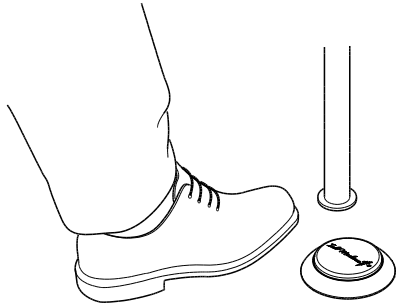

If foot switch is to be used:

- Place the foot switch on the floor, make sure you can reach it (make sure the foot switch is paired to the main unit, see page 23).

Note! Handle the foot switch with care, dont drop it on to the floor.



If powerpacks are used follow step 8 – 12, otherwise go direct to step 13:

- When charging is complete set up the tattoo machine(s) (for further instructions read the **Scorpion** manual).

9.

Note! Clean the Tattoo machine(s) before attaching the Powerpacks.

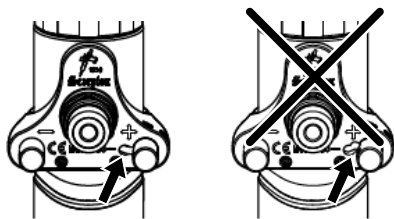
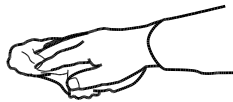

- Make sure the motor cable is in the right position or it can interfere with the Powerpack.

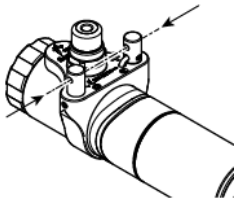

Motor cable position for Scorpion

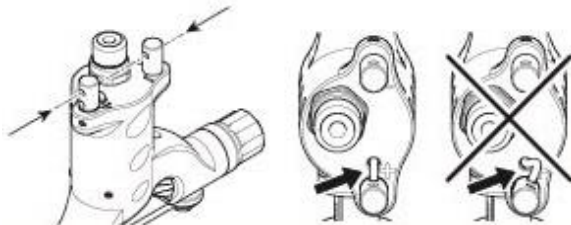

Motor cable position for Stingray and Dragonfly

- Connect the Powerpack to the tattoo

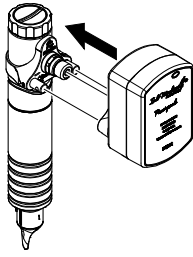

Tatto machine Scorpion

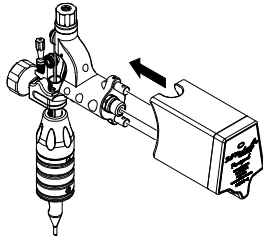

Tatto machine Stingray and Dragonfly

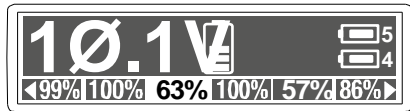
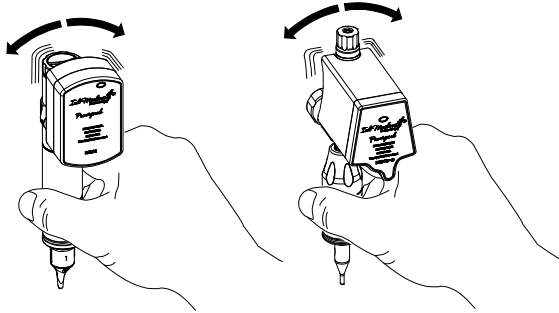

The image shows the display's appearance when Powerpack is used

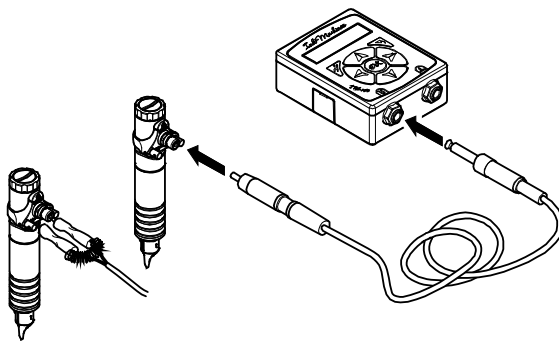

Connection of Scorpion to TPS-500

machine.

12. Activate the Powerpack (and the tattoo machine) by shaking it or giving it a gentle tilt. It is also possible to activate Powerpack manually by selecting active Powerpack with the arrows on the Control panel.

Note! This does not start the tattoo machine.

13. Charging status for the active Powerpack is highlighted on the display.

If RCA cable or clip cord are to be used:

14. The tattoo machine is connected as shown in the picture

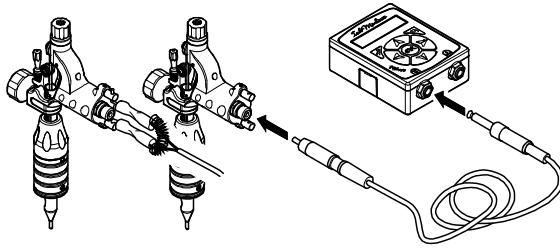

Connection of Stingray or Dragonfly to TPS-500

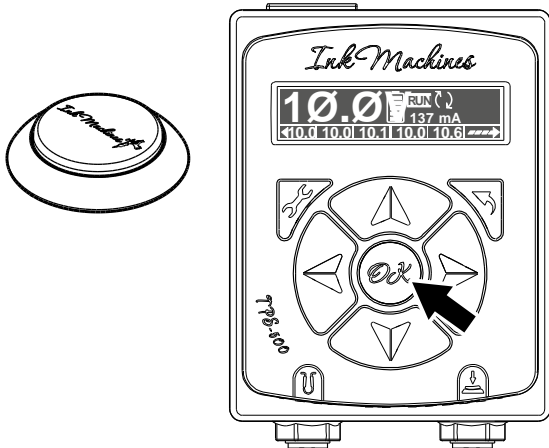

15. Start the machine with the foot switch (optional) or the OK button on the control panel (a symbol [RUN] is shown on the display).

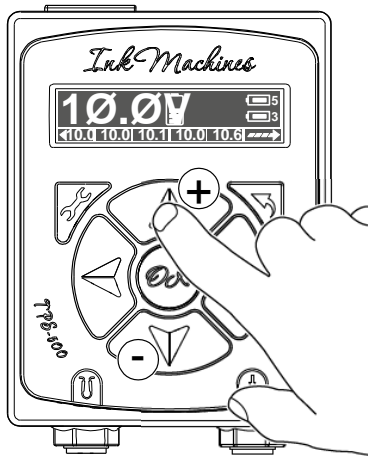

16. Set the voltage with the up (+) and down (-) arrow keys.



17. For additional settings see Settings on page 22.

If powerpacks are used follow step 17 – 18:

18. Repeat the steps 8-14 with up to 6 wireless machines with Powerpacks.

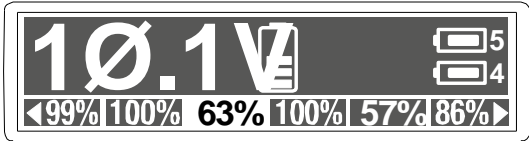

19. While working it is possible to charge two Powerpacks that are not in use.

The Neorail is only intended for use with Neo-Cartridge tattoo needle. To get the Neorail up running follow the steps below:

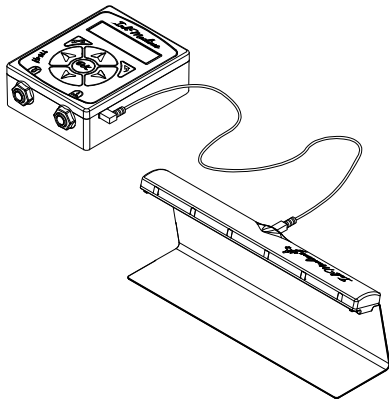

1. Connect the Neorail to the power supply unit with the supplied USB cable.



2. Prepare the Neorail as described in chapter Cleaning and hygienic on page 25
3. When Neorail is connected the appearance of the display on the main unit changes. In the lower row of the display the setting of voltage for each Neo-Cartridge (tattoo needle) is now displayed. The setting of voltage for active Neo-Cartridge is highlighted.
4. Each Neo-Cartridge has its own setting of voltage. This is changed with the arrow keys (up + or down -).

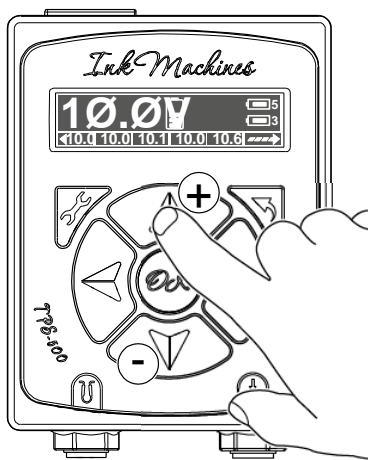

5. Just remove (and use) one Neo-Cartridge at a time from the Neorail.
6. To avoid cross-contamination when changing Neo-Cartridge – do not touch the part of the Neo-Cartridge which should be inserted into the tattoo machine.

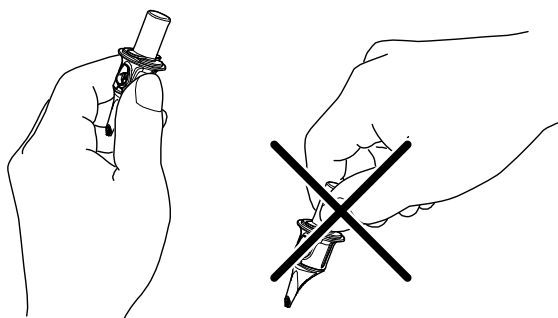

Connection

Wires

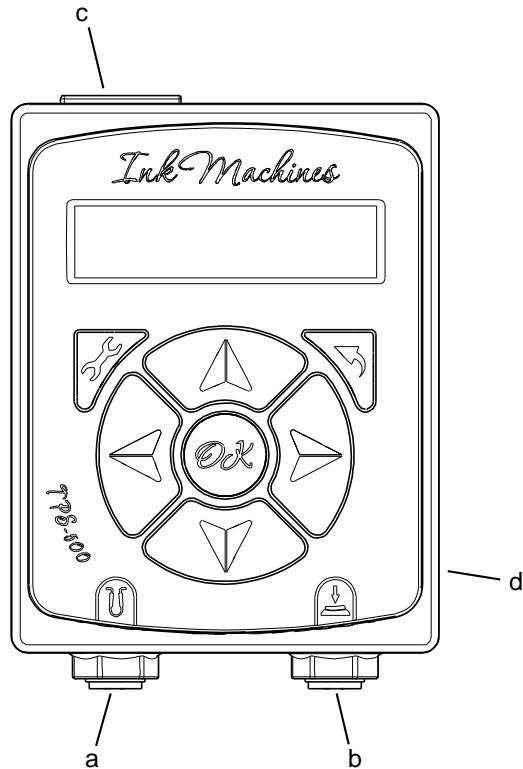

Connection point for;

- | | |
|---|--|
| a. tattoo machine, rotary and coil
(1/4" Phono Plug) | c. power cable (C7, 100 - 240V) |
| b. wired foot switch (1/4" Phono Plug) | d. Neorail (Only use the cable included in delivery
of Neorail)
Also for software updates. |

User interface

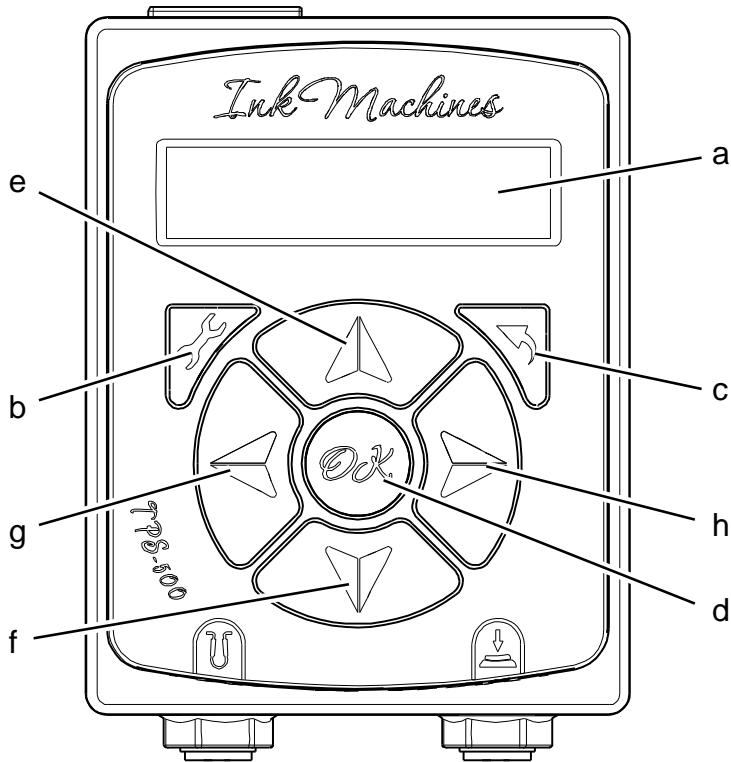

- | | | | |
|----|---------------------|-------|--|
| a. | Display, see below | d. | Start and stop tattoo machine/
Confirm selection |
| b. | Settings, see below | e./f. | Increase (e) and decrease (f) voltage to active
unit |
| c. | Return to main menu | g./h. | Navigate left (g) and right (h) between Timer
options and active Powerpacks |

Display

Start screen

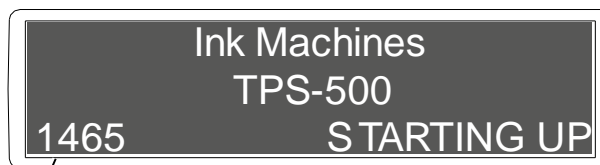

- a. Firmware version

Main screen

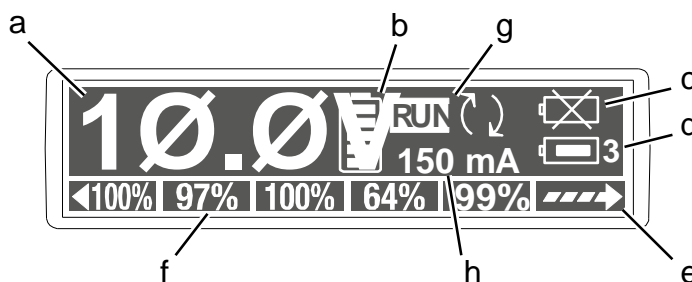

When Powerpack is used

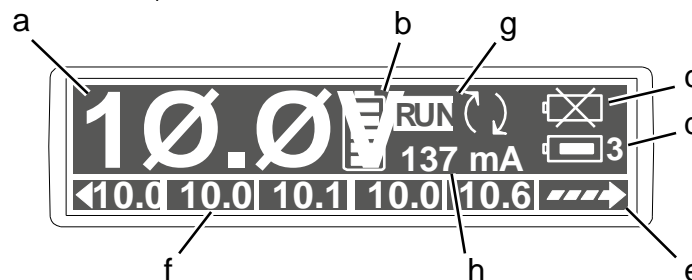

When Neorail is used

- a. Voltage for active Powerpack or cord connected
- b. Indicates that Powerpack is used. When cord is used this symbol  is shown.
- c./d. c – no Powerpack charging
d – Powerpack charging
- e. To timer menu (press right arrow key), see below
- f. When Powerpack is used: charging status in percent for each Powerpack paired to the Main unit
When Neorail is used: Voltage status for each Neo-Cartridge on the Neorail
- g. Symbol shown when the machine is running
- h. Current power consumption

Timer screen

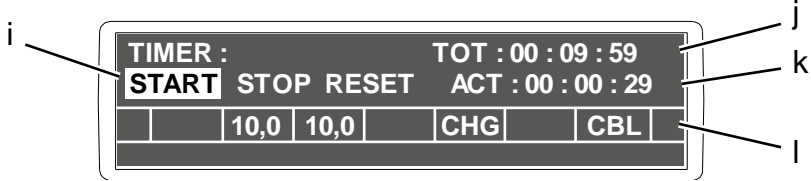

- i. Selections for the timer; START, STOP, RESET
- j. Total running time. Starts when a machine is activated for the first time and runs until sleep mode activates or manual stop / reset is selected
- k. Active time. Displays the time the machines have been running actively
- l. Line only appears when Neorail is used. Switches between showing voltage setting for active Neo-Cartridge and charging for active Powerpack.

Settings



Each Powerpack has its own individual settings. Choose Settings in the main menu and the below settings will be displayed. To move between Settings use the buttons with arrows on the Control panel.

Make sure that the Powerpack you want to change the settings for is the active one. The settings under ACTIVE will only apply for the active Powerpack. The ACTIVE settings also apply for the cable machine when selected as active on the main screen.

The settings under BASE are global.

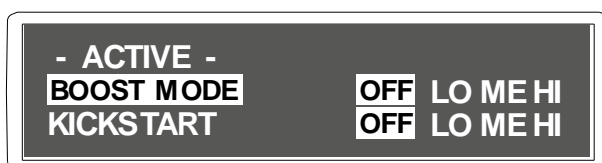

- ACTIVE -

BOOST MODE *	OFF, LO, ME, HI	Gives extra power when needed. Choose between Off, low, medium or high.
KICK START *	OFF, LO, ME, HI	Gives extra power to the tattoo machine at start up. Choose between Off, low, medium or high.

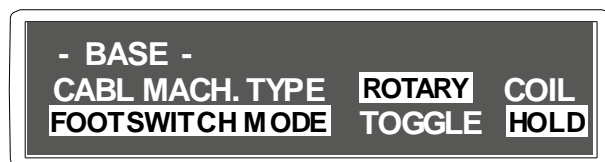

- BASE -

CABLE MACH. TYPE	ROTARY	COIL	Choose which type of machine you connect to the cable outlet for optimal usage.
FOOTSWITCH MODE	TOGGLE	HOLD	The machine is powered when pressing the pedal once. The machine is unpowered when pressing it again. Foot switch battery will last longer with this setting.
			The machine is powered only when the foot is held down. Battery change is needed more frequently with this setting.
BACKLIGHT			Display settings. Press the left and right arrow keys when selecting
CONTRAST			Display settings.

	Press the left and right arrow keys when selecting
PAIR FOOTSWITCH	Pair a foot switch to the Main unit (See page 23).
UNPAIR FOOTSWITCH	Unpair a foot switch from the Main unit (See page 23).
UNPAIR POWERPACKS	Unpair all Powerpacks from the Main unit. If there is interference in the communication between the units, it is possible to switch channel.
WIRELESS CHANNEL	Choose WIRELESS CHANNEL in the settings menu. Change channel with up and down keys. Active channel is shown on the display. After the channel have been changed should the powerpacks be placed in the charger.
NEORAIL	Setting of brightness for LED lights on Neorail (see page 5); RED; BLUE, WHITE

Pairing

The pairing function is essential, so the Main unit can provide the correct signals to the Active Powerpack and the correct Foot switch.

Powerpack

The Powerpacks will be paired automatically to the Main unit when they are set in the charger. Each Main unit can have 6 Powerpacks paired. The number of paired powerpacks will be shown on the lower part of the display.

It is possible to have several Main units in the room, then you will be able to borrow Powerpacks from other Main units.

The Powerpacks will automatically unpair from the "old" unit and pair to the "new" unit once the Powerpack is set in the charger of the "new unit".

Footswitch

The  running symbol(b) will be shown on the display when the foot switch is pressed and working properly.

To connect the foot switch, choose PAIR FOOTSWITCH from the Settings menu. There will be 3 activities to perform/accept on the Main unit before the Footswitch is paired. Chose OK to continue or Back(j) to abort.

Note! Make sure no other footswitch is being used during pairing!

PLEASE PRESS 5 TIMES FAST
ON THE FOOT SWITCH
BEFORE THE TIMER REACHES 0.

TIME LEFT 12 SECS

Unpairing a foot switch can be useful if the same foot switch has been paired to 2 or several main units. After unpairing the unit will no longer respond to that foot switch unless it's manually paired again.

To unpair the foot switch, select UNPAIR FOOTSWITCH from the Settings menu.

Active Powerpack

To control and view the correct status/ settings of the Powerpack you want to work with, you need to make the Powerpack active.

Make Powerpack active;

- tilt or shake the Powerpack, this will send a signal to the paired Main unit to make the Powerpack active.
- use the arrow keys on the User interface Control panel to manually select which Powerpack that should be active. The Active Powerpack will be highlighted on the display.

Run mode settings for Powerpack and Rotary mode for cable

Kick Start

The Kick start gives extra power to the Tattoo Machine at start up. This could be useful if the machine is equipped with extra features and the standard voltage is not enough for the start up. There are 4 levels; OFF, LOW, MEDIUM and HIGH.

When using Neo-Cartridges there is no need to use Kick start.

Note! Only use this feature if necessary, it will increase wear!

Boost mode

The Boost mode will increase your machines power considerable. It will enable the machine to keep the same speed when the workload is increasing. Depending on your setup this feature can be very useful. There are 4 levels; OFF, LOW, MEDIUM and HIGH.

Note! The speed may vary when the machine is started

Note! Only use this feature if necessary, it will increase wear!

Run mode display window for Coil machines

Speed(CPS)

The speed of the machine is displayed as CPS, the cycles per second in Hz.

Duty cycle(DUTY)

The duty cycle is displayed as DUTY in %, it is calculated as the contact time.

Cleaning and hygienic

Cleaning

Caution! Never spray or pour fluids directly on any of the units, it can cause short circuit and will void the warranty.

It is  important for the tattoo operation to keep a clean and hygienic environment to avoid infection.

Do NOT use alkaline or acid cleaning agents with strong bases (high or low pH). Only use pH neutral cleaning agents and alcohol disinfectants. Use a dampened piece of paper or cloth to gently wipe off surfaces of the units.

Foot switch

Clean the Foot switch outside and inside to eliminate dirt and deposits as it could affect the function of the Foot switch. Clean about 4 times a year depending on workload.

Dismount the foot switch, see Exchange of foot switch battery on page 27. Use a dampened piece of paper or cloth and gently wipe it off.

Preparation



Prepare all the tattoo machines before starting your session. Always clean the tattoo machine according to their manuals before attaching the TPS-500 Powerpacks.

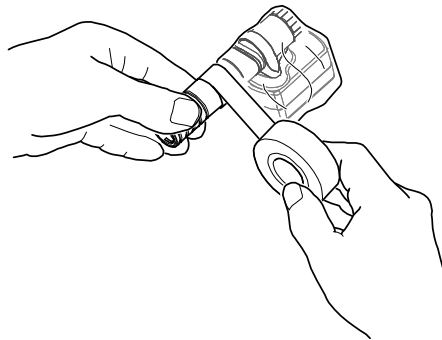

All the touching normally takes place on the Main unit during the session so there is no need to touch the Powerpacks during the session. To avoid contamination of the User interface (display and Control panel), wrap up the user interface with plastic film before starting your session.

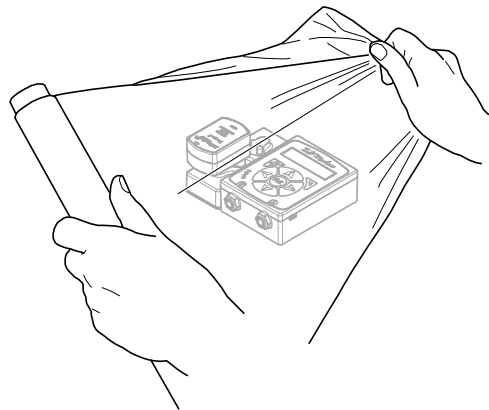

Cleaning and hygienic

When using Neorail start with attaching the Neorail on the table with tape.

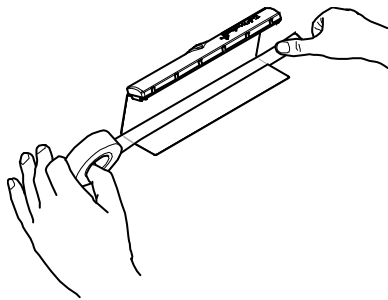

After that, wrap the Neorail with plastic film.

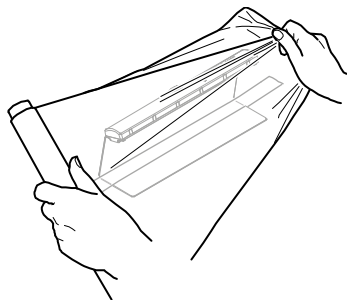

Put the Neo-Cartridges on the Neorail.

Service and maintenance

Self-service and repairing of the *TPS-500* and/or any of its units are prohibited and the warranty will be void if any unit has been opened or manipulated. The only exception is cleaning of the Foot switch, replacement of the battery in the Foot switch and resetting the Powerpack.

For service and repair visit www.inkmachines.com.

Caution! Changes or modifications not approved by the manufacturer could void the user's authority to operate the product.

Software upgrades

For information about Software upgrades check www.inkmachines.com.

The current software version will be displayed in the left corner at start-up of the Main unit.

Exchange of foot switch battery

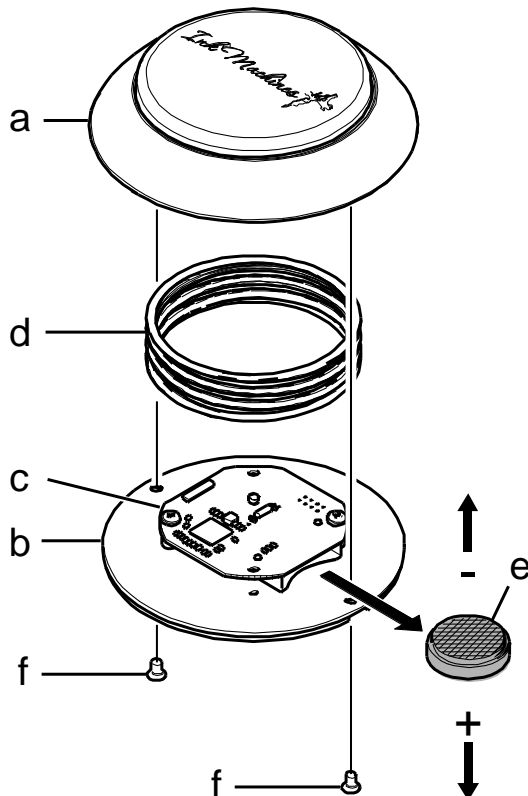

The foot switch is equipped with a CR2450 battery. To exchange the battery, you need to dismount the unit. The foot switch consists of:

- a. Upside cover
- b. Bottom plate
- c. Electrical board
- d. Spring
- e. Battery
- f. Screw

Exchange the battery according to below instruction.



1. Clean the foot switch before dismounting the unit. When the unit is opened also clean it inside, but do not use liquid near the electrical board.
2. Release the two screws(f) located on the bottom plate(b) of the foot switch. Use a screw driver to release the screws.

Caution! Be careful not to damage the electrical board!

Note! Do not remove the electrical board!

3. The battery(e) is located beneath the electrical board(c). Use a tool to push the battery from the backside.
 4. Attach the new battery.
-

Note! Make sure the battery is placed with the positive terminal (+) facing away from the circuit board.

5. Reattach the bottom plate(b) to the spring(d) and upside cover(a) by mounting the unit upside down.
 6. Attach the two screws(f).
 7. Test that the foot switch is working. Pairing is not needed after battery change.
-

Reset Powerpack

If you encounter problems with your Powerpack and you have gone through the Troubleshooting guide, see page 30, then reset the Powerpack according to the instruction below.

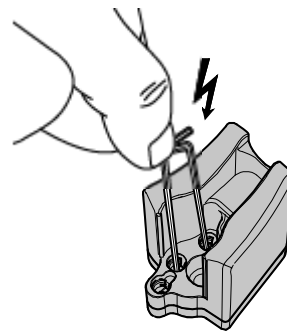
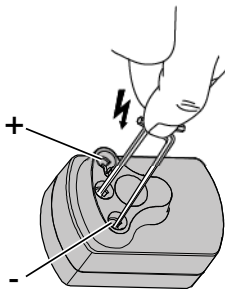

1. Make a hard reset by short circuiting the battery. Use a metal clip or similar to connect the middle and the negative connection points on the Powerpack, see figure up of.
-

Note! Do not get alarmed if there is a spark from the unit.

2. The indication light on the Powerpack will extinguish if lit
3. Put the Powerpack on the charger again and it will be reset and repaired to the Main unit.
4. After charging connect the Powerpack to the Tattoo machine.

5. If you still encounter problems contact InkMachines, see www.inkmachines.com.

Waste

The manufacturing company is responsible for disposal of the Product. To avoid environment pollution and human injury follow local regulation concerning waste of electronic products.

This product contains rechargeable and not rechargeable batteries. In the interest of protecting the environment and human health, please send the rechargeable batteries back to the manufacturer for exchange and follow local regulations concerning waste of batteries.

The
other



symbol indicates that the product and its electronic accessories is not to be disposed with house hold waste.

Trouble shooting

Check the following steps if you encounter problems.

Trouble shoot by excluding the different parts Tattoo machine, Powerpack and Footswitch

The Tattoo machine

Always check that the contact surface is clean from dirt.

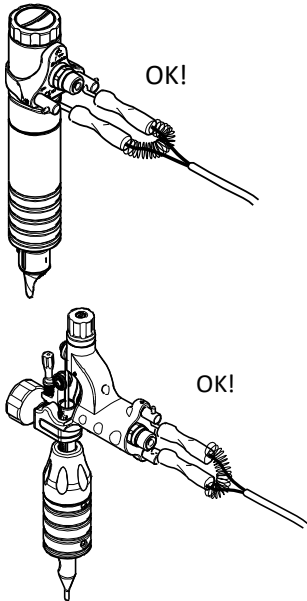
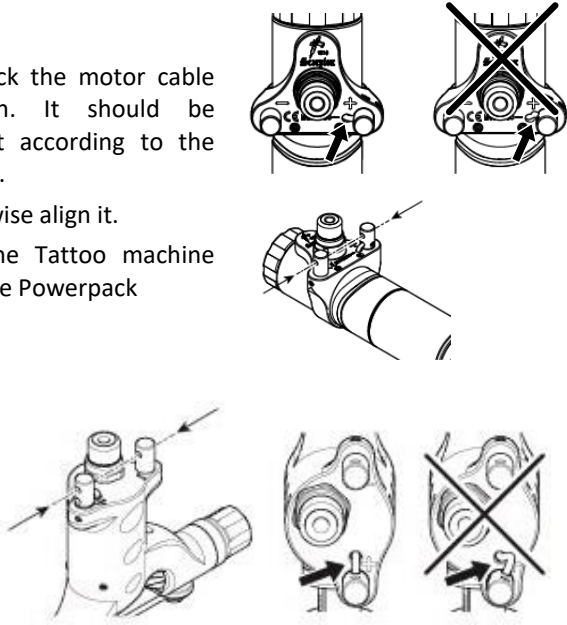
Instruction	If the Tattoo machine still not functioning
<p>1. Check that the clipcord binding positions is ok. Test the machine with a clip cord and make sure the machine is working properly.</p> 	<p>The Clipcord connection or the Clipcord does not work. Try with another clipcord. Still does not work Consult the machines manual. Go to 2.</p>
<p>2. Check the motor cable location. It should be straight according to the picture. Otherwise align it. Test the Tattoo machine with the Powerpack</p> 	<p>Shake to make it active. Check the Powerpack trouble shooting.</p>

The Powerpack

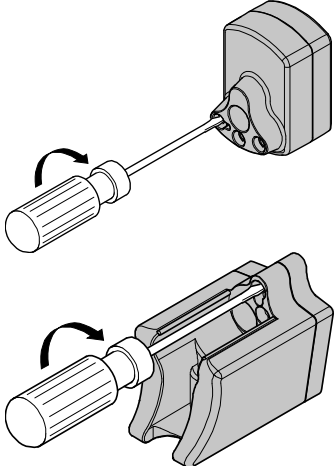
Instruction	If the Powerpack still not functioning with the Tattoo machine
<p>1. Check that the Powerpack is activated on the display. If not, tilt the Tattoo machine or select the Powerpack manually with the arrow keys on the main unit.</p>	Go to 2.
<p>2. Check on the display that the Powerpack is charged and that the Indication light is lit or pulsing on the Powerpack. Otherwise charge the unit.</p>	Go to 3.
<p>3. Unpair the Powerpack from the Main unit by selecting the choice from the settings menu. Put the Powerpack in the charger again to Pair it to the Main unit.</p>	Go to 4.
<p>4. Tighten the connections on the Powerpack.</p> 	Go to 5.
<p>5. Reset the Powerpack, see <i>page 28</i>.</p>	<p>Contact InkMachines for further instructions, see www.inkmachines.com</p>

The Foot switch

Start with using the OK-button on the Control panel to see if the Tattoo machine is working ok.

Instruction	If the Footswitch still not functioning with the Tattoo machine
<p>1. Check that the Foot switch is paired with the Main unit. The running symbol will be shown on the display when the foot switch is pressed down.</p> 	Go to 2.
<p>2. PAIR FOOTSWITCH from the settings menu.</p>	Go to 3.
<p>3. Check that the Footswitch battery is placed with the positive terminal (+) facing down, see Exchange of foot switch battery on page 27.</p>	Go to 4.
<p>4. Check that the Foot switch is cleaned and that there is no left dirt that could affect the function.</p>	Go to 5.
<p>5. Exchange battery, it may be discharged or bad.</p>	Something wrong with the footswitch, Contact InkMachines for further instructions, see www.inkmachines.com .

Technical specification

Main unit, *TPS-500* ©

Volt output	5 - 13 Volt DC
Power input	100 – 240 V AC
Frequency	2.4 GHz
Machine compatibility	<i>Scorpion</i> , <i>Stingray</i> and <i>Dragonfly</i> wireless and other machines by cable
Display	LCD 55 x 13 mm
Charger capacity	2 Powerpacks simultaneous charging
Connections:	¼" Phono for various wired tattoo machines 5 - 13 V
	¼" Phono for wired foot switch
	USB for software upgrades and for Neorail
	C7 power connection
Operating temperature	10 – 35 °C Indoor use only.
Weight	260 grams (main unit only)
Dimensions L x W x H	108 x 78 x 36 mm

Powerpack for *Scorpion* ©

Volt output	5 - 13 Volt DC
Frequency	2.4 GHz
Machine Compatibility	<i>Scorpion</i>
Battery capacity	Up to 5 hours. Depending on setup
Sensors	Accelerometer for activation
Operating temperature	10 – 35 °C Indoor use only.
Weight	70 grams
Dimensions L x W x H	56 x 37 x 34 mm

Powerpack for *Stingray* and *Dragonfly* ©

Volt output	5 - 13 Volt DC
Frequency	2.4 GHz
Machine Compatibility	<i>Stingray</i> and <i>Dragonfly</i>
Battery capacity	Up to 5 hours. Depending on setup
Sensors	Accelerometer for activation
Operating temperature	10 – 35 °C Indoor use only.
Weight	65 grams
Dimensions L x W x H	62 x 40 x 50 mm

Foot switch WFS ©

Battery	CR2450 3 V 620 mAh
Frequency	2.4 GHz
Battery	CR2450
Operating temperature	10 – 35 °C Indoor use only.
Weight	240 grams
Dimensions L x W x H	100 x 100 x 25 mm

Declaration of Conformity FCC

Per: 47 Code of Federal Regulations Part 15 - Radio Frequency Devices. This device complies with part 15 of the FCC Rules. Operation is subject to the following two conditions: (1) This device may not cause harmful interference, and (2) this device must accept any interference received, including interference that may cause undesired operation



**Federal
Communications
Commission**

We, the responsible party:

Company Name:	InkMachines Sweden AB (US rep. importer)
Address:	Grusåsvägen 8 352 45 VÄXJÖ, Sweden
Phone:	+46 470 244 03

declares that the product;

Type of equipment:	Wireless power supply for Tattoo Machines
Model / Name:	TPS-500

Was tested to confirm to the app. FCC rules and regulations. Testing was carried out by a listed facility of the FCC in accordance with the facility's registration.

Certification Summary;

Requirements tested:	FCC 47 CFR Part 15 Subpart C
Report Number:	3P07356-F15C
Tested by:	RISE Research Institutes of Sweden

Date of issue:	2018-
----------------	-------

Signed:

Name:

Title of Authority: CEO

RE-D Declaration of Conformity (DoC)

We;

Name	InkMachines Sweden AB
Address	Grusåsvägen 8 352 45 VÄXJÖ, Sweden

declare under our sole responsibility that the product;

Product name /model:	TPS-500 incl. WFS and Powerpack
Type:	Wireless power supply for Tattoo Machines

to which this declaration relates is in conformity with the essential requirements and other relevant requirements of the RE-D Directive (2014/53/EU). The product is in conformity with the following standards and/or other normative documents;

HEALTH & SAFETY (Art. 3(1)(a)):	EN 60950-1:2006 (2 nd Edition) /A1:2010/ A11:2009/A12:2011/A2:2013/AC1:2011
EMC (Art. 3(1)(b))	EN 301 489-1 2.1.1 / EN 301 489-17 V3.1.1 (assessed in conjunction with ITE standards EN 55032 and EN 55024 as Class B equipment)
SPECTRUM (Art. 3(2))	EN 300 328 V2.1.1

Place and date of issue (of this DoC):	2018-
--	-------

Signed by:

Name:

Title of Authority:

CEO

Warranty

This product includes a 12 months warranty from the date of purchase. The warranty applies to factory faults and not to wear of any components caused by normal or abnormal use.

If this product becomes defective during the Warranty period, InkMachines shall have the option, in its sole discretion, to either repair the product or replace the product. Shipping costs to repair destination is not covered.

The warranty is void if:

1. The *TPS-500* user interface, main unit or Powepacks has been opened.
2. The *TPS-500* or any of its units or components have been autoclaved or cleaned in an ultrasonic cleaner.
3. Powerpacks have been used on any other machine brand than InkMachines.
4. Components have been damaged by misuse or carelessness.
5. Components have been manipulated.
6. Alkaline or acid cleaning agents with strong bases (high or low pH) have been used on the products.
7. If fluids have been dripped or sprayed on the units.

InkMachines entire aggregate liability for losses and damages for any cause related to or arising out of the purchase and/or use of the product will in no event exceed the purchase price paid for the product. In no event will InkMachines be liable: (a) any indirect, special, incidental, consequential or punitive loss or damage, or other economic loss of any kind, in any case, even if advised of, or if InkMachines could reasonably foresee, the possibility thereof. The limitations, exclusions and disclaimers in this agreement shall apply irrespective of the nature of the cause of action, demand, or proceeding including but not limited to, breach of contract, negligence, tort, strict liability or any legal or equitable theory

Electromagnetic compatibility

US Federal Communications Commission 47 part 15 of the FCC Rules

This device complies with part 15 of the FCC Rules. Operation is subject to the following two conditions:

- (1) this device may not cause harmful interference, and
- (2) this device must accept any interference received, including interference that may cause undesired operation.

Note!

This equipment has been tested and found to comply with the limits for a Class B digital device, pursuant to part 15 of the FCC Rules. These limits are designed to provide reasonable protection against harmful interference in a residential installation. This equipment generates, uses and can radiate radio frequency energy and, if not installed and used in accordance with the instructions, may cause harmful interference to radio communications. However, there is no guarantee that interference will not occur in a particular installation. If this equipment does cause harmful interference to radio or television reception, which can be determined by turning the equipment off and on, the user is encouraged to try to correct the interference by one or more of the following measures:

- Reorient or relocate the receiving antenna.
- Increase the separation between the equipment and receiver.
- Connect the equipment into an outlet on a circuit different from that to which the receiver is connected.
- Consult the dealer for help.

Industry Canada licence exempt RSS standard

This device complies with Industry Canada licence exempt RSS standard(s). Operation is subject to the following two conditions:

- (1) this device may not cause interference, and
- (2) this device must accept any interference, including interference that may cause undesired operation of the device.

Le présent appareil est conforme aux CNR d'Industrie Canada applicables aux appareils radio exempts de licence. L'exploitation est autorisée aux deux conditions suivantes :

- (1) l'appareil ne doit pas produire de brouillage, et
- (2) l'appareil doit accepter tout brouillage radioélectrique subi, même si le brouillage est susceptible d'en compromettre le fonctionnement.