



Shenzhen CTL Electromagnetic Technology Co., Ltd.
Tel: +86-755-89486194 Fax: +86-755-89486194-805

FCC PART 15 SUBPART C TEST REPORT

Report Reference No......: **CTL1308301369-WF**

Compiled by

(position+printed name+signature) .: File administrators Jacky Chen

Jacky Chen

Name of the organization performing the tests

Test Engineer Tracy Qi

Tracy Qi

(position+printed name+signature) .:

Approved by

(position+printed name+signature) .: Manager Tracy Qi

Tracy Qi

Date of issue.....: Sept. 06, 2013

Representative Laboratory Name .: **Shenzhen CTL Electromagnetic Technology Co., Ltd.**

Address: Floor 1-A, Baisha Technology Park, No.3011, Shahexi Road, Nanshan District, Shenzhen, China 518055

Test Firm: **Bontek Compliance Testing Laboratory Ltd**

Address: 1/F, Block East H-3, OCT Eastern Ind. Zone, Qiaocheng East Road, Nanshan, Shenzhen, China

Applicant's name.....: **CaptionCall, LLC**

Address: 4215 South Riverboat Road, Salt Lake City, UTAH 84020. USA.

Test specification:

Standard: FCC Part 15.247: Operation within the bands 902–928 MHz, 2400–2483.5 MHz, and 5725–5850 MHz.

TRF Originator.....: Shenzhen CTL Electromagnetic Technology Co., Ltd.

Master TRF.....: Dated 2011-01

Shenzhen CTL Electromagnetic Technology Co., Ltd. All rights reserved.

This publication may be reproduced in whole or in part for non-commercial purposes as long as the Shenzhen CTL Electromagnetic Technology Co., Ltd. is acknowledged as copyright owner and source of the material. Shenzhen CTL Electromagnetic Technology Co., Ltd. takes no responsibility for and will not assume liability for damages resulting from the reader's interpretation of the reproduced material due to its placement and context.

Test item description: **Router**

FCC ID.....: **2AA6ZCR1**

Trade Mark: N/A

Model/Type reference: CR1

Work frequency: 802.11b/g/n(20MHz): 2412~2462MHz

802.11n(40MHz): 2422~2452

Type of modulation.....: 802.11b DSSS, 802.11g/n: OFDM

Data Rate: 802.11b: 1/2/5.5/11 Mbps

802.11g: 6/9/12/18/24/36/48/54 Mbps, 802.11n: up to 150 Mbps

Antenna Gain: 2dBi

Antenna type: Undetachable

Result: **Positive**

TEST REPORT

Test Report No. :	CTL1308301369-WF	Sept. 06, 2013
		Date of issue

Equipment under Test : **Router**

Model /Type : **CR1**

Applicant : **CaptionCall, LLC**

Address : 4215 South Riverboat Road, Salt Lake City, UTAH 84020.
USA.

Manufacturer : **SHENZHEN MTN ELECTRONICS CO.,LTD.**

Address : MTN Industrial Park, NO.3 Fuhua Road, Pingxi Neighborhood,
Longgang District, Shenzhen, China

Test Result according to the standards on page 4:	Positive
--	-----------------

The test report merely corresponds to the test sample.
It is not permitted to copy extracts of these test result without the written permission of the test laboratory.



Contents

1.	<u>TEST STANDARDS</u>	<u>4</u>
2.	<u>SUMMARY</u>	<u>5</u>
2.1.	General Remarks	5
2.2.	Equipment Under Test	5
2.3.	Short description of the Equipment under Test (EUT)	5
2.4.	EUT operation mode	5
2.5.	EUT configuration	6
2.6.	NOTE	6
2.7.	Related Submittal(s) / Grant (s)	6
2.8.	Modifications	6
3.	<u>TEST ENVIRONMENT</u>	<u>7</u>
3.1.	Address of the test laboratory	7
3.2.	Test Facility	7
3.3.	Environmental conditions	7
3.4.	Configuration of Tested System	7
3.5.	Statement of the measurement uncertainty	8
3.6.	Equipments Used during the Test	9
3.7.	Summary of Test Result	10
4.	<u>TEST CONDITIONS AND RESULTS</u>	<u>11</u>
4.1.	Conducted Emissions Test	11
4.2.	Radiated Emission Test	14
4.3.	6dB Bandwidth Measurement	20
4.4.	Maximum Peak Output Power	29
4.5.	Band Edge Measurement	31
4.6.	Power Spectral Density Measurement	48
4.7.	Spurious RF Conducted Emission	57
4.8.	Operation Frequency Range of 20dB Bandwidth	65
4.9.	Antenna Requirement	70
5.	<u>TEST SETUP PHOTOS OF THE EUT</u>	<u>71</u>
6.	<u>EXTERNAL AND INTERNAL PHOTOS OF THE EUT</u>	<u>73</u>

1. TEST STANDARDS

The tests were performed according to following standards:

[FCC Part 15.247](#): Frequency Hopping, Direct Spread Spectrum and Hybrid Systems that are in operation within the bands of 902-928 MHz, 2400-2483.5 MHz, and 5725-5850 MHz.

[ANSI C63.10-2009](#): American National Standard for Testing Unlicensed Wireless Devices.

[ANSI C63.4-2003](#)

[KDB Publication No. 558074 D01 v03r01 Guidance on Measurements for Digital Transmission Systems](#)



2. SUMMARY

2.1. General Remarks

Date of receipt of test sample	:	Aug. 30, 2013
Testing commenced on	:	Aug. 30, 2013
Testing concluded on	:	Sept. 06, 2013

2.2. Equipment Under Test

Power supply system utilised

Power supply voltage	:	<input checked="" type="radio"/> 120V / 60 Hz	<input type="radio"/> 115V / 60Hz
		<input type="radio"/> 12 V DC	<input type="radio"/> 24 V DC
		<input type="radio"/> Other (specified in blank below)	

Description of the test mode

IEEE 802.11b/g/n: Thirteen channels are provided to the EUT, but only eleventh channels used for USA.

Channel	Frequency(MHz)	Channel	Frequency(MHz)
1	2412	8	2447
2	2417	9	2452
3	2422	10	2457
4	2427	11	2462
5	2432		
6	2437		
7	2442		

2.3. Short description of the Equipment under Test (EUT)

A Router support wifi function.

For more details, refer to the user's manual of the EUT.

Serial number: Prototype

2.4. EUT operation mode

Test Mode:

1. The EUT has been tested under normal operating condition.
2. Test program used to control the EUT for staying in continuous transmitting and receiving mode is programmed. Channel low (2412MHz), mid (2442MHz) and high (2462MHz) with highest data rate are chosen for full testing.
3. Test Mode:

Test Mode(TM)	Description	Remark
1	Transmitting	802.11 b
2	Transmitting	802.11 g
3	Transmitting	802.11 n HT20
4	Transmitting	802.11 n HT40

2.5. EUT configuration

The following peripheral devices and interface cables were connected during the measurement:

○ - supplied by the manufacturer

● - supplied by the lab

● Notebook PC

Manufacturer : HP

Model No. : 4-1007TX

2.6. NOTE

1. The EUT is an 802.11b/g/n Tablet PC, The functions of the EUT listed as below:

	Test Standards	Reference Report
WLAN 802.11b/g, 802.11n	FCC Part 15 Subpart C (Section15.247)	CTL1308301369-WF

2. The frequency bands used in this EUT are listed as follows:

Frequency Band(MHz)	2400-2483.5	5150-5350	5470-5725	5725-5850
802.11b	√	—	—	—
802.11g	√	—	—	—
802.11n(20MHz)	√	—	—	—
802.11n(40MHz)	√	—	—	—

3. The EUT incorporates a SISO function, Physically, the EUT provides two completed transmitter and two completed receivers.

Modulation Mode	TX Function
802.11b	1TX
802.11g	1TX
802.11n (20MHz)	1TX
802.11n (40MHz)	1TX

2.7. Related Submittal(s) / Grant (s)

This submittal(s) (test report) is intended for FCC ID: 2AA6ZCR1 filing to comply with of the FCC Part 15.247 Rules.

2.8. Modifications

No modifications were implemented to meet testing criteria.

3. TEST ENVIRONMENT

3.1. Address of the test laboratory

Bontek Compliance Testing Laboratory Ltd
 1/F, Block East H-3, OCT Eastern Ind. Zone, Qiaocheng East Road, Nanshan, Shenzhen, China

The sites are constructed in conformance with the requirements of ANSI C63.7, ANSI C63.4 (2003) and CISPR Publication 22.

3.2. Test Facility

The test facility is recognized, certified, or accredited by the following organizations:

IC Registration No.: 7631A

The 3m alternate test site of Bontek Compliance Testing Laboratory Ltd EMC Laboratory has been registered by Certification and Engineer Bureau of Industry Canada for the performance of with Registration NO.: 7631A on March, 2011.

FCC-Registration No.: 338263

Bontek Compliance Testing Laboratory Ltd EMC Laboratory has been registered and fully described in a report filed with the (FCC) Federal Communications Commission. The acceptance letter from the FCC is maintained in our files. Registration 338263, March 24, 2008.

3.3. Environmental conditions

During the measurement the environmental conditions were within the listed ranges:

- Temperature: 15-35 ° C
- Humidity: 30-60 %
- Atmospheric pressure: 950-1050mbar

3.4. Configuration of Tested System

Fig. 2-1 Configuration of Tested System

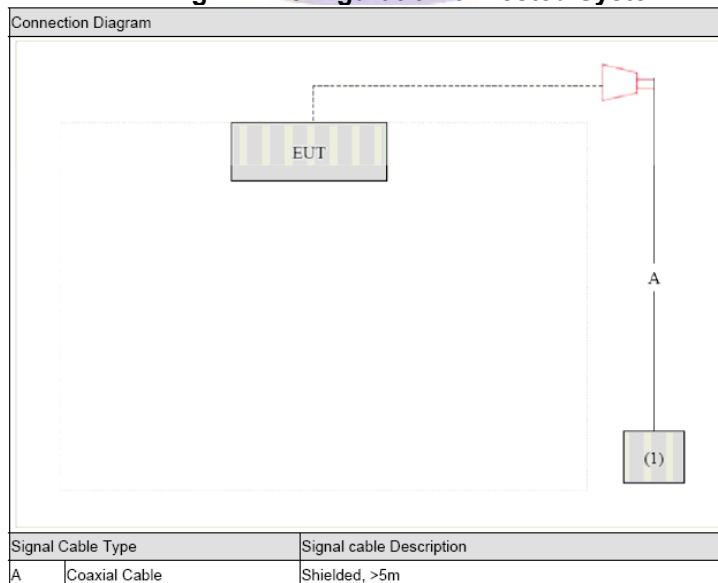

3.5. Statement of the measurement uncertainty

The data and results referenced in this document are true and accurate. The reader is cautioned that there may be errors within the calibration limits of the equipment and facilities. The measurement uncertainty was calculated for all measurements listed in this test report acc. to CISPR 16 - 4 „Specification for radio disturbance and immunity measuring apparatus and methods – Part 4: Uncertainty in EMC Measurements“ and is documented in the Bontek Compliance Testing Laboratory Ltd quality system acc. to DIN EN ISO/IEC 17025. Furthermore, component and process variability of devices similar to that tested may result in additional deviation. The manufacturer has the sole responsibility of continued compliance of the device.

Hereafter the best measurement capability for Bontek laboratory is reported:

Test	Range	Measurement Uncertainty	Notes
Radiated Emission	30~1000MHz	4.10dB	(1)
Radiated Emission	Above 1GHz	4.32dB	(1)
Conducted Disturbance	0.15~30MHz	3.20dB	(1)

- (1) This uncertainty represents an expanded uncertainty expressed at approximately the 95% confidence level using a coverage factor of k=2.



3.6. Equipments Used during the Test

Item	Test Equipment	Manufacturer	Model No.	Last Cal.	Due. Date
1	EMI Test Receiver	ROHDE & SCHWARZ	ESCI	2013/04/14	2014/04/13
2	Radio Communication Tester	ROHDE & SCHWARZ	CMU200	2013/04/14	2014/04/13
3	Dual Directional Coupler	Agilent	778D	2013/04/14	2014/04/13
4	10dB attenuator	SCHWARZBECK	MTAIMP-136	2013/04/14	2014/04/13
5	Tunable Bandreject filter	K&L	3TNF-800	2013/04/14	2014/04/13
6	Tunable Bandreject filter	K&L	5TNF-1700	2013/04/14	2014/04/13
7	High-Pass Filter	K&L	9SH10-2700/X12750-O/O	2013/04/14	2014/04/13
8	High-Pass Filter	K&L	41H10-1375/U12750-O/O	2013/04/14	2014/04/13
9	Coaxial Cable	Huber+Suhner	AC4-RF-H	2013/04/14	2014/04/13
10	AC Power Supply	IDRC	CF-500TP	2013/04/14	2014/04/13
11	DC Power Supply	IDRC	CD-035-020PR	2013/04/14	2014/04/13
12	RF Current Probe	FCC	F-33-4	2013/04/14	2014/04/13
13	Temperature /Humidity Meter	zhicheng	ZC1-2	2013/04/14	2014/04/13
14	MICROWAVE AMPLIFIER	HP	8349B	2013/04/14	2014/04/13
15	Amplifier	HP	8447D	2013/04/14	2014/04/13
16	SIGNAL GENERATOR	HP	8647A	2013/04/14	2014/04/13
17	Log Periodic Antenna	ELECTRO-METRICS	EM-6950	2013/04/14	2014/04/13
18	Horn Antenna	Schwarzbeck	BBHA9120A	2013/04/14	2014/04/13
19	EMI Test Receiver	R&S	ESPI	2013/04/14	2014/04/13
20	Loop Antenna	ZHINAN	ZN30900A	2013/04/14	2014/04/13
21	Horn Antenna	Schwarzbeck	BBHA9120D	2013/04/14	2014/04/13
22	Horn Antenna	Schwarzbeck	BBHA9170	2013/04/14	2014/04/13
23	Spectrum Analyzer	Agilent	E4440A	2013/05/10	2014/05/09
24	Wideband Peak Power Meter	Anritsu	ML2495A	2013/04/14	2014/04/13
25	Power Sensor	Anritsu	MA2411B	2013/04/14	2014/04/13

3.7. Summary of Test Result

FCC PART 15		
FCC Part 15.207	AC Power Conducted Emission	PASS
FCC Part 15.247(a)(2)	6dB Bandwidth	PASS
FCC Part 15.247(d)	Spurious RF Conducted Emission	PASS
FCC Part 15.247(b)	Maximum Peak Output Power	PASS
FCC Part 15.247(e)	Power Spectral Density	PASS
FCC Part 15.109/ 15.205/ 15.209	Radiated Emissions	PASS
FCC Part 15.247(d)	Band Edge Compliance of RF Emission	PASS
FCC Part 15.203/15.247 (b)	Antenna Requirement	PASS

Remark: The measurement uncertainty is not included in the test result.

Preliminary tests were performed in different data rate to find the worst radiated emission. The data rate shown in the table below is the worst-case rate with respect to the specific test item. Investigation has been done on all the possible configurations for searching the worst cases. The following table is a list of the test modes shown in this test report.

Test Items	Mode	Data Rate	Channel
AC Power Conducted Emission	Normal Link	11 Mbps	1
Maximum Peak Conducted Output Power Power Spectral Density 6dB Bandwidth Spurious RF conducted emission	11b/DSSS	11 Mbps	1/6/11
	11g/OFDM	54 Mbps	1/6/11
	11n(20MHz)/OFDM	65Mbps	1/6/11
	11n(40MHz)/OFDM	150Mbps	3/6/9
Radiated Emission 30MHz~1GHz	11b/DSSS	11 Mbps	1/6/11
	11g/OFDM	54 Mbps	1/6/11
	11n(20MHz)/OFDM	65Mbps	1/6/11
	11n(40MHz)/OFDM	150Mbps	3/6/9
Radiated Emission 1GHz~10th Harmonic	11b/DSSS	11 Mbps	1/6/11
	11g/OFDM	54 Mbps	1/6/11
	11n(20MHz)/OFDM	65Mbps	1/6/11
	11n(40MHz)/OFDM	150Mbps	3/6/9
Band Edge Compliance of RF Emission	11b/DSSS	11 Mbps	1/11
	11g/OFDM	54 Mbps	1/11
	11n(20MHz)/OFDM	65Mbps	1/11
	11n(40MHz)/OFDM	135Mbps	3/9

Note1: According exploratory test, EUT will have maximum output power in those data rate, so those data rate were used for all test.

4. TEST CONDITIONS AND RESULTS

4.1. Conducted Emissions Test

TEST CONFIGURATION

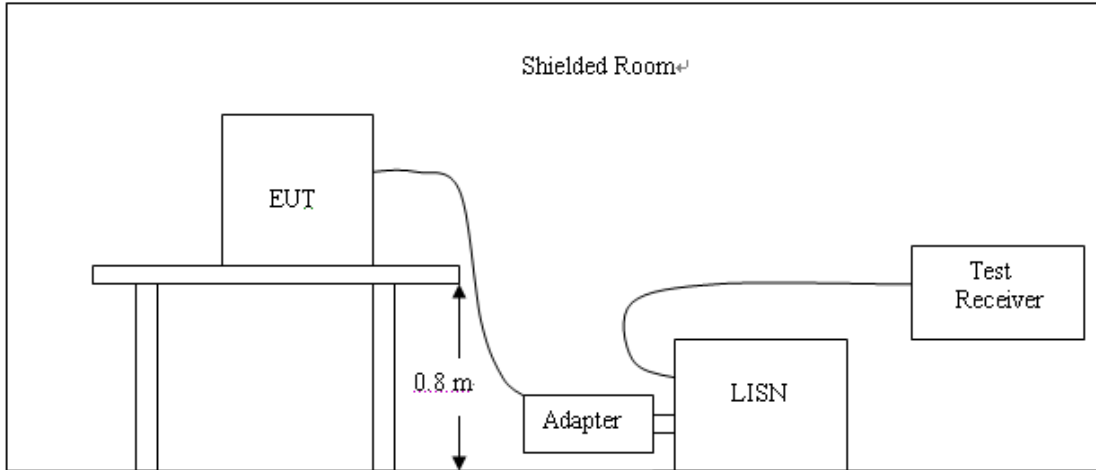

TEST PROCEDURE

For unintentional device, according to § 15.107(a) Line Conducted Emission Limits is as following:

Frequency (MHz)	Maximum RF Line Voltage (dB μ v)			
	CLASS A		CLASS B	
	Q.P.	Ave.	Q.P.	Ave.
0.15 - 0.50	79	66	66-56*	56-46*
0.50 - 5.00	73	60	56	46
5.00 - 30.0	73	60	60	50

* Decreasing linearly with the logarithm of the frequency

For intentional device, according to §15.207(a) Line Conducted Emission Limit is same as above table.

1. Please follow the guidelines in ANSI C63.4-2003.
2. The EUT was placed 0.4 meter from the conducting wall of the shielding room was kept at least 80 centimeters from any other grounded conducting surface.
3. Connect EUT to the power mains through a line impedance stabilization network (LISN).
4. All the support units are connecting to the other LISN.
5. The LISN provides 50 ohm coupling impedance for the measuring instrument.
6. The FCC states that a 50 ohm, 50 microhenry LISN should be used.
7. Both sides of AC line were checked for maximum conducted interference.
8. The frequency range from 150 kHz to 30 MHz was searched.
9. Set the test-receiver system to Peak Detect Function and specified bandwidth with Maximum Hold Mode.

The RBW/VBW for 150KHz to 30MHz: 9KHz

TEST RESULTS

SCAN TABLE: "Voltage (9K-30M) FIN"
 Short Description: 150K-30M Voltage

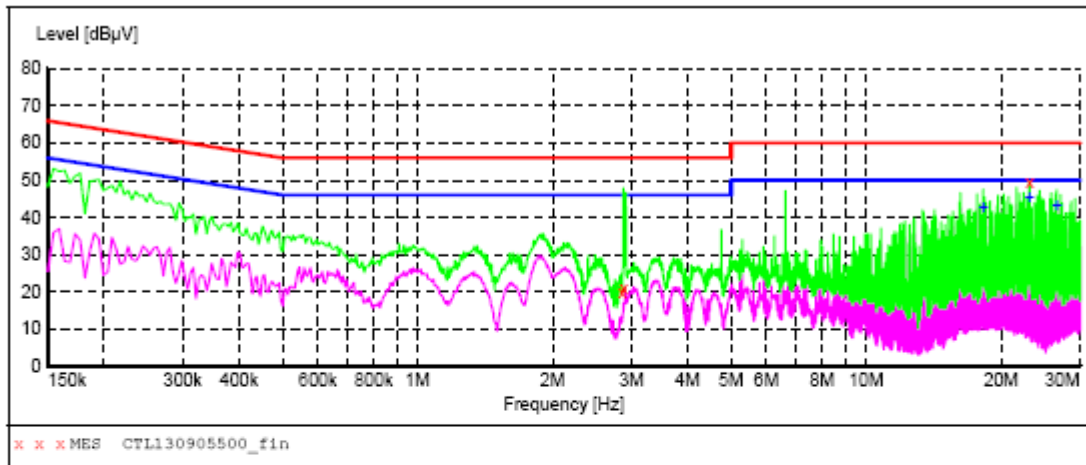

MEASUREMENT RESULT: "CTL130905500_fin"

9/5/2013 4:31PM

Frequency MHz	Level dBuV	Transd dB	Limit dBuV	Margin dB	Detector	Line	PE
2.859000	19.80	9.9	56	36.2	QP	L1	GND
2.886000	20.70	9.9	56	35.3	QP	L1	GND
23.127000	49.20	10.4	60	10.8	QP	L1	GND

MEASUREMENT RESULT: "CTL130905500_fin2"

9/5/2013 4:31PM

Frequency MHz	Level dBuV	Transd dB	Limit dBuV	Margin dB	Detector	Line	PE
18.244500	43.10	10.4	50	6.9	AV	L1	GND
23.127000	45.50	10.4	50	4.5	AV	L1	GND
26.610000	43.40	10.5	50	6.6	AV	L1	GND



SCAN TABLE: "Voltage (9K-30M) FIN"
 Short Description: 150K-30M Voltage

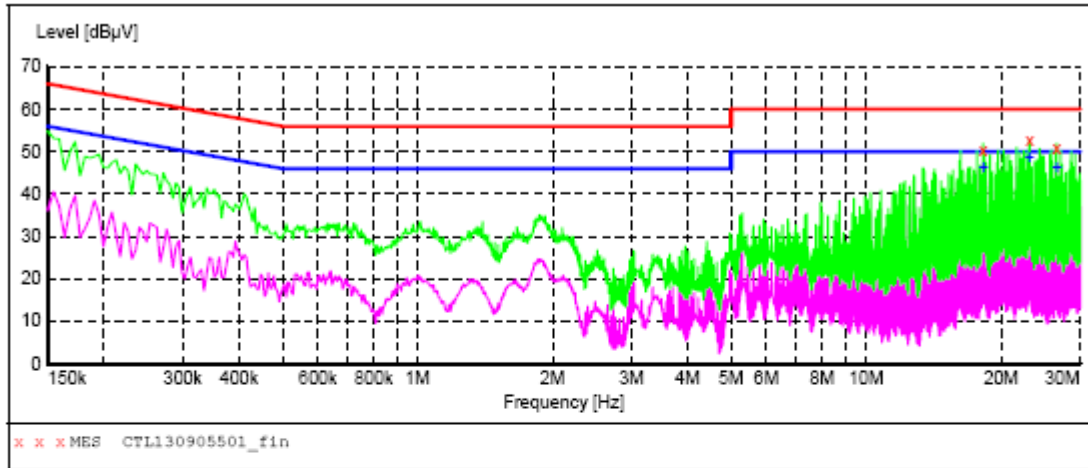

MEASUREMENT RESULT: "CTL130905501_fin"

9/5/2013 4:35PM

Frequency MHz	Level dBuV	Transd dB	Limit dBuV	Margin dB	Detector	Line	PE
18.244500	50.40	10.4	60	9.6	QP	N	GND
23.127000	52.60	10.4	60	7.4	QP	N	GND
26.610000	50.70	10.5	60	9.3	QP	N	GND

MEASUREMENT RESULT: "CTL130905501_fin2"

9/5/2013 4:35PM

Frequency MHz	Level dBuV	Transd dB	Limit dBuV	Margin dB	Detector	Line	PE
18.244500	46.50	10.4	50	3.5	AV	N	GND
23.127000	48.80	10.4	50	1.2	AV	N	GND
26.610000	46.60	10.5	50	3.4	AV	N	GND



4.2. Radiated Emission Test

TEST CONFIGURATION

(A) Radiated Emission Test Set-Up, Frequency Below 30MHz

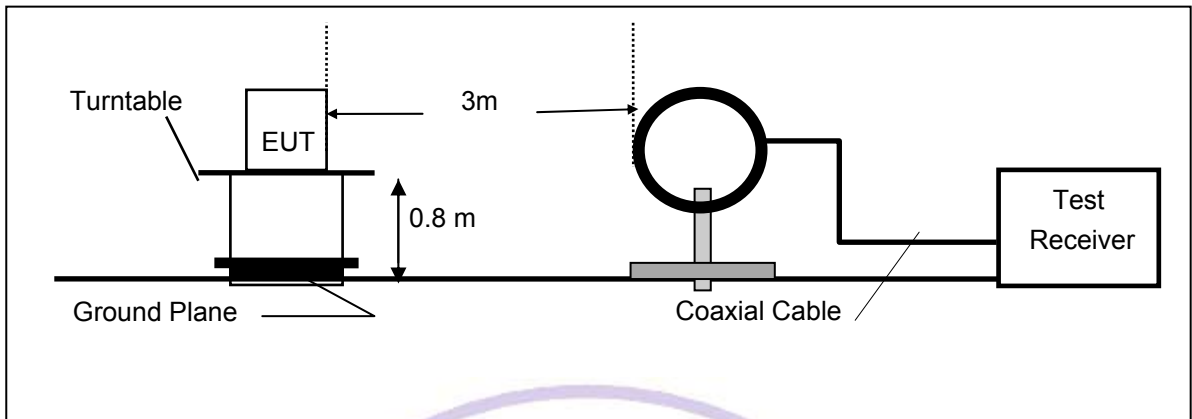

(B) Radiated Emission Test Set-Up, Frequency Below 1000MHz

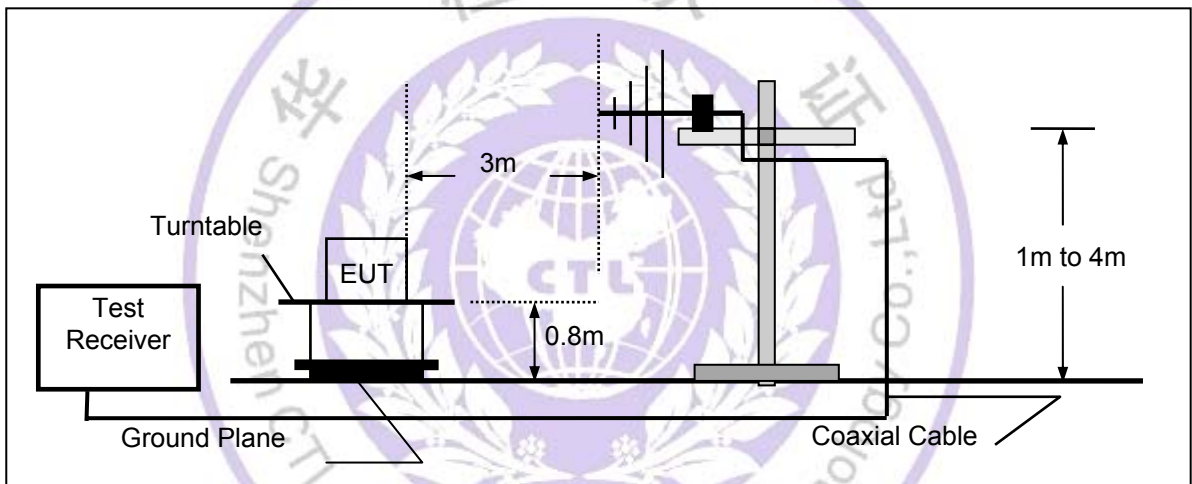

(C) Radiated Emission Test Set-Up, Frequency above 1000MHz

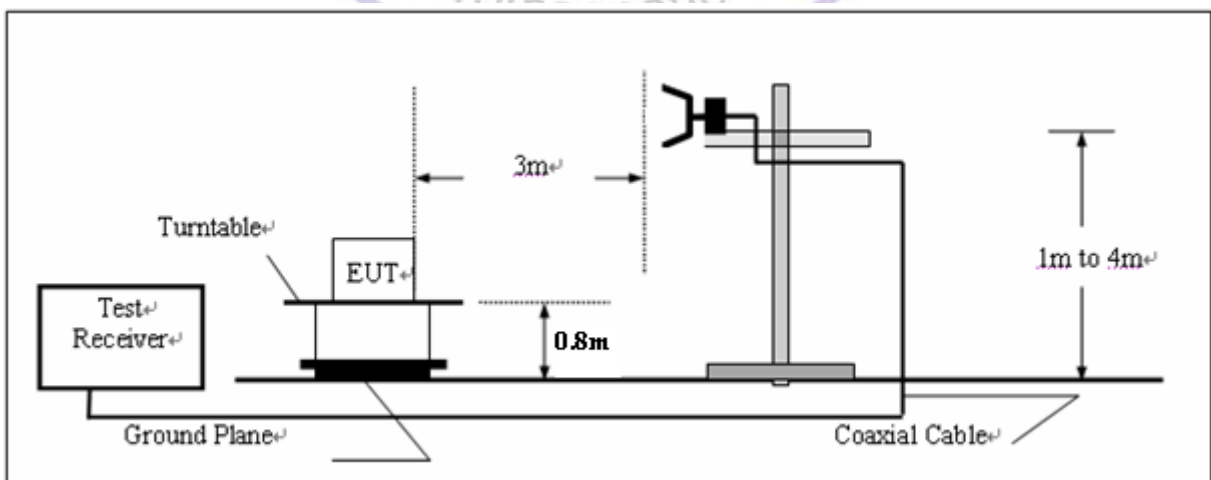

FIELD STRENGTH CALCULATION

The field strength is calculated by adding the Antenna Factor and Cable Factor and subtracting the Amplifier Gain and Duty Cycle Correction Factor(if any) from the measured reading. The basic equation with a sample calculation is as follows:

$$FS = RA + AF + CL - AG$$

Where FS = Field Strength	CL = Cable Attenuation Factor (Cable Loss)
RA = Reading Amplitude	AG = Amplifier Gain
AF = Antenna Factor	

TEST PROCEDURE

1. The testing follows FCC KDB Publication No. 558074 (Measurement Guidelines of DTS), the EUT was setup according to ANSI C63.4: and tested according to ANSI C63.10 for compliance to FCC 47CFR 15.247 requirements.
2. The EUT was placed on a turn table which is 0.8m above ground plane.
3. Maximum procedure was performed by raising the receiving antenna from 1m to 4m and rotating the turn table from 0° to 360° to acquire the highest emissions from EUT
4. And also, each emission was to be maximized by changing the polarization of receiving antenna both horizontal and vertical.
5. Span = wide enough to fully capture the emission being measured; RBW = 1 MHz for f > 1 GHz, 120 kHz for f < 1 GHz; VBW ≥ RBW; Sweep = auto; Detector function = peak; Trace = max hold.
6. Repeat above procedures until all frequency measurements have been completed.

Note:

When doing emission measurement above 1GHz, the horn antenna will be bended down a little (as horn antenna has the narrow beamwidth) in order to keeping the antenna in the “cone of radiation” of EUT. The 3dB beamwidth is 60 degrees for H-plane and 90 degrees for E-plane.

LIMIT

For unintentional device, according to § 15.109(a), except for Class A digital devices, the field strength of radiated emissions from unintentional radiators at a distance of 3 meters shall not exceed the following values:

Frequency (MHz)	Distance (Meters)	Radiated (dBμV/m)	Radiated (μV/m)
30-88	3	40.0	100
88-216	3	43.5	150
216-960	3	46.0	200
Above 960	3	54.0	500

For intentional device, according to § 15.209(a), the general requirement of field strength of radiated emissions from intentional radiators at a distance of 3 meters shall not exceed the above table. According to § 15.247(d), in any 100kHz bandwidth outside the frequency band in which the EUT is operating, the radio frequency power that is produced by the intentional radiator shall be at least 20dB below that in the 100kHz bandwidth within the band that contains the highest level of desired power.

TEST RESULTS

802.11b

CH	Antenna	Frequency (MHz)	Reading Level (dBuV/m)	Factor (dB)	Measure Level (dBuV/m)	Limit (dBuV/m)	Margin (dB)	Detector
1	V	2412.0	71.5	30.8	102.3	Fundamental	/	PK
	V	307.4	12.9	14.8	27.7	46	-18.3	QP
	V	500.0	15.0	19.7	34.7	46	-11.3	QP
	V	3200.0	42.8	-0.6	42.2	54(note3)	-11.8	PK
	V	4825.0	47.2	2.6	49.8	54(note3)	-4.2	PK
	V	7239.0	51.8	8.1	59.9	74	-13.3	PK
	V	7236.0	44.2	8.9	53.1	54	-0.9	AV
	H	24000.0	59.1	-8.9	50.2	54(note3)	-3.8	PK
6	V	2437.0	71.3	31.2	102.5	Fundamental	/	PK
	V	317.1	13.3	15.2	28.5	46	-17.5	QP
	V	571.6	13.1	21.2	34.3	46	-11.7	QP
	V	3200.0	43.6	-0.6	43.0	54(note3)	-11.0	PK
	V	4876.0	49.2	2.8	52.0	54(note3)	-2.0	PK
	V	7315.5	53.8	8.8	62.6	74	-11.4	PK
	V	7311.0	43.9	8.8	52.7	54	-1.3	AV
	H	24000.0	59.1	-8.9	50.2	54(note3)	-3.8	PK
11	V	2462.0	70.5	30.9	101.4	Fundamental	/	PK
	V	326.3	12.6	14.9	27.5	46	-18.5	QP
	H	582.0	12.9	21.2	34.1	46	-11.9	QP
	V	3200.0	44.1	-0.6	43.5	54(note3)	-10.5	PK
	V	4927.0	45.1	3.0	48.1	54(note3)	-5.9	PK
	V	7383.5	50.8	8.9	59.7	74	-14.3	PK
	V	7386.0	43.4	8.9	52.3	54	-1.7	AV
	H	24000.0	59.1	-8.9	50.2	54(note3)	-3.8	PK

Note: 1. Measure Level = Reading Level + Factor.

2. The test trace is same as the ambient noise (the test frequency range: 9kHz~30MHz, 18GHz~25GHz), therefore no data appear in the report.

3. This limit applies for using average detector, if the test result on peak is lower than average limit, then average measurement needn't be performed.

802.11g

CH	Antenna	Frequency (MHz)	Reading Level (dBuV/m)	Factor (dB)	Measure Level (dBuV/m)	Limit (dBuV/m)	Margin (dB)	Detector
1	V	2411.9	69.7	31.9	101.6	Fundamental	/	PK
	H	296.8	13.4	15.7	29.1	46	-17.9	QP
	H	567.4	13.9	21.3	35.2	46	-10.8	QP
	V	3200	50.0	-13.4	36.6	54(note3)	-17.4	PK
	V	4824.0	43.3	2.6	45.9	54(note3)	-8.1	PK
	V	7236.0	36.7	8.9	45.6	54	-8.4	AV
	V	7239.0	50.2	8.9	59.1	74	-14.9	PK
	H	24000.0	59.1	-8.9	50.2	54(note3)	-3.8	PK
6	V	2437.0	70.3	31.2	101.5	Fundamental	/	PK
	V	302.6	12.7	14.8	27.5	46	-18.5	QP
	V	599.9	13.8	21.2	35.0	46	-11.0	QP
	V	3200.0	42.5	-0.6	41.9	54(note3)	-12.1	PK
	V	4876.0	45.6	2.8	48.4	54(note3)	-5.6	PK
	V	7298.5	44.2	8.8	53.0	54(note3)	-1.0	PK
	H	24000.0	59.1	-8.9	50.2	54(note3)	-3.8	PK
11	V	2462.3	70.9	30.9	101.8	Fundamental	/	PK
	H	589.7	13.7	21.2	34.9	46	-11.1	QP
	V	286.6	12.5	14.7	27.2	46	-18.8	QP
	V	3200.0	42.7	-0.6	42.1	54(note3)	-11.9	PK
	V	4927.0	45.9	3.0	48.9	54(note3)	-5.1	PK
	V	7386.0	37.4	8.9	46.3	54	-7.7	AV
	V	7392.0	51.8	8.9	60.7	74	-13.3	PK
H	24000.0	59.1	-8.9	50.2	54(note3)	-3.8	PK	

Note: 1. Measure Level = Reading Level + Factor.

2. The test trace is same as the ambient noise (the test frequency range: 9kHz~30MHz, 18GHz~25GHz), therefore no data appear in the report.

3. This limit applies for using average detector, if the test result on peak is lower than average limit, then average measurement needn't be performed.

802.11n(20MHz)

CH	Antenna	Frequency (MHz)	Reading Level (dBuV/m)	Factor (dB)	Measure Level (dBuV/m)	Limit (dBuV/m)	Margin (dB)	Detector
1	V	2412.1	69.4	30.7	100.1	Fundamental	/	PK
	H	597.9	14.1	21.2	35.3	46	-10.7	QP
	H	311.8	12.5	15.1	27.6	46	-18.4	QP
	V	3200.0	42.4	-0.6	41.8	54(note3)	-12.2	PK
	V	4824.0	42.3	2.6	44.9	54(note3)	-9.1	PK
	V	7236.0	33.6	8.9	42.5	54	-11.5	AV
	V	7239.0	46.2	8.9	55.1	74	-18.9	PK
	H	24000.0	59.1	-8.9	50.2	54(note3)	-3.8	PK
6	V	2437.0	69.3	31.2	100.5	Fundamental	/	PK
	H	561.6	13.8	21.2	35.0	46	-11.0	QP
	H	343.3	13.2	16.0	29.2	46	-16.8	QP
	V	3200.0	42.5	-0.6	41.9	54(note3)	-12.1	PK
	V	4876.0	45.5	2.8	48.3	54(note3)	-5.7	PK
	V	7307.0	54.6	8.8	63.4	74	-10.6	PK
	V	7310.6	41.0	8.8	49.8	54	-4.2	AV
	H	24000.0	59.1	-8.9	50.2	54(note3)	-3.8	PK
11	V	2462.0	70.1	30.9	101.0	Fundamental	/	PK
	H	300.1	13.7	14.7	28.4	46	-17.6	QP
	H	553.8	13.5	21.2	34.7	46	-11.3	QP
	V	3200.0	43.2	-0.6	42.6	54(note3)	-11.4	PK
	V	4924.0	42.7	3.0	45.7	54(note3)	-8.3	PK
	V	7375.0	50.1	9.0	59.0	74	-15.0	PK
	V	7378.3	34.0	9.0	42.9	54	-11.1	AV
	H	24000.0	59.1	-8.9	50.2	54(note3)	-3.8	PK

Note: 1. Measure Level = Reading Level + Factor.

2. The test trace is same as the ambient noise (the test frequency range: 9kHz~30MHz, 18GHz~25GHz), therefore no data appear in the report.

3. This limit applies for using average detector, if the test result on peak is lower than average limit, then average measurement needn't be performed.

802.11n(40MHz)

CH	Antenna	Frequency (MHz)	Reading Level (dBuV/m)	Factor (dB)	Measure Level (dBuV/m)	Limit (dBuV/m)	Margin (dB)	Detector
3	V	2423.6	65.6	31.8	97.4	Fundamental	/	PK
	H	341.9	14.2	16.0	30.2	46	-15.8	QP
	H	564.0	14.5	21.2	35.7	46	-10.3	QP
	V	3200.0	42.5	-0.6	41.9	54(note3)	-12.1	PK
	V	4844.0	41.5	2.6	44.2	54(note3)	-9.8	PK
	V	7290.0	44.5	8.8	53.3	54(note3)	-0.7	PK
	H	24000.0	59.1	-8.9	50.2	54(note3)	-3.8	PK
6	V	2437.0	64.6	31.2	95.8	Fundamental	/	PK
	H	291.9	12.9	14.8	27.7	46	-18.3	QP
	H	553.3	13.6	21.2	34.8	46	-11.2	QP
	V	3200.0	42.1	-0.6	41.5	54(note3)	-12.5	PK
	V	4874.0	41.6	2.8	44.4	54(note3)	-9.6	PK
	V	7349.2	32.0	9.0	40.9	54	-13.1	AV
	V	7358.0	46.6	9.0	55.6	74	-18.4	PK
H	24000.0	59.1	-8.9	50.2	54(note3)	-3.8	PK	
9	V	2453.6	64.7	30.9	95.6	Fundamental	/	PK
	H	586.3	14.1	21.2	35.3	46	-10.7	QP
	H	294.3	13.4	14.8	28.2	46	-17.8	QP
	V	3200.0	42.6	-0.6	42.0	54(note3)	-12.0	PK
	V	4904.0	41.9	2.9	44.8	54(note3)	-9.2	PK
	V	7349.4	32.2	9.0	41.2	54	-12.8	AV
	V	7349.5	45.6	9.0	54.5	74	-19.5	PK
H	24000.0	59.1	-8.9	50.2	54(note3)	-3.8	PK	

Note: 1. Measure Level = Reading Level + Factor.

2. The test trace is same as the ambient noise (the test frequency range: 9kHz~30MHz, 18GHz~25GHz), therefore no data appear in the report.

3. This limit applies for using average detector, if the test result on peak is lower than average limit, then average measurement needn't be performed.

4.3. 6dB Bandwidth Measurement

TEST CONFIGURATION

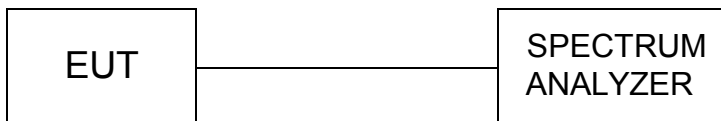

TEST PROCEDURE

1. The testing follows FCC KDB Publication No. 558074 D01 v03r01 (Measurement Guidelines of DTS).
2. The RF output of EUT was connected to the spectrum analyzer by a low loss cable.
3. Make the measurement with the spectrum analyzer's resolution bandwidth (RBW) = 100 kHz. In order to make an accurate measurement, set the span greater than RBW. The 6 dB bandwidth must be greater than 500 kHz.
4. The marker-delta reading at this point is the 6 dB bandwidth of the emission.

LIMIT

For digital modulation systems, the minimum 6 dB bandwidth shall be at least 500 kHz.

TEST RESULTS

Product	:	Router
Test Item	:	6dB Occupied Bandwidth
Test Mode	:	Mode 1: Transmit by 802.11b

Channel No.	Frequency (MHz)	Occupied Bandwidth (kHz)	Limit (kHz)	Result
01	2412	10500	500	Pass
06	2437	9100	500	Pass
11	2462	10500	500	Pass

Channel 01 (2412MHz)

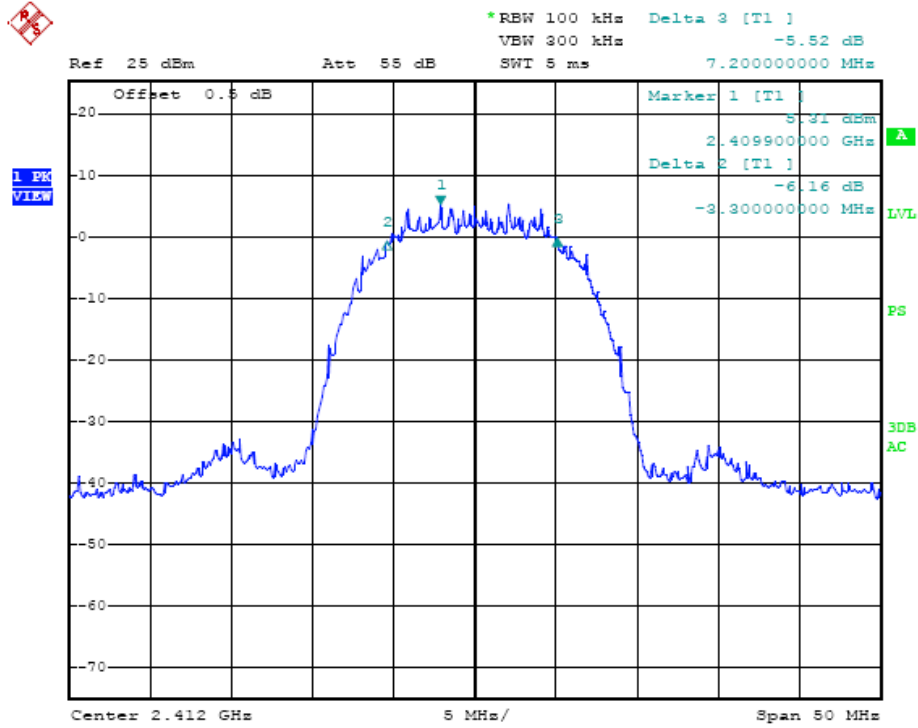

Channel 06 (2437MHz)

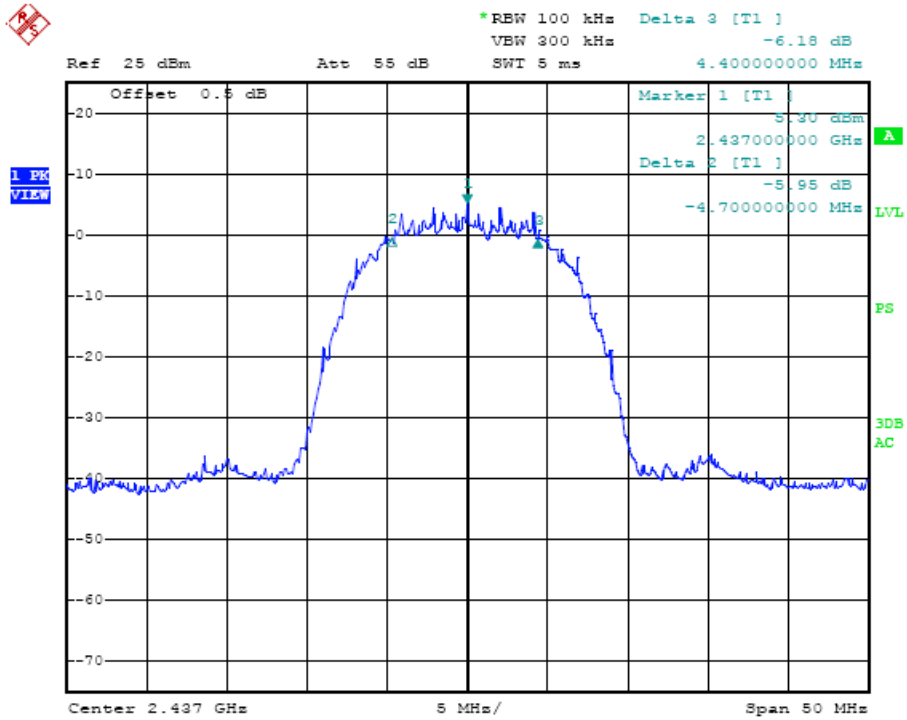

Channel 11 (2462MHz)

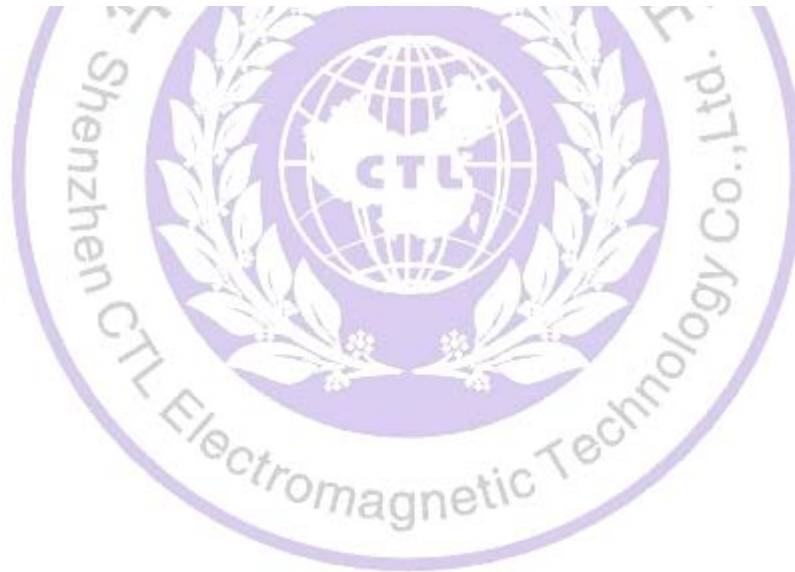
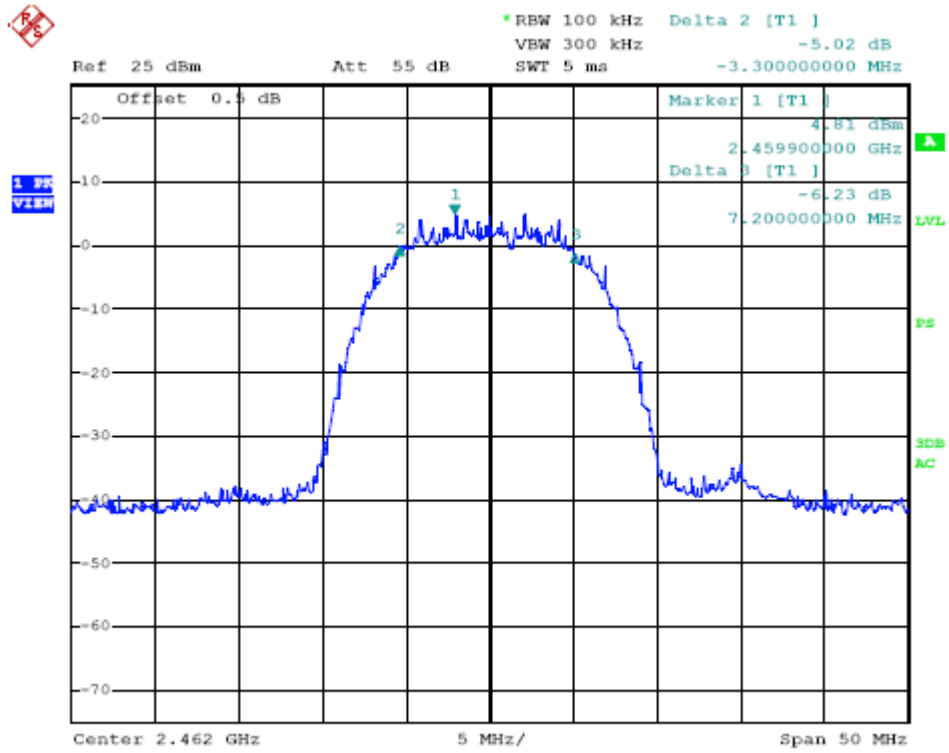

Product	:	Router
Test Item	:	6dB Occupied Bandwidth
Test Mode	:	Mode 2: Transmit by 802.11g

Channel No.	Frequency (MHz)	Occupied Bandwidth (kHz)	Limit (kHz)	Result
01	2412	16500	500	Pass
06	2437	16600	500	Pass
11	2462	16600	500	Pass

Channel 01 (2412MHz)

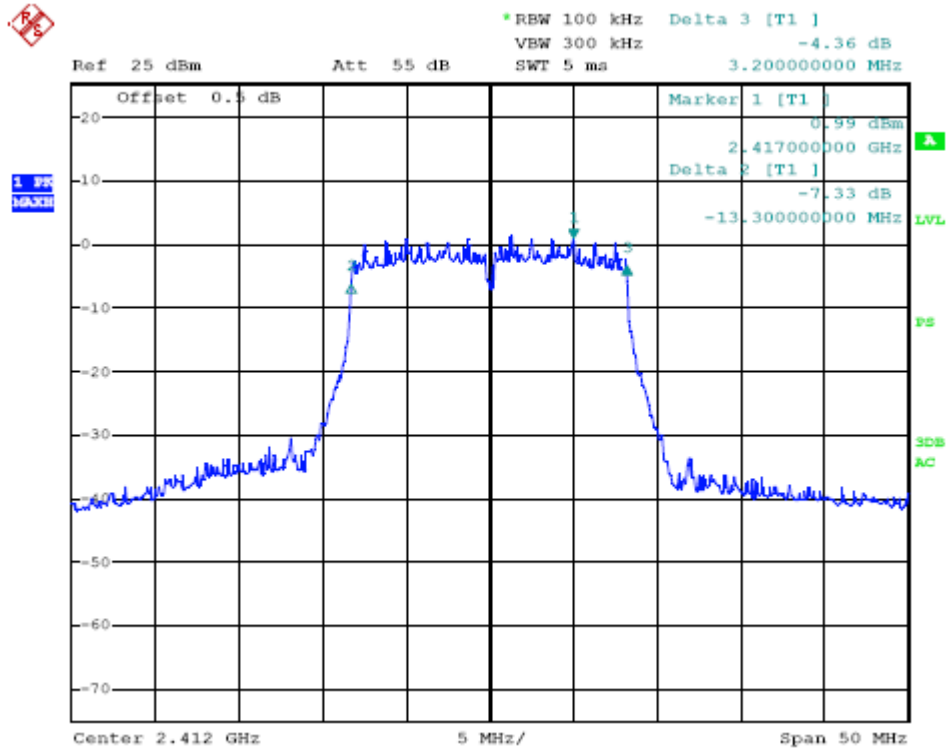

Channel 06 (2437MHz)

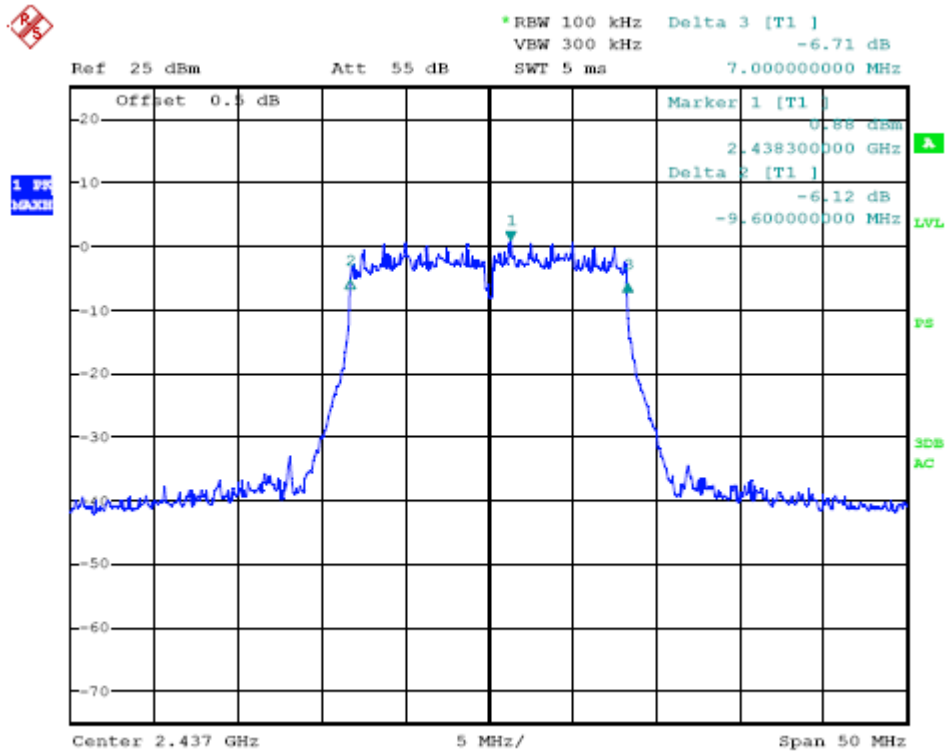

Channel 11 (2462MHz)

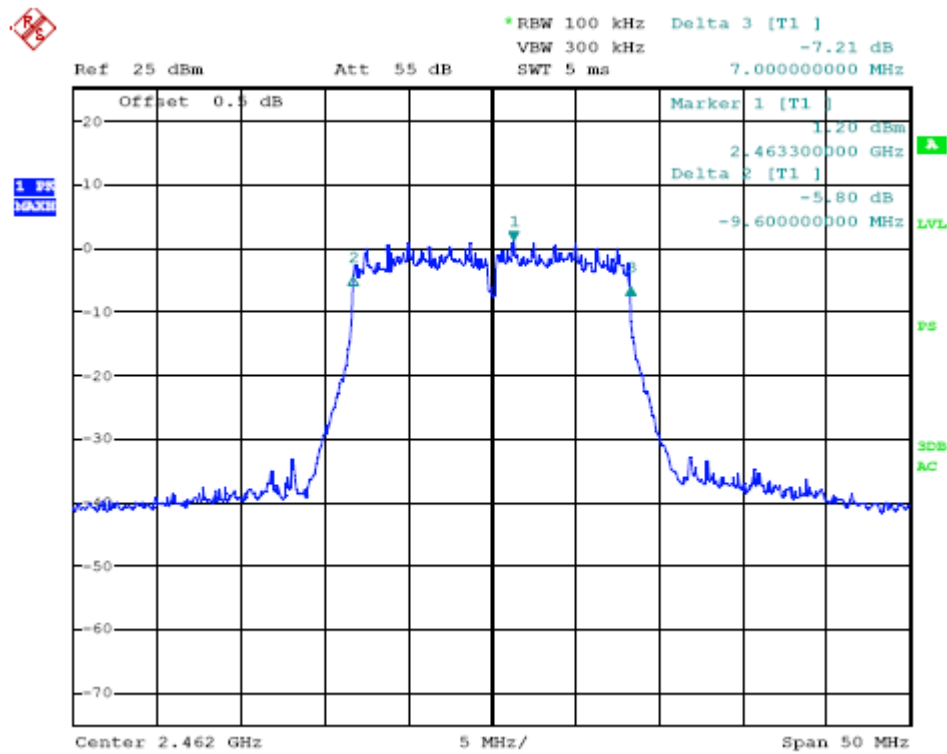

Product	:	Router
Test Item	:	6dB Occupied Bandwidth
Test Mode	:	Mode 3: Transmit by 802.11n (20MHz)

Channel No.	Frequency (MHz)	Occupied Bandwidth (kHz)	Limit (kHz)	Result
01	2412	17300	500	Pass
06	2437	17600	500	Pass
11	2462	17600	500	Pass

Channel 01 (2412MHz)

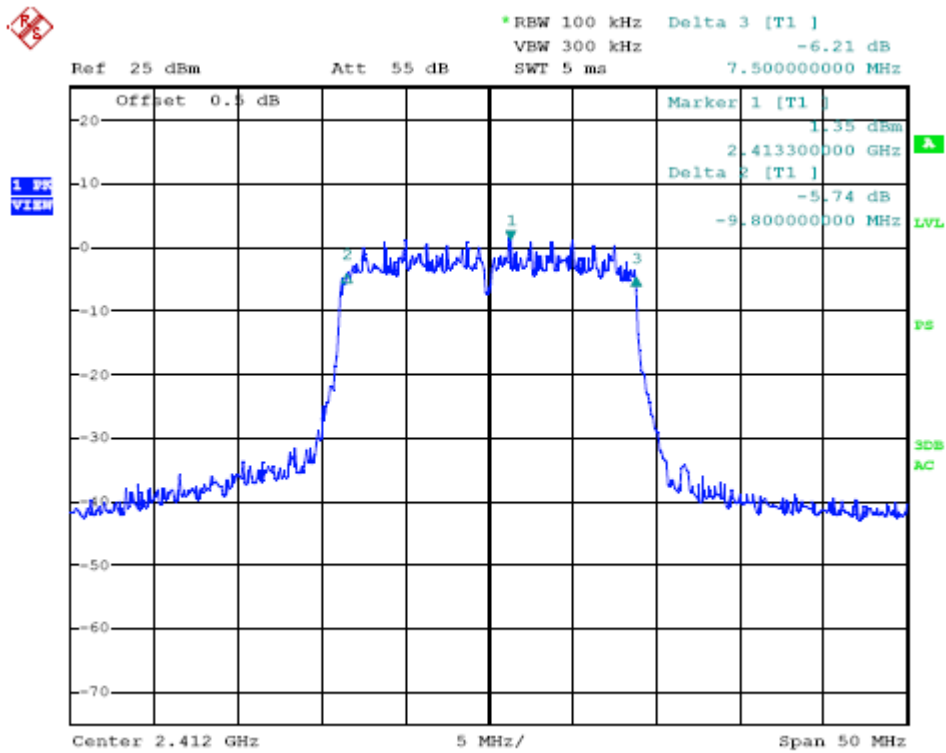

Channel 06 (2437MHz)

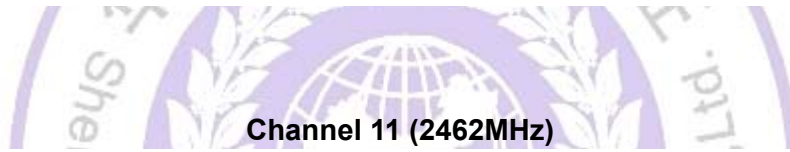
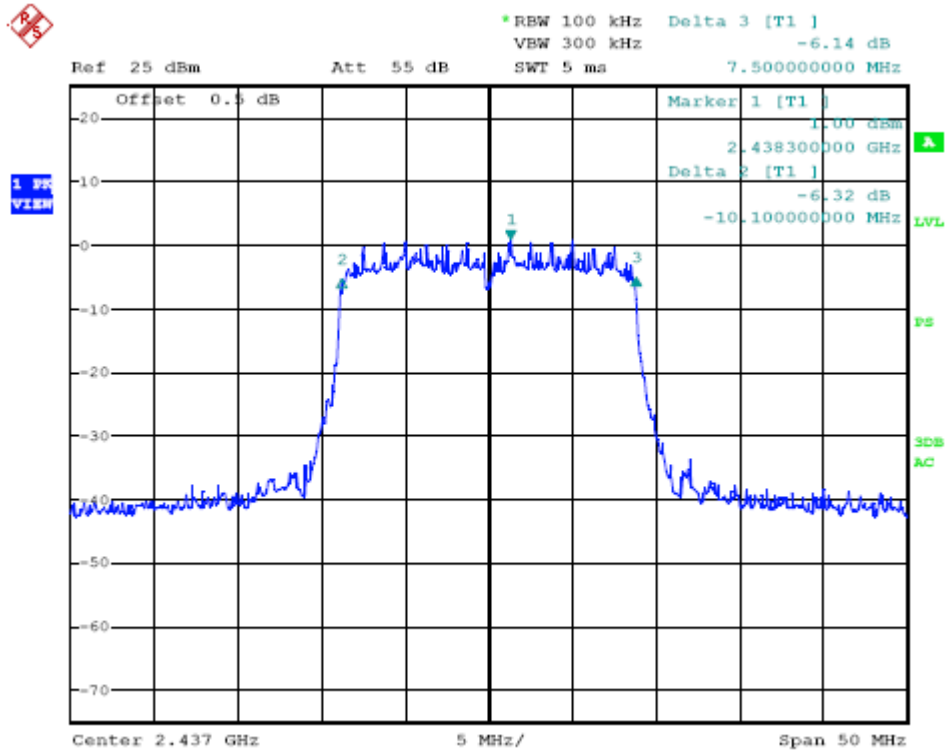

Channel 11 (2462MHz)

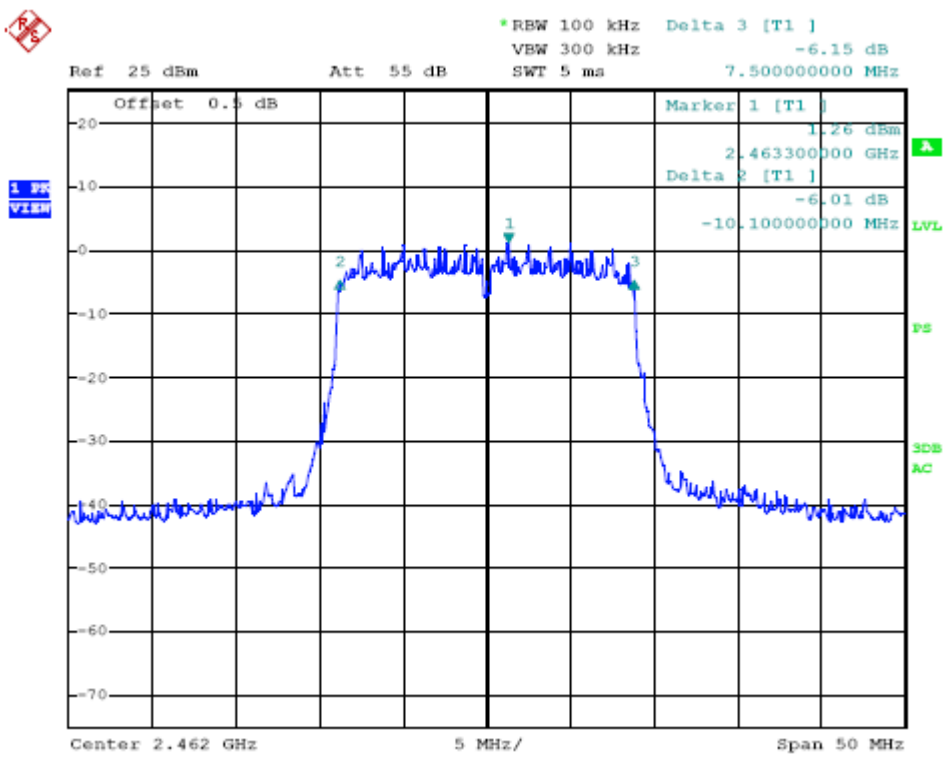

Product	:	Router
Test Item	:	6dB Occupied Bandwidth
Test Mode	:	Mode 4: Transmit by 802.11n (40MHz)

Channel No.	Frequency (MHz)	Occupied Bandwidth (kHz)	Limit (kHz)	Result
03	2422	35600	500	Pass
06	2437	35600	500	Pass
09	2452	35600	500	Pass

Channel 03 (2422MHz)

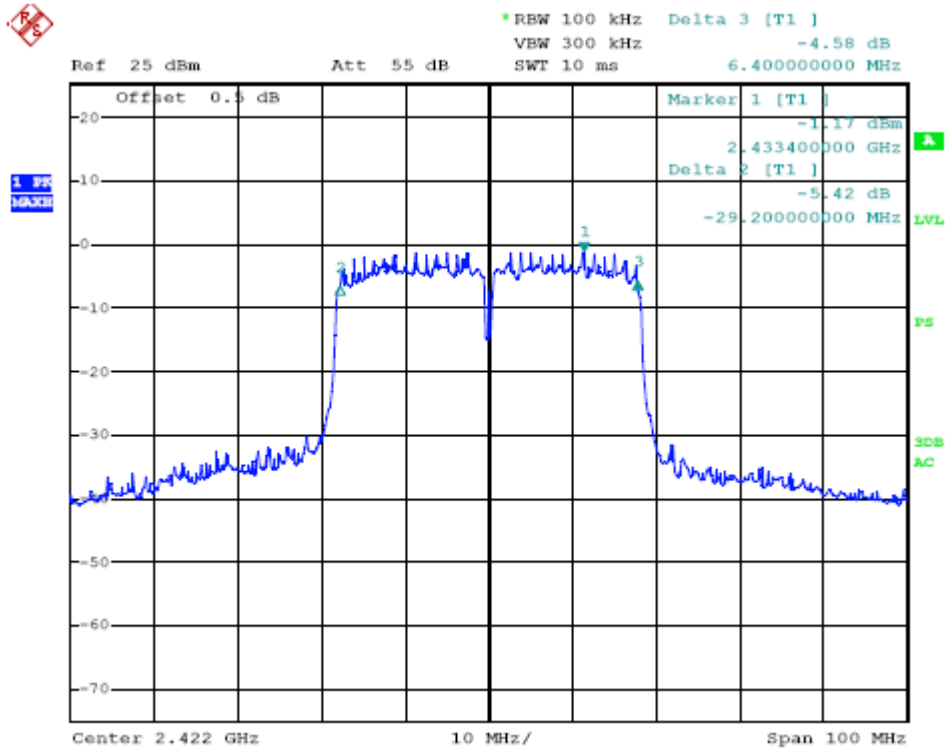

Channel 06 (2437MHz)

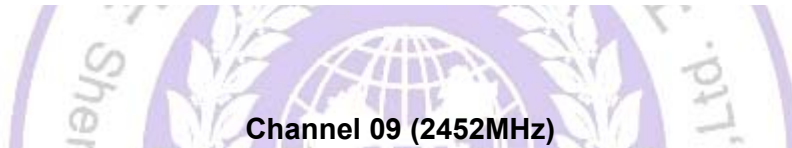
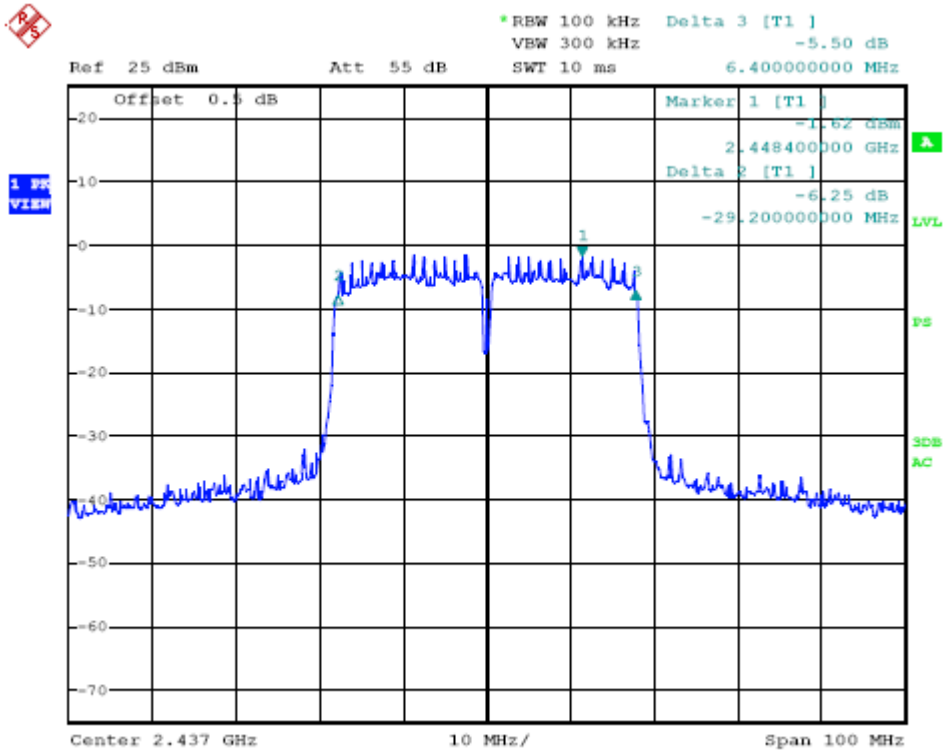

Channel 09 (2452MHz)

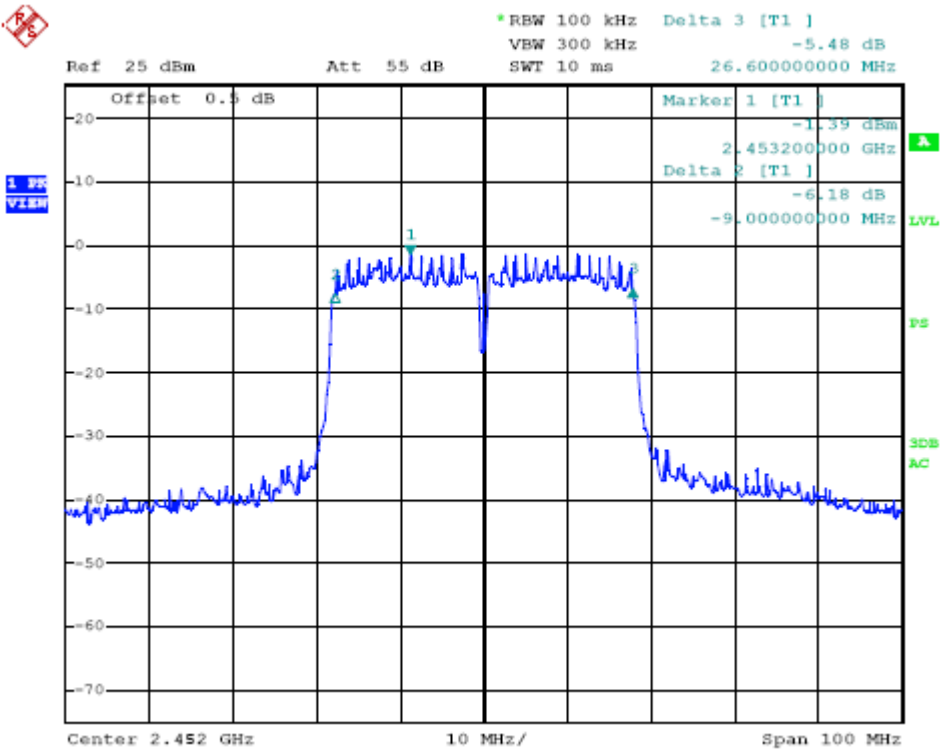

4.4. Maximum Peak Output Power

TEST CONFIGURATION

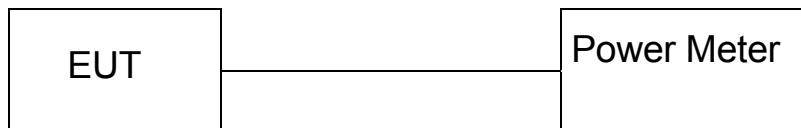

TEST PROCEDURE

According to C63.10 -2009 and KDB558074 D01 v03r01, The EUT was directly connected to the power meter / spectrum analyzer and antenna output port as show in the block diagram as TEST CONFIGURATION shows.

Use the wideband power meter to test peak power and record the result.

LIMIT

The Peak Output Power Measurement limits are 30dBm.

TEST RESULTS

Product	:	Router
Test Item	:	Power Output
Test Mode	:	Mode 1: Transmit by 802.11b

Channel No.	Frequency (MHz)	Measurement Power Output (dBm)	Limit (dBm)	Result
1	2412	11.54	30.00	Pass
6	2437	11.01	30.00	Pass
11	2462	11.34	30.00	Pass

Product	:	Router
Test Item	:	Power Output
Test Mode	:	Mode 2: Transmit by 802.11g

Channel No.	Frequency (MHz)	Measurement Power Output (dBm)	Limit (dBm)	Result
1	2412	10.16	30.00	Pass
6	2437	9.95	30.00	Pass
11	2462	10.44	30.00	Pass

Product	:	Router
Test Item	:	Power Output
Test Mode	:	Mode 3: Transmit by 802.11n(20MHz)

Channel No.	Frequency (MHz)	Measurement Power Output (dBm)	Limit (dBm)	Result
1	2412	9.87	30.00	Pass
6	2437	10.14	30.00	Pass
11	2462	9.98	30.00	Pass

Product	:	Router
Test Item	:	Power Output
Test Mode	:	Mode 4: Transmit by 802.11n(40MHz)

Channel No.	Frequency (MHz)	Measurement Power Output (dBm)	Limit (dBm)	Result
3	2422	13.36	30.00	Pass
6	2437	13.06	30.00	Pass
9	2452	13.09	30.00	Pass

4.5. Band Edge Measurement

TEST CONFIGURATION

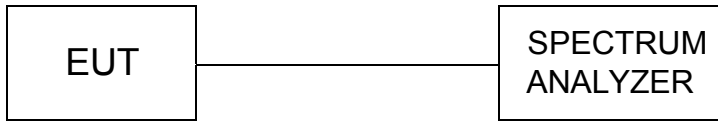

TEST PROCEDURE

The band edge compliance of RF radiated emission should be measured by following the guidance in ANSI C63.10 and FCC KDB Publication No. 558074 D01 v03r01 (Measurement Guidelines of DTS) with respect to maximizing the emission by rotating the EUT, measuring the emission while the EUT is situated in three orthogonal planes (if appropriate), adjusting the measurement antenna height and polarization etc. Set RBW=100kHz and VBM= 300KHz to measure the peak field strength and set RBW to 1MHz and VBW to 10Hz to measure the average radiated field strength.

The conducted RF band edge was measured by using a spectrum analyzer. Set span wide enough to capture the highest in-band emission and the emission at the band edge. Set RBW and VBW to 100 kHz, to measure the conducted peak band edge.

Connect the spectrum analyzer to the EUT using an appropriate RF cable connected to the EUT output. Configure the spectrum analyzer settings as described below (be sure to enter all losses between the unlicensed wireless device output and the spectrum analyzer).

- Span: Set Span for minimum 50 MHz - Reference Level: 110 dB μ V (corrected for gains and losses of test antenna factor, preamp gain and cable loss) - Attenuation: 10 dB
- Sweep Time: Coupled - Resolution Bandwidth: Up to and including 1 GHz = \geq 100 kHz
- Resolution Bandwidth: Above 1 GHz = 1 MHz - Video Bandwidth: Below 1 GHz = 300 kHz
- Video Bandwidth: Up to and including 1 GHz = \geq 3 MHz for peak and 10 Hz for average
- Detector: Peak

Place a marker at the end of the restricted band closest to the transmit frequency to show compliance. Also measure any emissions in the restricted bands. Save the spectrum analyzer plot. Repeat for each power and modulation for lowest and highest channel.

LIMIT

1. Below -20dB of the highest emission level in operating band.
2. Fall in the restricted bands listed in section 15.205. The maximum permitted average field strength is listed in section 15.209(see Section 15.205(c)).

Frequency (MHz)	Limit Average (dBuV/m)	Limit Peak (dBuV/m)
Below 2390 or Above 2483.5	54	74

TEST RESULTS

Engineer: Brgant	
Site: AC5	Time: 2013/09/02 - 17:43
Limit: FCC_Part15.209_RE(3m)	Margin: 0
Probe: BBHA 9120D_499(1-18GHz)	Polarity: Horizontal
EUT: Router	Power: AC 120V/60Hz
Note: Mode1:Transmit at channel 2412MHz by 802.11b	

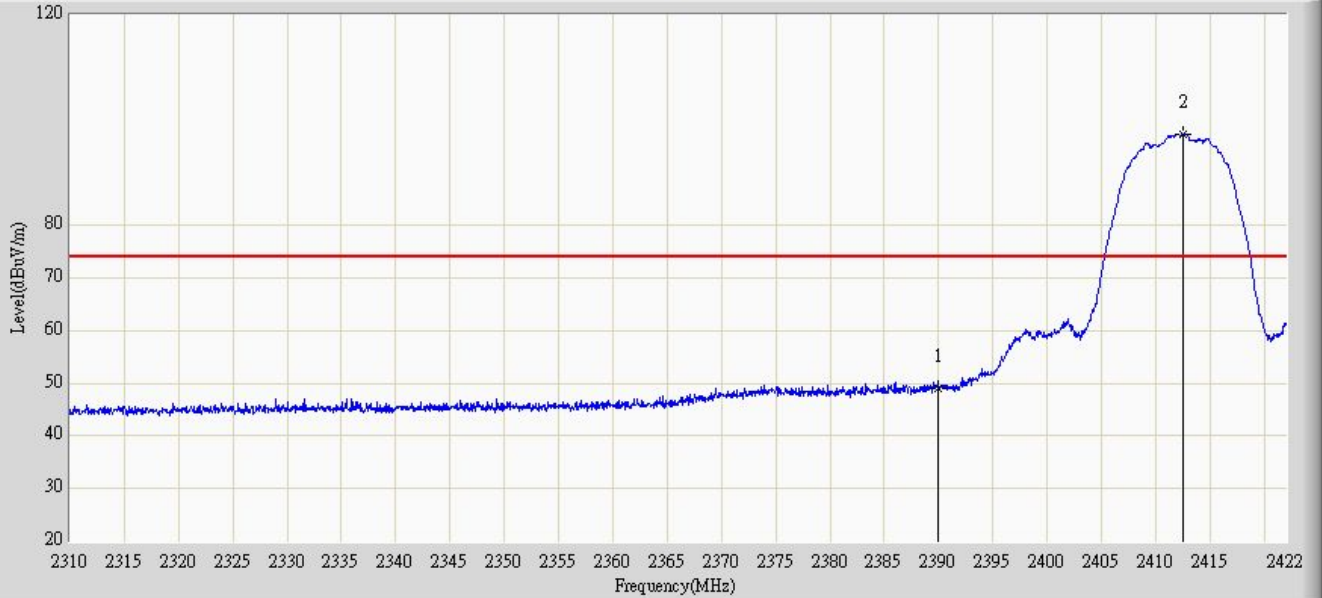

No	Flag	Mark	Frequency (MHz)	Measure Level (dBuV/m)	Reading Level (dBuV)	Over Limit (dB)	Limit (dBuV/m)	Factor	Type
1			2390.000	49.158	18.418	-24.842	74.000	30.740	PK
2		*	2412.536	97.198	66.403	N/A	N/A	30.795	PK

Engineer: Brgant	
Site: AC5	Time: 2013/09/02 - 19:16
Limit: FCC_Part15.209_RE(3m)	Margin: 0
Probe: BBHA 9120D_499(1-18GHz)	Polarity: Horizontal
EUT: Router	Power: AC 120V/60Hz
Note: Mode1:Transmit at channel 2412MHz by 802.11b	

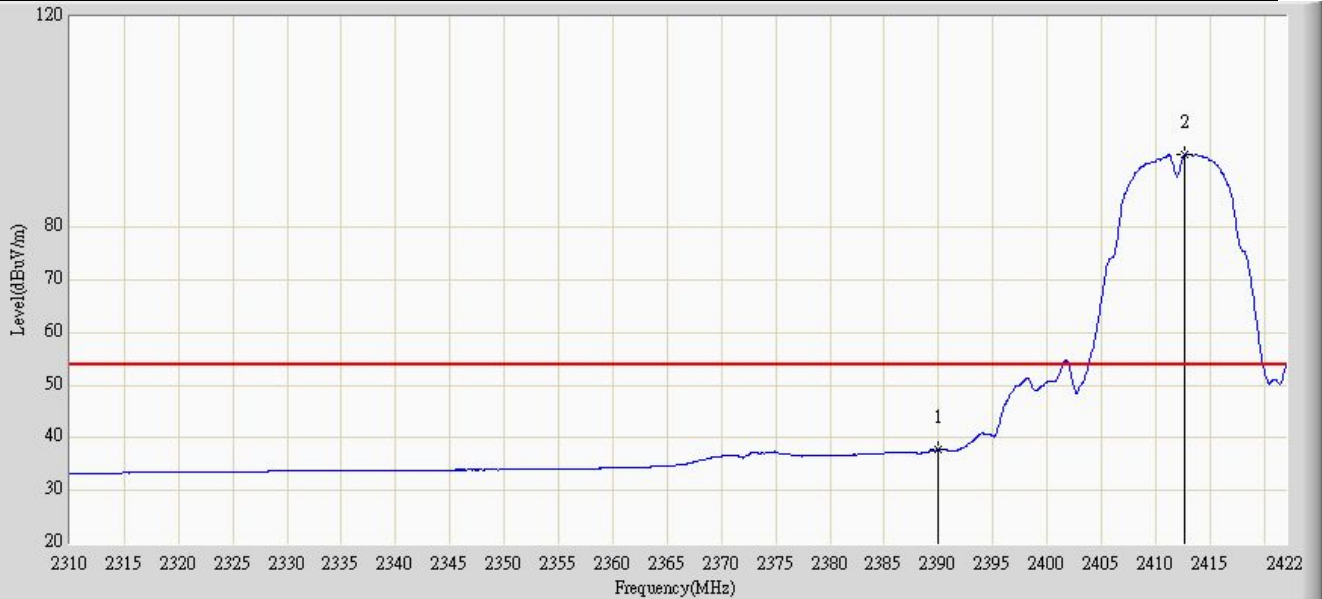

No	Flag	Mark	Frequency (MHz)	Measure Level (dBuV/m)	Reading Level (dBuV)	Over Limit (dB)	Limit (dBuV/m)	Factor	Type
1			2390.000	37.804	7.064	-16.196	54.000	30.740	AV
2		*	2412.704	93.986	63.191	N/A	N/A	30.795	AV

Engineer: Brgant	
Site: AC5	Time: 2013/09/02 - 19:21
Limit: FCC_Part15.209_RE(3m)	Margin: 0
Probe: BBHA 9120D_499(1-18GHz)	Polarity: Vertical
EUT: Router	Power: AC 120V/60Hz
Note: Mode1:Transmit at channel 2412MHz by 802.11b	

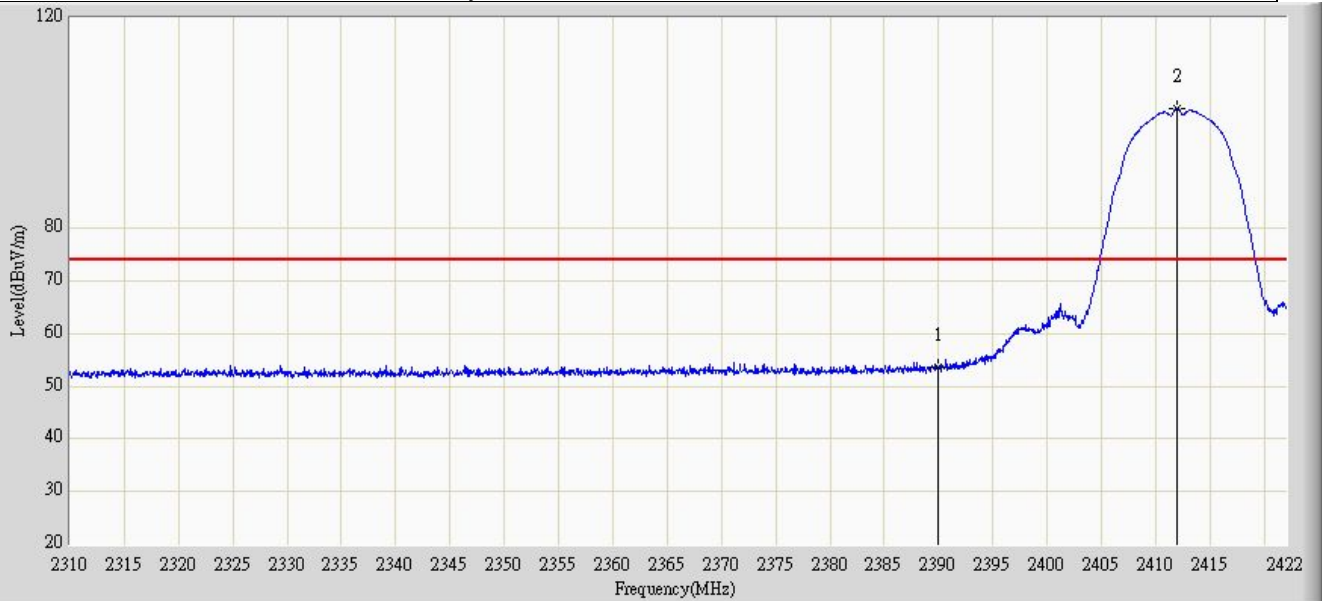

No	Flag	Mark	Frequency (MHz)	Measure Level (dBuV/m)	Reading Level (dBuV)	Over Limit (dB)	Limit (dBuV/m)	Factor	Type
1			2390.000	53.484	22.744	-20.516	74.000	30.740	PK
2		*	2412.032	102.719	71.926	N/A	N/A	30.793	PK

Engineer: Brgant	
Site: AC5	Time: 2013/09/02 - 19:22
Limit: FCC_Part15.209_RE(3m)	Margin: 0
Probe: BBHA 9120D_499(1-18GHz)	Polarity: Vertical
EUT: Router	Power: AC 120V/60Hz
Note: Mode1:Transmit at channel 2412MHz by 802.11b	

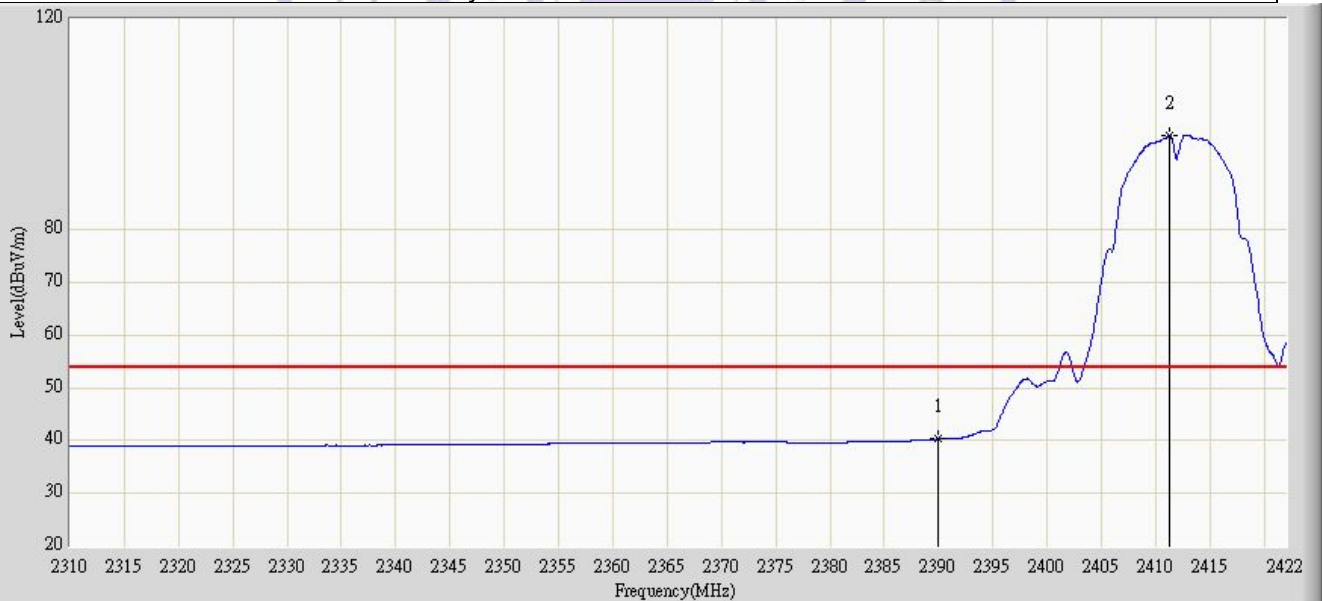

No	Flag	Mark	Frequency (MHz)	Measure Level (dBuV/m)	Reading Level (dBuV)	Over Limit (dB)	Limit (dBuV/m)	Factor	Type
1			2390.000	40.283	9.543	-13.717	54.000	30.740	AV
2		*	2411.304	97.878	67.087	N/A	N/A	30.791	AV

Engineer: Brgant	
Site: AC5	Time: 2013/09/02 - 19:45
Limit: FCC_Part15.209_RE(3m)	Margin: 0
Probe: BBHA 9120D_499(1-18GHz)	Polarity: Horizontal
EUT: Router	Power: AC 120V/60Hz
Note: Mode1:Transmit at channel 2462MHz by 802.11b	

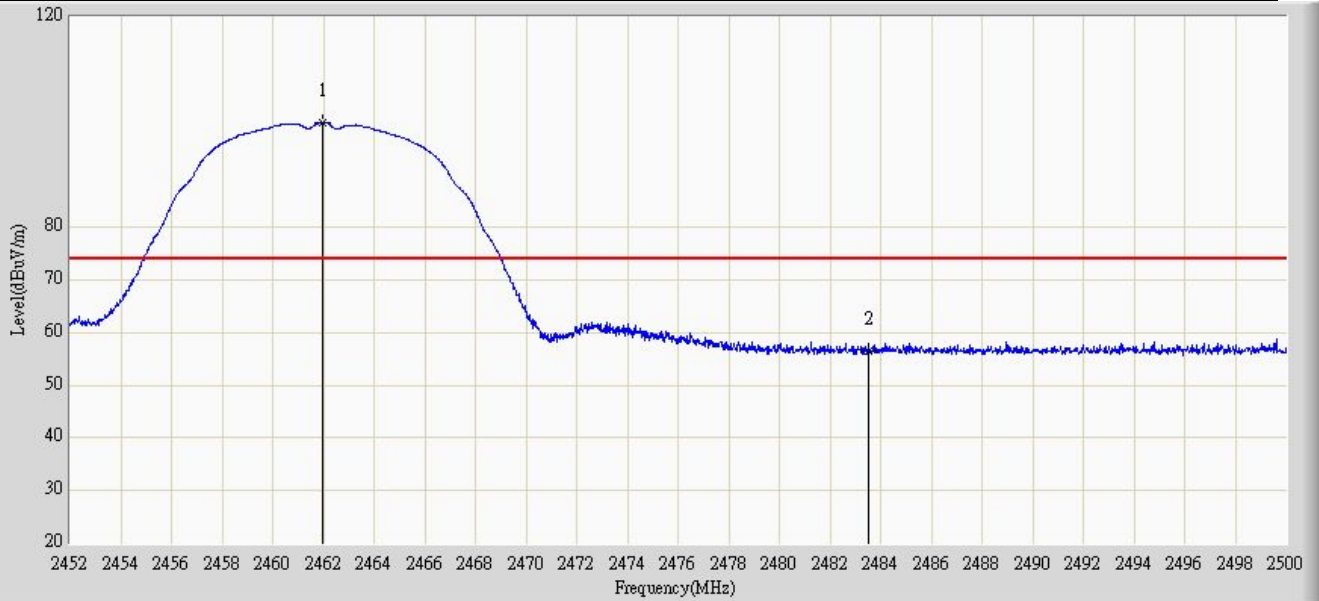

No	Flag	Mark	Frequency (MHz)	Measure Level (dBuV/m)	Reading Level (dBuV)	Over Limit (dB)	Limit (dBuV/m)	Factor	Type
1		*	2461.984	100.009	69.077	N/A	N/A	30.932	PK
2			2483.500	56.406	25.420	-17.594	74.000	30.985	PK

Engineer: Brgant	
Site: AC5	Time: 2013/09/02 - 19:50
Limit: FCC_Part15.209_RE(3m)	Margin: 0
Probe: BBHA 9120D_499(1-18GHz)	Polarity: Horizontal
EUT: Router	Power: AC 120V/60Hz
Note: Mode1:Transmit at channel 2462MHz by 802.11b	



No	Flag	Mark	Frequency (MHz)	Measure Level (dBuV/m)	Reading Level (dBuV)	Over Limit (dB)	Limit (dBuV/m)	Factor	Type
1		*	2462.800	96.268	65.334	N/A	N/A	30.933	AV
2			2483.500	43.915	12.930	-10.085	54.000	30.985	AV

Engineer: Brgant	
Site: AC5	Time: 2013/09/02 - 20:09
Limit: FCC_Part15.209_RE(3m)	Margin: 0
Probe: BBHA 9120D_499(1-18GHz)	Polarity: Vertical
EUT: Router	Power: AC 120V/60Hz
Note: Mode1:Transmit at channel 2462MHz by 802.11b	

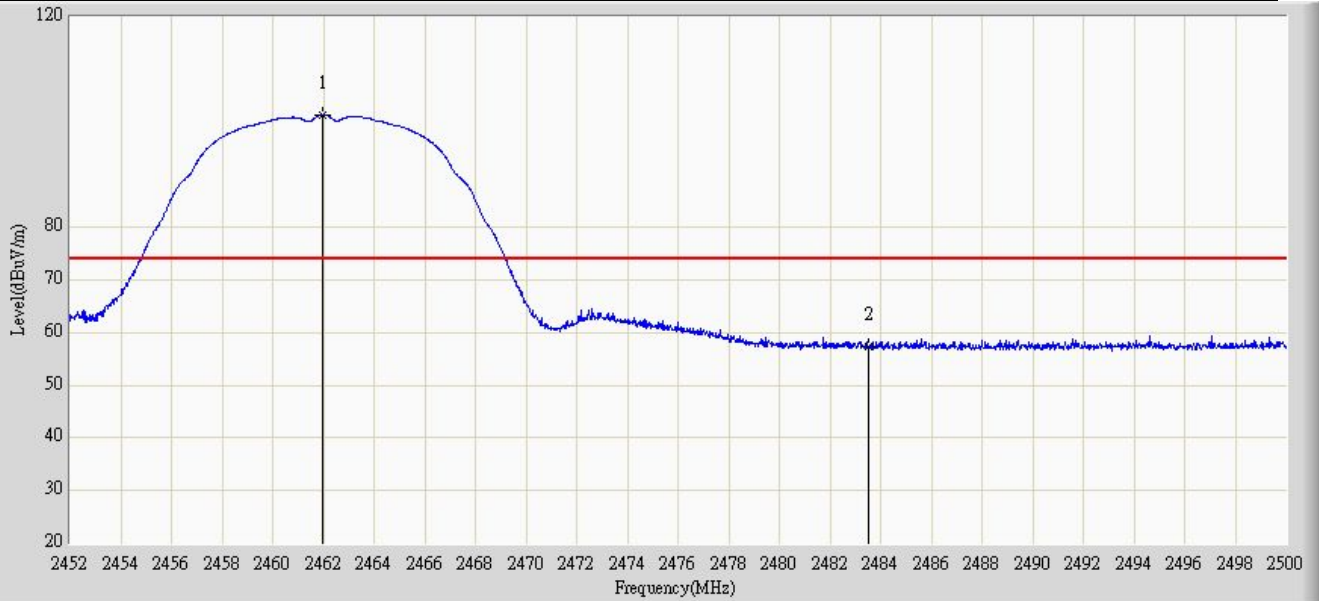

No	Flag	Mark	Frequency (MHz)	Measure Level (dBuV/m)	Reading Level (dBuV)	Over Limit (dB)	Limit (dBuV/m)	Factor	Type
1		*	2461.984	101.417	70.485	N/A	N/A	30.932	PK
2			2483.500	26.397	26.411	-16.603	74.000	30.985	PK

Engineer: Brgant	
Site: AC5	Time: 2013/09/02 - 20:15
Limit: FCC_Part15.209_RE(3m)	Margin: 0
Probe: BBHA 9120D_499(1-18GHz)	Polarity: Vertical
EUT: Router	Power: AC 120V/60Hz
Note: Mode1:Transmit at channel 2462MHz by 802.11b	



No	Flag	Mark	Frequency (MHz)	Measure Level (dBuV/m)	Reading Level (dBuV)	Over Limit (dB)	Limit (dBuV/m)	Factor	Type
1		*	2462.728	96.074	65.140	N/A	N/A	30.933	AV
2			2483.500	43.887	12.902	-10.113	54.000	30.985	AV

Engineer: Brgant	
Site: AC5	Time: 2013/09/02 - 20:27
Limit: FCC_Part15.209_RE(3m)	Margin: 0
Probe: BBHA 9120D_499(1-18GHz)	Polarity: Horizontal
EUT: Router	Power: AC 120V/60Hz
Note: Mode2:Transmit at channel 2412MHz by 802.11g	

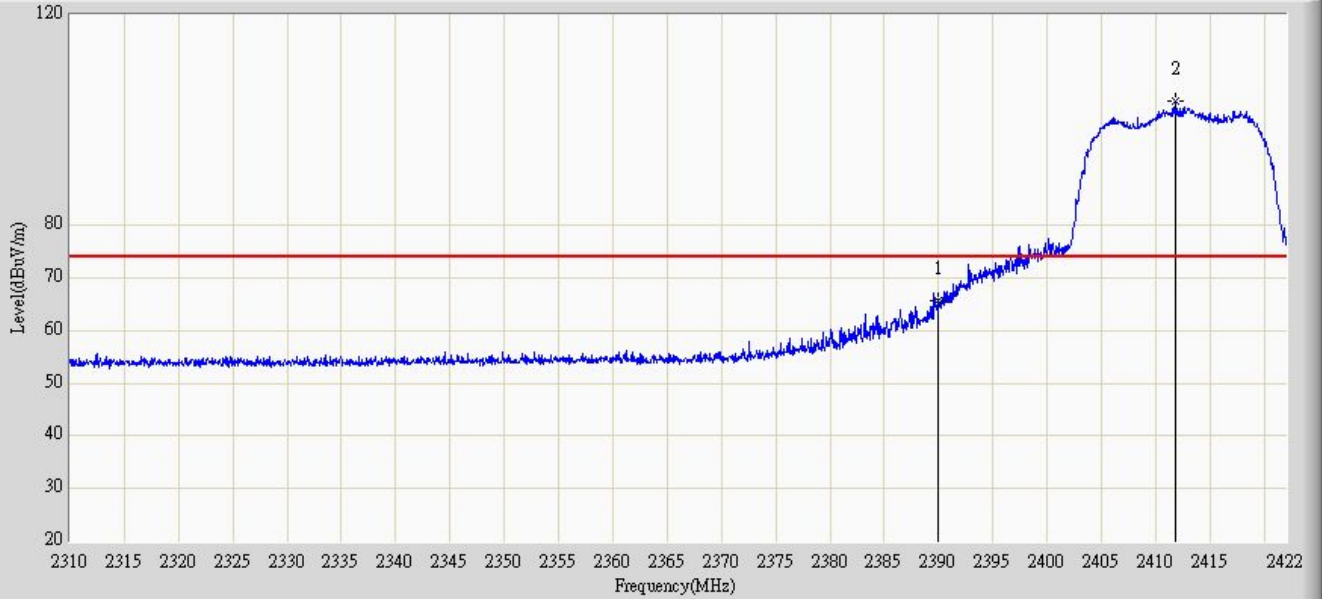

No	Flag	Mark	Frequency (MHz)	Measure Level (dBuV/m)	Reading Level (dBuV)	Over Limit (dB)	Limit (dBuV/m)	Factor	Type
1			2390.000	65.736	34.996	-8.264	74.000	30.740	PK
2		*	2411.808	103.738	72.946	N/A	N/A	30.792	PK

Engineer: Brgant	
Site: AC5	Time: 2013/09/02 - 20:34
Limit: FCC_Part15.209_RE(3m)	Margin: 0
Probe: BBHA 9120D_499(1-18GHz)	Polarity: Horizontal
EUT: Router	Power: AC 120V/60Hz
Note: Mode2:Transmit at channel 2412MHz by 802.11g	

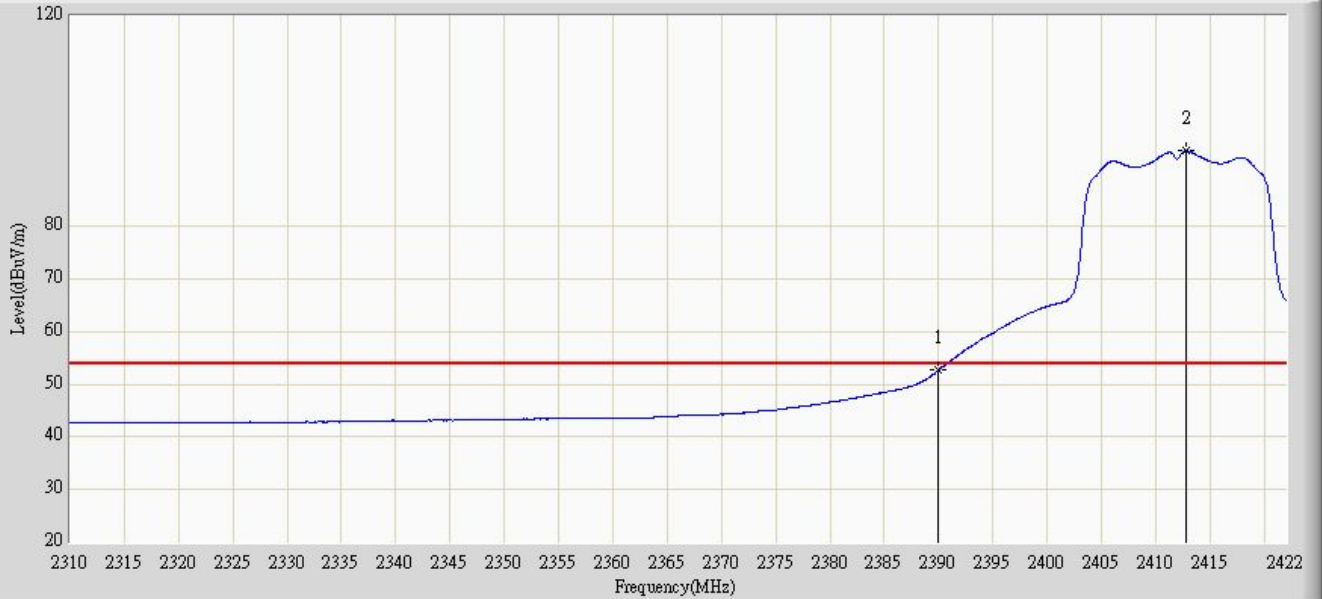

No	Flag	Mark	Frequency (MHz)	Measure Level (dBuV/m)	Reading Level (dBuV)	Over Limit (dB)	Limit (dBuV/m)	Factor	Type
1			2390.000	52.695	21.955	-1.305	54.000	30.740	AV
2		*	2412.872	94.319	63.523	N/A	N/A	30.795	AV

Engineer: Brgant	
Site: AC5	Time: 2013/09/02 - 20:35
Limit: FCC_Part15.209_RE(3m)	Margin: 0
Probe: BBHA 9120D_499(1-18GHz)	Polarity: Vertical
EUT: Router	Power: AC 120V/60Hz
Note: Mode2:Transmit at channel 2412MHz by 802.11g	

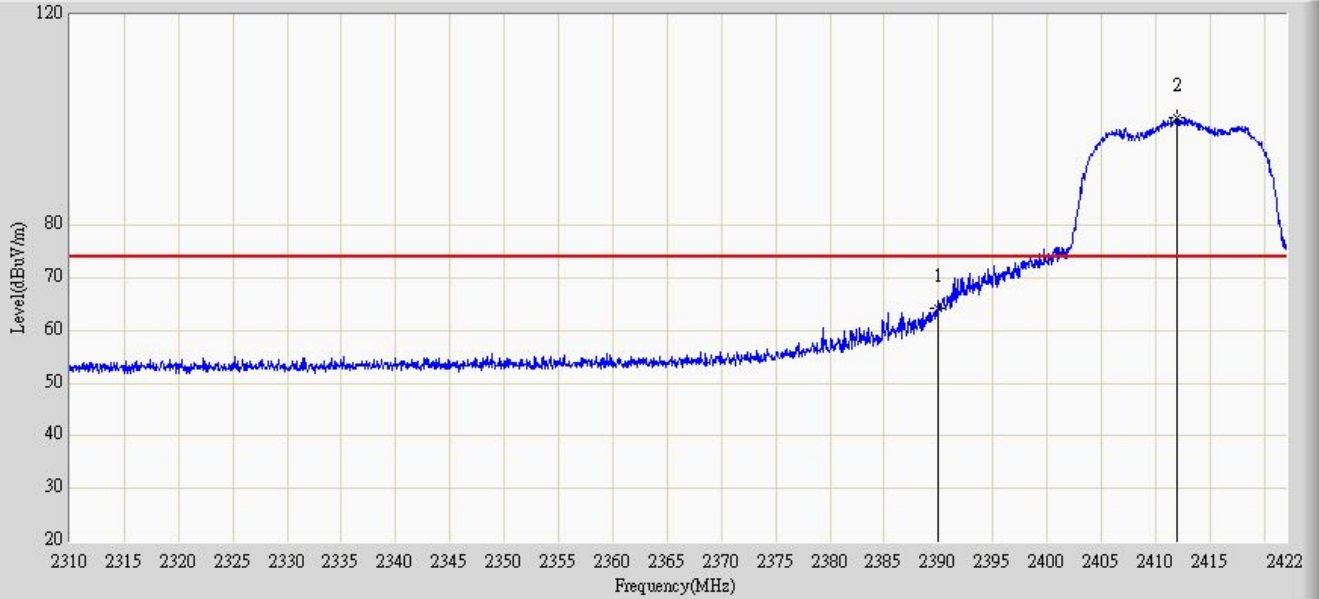

No	Flag	Mark	Frequency (MHz)	Measure Level (dBuV/m)	Reading Level (dBuV)	Over Limit (dB)	Limit (dBuV/m)	Factor	Type
1			2390.000	64.154	33.414	-9.846	74.000	30.740	PK
2		*	2411.920	100.460	69.667	N/A	N/A	30.793	PK

Engineer: Brgant	
Site: AC5	Time: 2013/09/02 - 20:38
Limit: FCC_Part15.209_RE(3m)	Margin: 0
Probe: BBHA 9120D_499(1-18GHz)	Polarity: Vertical
EUT: Router	Power: AC 120V/60Hz
Note: Mode2:Transmit at channel 2412MHz by 802.11g	

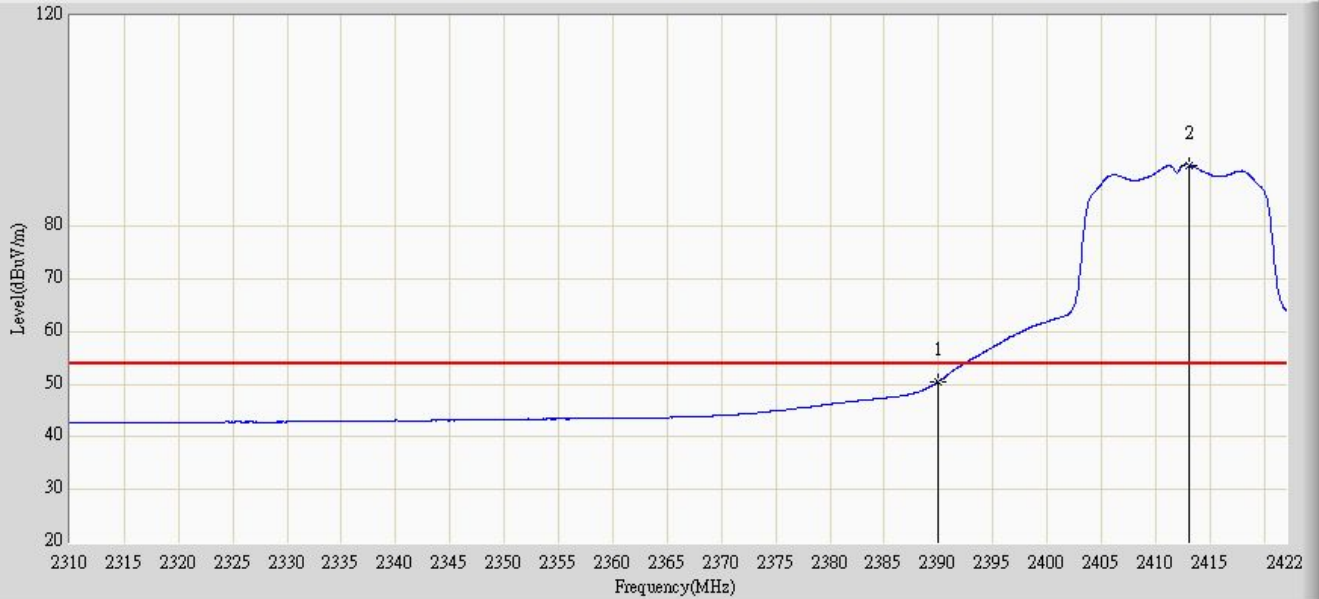

No	Flag	Mark	Frequency (MHz)	Measure Level (dBuV/m)	Reading Level (dBuV)	Over Limit (dB)	Limit (dBuV/m)	Factor	Type
1			2390.000	50.512	19.772	-3.488	54.000	30.740	AV
2		*	2413.040	91.683	60.887	N/A	N/A	30.796	AV

Engineer: Brgant	
Site: AC5	Time: 2013/09/02- 20:48
Limit: FCC_Part15.209_RE(3m)	Margin: 0
Probe: BBHA 9120D_499(1-18GHz)	Polarity: Horizontal
EUT: Router	Power: AC 120V/60Hz
Note: Mode2:Transmit at channel 2462MHz by 802.11g	

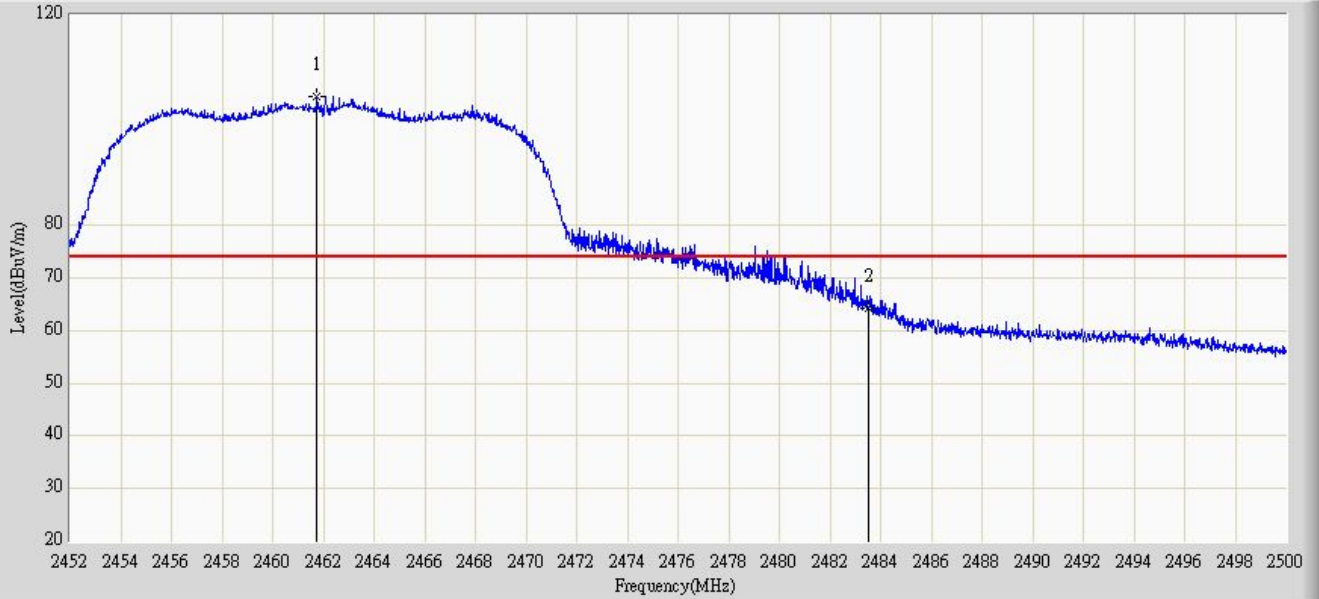

No	Flag	Mark	Frequency (MHz)	Measure Level (dBuV/m)	Reading Level (dBuV)	Over Limit (dB)	Limit (dBuV/m)	Factor	Type
1		*	2461.744	104.423	73.492	N/A	N/A	30.932	PK
2			2483.500	64.251	33.266	-9.749	74.000	30.985	PK

Engineer: Brgant	
Site: AC5	Time: 2013/09/02 - 20:52
Limit: FCC_Part15.209_RE(3m)	Margin: 0
Probe: BBHA 9120D_499(1-18GHz)	Polarity: Horizontal
EUT: Router	Power: AC 120V/60Hz
Note: Mode2:Transmit at channel 2462MHz by 802.11g	

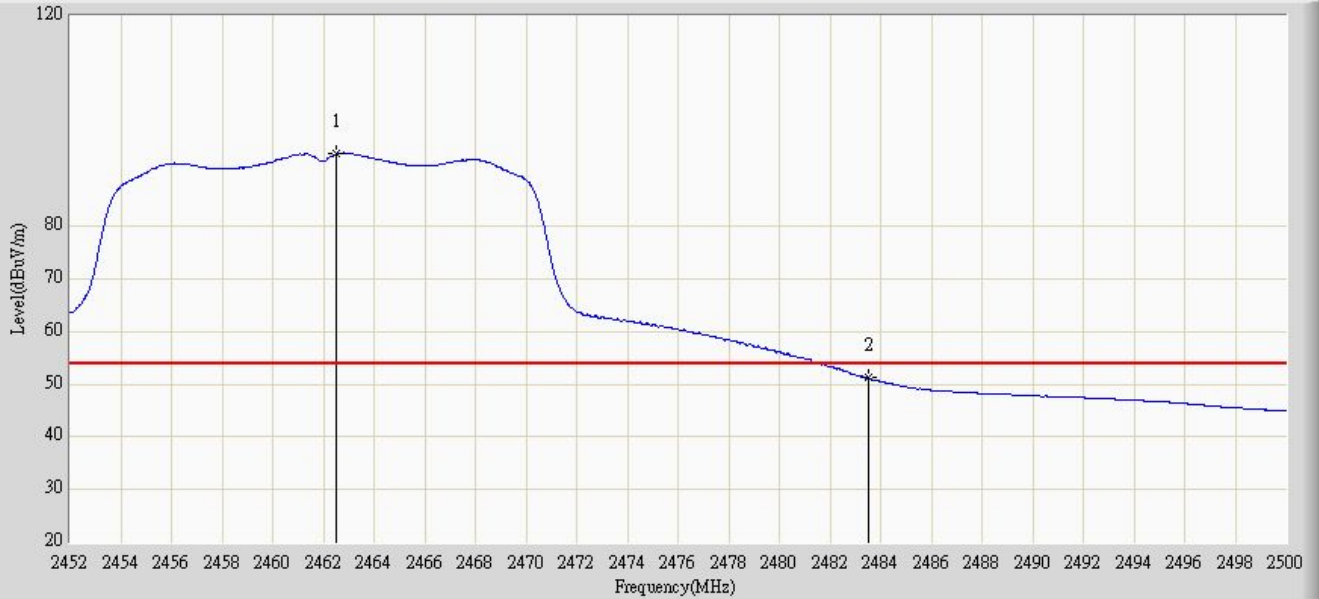

No	Flag	Mark	Frequency (MHz)	Measure Level (dBuV/m)	Reading Level (dBuV)	Over Limit (dB)	Limit (dBuV/m)	Factor	Type
1		*	2462.512	93.831	62.898	N/A	N/A	30.933	AV
2			2483.500	51.234	20.249	-2.766	54.000	30.985	AV

Engineer: Brgant	
Site: AC5	Time: 2013/09/02 - 20:53
Limit: FCC_Part15.209_RE(3m)	Margin: 0
Probe: BBHA 9120D_499(1-18GHz)	Polarity: Vertical
EUT: Router	Power: AC 120V/60Hz
Note: Mode2:Transmit at channel 2462MHz by 802.11g	

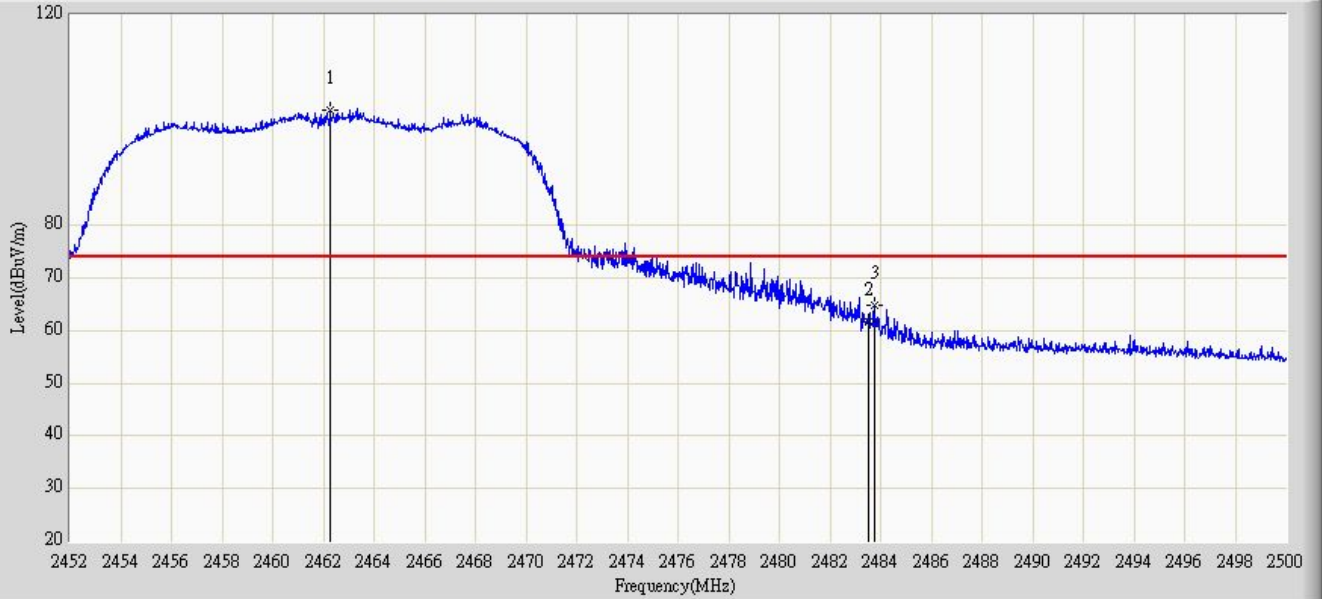

No	Flag	Mark	Frequency (MHz)	Measure Level (dBuV/m)	Reading Level (dBuV)	Over Limit (dB)	Limit (dBuV/m)	Factor	Type
1		*	2462.272	101.784	70.851	N/A	N/A	30.932	PK
2			2483.500	61.806	30.821	-12.194	74.000	30.985	PK
3			2483.752	64.740	33.754	-9.260	74.000	30.987	PK

Engineer: Brgant	
Site: AC5	Time: 2013/09/02 - 20:55
Limit: FCC_Part15.209_RE(3m)	Margin: 0
Probe: BBHA 9120D_499(1-18GHz)	Polarity: Vertical
EUT: Router	Power: AC 120V/60Hz
Note: Mode2:Transmit at channel 2462MHz by 802.11g	

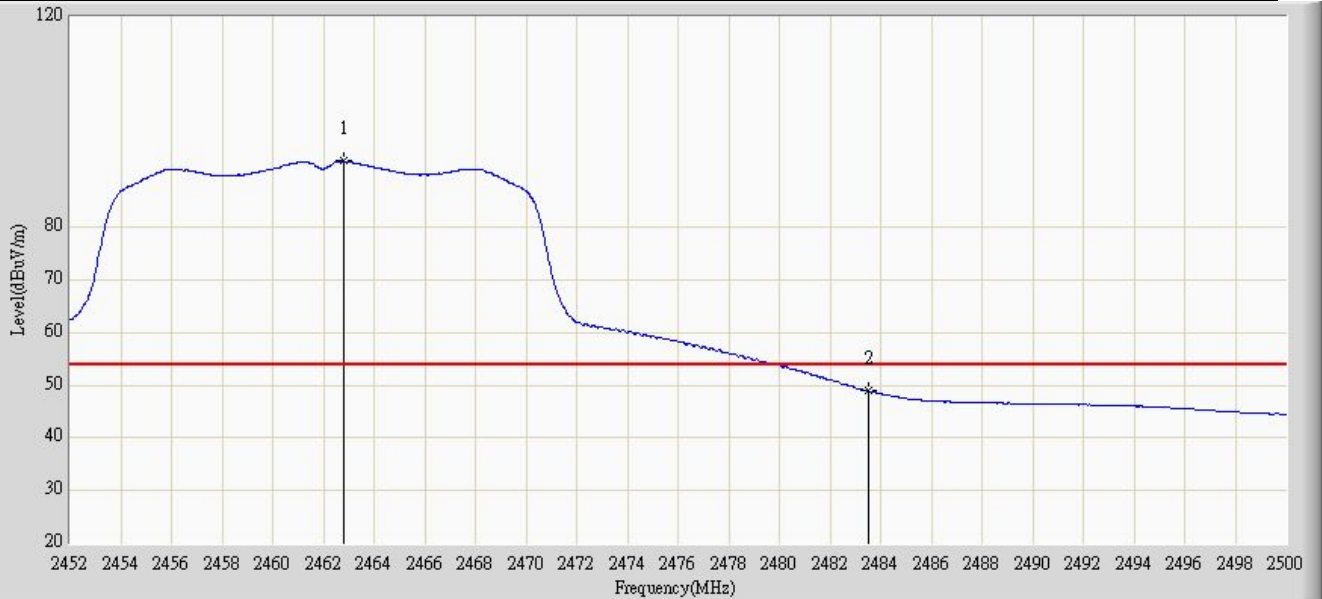

No	Flag	Mark	Frequency (MHz)	Measure Level (dBuV/m)	Reading Level (dBuV)	Over Limit (dB)	Limit (dBuV/m)	Factor	Type
1		*	2462.800	92.573	61.639	N/A	N/A	30.933	AV
2			2483.500	49.016	18.030	-4.984	54.000	30.985	AV

Engineer: Brgant	
Site: AC5	Time: 2013/09/02 - 21:07
Limit: FCC_Part15.209_RE(3m)	Margin: 0
Probe: BBHA 9120D_499(1-18GHz)	Polarity: Horizontal
EUT: Router	Power: AC 120V/60Hz
Note: Mode3:Transmit at channel 2412MHz by 802.11n20MHz	

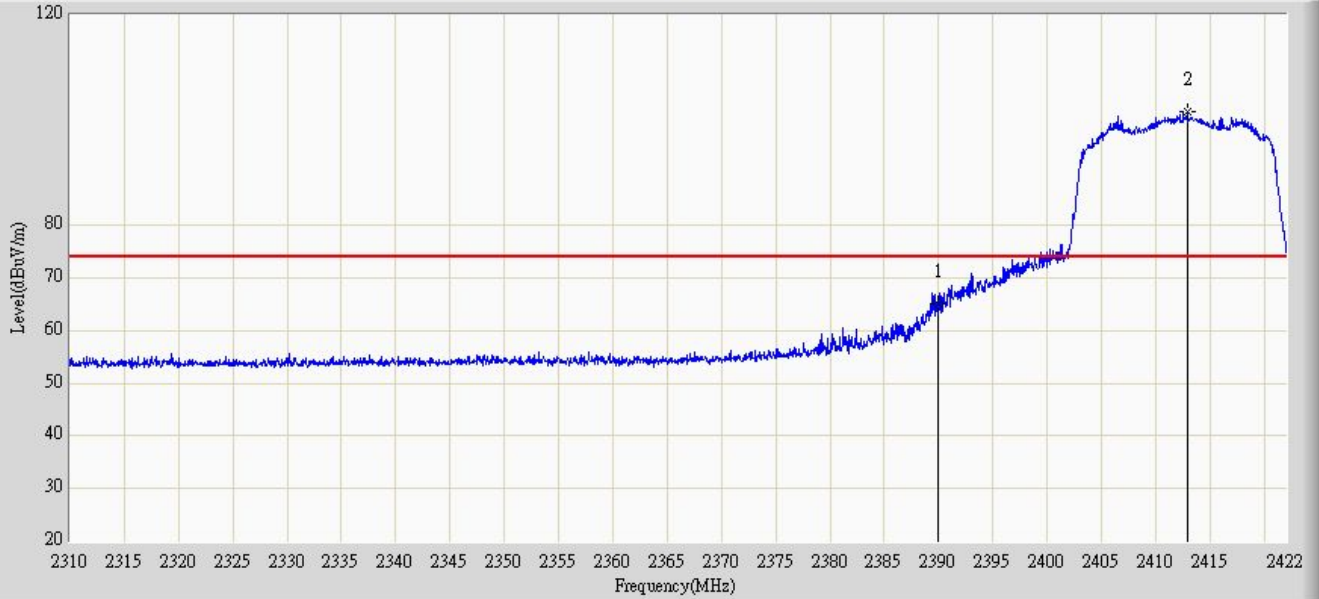

No	Flag	Mark	Frequency (MHz)	Measure Level (dBuV/m)	Reading Level (dBuV)	Over Limit (dB)	Limit (dBuV/m)	Factor	Type
1			2390.000	65.005	34.265	-8.995	74.000	30.740	PK
2		*	2412.928	101.610	70.814	N/A	N/A	30.795	PK

Engineer: Brgant	
Site: AC5	Time: 2013/09/02 - 21:10
Limit: FCC_Part15.209_RE(3m)	Margin: 0
Probe: BBHA 9120D_499(1-18GHz)	Polarity: Horizontal
EUT: Router	Power: AC 120V/60Hz
Note: Mode3:Transmit at channel 2412MHz by 802.11n20MHz	

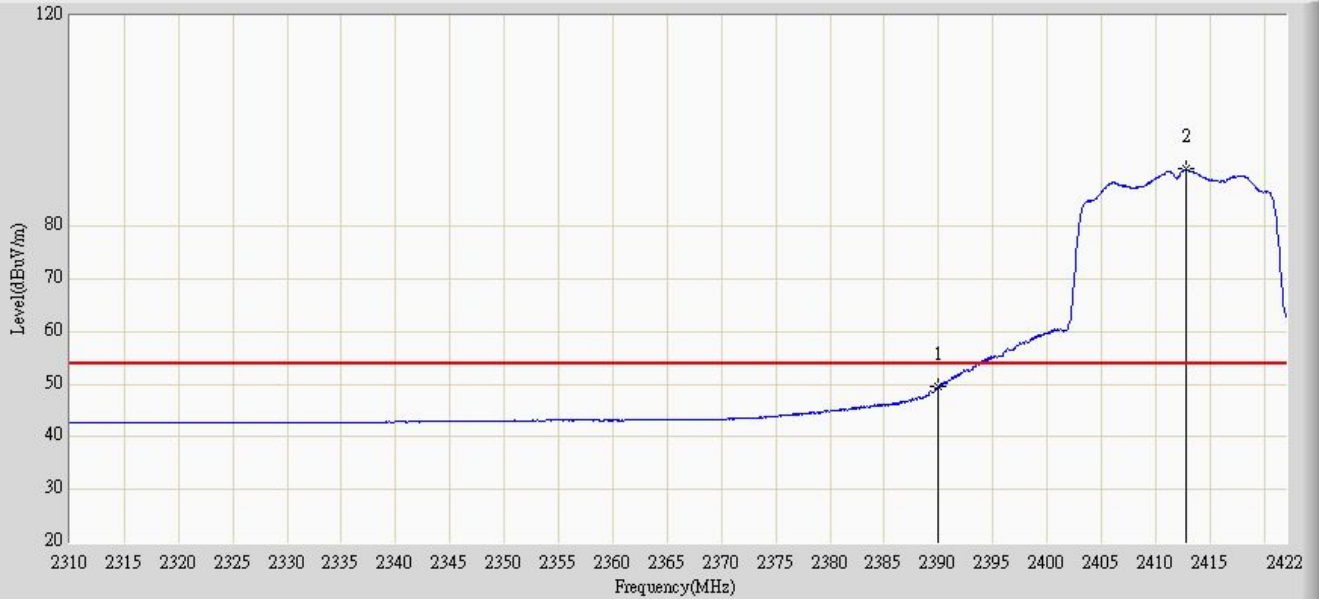

No	Flag	Mark	Frequency (MHz)	Measure Level (dBuV/m)	Reading Level (dBuV)	Over Limit (dB)	Limit (dBuV/m)	Factor	Type
1			2390.000	49.579	18.839	-4.421	54.000	30.740	AV
2		*	2412.872	90.855	60.059	N/A	N/A	30.795	AV

Engineer: Brgant	
Site: AC5	Time: 2013/09/02 - 21:14
Limit: FCC_Part15.209_RE(3m)	Margin: 0
Probe: BBHA 9120D_499(1-18GHz)	Polarity: Vertical
EUT: Router	Power: AC 120V/60Hz
Note: Mode3:Transmit at channel 2412MHz by 802.11n20MHz	

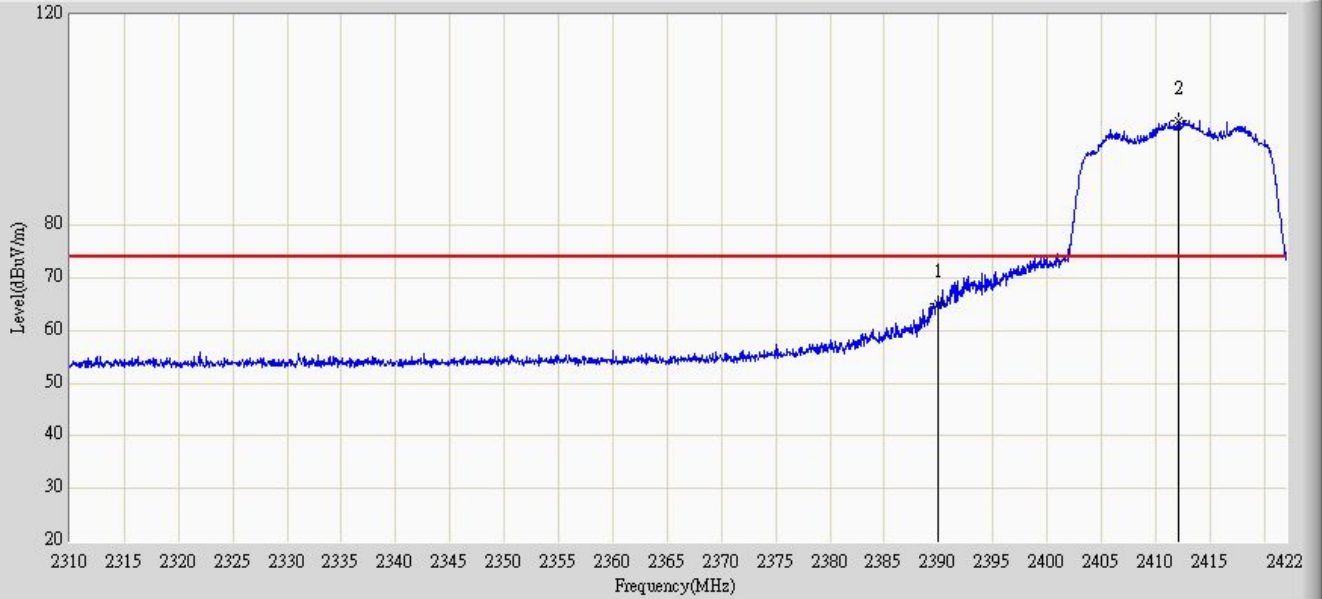

No	Flag	Mark	Frequency (MHz)	Measure Level (dBuV/m)	Reading Level (dBuV)	Over Limit (dB)	Limit (dBuV/m)	Factor	Type
1			2390.000	64.974	34.234	-9.026	74.000	30.740	PK
2		*	2412.144	99.850	69.057	N/A	N/A	30.793	PK

Engineer: Brgant	
Site: AC5	Time: 2013/09/02 - 21:16
Limit: FCC_Part15.209_RE(3m)	Margin: 0
Probe: BBHA 9120D_499(1-18GHz)	Polarity: Vertical
EUT: Router	Power: AC 120V/60Hz
Note: Mode3:Transmit at channel 2412MHz by 802.11n20MHz	

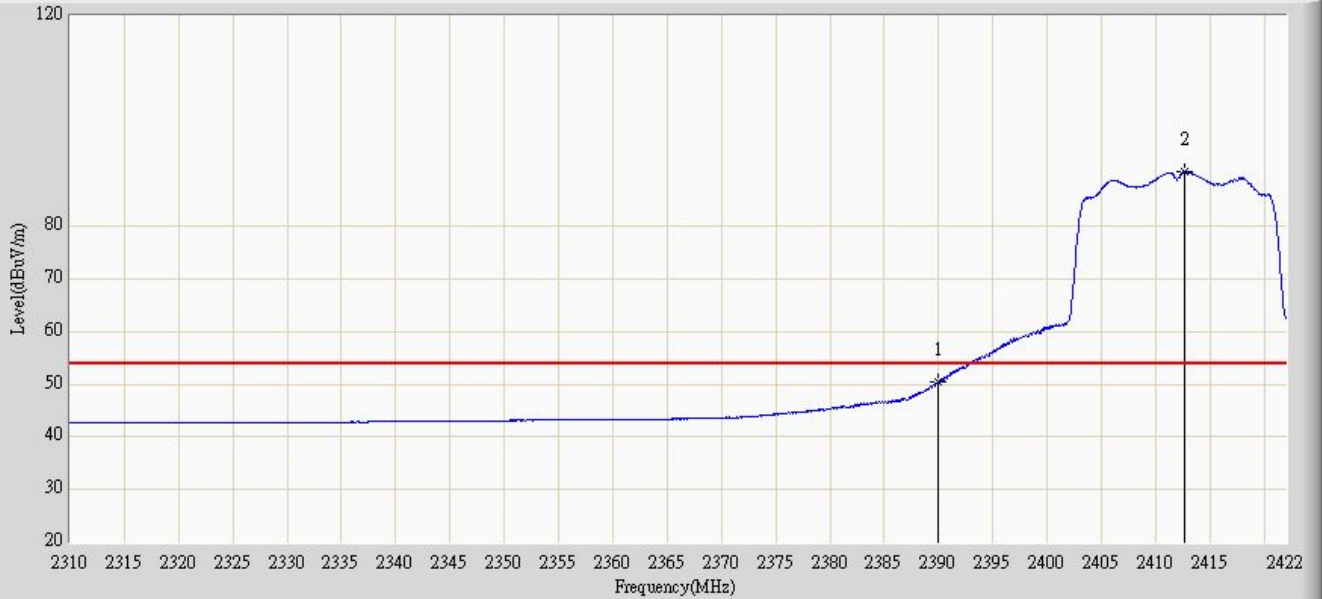

No	Flag	Mark	Frequency (MHz)	Measure Level (dBuV/m)	Reading Level (dBuV)	Over Limit (dB)	Limit (dBuV/m)	Factor	Type
1			2390.000	50.392	19.652	-3.608	54.000	30.740	AV
2		*	2412.648	90.387	59.592	N/A	N/A	30.795	AV

Engineer: Brgant	
Site: AC5	Time: 2013/09/02 - 21:29
Limit: FCC_Part15.209_RE(3m)	Margin: 0
Probe: BBHA 9120D_499(1-18GHz)	Polarity: Horizontal
EUT: Router	Power: AC 120V/60Hz
Note: Mode3:Transmit at channel 2462MHz by 802.11n20MHz	

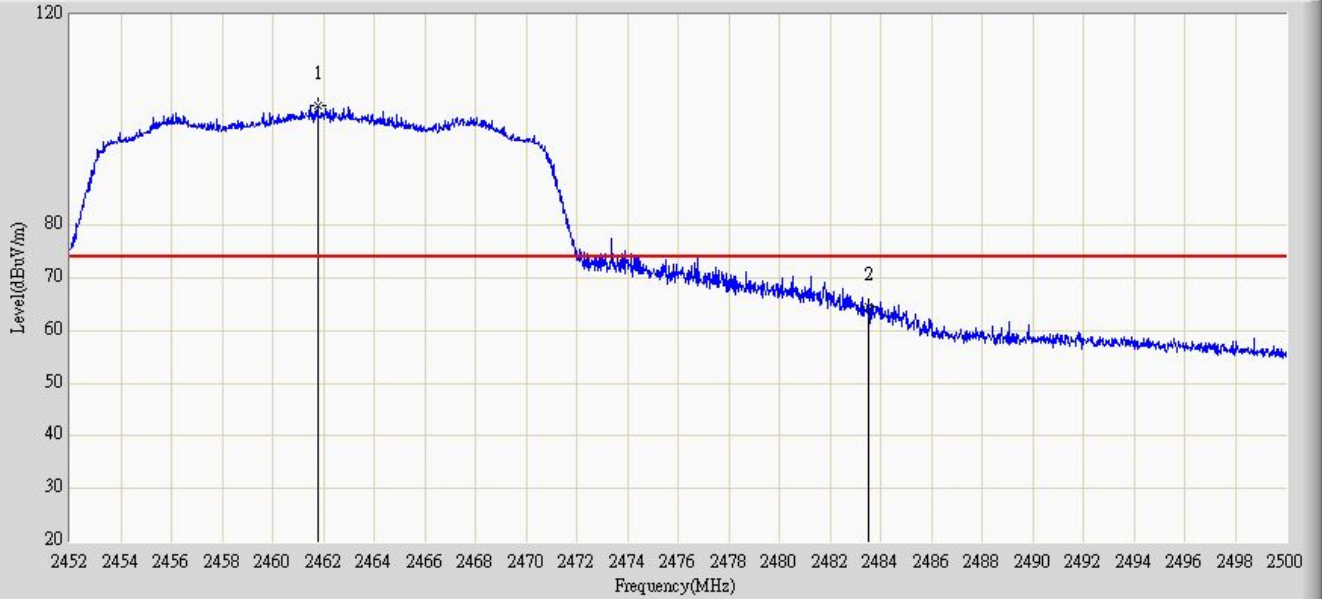

No	Flag	Mark	Frequency (MHz)	Measure Level (dBuV/m)	Reading Level (dBuV)	Over Limit (dB)	Limit (dBuV/m)	Factor	Type
1		*	2461.768	102.700	71.769	N/A	N/A	30.932	PK
2			2483.500	64.513	33.528	-9.487	74.000	30.985	PK

Engineer: Brgant	
Site: AC5	Time: 2013/09/02- 21:31
Limit: FCC_Part15.209_RE(3m)	Margin: 0
Probe: BBHA 9120D_499(1-18GHz)	Polarity: Horizontal
EUT: Router	Power: AC 120V/60Hz
Note: Mode3:Transmit at channel 2462MHz by 802.11n20MHz	



No	Flag	Mark	Frequency (MHz)	Measure Level (dBuV/m)	Reading Level (dBuV)	Over Limit (dB)	Limit (dBuV/m)	Factor	Type
1		*	2462.656	92.026	61.092	N/A	N/A	30.933	AV
2			2483.500	49.746	18.761	-4.254	54.000	30.985	AV

Engineer: Brgant	
Site: AC5	Time: 2013/09/02 - 21:33
Limit: FCC_Part15.209_RE(3m)	Margin: 0
Probe: BBHA 9120D_499(1-18GHz)	Polarity: Vertical
EUT: Router	Power: AC 120V/60Hz
Note: Mode3:Transmit at channel 2462MHz by 802.11n20MHz	

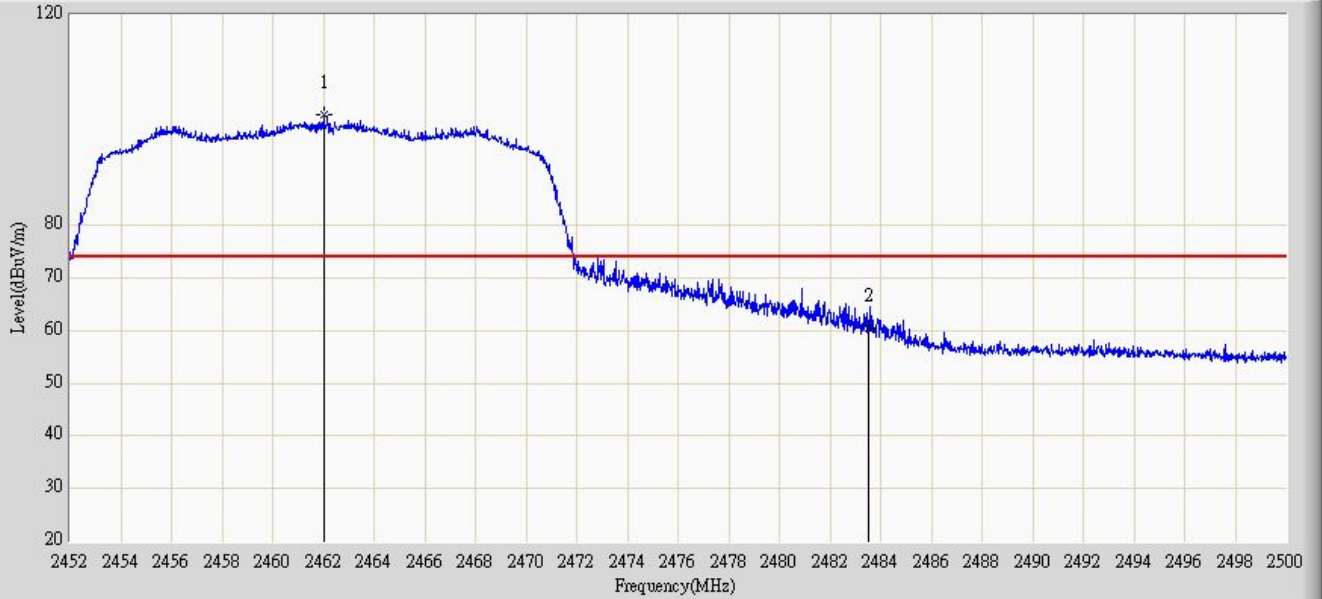

No	Flag	Mark	Frequency (MHz)	Measure Level (dBuV/m)	Reading Level (dBuV)	Over Limit (dB)	Limit (dBuV/m)	Factor	Type
1		*	2462.008	101.013	70.081	N/A	N/A	30.932	PK
2			2483.500	60.657	29.672	-13.343	74.000	30.985	PK

Engineer: Brgant	
Site: AC5	Time: 2013/09/02 - 21:34
Limit: FCC_Part15.209_RE(3m)	Margin: 0
Probe: BBHA 9120D_499(1-18GHz)	Polarity: Vertical
EUT: Router	Power: AC 120V/60Hz
Note: Mode3:Transmit at channel 2462MHz by 802.11n20MHz	

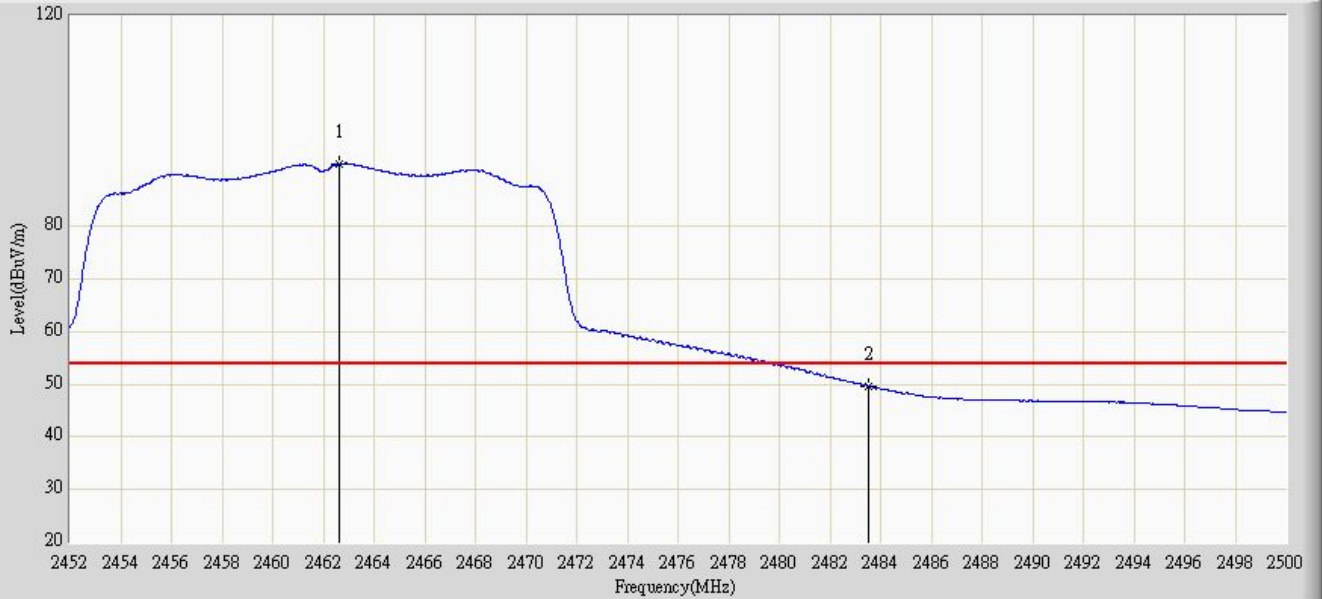

No	Flag	Mark	Frequency (MHz)	Measure Level (dBuV/m)	Reading Level (dBuV)	Over Limit (dB)	Limit (dBuV/m)	Factor	Type
1		*	2462.656	91.901	60.967	N/A	N/A	30.933	AV
2			2483.500	49.578	18.593	-4.422	54.000	30.985	AV

Engineer: Brgant	
Site: AC5	Time: 2013/09/02 - 22:04
Limit: FCC_Part15.209_RE(3m)	Margin: 0
Probe: BBHA 9120D_499(1-18GHz)	Polarity: Horizontal
EUT: Router	Power: AC 120V/60Hz
Note: Mode4:Transmit at channel 2422MHz by 802.11n40MHz	

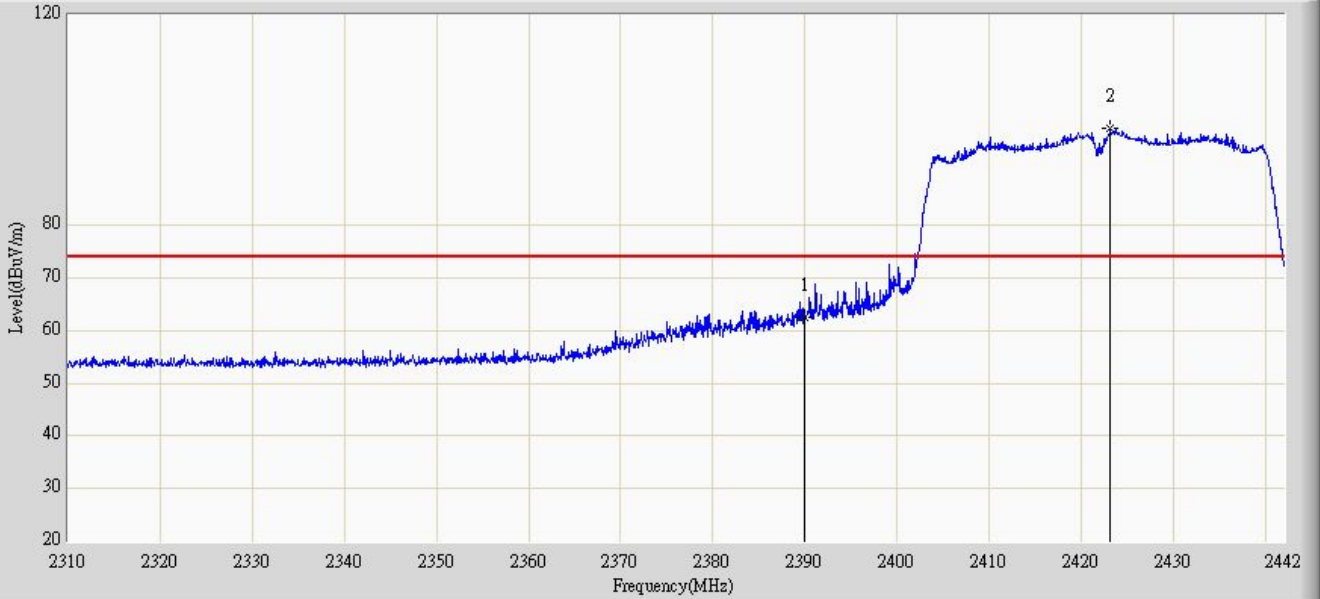

No	Flag	Mark	Frequency (MHz)	Measure Level (dBuV/m)	Reading Level (dBuV)	Over Limit (dB)	Limit (dBuV/m)	Factor	Type
1			2390.000	62.569	31.829	-11.431	74.000	30.740	PK
2		*	2423.124	98.456	67.630	N/A	N/A	30.825	PK

Engineer: Brgant	
Site: AC5	Time: 2013/09/02 - 22:07
Limit: FCC_Part15.209_RE(3m)	Margin: 0
Probe: BBHA 9120D_499(1-18GHz)	Polarity: Horizontal
EUT: Router	Power: AC 120V/60Hz
Note: Mode4:Transmit at channel 2422MHz by 802.11n40MHz	

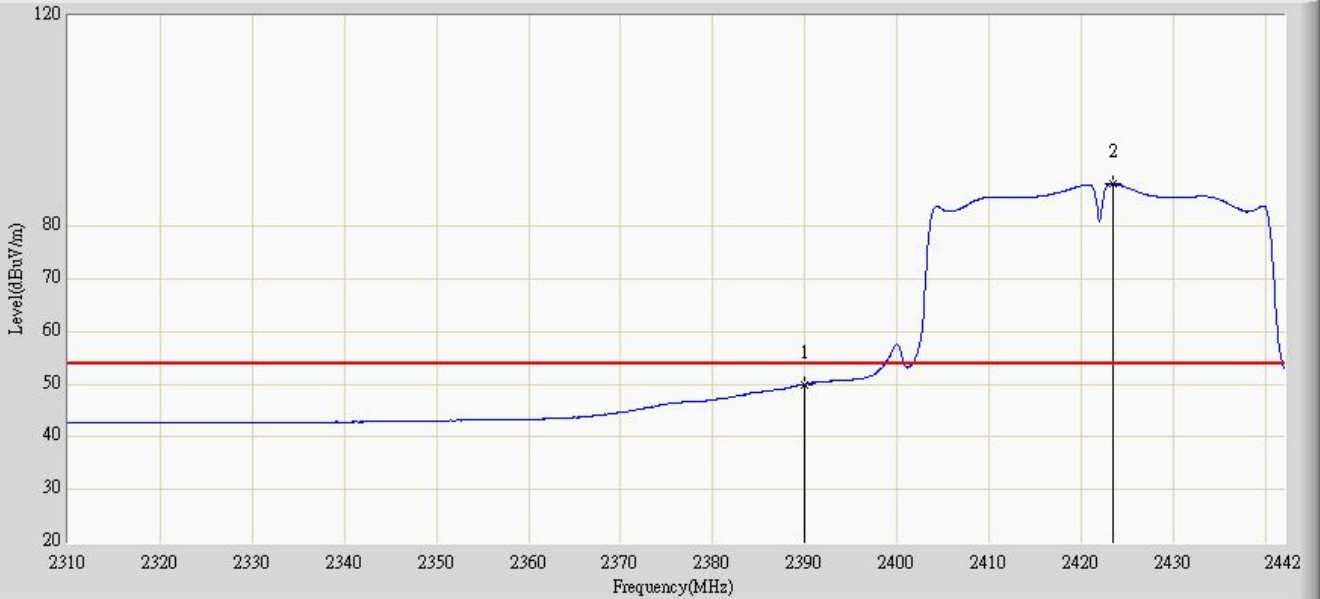

No	Flag	Mark	Frequency (MHz)	Measure Level (dBuV/m)	Reading Level (dBuV)	Over Limit (dB)	Limit (dBuV/m)	Factor	Type
1			2390.000	50.026	19.286	-3.974	54.000	30.740	AV
2		*	2423.454	88.067	57.240	N/A	N/A	30.827	AV

Engineer: Brgant	
Site: AC5	Time: 2013/09/02 - 22:10
Limit: FCC_Part15.209_RE(3m)	Margin: 0
Probe: BBHA 9120D_499(1-18GHz)	Polarity: Vertical
EUT: Router	Power: AC 120V/60Hz
Note: Mode4:Transmit at channel 2422MHz by 802.11n40MHz	

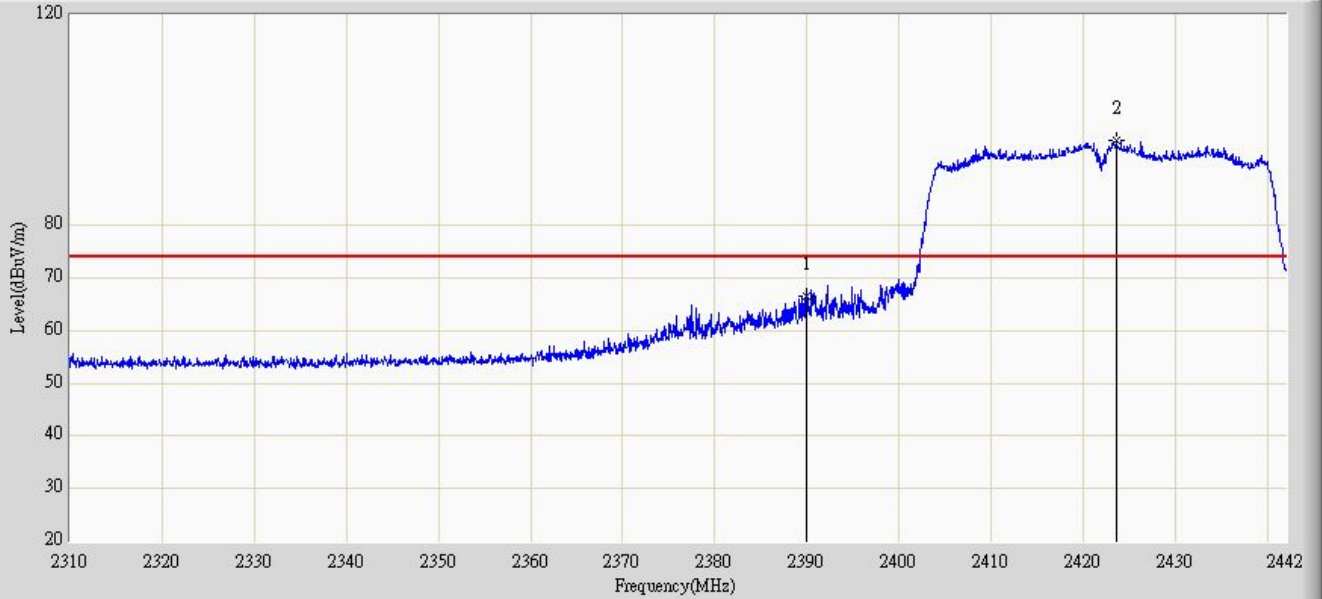

No	Flag	Mark	Frequency (MHz)	Measure Level (dBuV/m)	Reading Level (dBuV)	Over Limit (dB)	Limit (dBuV/m)	Factor	Type
1			2390.000	66.517	35.777	-7.483	74.000	30.740	PK
2		*	2423.586	96.046	65.219	N/A	N/A	30.827	PK

Engineer: Brgant	
Site: AC5	Time: 2013/09/02 - 22:12
Limit: FCC_Part15.209_RE(3m)	Margin: 0
Probe: BBHA 9120D_499(1-18GHz)	Polarity: Vertical
EUT: Router	Power: AC 120V/60Hz
Note: Mode4:Transmit at channel 2422MHz by 802.11n40MHz	

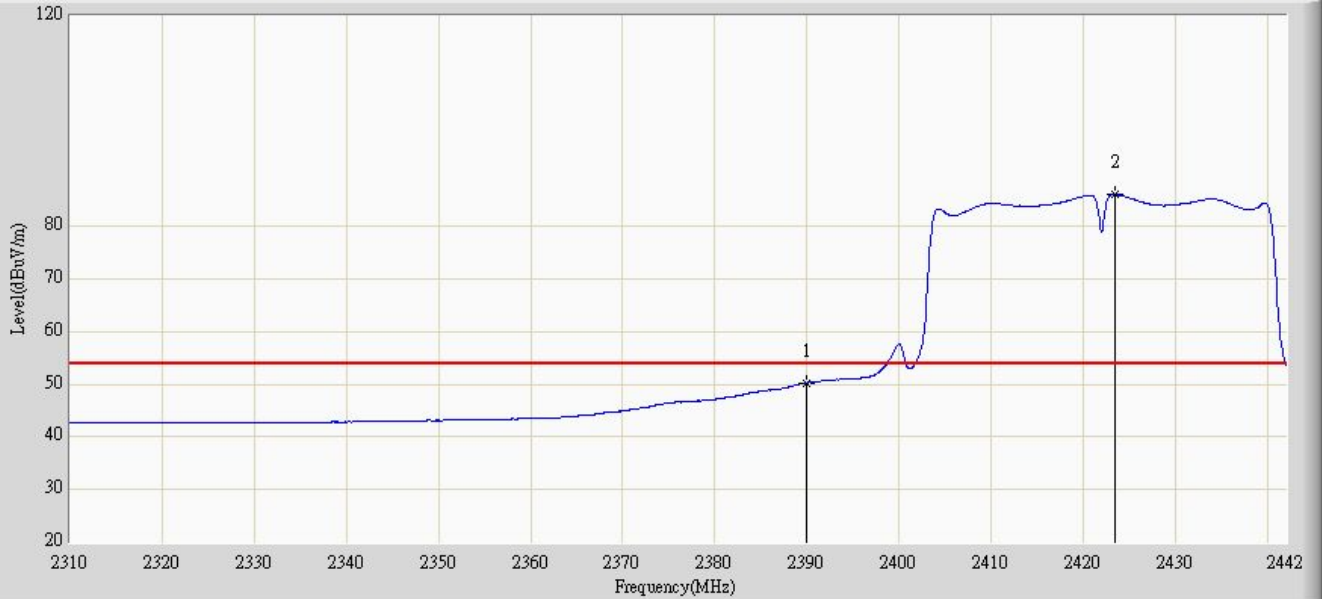

No	Flag	Mark	Frequency (MHz)	Measure Level (dBuV/m)	Reading Level (dBuV)	Over Limit (dB)	Limit (dBuV/m)	Factor	Type
1			2390.000	50.247	19.507	-3.753	54.000	30.740	AV
2		*	2423.454	86.032	55.205	N/A	N/A	30.827	AV

Engineer: Brgant	
Site: AC5	Time: 2013/09/02 - 22:24
Limit: FCC_Part15.209_RE(3m)	Margin: 0
Probe: BBHA 9120D_499(1-18GHz)	Polarity: Horizontal
EUT: Router	Power: AC 120V/60Hz
Note: Mode4:Transmit at channel 2452MHz by 802.11n40MHz	

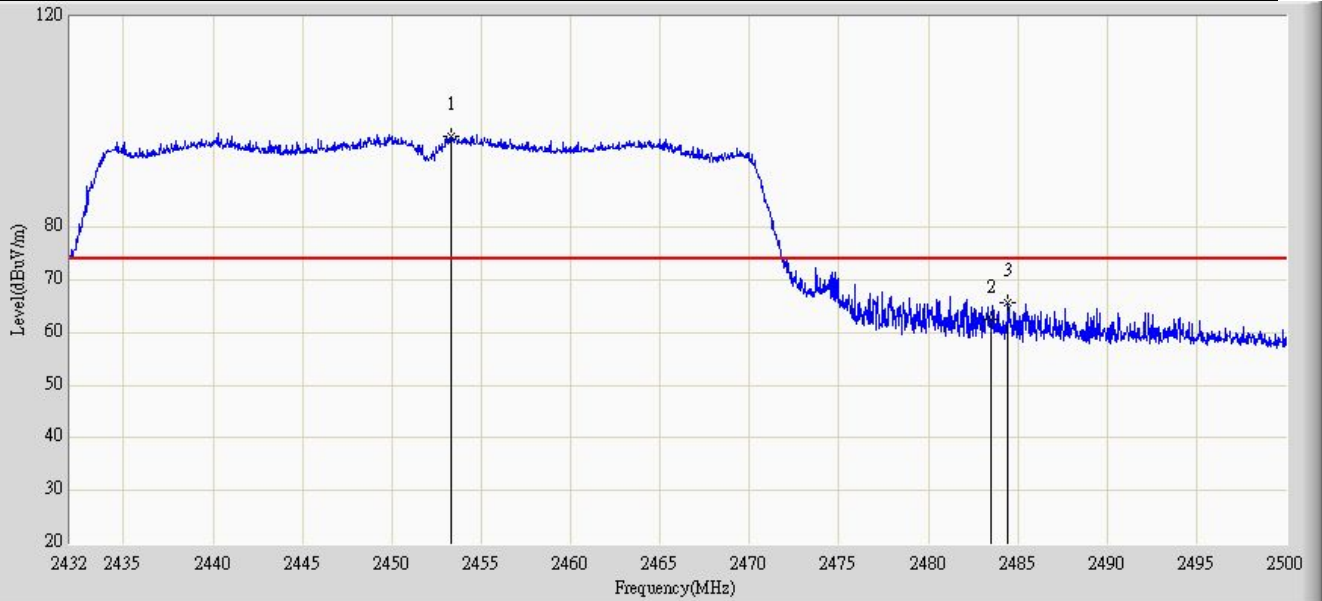

No	Flag	Mark	Frequency (MHz)	Measure Level (dBuV/m)	Reading Level (dBuV)	Over Limit (dB)	Limit (dBuV/m)	Factor	Type
1		*	2453.284	97.222	66.316	N/A	N/A	30.906	PK
2			2483.500	62.481	31.496	-11.519	74.000	30.985	PK
3			2484.462	65.735	34.747	-8.265	74.000	30.988	PK

Engineer: Brgant	
Site: AC5	Time: 2013/09/02 - 22:27
Limit: FCC_Part15.209_RE(3m)	Margin: 0
Probe: BBHA 9120D_499(1-18GHz)	Polarity: Horizontal
EUT: Router	Power: AC 120V/60Hz
Note: Mode4:Transmit at channel 2452MHz by 802.11n40MHz	

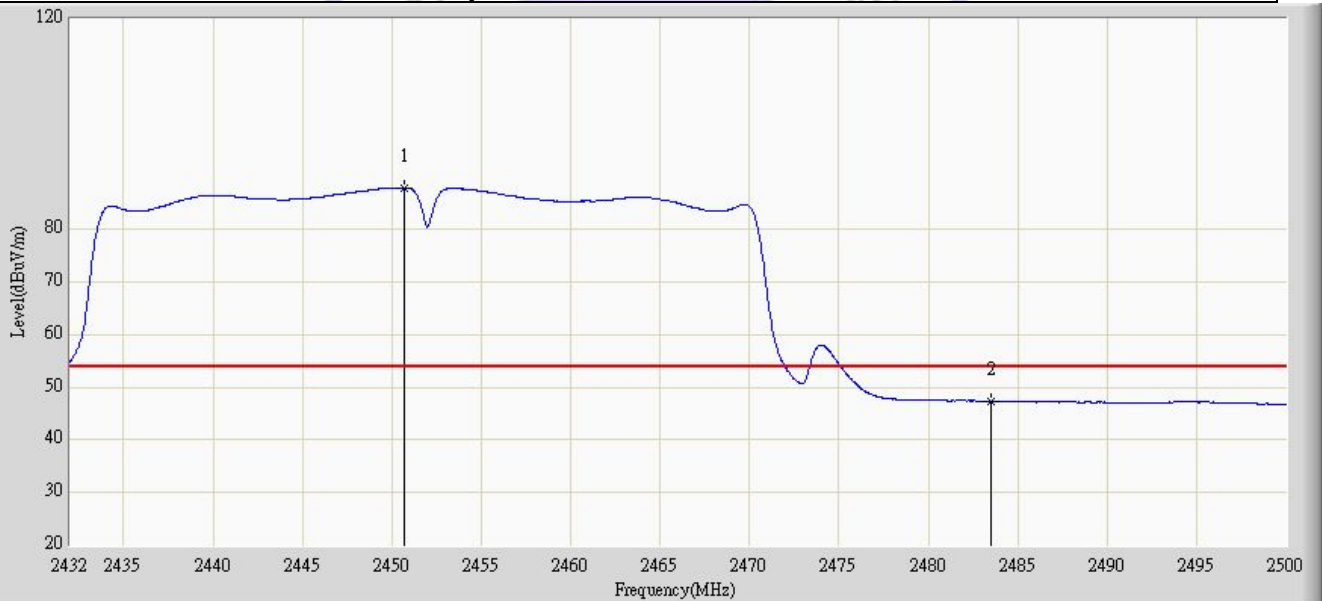

No	Flag	Mark	Frequency (MHz)	Measure Level (dBuV/m)	Reading Level (dBuV)	Over Limit (dB)	Limit (dBuV/m)	Factor	Type
1		*	2450.666	87.877	56.979	N/A	N/A	30.898	AV
2			2483.500	47.367	16.382	-6.633	54.000	30.985	AV

Engineer: Brgant	
Site: AC5	Time: 2013/09/02 - 22:29
Limit: FCC_Part15.209_RE(3m)	Margin: 0
Probe: BBHA 9120D_499(1-18GHz)	Polarity: Vertical
EUT: Router	Power: AC 120V/60Hz
Note: Mode4:Transmit at channel 2452MHz by 802.11n40MHz	

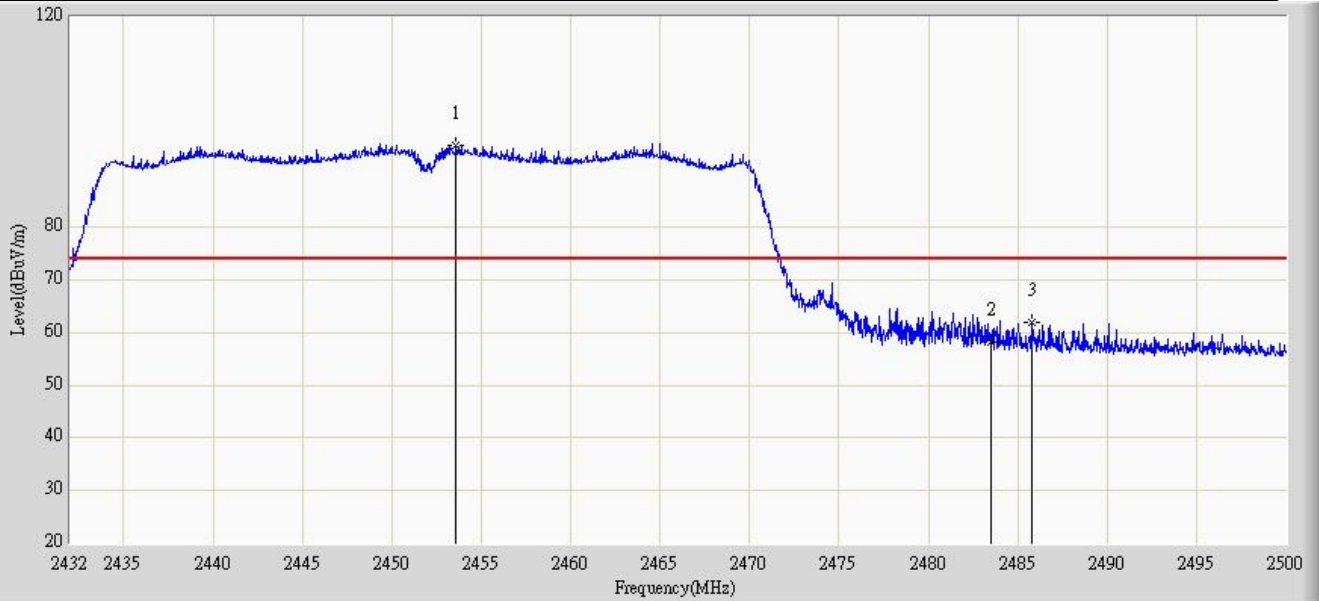

No	Flag	Mark	Frequency (MHz)	Measure Level (dBuV/m)	Reading Level (dBuV)	Over Limit (dB)	Limit (dBuV/m)	Factor	Type
1		*	2453.590	95.623	64.716	N/A	N/A	30.907	PK
2			2483.500	58.344	27.359	-15.656	74.000	30.985	PK
3			2485.788	62.028	31.036	-11.972	74.000	30.992	PK

Engineer: Brgant	
Site: AC5	Time: 2013/09/02 - 22:31
Limit: FCC_Part15.209_RE(3m)	Margin: 0
Probe: BBHA 9120D_499(1-18GHz)	Polarity: Vertical
EUT: Router	Power: AC 120V/60Hz
Note: Mode4:Transmit at channel 2452MHz by 802.11n40MHz	

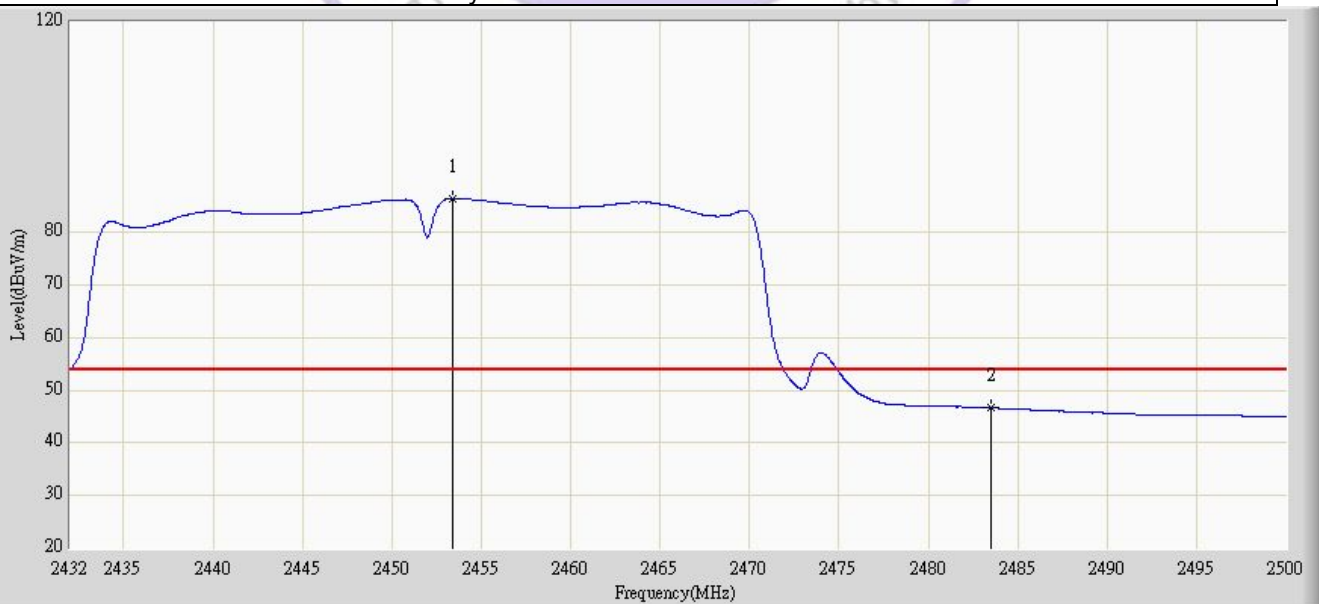

No	Flag	Mark	Frequency (MHz)	Measure Level (dBuV/m)	Reading Level (dBuV)	Over Limit (dB)	Limit (dBuV/m)	Factor	Type
1		*	2453.420	86.346	55.440	N/A	N/A	30.906	AV
2			2483.500	46.700	15.714	-7.300	54.000	30.985	AV

4.6. Power Spectral Density Measurement

TEST CONFIGURATION

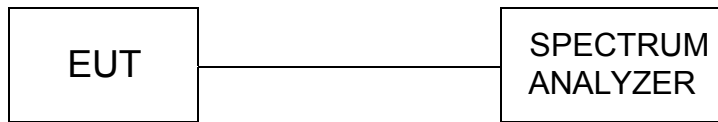

TEST PROCEDURE

The EUT was tested according to KDB558074 D01 v03r01 for compliance to FCC 47CFR 15.247 requirements.

Set RBW= 3 kHz, VBW \geq 10KHz, SPAN to 1.5 times greater than the EBW,.

LIMIT

For digitally modulated systems, the power spectral density conducted from the intentional radiator to the antenna shall not be greater than 8 dBm in any 3 kHz band during any time interval of continuous transmission.

TEST RESULTS

Product	:	Router
Test Item	:	Power Spectral Density
Test Mode	:	Mode 1: Transmit by 802.11b

Channel No.	Frequency (MHz)	Measurement PPSD (dBm)	Limit (dBm/3kHz)	Result
01	2412	-10.51	8	Pass
06	2437	-9.98	8	Pass
11	2462	-9.78	8	Pass

Channel 01 (2412MHz)

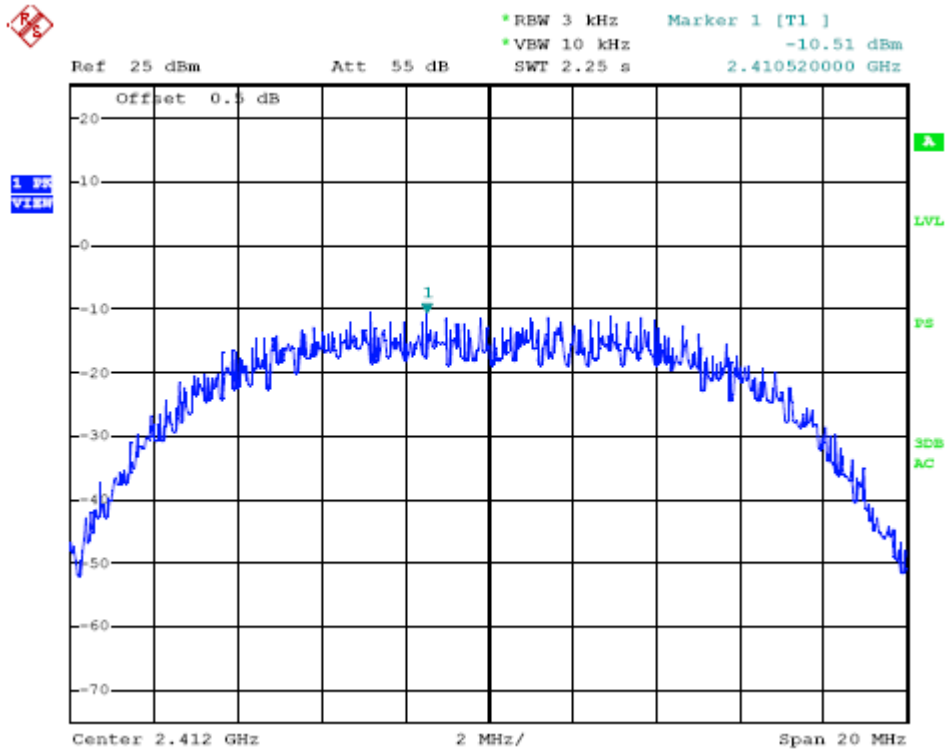

Channel 06 (2437MHz)

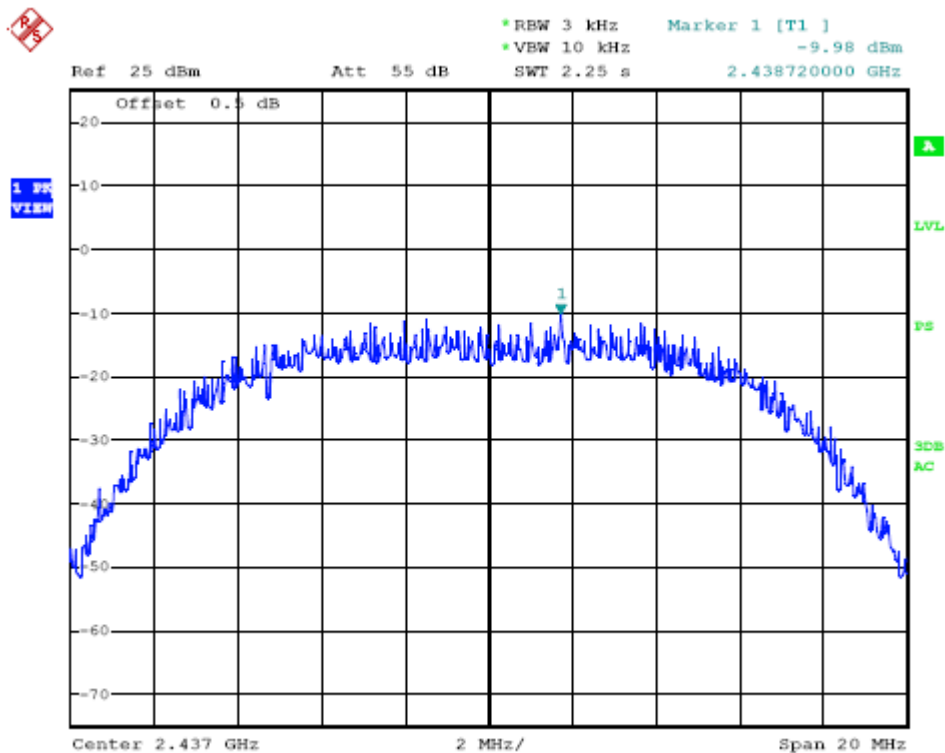

Channel 11 (2462MHz)

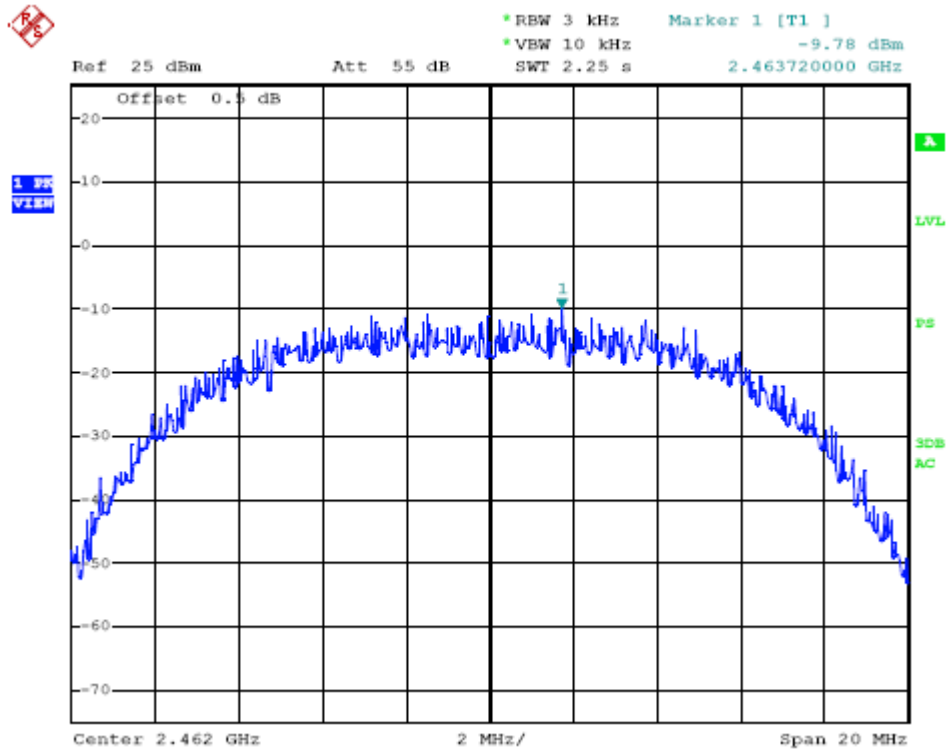

Product	:	Router
Test Item	:	Power Spectral Density
Test Mode	:	Mode 2: Transmit by 802.11g

Channel No.	Frequency (MHz)	Measurement PPSD (dBm)	Limit (dBm/3kHz)	Result
01	2412	-15.33	8	Pass
06	2437	-16.00	8	Pass
11	2462	-14.76	8	Pass

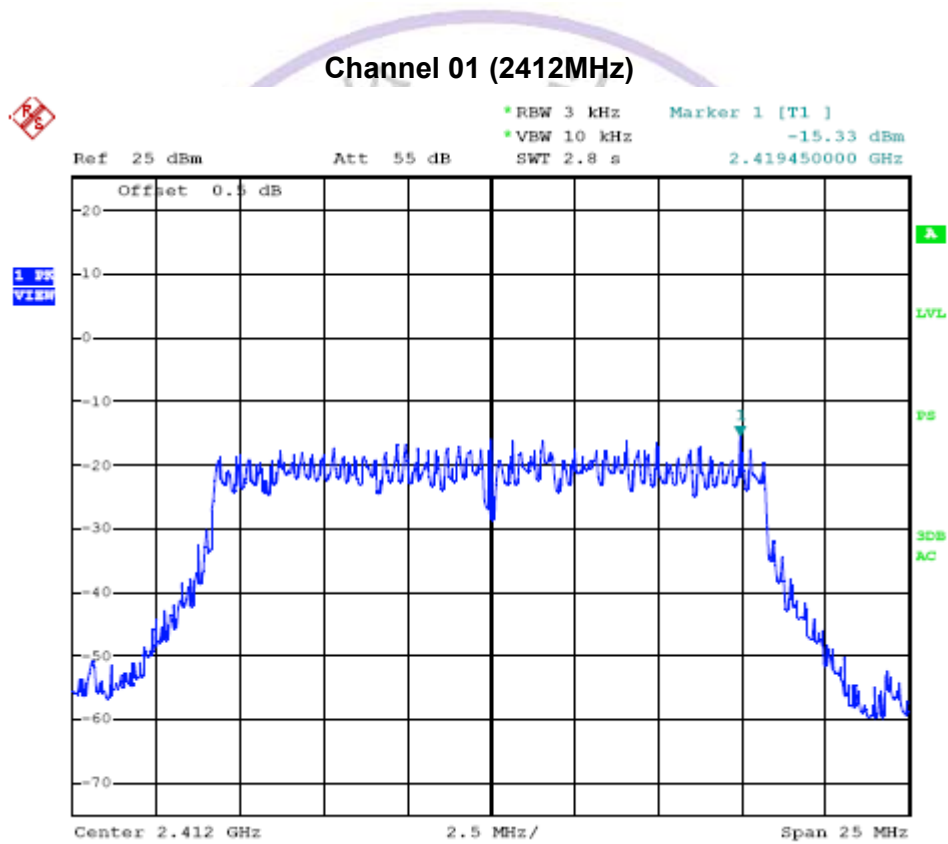

Channel 06 (2437MHz)



*RBW 3 kHz Marker 1 [T1]
VBW 10 kHz -16.00 dBm
SWT 2.8 s 2.439450000 GHz

Ref 25 dBm Att 60 dB

1 PP
MAXH

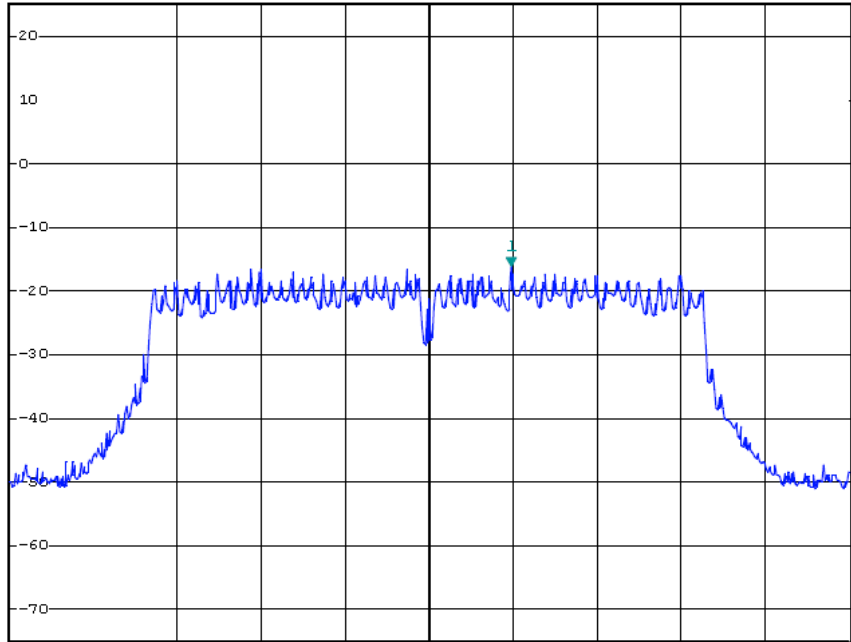

Center 2.437 GHz 2.5 MHz/ Span 25 MHz

Channel 11 (2462MHz)



*RBW 3 kHz Marker 1 [T1]
VBW 10 kHz -14.76 dBm
SWT 2.8 s 2.462000000 GHz

Ref 25 dBm Att 55 dB

1 PP
VIEW

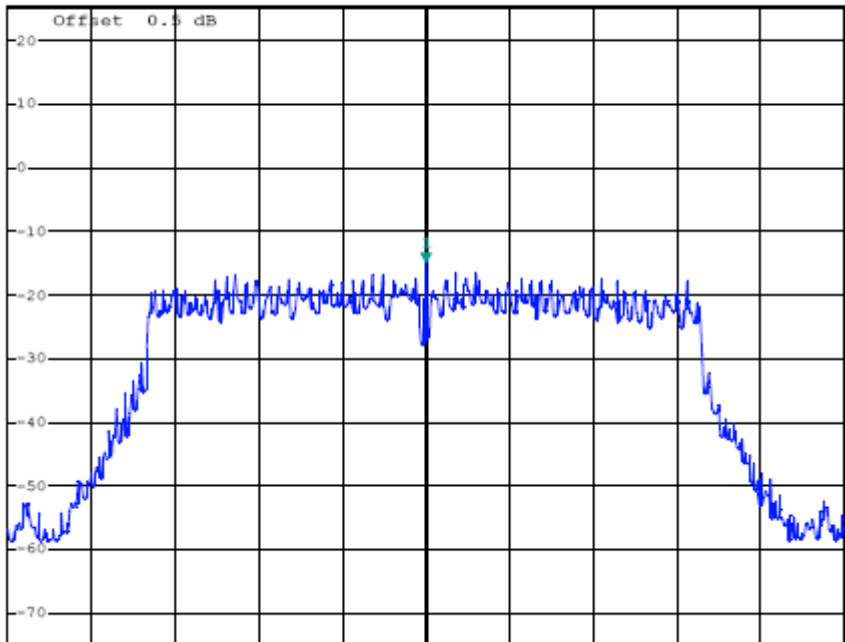

Center 2.462 GHz 2.5 MHz/ Span 25 MHz

Product	:	Router
Test Item	:	Power Spectral Density
Test Mode	:	Mode 3: Transmit by 802.11n (20MHz)

Channel No.	Frequency (MHz)	Measurement PPSD (dBm)	Limit (dBm/3kHz)	Result
01	2412	-14.43	8	Pass
06	2437	-15.07	8	Pass
11	2462	-13.96	8	Pass

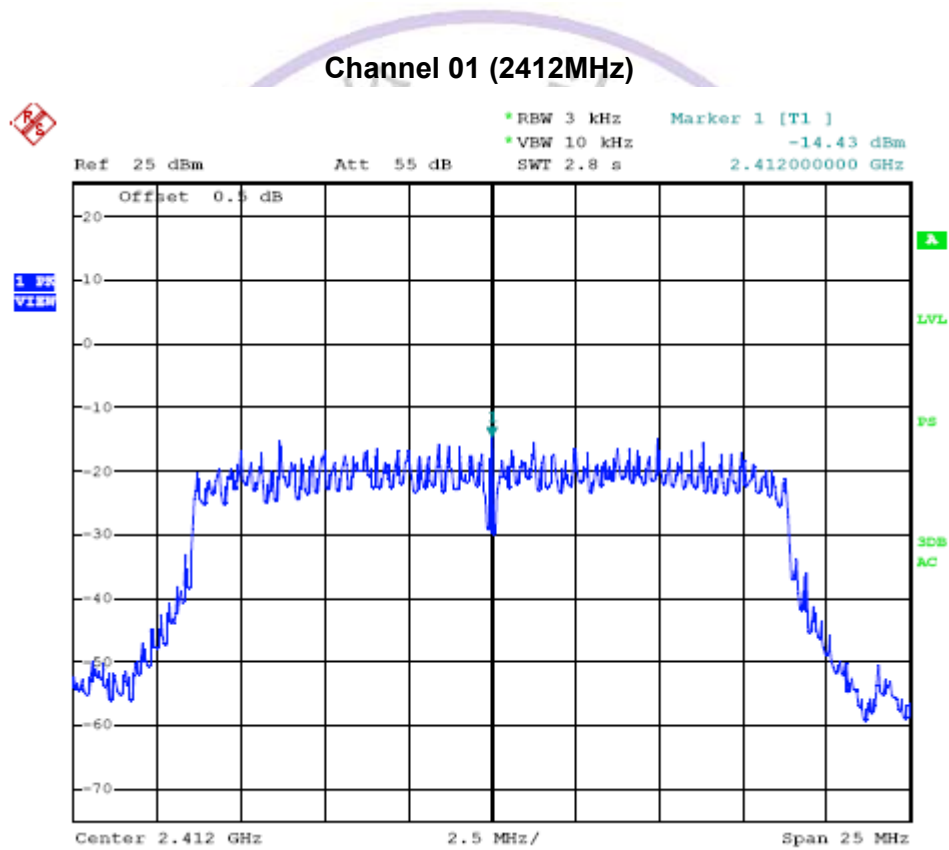

Product	:	Router
Test Item	:	Power Spectral Density
Test Mode	:	Mode 4: Transmit by 802.11n (40MHz)

Channel No.	Frequency (MHz)	Measurement PPSD (dBm)	Limit (dBm/3kHz)	Result
03	2422	-18.85	8	Pass
06	2437	-18.38	8	Pass
09	2452	-18.28	8	Pass

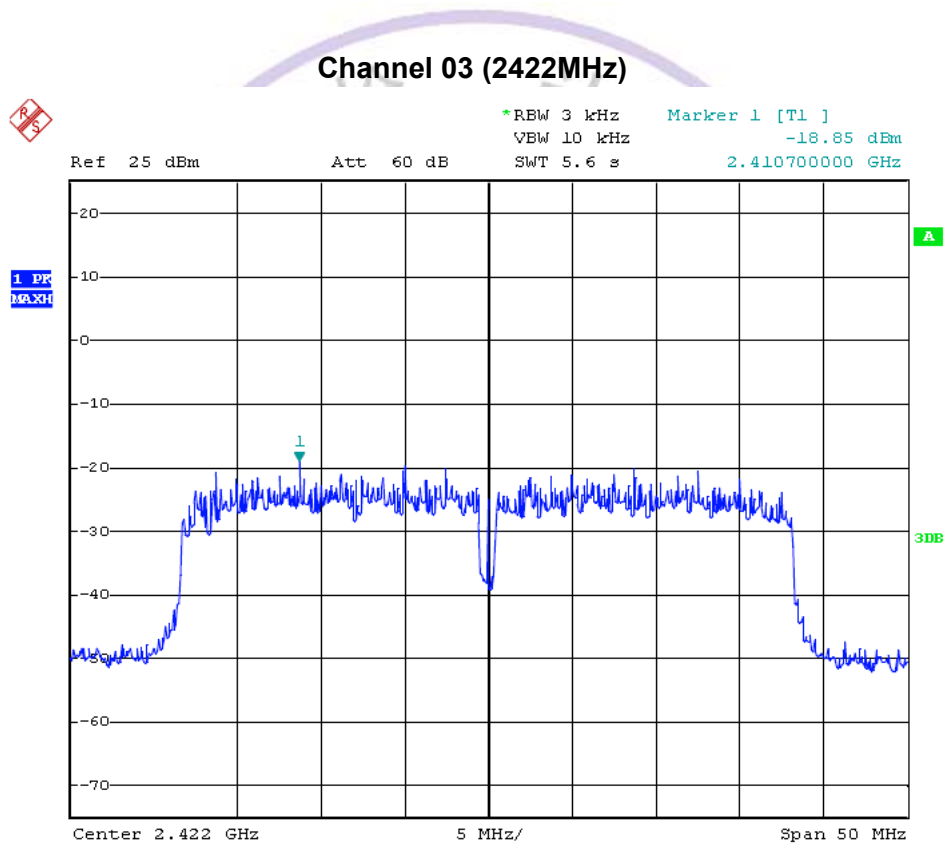

4.7. Spurious RF Conducted Emission

TEST CONFIGURATION

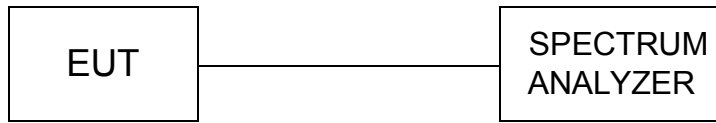

TEST PROCEDURE

The EUT was tested according to KDB558074 D01 v03r01 for compliance to FCC 47CFR 15.247 requirements. The Spurious RF conducted emissions compliance of RF radiated emission should be measured by following the guidance in ANSI C63.10-2009 with respect to maximizing the emission by rotating the EUT, measuring the emission while the EUT is situated in three orthogonal planes (if appropriate), adjusting the measurement antenna height and polarization etc. Set RBW=100kHz and VBM= 300KHz to measure the peak field strength , and measure frequency range from 30MHz to 26.5GHz.

LIMIT

In any 100 kHz bandwidth outside the frequency band in which the spread spectrum or digitally modulated intentional radiator is operating, the radio frequency power that is produced by the intentional radiator shall be at least 20 dB below that in the 100 kHz bandwidth within the band that contains the highest level of the desired power, based on either an RF conducted or a radiated measurement, provided the transmitter demonstrates compliance with the peak conducted power limits.

TEST RESULTS

Product	:	Router
Test Item	:	RF Antenna Conducted Spurious
Test Mode	:	Mode 1: Transmit by 802.11b

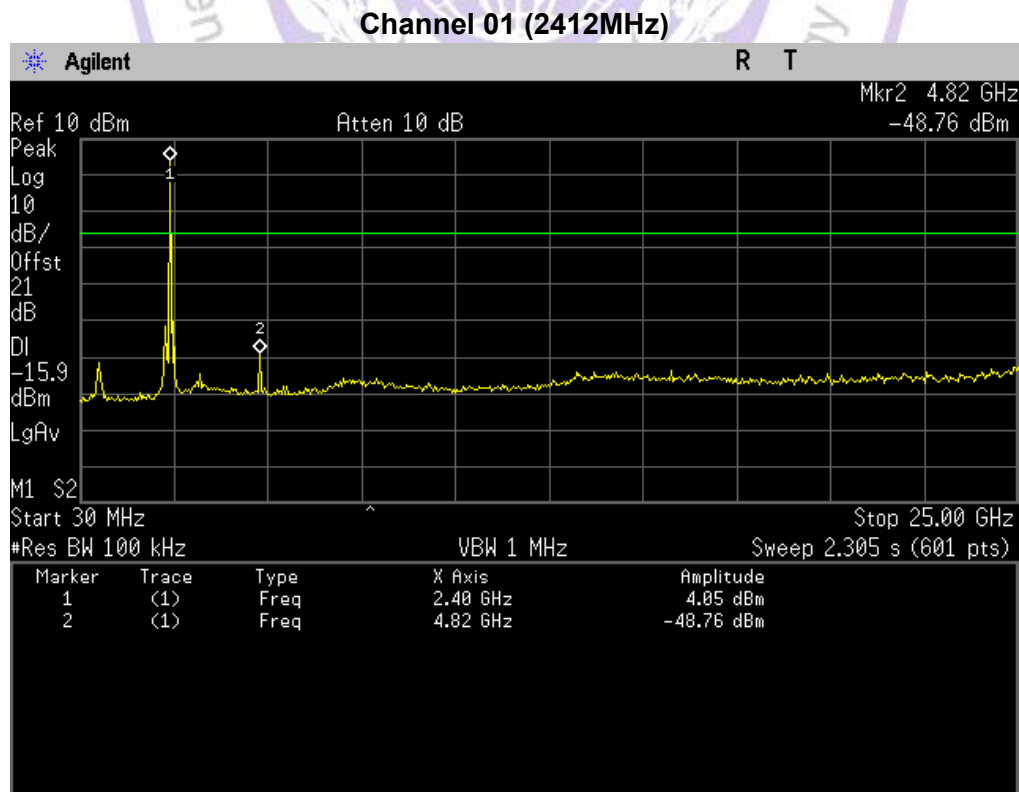

Channel 06 (2437MHz)

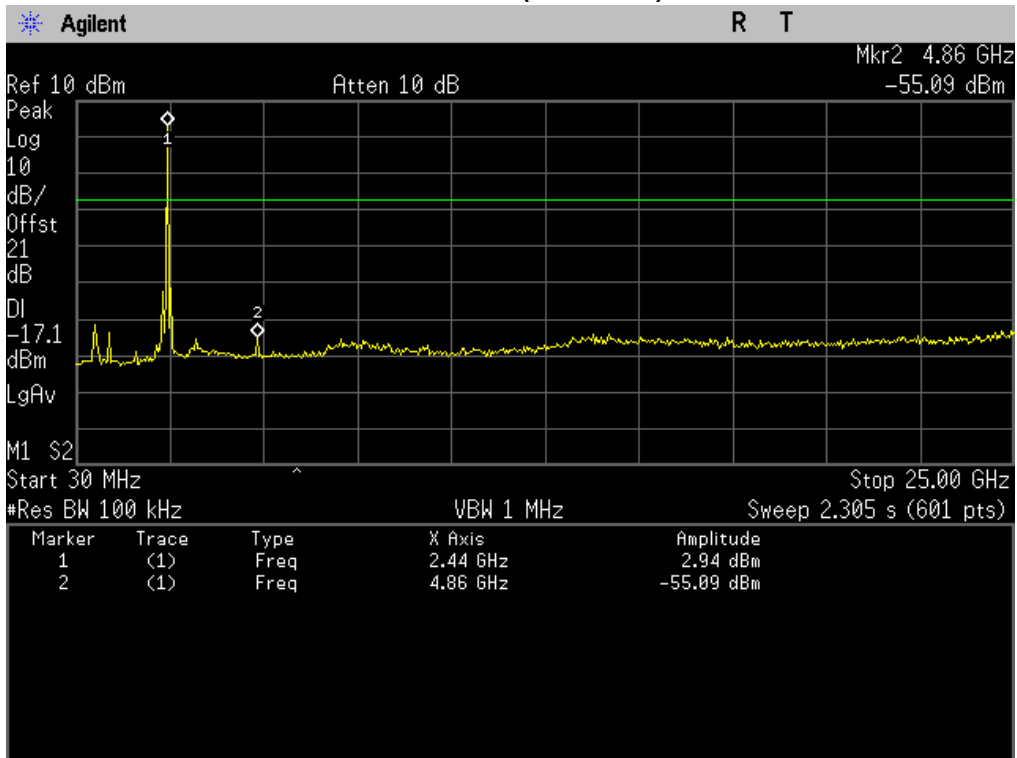

Channel 11 (2462MHz)

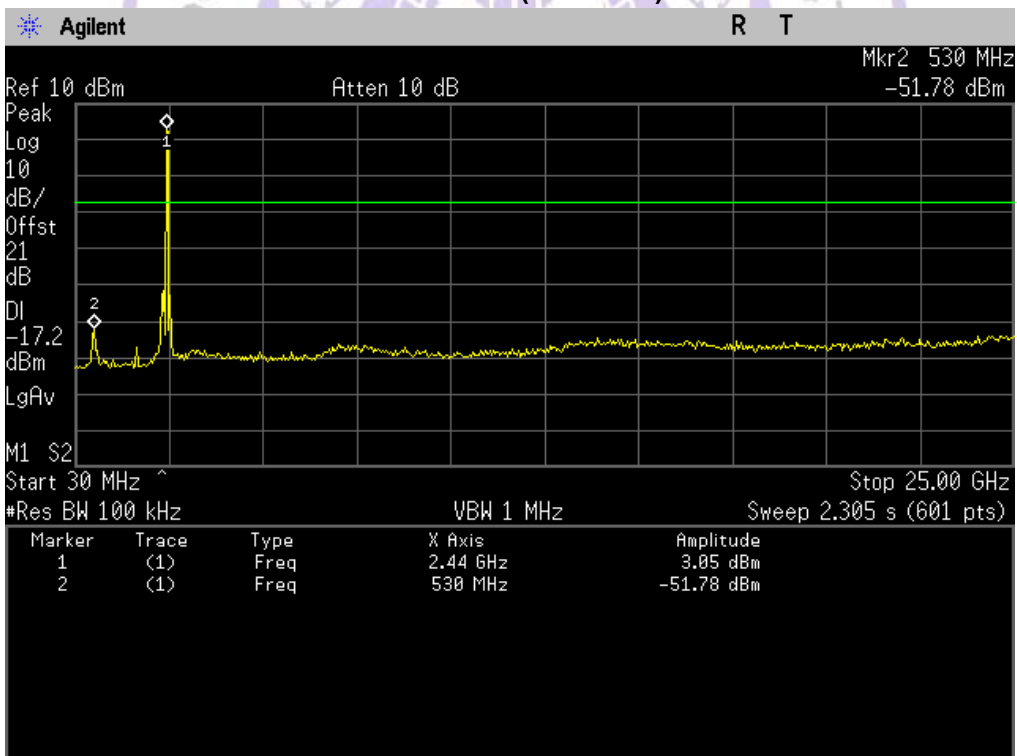

Product	:	Router
Test Item	:	RF Antenna Conducted Spurious
Test Mode	:	Mode 2: Transmit by 802.11g

Channel 01 (2412MHz)

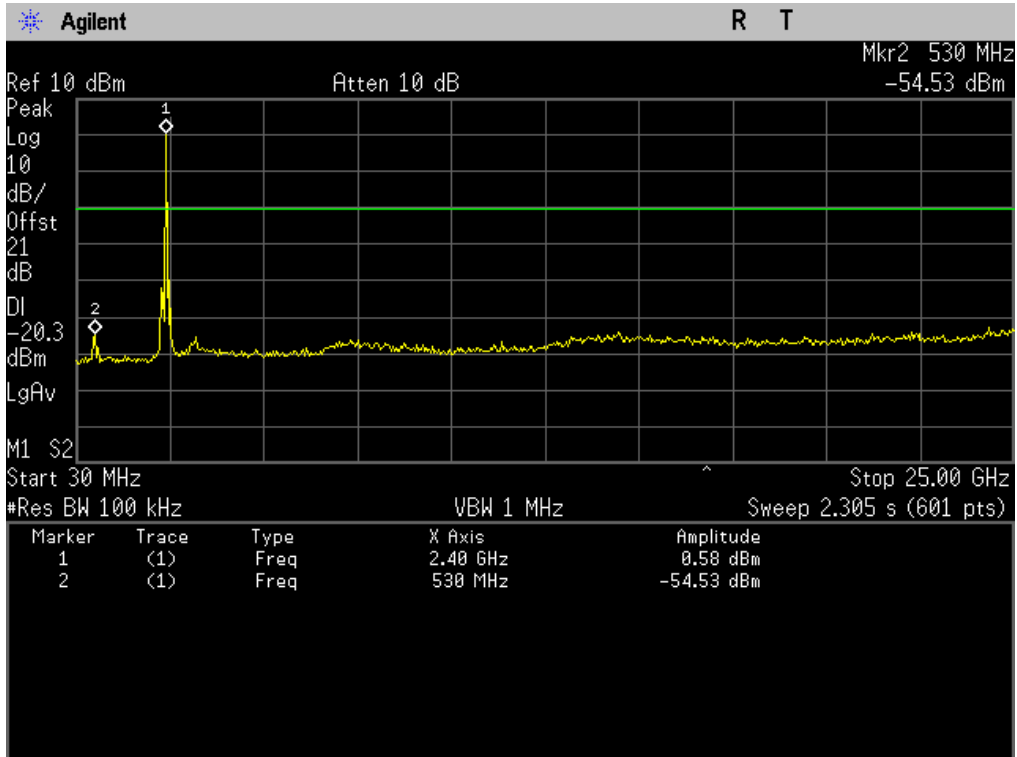

Channel 06 (2437MHz)

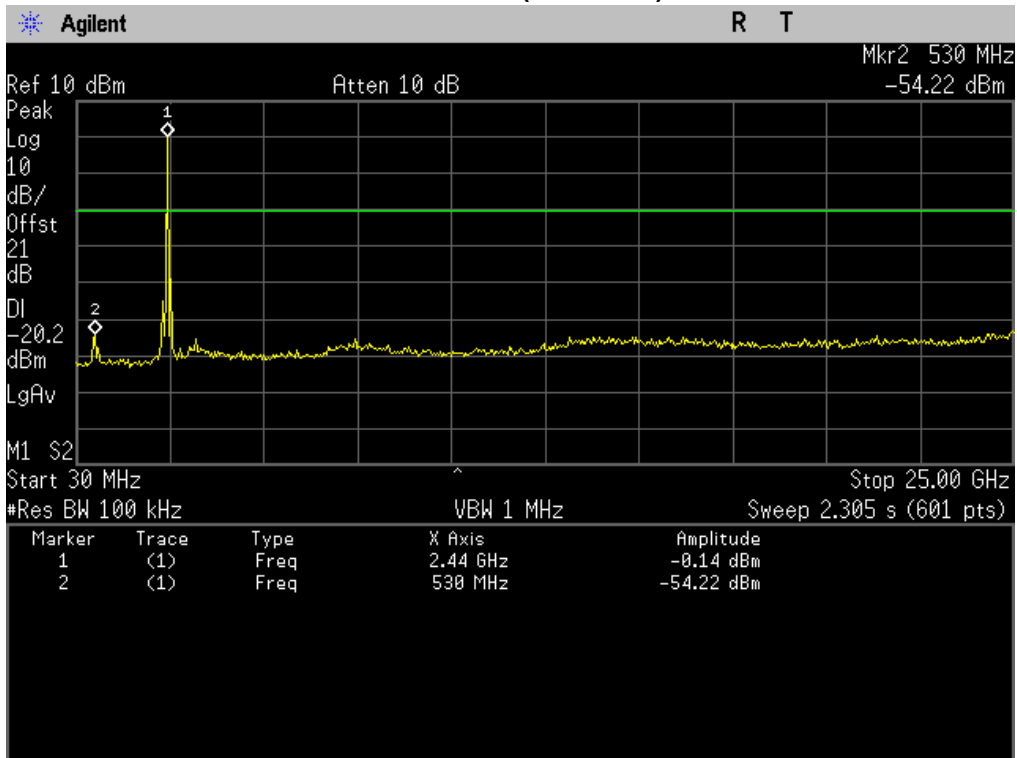

Channel 11 (2462MHz)

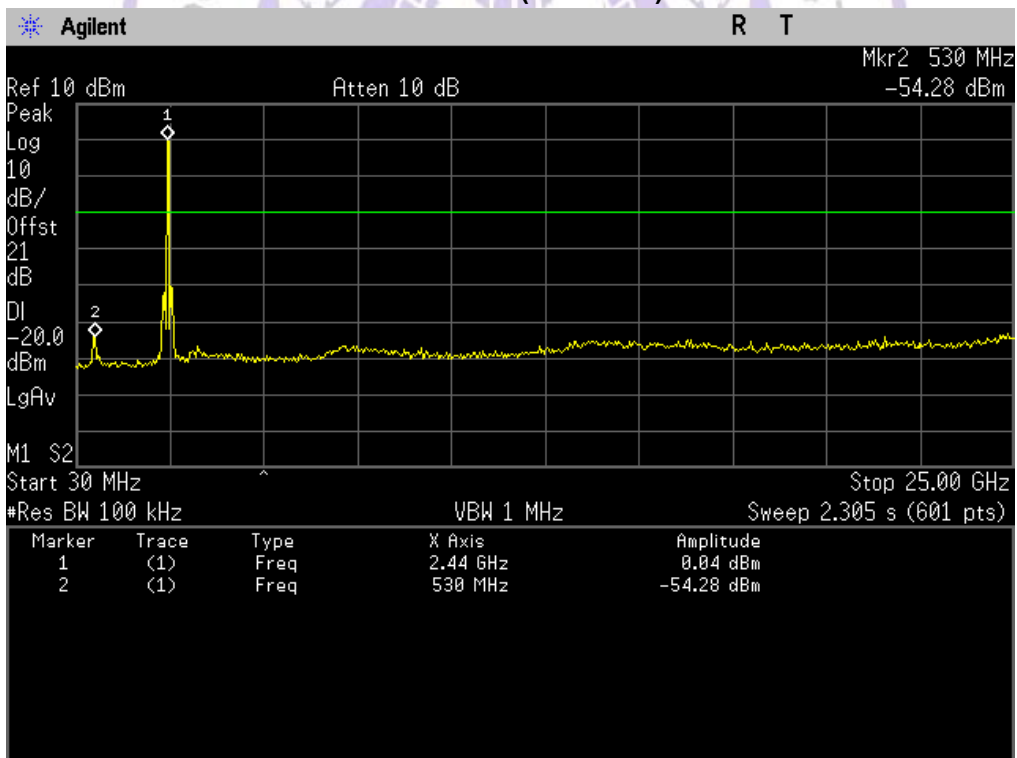

Product	:	Router
Test Item	:	RF Antenna Conducted Spurious
Test Mode	:	Mode 3: Transmit by 802.11n (20MHz)

Channel 01 (2412MHz)

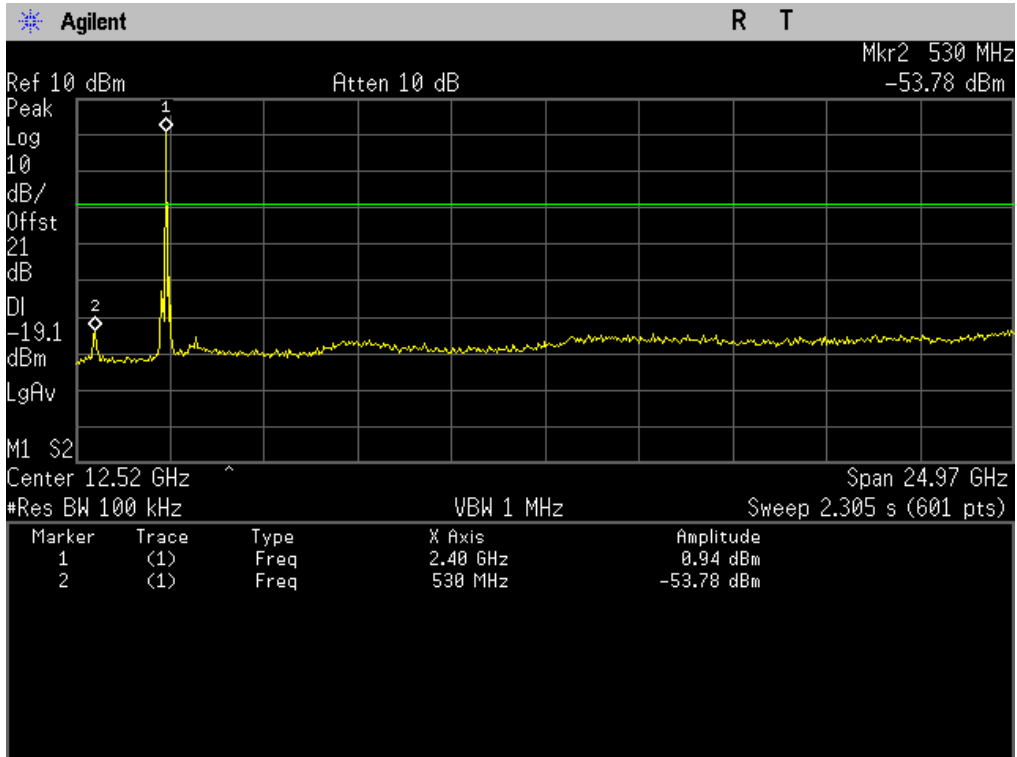

Channel 06 (2437MHz)

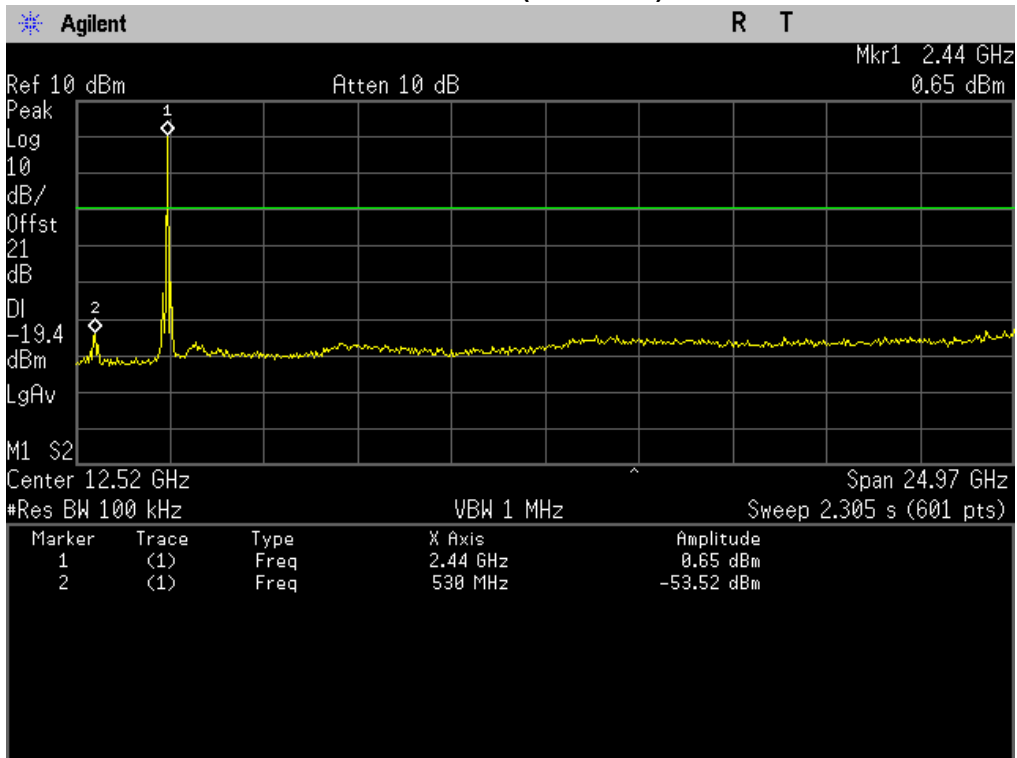

Channel 11 (2462MHz)

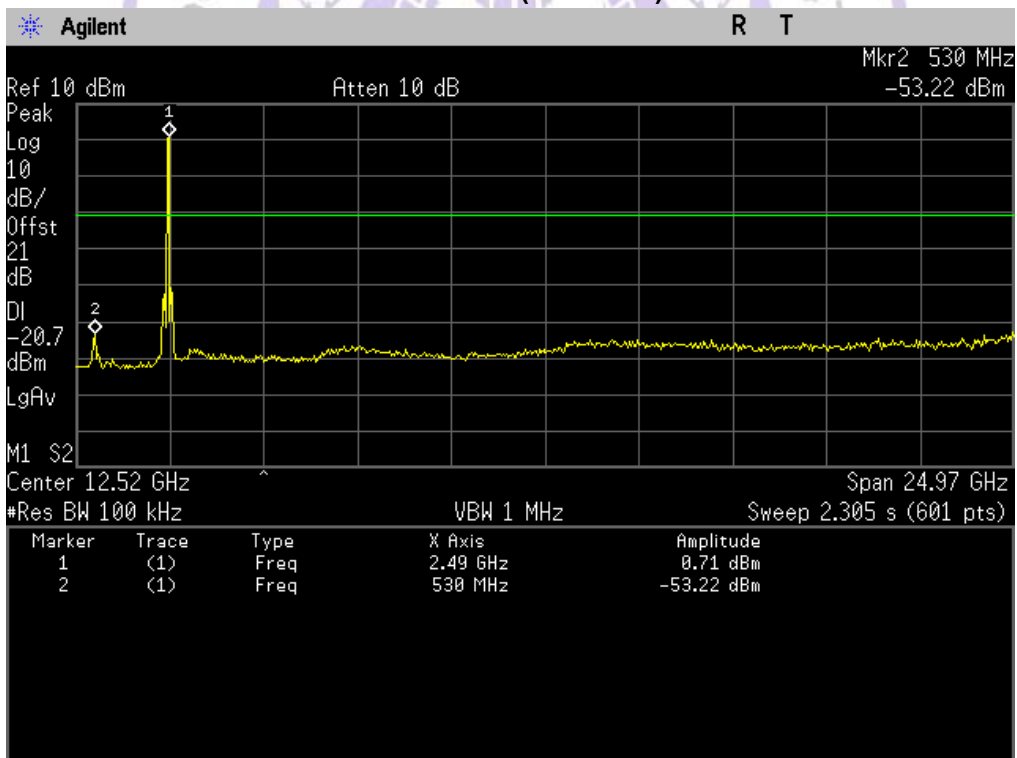

Product	:	Router
Test Item	:	RF Antenna Conducted Spurious
Test Mode	:	Mode 4: Transmit by 802.11n (40MHz)

Channel 03 (2422MHz)

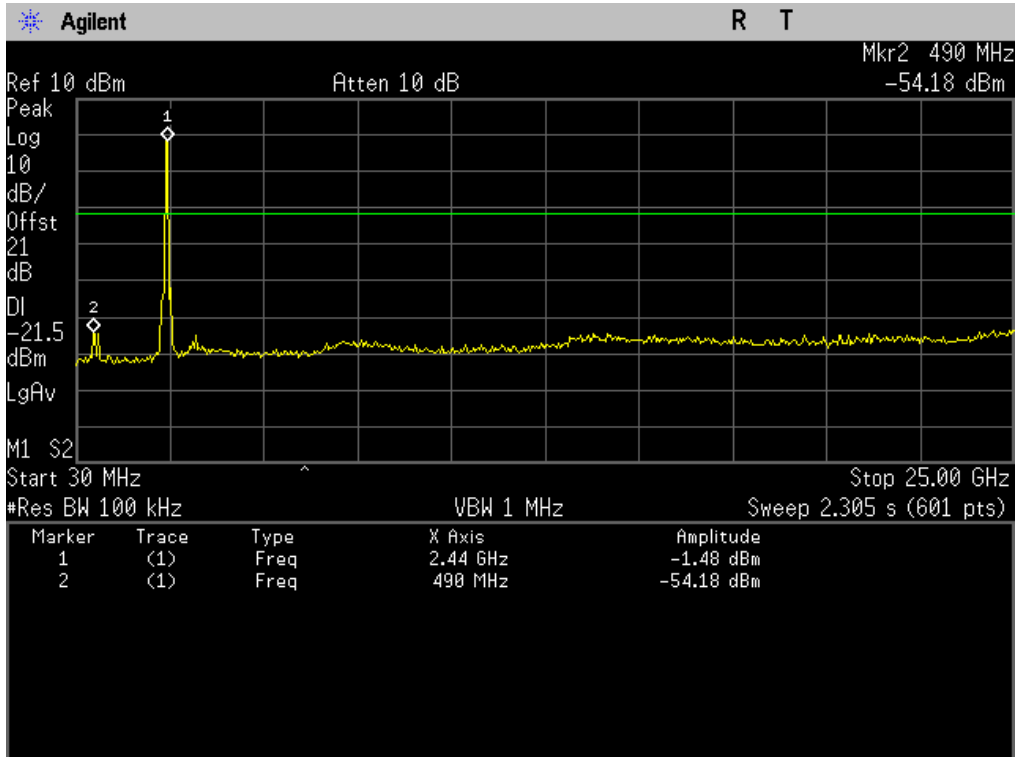

Channel 06 (2437MHz)

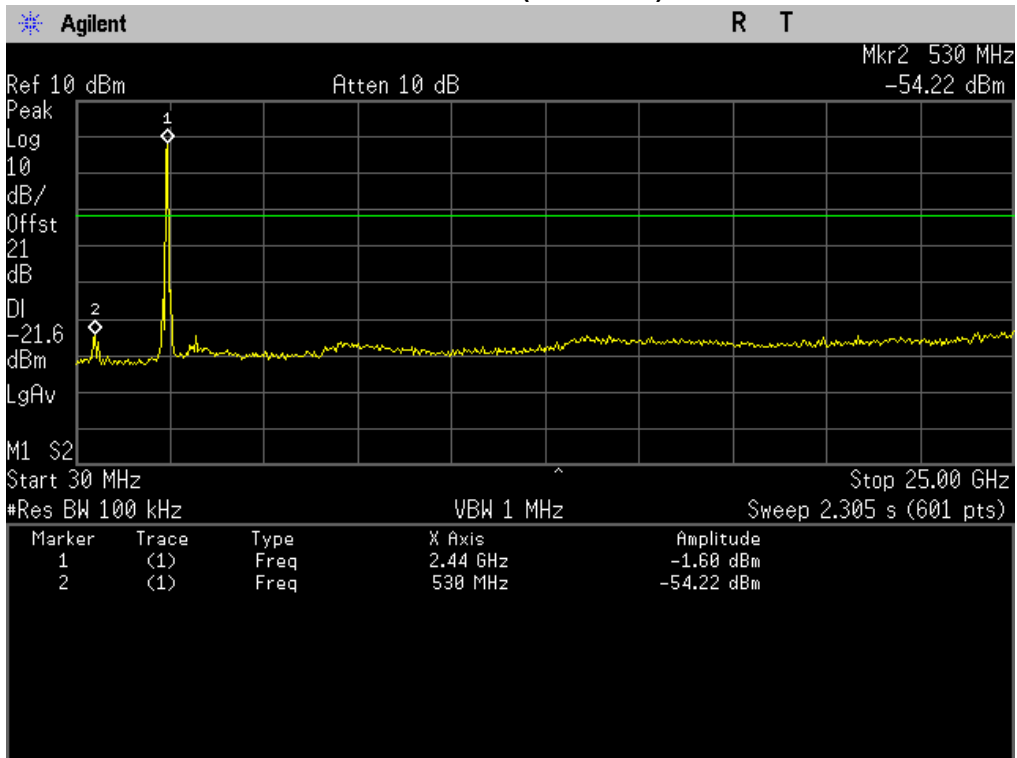

Channel 09 (2452MHz)

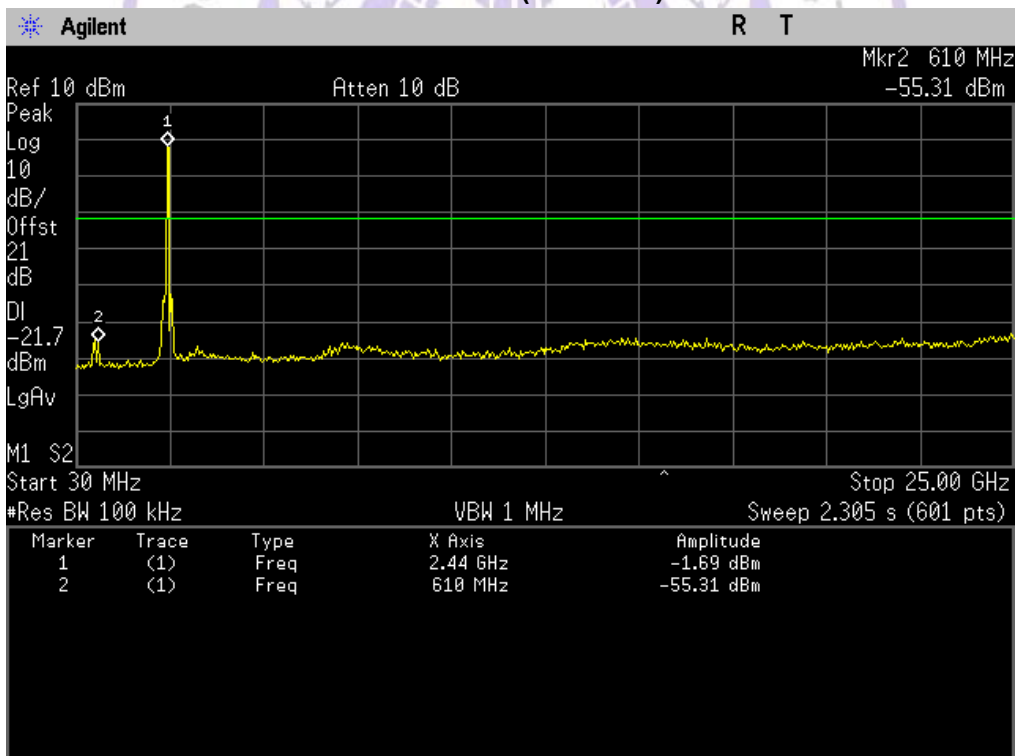

4.8. Operation Frequency Range of 20dB Bandwidth

TEST CONFIGURATION

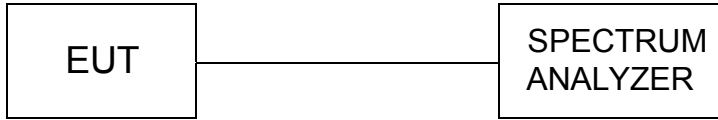

TEST PROCEDURE

The EUT was tested according to KDB558074 D01 v03r01 for compliance to FCC 47CFR 15.247 requirements. Set RBW = 100 kHz, Span greater than RBW.

LIMIT

20 dB bandwidth of the emission is contained within the operation frequency band.

TEST RESULT

Product	:	Router
Test Item	:	Operation Frequency Range of 20dB Bandwidth
Test Mode	:	Mode 1: Transmit by 802.11b

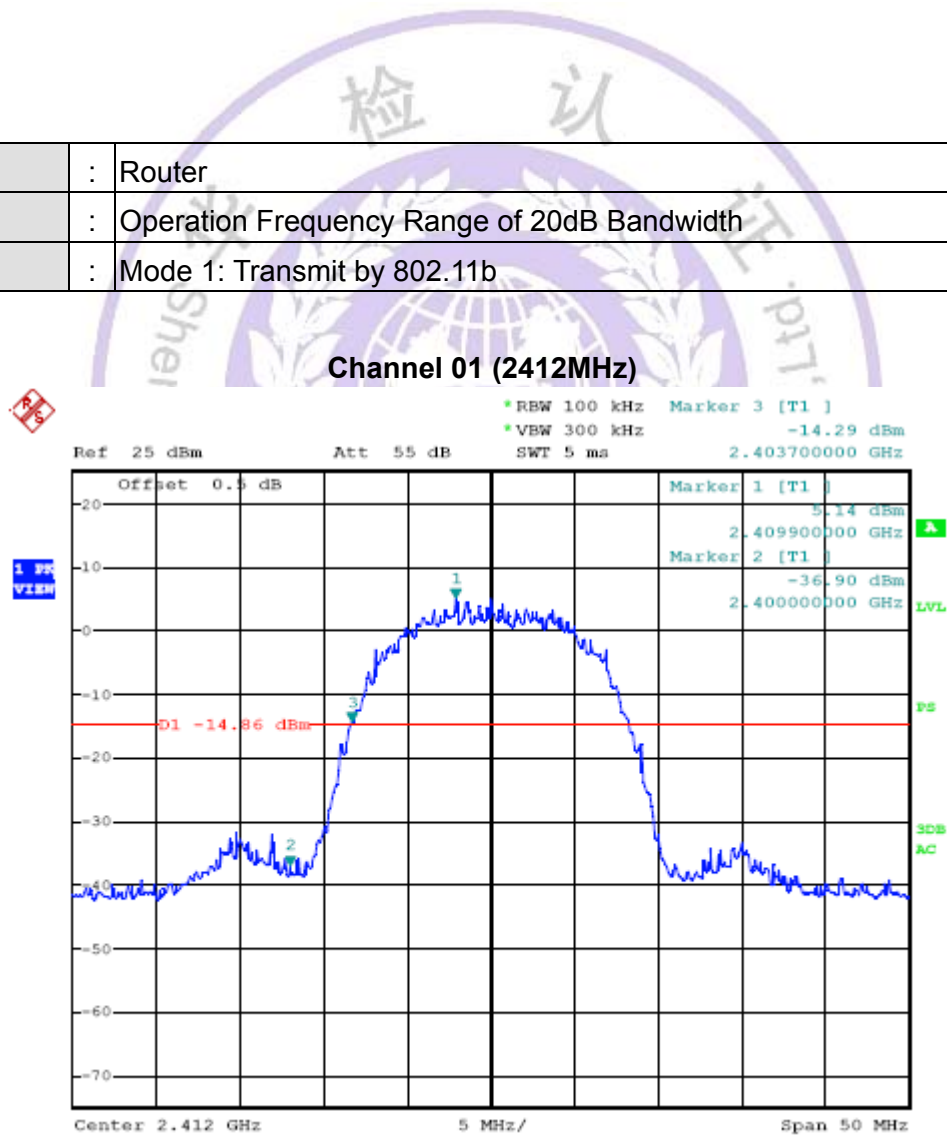

Channel 11 (2462MHz)

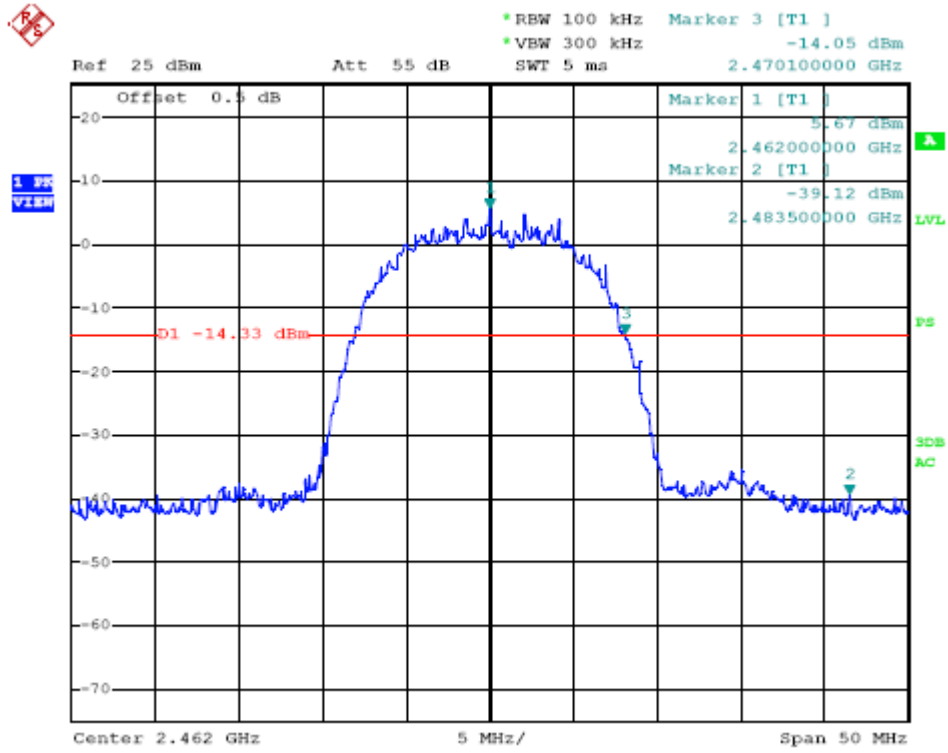

Product	:	Router
Test Item	:	Operation Frequency Range of 20dB Bandwidth
Test Mode	:	Mode 2: Transmit by 802.11g

Channel 01 (2412MHz)

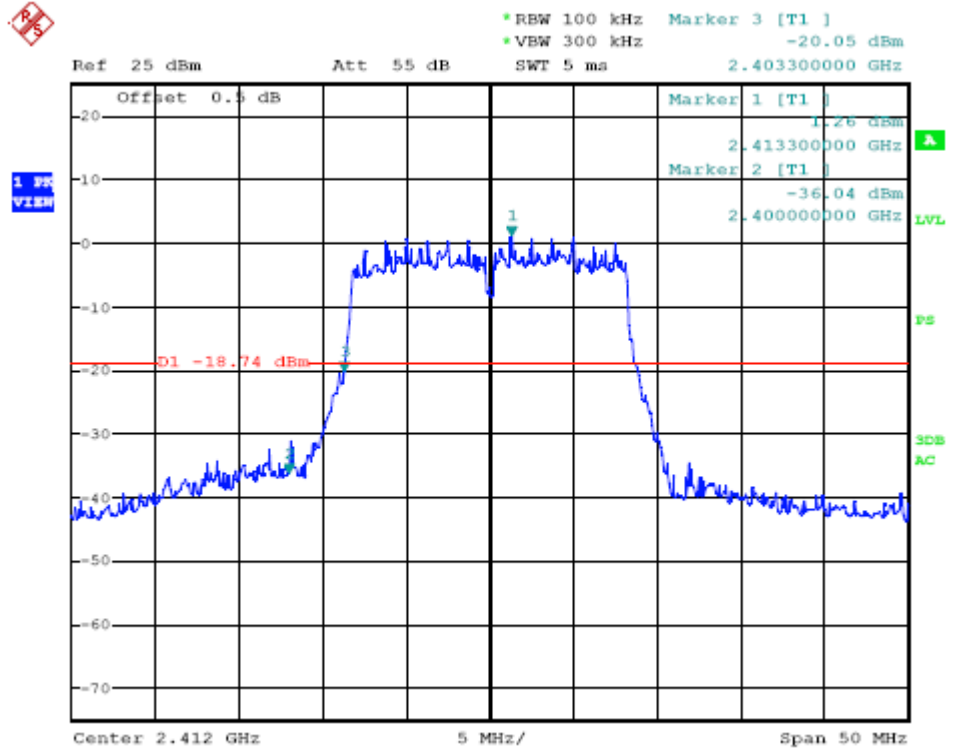

Channel 11 (2462MHz)

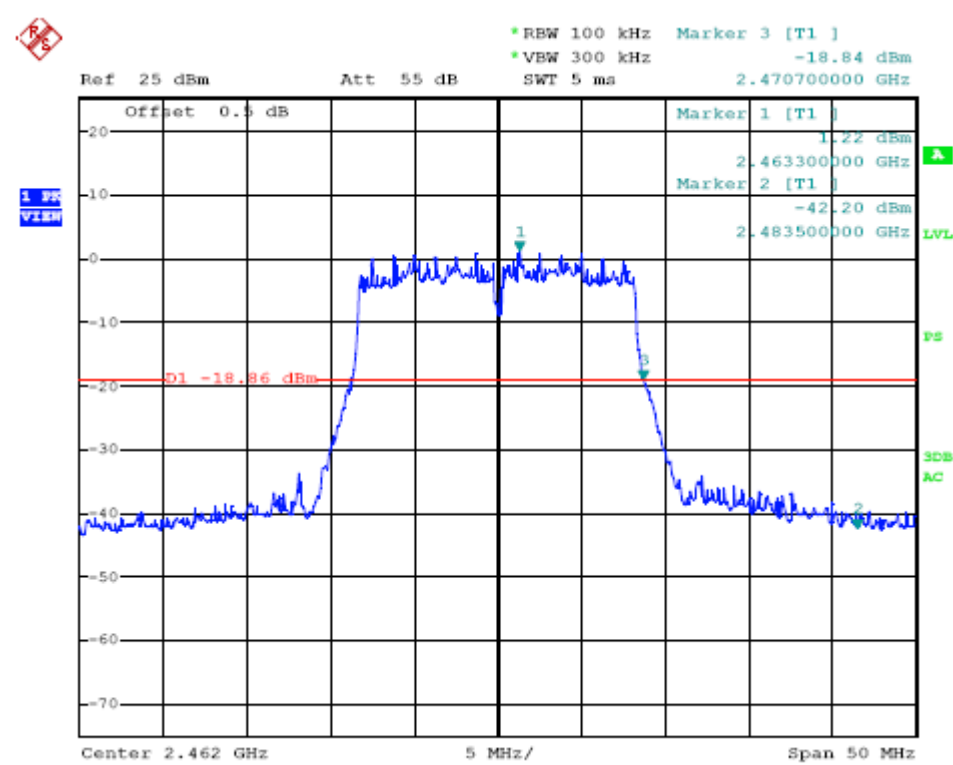

Product	:	Router
Test Item	:	Operation Frequency Range of 20dB Bandwidth
Test Mode	:	Mode 3: Transmit by 802.11n (20MHz)

Channel 01 (2412MHz)

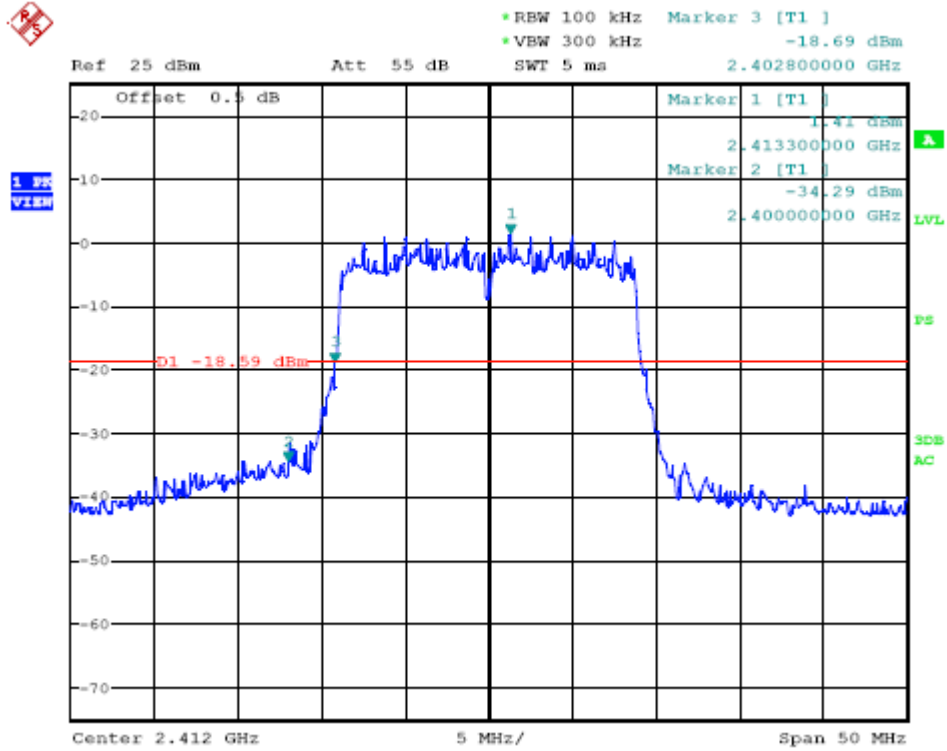

Channel 11 (2462MHz)

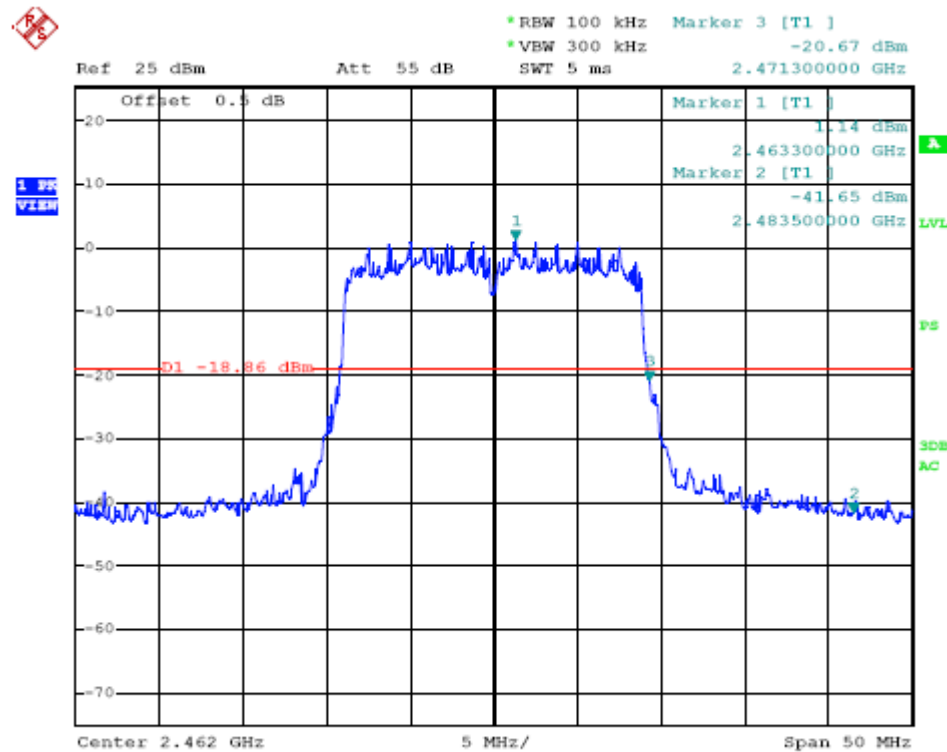

Product	:	Router
Test Item	:	Operation Frequency Range of 20dB Bandwidth
Test Mode	:	Mode 4: Transmit by 802.11n (40MHz)

Channel 03 (2422MHz)

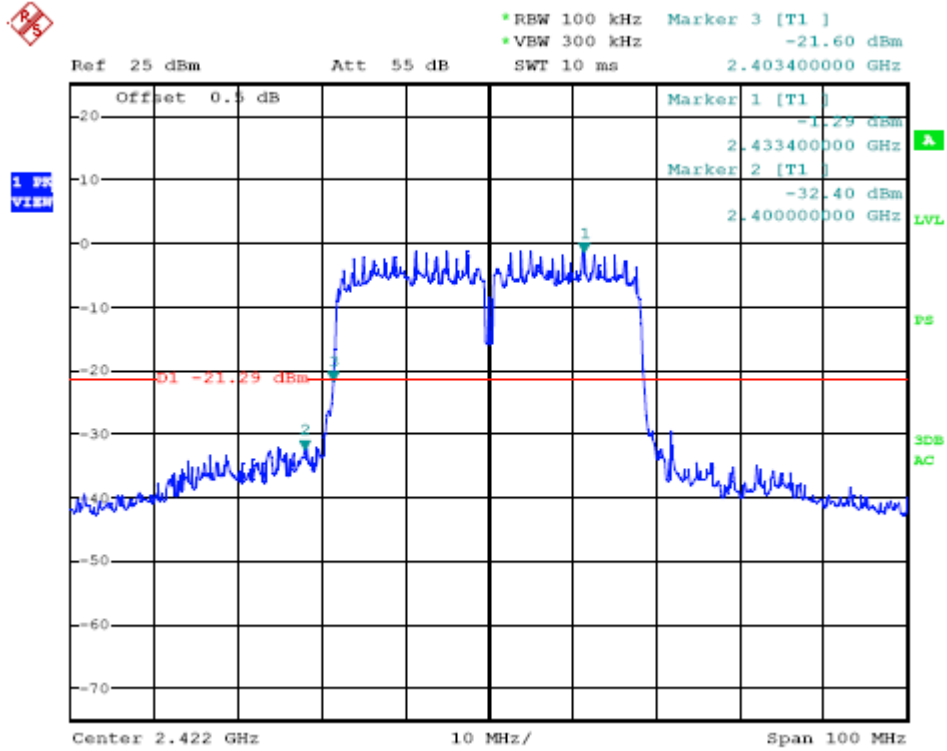

Channel 09 (2452MHz)

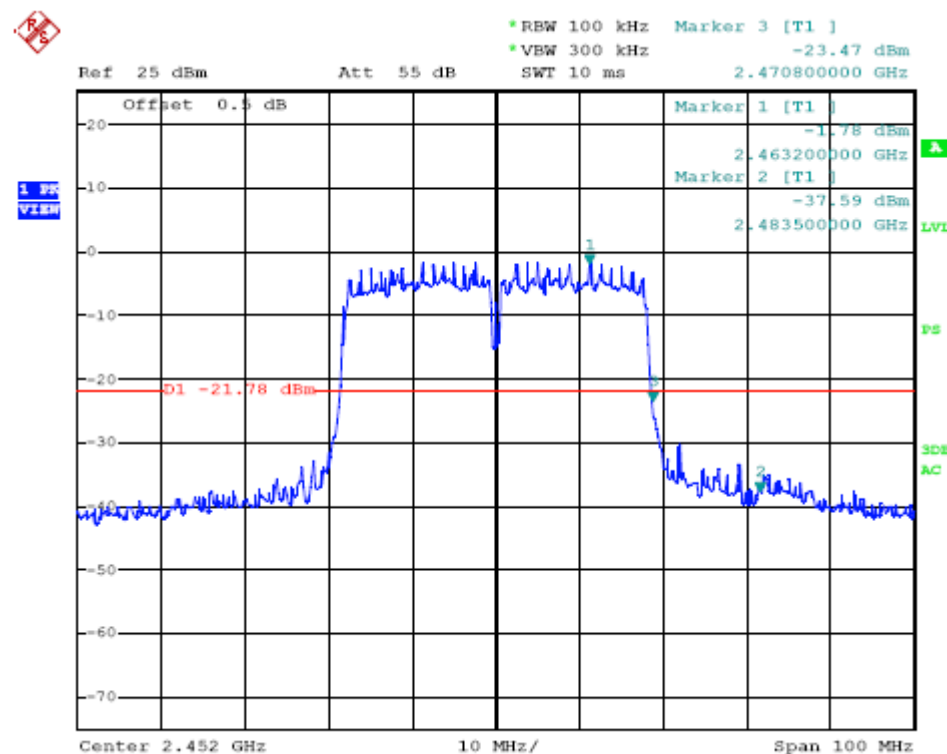

4.9. Antenna Requirement

STANDARD APPLICABLE

For intentional device, according to FCC 47 CFR Section 15.203, an intentional radiator shall be designed to ensure that no antenna other than that furnished by the responsible party shall be used with the device.

And according to FCC 47 CFR Section 15.247 (c), if transmitting antennas of directional gain greater than 6dBi are used, the power shall be reduced by the amount in dB that the directional gain of the antenna exceeds 6dBi.

Refer to statement below for compliance.

The manufacturer may design the unit so that the user can replace a broken antenna, but the use of a standard antenna jack or electrical connector is prohibited. Further, this requirement does not apply to intentional radiators that must be professionally installed.

ANTENNA CONNECTED CONSTRUCTION

The directional gains of antenna used for transmitting is 2 dBi, and the antenna connector is designed with permanent attachment and no consideration of replacement. Please see EUT photo for details.



5. Test Setup Photos of the EUT

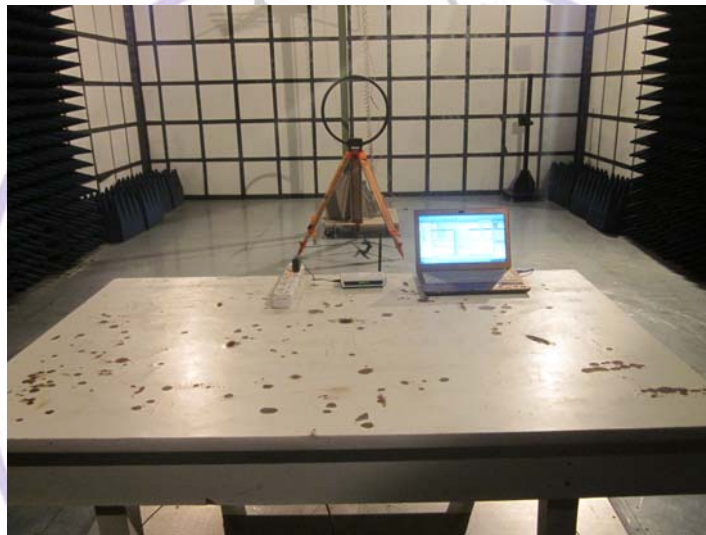



6. External and Internal Photos of the EUT

External Photos of EUT



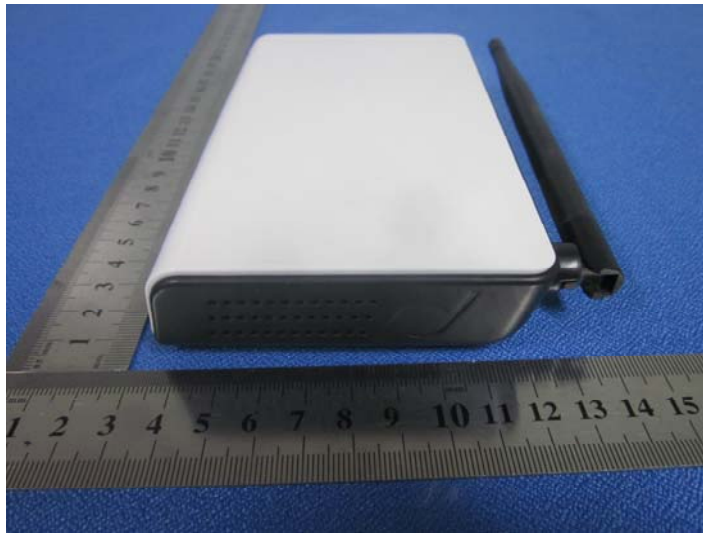



Internal Photos of EUT



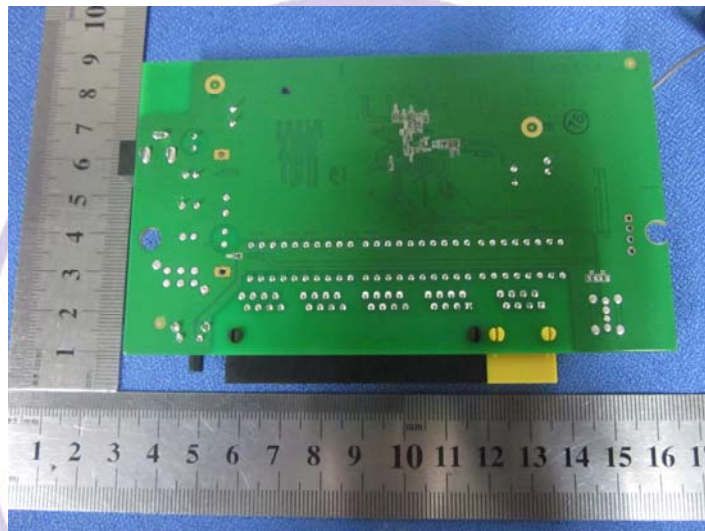

.....End of Report.....

