

FCC CERTIFICATION TEST REPORT

FOR

| | | |
|-----------------------------|---|-----------------------------------------------------|
| Applicant | : | Tenetics, LLC |
| Address | : | 10718 Vista Road, Columbia, MD 21044, United States |
| Equipment under Test | : | Ceres Gateway 2 |
| Model No. | : | GW2 |
| Trade Mark | : | Ceres |
| FCC ID | : | 2AA6Q-GW2 |
| Manufacturer | : | Tenetics, LLC |
| Address | : | 10718 Vista Road, Columbia, MD 21044, United States |

Issued By: Dongguan Dongdian Testing Service Co., Ltd.

Add: No. 17, Zongbu Road 2, Songshan Lake Sci&Tech, Industry Park, Dongguan City, Guangdong Province, China, 523808

Tel: +86-0769-89201699 **E-mail:** ddt@dgddt.com <http://www.dgddt.com>

REPORT

TABLE OF CONTENTS

| | | |
|------|--------------------------------------------------|----|
| | Test report declares..... | 4 |
| 1. | Summary of test results | 6 |
| 2. | General test information..... | 7 |
| 2.1. | Description of EUT | 7 |
| 2.2. | Accessories of EUT | 8 |
| 2.3. | Assistant equipment used for test..... | 8 |
| 2.4. | Block diagram of EUT configuration for test..... | 8 |
| 2.5. | Deviations of test standard | 8 |
| 2.6. | Test environment conditions | 8 |
| 2.7. | Test laboratory | 9 |
| 2.8. | Measurement uncertainty | 9 |
| 3. | Equipment used during test | 10 |
| 4. | Maximum Peak Output Power | 11 |
| 4.1. | Block diagram of test setup | 11 |
| 4.2. | Limits | 11 |
| 4.3. | Test Procedure..... | 11 |
| 4.4. | Test Result | 11 |
| 4.5. | Original test data | 12 |
| 5. | 20dB Bandwidth and 99% Bandwidth | 14 |
| 5.1. | Block diagram of test setup | 14 |
| 5.2. | Limits | 14 |
| 5.3. | Test Procedure..... | 14 |
| 5.4. | Test Result | 14 |
| 5.5. | Original test data | 15 |
| 6. | Carrier Frequency Separation | 17 |
| 6.1. | Block diagram of test setup | 17 |
| 6.2. | Limits | 17 |
| 6.3. | Test Procedure..... | 17 |
| 6.4. | Test Result | 17 |
| 6.5. | Original test data | 17 |
| 7. | Number Of Hopping Channel | 18 |
| 7.1. | Block diagram of test setup | 18 |
| 7.2. | Limits | 18 |
| 7.3. | Test Procedure..... | 18 |
| 7.4. | Test Result | 18 |

| | | |
|-------|-----------------------------------------------|----|
| 7.5. | Original test data | 18 |
| 8. | Dwell Time | 20 |
| 8.1. | Block diagram of test setup | 20 |
| 8.2. | Limits | 20 |
| 8.3. | Test Procedure..... | 20 |
| 8.4. | Test Result | 20 |
| 8.5. | Original test data | 20 |
| 9. | Band Edge Compliance (conducted method) | 22 |
| 9.1. | Block diagram of test setup | 22 |
| 9.2. | Limit..... | 22 |
| 9.3. | Test result..... | 22 |
| 9.4. | Original test data | 22 |
| 10. | Radiated emission | 24 |
| 10.1. | Block diagram of test setup | 24 |
| 10.2. | Limit..... | 25 |
| 10.3. | Test Procedure..... | 26 |
| 10.4. | Test result..... | 28 |
| 11. | RF Conducted Spurious Emissions..... | 36 |
| 11.1. | Block diagram of test setup | 36 |
| 11.2. | Limits | 36 |
| 11.3. | Test Procedure..... | 36 |
| 11.4. | Test Result | 36 |
| 11.5. | Original test data | 37 |
| 12. | Band Edge Compliance (radiated method) | 40 |
| 12.1. | Block diagram of test setup | 40 |
| 12.2. | Limit..... | 40 |
| 12.3. | Test Procedure..... | 40 |
| 12.4. | Test result..... | 40 |
| 13. | Power Line Conducted Emission..... | 45 |
| 13.1. | Block diagram of test setup | 45 |
| 13.2. | Power Line Conducted Emission Limits | 45 |
| 13.3. | Test Procedure..... | 45 |
| 13.4. | Test Result | 46 |
| 14. | Antenna Requirements | 49 |
| 14.1. | Limit..... | 49 |
| 14.2. | Result | 49 |

TEST REPORT DECLARE

| | | |
|-----------------------------|---|-----------------------------------------------------|
| Applicant | : | Tenetics, LLC |
| Address | : | 10718 Vista Road, Columbia, MD 21044, United States |
| Equipment under Test | : | Ceres Gateway 2 |
| Model No. | : | GW2 |
| Trade mark | : | Ceres |
| Manufacturer | : | Tenetics, LLC |
| Address | : | 10718 Vista Road, Columbia, MD 21044, United States |

Test Standard Used:

FCC Rules and Regulations Part 15 Subpart C.

Test procedure used:

ANSI C63.10:2013

We Declare:

The equipment described above is tested by Dongguan Dongdian Testing Service Co., Ltd. and in the configuration tested the equipment complied with the standards specified above. The test results are contained in this test report and Dongguan Dongdian Testing Service Co., Ltd. is assumed of full responsibility for the accuracy and completeness of these tests.

After test and evaluation, our opinion is that the equipment provided for test compliance with the requirement of the above FCC standards.

| | | | |
|-------------------------|-------------------|----------------------|-------------------------------|
| Report No.: | DDT-R18050304-1E2 | | |
| Date of Receipt: | May. 14, 2018 | Date of Test: | May. 14, 2018 ~ Jun. 28, 2018 |

Prepared By:

Ella Gong

Ella Gong/Engineer

Approved By:



Damon Hu/EMC Manager

Note: This report applies to above tested sample only. This report shall not be reproduced in parts without written approval of Dongguan Dongdian Testing Service Co., Ltd.

Revision history

| Rev. | Revisions | Issue Date | Revised By |
|------|---------------|---------------|------------|
| --- | Initial issue | Jun. 28, 2018 | |
| | | | |

1. Summary of test results

| Description of Test Item | Standard | Results |
|--------------------------------------------------|-------------------------------------------------------------------|---------|
| Maximum Peak Output Power | FCC Part 15: 15.247(b)(1) ANSI C63.10:2013 | PASS |
| 20dB Bandwidth | FCC Part 15: 15.215 ANSI C63.10:2013 | PASS |
| Carrier Frequency Separation | FCC Part 15: 15.247(a)(1) ANSI C63.10:2013 | PASS |
| Number Of Hopping Channel | FCC Part 15: 15.247(a)(1)(iii) ANSI C63.10:2013 | PASS |
| Dwell Time | FCC Part 15: 15.247(a)(1)(iii) ANSI C63.10:2013 | PASS |
| Radiated Emission | FCC Part 15: 15.209 FCC Part 15: 15.247(d) ANSI C63.10:2013 | PASS |
| Band Edge Compliance | FCC Part 15: 15.247(d) ANSI C63.10:2013 | PASS |
| Power Line Conducted Emissions | FCC Part 15: 15.207 ANSI C63.10:2013 | N/A |
| Antenna requirement | FCC Part 15: 15.203 | PASS |
| Note: N/A is an abbreviation for Not Applicable. | | |

2. General test information

2.1. Description of EUT

| | |
|--------------------------|--------------------------------------------------------------------------------------------------------------------------|
| EUT* Name | : Ceres Gateway 2 |
| Model Number | : GW2 |
| EUT function description | : Please reference user manual of this device |
| Power supply | : Input: DC 5V/150mA from external AC adapter |
| Operation frequency | : 910-920MHz |
| Modulation | : GFSK |
| Data rate | : Two data rates: 4.8kbps data rate with 5kHz frequency deviation; 50kbps data rate with 25kHz frequency deviation |
| Antenna Type | : RP-SMA dipole antenna, maximum PK gain: 1.2dBi |
| Sample Type | : Series production |

Note 1: EUT is the ab. of equipment under test.

Note 2: For 50kbps data and 4.8kbps data rate, based exploratory test, there is no significant difference of that two types test result, after the preliminary scan, some items final test were only performed with the worst case.

| Channel information | | | |
|---------------------|-----------------|---------|-----------------|
| Channel | Frequency (MHz) | Channel | Frequency (MHz) |
| CH0 | 910.0 | CH25 | 915.0 |
| CH1 | 910.2 | CH26 | 915.2 |
| CH2 | 910.4 | CH27 | 915.4 |
| CH3 | 910.6 | CH28 | 915.6 |
| CH4 | 910.8 | CH29 | 915.8 |
| CH5 | 911.0 | CH30 | 916.0 |
| CH6 | 911.2 | CH31 | 916.2 |
| CH7 | 911.4 | CH32 | 916.4 |
| CH8 | 911.6 | CH33 | 916.6 |
| CH9 | 911.8 | CH34 | 916.8 |
| CH10 | 912.0 | CH35 | 917.0 |
| CH11 | 912.2 | CH36 | 917.2 |
| CH12 | 912.4 | CH37 | 917.4 |
| CH13 | 912.6 | CH38 | 917.6 |
| CH14 | 912.8 | CH39 | 917.8 |
| CH15 | 913.0 | CH40 | 918.0 |
| CH16 | 913.2 | CH41 | 918.2 |
| CH17 | 913.4 | CH42 | 918.4 |
| CH18 | 913.6 | CH43 | 918.6 |
| CH19 | 913.8 | CH44 | 918.8 |
| CH20 | 914.0 | CH45 | 919.0 |
| CH21 | 914.2 | CH46 | 919.2 |
| CH22 | 914.4 | CH47 | 919.4 |
| CH23 | 914.6 | CH48 | 919.6 |
| CH24 | 914.8 | CH49 | 919.8 |

2.2. Accessories of EUT

| Description of Accessories | Manufacturer | Model number | Serial No. | Other |
|----------------------------|----------------------------|----------------|------------|-------------------------------------------------------------|
| USB cable | N/A | N/A | N/A | Length: 1.5m with core |
| AC adapter | Research In Motion Limited | PSM04A-050QRIM | N/A | INPUT: 100-240V/50-60Hz, 200mA OUTPUT: DC 5V/750mA |

2.3. Assistant equipment used for test

| Assistant equipment | Manufacturer | Model number | Serial No. | Other |
|---------------------|--------------|---------------|------------|-------------------|
| Notebook | DELL | Latitude D610 | FCC DOC | 00045-534-136-300 |

2.4. Block diagram of EUT configuration for test

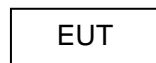

Test software: PuTTY

The test software was used to control EUT work in Continuous TX mode, and select test channel, wireless mode as below table.

| Tested mode, channel, information | | |
|-----------------------------------|-------------|-----------------|
| Mode | Channel | Frequency (MHz) |
| Hopping on TX mode | CH0 to CH49 | 910 to 919.8 |
| Hopping off TX mode | CH0 | 910 |
| | CH24 | 915 |
| | CH49 | 919.8 |

2.5. Deviations of test standard

No Deviation.

2.6. Test environment conditions

During the measurement the environmental conditions were within the listed ranges:

| | |
|--------------------|-----------|
| Temperature range: | 21-25°C |
| Humidity range: | 40-75% |
| Pressure range: | 86-106kPa |

Note : New battery is used during all test.

2.7. Test laboratory

Dongguan Dongdian Testing Service Co., Ltd

Add: No. 17, Zongbu Road 2, Songshan Lake Sci&Tech, Industry Park, Dongguan City, Guangdong Province, China, 523808

Tel: +86-0769-89201699, <http://www.dgddt.com>, Email: ddt@dgddt.com

CNAS Accreditation No. L6451; A2LA Accreditation No. 3870.01

Designation Number: CN1182; Test Firm Registration Number: 540522

Industry Canada site registration number: 10288A-1

2.8. Measurement uncertainty

| Test Item | Uncertainty |
|------------------------------------------------------|----------------------------------------------|
| Bandwidth | 1.1% |
| Peak Output Power(Conducted)(Spectrum analyzer) | 0.86dB (10 MHz ≤ f < 3.6GHz); |
| | 1.38dB (3.6GHz ≤ f < 8GHz) |
| Peak Output Power(Conducted)(Power Sensor) | 0.74dB |
| Power Spectral Density | 0.74dB (10 MHz ≤ f < 3.6GHz); |
| | 1.38dB (3.6GHz ≤ f < 8GHz) |
| Frequencies Stability | 6.7×10^{-8} (Antenna couple method) |
| | 5.5×10^{-8} (Conducted method) |
| Conducted spurious emissions | 0.86dB (10 MHz ≤ f < 3.6GHz); |
| | 1.40dB (3.6GHz ≤ f < 8GHz) |
| | 1.66dB (8GHz ≤ f < 22GHz) |
| Uncertainty for radio frequency (RBW<20kHz) | 3×10^{-8} |
| Temperature | 0.4℃ |
| Humidity | 2% |
| Uncertainty for Radiation Emission test (30MHz-1GHz) | 4.70 dB (Antenna Polarize: V) |
| | 4.84 dB (Antenna Polarize: H) |
| Uncertainty for Radiation Emission test (1GHz-40GHz) | 4.10dB (1-6GHz) |
| | 4.40dB (6GHz-18GHz) |
| | 3.54dB (18GHz-26GHz) |
| | 4.30dB (26GHz-40GHz) |
| Uncertainty for Power line conduction emission test | 3.32dB (150kHz-30MHz) |

Note: This uncertainty represents an expanded uncertainty expressed at approximately the 95% confidence level using a coverage factor of k=2.

3. Equipment used during test

| Equipment | Manufacturer | Model No. | Serial No. | Last Cal. | Cal. Interval |
|-----------------------------------------------------------|---------------|-------------------|-------------------|---------------|---------------|
| RF Connected Test (Tonscend RF Measurement System) | | | | | |
| Spectrum analyzer | R&S | FSU26 | 200071 | Oct. 23, 2017 | 1Year |
| Vector Signal Generator | Agilent | E8267D | US49060192 | Oct. 23, 2017 | 1Year |
| Power Sensor | Agilent | U2021XA | MY55150010 | Oct. 21, 2017 | 1Year |
| Power Sensor | Agilent | U2021XA | MY55150011 | Oct. 23, 2017 | 1Year |
| DC Power Source | MATRIS | MPS-3005L-3 | D813058W | Aug. 18, 2017 | 1Year |
| Attenuator | Mini-Circuits | BW-S10W2 | 101109 | Aug. 18, 2017 | 1Year |
| RF Cable | Micable | C10-01-01-1 | 100309 | Oct. 21, 2017 | 1Year |
| Temp&Humi Programmable | ZHIXIANG | ZXGDJS-150 L | ZX170110-A | Oct. 21, 2017 | 1Year |
| Test Software | JS Tonscend | JS1120-3 | Ver.2.7 | N/A | N/A |
| Radiated Emission Test Chamber 1# | | | | | |
| EMI Test Receiver | R&S | ESU8 | 100316 | Oct. 21 2017 | 1 Year |
| Spectrum analyzer | R&S | FSU26 | 1166.1660.26 | Oct. 21 2017 | 1 Year |
| Trilog Broadband Antenna | Schwarzbeck | VULB9163 | 9163-462 | Nov. 09, 2017 | 1 Year |
| Active Loop antenna | Schwarzbeck | FMZB-1519 | 1519-038 | Oct. 17, 2017 | 1 Year |
| Double Ridged Horn Antenna | R&S | HF907 | 100276 | Oct. 17, 2017 | 1 Year |
| Broad Band Horn Antenna | Schwarzbeck | BBHA 9170 | 790 | Nov. 09,2017 | 1 Year |
| Pre-amplifier | A.H. | PAM-0118 | 360 | Oct. 21, 2017 | 1 Year |
| Pre-amplifier | TERA-MW | TRLA-0040G35 | 101303 | Oct. 21, 2017 | 1 Year |
| RF Cable | HUBSER | CP-X2+ CP-X1 | W11.03+ W12.02 | Oct. 21, 2017 | 1Year |
| RF Cable | N/A | SMAJ-SMAJ-1M+ 11M | 17070133+17070131 | Nov. 08, 2017 | 1 Year |
| MI Cable | HUBSER | C10-01-01-1M | 1091629 | Oct. 21, 2017 | 1 Year |
| Test software | Audix | E3 | V 6.11111b | N/A | N/A |
| Power Line Conducted Emissions Test | | | | | |
| EMI Test Receiver | R&S | ESU8 | 100316 | Oct. 21, 2017 | 1 Year |
| LISN 1 | R&S | ENV216 | 101109 | Oct. 21, 2017 | 1 Year |
| LISN 2 | R&S | ESH2-Z5 | 100309 | Oct. 21, 2017 | 1 Year |
| Pulse Limiter | R&S | ESH3-Z2 | 101242 | Oct. 21, 2017 | 1 Year |
| CE Cable 1 | HUBSER | N/A | W10.01 | Oct. 21, 2017 | 1 Year |
| Test software | Audix | E3 | V 6.11111b | N/A | N/A |

4. Maximum Peak Output Power

4.1. Block diagram of test setup

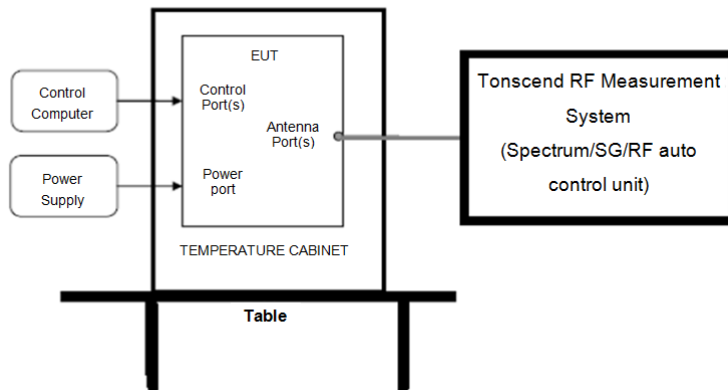

4.2. Limits

For frequency hopping systems operating in the 902-928 MHz band: 1 watt for systems employing at least 50 hopping channels; and 0.25 watts for systems employing less than 50 hopping channels, but at least 25 hopping channels, as permitted under paragraph (a)(1)(i) of this section.

4.3. Test Procedure

- (1) Connect EUT's antenna output to spectrum analyzer by RF cable.
- (2) Measure the maximum output power of EUT by spectrum analyzer with PK detector and RBW=3MHz (above 20dB bandwidth of measured signal), VBW=10MHz

Note: The attenuator loss was inputted into spectrum analyzer as amplitude offset.

4.4. Test Result

| Mode | Freq (MHz) | Result (dBm) | Limit (dBm) | Conclusion |
|--------------|------------|--------------|-------------|------------|
| GFSK 4.8kbps | 910 | 18.26 | 30 | PASS |
| | 915 | 18.12 | 30 | PASS |
| | 919.8 | 17.99 | 30 | PASS |
| GFSK 50kbps | 910 | 18.20 | 30 | PASS |
| | 915 | 18.10 | 30 | PASS |
| | 919.8 | 17.96 | 30 | PASS |

4.5. Original test data

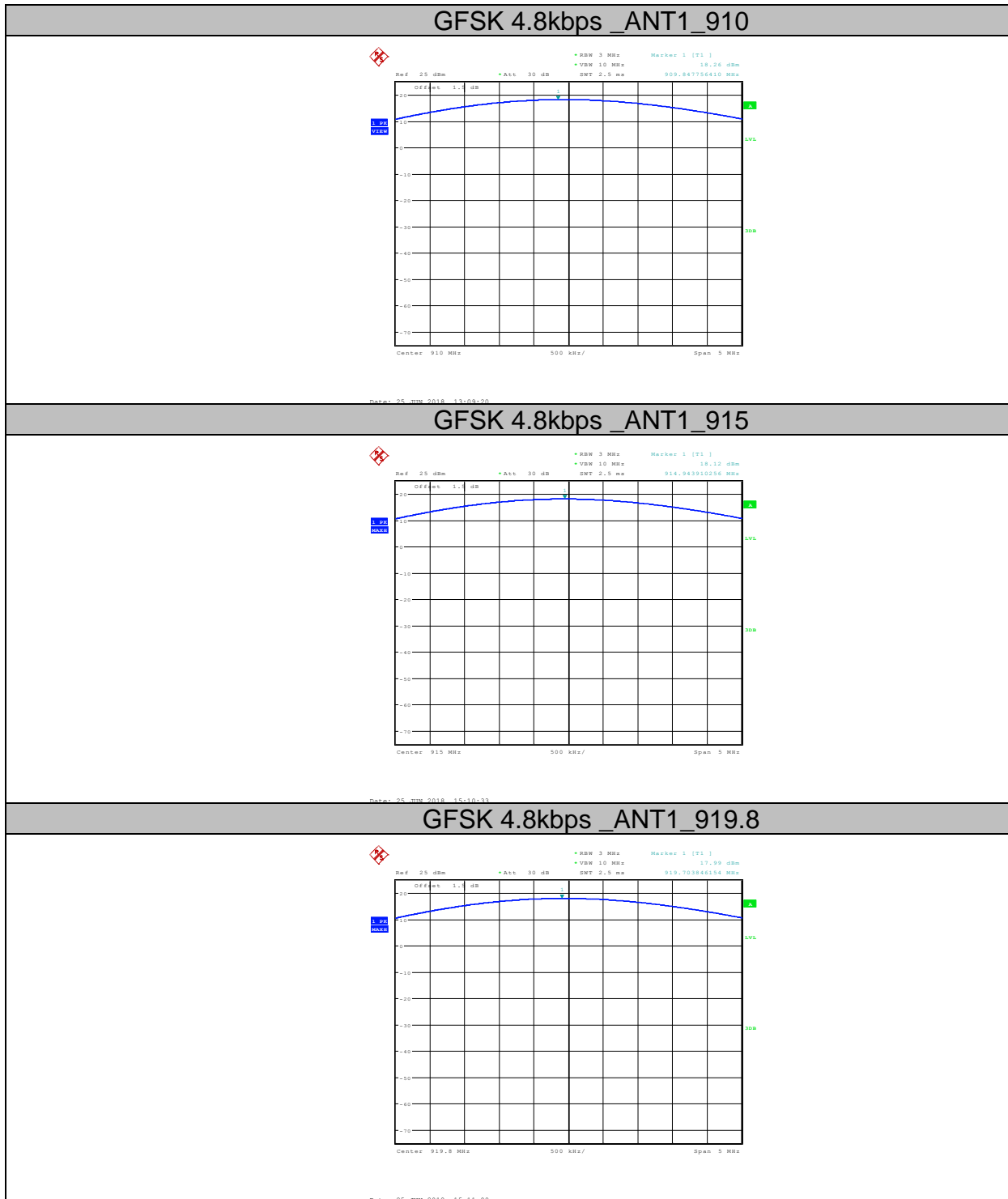

GFSK 50kbps _ANT1_910

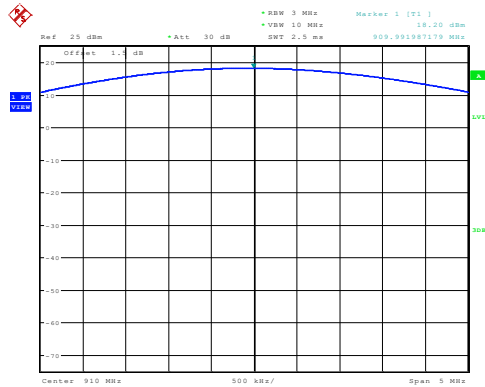

Date: 25-Nov-2018 15:08:01

GFSK 50kbps _ANT1_915

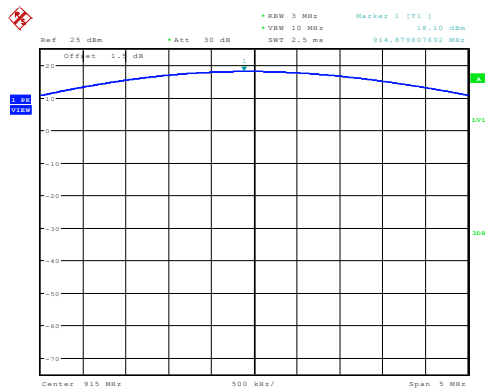

Date: 25-Nov-2018 15:08:02

GFSK 50kbps _ANT1_919.8

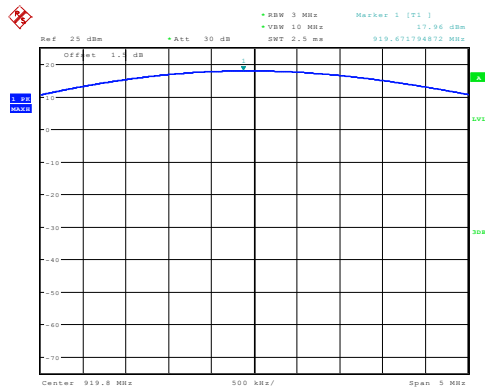

Date: 25-Nov-2018 15:08:00

5. 20dB Bandwidth and 99% Bandwidth

5.1. Block diagram of test setup

Same as section 4.1

5.2. Limits

Intentional radiators operating under the alternative provisions to the general emission limits, as contained in § 15.217 through 15.257 and in Subpart E of this part, must be designed to ensure that the 20 dB bandwidth of the emission, or whatever bandwidth may otherwise be specified in the specific rule section under which the equipment operates, is contained within the frequency band designated in the rule section under which the equipment is operated.

5.3. Test Procedure

(1) Connect EUT's antenna output to spectrum analyzer by RF cable.

The bandwidth of the fundamental frequency was measured by spectrum analyzer with RBW that in the range of 1% to 5% of the OBW and video bandwidth (VBW) shall be approximately three times RBW, The 20dB bandwidth is defined as the total spectrum the power of which is higher than peak power minus 20dB.

5.4. Test Result

| Mode | Freq. (MHz) | 20dB bandwidth Result (kHz) | 99% bandwidth Result (kHz) | Conclusion |
|--------------|-------------|-----------------------------|----------------------------|------------|
| GFSK 4.8kbps | 910 | 15.144 | 14.824 | PASS |
| | 915 | 15.144 | 14.824 | PASS |
| | 919.8 | 15.144 | 14.824 | PASS |
| GFSK 50kbps | 910 | 104.167 | 101.762 | PASS |
| | 915 | 104.167 | 101.362 | PASS |
| | 919.8 | 104.567 | 101.362 | PASS |

5.5. Original test data

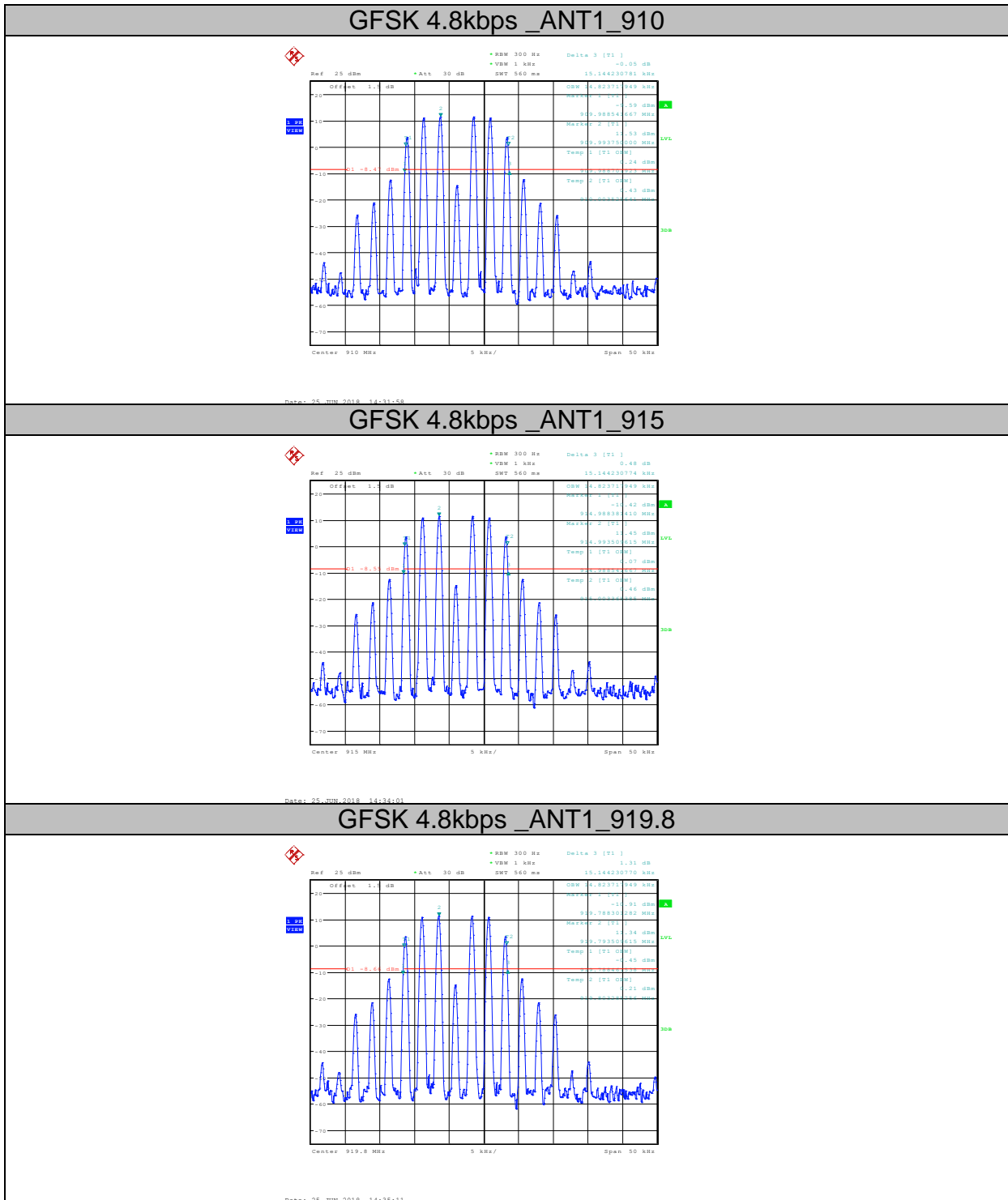

GFSK 50kbps _ANT1_910

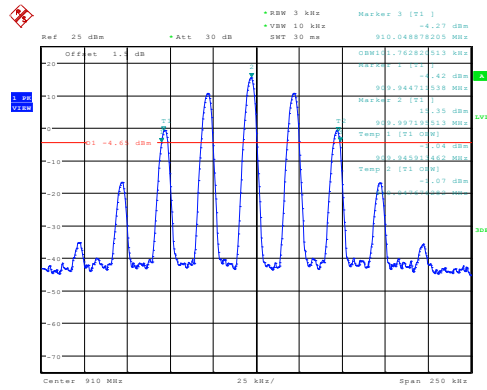

Date: 25-Nov-2018 14:57:02

GFSK 50kbps _ANT1_915

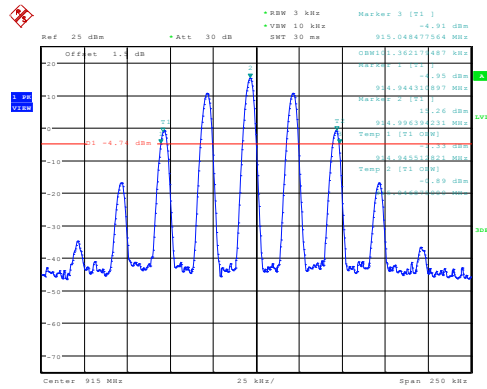

Date: 25-Nov-2018 14:58:17

GFSK 50kbps _ANT1_919.8

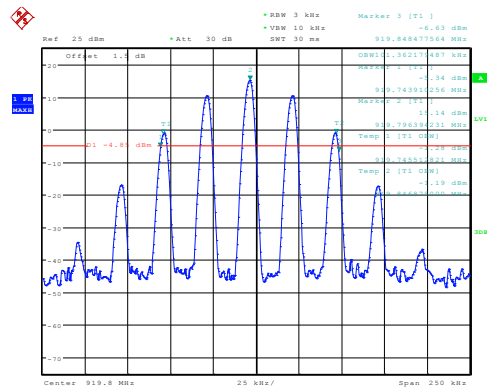

Date: 25-Nov-2018 14:59:02

6. Carrier Frequency Separation

6.1. Block diagram of test setup

Same as section 4.1

6.2. Limits

Frequency hopping systems shall have hopping channel carrier frequencies separated by a minimum of 25 kHz or the 20dB bandwidth of the hopping channel, whichever is greater.

Alternatively, frequency hopping systems operating in the 2400-2483.5 MHz band may have hopping channel carrier frequencies that are separated by 25 kHz or two-thirds of the 20 dB bandwidth of the hopping channel, whichever is greater, provided the systems operate with an output power no greater than 125 mW.

6.3. Test Procedure

- (1) Connect EUT's antenna output to spectrum analyzer by RF cable.
- (2) The carrier frequency was measured by spectrum analyzer with 100 kHz RBW and 300 kHz VBW.

6.4. Test Result

| Mode | Channel separation (kHz) | 20dB bandwidth (kHz) (worse case) | Limit (kHz) | Conclusion |
|------------------|--------------------------|-----------------------------------|-------------|------------|
| GFSK 4.8 kbps | 201.923 | 15.144 | ≥25.000 | PASS |
| GFSK 50 kbps | 202.848 | 104.567 | ≥104.567 | PASS |

6.5. Original test data

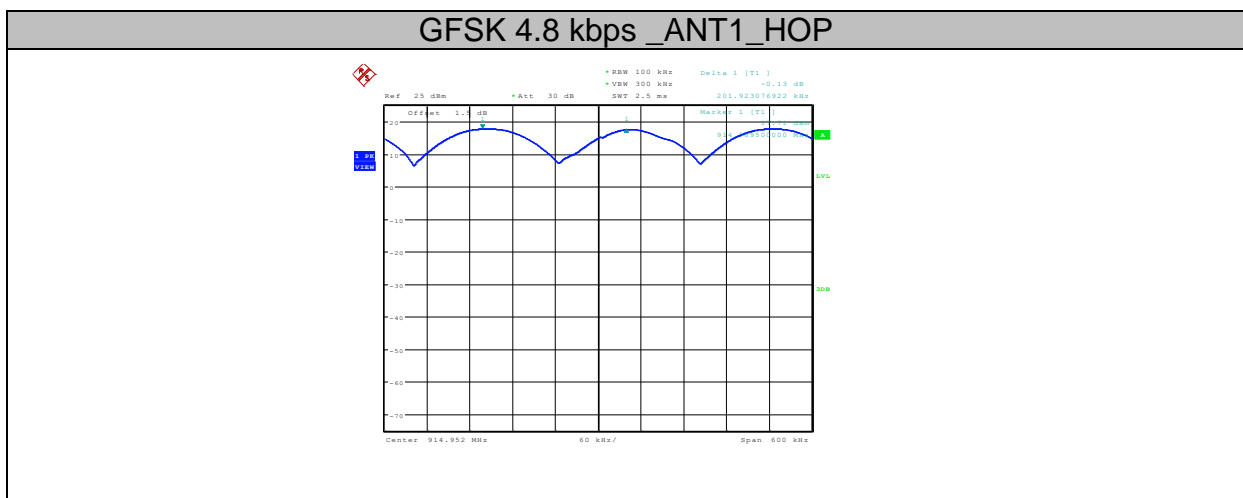

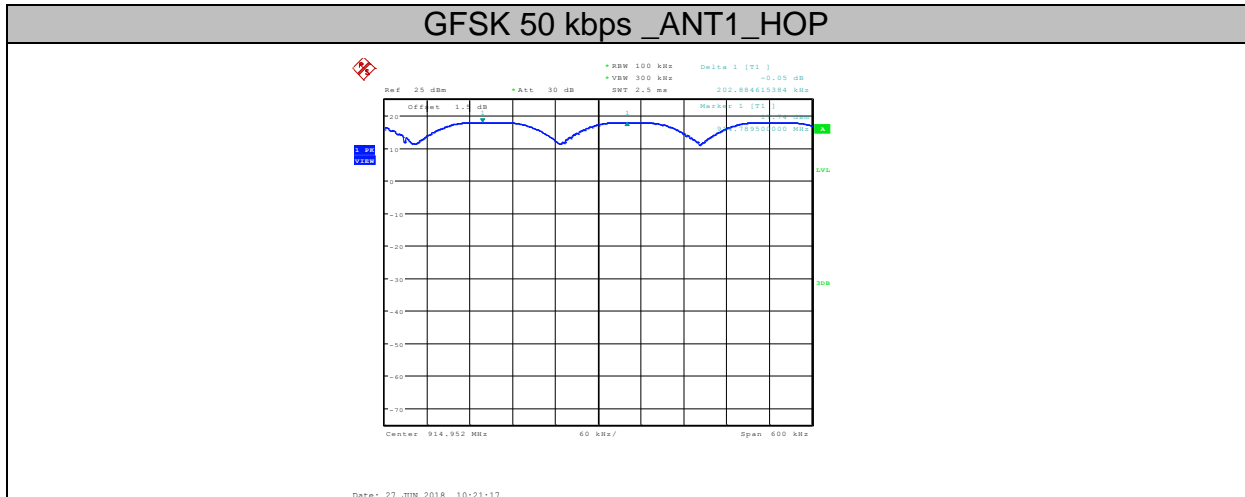

7. Number Of Hopping Channel

7.1. Block diagram of test setup

Same as section 4.1

7.2. Limits

For frequency hopping systems operating in the 902-928 MHz band: if the 20dB bandwidth of the hopping channel is less than 250 kHz, the system shall use at least 50 hopping frequencies

7.3. Test Procedure

- (1) Connect EUT's antenna output to spectrum analyzer by RF cable.
- (2) The number of hopping channel was measured by spectrum analyzer with 100 kHz RBW and 300kHz VBW.

7.4. Test Result

| Mode | Number of hopping channel | Limit | Conclusion |
|------------------|---------------------------|-------|------------|
| GFSK 4.8 kbps | 50 | ≥50 | PASS |
| GFSK 50 kbps | 50 | ≥50 | PASS |

7.5. Original test data



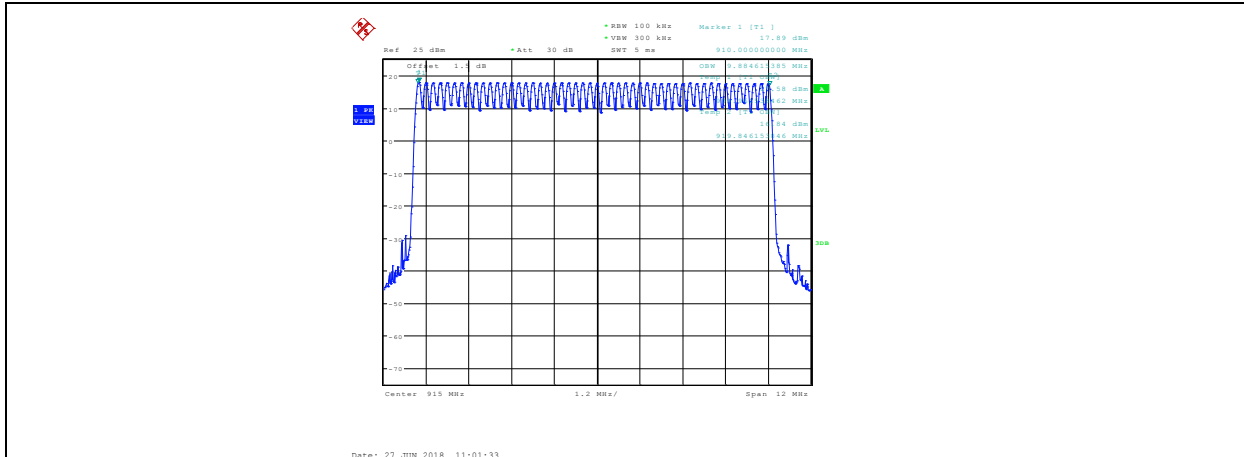

GFSK 50 kbps _ANT1_HOP

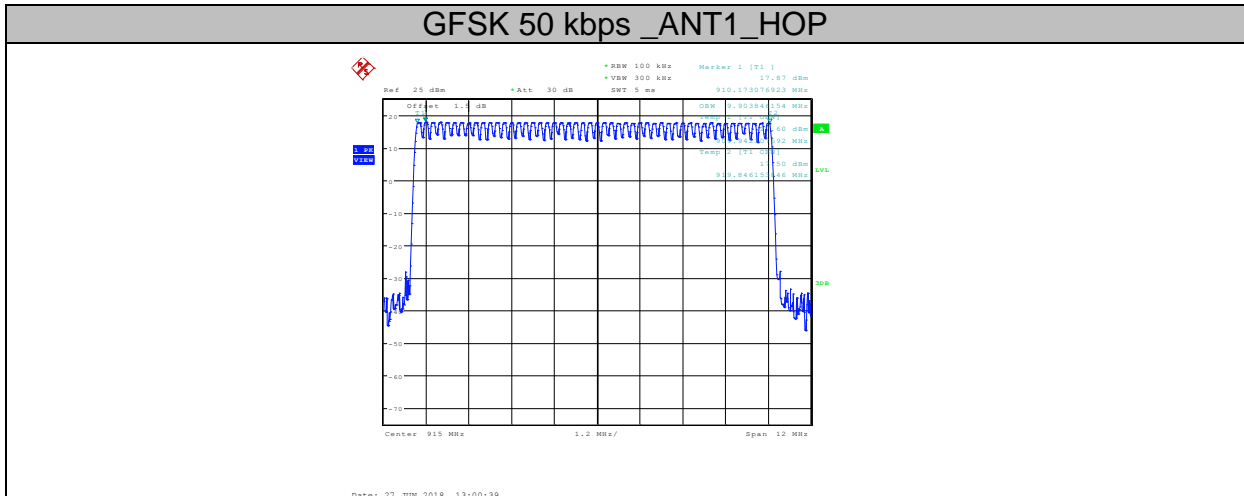

8. Dwell Time

8.1. Block diagram of test setup

Same as section 4.1

8.2. Limits

The average time of occupancy on any channel shall not be greater than 0.4 seconds within a period of 0.4 seconds multiplied by the number of hopping channels employed.

8.3. Test Procedure

- (1) Connect EUT's antenna output to spectrum analyzer by RF cable.
- (2) The test period: $T = 0.4 \text{ Second/Channel} \times 50 \text{ Channel} = 20 \text{ s}$

Analyzer sweep time=900s (transmitter operates every 15 minutes)

Measure the hopping number and on time of each pulse with spectrum analyzer in zero span set, and calculate dwell time with formula $\text{Dwell time} = \text{Number of hops} \times \text{pulse's on time}$ (Number of hops in the period specified in the requirements) $= (\text{number of hops on spectrum analyzer}) \times (\text{period specified in the requirements} / \text{analyzer sweep time})$

8.4. Test Result

| Mode | Dwell time (s) | Pulse's on time (ms) | Total hops | Limit | Conclusion |
|------|----------------|----------------------|------------|--------|------------|
| GFSK | 0.289 | 14.42 | 13 | <400ms | PASS |

Note: $\text{Dwell time} = \text{Number of hops} \times \text{pulse's on time}$. (Number of hops in the period specified in the requirements) $= (\text{number of hops on spectrum analyzer}) \times (\text{period specified in the requirements} / \text{analyzer sweep time})$

8.5. Original test data

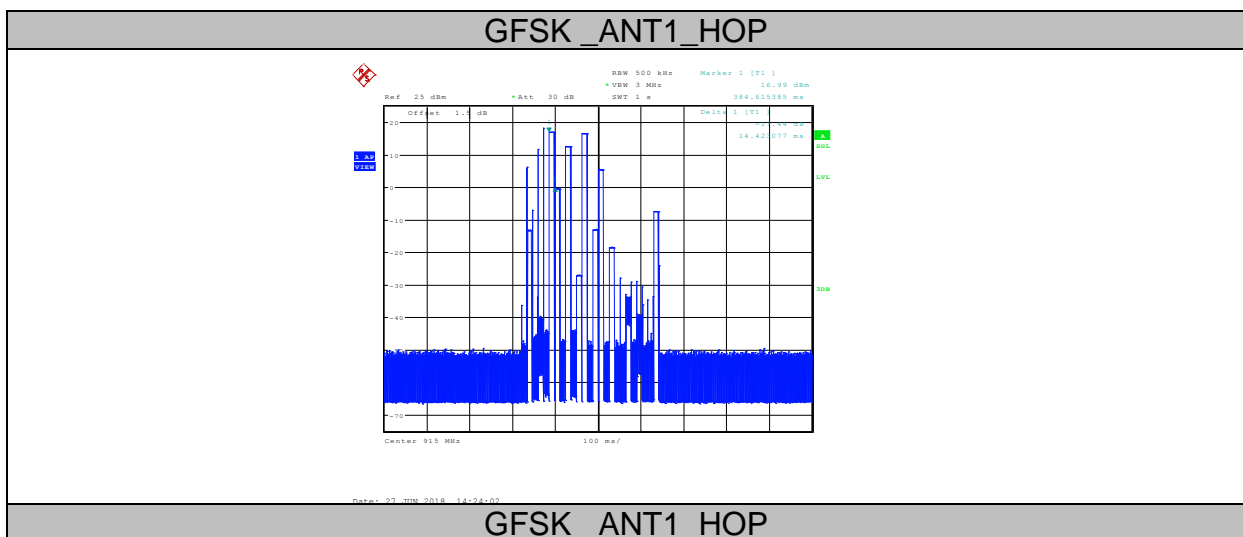

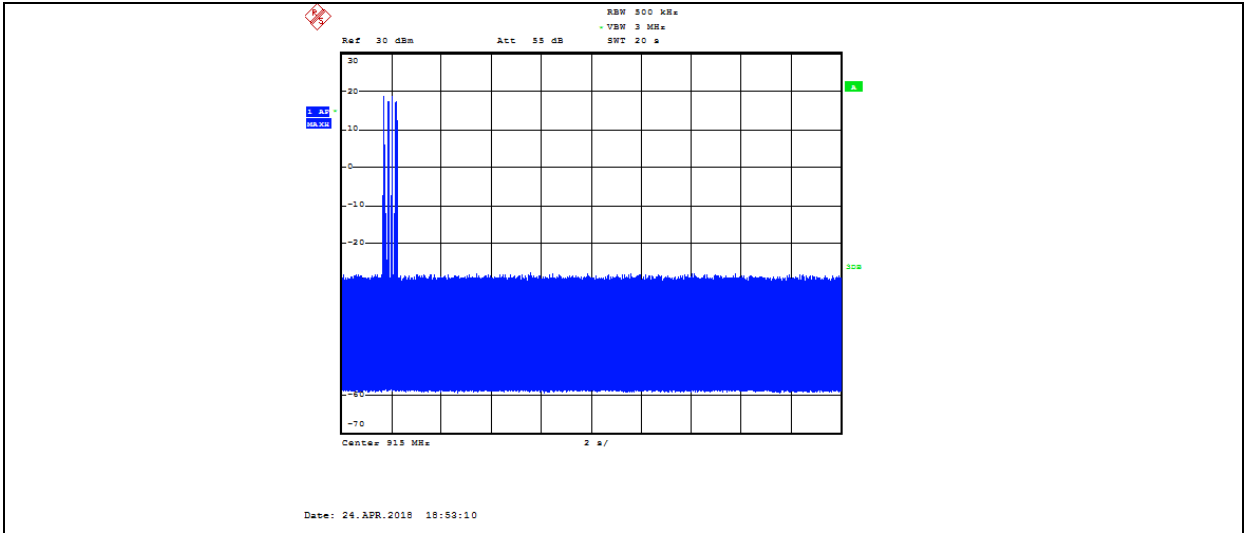

9. Band Edge Compliance (conducted method)

9.1. Block diagram of test setup

Same as section 4.1

9.2. Limit

All restriction band should comply with 15.209, other emission should be at least 20dB below the fundamental.

9.3. Test result

| Mode | Freq (MHz) | Conclusion |
|------|-------------------|------------|
| GFSK | Hopping off 915 | PASS |
| | Hopping off 919.8 | PASS |
| | Hopping on | PASS |

9.4. Original test data

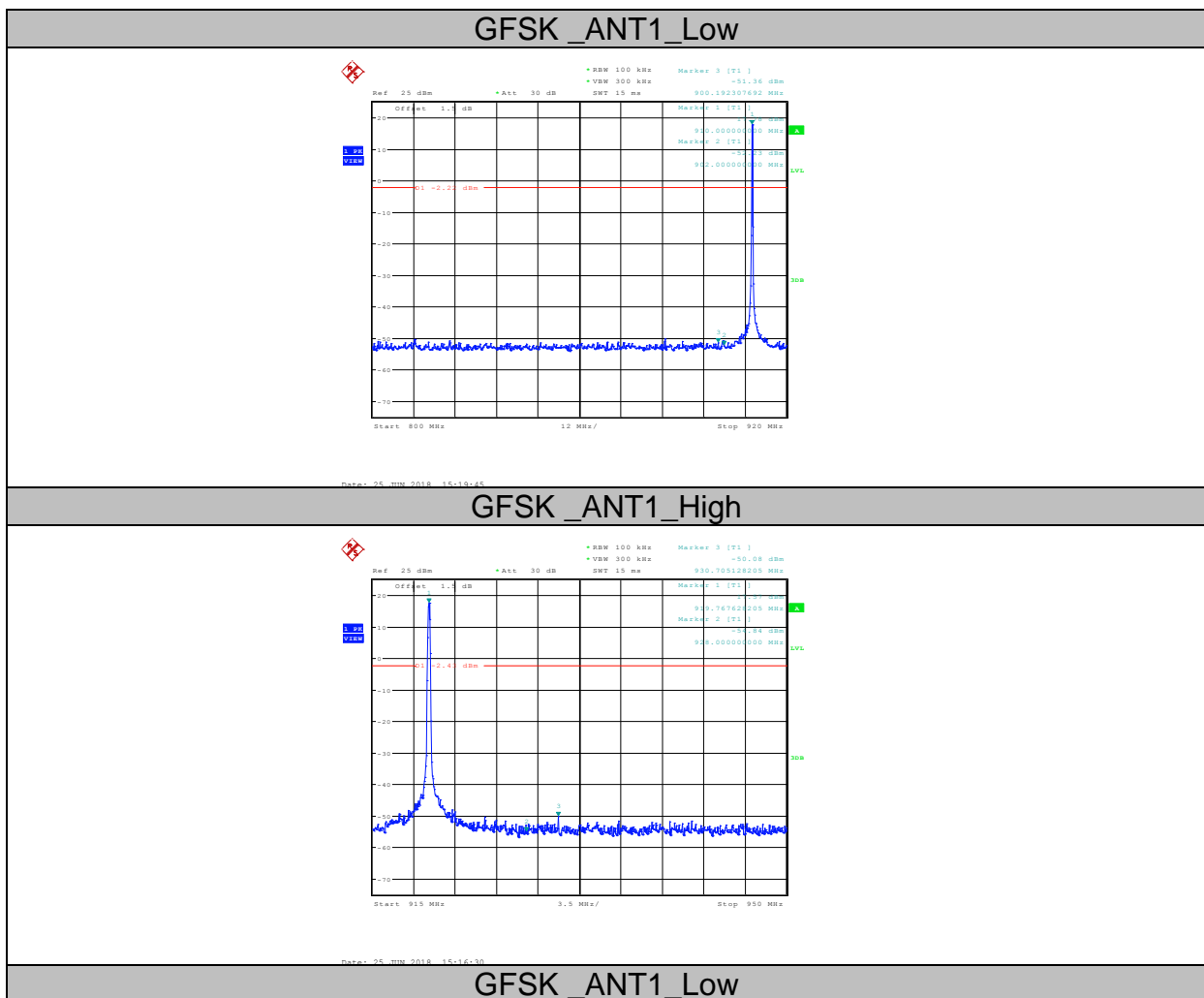

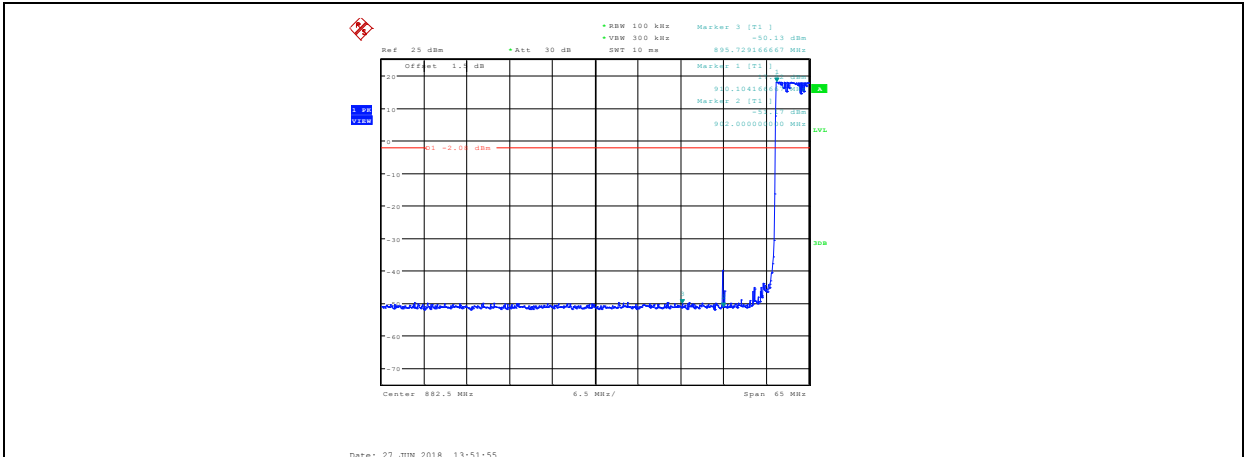

GFSK_ANT1_High

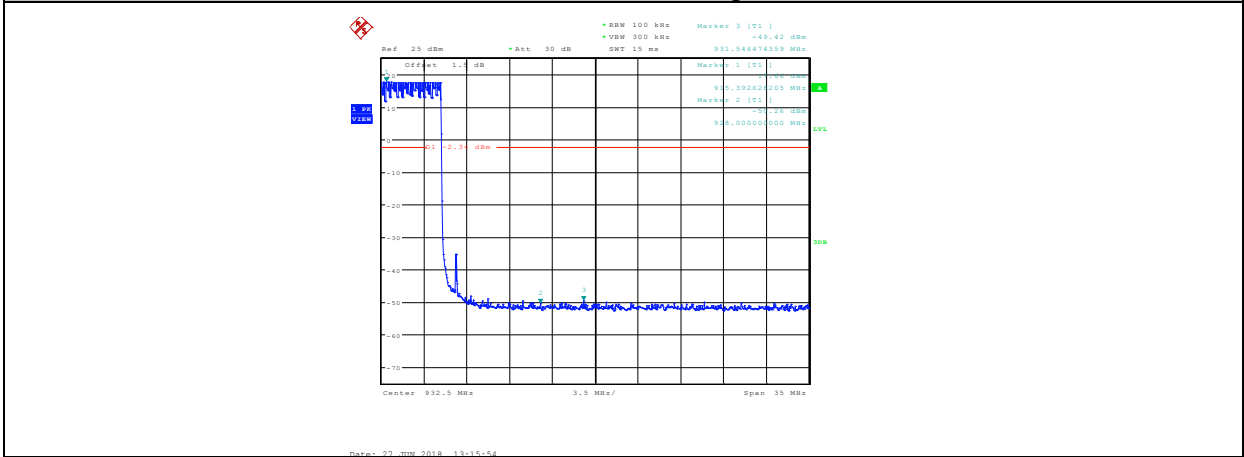

Note:50kbps data and 4.8kbps data rate all have been tested · worse case is reported

10. Radiated emission

10.1. Block diagram of test setup

In 3m Anechoic Chamber Test Setup Diagram for 9kHz-30MHz

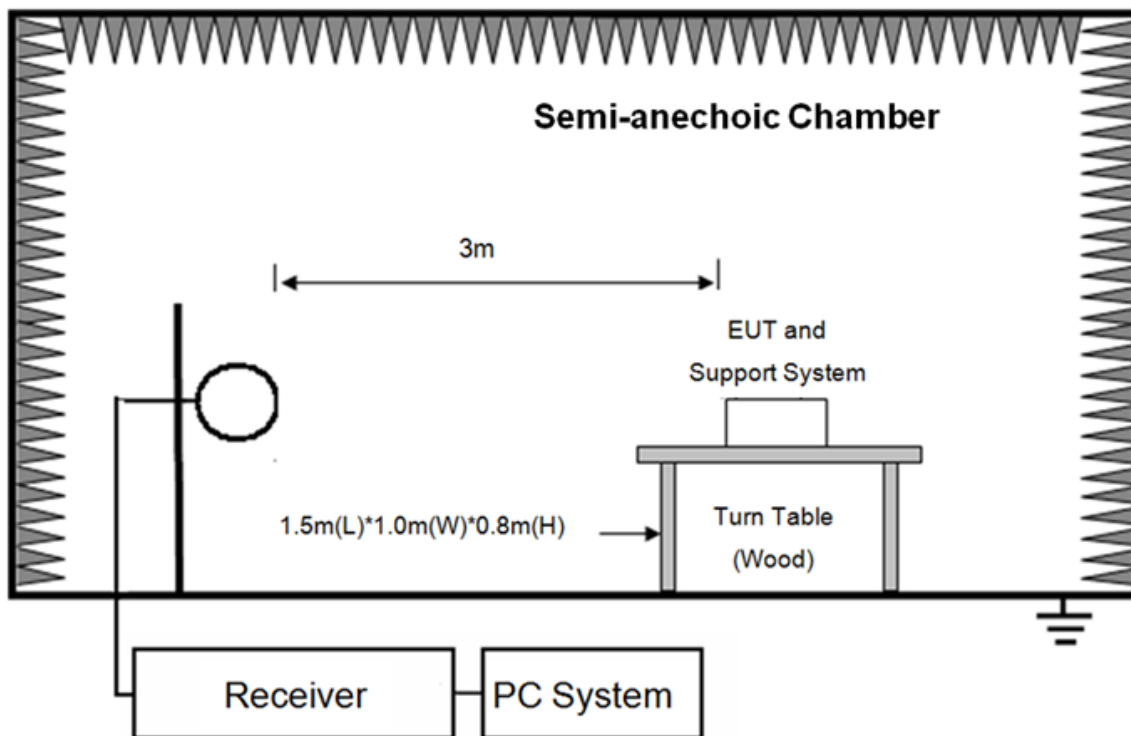

In 3m Anechoic Chamber Test Setup Diagram for below 1GHz

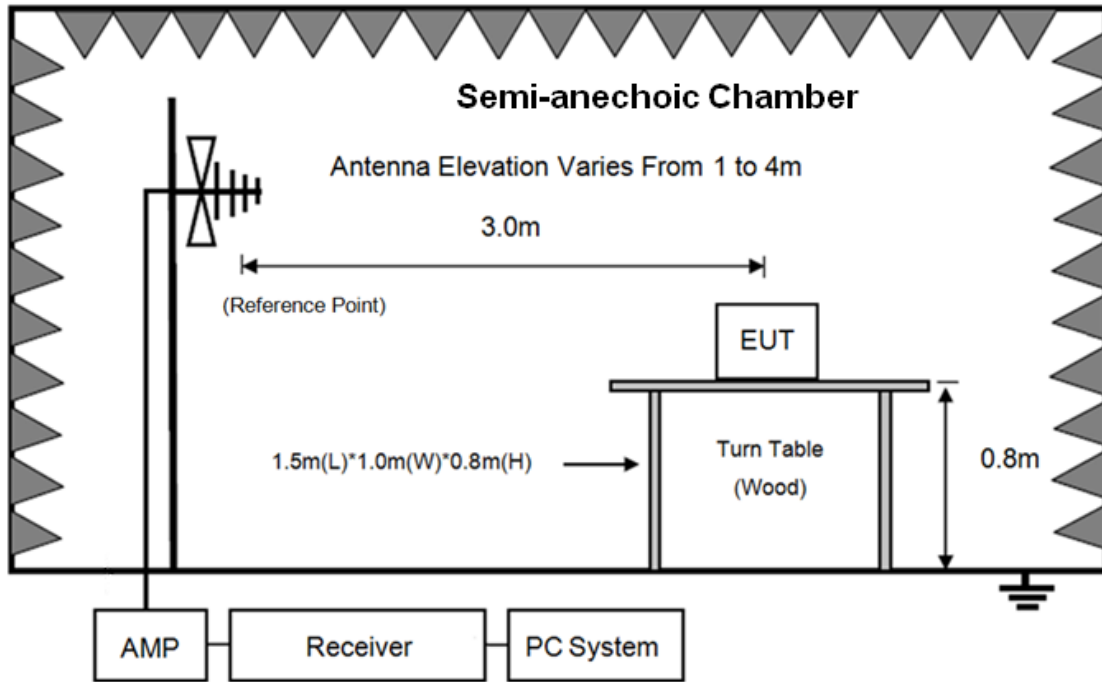

In 3m Anechoic Chamber Test Setup Diagram for frequency above 1GHz

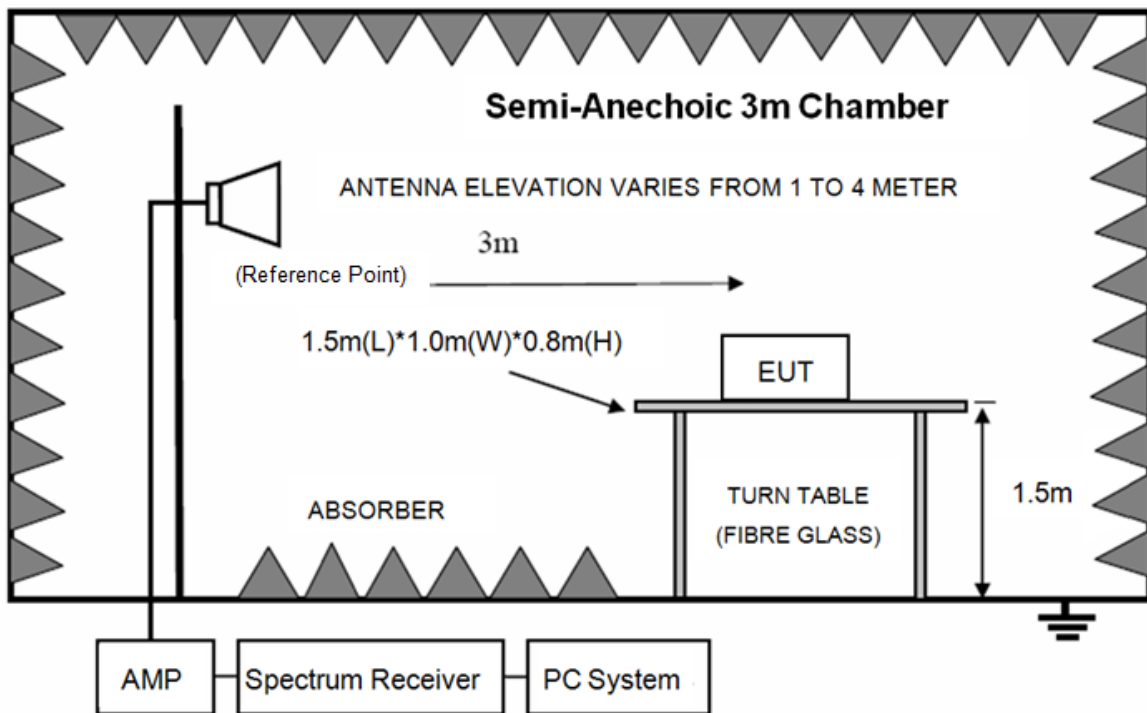

Note: For harmonic emissions test a appropriate high pass filter was inserted in the input port of AMP.

10.2. Limit

(1) FCC 15.205 Restricted frequency band

| MHz | MHz | MHz | GHz |
|-------------|--------------|-----------|----------|
| 0.090-0.110 | 16.42-16.423 | 399.9-410 | 4.5-5.15 |

| | | | |
|-------------------|---------------------|---------------|------------------|
| 10.495-0.505 | 16.69475-16.69525 | 608-614 | 5.35-5.46 |
| 2.1735-2.1905 | 16.80425-16.80475 | 960-1240 | 7.25-7.75 |
| 4.125-4.128 | 25.5-25.67 | 1300-1427 | 8.025-8.5 |
| 4.1772&4.17775 | 37.5-38.25 | 1435-1626.5 | 9.0-9.2 |
| 4.2072&4.20775 | 73-74.6 | 1645.5-1646.5 | 9.3-9.5 |
| 6.215-6.218 | 74.8-75.2 | 1660-1710 | 10.6-12.7 |
| 6.26775-6.26825 | 108-121.94 | 1718.8-1722.2 | 13.25-13.4 |
| 6.31175-6.31225 | 123-138 | 2200-2300 | 14.47-14.5 |
| 8.291-8.294 | 149.9-150.05 | 2310-2390 | 15.35-16.2 |
| 8.362-8.366 | 156.52475-156.52525 | 2483.5-2500 | 17.7-21.4 |
| 8.37625-8.38675 | 156.7-156.9 | 2690-2900 | 22.01-23.12 |
| 8.41425-8.41475 | 162.0125-167.17 | 3260-3267 | 23.6-24.G |
| 12.29-12.293 | 167.72-173.2 | 3332-3339 | 31.2-31.8 |
| 12.51975-12.52025 | 240-285 | 3345.8-3358 | 36.43-36.5 |
| 12.57675-12.57725 | 322-335.4 | 3600-4400 | (²) |
| 13.36-13.41 | | | |

(2) FCC 15.209 Limit.

| FREQUENCY MHz | DISTANCE Meters | FIELD STRENGTHS LIMIT | |
|------------------|--------------------|---------------------------------------------------------------------------|-----------------------------------|
| | | $\mu\text{V}/\text{m}$ | $\text{dB}(\mu\text{V})/\text{m}$ |
| 0.009 ~ 0.490 | 300 | 2400/F(kHz) | 67.6-20log(F) |
| 0.490 ~ 1.705 | 30 | 24000/F(kHz) | 87.6-20log(F) |
| 1.705 ~ 30.0 | 30 | 30 | 29.54 |
| 30 ~ 88 | 3 | 100 | 40.0 |
| 88 ~ 216 | 3 | 150 | 43.5 |
| 216 ~ 960 | 3 | 200 | 46.0 |
| 960 ~ 1000 | 3 | 500 | 54.0 |
| Above 1000 | 3 | 74.0 dB(μV)/m (Peak) 54.0 dB(μV)/m (Average) | |

Note: (1)The emission limits shown in the above table are based on measurements employing a CISPR QP detector except for the frequency bands 9-90kHz, 110-490kHz and above 1000MHz. Radiated emissions limits in these three bands are based on measurements employing an average detector.

(2) At frequencies below 30MHz, measurement may be performed at a distance closer than that specified, and the limit at closer measurement distance can be extrapolated by below formula:

$$\text{Limit}_{3\text{m}}(\text{dB}\mu\text{V}/\text{m}) = \text{Limit}_{30\text{m}}(\text{dB}\mu\text{V}/\text{m}) + 40\text{Log}(30\text{m}/3\text{m})$$

(3) Limit for this EUT

All the emissions appearing within 15.205 restricted frequency bands shall not exceed the limits shown in 15.209, all the other emissions shall be at least 20dB below the fundamental emissions, or comply with 15.209 limits.

10.3. Test Procedure

(1) EUT was placed on a non-metallic table, 80 cm above the ground plane inside a

semi-anechoic chamber for blow 1G and 150 cm above the ground plane inside a semi-anechoic chamber for above 1G.

(2) Test antenna was located 3m from the EUT on an adjustable mast, and the antenna used as below table.

| Test frequency range | Test antenna used | Test antenna distance |
|----------------------|----------------------------------------|-----------------------|
| 9kHz-30MHz | Active Loop antenna | 3m |
| 30MHz-1GHz | Trilog Broadband Antenna | 3m |
| 1GHz-18GHz | Double Ridged Horn Antenna(1GHz-18GHz) | 3m |
| 18GHz-40GHz | Horn Antenna(18GHz-40GHz) | 1m |

According ANSI C63.10:2013 clause 6.4.4.2 and 6.5.3, for measurements below 30 MHz, the loop antenna was positioned with its plane vertical from the EUT and rotated about its vertical axis for maximum response at each azimuth position around the EUT. And the loop antenna also be positioned with its plane horizontal at the specified distance from the EUT. The center of the loop is 1 m above the ground. for measurement above 30MHz, the Trilog Broadband Antenna or Horn Antenna was located 3m from EUT, Measurements were made with the antenna positioned in both the horizontal and vertical planes of

Polarization, and the measurement antenna was varied from 1 m to 4 m. in height above the reference ground plane to obtain the maximum signal strength.

(3) Below pre-scan procedure was first performed in order to find prominent frequency spectrum radiated emissions from 9kHz to 25GHz:

(a) Scanning the peak frequency spectrum with the antenna specified in step (3), and the EUT was rotated 360 degree, the antenna height was varied from 1m to 4m(Except loop antenna, it's fixed 1m above ground.)

(b) Change work frequency or channel of device if practicable.

(c) Change modulation type of device if practicable.

(d) Change power supply range from 85% to 115% of the rated supply voltage

(e) Rotated EUT though three orthogonal axes to determine the attitude of EUT arrangement produces highest emissions.

Spectrum frequency from 9kHz to 25GHz (tenth harmonic of fundamental frequency) was investigated, and no any obvious emission were detected from 10GHz to 25GHz, so below final test was performed with frequency range from 9kHz to 10GHz.

(4) For final emissions measurements at each frequency of interest, the EUT was rotated and the antenna height was varied between 1m and 4m in order to maximize the emission. Measurements in both horizontal and vertical polarities were made and the data was recorded. In order to find the maximum emission, the relative positions of equipments and all of the interface cables were changed according to ANSI C63.10 2013 on Radiated Emission test.

(5) The emissions from 9kHz to 1GHz were measured based on CISPR QP detector except for

the frequency bands 9-90kHz, 110-490kHz, for emissions from 9kHz-90kHz,110kHz-490kHz and above 1GHz were measured based on average detector, for emissions above 1GHz, peak emissions also be measured and need comply with Peak limit.

- (6) The emissions from 9kHz to 1GHz, QP or average values were measured with EMI receiver with below RBW.

| Frequency band | RBW |
|----------------|--------|
| 9kHz-150kHz | 200Hz |
| 150kHz-30MHz | 9kHz |
| 30MHz-1GHz | 120kHz |

- (7) For emissions above 1GHz, both Peak and Average level were measured with Spectrum Analyzer, and the RBW is set at 1MHz, VBW is set at 3MHz for Peak measure; RMS detector RBW 1MHz VBW 3MHz for Average measure(according ANSI C63.10:2013 clause 4.2.3.2.3 procedure for average measure), and for the radiated emissions which outside of there stricted bands, according FCC Part 15: 15.247(d), the RBW is set at 100 kHz, VBW is set at 300kHz for Peak measure, the radio frequency power that is produced by the intentional radiator shall be at least 20 dB below that in the 100 kHz bandwidth within the band that contains the highest level of the desired power.
- (8) X axis, Y axis, Z axis are tested, and worse setup X axis is reported.
- (9) 50kbps data and 4.8kbps data rate all have been tested, worse case is reported

10.4. Test result

PASS. (See below detailed test result)

Note1: According exploratory test no any obvious emission ware detected from 9kHz to 30MHz and 10GHz to 25GHz.

Note2: For emissions above 1GHz. If peak results comply with AV limit, AV Result is deemed to comply with AV limit.

Radiated Emission test (below 1GHz)

TR-4-E-009 Radiated Emission Test Result

| | | |
|---------------------|---------------------------------------------|------------------------------------------------------------------|
| Test Site | : DDT 3m Chamber 1# | D:\2018 RE1# Report Data\Q18050304-1E GW2\FCC BELOW1G.EM6 |
| Test Date | : 2018-06-25 | Tested By : Talent |
| EUT | : Ceres Gateway 2 | Model Number : GW2 |
| Power Supply | : DC 5V from AC Adapter | Test Mode : Tx mode |
| Condition | : Temp:24.5'C,Humi:55.5%, Press:100.1kPa | Antenna/Distance : 2017 VULB 9163 1#/3m/VERTICAL |
| Memo | : 910M | |

Data: 39

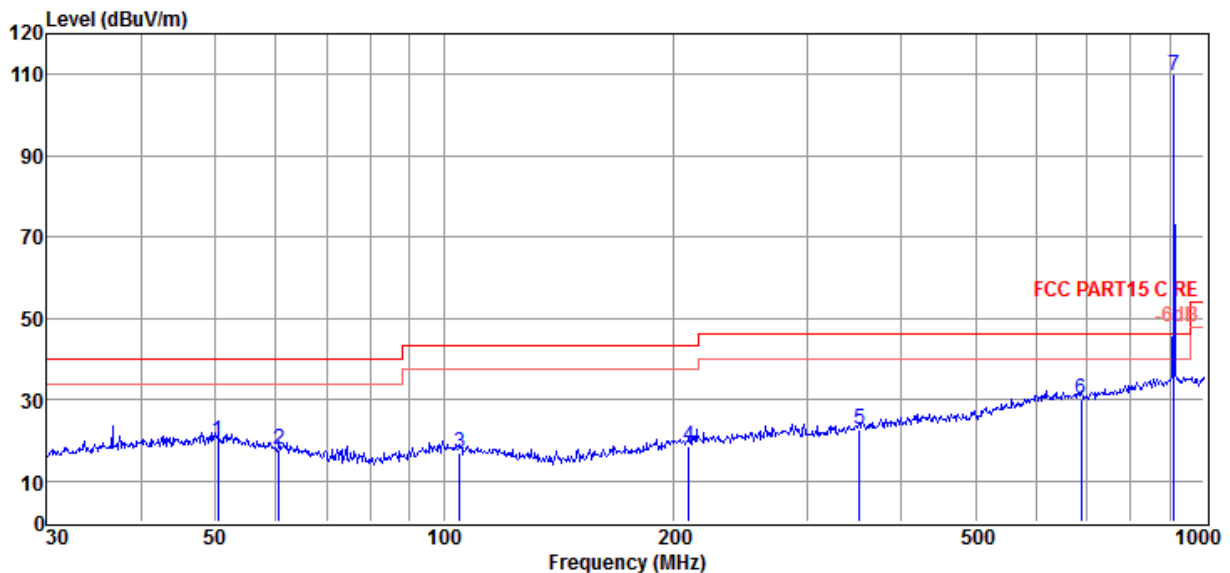

| Item (Mark) | Freq. (MHz) | Read Level (dBμV) | Antenna Factor (dB/m) | Cable Loss dB | Result Level (dBμV/m) | Limit Line (dBμV/m) | Over Limit (dB) | Detector | Polarization |
|----------------|----------------|-------------------------|-----------------------------|---------------------|-----------------------------|---------------------------|-----------------------|----------|--------------|
| 1 | 50.41 | 2.30 | 13.69 | 4.00 | 19.99 | 40.00 | -20.01 | QP | VERTICAL |
| 2 | 60.70 | 2.60 | 11.23 | 4.10 | 17.93 | 40.00 | -22.07 | QP | VERTICAL |
| 3 | 104.90 | 1.56 | 10.90 | 4.45 | 16.91 | 43.50 | -26.59 | QP | VERTICAL |
| 4 | 210.05 | 1.65 | 11.72 | 5.08 | 18.45 | 43.50 | -25.05 | QP | VERTICAL |
| 5 | 351.71 | 2.41 | 14.35 | 5.76 | 22.52 | 46.00 | -23.48 | QP | VERTICAL |
| 6 | 689.56 | 3.51 | 19.67 | 6.98 | 30.16 | 46.00 | -15.84 | QP | VERTICAL |
| 7 | 912.86 | 79.55 | 22.57 | 7.64 | 109.76 | / | / | Peak | VERTICAL |

Note: 1. Result Level = Read Level + Antenna Factor + Cable loss.

2. If Peak Result complies with QP limit, QP Result is deemed to comply with QP limit.

3. Test setup: RBW: 120 kHz, VBW: 300 kHz, Sweep time: auto.

TR-4-E-009 Radiated Emission Test Result

| | | |
|---------------------|---------------------------------------------|-----------------------------------------------------------|
| Test Site | : DDT 3m Chamber 1# | D:\2018 RE1# Report Data\Q18050304-1E GW2\FCC BELOW1G.EM6 |
| Test Date | : 2018-06-25 | Tested By : Talent |
| EUT | : Ceres Gateway 2 | Model Number : GW2 |
| Power Supply | : DC 5V from AC Adapter | Test Mode : Tx mode |
| Condition | : Temp:24.5'C,Humi:55.5%, Press:100.1kPa | Antenna/Distance : 2017 VULB 9163 1#/3m/HORIZONTAL |
| Memo | : 910M | |

Data: 40

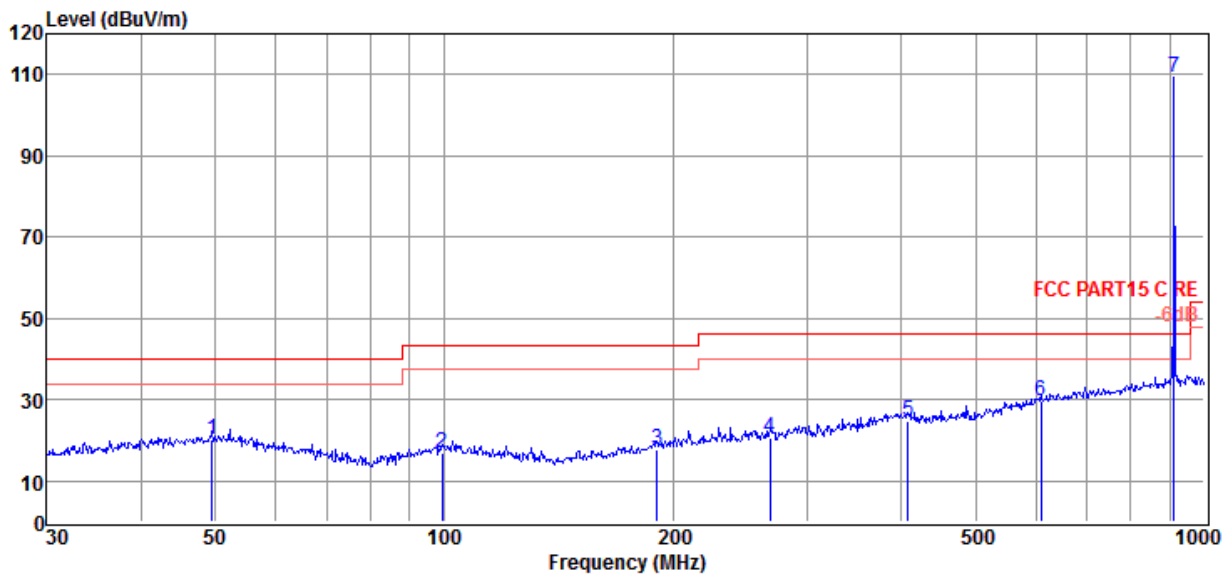

| Item (Mark) | Freq. (MHz) | Read Level (dBμV) | Antenna Factor (dB/m) | Cable Loss (dB) | Result Level (dBμV/m) | Limit Line (dBμV/m) | Over Limit (dB) | Detector | Polarization |
|-------------|-------------|-------------------|-----------------------|-----------------|-----------------------|---------------------|-----------------|----------|--------------|
| 1 | 49.53 | 2.47 | 13.75 | 3.99 | 20.21 | 40.00 | -19.79 | QP | HORIZONTAL |
| 2 | 99.53 | 1.13 | 11.41 | 4.41 | 16.95 | 43.50 | -26.55 | QP | HORIZONTAL |
| 3 | 190.41 | 2.22 | 10.66 | 4.98 | 17.86 | 43.50 | -25.64 | QP | HORIZONTAL |
| 4 | 268.49 | 2.55 | 12.81 | 5.38 | 20.74 | 46.00 | -25.26 | QP | HORIZONTAL |
| 5 | 407.51 | 3.64 | 15.39 | 5.90 | 24.93 | 46.00 | -21.07 | QP | HORIZONTAL |
| 6 | 609.92 | 3.39 | 19.43 | 6.71 | 29.53 | 46.00 | -16.47 | QP | HORIZONTAL |
| 7 | 912.86 | 78.91 | 22.57 | 7.64 | 109.12 | / | / | Peak | HORIZONTAL |

- Note: 1. Result Level = Read Level + Antenna Factor + Cable loss.
 2. If Peak Result complies with QP limit, QP Result is deemed to comply with QP limit.
 3. Test setup: RBW: 120 kHz, VBW: 300 kHz, Sweep time: auto.

TR-4-E-009 Radiated Emission Test Result

Test Site : DDT 3m Chamber 1#

D:\2018 RE1# Report Data\Q18050304-1E GW2\FCC
BELOW1G.EM6

Test Date : 2018-06-25

Tested By : Talent

EUT : Ceres Gateway 2

Model Number : GW2

Power Supply : DC 5V from AC Adapter

Test Mode : Tx mode

Condition : Temp:24.5'C,Humi:55.5%,
Press:100.1kPa

Antenna/Distance : 2017 VULB 9163 1#/3m/HORIZONTAL

Memo : 915M

Data: 37

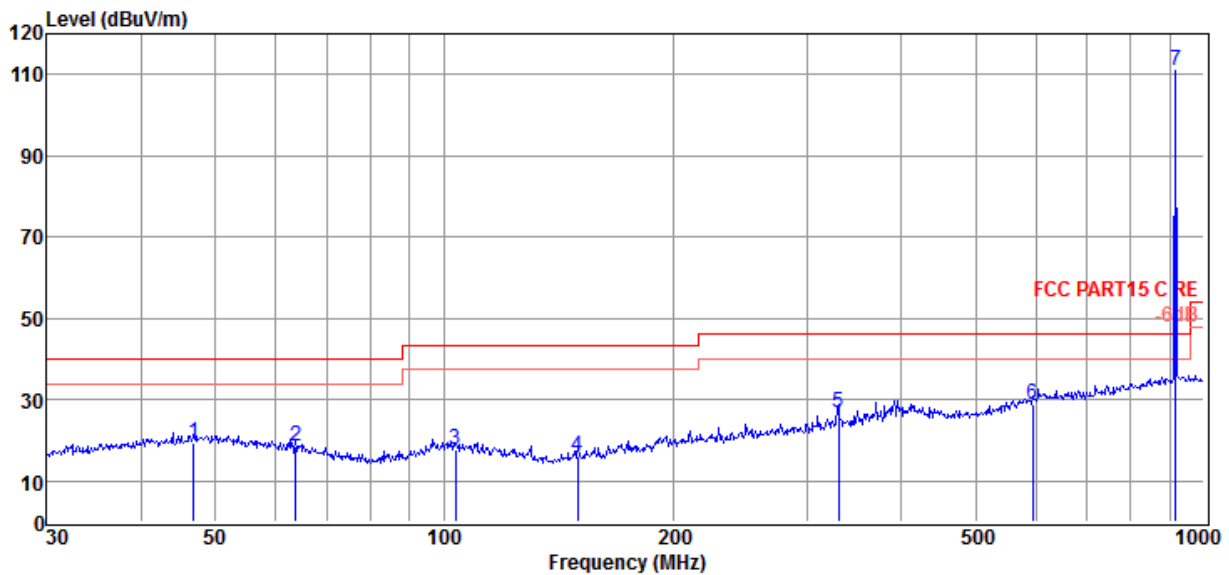

| Item (Mark) | Freq. (MHz) | Read Level (dB μ V) | Antenna Factor (dB/m) | Cable Loss dB | Result Level (dB μ V/m) | Limit Line (dB μ V/m) | Over Limit (dB) | Detector | Polarization |
|----------------|----------------|-------------------------------|-----------------------------|---------------------|-----------------------------------|---------------------------------|-----------------------|----------|--------------|
| 1 | 46.83 | 2.02 | 13.45 | 3.96 | 19.43 | 40.00 | -20.57 | QP | HORIZONTAL |
| 2 | 63.76 | 3.72 | 10.53 | 4.13 | 18.38 | 40.00 | -21.62 | QP | HORIZONTAL |
| 3 | 103.44 | 2.06 | 11.07 | 4.44 | 17.57 | 43.50 | -25.93 | QP | HORIZONTAL |
| 4 | 150.01 | 3.19 | 8.02 | 4.77 | 15.98 | 43.50 | -27.52 | QP | HORIZONTAL |
| 5 | 330.20 | 7.21 | 13.93 | 5.66 | 26.80 | 46.00 | -19.20 | QP | HORIZONTAL |
| 6 | 595.13 | 2.85 | 19.32 | 6.61 | 28.78 | 46.00 | -17.22 | QP | HORIZONTAL |
| 7 | 916.07 | 80.53 | 22.57 | 7.65 | 110.75 | / | / | Peak | HORIZONTAL |

Note: 1. Result Level = Read Level + Antenna Factor + Cable loss.

2. If Peak Result complies with QP limit, QP Result is deemed to comply with QP limit.

3. Test setup: RBW: 120 kHz, VBW: 300 kHz, Sweep time: auto.

TR-4-E-009 Radiated Emission Test Result

Test Site : DDT 3m Chamber 1#

D:\2018 RE1# Report Data\Q18050304-1E GW2\FCC
BELOW1G.EM6

Test Date : 2018-06-25

Tested By : Talent

EUT : Ceres Gateway 2

Model Number : GW2

Power Supply : DC 5V from AC Adapter

Test Mode : Tx mode

Condition : Temp:24.5'C,Humi:55.5%,
Press:100.1kPa

Antenna/Distance : 2017 VULB 9163 1#/3m/VERTICAL

Memo : 915M

Data: 38

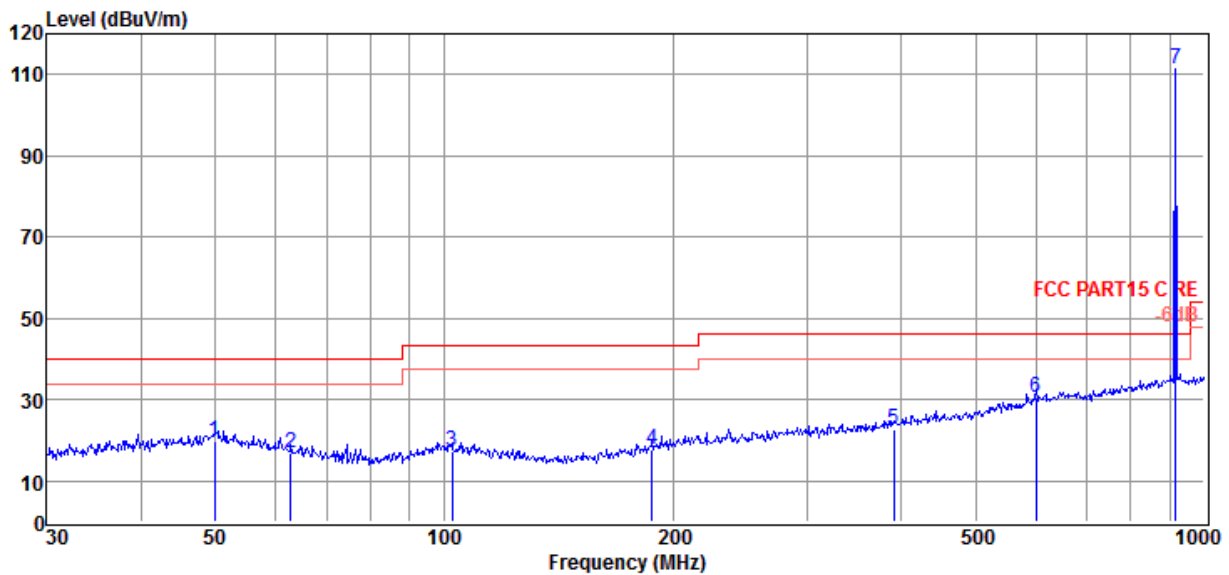

| Item (Mark) | Freq. (MHz) | Read Level (dBμV) | Antenna Factor (dB/m) | Cable Loss dB | Result Level (dBμV/m) | Limit Line (dBμV/m) | Over Limit (dB) | Detector | Polarization |
|----------------|----------------|-------------------------|-----------------------------|---------------------|-----------------------------|---------------------------|-----------------------|----------|--------------|
| 1 | 49.88 | 2.11 | 13.79 | 3.99 | 19.89 | 40.00 | -20.11 | QP | VERTICAL |
| 2 | 62.87 | 1.95 | 10.73 | 4.12 | 16.80 | 40.00 | -23.20 | QP | VERTICAL |
| 3 | 102.36 | 1.83 | 11.21 | 4.43 | 17.47 | 43.50 | -26.03 | QP | VERTICAL |
| 4 | 187.75 | 2.34 | 10.42 | 4.96 | 17.72 | 43.50 | -25.78 | QP | VERTICAL |
| 5 | 390.72 | 1.77 | 15.05 | 5.91 | 22.73 | 46.00 | -23.27 | QP | VERTICAL |
| 6 | 601.43 | 4.60 | 19.40 | 6.68 | 30.68 | 46.00 | -15.32 | QP | VERTICAL |
| 7 | 916.07 | 80.95 | 22.57 | 7.65 | 111.17 | / | / | Peak | VERTICAL |

Note: 1. Result Level = Read Level + Antenna Factor + Cable loss.

2. If Peak Result complies with QP limit, QP Result is deemed to comply with QP limit.

3. Test setup: RBW: 120 kHz, VBW: 300 kHz, Sweep time: auto.

TR-4-E-009 Radiated Emission Test Result

Test Site : DDT 3m Chamber 1#

D:\2018 RE1# Report Data\Q18050304-1E GW2\FCC
BELOW1G.EM6

Test Date : 2018-06-25

Tested By : Talent

EUT : Ceres Gateway 2

Model Number : GW2

Power Supply : DC 5V from AC Adapter

Test Mode : Tx mode

Condition : Temp:24.5'C,Humi:55.5%,
Press:100.1kPa

Antenna/Distance : 2017 VULB 9163 1#/3m/VERTICAL

Memo : 919.8M

Data: 35

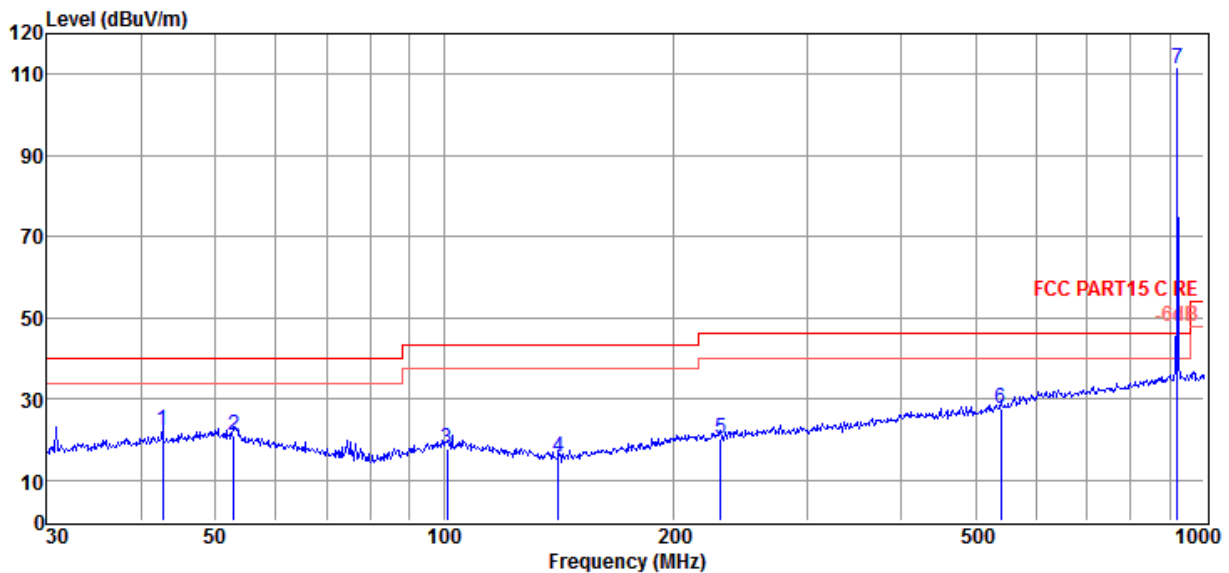

| Item (Mark) | Freq. (MHz) | Read Level (dB μ V) | Antenna Factor (dB/m) | Cable Loss dB | Result Level (dB μ V/m) | Limit Line (dB μ V/m) | Over Limit (dB) | Detector | Polarization |
|----------------|----------------|-------------------------------|-----------------------------|---------------------|-----------------------------------|---------------------------------|-----------------------|----------|--------------|
| 1 | 42.60 | 5.25 | 12.94 | 3.90 | 22.09 | 40.00 | -17.91 | QP | VERTICAL |
| 2 | 52.95 | 4.09 | 13.05 | 4.02 | 21.16 | 40.00 | -18.84 | QP | VERTICAL |
| 3 | 100.93 | 2.05 | 11.38 | 4.42 | 17.85 | 43.50 | -25.65 | QP | VERTICAL |
| 4 | 141.33 | 3.30 | 7.48 | 4.71 | 15.49 | 43.50 | -28.01 | QP | VERTICAL |
| 5 | 230.91 | 2.85 | 12.14 | 5.20 | 20.19 | 46.00 | -25.81 | QP | VERTICAL |
| 6 | 539.48 | 3.44 | 18.29 | 5.88 | 27.61 | 46.00 | -18.39 | QP | VERTICAL |
| 7 | 922.52 | 81.29 | 22.55 | 7.67 | 111.51 | / | / | Peak | VERTICAL |

Note: 1. Result Level = Read Level + Antenna Factor + Cable loss.

2. If Peak Result complies with QP limit, QP Result is deemed to comply with QP limit.

3. Test setup: RBW: 120 kHz, VBW: 300 kHz, Sweep time: auto.

TR-4-E-009 Radiated Emission Test Result

Test Site : DDT 3m Chamber 1#

D:\2018 RE1# Report Data\Q18050304-1E GW2\FCC
BELOW1G.EM6

Test Date : 2018-06-25

Tested By : Talent

EUT : Ceres Gateway 2

Model Number : GW2

Power Supply : DC 5V from AC Adapter

Test Mode : Tx mode

Condition : Temp:24.5'C,Humi:55.5%,
Press:100.1kPa

Antenna/Distance : 2017 VULB 9163 1#/3m/HORIZONTAL

Memo : 919.8M

Data: 36

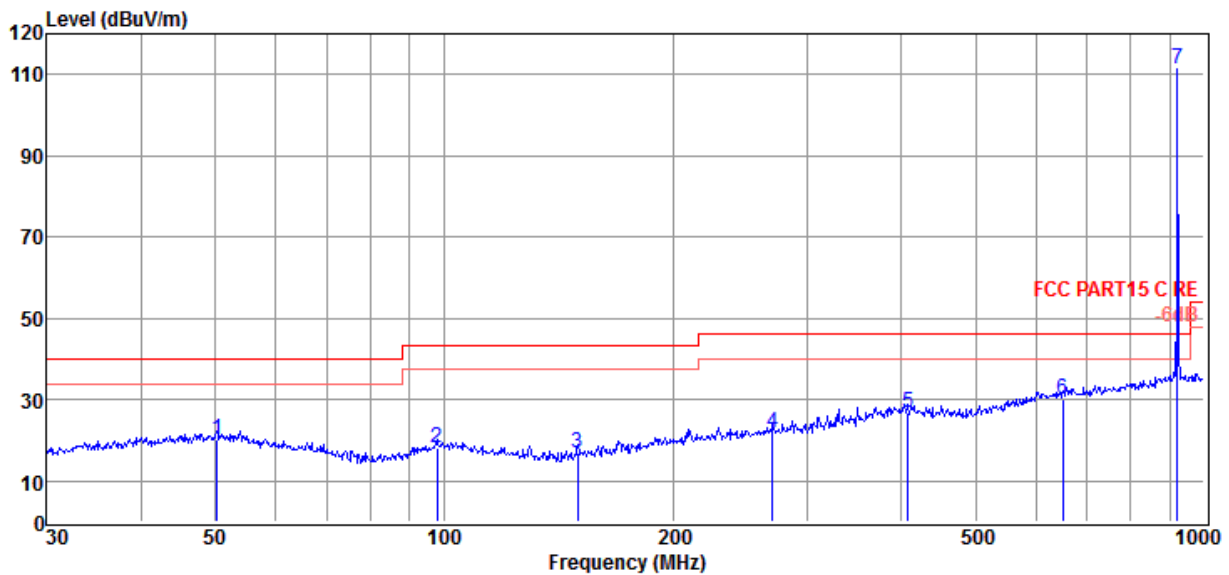

| Item (Mark) | Freq. (MHz) | Read Level (dBμV) | Antenna Factor (dB/m) | Cable Loss dB | Result Level (dBμV/m) | Limit Line (dBμV/m) | Over Limit (dB) | Detector | Polarization |
|----------------|----------------|-------------------------|-----------------------------|---------------------|-----------------------------|---------------------------|-----------------------|----------|--------------|
| 1 | 50.23 | 2.50 | 13.74 | 3.99 | 20.23 | 40.00 | -19.77 | QP | HORIZONTAL |
| 2 | 97.80 | 2.68 | 11.06 | 4.39 | 18.13 | 43.50 | -25.37 | QP | HORIZONTAL |
| 3 | 150.01 | 3.99 | 8.02 | 4.77 | 16.78 | 43.50 | -26.72 | QP | HORIZONTAL |
| 4 | 270.38 | 3.79 | 12.84 | 5.39 | 22.02 | 46.00 | -23.98 | QP | HORIZONTAL |
| 5 | 407.51 | 5.56 | 15.39 | 5.90 | 26.85 | 46.00 | -19.15 | QP | HORIZONTAL |
| 6 | 651.94 | 3.81 | 19.56 | 6.85 | 30.22 | 46.00 | -15.78 | QP | HORIZONTAL |
| 7 | 922.52 | 80.96 | 22.55 | 7.67 | 111.18 | / | / | Peak | HORIZONTAL |

Note: 1. Result Level = Read Level + Antenna Factor + Cable loss.

2. If Peak Result complies with QP limit, QP Result is deemed to comply with QP limit.

3. Test setup: RBW: 120 kHz, VBW: 300 kHz, Sweep time: auto.

Radiated Emission test (above 1GHz)

| Freq. (MHz) | Read level (dBμV) | Antenna Factor (dB/m) | PRM Factor (dB) | Cable Loss (dB) | Result Level (dBμV/m) | Limit (dBμV/m) | Margin (dB) | Detector type | Polarization |
|------------------------------|-------------------------|-----------------------------|-----------------------|-----------------------|-----------------------------|-----------------------|----------------|------------------|--------------|
| GFSK Tx mode 910MHz | | | | | | | | | |
| 2728.00 | 55.22 | 28.31 | 44.34 | 5.48 | 44.67 | 74.00 | -29.33 | Peak | HORIZONTAL |
| 4195.00 | 48.62 | 33.16 | 44.28 | 6.78 | 44.28 | 74.00 | -29.72 | Peak | HORIZONTAL |
| 5419.00 | 47.93 | 35.42 | 43.55 | 7.84 | 47.64 | 74.00 | -26.36 | Peak | HORIZONTAL |
| 6337.00 | 47.13 | 35.70 | 43.30 | 8.25 | 47.78 | 74.00 | -26.22 | Peak | HORIZONTAL |
| 7039.00 | 46.04 | 36.82 | 43.51 | 8.37 | 47.72 | 74.00 | -26.28 | Peak | HORIZONTAL |
| 7462.00 | 46.21 | 36.98 | 43.64 | 8.75 | 48.30 | 74.00 | -25.70 | Peak | HORIZONTAL |
| 2728.00 | 57.64 | 28.31 | 44.34 | 5.48 | 47.09 | 74.00 | -26.91 | Peak | VERTICAL |
| 3637.00 | 53.32 | 32.06 | 44.38 | 6.29 | 47.29 | 74.00 | -26.71 | Peak | VERTICAL |
| 4546.00 | 49.29 | 34.27 | 44.07 | 7.13 | 46.62 | 74.00 | -27.38 | Peak | VERTICAL |
| 5464.00 | 49.99 | 35.46 | 43.52 | 7.87 | 49.80 | 74.00 | -24.20 | Peak | VERTICAL |
| 6076.00 | 47.38 | 35.70 | 43.22 | 8.22 | 48.08 | 74.00 | -25.92 | Peak | VERTICAL |
| 7399.00 | 45.65 | 36.96 | 43.62 | 8.69 | 47.68 | 74.00 | -26.32 | Peak | VERTICAL |
| GFSK Tx mode 915MHz | | | | | | | | | |
| 2746.00 | 54.99 | 28.38 | 44.34 | 5.50 | 44.53 | 74.00 | -29.47 | Peak | HORIZONTAL |
| 3907.00 | 48.93 | 32.39 | 44.40 | 6.51 | 43.43 | 74.00 | -30.57 | Peak | HORIZONTAL |
| 5275.00 | 49.01 | 35.28 | 43.64 | 7.75 | 48.40 | 74.00 | -25.60 | Peak | HORIZONTAL |
| 6049.00 | 47.25 | 35.70 | 43.21 | 8.22 | 47.96 | 74.00 | -26.04 | Peak | HORIZONTAL |
| 7183.00 | 45.60 | 36.87 | 43.55 | 8.49 | 47.41 | 74.00 | -26.59 | Peak | HORIZONTAL |
| 7552.00 | 46.07 | 37.02 | 43.67 | 8.83 | 48.25 | 74.00 | -25.75 | Peak | HORIZONTAL |
| 2746.00 | 56.27 | 28.38 | 44.34 | 5.50 | 45.81 | 74.00 | -28.19 | Peak | VERTICAL |
| 3664.00 | 52.83 | 32.10 | 44.38 | 6.31 | 46.86 | 74.00 | -27.14 | Peak | VERTICAL |
| 4573.00 | 49.22 | 34.32 | 44.06 | 7.15 | 46.63 | 74.00 | -27.37 | Peak | VERTICAL |
| 5032.00 | 47.58 | 35.03 | 43.78 | 7.60 | 46.43 | 74.00 | -27.57 | Peak | VERTICAL |
| 5725.00 | 47.55 | 35.59 | 43.37 | 8.04 | 47.81 | 74.00 | -26.19 | Peak | VERTICAL |
| 6130.00 | 47.84 | 35.70 | 43.24 | 8.23 | 48.53 | 74.00 | -25.47 | Peak | VERTICAL |
| GFSK Tx mode 919.8MHz | | | | | | | | | |
| 2755.00 | 52.96 | 28.42 | 44.34 | 5.51 | 42.55 | 74.00 | -31.45 | Peak | HORIZONTAL |
| 4294.00 | 48.09 | 33.50 | 44.22 | 6.87 | 44.24 | 74.00 | -29.76 | Peak | HORIZONTAL |
| 5230.00 | 47.54 | 35.23 | 43.66 | 7.72 | 46.83 | 74.00 | -27.17 | Peak | HORIZONTAL |
| 5995.00 | 49.84 | 35.70 | 43.20 | 8.21 | 50.55 | 74.00 | -23.45 | Peak | HORIZONTAL |
| 7120.00 | 45.96 | 36.85 | 43.54 | 8.44 | 47.71 | 74.00 | -26.29 | Peak | HORIZONTAL |
| 7822.00 | 45.94 | 37.13 | 43.75 | 9.07 | 48.39 | 74.00 | -25.61 | Peak | HORIZONTAL |
| 2755.00 | 54.52 | 28.42 | 44.34 | 5.51 | 44.11 | 74.00 | -29.89 | Peak | VERTICAL |
| 3682.00 | 52.44 | 32.12 | 44.38 | 6.33 | 46.51 | 74.00 | -27.49 | Peak | VERTICAL |
| 4600.00 | 52.12 | 34.36 | 44.04 | 7.18 | 49.62 | 74.00 | -24.38 | Peak | VERTICAL |
| 5257.00 | 47.90 | 35.26 | 43.65 | 7.74 | 47.25 | 74.00 | -26.75 | Peak | VERTICAL |
| 6085.00 | 48.15 | 35.70 | 43.23 | 8.22 | 48.84 | 74.00 | -25.16 | Peak | VERTICAL |
| 7066.00 | 45.63 | 36.83 | 43.52 | 8.39 | 47.33 | 74.00 | -26.67 | Peak | VERTICAL |
| Result: Pass | | | | | | | | | |

Note: 1. Result Level = Read Level + Antenna Factor + Cable loss - PRM Factor.

2. For emissions above 1GHz. If peak results comply with AV limit, AV Result is deemed to comply with AV limit.

3. Note:50kbps data and 4.8kbps data rate all have been tested · worse case is reported.

11. RF Conducted Spurious Emissions

11.1. Block diagram of test setup

Same as section 4.1

11.2. Limits

In any 100kHz bandwidth outside the frequency bands in which the spread spectrum intentional radiator is operating, the radio frequency power that is produced by the intentional radiator shall be at least 20dB below that in the 100kHz bandwidth within the band that contains the highest level of the desired power.

11.3. Test Procedure

(1) Connect EUT's antenna output to spectrum analyzer by RF cable.

(2) Establish a reference level by using the following procedure:

| | |
|------------------|------------------------------|
| Center frequency | DTS Channel center frequency |
| RBW: | 100kHz |
| VBW: | 300kHz |
| Span | 1.5times the DTS bandwidth |
| Detector Mode: | Peak |
| Sweep time: | auto |
| Trace mode | Max hold |

(3) Allow the trace to stabilize, use the peak marker function to determine the maximum peak power level to establish the reference level.

(4) Set the spectrum analyzer as follows:

| | |
|------------------------------|------------------------------------------|
| RBW: | 100kHz |
| VBW: | 300kHz |
| Span | Encompass frequency range to be measured |
| Number of measurement points | $\geq \text{span}/\text{RBW}$ |
| Detector Mode: | Peak |
| Sweep time: | auto |
| Trace mode | Max hold |

(5) Allow the trace to stabilize, use the peak marker function to determine the maximum amplitude of all unwanted emissions outside of the authorized frequency band .

11.4. Test Result

| Mode | Freq. (MHz) | Conclusion |
|------|-------------|------------|
|------|-------------|------------|

| | | |
|------|-------------------|------|
| GFSK | Hopping off 910 | PASS |
| | Hopping off 915 | PASS |
| | Hopping off 919.8 | PASS |

11.5. Original test data

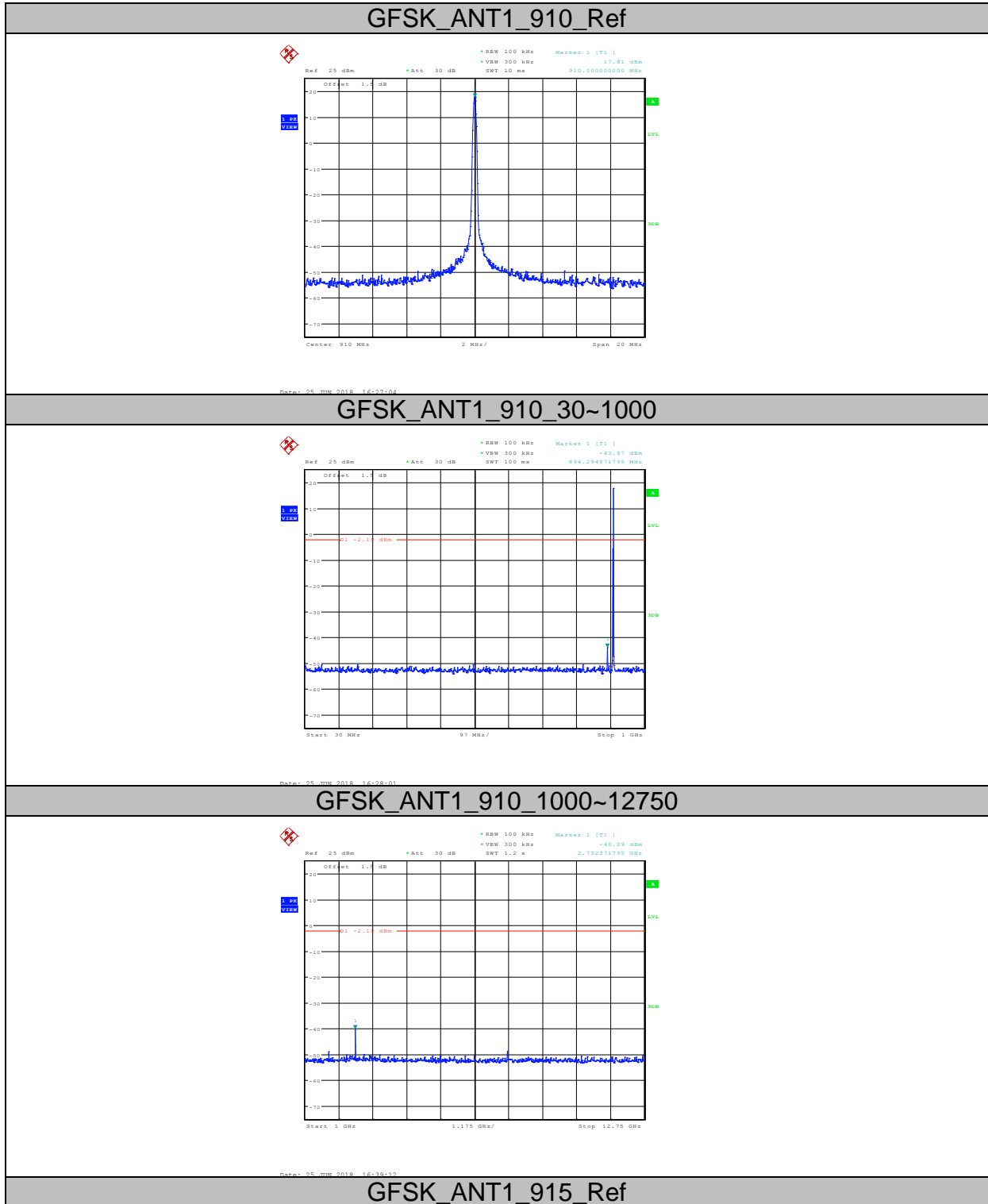

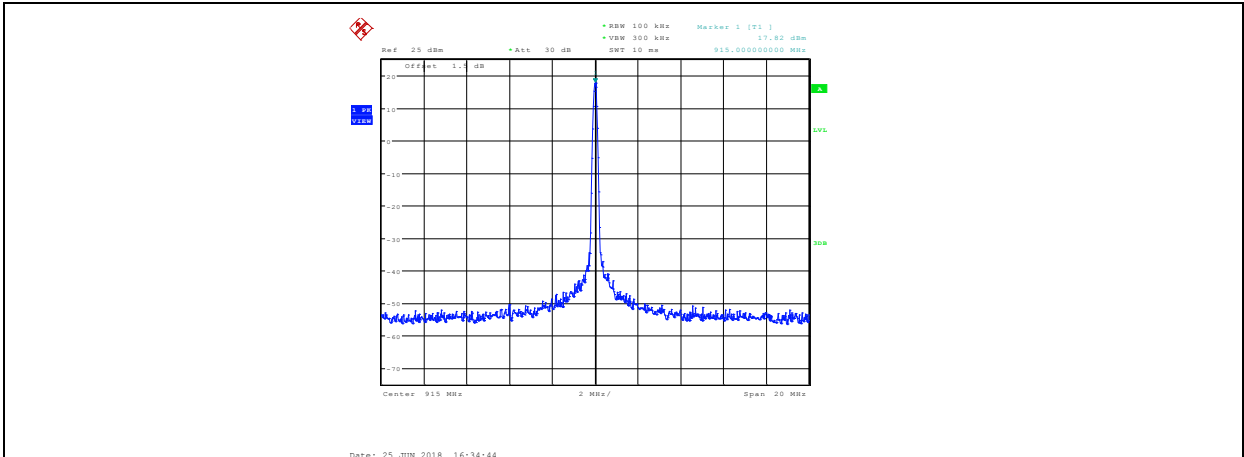

GFSK_ANT1_915_30~1000

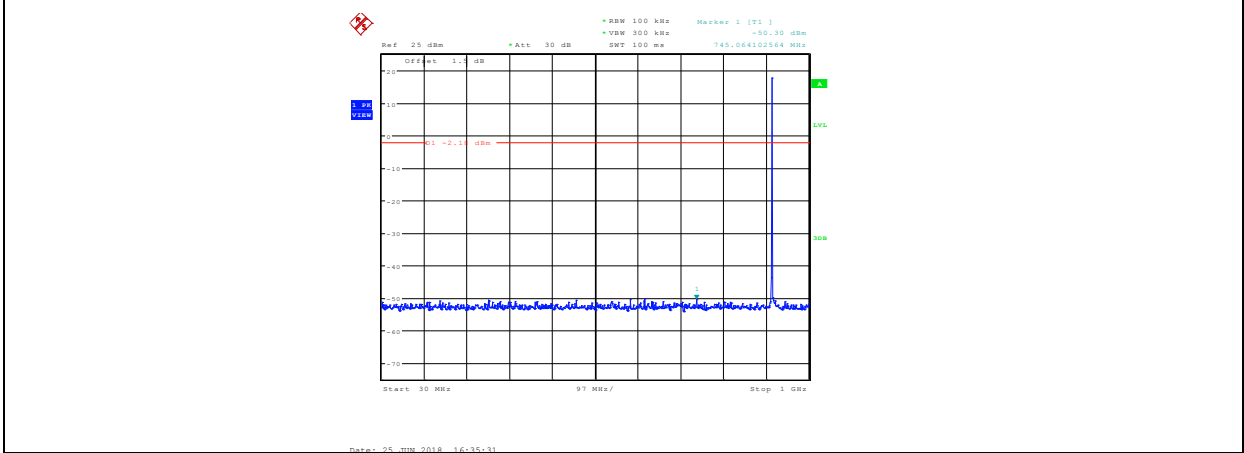

GFSK_ANT1_915_1000~12750

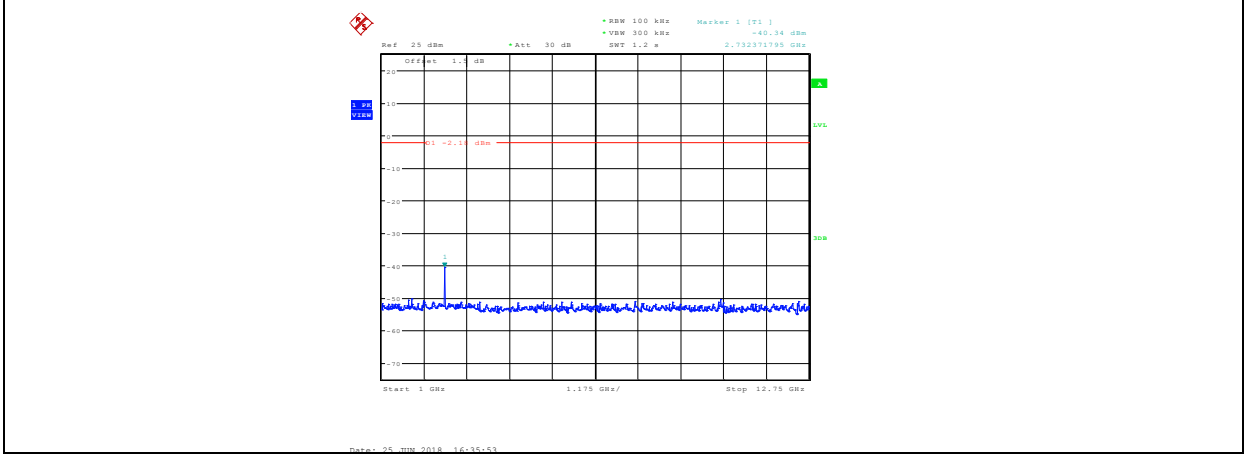

GFSK_ANT1_919.8_Ref

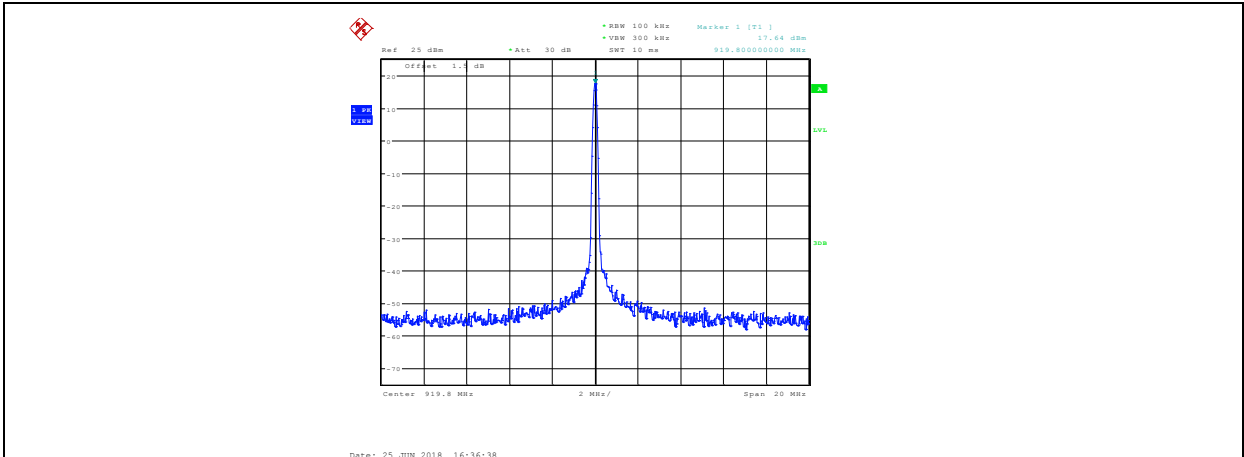

GFSK_ANT1_919.8_30~1000

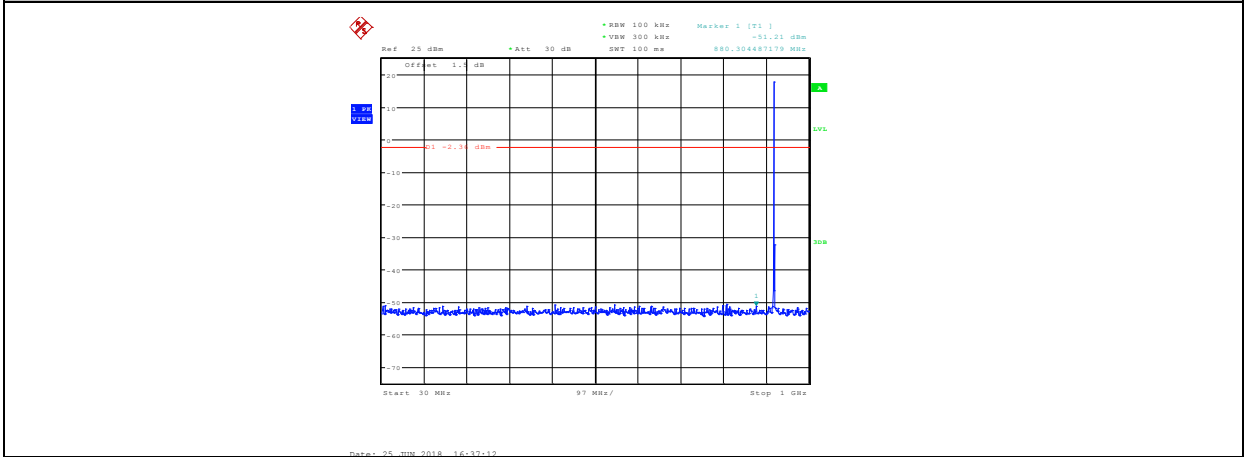

GFSK_ANT1_919.8_1000~12750

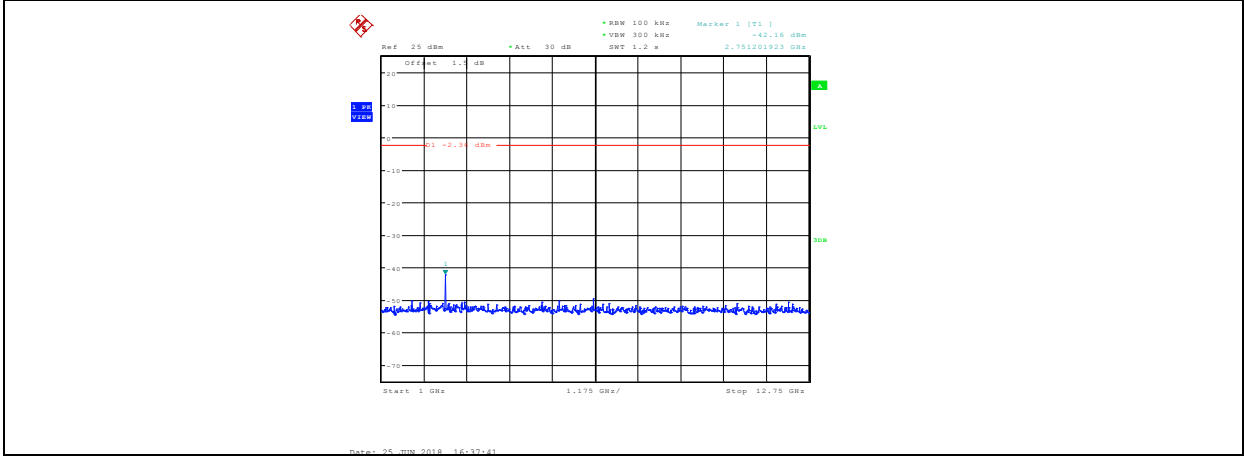

12. Band Edge Compliance (radiated method)

12.1. Block diagram of test setup

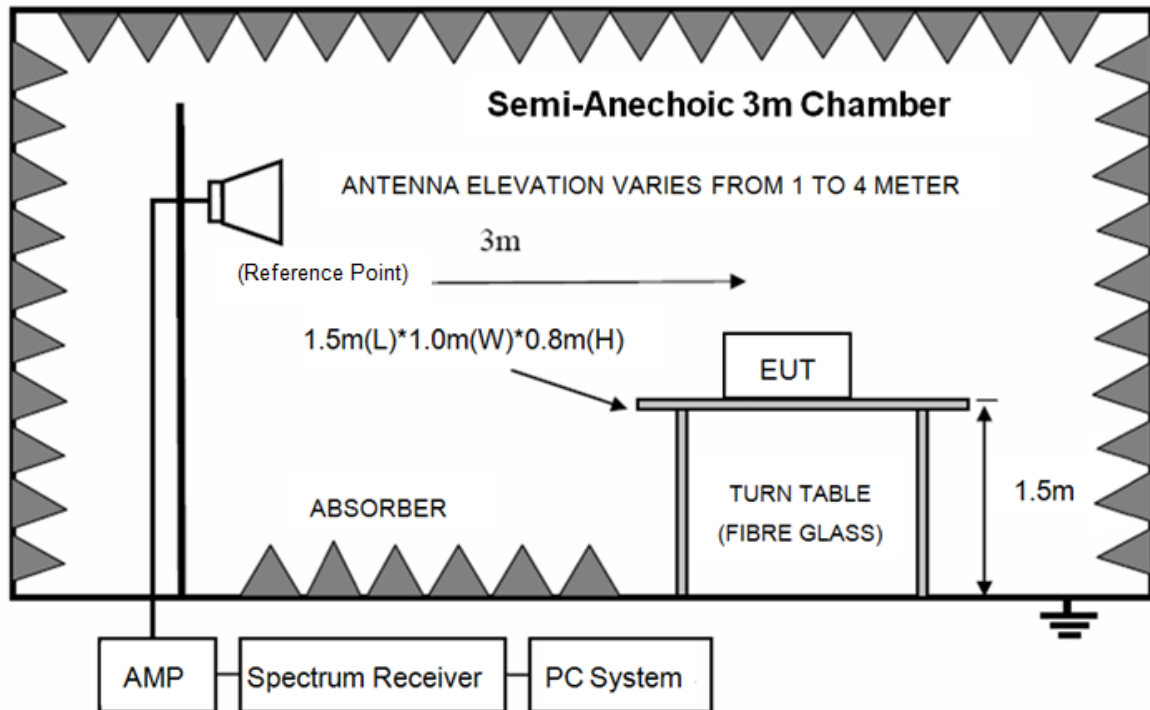

12.2. Limit

All restriction band should comply with 15.209, other emission should be at least 20dB below the fundamental.

12.3. Test Procedure

Same with clause 10.3 except change investigated frequency range.

Remark: All restriction band have been tested, and only the worst case is shown in report.

12.4. Test result

PASS. (See below detailed test result)

Remark: hopping on and hopping off mode all have been test, hopping off mode is worst and reported only.

Note: 50kbps data and 4.8kbps data rate all have been tested, worse case is reported

TR-4-E-009 Radiated Emission Test Result

| | | |
|---------------------|---------------------------------------------|-----------------------------------------------------------|
| Test Site | : DDT 3m Chamber 1# | D:\2018 RE1# Report Data\Q18050304-1E GW2\FCC BELOW1G.EM6 |
| Test Date | : 2018-06-12 | Tested By : Talent |
| EUT | : Cares Gateway2 | Model Number : GW2 |
| Power Supply | : DC 5V from AC Adapter | Test Mode : Tx mode |
| Condition | : Temp:24.5'C,Humi:55.5%, Press:100.1kPa | Antenna/Distance : 2017 VULB 9163 1#/3m/HORIZONTAL |
| Memo | : 910M | |

Data: 43

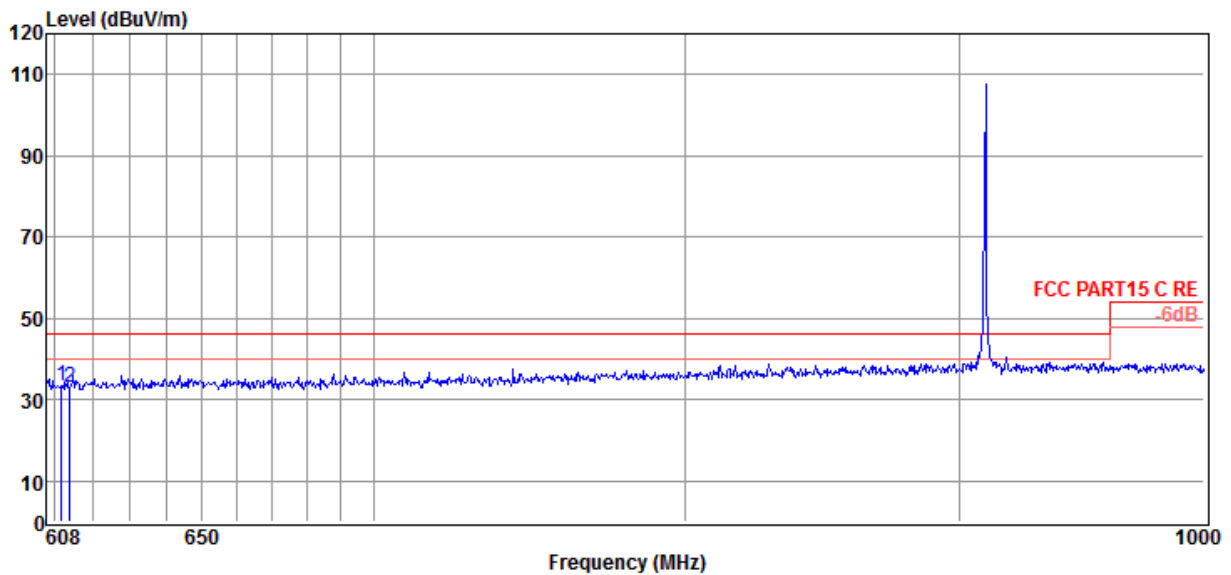

| Item (Mark) | Freq. (MHz) | Read Level (dBμV) | Antenna Factor (dB/m) | Cable Loss (dB) | Result Level (dBμV/m) | Limit Line (dBμV/m) | Over Limit (dB) | Detector | Polarization |
|-------------|-------------|-------------------|-----------------------|-----------------|-----------------------|---------------------|-----------------|----------|--------------|
| 1 | 611.95 | 7.34 | 19.44 | 6.71 | 33.49 | 46.00 | -12.51 | Peak | HORIZONTAL |
| 2 | 614.08 | 6.95 | 19.45 | 6.72 | 33.12 | 46.00 | -12.88 | Peak | HORIZONTAL |

- Note: 1. Result Level = Read Level + Antenna Factor + Cable loss.
 2. If Peak Result complies with QP limit, QP Result is deemed to comply with QP limit.
 3. Test setup: RBW: 120 kHz, VBW: 300 kHz, Sweep time: auto.

TR-4-E-009 Radiated Emission Test Result

| | | |
|---------------------|---------------------------------------------|-----------------------------------------------------------|
| Test Site | : DDT 3m Chamber 1# | D:\2018 RE1# Report Data\Q18050304-1E GW2\FCC BELOW1G.EM6 |
| Test Date | : 2018-06-12 | Tested By : Talent |
| EUT | : Cares Gateway2 | Model Number : GW2 |
| Power Supply | : DC 5V from AC Adapter | Test Mode : Tx mode |
| Condition | : Temp:24.5'C,Humi:55.5%, Press:100.1kPa | Antenna/Distance : 2017 VULB 9163 1#/3m/VERTICAL |
| Memo | : 910M | |

Data: 44

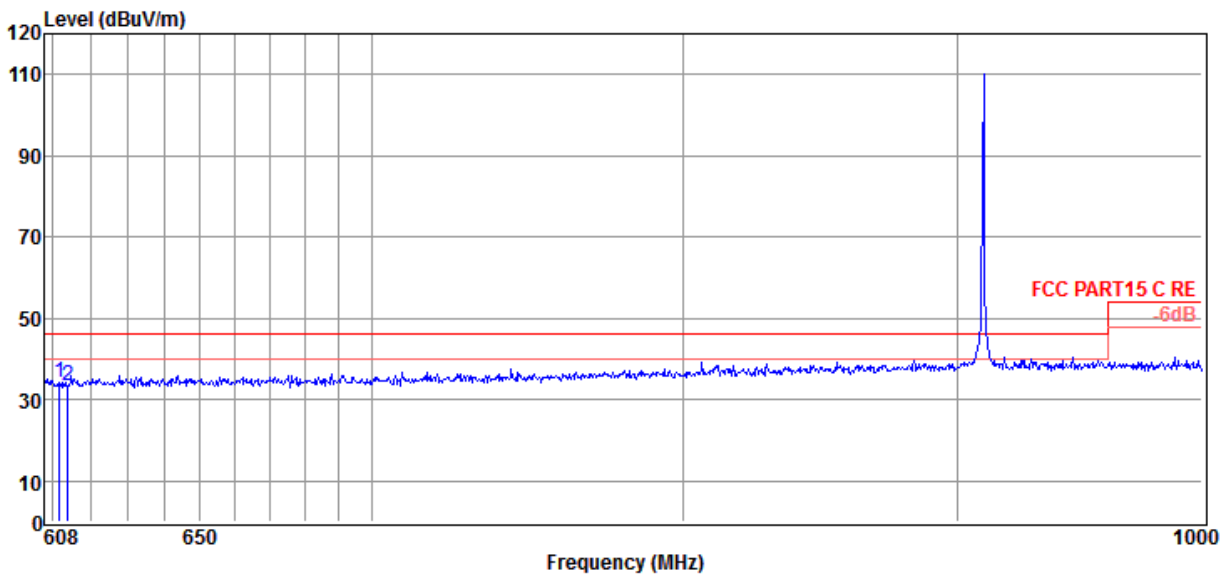

| Item (Mark) | Freq. (MHz) | Read Level (dBμV) | Antenna Factor (dB/m) | Cable Loss (dB) | Result Level (dBμV/m) | Limit Line (dBμV/m) | Over Limit (dB) | Detector | Polarization |
|-------------|-------------|-------------------|-----------------------|-----------------|-----------------------|---------------------|-----------------|----------|--------------|
| 1 | 611.95 | 8.14 | 19.44 | 6.71 | 34.29 | 46.00 | -11.71 | Peak | VERTICAL |
| 2 | 614.08 | 7.03 | 19.45 | 6.72 | 33.20 | 46.00 | -12.80 | Peak | VERTICAL |

- Note: 1. Result Level = Read Level + Antenna Factor + Cable loss.
 2. If Peak Result complies with QP limit, QP Result is deemed to comply with QP limit.
 3. Test setup: RBW: 120 kHz, VBW: 300 kHz, Sweep time: auto.

TR-4-E-009 Radiated Emission Test Result

Test Site : DDT 3m Chamber 1#
Test Date : 2018-06-12
EUT : Cares Gateway2
Power Supply : DC 5V from AC Adapter
Condition : Temp:24.5'C,Humi:55.5%, Press:100.1kPa
Memo : 918.2M

D:\2018 RE1# Report Data\Q18050304-1E GW2\FCC BELOW1G.EM6
Tested By : Talent
Model Number : GW2
Test Mode : Tx mode
Antenna/Distance : 2017 VULB 9163 1#/3m/VERTICAL

Data: 41

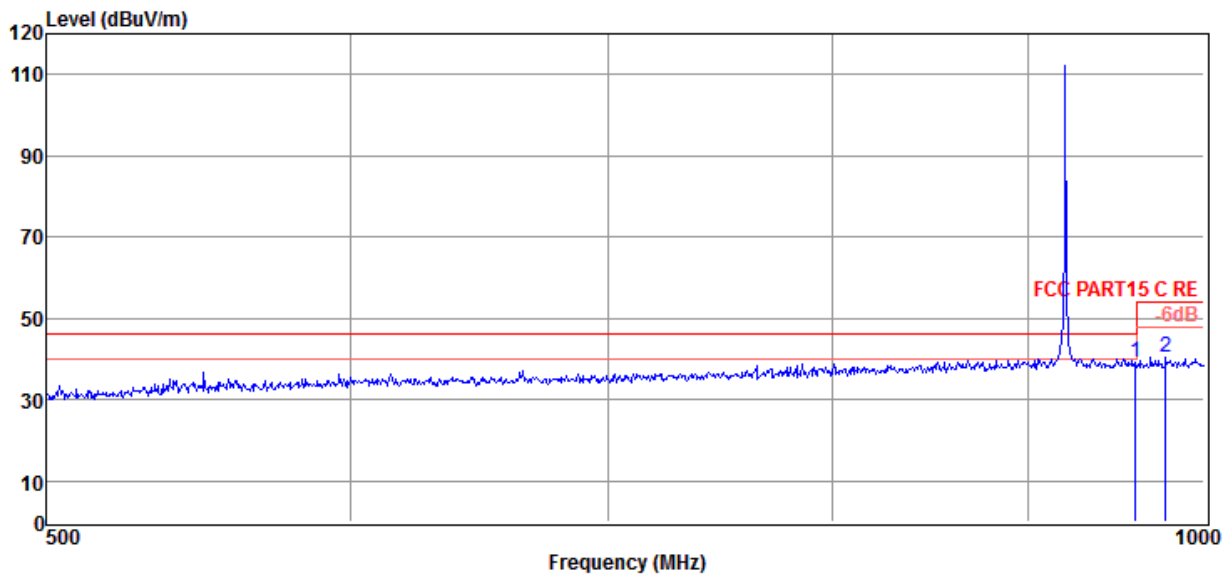

| Item (Mark) | Freq. (MHz) | Read Level (dBμV) | Antenna Factor (dB/m) | Cable Loss (dB) | Result Level (dBμV/m) | Limit Line (dBμV/m) | Over Limit (dB) | Detector | Polarization |
|-------------|-------------|-------------------|-----------------------|-----------------|-----------------------|---------------------|-----------------|----------|--------------|
| 1 | 959.93 | 9.07 | 22.48 | 7.77 | 39.32 | 46.00 | -6.68 | Peak | VERTICAL |
| 2 | 977.39 | 10.01 | 22.44 | 7.82 | 40.27 | 54.00 | -13.73 | Peak | VERTICAL |

- Note: 1. Result Level = Read Level + Antenna Factor + Cable loss.
 2. If Peak Result complies with QP limit, QP Result is deemed to comply with QP limit.
 3. Test setup: RBW: 120 kHz, VBW: 300 kHz, Sweep time: auto.

TR-4-E-009 Radiated Emission Test Result

Test Site : DDT 3m Chamber 1# D:\2018 RE1# Report Data\Q18050304-1E GW2\FCC BELOW1G.EM6
Test Date : 2018-06-12 **Tested By** : Talent
EUT : Cares Gateway2 **Model Number** : GW2
Power Supply : DC 5V from AC Adapter **Test Mode** : Tx mode
Condition : Temp:24.5'C,Humi:55.5%,
 Press:100.1kPa **Antenna/Distance** : 2017 VULB 9163 1#/3m/HORIZONTAL
Memo : 918.2M

Data: 42

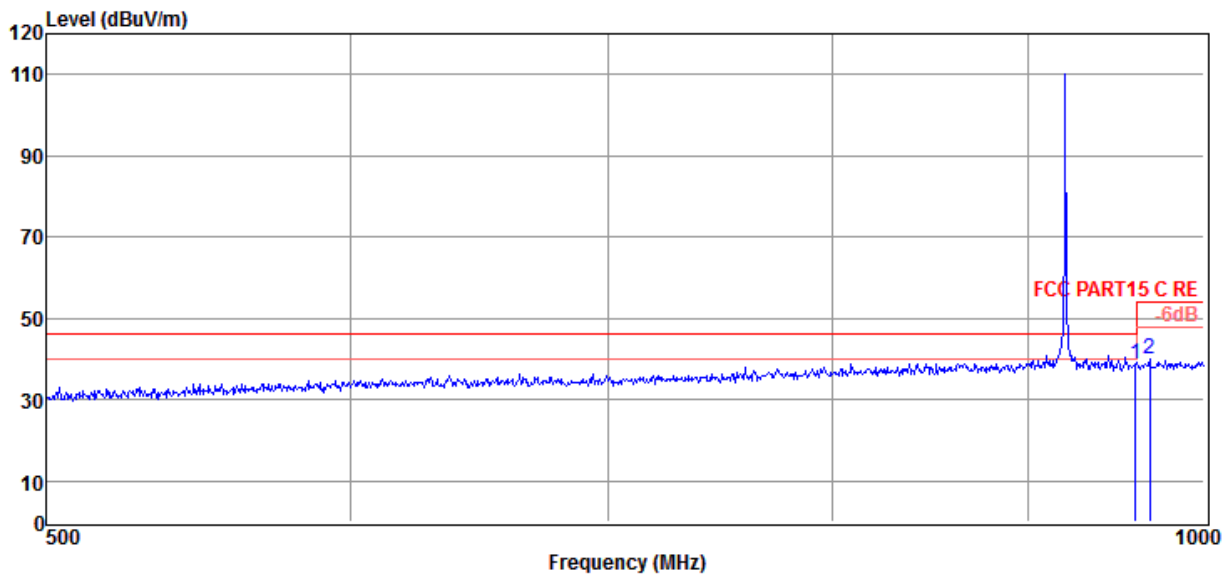

| Item (Mark) | Freq. (MHz) | Read Level (dBμV) | Antenna Factor (dB/m) | Cable Loss (dB) | Result Level (dBμV/m) | Limit Line (dBμV/m) | Over Limit (dB) | Detector | Polarization |
|-------------|-------------|-------------------|-----------------------|-----------------|-----------------------|---------------------|-----------------|----------|--------------|
| 1 | 959.93 | 8.51 | 22.48 | 7.77 | 38.76 | 46.00 | -7.24 | Peak | HORIZONTAL |
| 2 | 967.95 | 9.56 | 22.46 | 7.79 | 39.81 | 54.00 | -14.19 | Peak | HORIZONTAL |

- Note: 1. Result Level = Read Level + Antenna Factor + Cable loss.
 2. If Peak Result complies with QP limit, QP Result is deemed to comply with QP limit.
 3. Test setup: RBW: 120 kHz, VBW: 300 kHz, Sweep time: auto.

13. Power Line Conducted Emission

13.1. Block diagram of test setup

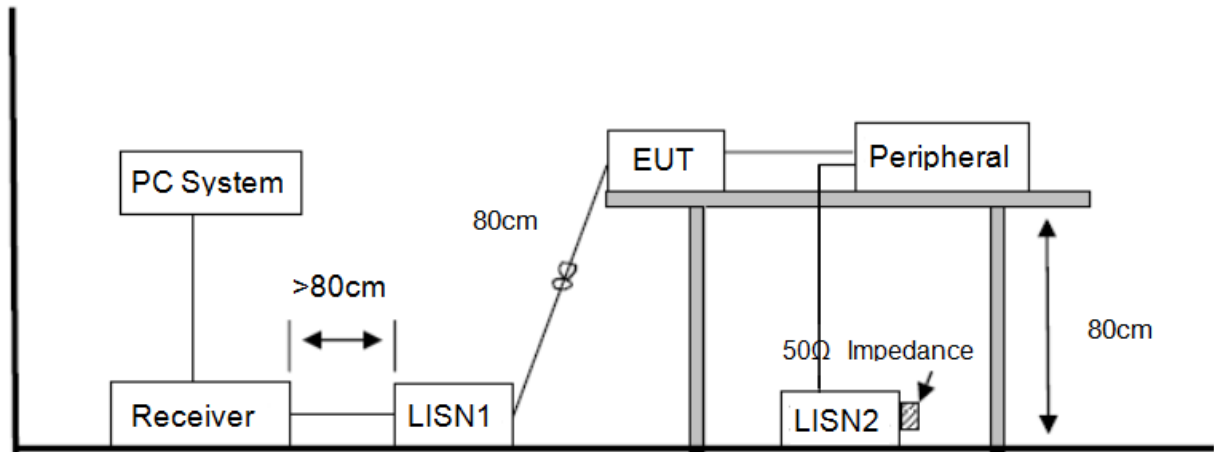

13.2. Power Line Conducted Emission Limits

| Frequency | Quasi-Peak Level dB(μ V) | Average Level dB(μ V) |
|-----------------|----------------------------------|-------------------------------|
| 150kHz ~ 500kHz | 66 ~ 56* | 56 ~ 46* |
| 500kHz ~ 5MHz | 56 | 46 |
| 5MHz ~ 30MHz | 60 | 50 |

Note 1: * Decreasing linearly with logarithm of frequency.

Note 2: The lower limit shall apply at the transition frequencies.

13.3. Test Procedure

The EUT and Support equipment, if needed, were put placed on a non-metallic table, 80cm above the ground plane.

Configuration EUT to simulate typical usage as described in clause 2.4 and test equipment as described in clause 10.2 of this report.

All I/O cables were positioned to simulate typical actual usage as per ANSI C63.10.

All support equipment power received from a second LISN.

Emissions were measured on each current carrying line of the EUT using an EMI Test Receiver connected to the LISN powering the EUT.

The Receiver scanned from 150 kHz to 30MHz for emissions in each of the test modes.

During the above scans, the emissions were maximized by cable manipulation.

The test mode(s) described in clause 2.4 were scanned during the preliminary test.

After the preliminary scan, we found the test mode producing the highest emission level.

The EUT configuration and worse cable configuration of the above highest emission levels were recorded for reference of the final test.

EUT and support equipment were set up on the test bench as per the configuration with highest emission level in the preliminary test.

A scan was taken on both power lines, Neutral and Line, recording at least the six highest emissions.

Emission frequency and amplitude were recorded into a computer in which correction factors were used to calculate the emission level and compare reading to the applicable limit.

The test data of the worst-case condition(s) was recorded.

The bandwidth of test receiver is set at 9 kHz.

13.4. Test Result

PASS. (See below detailed test result)

Note1: All emissions not reported below are too low against the prescribed limits.

Note2: "----" means peak detection; "-----" means average detection

Note3: Pre-test AC conducted emission at both voltage AC 120V/60Hz and AC 240V/50Hz, recorded worst case.

TR-4-E-010 Conducted Emission Test Result

Test Site : DDT 1# Shield Room
Test Date : 2018-06-06
EUT : Ceres Gateway 2
Power Supply : AC 120V/60Hz
Condition : Temp:24.5°C,Humi:55.5%,
 Press:100.1kPa
Memo : 1#

D:\2018 CE report data\Q18050304-1E
 GW2\Q18050304-1E-P15C.EM6
Tested By : Michael
Model Number : GW2
Test Mode : Tx mode
LISN : 2017 ENV216/NEUTRAL

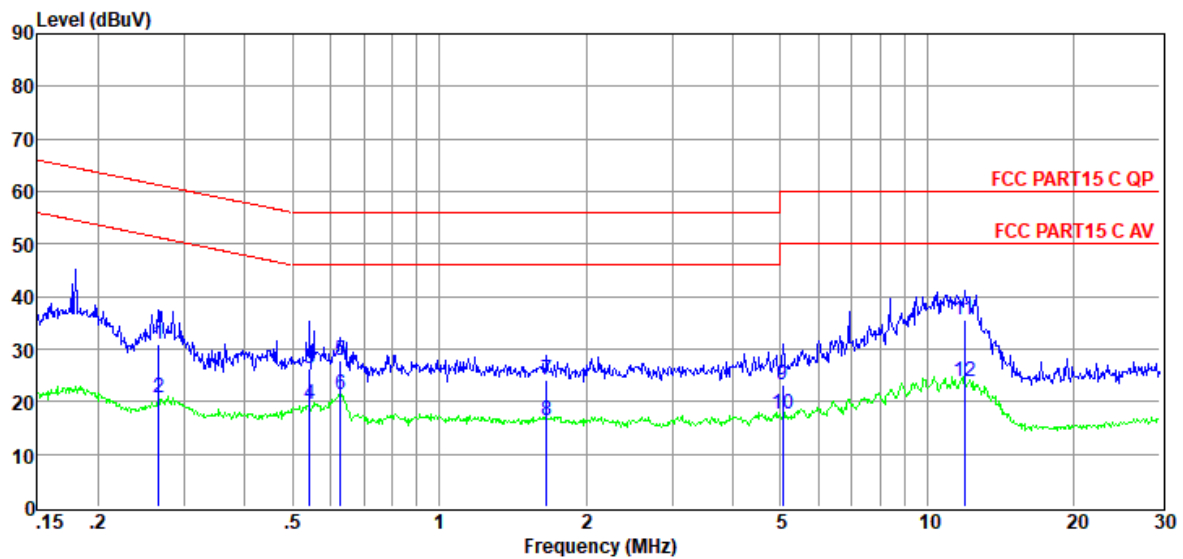

| Item (Mark) | Freq. (MHz) | Read Level (dB μ V) | LISN Factor (dB) | Cable Loss (dB) | Pulse Limiter Factor (dB) | Result Level (dB μ V) | Limit Line (dB μ V) | Over Limit (dB) | Detector | Phase |
|----------------|----------------|-------------------------------|------------------------|-----------------------|------------------------------------|---------------------------------|-------------------------------|-----------------------|----------|---------|
| 1 | 0.27 | 11.48 | 9.41 | 0.04 | 9.86 | 30.79 | 61.25 | -30.46 | QP | NEUTRAL |
| 2 | 0.27 | 1.47 | 9.41 | 0.04 | 9.86 | 20.78 | 51.25 | -30.47 | Average | NEUTRAL |
| 3 | 0.54 | 7.14 | 9.34 | 0.05 | 9.81 | 26.34 | 56.00 | -29.66 | QP | NEUTRAL |
| 4 | 0.54 | 0.18 | 9.34 | 0.05 | 9.81 | 19.38 | 46.00 | -26.62 | Average | NEUTRAL |
| 5 | 0.63 | 8.53 | 9.33 | 0.07 | 9.84 | 27.77 | 56.00 | -28.23 | QP | NEUTRAL |
| 6 | 0.63 | 2.17 | 9.33 | 0.07 | 9.84 | 21.41 | 46.00 | -24.59 | Average | NEUTRAL |
| 7 | 1.66 | 4.84 | 9.28 | 0.13 | 9.86 | 24.11 | 56.00 | -31.89 | QP | NEUTRAL |
| 8 | 1.66 | -2.74 | 9.28 | 0.13 | 9.86 | 16.53 | 46.00 | -29.47 | Average | NEUTRAL |
| 9 | 5.06 | 4.08 | 9.28 | 0.10 | 9.87 | 23.33 | 60.00 | -36.67 | QP | NEUTRAL |
| 10 | 5.06 | -1.70 | 9.28 | 0.10 | 9.87 | 17.55 | 50.00 | -32.45 | Average | NEUTRAL |
| 11 | 11.93 | 15.97 | 9.44 | 0.12 | 9.90 | 35.43 | 60.00 | -24.57 | QP | NEUTRAL |
| 12 | 11.93 | 4.36 | 9.44 | 0.12 | 9.90 | 23.82 | 50.00 | -26.18 | Average | NEUTRAL |

Note: 1. Result Level = Read Level + LISN Factor + Pulse Limiter Factor + Cable loss.

2. If QP Result complies with AV limit, AV Result is deemed to comply with AV limit.

3. Test setup: RBW: 200 Hz (9 kHz—150 kHz), 9 kHz (150 kHz—30 MHz).

4. Step size: 80Hz (0.009MHz-0.15MHz), 4 kHz (0.15MHz-30MHz), Scan time: auto.

TR-4-E-010 Conducted Emission Test Result

| | | |
|---------------------|---------------------------------------------|------------------------------------------------------------------|
| Test Site | : DDT 1# Shield Room | D:\2018 CE report data\Q18050304-1E GW2\Q18050304-1E-P15C.EM6 |
| Test Date | : 2018-06-06 | Tested By : Michael |
| EUT | : Ceres Gateway 2 | Model Number : GW2 |
| Power Supply | : AC 120V/60Hz | Test Mode : Tx mode |
| Condition | : Temp:24.5°C,Humi:55.5%, Press:100.1kPa | LISN : 2017 ENV216/LINE |
| Memo | : 1# | |

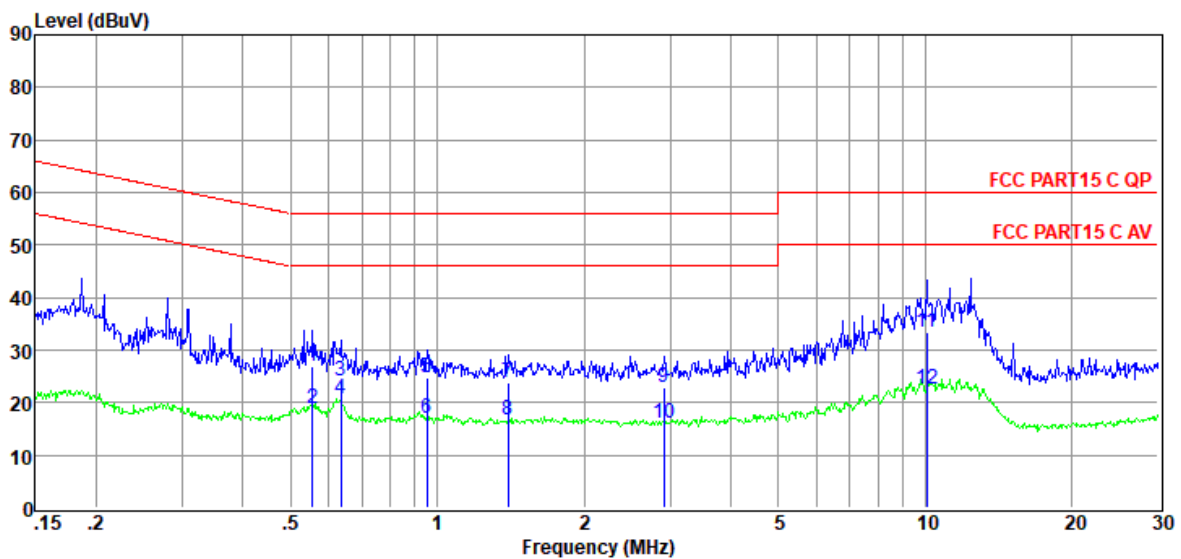

| Item (Mark) | Freq. (MHz) | Read Level (dB μ V) | LISN Factor (dB) | Cable Loss (dB) | Pulse Limiter Factor (dB) | Result Level (dB μ V) | Limit Line (dB μ V) | Over Limit (dB) | Detector | Phase |
|----------------|----------------|-------------------------------|------------------------|-----------------------|------------------------------------|---------------------------------|-------------------------------|-----------------------|----------|-------|
| 1 | 0.56 | 7.57 | 9.55 | 0.06 | 9.82 | 27.00 | 56.00 | -29.00 | QP | LINE |
| 2 | 0.56 | -0.42 | 9.55 | 0.06 | 9.82 | 19.01 | 46.00 | -26.99 | Average | LINE |
| 3 | 0.63 | 4.68 | 9.55 | 0.07 | 9.84 | 24.14 | 56.00 | -31.86 | QP | LINE |
| 4 | 0.63 | 1.20 | 9.55 | 0.07 | 9.84 | 20.66 | 46.00 | -25.34 | Average | LINE |
| 5 | 0.95 | 5.04 | 9.57 | 0.13 | 9.86 | 24.60 | 56.00 | -31.40 | QP | LINE |
| 6 | 0.95 | -2.55 | 9.57 | 0.13 | 9.86 | 17.01 | 46.00 | -28.99 | Average | LINE |
| 7 | 1.40 | 4.30 | 9.58 | 0.13 | 9.86 | 23.87 | 56.00 | -32.13 | QP | LINE |
| 8 | 1.40 | -3.00 | 9.58 | 0.13 | 9.86 | 16.57 | 46.00 | -29.43 | Average | LINE |
| 9 | 2.92 | 3.32 | 9.62 | 0.11 | 9.87 | 22.92 | 56.00 | -33.08 | QP | LINE |
| 10 | 2.92 | -3.61 | 9.62 | 0.11 | 9.87 | 15.99 | 46.00 | -30.01 | Average | LINE |
| 11 | 10.07 | 13.55 | 9.82 | 0.12 | 9.89 | 33.38 | 60.00 | -26.62 | QP | LINE |
| 12 | 10.07 | 2.87 | 9.82 | 0.12 | 9.89 | 22.70 | 50.00 | -27.30 | Average | LINE |

Note: 1. Result Level = Read Level + LISN Factor + Pulse Limiter Factor + Cable loss.

2. If QP Result complies with AV limit, AV Result is deemed to comply with AV limit.

3. Test setup: RBW: 200 Hz (9 kHz—150 kHz), 9 kHz (150 kHz—30 MHz).

4. Step size: 80Hz (0.009MHz-0.15MHz), 4 kHz (0.15MHz-30MHz), Scan time: auto.

14. Antenna Requirements

14.1. Limit

For intentional device, according to FCC 47 CFR Section 15.203, an intentional radiator shall be designed to ensure that no antenna other than that furnished by the responsible party shall be used with the device. And according to FCC 47 CFR Section 15.247 (b), if transmitting antennas of directional gain greater than 6dBi are used, the power shall be reduced by the amount in dB that the directional gain of the antenna exceeds 6dBi.

14.2. Result

The antennas used for this product are integrated antenna and that no antenna other than that furnished by the responsible party shall be used with the device, the maximum peak gain of the transmit antenna is only 1.2dBi.

END OF REPORT