

# PA-MR04LN

## Instruction Manual

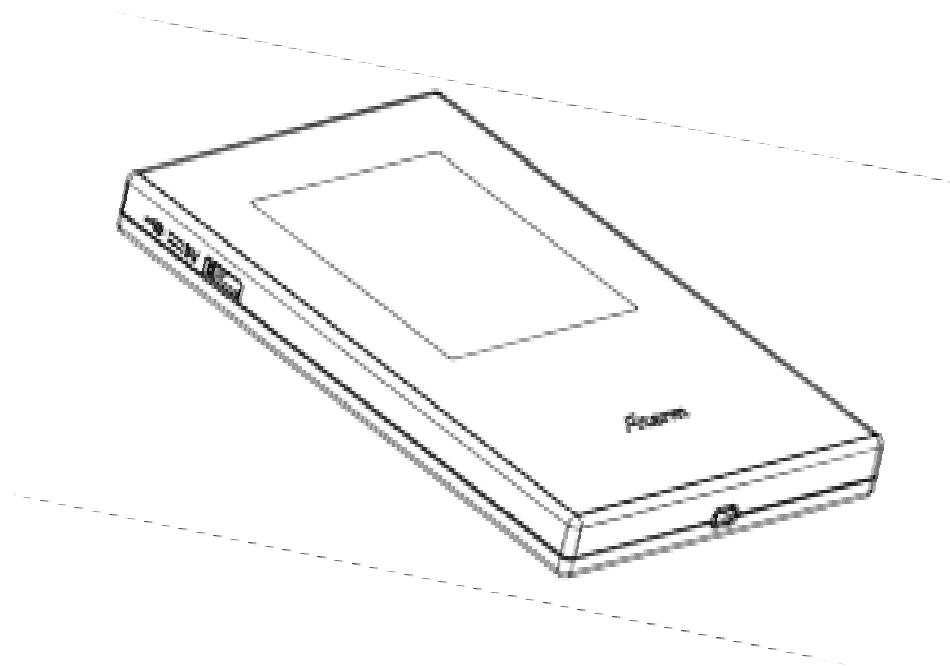

# Contents

|  |    |
|--|----|
| Contents.....  | 2  |
| Important Product Information .....                        | 3  |
| Safety Instructions .....                                  | 4  |
| Notice.....  | 8  |
| 1. Package Contents.....                                   | 11 |
| 2. Part Names and Functions.....                           | 12 |
| 3. Using microSIM.....                                     | 14 |
| 4. Attaching, Detaching and Charging the Battery Pack..... | 15 |
| 5. Network Setup.....                                      | 16 |
| 6. Web Setting.....  | 17 |
| 7. Products Specifications.....                            | 19 |

Windows® and Windows 7® are registered trademarks of Microsoft Corporation in the United States and other countries.  
Windows 7® is an operating system.

Copyright© NEC Platforms, Ltd. 2015

# Important Product Information

## Important safety information regarding radio frequency (RF) exposure and use when worn

The product "MR04LN" is declared to conform with the essential requirements of European Union Directive 1999/5/EC Radio and Telecommunications Terminal Equipment Directive 3.1(a), 3.1(b) and 3.2.

This wireless portable device complies with the EU requirements for exposure to radio waves.

Your wireless portable device is a radio transceiver and receiver. It is designed not to exceed the SAR\* (Specific Absorption Rate) limits\*\* for exposure to radiofrequency (RF) energy by European Union Directives.

The Max. SAR\* value is 1.04W/kg (10 g) when it is worn on the body. To comply with the RF Exposure limits

For body-worn operating conditions please use belt-clips, holsters, and/or accessories that have no metallic component in the assembly and must provide at least 1cm separation between the device and the user's body.

\* The exposure standard for wireless portable devices employs a unit of measurement known as the Specific Absorption Rate, or SAR.

\*\* The SAR limit recommended by the International Commission on Non-Ionizing Radiation Protection (ICNIRP) is 2W/kg averaged over 10g of tissue.

\*\*\* Tests for SAR have been conducted using standard operating positions with the transmitting at its highest certified power level in all tested frequency bands. Although the SAR is determined at the highest certified power level, the actual SAR level of the wireless portable device while operating can be well below the maximum value. This is because the wireless portable device is designed to operate at multiple power levels so as to use only the power required to reach the network. In general, the closer you are to a base station antenna, the lower the power output.

R&TTE Directive



**CE 0560**

We, NEC Platforms, Ltd. hereby, declare that the residential gateway model PA-MR04LN is in compliance with the essential requirements and other relevant provisions of Directive 1999/5/EC.

# Safety Instructions

Please read these Safety Instructions carefully before using this product. These Safety Instructions show items that must be followed to prevent danger to any person and damage to property. Alert symbols below are important to fully understand these Safety Instructions.

## Alert symbols in this instruction manual



**Warning** : Indicates a hazardous situation which could result in death or serious injury.



**Caution** : Indicates a situation which could result in minor injury or physical damage.

### Other alert symbols

#### ■ Warnings and cautions



Flammable



Electric shock



High Temperature

#### ■ Prohibited actions



General



No disassembly



No water



No wet hands



No naked flames



**Warning**

## Battery

- Do not get any metal objects such as wire come into contact with the battery terminal.

Do not carry or store the terminal together with any metal objects such as a necklace.

Ignition, explosion, overheating or leakage of the battery pack may result.



**Warning**

- Do not attach the battery pack forcibly if you are having trouble attaching it. When attaching the battery pack, check the direction of the battery pack. Ignition, explosion, overheating or leakage of the battery pack may result.
- Do not throw the battery pack into fire. Ignition, explosion, overheating or leakage of the battery pack may result.
- Do not pierce the battery pack with a nail, hit it with a hammer or step on it. Ignition, explosion, overheating or leakage of the battery pack may result.
- If the battery fluid gets into your eyes, immediately flush with clean water and consult a doctor. Do not rub the eyes. Otherwise, blindness may result.
- If you find any trouble on the battery pack such as distortion caused by a drop or scratches, never use the battery pack. Ignition, explosion, overheating or leakage of the battery pack may result.
- If the battery leaks or emits unusual odor, immediately stop using the terminal and keep away from the open fire. Otherwise, the leaked battery fluid may ignite, resulting in fire or burst.
- Be careful not to let your pets bite the battery pack. Otherwise, Ignition, explosion, overheating or leakage of the battery pack may result.



## Caution

CAUTION : RISK OF EXPLOSION IF BATTERY IS REPLACED BY AN INCORRECT TYPE. DISPOSE OF USED BATTERIES ACCORDING TO THE INSTRUCTIONS



## Warning

## In these cases

- Do not dispose of old batteries with ordinary household waste.

Ignition or environmental damage may result.

Cover the battery terminals with a non-conductive tape and dispose of them in accordance with local waste disposal regulations.



- Do not use or charge a wet battery pack.

Ignition, explosion, overheating or leakage of the battery pack may result.



- If the liquid inside the battery pack leaks out, keep the liquid away from your skin such as face or hands.

Otherwise, blindness or injury to your skin may result.

If the liquid gets into your eyes or mouth, or attaches to your skin or clothing, flush with clean water immediately.

If the liquid gets into your eyes or mouth, immediately flush with water and then consult a doctor.





## Warning

### Other warnings

- Turn off this product in any place where use of a wireless device is prohibited, for example in an airplane or hospital. Otherwise, it may influence electronics and medical devices, and cause an incident.
- Do not place or use this product near high-precision electronics or devices which handle weak signals, for example pacemakers. Otherwise, electronics such as pacemakers may malfunction. Do not use this product near medical electronics, or in any place where you are prohibited from using this product, for example in a hospital.
- Do not place this product near vases, pots, cups, cosmetics, vessels with chemicals or water, or near any small metal objects (staples etc.) which could fall through the ventilation slots. If this product gets wet or a short circuit occurs, it may cause a fire, electric shock or malfunction.
- Do not place or use this product in a humid location such as a bathroom and humidifier. Otherwise, a fire, electric shock or malfunction may occur.



# Notice

Indicates a situation which could result in this product performing poorly or malfunctioning.

## **What you must not do**

- Do not drop or hit this product. Otherwise, it may malfunction.
- Do not leave this product in a cold place such as an ice warehouse. Otherwise, this product may operate abnormally.
- Disconnect all cords before moving this product. Otherwise, it may malfunction.
- This product may operate abnormally if the connecting cords are disconnected when it is on, or if the connection is unstable. When this product is on, do not touch the connecting parts.
- Do not turn on this product immediately after you turn it off. Wait at least 10 seconds to restart. It may not turn on if you attempt to turn it back on immediately.



## **Other warnings**

- If you turn off or disconnect this product during data communication, communication may fail or data may be damaged. If your data are important, check them against the original.

## **Notes on wireless LAN**

- The standard values of wireless LAN are the maximum theoretical values when communication is carried out with other products with the same configuration as this product. The standard values may not indicate the actual data transfer rate.
- The interconnectivity of this product with other products is not guaranteed.
- Wireless LAN transmission distance and transmission speed varies greatly depending on objects in the surrounding environment such as walls and furniture.

## **Security notes on wireless LAN products**

Wireless LAN has the advantage of a LAN connection without the use of LAN cables if the device is placed within the reach of radio waves. You can send and receive information between devices that use radio waves such as a computer and the wireless LAN access point (base unit). On the other hand, you may encounter the following problems if you do not complete the settings related to security because the radio waves reach beyond all obstacles such as walls if within a certain range.

- Interception of information: Some malicious computer users may intercept radio waves intentionally to discover your IDs, passwords, credit card numbers, e-mails, etc.
- Unauthorized intrusion: Some malicious computer users may access personal or office networks to gain personal or confidential information and send out false data. Also, they may intercept communication content, rewrite it, and then send it out. Furthermore, they may send out computer viruses to destroy data and systems.

Wireless LAN products already have security systems so there is a low probability that any of the above problems will occur if you use the product with these settings.

You should be fully aware of problems which may happen to you if you do not do your security configuration. We recommend that you use this product only after making the security setting you judge to be necessary based on a proper understanding of the problems which may occur if security settings are not configured.

We, NEC Platforms, Ltd., do not take responsibility for any damage caused by a security problem occurring because of a lack of a security measure or an unavoidable issue with the wireless LAN specifications.

In addition, we recommend changing the encryption key and PIN code of the wireless LAN access point (base unit) on a regular basis to ensure safe use of the wireless LAN.

# 1. Package Contents

This product package contains the following items.

□ PA-MR04LN Terminal

□ Battery Cover

□ Battery Pack

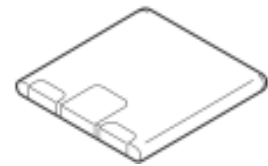
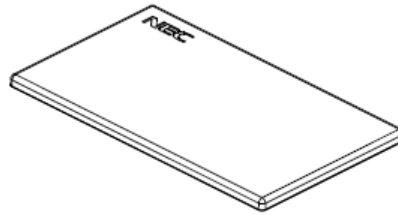
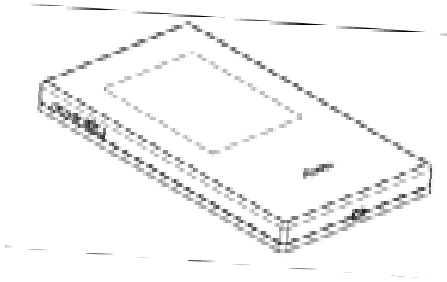

□ Instruction manual



# 2. Part Names and Functions

Right Side / Left side

<PA-MR04LN>

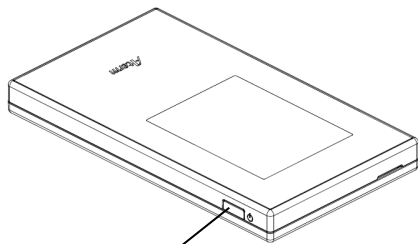

(1) Power button

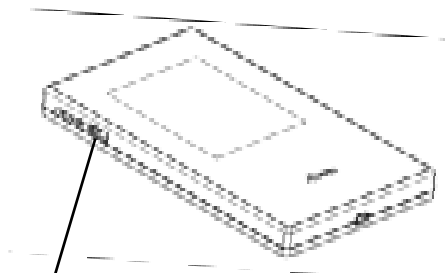

(2) USB port

## Indicators

| Name             | Display   | Description                     |
|------------------|---|---------------------------------|
| (1) Power button |  | Hold down the button to turn on |

## Port

| Name         | Display   | Description               |
|--------------|---|---------------------------|
| (2) USB port |  | microUSB Connection Cable |

## Product label

Look at the product label on the left side of this product to configure a wireless LAN terminal [client].

\* The label is an example.

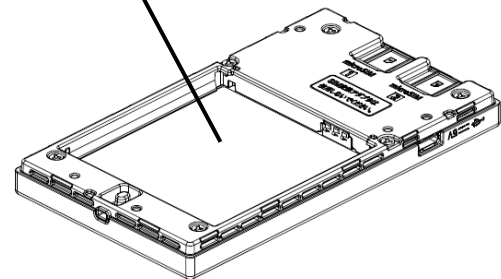
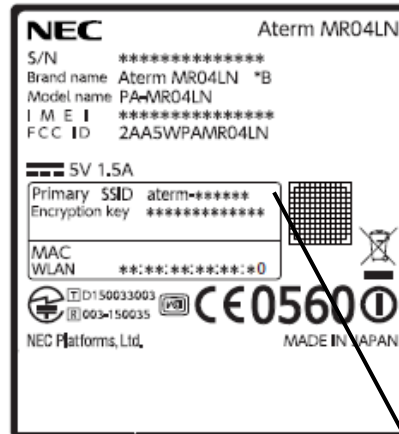

Network name (SSID) of initial state and coded key

# 3. Using microSIM

A microSIM is an IC Card that stores personal information such as your phone number. Without the microSIM installed in this terminal, you cannot use data communication. For details on handling the microSIM, refer to the microSIM manual.

When inseting and removing the microSIM, hold this terminal with both hands.

## Inseting the microSIM

- (1) With the IC chip side down, insert a microSIM under the microSIM1 slot in the direction of arrow.

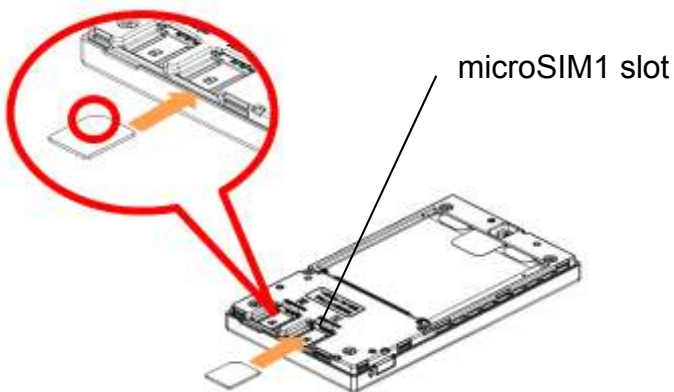

## Removing the microSIM

- (1) Slide the microSIM1 in the direction of arrow to remove.

# 4. Attaching, Detaching and Charging the Battery Pack

When attaching and detaching the battery pack, hold this terminal with both hands.

## Attaching the Battery Pack

- (1) With the “♻️” side of the battery pack up, align the metal contacts of both the Battery pack and terminal, attach the battery pack in the direction, and then Push it down in the direction.

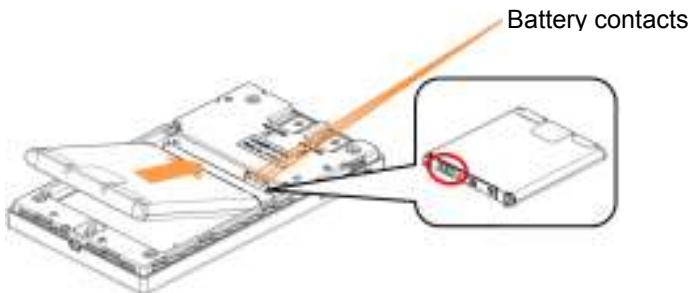

- (2) Check the direction of the Battery cover and attach it to the terminal.

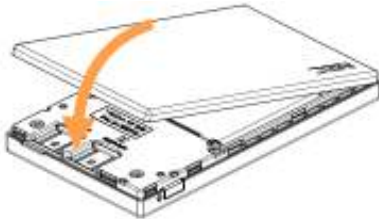

## Detaching the Battery Pack

- (1) Insert a fingernail into the groove at the bottom of this terminal, and pull up.
- (2) Hold the “PULL” tab of battery pack, and pull it up the direction of the arrow.

## Charging the Battery Pack

- (1) Connect to The USB port of this product and PC with an attached USB cable.

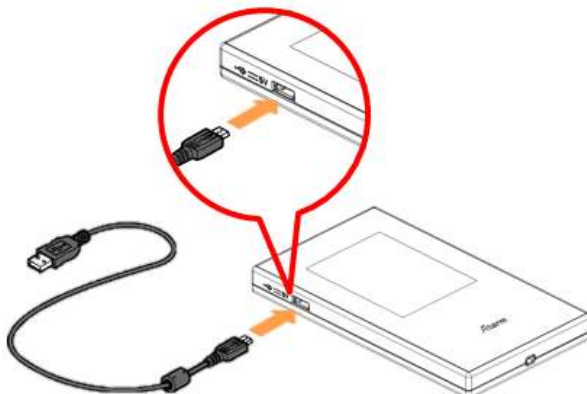

# 5. Network Setup

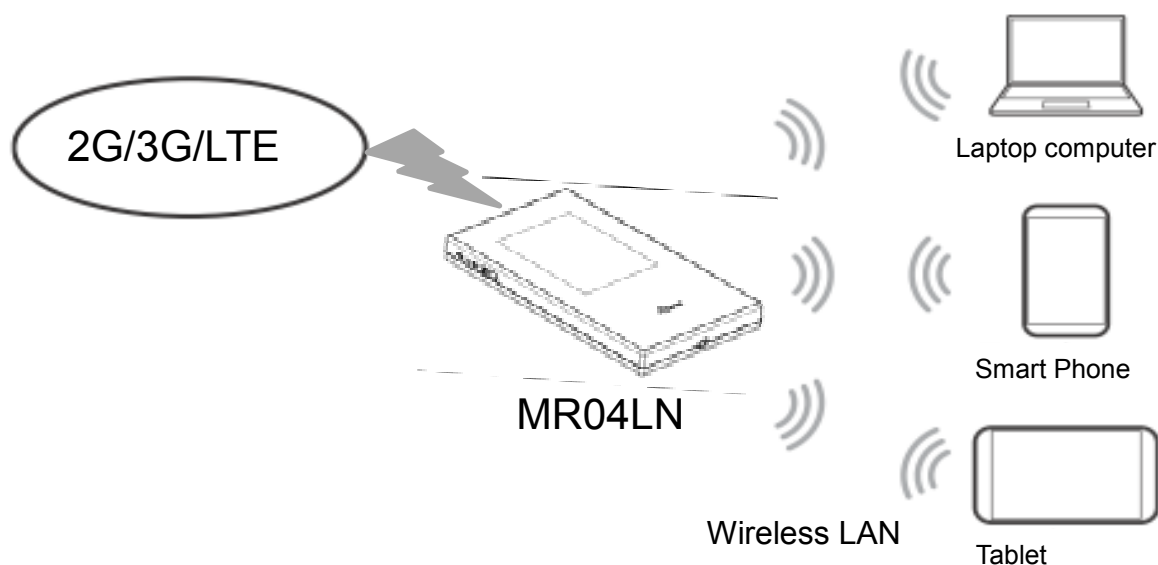

## Registering the Access Point Setting

- (1) In the top menu, click "基本設定"
- (2) In the submenu, click "接続先設定(LTE/3G)"
- (3) Click "高度な設定を表示"
- (4) Confirm "国際ローミング" settings area, and click "使用する"
- (5) Confirm pop-up message, and click "OK"
- (6) To register International roaming setting, click "設定"
- (7) Click "編集"
- (8) On the setting screen, set the required items.  
接続先名, 接続サービス, APN, ユーザー名, パスワード, 暗号化方式, 接続方式
- (9) To register a new access point, click "設定"

## Connecting to Windows PC

### For Windows7

- (1) Turn on the wireless LAN function of a PC.
- (2) Start ⇒ Click "コントロールパネル(Control panel)" ⇒ "ネットワークとインターネット(Network and Internet)" ⇒ "ネットワークと共有センター(Network and sharing center)"  
※ネットワークと共有センター(Network and sharing center) windows appears
- (3) Click "ネットワークに接続(Connect to a network)"
- (4) Click the item witch shows SSID set to this terminal, and click "接続(Connect)".  
※(Default:"aterm-:\*\*\*\*\*-g")
- (5) In "セキュリティキーまたはパスフレーズ(Security key or pass phrase)", enter Security key(AES shared key) set to this terminal and click "OK"



# 6. Web Setting

- (1) Start the PC and others.
- (2) Start a WWW browser, enter "http://192.168.179.1/" and open the page for Web configurations.
- (3) Enter the user name and password. The user name is "admin" and the password is "1234" (default value).



- (4) The "管理者パスワード変更" screen appears. Change the administrator's password as you like, and write it down in the "Administrator's password" box below.



Do not forget to write down your administrator's password. The password is essential to the configuration of this product. You need to use the password to open the configuration screen. If you forget the password, you will need to initialize this product. Note that all the configurations you have saved will be deleted during initialization.

|                          |  |
|--------------------------|--|
| Administrator's password |  |
|--------------------------|--|

(5) Select the menu you want to modify, and proceed.

Aterm MR04LN  
クイック設定Web

左メニューから設定項目を選択して、  
設定をスタートしましょう。

| 装置情報  |              |
|-------|--------------|
| 装置名   | ATERM-003303 |
| 動作モード | ルータモード       |
| 接続状態  | インターネット未接続   |
| 電波状態  | 圏外           |

最新状態に更新

Copyright (c) NEC Corporation 2001-2014  
Copyright (c) NEO Platforms, Ltd. 2001-2014

# 7. Products Specifications

| Item                 |                    | Condition                                      |                                  |
|----------------------|--------------------|--|----------------------------------|
| WAN                  | Antenna            | Antenna built in                               |                                  |
|                      | LTE_Band3          | Frequency                                      | UL:1710-1785MHz,DL:1805-1880MHz  |
|                      | LTE_Band17         | Frequency                                      | UL:704-716MHz,DL:734-746MHz      |
|                      | HSPA_Band1         | Frequency                                      | UL:1920-1980MHz,DL:2110-2170MHz  |
|                      | HSPA_Band5         | Frequency                                      | UL:824-849MHz,DL:869-894MHz      |
|                      | HSPA_Band8         | Frequency                                      | UL:880-915MHz,DL:925-960MHz      |
|                      | GSM850             | Frequency                                      | UL:824-849MHz, DL:869-894MHz     |
|                      | EGSM900            | Frequency                                      | UL:880-915MHz, DL:925-960MHz     |
|                      | DCS1800            | Frequency                                      | UL:1710-1785MHz, DL:1805-1880MHz |
| PCS1900              | Frequency          | UL:1850-1910MHz, DL:1930-1990MHz               |                                  |
| Wireless LAN         | Antenna            | Antenna built in                               |                                  |
|                      | IEEE802.11b        | Frequency band/CH                              | 2.4GHz (2412-2472MHz)/1-13ch     |
|                      |                    | Bit rate                                       | 1/2/5.5/11Mbps                   |
|                      | IEEE802.11g        | Frequency band/CH                              | 2.4GHz (2412-2472MHz)/1-13ch     |
|                      |                    | Bit rate                                       | 6/9/12/18/24/36/48/54Mbps        |
|                      | IEEE802.11n        | Frequency band/CH                              | 2.4GHz (2412-2472MHz)/1-13ch     |
| Bit rate             |                    | 6.5 Mbps to 300 Mbps (HT20/40)                 |                                  |
| USB port             | Physical interface | Type micro B connector                         |                                  |
|                      | Port               | 1ports   |                                  |
|                      | Type               | USB2.0   |                                  |
| Operating conditions |                    | Temperature: 0 to 35 °C<br>Humidity: 10 to 90% |                                  |
| Dimensions           |                    | Approx. 117(W) x 64(D) x 11(H) mm              |                                  |
| Power consumption    |                    | 5.5W   |                                  |
| Weight               |                    | Approx. 0.111kg                                |                                  |

## Battery pack

|                  |                     |
|------------------|---------------------|
| Model name       | 1UF57555S-B003A     |
| Battery type     | Lithium ion battery |
| Nominal voltage  | 3.8V                |
| Nominal capacity | 2300mAh             |

## Notice

- (1) All rights reserved. No part of this manual may be copied or reproduced without prior permission.
- (2) Contents of this manual may change without notice.
- (3) We take every possible precaution to ensure the accuracy of this manual, but if anything is unclear or erroneous in the content, please contact us. (<http://www.necat.co.jp/>)
- (4) We assume no responsibility whatsoever for any failure, malfunction, accident, trouble or damage resulting from external causes such as erroneous operation, natural disasters, faults power cuts, etc.
- (5) Please note that we shall not be responsible for any damage resulting from security problems if no security measures are in place or the wireless LAN specification is insecure.
- (6) If the product is damaged in accidentally through inappropriate use or unpredictable circumstances (e.g. thunderstorms or electric current leakage), the product may not operate properly. Please read this manual and follow the instructions carefully.



### **Disposing of your used NEC product**

#### **In the European Union**

EU-wide legislation as implemented in each Member State requires that used electrical and electronic products carrying the mark (left) must be disposed of separately from normal household waste. *This includes the residential gateway or electrical accessories, such as the AC Adaptor.*

When you dispose of such products, please follow the guidance of your local authority and/or ask the shop where you purchased the product.

The mark on the electrical and electronic products only applies to the current European Union Member States.

#### **Outside the European Union**

If you wish to dispose of used electrical and electronic products outside the European Union, please contact your local authority and ask for the correct method of disposal.

## **Europe – EU Declaration of Conformity**

This device complies with the essential requirements of the R&TTE Directive 1999/5/EC. The following test methods have been applied in order to prove presumption of conformity with the essential requirements of the R&TTE Directive 1999/5/EC:

- EN 60950-1/A12: 2011

Safety of Information Technology Equipment

- EN 50566:2013

Product standard to demonstrate compliance of radio frequency fields from handheld and body-mounted wireless communication devices used by the general public (30 MHz — 6 GHz)

- EN 300 328 V1.8.1:2012

Electromagnetic compatibility and Radio spectrum Matters (ERM); Wideband transmission systems; Data transmission equipment operating in the 2.4GHz ISM band and using wide band modulation techniques; Harmonized EN covering the essential requirements of article 3.2 of the R&TTE Directive

- EN 301 511 V9.0.2:2003

Global System for Mobile communications (GSM); Harmonized standard for mobile stations in the GSM 900 and DCS 1800 bands covering essential requirements under article 3.2 of the R&TTE directive (1999/5/EC)

- EN 62479:2010

Assessment of the compliance of low power electronic and electrical equipment with the basic restrictions related to human exposure to electromagnetic fields (10 MHz to 300 GHz)

- EN 301 908-1 V5.2.1:2013

IMT cellular networks; Harmonized EN covering the essential requirements

of article 3.2 of the R&TTE Directive; Part 1: Introduction and common requirements

## **Federal Communication Commission Interference Statement**

This device complies with Part 15 of the FCC Rules. Operation is subject to the following two conditions: (1) This device may not cause harmful interference, and (2) this device must accept any interference received, including interference that may cause undesired operation.

This equipment has been tested and found to comply with the limits for a Class B digital device, pursuant to Part 15 of the FCC Rules. These limits are designed to provide reasonable protection against harmful interference in a residential installation. This equipment generates, uses and can radiate radio frequency energy and, if not installed and used in accordance with the instructions, may cause harmful interference to radio communications. However, there is no guarantee that interference will not occur in a particular installation. If this equipment does cause harmful interference to radio or television reception, which can be determined by turning the equipment off and on, the user is encouraged to try to correct the interference by one of the following measures:

- Reorient or relocate the receiving antenna.
- Increase the separation between the equipment and receiver.
- Connect the equipment into an outlet on a circuit different from that to which the receiver is connected.
- Consult the dealer or an experienced radio/TV technician for help.

FCC Caution: Any changes or modifications not expressly approved by the party responsible for compliance could void the user's authority to operate this equipment.

This transmitter must not be co-located or operating in conjunction with any other antenna or transmitter.

## **Radiation Exposure Statement**

The product comply with the FCC portable RF exposure limit set forth for an uncontrolled environment and are safe for intended operation as described in this manual. The further RF exposure reduction can be achieved if the product can be kept as far as possible from the user body or set the device to lower output power if such function is available.

