

FCC Test Report

(PART 22)

Report No.: RF150114C11

FCC ID: 2AA5WPAMR04LN

Test Model: PA-MR04LN

Received Date: Jan. 14, 2015

Test Date: Jan. 20 ~ Mar. 13, 2015

Issued Date: Mar. 26, 2015

Applicant: NEC Platforms.

Address: 800, Shimomata, Kakegawa-shi, Shizuoka 436-8501, Japan

Issued By: Bureau Veritas Consumer Products Services (H.K.) Ltd., Taoyuan Branch

Lab Address: No. 47-2, 14th Ling, Chia Pau Vil., Lin Kou Dist., New Taipei City, Taiwan (R.O.C.)

Test Location: No.19, Hwa Ya 2nd Rd., Wen Hwa Vil., Kwei Shan Dist., Taoyuan City 33383, TAIWAN (R.O.C.)



This report is for your exclusive use. Any copying or replication of this report to or for any other person or entity, or use of our name or trademark, is permitted only with our prior written permission. This report sets forth our findings solely with respect to the test samples identified herein. The results set forth in this report are not indicative or representative of the quality or characteristics of the lot from which a test sample was taken or any similar or identical product specifically and expressly noted. Our report includes all of the tests requested by you and the results thereof based upon the information that you provided to us. You have 60 days from date of issuance of this report to notify us of any material error or omission caused by our negligence, provided, however, that such notice shall be in writing and shall specifically address the issue you wish to raise. A failure to raise such issue within the prescribed time shall constitute your unqualified acceptance of the completeness of this report, the tests conducted and the correctness of the report contents. Unless specific mention, the uncertainty of measurement has been explicitly taken into account to declare the compliance or non-compliance to the specification. The report must not be used by the client to claim product certification, approval, or endorsement by TAF or any government agencies

Table of Contents

Release Control Record	3
1 Certificate of Conformity	4
2 Summary of Test Results	5
2.1 Measurement Uncertainty.....	5
2.2 Test Site And Instruments.....	6
3 General Information	7
3.1 General Description of EUT.....	7
3.2 Configuration of System Under Test.....	8
3.2.1 Description Of Support Units.....	8
3.3 Test Mode Applicability and Tested Channel Detail.....	9
3.4 EUT Operating Conditions.....	10
3.5 General Description of Applied Standards.....	10
4 Test Types and Results	11
4.1 Output Power Measurement.....	11
4.1.1 Limits of Output Power Measurement.....	11
4.1.2 Test Procedures.....	11
4.1.3 Test Setup.....	12
4.1.4 Test Results.....	13
4.2 Frequency Stability Measurement.....	16
4.2.1 Limits of Frequency Stabiliity Measurement.....	16
4.2.2 Test Procedure.....	16
4.2.3 Test Setup.....	16
4.2.4 Test Results.....	17
4.3 Occupied Bandwidth Measurement.....	18
4.3.1 Test Procedure.....	18
4.3.2 Test Setup.....	18
4.3.3 Test Result.....	19
4.4 Band Edge Measurement.....	20
4.4.1 Limits of Band Edge Measurement.....	20
4.4.2 Test Setup.....	20
4.4.3 Test Procedures.....	20
4.4.4 Test Results.....	21
4.5 Peak To Average Ratio.....	23
4.5.1 Limits of Peak To Average Ratio Measurement.....	23
4.5.2 Test Setup.....	23
4.5.3 Test Procedures.....	23
4.5.4 Test Results.....	24
4.6 Conducted Spurious Emissions.....	25
4.6.1 Limits of Conducted Spurious Emissions Measurement.....	25
4.6.2 Test Setup.....	25
4.6.3 Test Procedure.....	25
4.6.4 Test Results.....	26
4.7 Radiated Emission Measurement.....	38
4.7.1 Limits of Radiated Emission Measurement.....	38
4.7.2 Test Procedure.....	38
4.7.3 Deviation from Test Standard.....	38
4.7.4 Test Setup.....	39
4.7.5 Test Results.....	40
5 Pictures of Test Arrangements	46
Appendix – Information on the Testing Laboratories	47



A D T

Release Control Record

Issue No.	Description	Date Issued
RF150114C11	Original release.	Mar. 26, 2015



1 Certificate of Conformity

Product: AtermMR04LN
Brand: NEC
Test Model: PA-MR04LN
Sample Status: Engineering sample
Applicant: NEC Platforms.
Test Date: Jan. 20 ~ Mar. 13, 2015
Standards: FCC Part 22, Subpart H

The above equipment has been tested by **Bureau Veritas Consumer Products Services (H.K.) Ltd., Taoyuan Branch**, and found compliance with the requirement of the above standards. The test record, data evaluation & Equipment Under Test (EUT) configurations represented herein are true and accurate accounts of the measurements of the sample's EMC characteristics under the conditions specified in this report.

Prepared by : Shy Lin , **Date:** Mar. 26, 2015
Shy Lin / Specialist

Approved by : Bruce Chen , **Date:** Mar. 26, 2015
Bruce Chen / Project Engineer

2 Summary of Test Results

Applied Standard: FCC Part 22 & Part 2			
FCC Clause	Test Item	Result	Remarks
2.1046 22.913 (a)	Effective radiated power	PASS	Meet the requirement of limit.
---	Peak To Average Ratio	PASS	Meet the requirement of limit.
2.1055 22.355	Frequency Stability	PASS	Meet the requirement of limit.
2.1049	Occupied Bandwidth	PASS	Meet the requirement of limit.
22.917	Band Edge Measurements	PASS	Meet the requirement of limit.
2.1051 22.917	Conducted Spurious Emissions	PASS	Meet the requirement of limit.
2.1053 22.917	Radiated Spurious Emissions	PASS	Meet the requirement of limit. Minimum passing margin is -28.46dB at 43.58MHz.

2.1 Measurement Uncertainty

Where relevant, the following measurement uncertainty levels have been estimated for tests performed on the EUT as specified in CISPR 16-4-2:

Measurement	Frequency	Expanded Uncertainty (k=2) (\pm)
Radiated Emissions up to 1 GHz	30MHz ~ 200MHz	3.59 dB
	200MHz ~1000MHz	3.60 dB
Radiated Emissions above 1 GHz	1GHz ~ 18GHz	2.29 dB
	18GHz ~ 40GHz	2.29 dB

2.2 Test Site And Instruments

DESCRIPTION & MANUFACTURER	MODEL NO.	SERIAL NO.	DATE OF CALIBRATION	DUE DATE OF CALIBRATION
Test Receiver ROHDE & SCHWARZ	ESCI	100424	Oct. 06, 2014	Oct. 05, 2015
BILOG Antenna SCHWARZBECK	VULB9168	9168-155	Feb. 26, 2014	Feb. 25, 2015
			Feb. 06, 2015	Feb. 05, 2016
HORN Antenna SCHWARZBECK	BBHA 9120D	9120D-1170	Aug. 25, 2014	Aug. 24, 2015
HORN Antenna SCHWARZBECK	BBHA 9170	BBHA9170241	Feb. 20, 2014	Feb. 19, 2015
			Feb. 09, 2015	Feb. 08, 2016
Preamplifier Agilent	8449B	3008A01961	Oct. 18, 2014	Oct. 17, 2015
Preamplifier Agilent	8447D	2944A10738	Oct. 18, 2014	Oct. 17, 2015
RF signal cable HUBER+SUHNNER	SUCOFLEX 104	309220/4	Aug. 09, 2014	Aug. 08, 2015
RF signal cable HUBER+SUHNNER	SUCOFLEX 104	250724/4	Aug. 09, 2014	Aug. 08, 2015
RF signal cable HUBER+SUHNNER	SUCOFLEX 104	295012/4	Aug. 09, 2014	Aug. 08, 2015
Software BV ADT	ADT_Radiated_ V7.6.15.9.4	NA	NA	NA
Antenna Tower inn-co GmbH	MA 4000	010303	NA	NA
Antenna Tower Controller inn-co GmbH	CO2000	019303	NA	NA
Turn Table BV ADT	TT100.	TT93021704	NA	NA
Turn Table Controller BV ADT	SC100.	SC93021704	NA	NA
Mini-Circuits Power Splitter	ZN2PD-9G	NA	Apr. 25, 2014	Apr. 24, 2015
JFW 20dB attenuation	50HF-020-SMA	NA	NA	NA

- NOTE:**
1. The calibration interval of the above test instruments is 12 months and the calibrations are traceable to NML/ROC and NIST/USA.
 2. The test was performed in HwaYa Chamber 4.
 3. The horn antenna and HP preamplifier (model: 8449B) are used only for the measurement of emission frequency above 1GHz if tested.
 4. The FCC Site Registration No. is 460141.
 5. The IC Site Registration No. is IC7450F-4.

3 General Information

3.1 General Description of EUT

Product	AtermMR04LN
Brand	NEC
Test Model	PA-MR04LN
Status of EUT	Engineering sample
Power Supply Rating	5Vdc (adapter) 3.8Vdc (battery)
Modulation Type	GPRS: GMSK WCDMA: BPSK
Operating Frequency	GPRS: 824.2MHz ~ 848.8MHz WCDMA: 826.4MHz ~ 846.6MHz
Max. ERP Power	GPRS: 445.66mW (26.49dBm) WCDMA: 37.24mW (15.71dBm)
Multi-Slots CLASS	12
Release Version	GPRS: R8
Antenna Type	Inverted F antenna with -2.69dBi gain
Antenna Connector	UFL
Accessory Device	N/A
Data Cable Supplied	N/A

Note:

1. The EUT uses following adapter, battery and USB cable.

Adapter (Support unit only)	
Brand	NEC
Model	AL1-004001-001
Input Power	100-240Vac, 50/60Hz, 140mA
Output Power	5Vdc, 1.0A

Li-ion Battery (Support unit only)	
Brand	NEC
Model	AL1-003388-001
Input Power	3.8Vdc, 2300mAh

USB cable (Support unit only)	1.0m non-shielded cable with one core
----------------------------------	---------------------------------------

2. The above EUT information is declared by manufacturer and for more detailed features description, please refer to the manufacturer's specifications or User's Manual.

3.2 Configuration of System Under Test

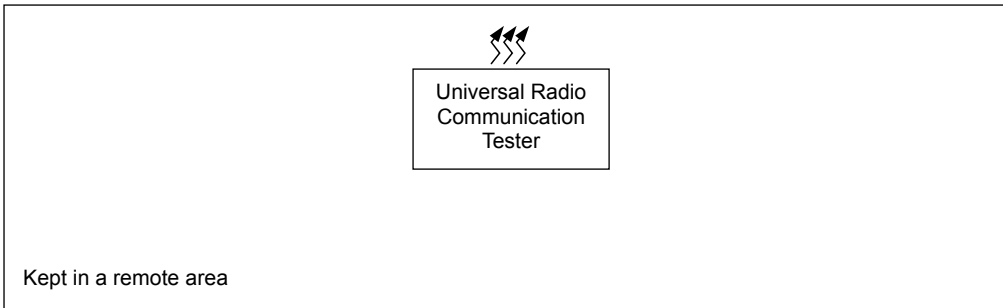
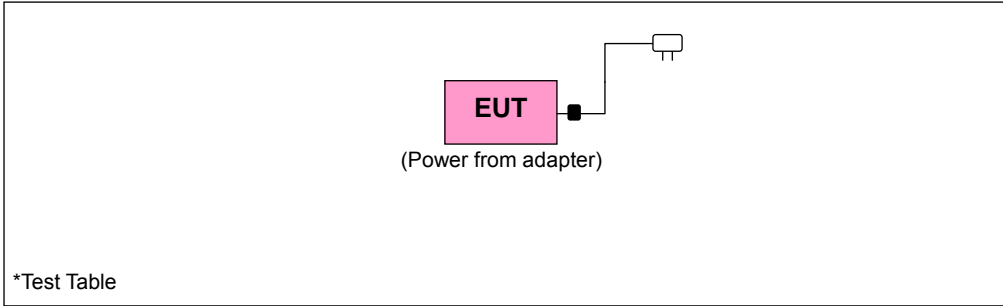

3.2.1 Description Of Support Units

The EUT has been tested as an independent unit together with other necessary accessories or support units. The following support units or accessories were used to form a representative test configuration during the tests.

ID	Product	Brand	Model No.	Serial No.	FCC ID	Remarks
A.	Universal Radio Communication Tester	R&S	CMU200	117260	NA	-

Note:

1. All power cords of the above support units are non-shielded (1.8m).
2. Item A acted as a communication partner to transfer data.

3.3 Test Mode Applicability and Tested Channel Detail

Pre-Scan has been conducted to determine the worst-case mode from all possible combinations between available modulations, data rates, XYZ axis and antenna ports

The worst case was found when positioned on Y-plane. Following channel(s) was (were) selected for the final test as listed below:

Test results are presented in the report as below.

Test Mode	Test Condition
A	Power from adapter
B	Power from battery

GPRS MODE

EUT Configure Mode	Test Item	Available Channel	Tested Channel	Mode
A	ERP	128 to 251	128, 189, 251	GPRS
B	Frequency Stability	128 to 251	189	GPRS
B	Occupied Bandwidth	128 to 251	128, 189, 251	GPRS
B	Band Edge	128 to 251	128, 251	GPRS
B	Peak To Average Ratio	128 to 251	128, 189, 251	GPRS
B	Condcudeted Emission	128 to 251	128, 189, 251	GPRS
A	Radiated Emission Below 1GHz	128 to 251	128	GPRS
A	Radiated Emission Above 1GHz	128 to 251	128, 189, 251	GPRS

WCDMA MODE

EUT Configure Mode	Test Item	Available Channel	Tested Channel	Mode
A	ERP	4132 to 4233	4132, 4182, 4233	WCDMA
B	Frequency Stability	4132 to 4233	4182	WCDMA
B	Occupied Bandwidth	4132 to 4233	4132, 4182, 4233	WCDMA, HSDPA, HSUPA
B	Band Edge	4132 to 4233	4132, 4233	WCDMA, HSDPA, HSUPA
B	Peak To Average Ratio	4132 to 4233	4132, 4182, 4233	WCDMA, HSDPA, HSUPA
B	Condcudeted Emission	4132 to 4233	4132, 4182, 4233	WCDMA, HSDPA, HSUPA
A	Radiated Emission Below 1GHz	4132 to 4233	4132	WCDMA
A	Radiated Emission Above 1GHz	4132 to 4233	4132, 4182, 4233	WCDMA

Test Condition:

Test Item	Environmental Conditions	Input Power	Tested By
ERP	25deg. C, 65%RH	120Vac, 60Hz	Chris Lin
Frequency Stability	24deg. C, 64%RH	3.8Vdc	Match Tsui
Occupied Bandwidth	24deg. C, 64%RH	3.8Vdc	Match Tsui
Band Edge	24deg. C, 64%RH	3.8Vdc	Match Tsui
Peak To Average Ratio	24deg. C, 64%RH	3.8Vdc	Match Tsui
Condcudeted Emission	24deg. C, 64%RH	3.8Vdc	Match Tsui
Radiated Emission	25deg. C, 65%RH	120Vac, 60Hz	Chris Lin

3.4 EUT Operating Conditions

The EUT makes a call to the communication simulator. The communication simulator station system controlled a EUT to export maximum output power under transmission mode and specific channel frequency

3.5 General Description of Applied Standards

The EUT is a RF Product. According to the specifications of the manufacturer, it must comply with the requirements of the following standards:

FCC 47 CFR Part 2

FCC 47 CFR Part 22

KDB 971168 D01 Power Meas License Digital Systems v02r01

ANSI/TIA/EIA-603-C 2004

NOTE: All test items have been performed and recorded as per the above standards.

4 Test Types and Results

4.1 Output Power Measurement

4.1.1 Limits of Output Power Measurement

Mobile / Portable station are limited to 7 watts e.r.p.

4.1.2 Test Procedures

EIRP / ERP Measurement:

- a. All measurements were done at low, middle and high operational frequency range. RBW and VBW is 1MHz for GPRS and 5MHz for WCDMA mode.
- b. Substitution method is used for E.I.R.P measurement. In the semi-anechoic chamber, EUT placed on the 0.8m height of Turn Table, rotated the table around 360 degrees to search the maximum radiation power and receiver antenna shall be rotated vertical and horizontal polarization and moved height from 1m to 4m to find the maximum polar radiated power. The "Read Value" is the spectrum reading the maximum power value.
- c. The substitution horn antenna is substituted for EUT at the same position and signals generator export the CW signal to the substitution antenna via a tx cable. Rotated the Turn Table and moved receiving antenna to find the maximum radiation power. Adjust output power level of S.G to get a Value of spectrum reading equal to "Read Value" of step b. Record the power level of S.G
- d. $EIRP = \text{Output power level of S.G} - \text{TX cable loss} + \text{Antenna gain of substitution horn.}$ E.R.P power can be calculated form E.I.R.P power by subtracting the gain of dipole, $E.R.P \text{ power} = E.I.R.P \text{ power} - 2.15\text{dBi}$.

Conducted Power Measurement:

The EUT was set up for the maximum power with GPRS & WCDMA link data modulation and link up with simulator. Set the EUT to transmit under low, middle and high channel and record the power level shown on simulator.

4.1.3 Test Setup
EIRP / ERP MEASUREMENT:

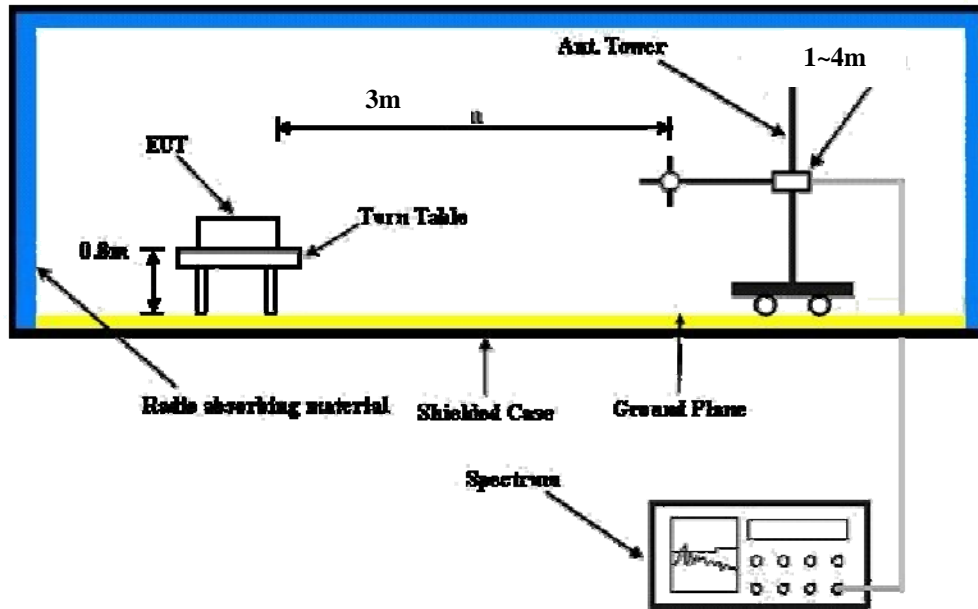

For the actual test configuration, please refer to the attached file (Test Setup Photo).

CONDUCTED POWER MEASUREMENT:

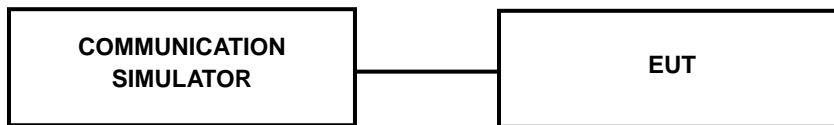

For the actual test configuration, please refer to the attached file (Test Setup Photo).

4.1.4 Test Results

CONDUCTED OUTPUT POWER (dBm)

Band	GPRS850		
Channel	128	189	251
Frequency (MHz)	824.2	836.4	848.8
GPRS 8	32.56	32.65	32.62
GPRS 10	29.99	30.08	30.05
GPRS 11	28.60	28.69	28.66
GPRS 12	27.31	27.50	27.37

Band	WCDMA V		
Channel	4132	4182	4233
Frequency (MHz)	826.4	836.4	846.6
RMC 12.2K	21.63	22.38	22.21
HSDPA Subtest-1	21.67	21.18	21.54
HSDPA Subtest-2	20.74	21.31	21.34
HSDPA Subtest-3	20.28	20.85	21.21
HSDPA Subtest-4	20.27	20.84	21.20
HSUPA Subtest-1	20.98	21.60	21.23
HSUPA Subtest-2	20.55	21.27	21.15
HSUPA Subtest-3	20.63	21.28	21.21
HSUPA Subtest-4	20.47	21.27	21.10
HSUPA Subtest-5	21.90	22.12	22.05

ERP Power (dBm)

For GPRS Mode:

MODE		TX channel 128					
Antenna Polarity & Test Distance: Horizontal at 3 M							
No.	Freq. (MHz)	Reading (dBm)	S.G Power Value (dBm)	Correction Factor (dB)	ERP (dBm)	Limit (dBm)	Margin (dB)
1	824.20	-4.70	26.48	0.01	26.49	38.45	-11.96
Antenna Polarity & Test Distance: Vertical at 3 M							
No.	Freq. (MHz)	Reading (dBm)	S.G Power Value (dBm)	Correction Factor (dB)	ERP (dBm)	Limit (dBm)	Margin (dB)
1	824.20	-10.86	21.05	0.01	21.06	38.45	-17.39

MODE		TX channel 189					
Antenna Polarity & Test Distance: Horizontal at 3 M							
No.	Freq. (MHz)	Reading (dBm)	S.G Power Value (dBm)	Correction Factor (dB)	ERP (dBm)	Limit (dBm)	Margin (dB)
1	836.40	-5.67	25.37	0.29	25.66	38.45	-12.79
Antenna Polarity & Test Distance: Vertical at 3 M							
No.	Freq. (MHz)	Reading (dBm)	S.G Power Value (dBm)	Correction Factor (dB)	ERP (dBm)	Limit (dBm)	Margin (dB)
1	836.40	-9.26	22.43	0.29	22.72	38.45	-15.73

MODE		TX channel 251					
Antenna Polarity & Test Distance: Horizontal at 3 M							
No.	Freq. (MHz)	Reading (dBm)	S.G Power Value (dBm)	Correction Factor (dB)	ERP (dBm)	Limit (dBm)	Margin (dB)
1	848.80	-5.77	24.69	0.51	25.20	38.45	-13.25
Antenna Polarity & Test Distance: Vertical at 3 M							
No.	Freq. (MHz)	Reading (dBm)	S.G Power Value (dBm)	Correction Factor (dB)	ERP (dBm)	Limit (dBm)	Margin (dB)
1	848.80	-9.54	21.77	0.51	22.28	38.45	-16.17

NOTE: ERP (dBm) = S.G Power Value (dBm) + Correction Factor (dB).

For WCDMA Mode:

MODE		TX channel 4132					
Antenna Polarity & Test Distance: Horizontal at 3 M							
No.	Freq. (MHz)	Reading (dBm)	S.G Power Value (dBm)	Correction Factor (dB)	ERP (dBm)	Limit (dBm)	Margin (dB)
1	826.40	-15.47	15.64	0.06	15.70	38.45	-22.75
Antenna Polarity & Test Distance: Vertical at 3 M							
No.	Freq. (MHz)	Reading (dBm)	S.G Power Value (dBm)	Correction Factor (dB)	ERP (dBm)	Limit (dBm)	Margin (dB)
1	826.40	-19.95	11.83	0.06	11.89	38.45	-26.56

MODE		TX channel 4182					
Antenna Polarity & Test Distance: Horizontal at 3 M							
No.	Freq. (MHz)	Reading (dBm)	S.G Power Value (dBm)	Correction Factor (dB)	ERP (dBm)	Limit (dBm)	Margin (dB)
1	836.40	-15.62	15.42	0.29	15.71	38.45	-22.74
Antenna Polarity & Test Distance: Vertical at 3 M							
No.	Freq. (MHz)	Reading (dBm)	S.G Power Value (dBm)	Correction Factor (dB)	ERP (dBm)	Limit (dBm)	Margin (dB)
1	836.40	-19.96	11.73	0.29	12.02	38.45	-26.43

MODE		TX channel 4233					
Antenna Polarity & Test Distance: Horizontal at 3 M							
No.	Freq. (MHz)	Reading (dBm)	S.G Power Value (dBm)	Correction Factor (dB)	ERP (dBm)	Limit (dBm)	Margin (dB)
1	846.60	-15.56	14.82	0.47	15.29	38.45	-23.16
Antenna Polarity & Test Distance: Vertical at 3 M							
No.	Freq. (MHz)	Reading (dBm)	S.G Power Value (dBm)	Correction Factor (dB)	ERP (dBm)	Limit (dBm)	Margin (dB)
1	846.60	-20.05	11.17	0.47	11.64	38.45	-26.81

NOTE: ERP (dBm) = S.G Power Value (dBm) + Correction Factor (dB).

4.2 Frequency Stability Measurement

4.2.1 Limits of Frequency Stability Measurement

1.5 ppm is for base and fixed station. 2.5 ppm is for mobile station.

4.2.2 Test Procedure

- Device is placed at the oven room. The oven room could control the temperatures and humidity. Power warm up is at least 15 min and power applied should perform before recording frequency error.
- EUT is connected the external power supply to control the DC input power. The test voltage range is from minimum to maximum working voltage. Each step shall be record the frequency error rate.
- The temperature range step is 10 degrees in this test items. All temperature levels shall be hold the ± 0.5 during the measurement testing. The each temperature step shall be at least 0.5 hours, consider the EUT could be test under the stability condition.

NOTE: The frequency error was recorded frequency error from the communication simulator.

4.2.3 Test Setup

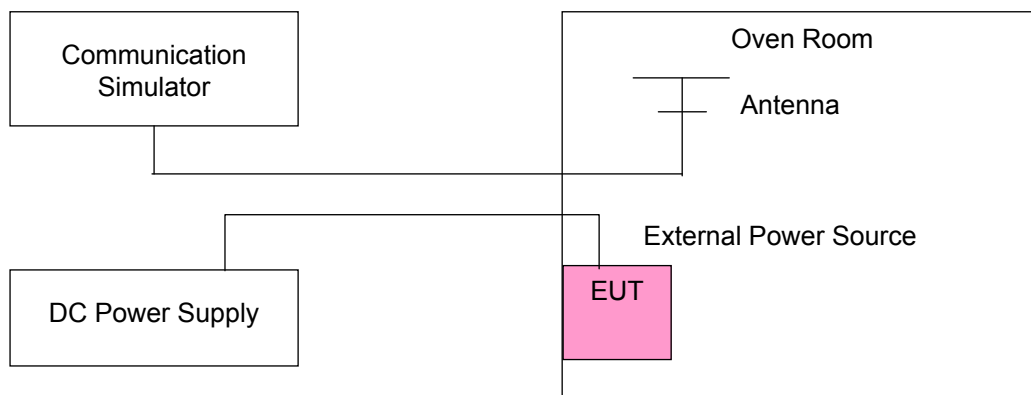

4.2.4 Test Results

Frequency Error vs. Voltage

Voltage (Volts)	Frequency Error (ppm)		Limit (ppm)
	GPRS	WCDMA	
4.2	-0.019	-0.018	2.5
3.8	-0.018	-0.016	2.5
3.5	-0.018	-0.017	2.5

NOTE: The applicant defined the normal working voltage of the battery is from 3.5Vdc to 4.2Vdc.

Frequency Error vs. Temperature.

TEMP. ()	Frequency Error (ppm)		Limit (ppm)
	GPRS	WCDMA	
60	-0.035	-0.030	2.5
50	-0.029	-0.029	2.5
40	-0.029	-0.025	2.5
30	-0.020	-0.019	2.5
20	-0.018	-0.016	2.5
10	-0.025	-0.023	2.5
0	-0.035	-0.029	2.5
-10	-0.041	-0.037	2.5
-20	-0.039	-0.037	2.5

4.3 Occupied Bandwidth Measurement

4.3.1 Test Procedure

The EUT makes a call to the communication simulator. All measurements were done at low, middle and high operational frequency range. The communication simulator station system controlled a EUT to export maximum output power under transmission mode and specific channel frequency. Use OBW measurement function of Spectrum analyzer to measure 99 % occupied bandwidth.

4.3.2 Test Setup

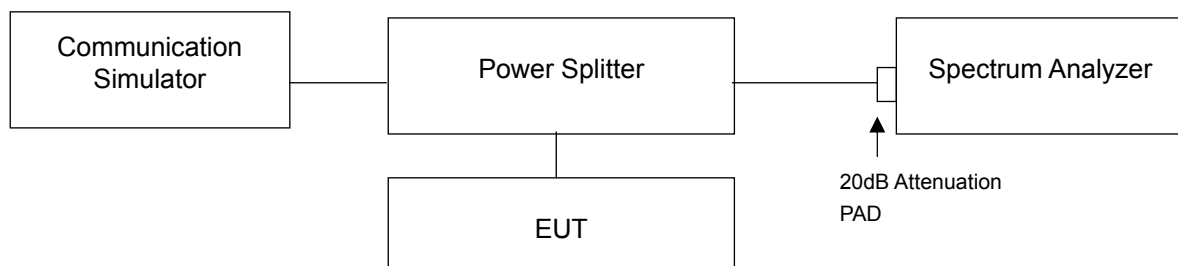

4.3.3 Test Result

Channel	Frequency (MHz)	99% Occupied Bandwidth (kHz)	Channel	FREQ. (MHz)	99% Occupied Bandwidth (MHz)		
		GRPS			WCDMA	HSDPA	HSUPA
128	824.2	250.00	4132	826.4	4.12	4.13	4.13
189	836.4	270.00	4182	836.4	4.15	4.15	4.13
251	848.8	250.00	4233	846.6	4.17	4.17	4.17

Spectrum Plot Of Worst Value

GPRS

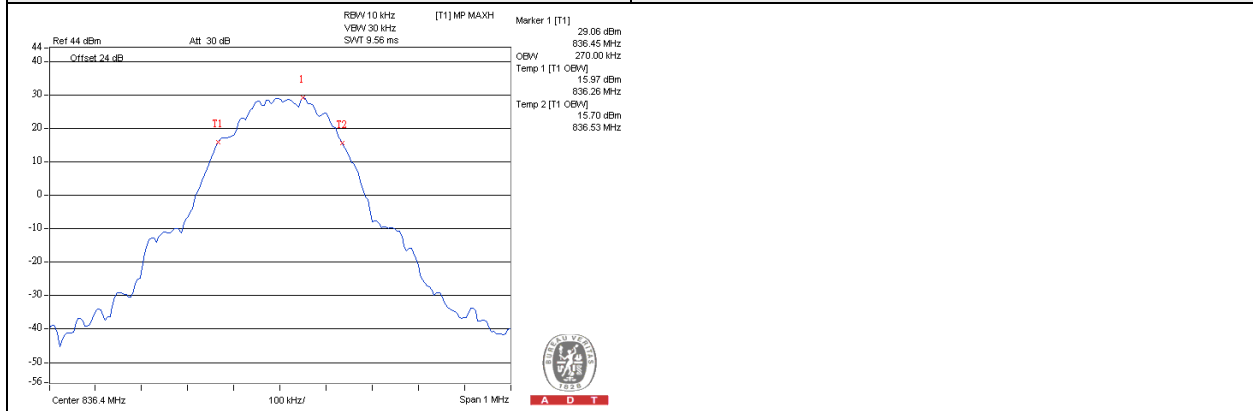

WCDMA

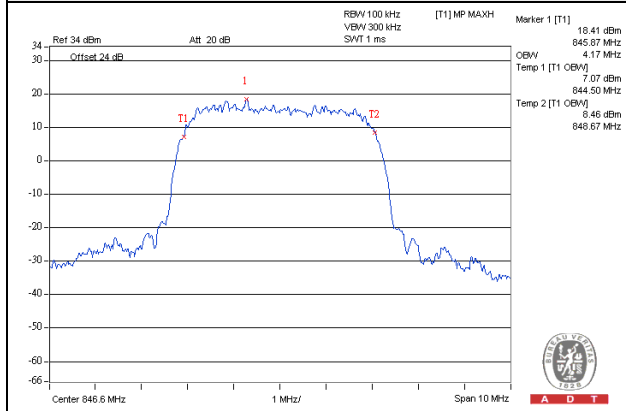

HSDPA

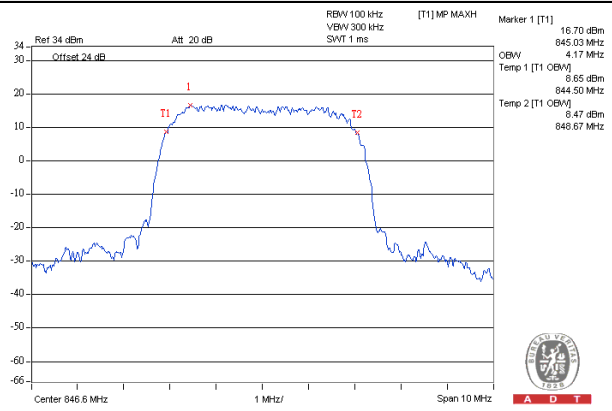

HSUPA

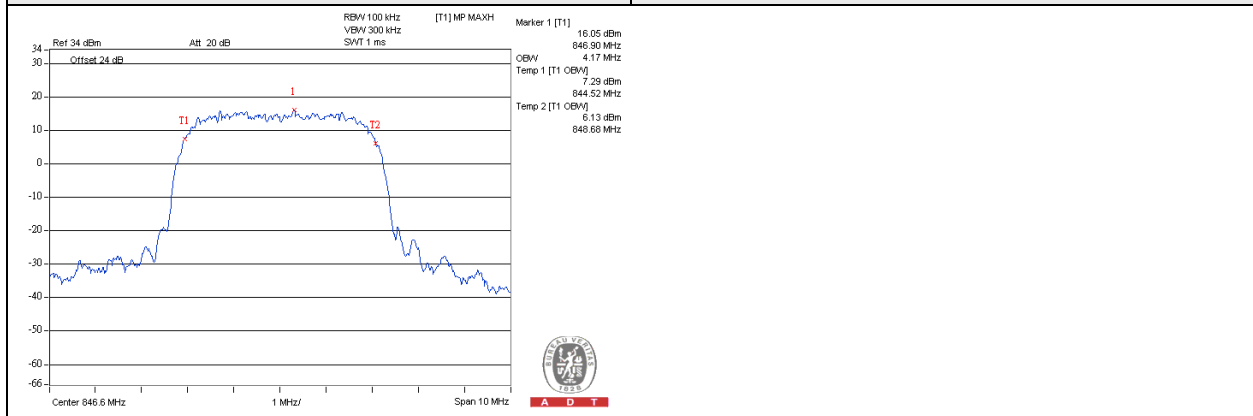

4.4 Band Edge Measurement

4.4.1 Limits of Band Edge Measurement

Power of any emission outside of the authorized operating frequency ranges must be attenuated below the transmitting power (P) by a factor of at least $43 + 10 \log(P)$ dB. In the 1 MHz bands immediately outside and adjacent to the frequency block a resolution bandwidth of at least one percent of the emission bandwidth of the fundamental emission of the transmitter may be employed.

4.4.2 Test Setup

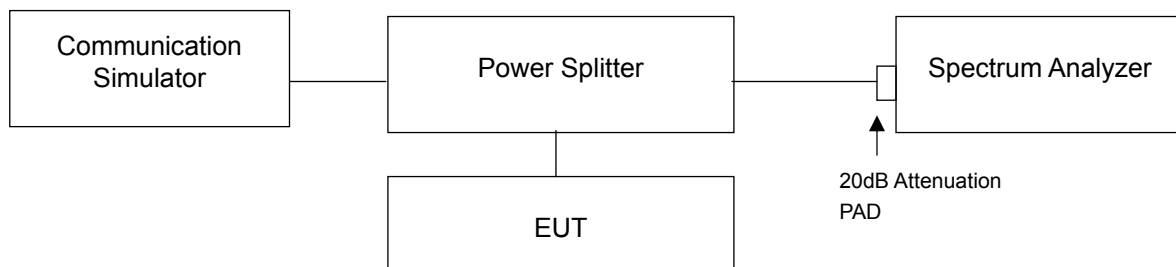

4.4.3 Test Procedures

- a. All measurements were done at low and high operational frequency range.
- b. The center frequency of spectrum is the band edge frequency and span is 1.5MHz. RB of the spectrum is 3kHz and VB of the spectrum is 10kHz (GPRS).
- c. The center frequency of spectrum is the band edge frequency and span is 10MHz. RB of the spectrum is 100kHz and VB of the spectrum is 300kHz (WCDMA/ HSDPA/ HSUPA).
- d. Record the max trace plot into the test report.

4.4.4 Test Results

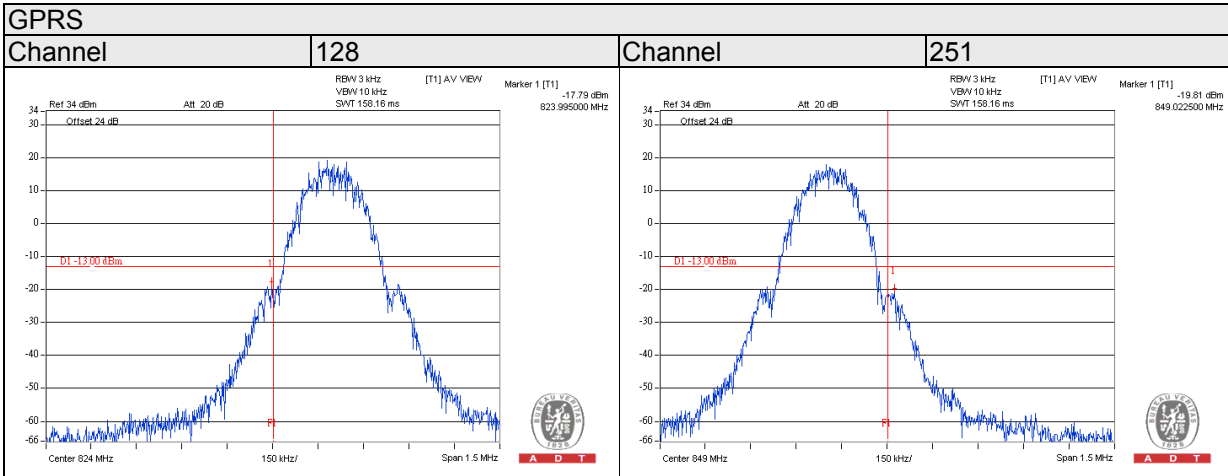

WCDMA	
Channel 4132	Channel 4233

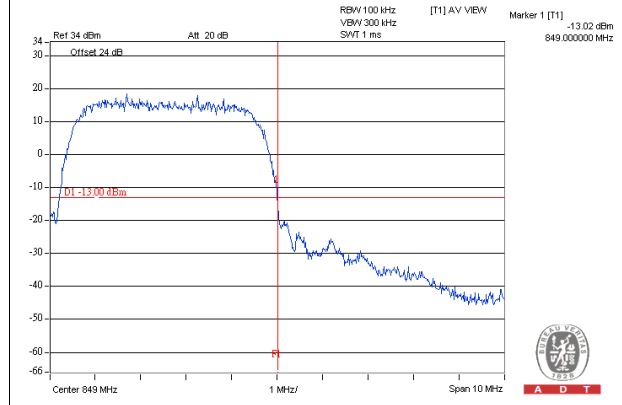
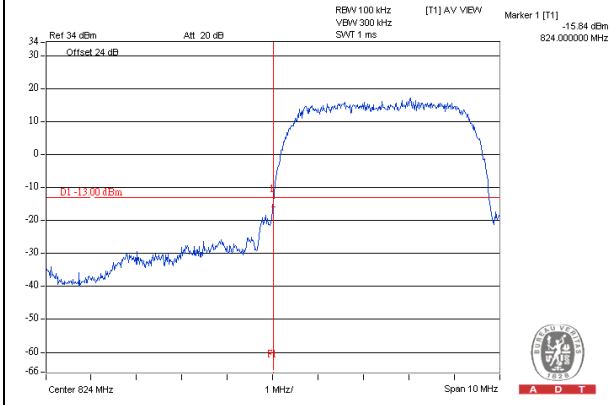

HSDPA	
Channel 4132	Channel 4233

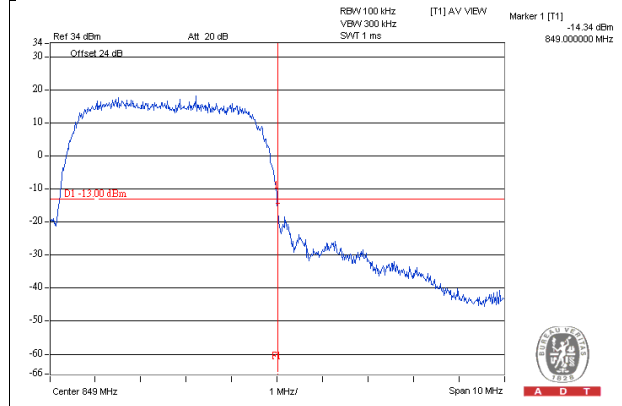
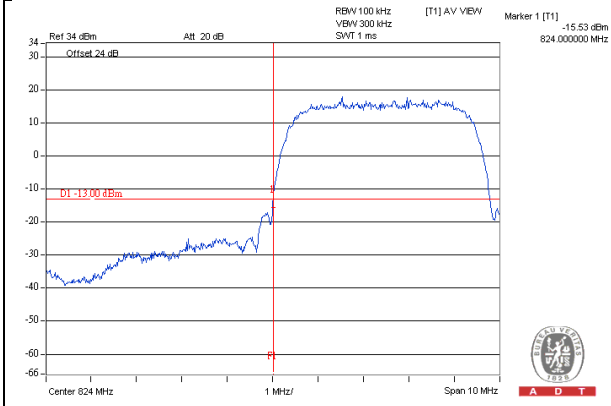

HSUPA	
Channel 4132	Channel 4233

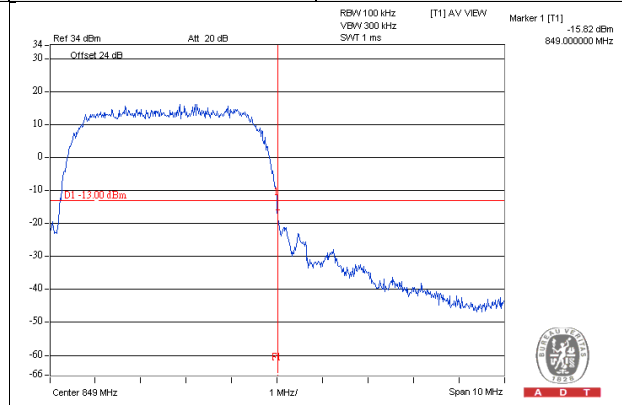
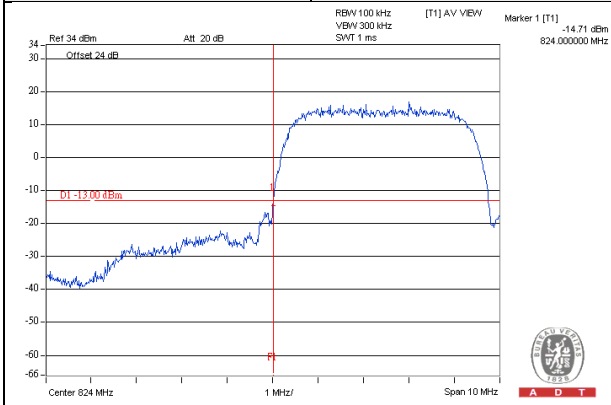

4.5 Peak To Average Ratio

4.5.1 Limits of Peak To Average Ratio Measurement

In measuring transmissions in this band using an average power technique, the peak to-average ratio (PAR) of the transmission may not exceed 13 dB

4.5.2 Test Setup

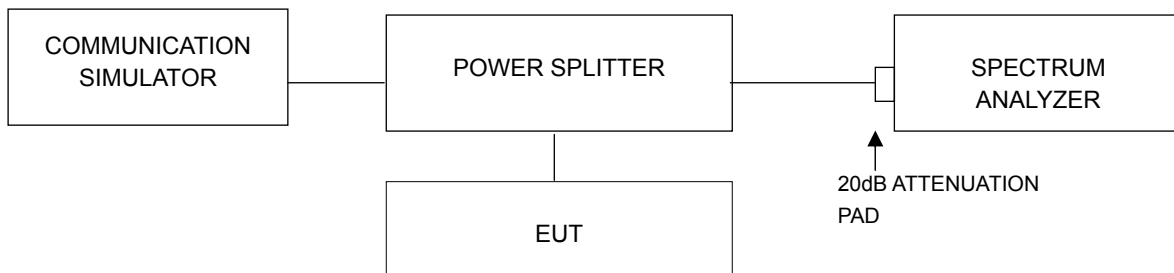

4.5.3 Test Procedures

1. Set resolution/measurement bandwidth \geq signal's occupied bandwidth;
2. Set the number of counts to a value that stabilizes the measured CCDF curve;
3. Record the maximum PAPR level associated with a probability of 0.1%.

4.5.4 Test Results

Channel	Frequency (MHz)	Peak To Average Ratio (dB)		
		GPRS	WCDMA	HSDPA
128	824.2	2.69	3.13	3.17
189	836.4	2.77	3.19	3.20
251	848.8	2.63	3.07	3.14

Spectrum Plot Of Worst Value

GPRS

R L

Ch Freq 836.4 MHz Trig VidIF

CCDF Counts(k): 100

Average Power
31.48 dBm
52.66%

10.0%	2.47 dB
1.0%	2.60 dB
0.1%	2.77 dB
0.01%	2.77 dB
0.001%	2.77 dB
Peak	2.77 dB

Copyright 2000-2010 Agilent Technologies

Freq/Channel

Center Freq 836.400000 MHz

Start Freq 836.400000 MHz

Stop Freq 836.400000 MHz

CF Step 5.00000000 MHz
Auto Man

Freq Offset 0.00000000 Hz

Signal Track On Off

WCDMA

R L

Ch Freq 836.4 MHz Trig Free

CCDF Counts(k): 100

Average Power
21.37 dBm
53.33%

10.0%	1.71 dB
1.0%	2.69 dB
0.1%	3.19 dB
0.01%	3.39 dB
0.001%	3.49 dB
Peak	3.49 dB

Copyright 2000-2012 Agilent Technologies

Freq/Channel

Center Freq 836.400000 MHz

Start Freq 836.400000 MHz

Stop Freq 836.400000 MHz

CF Step 5.00000000 MHz
Auto Man

Freq Offset 0.00000000 Hz

Signal Track On Off

HSDPA

R L

Ch Freq 836.4 MHz Trig Free

CCDF Counts(k): 100

Average Power
21.31 dBm
53.34%

10.0%	1.72 dB
1.0%	2.68 dB
0.1%	3.20 dB
0.01%	3.40 dB
0.001%	3.53 dB
Peak	3.53 dB

Copyright 2000-2012 Agilent Technologies

Freq/Channel

Center Freq 836.400000 MHz

Start Freq 836.400000 MHz

Stop Freq 836.400000 MHz

CF Step 5.00000000 MHz
Auto Man

Freq Offset 0.00000000 Hz

Signal Track On Off

HSUPA

R L

Ch Freq 826.4 MHz Trig Free

CCDF Counts(k): 100

Average Power
21.01 dBm
53.41%

10.0%	1.71 dB
1.0%	2.70 dB
0.1%	3.19 dB
0.01%	3.42 dB
0.001%	3.53 dB
Peak	3.53 dB

File name error

Freq/Channel

Center Freq 826.400000 MHz

Start Freq 826.400000 MHz

Stop Freq 826.400000 MHz

CF Step 5.00000000 MHz
Auto Man

Freq Offset 0.00000000 Hz

Signal Track On Off

4.6 Conducted Spurious Emissions

4.6.1 Limits of Conducted Spurious Emissions Measurement

The power of any emission outside of the authorized operating frequency ranges must be attenuated below the transmitting power (P) by a factor of at least $43 + 10 \log(P)$ dB. The emission limit equal to -13dBm .

4.6.2 Test Setup

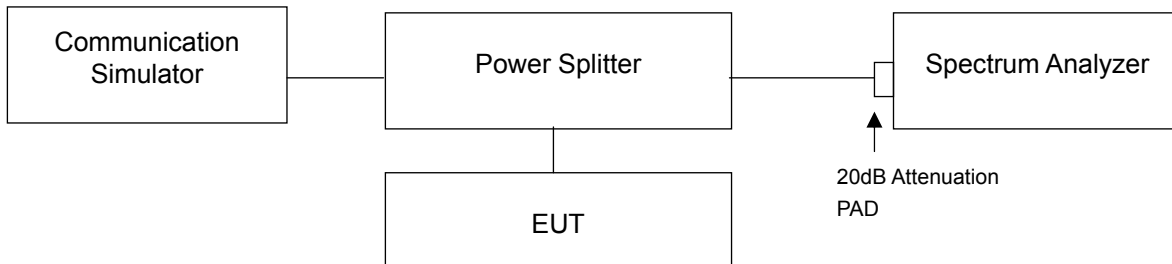

4.6.3 Test Procedure

- a. The EUT makes a phone call to the communication simulator. All measurements were done at low, middle and high operational frequency range.
- b. Measuring frequency range is from 9 kHz to 9GHz. 20dB attenuation pad is connected with spectrum. RBW=1MHz and VBW=3MHz is used for conducted emission measurement.

4.6.4 Test Results

GPRS

Channel 128

Frequency Range : 9kHz~1GHz Frequency Range : 1GHz~4GHz

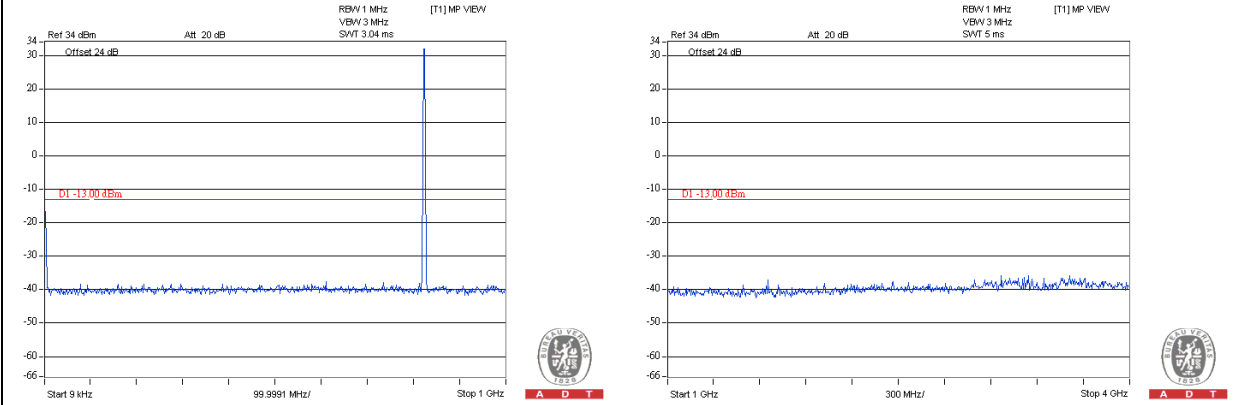

Frequency Range : 4GHz~7GHz Frequency Range : 7GHz~9GHz

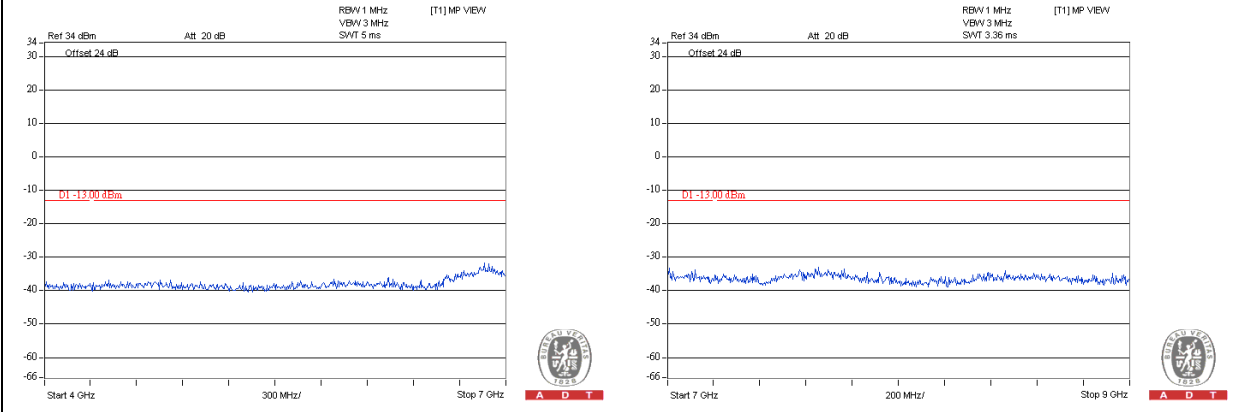

GPRS
Channel 189
Frequency Range : 9kHz~1GHz **Frequency Range : 1GHz~4GHz**

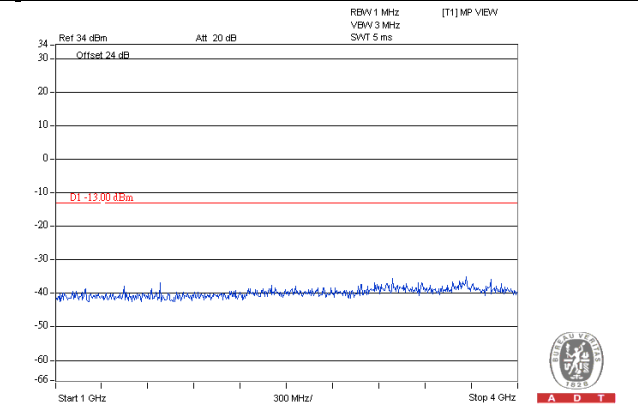
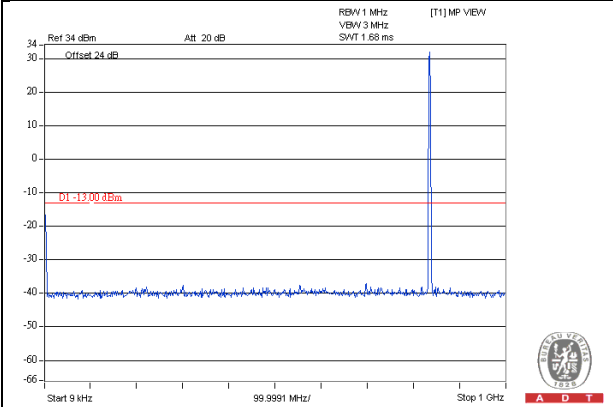

Frequency Range : 4GHz~7GHz

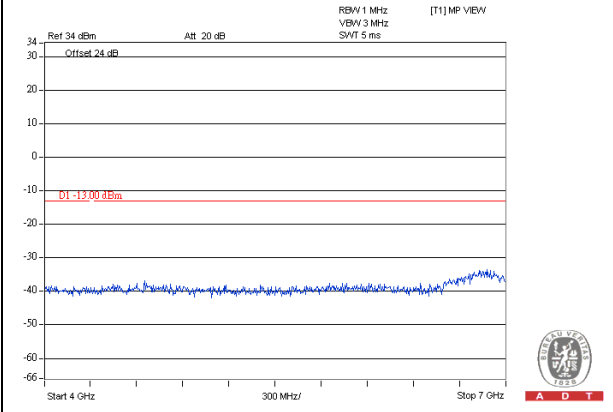

Frequency Range : 7GHz~9GHz

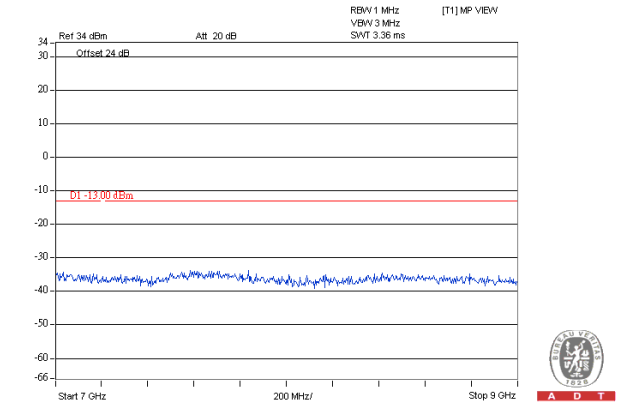

GPRS
Channel 251
Frequency Range : 9kHz~1GHz **Frequency Range : 1GHz~4GHz**

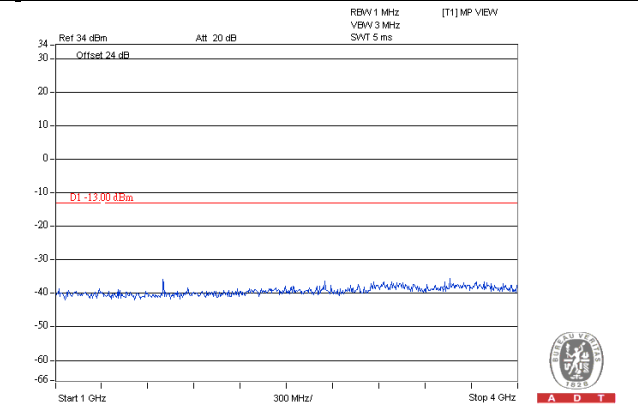
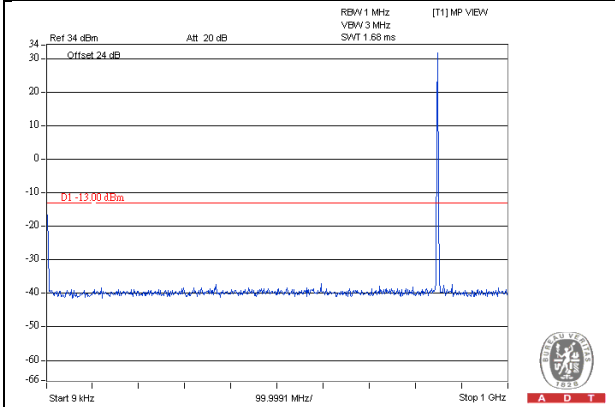

Frequency Range : 4GHz~7GHz

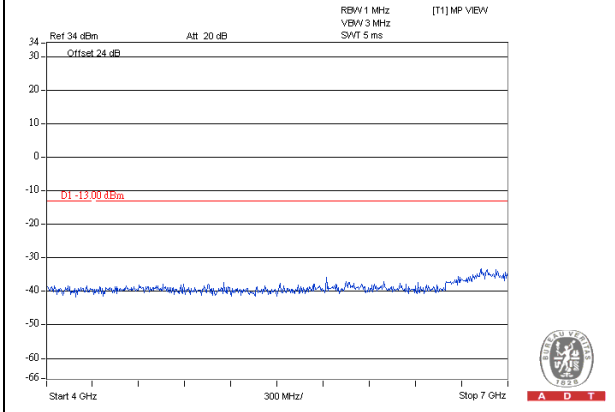

Frequency Range : 7GHz~9GHz

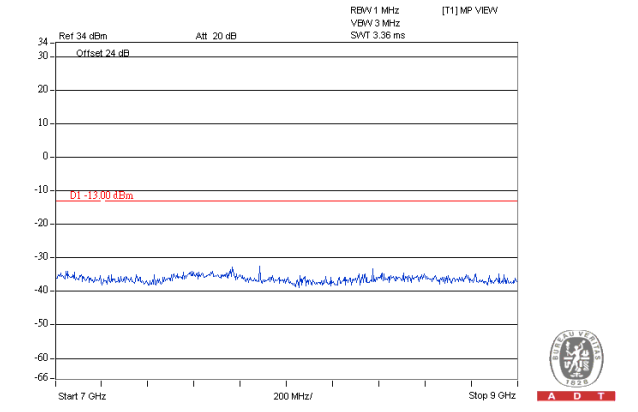

WCDMA

Channel 4132

Frequency Range : 9kHz~1GHz **Frequency Range : 1GHz~4GHz**

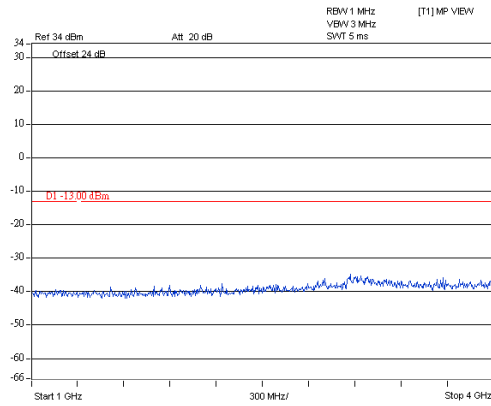
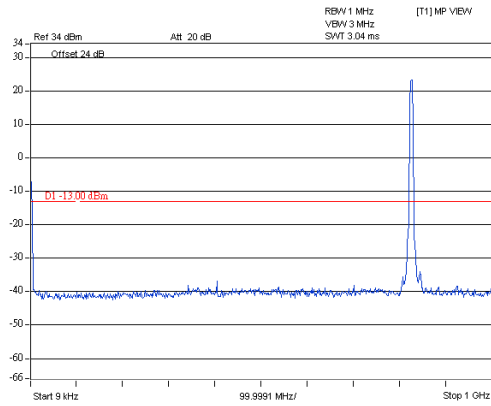

Frequency Range : 4GHz~7GHz **Frequency Range : 7GHz~9GHz**

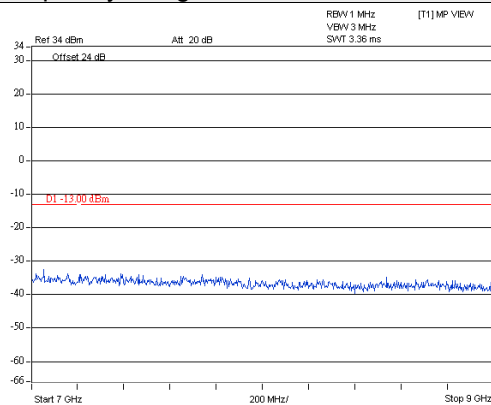
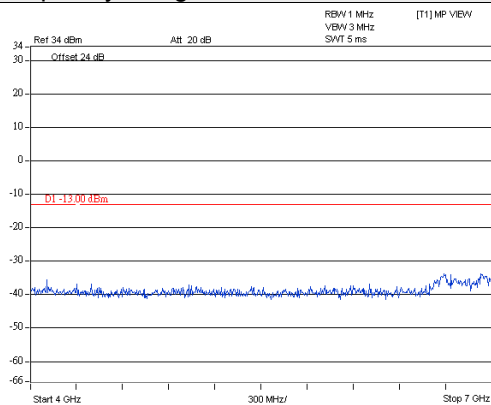

WCDMA
Channel 4182
Frequency Range : 9kHz~1GHz **Frequency Range : 1GHz~4GHz**

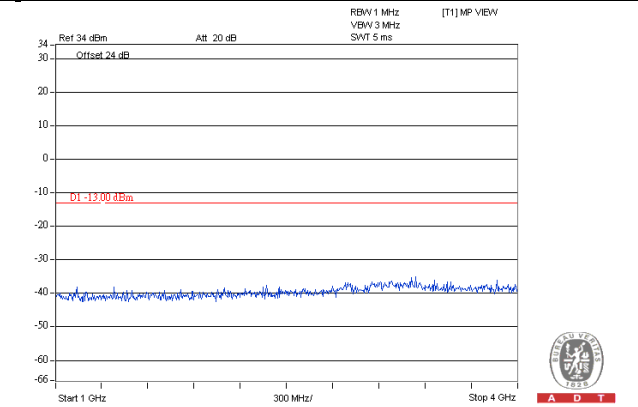
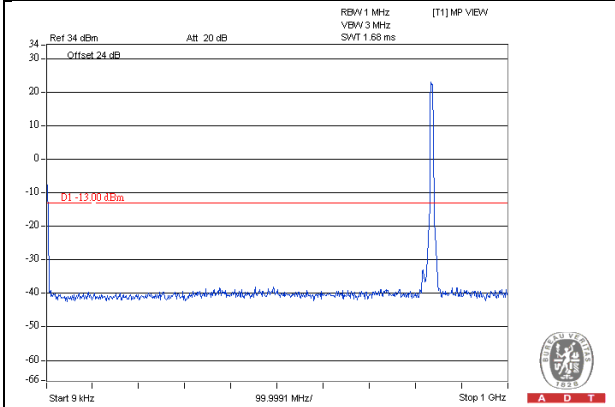

Frequency Range : 4GHz~7GHz

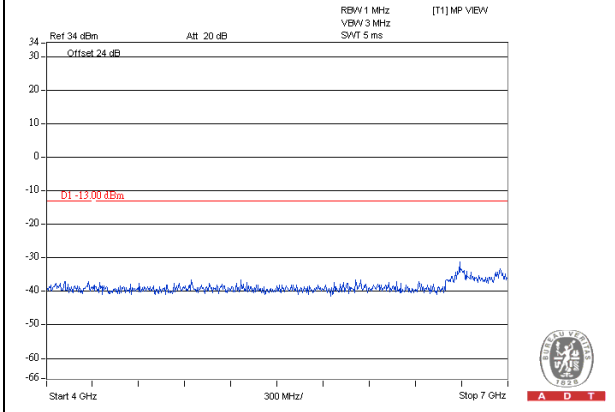

Frequency Range : 7GHz~9GHz

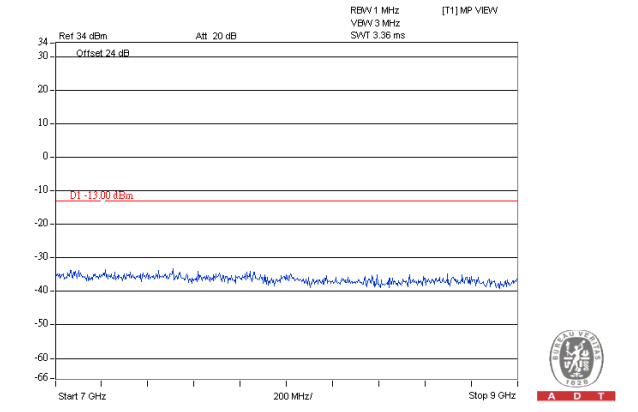

WCDMA

Channel 4233

Frequency Range : 9kHz~1GHz Frequency Range : 1GHz~4GHz

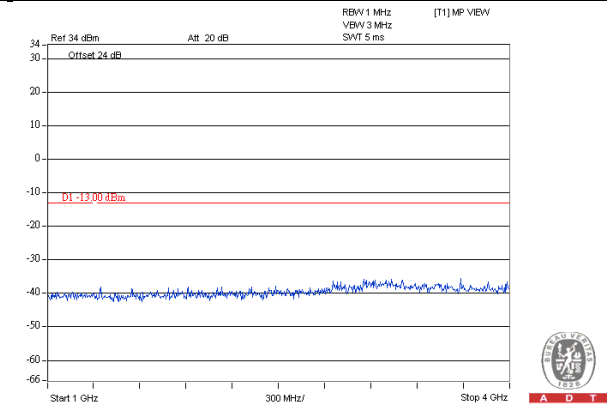
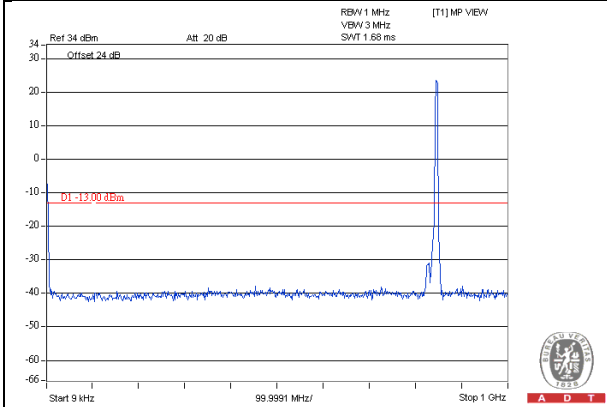

Frequency Range : 4GHz~7GHz Frequency Range : 7GHz~9GHz

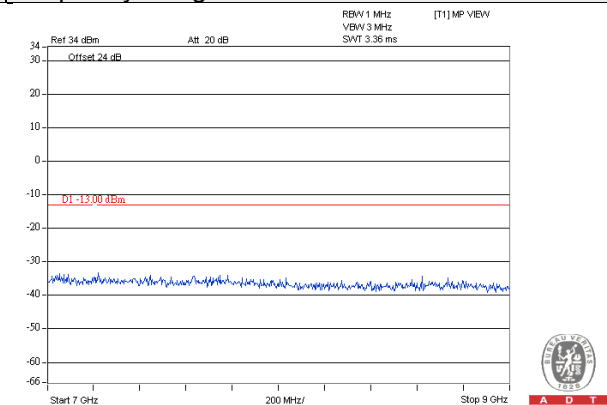
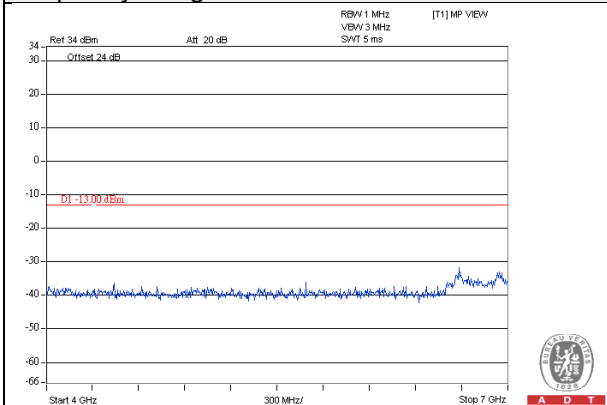

HSDPA
Channel 4132
Frequency Range : 9kHz~1GHz **Frequency Range : 1GHz~4GHz**

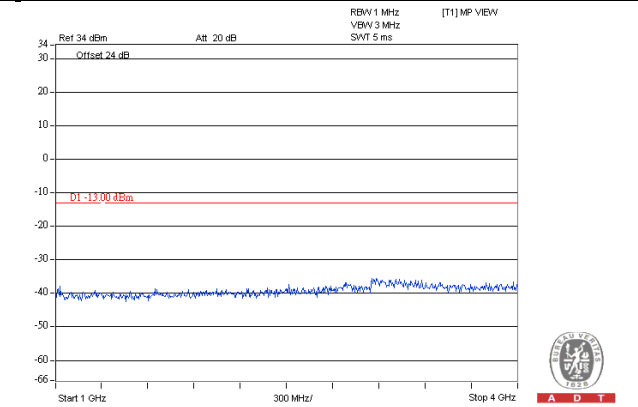
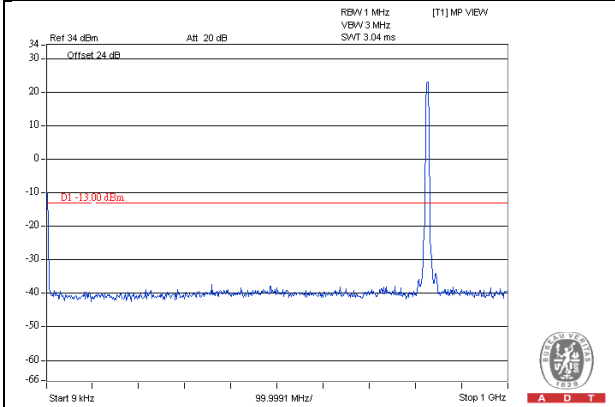

Frequency Range : 4GHz~7GHz **Frequency Range : 7GHz~9GHz**

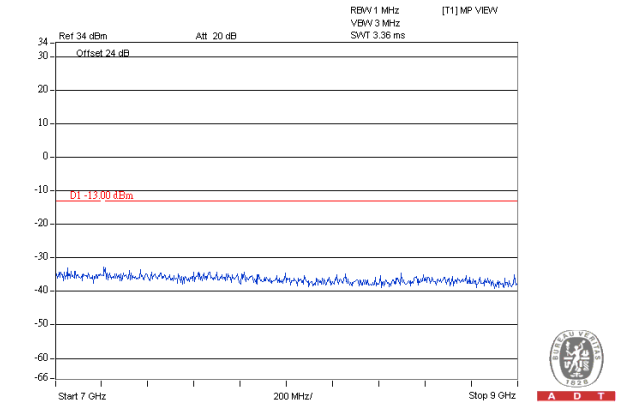
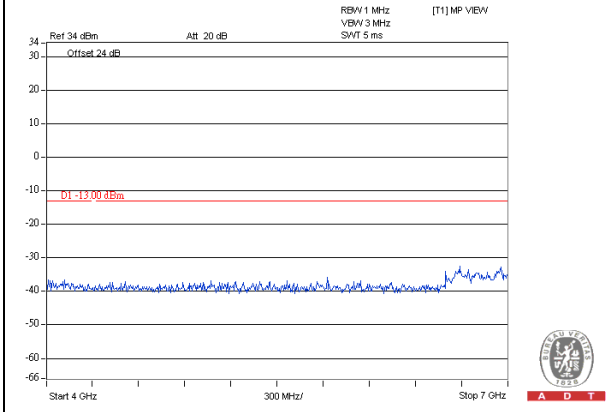

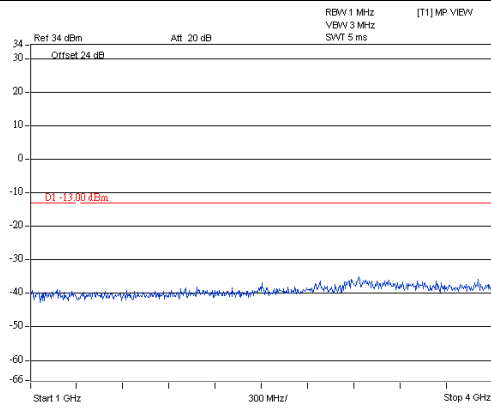
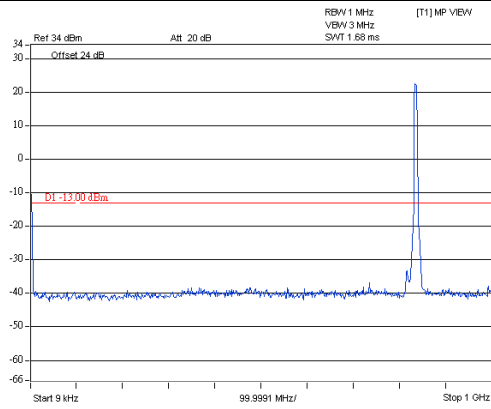
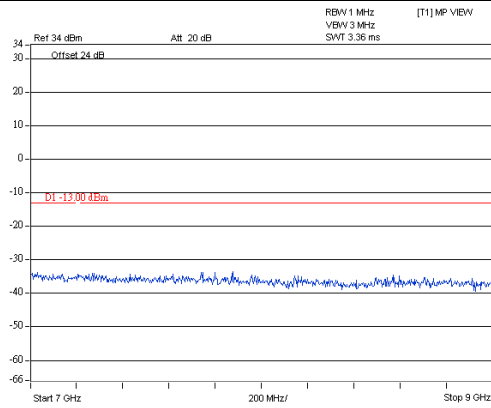
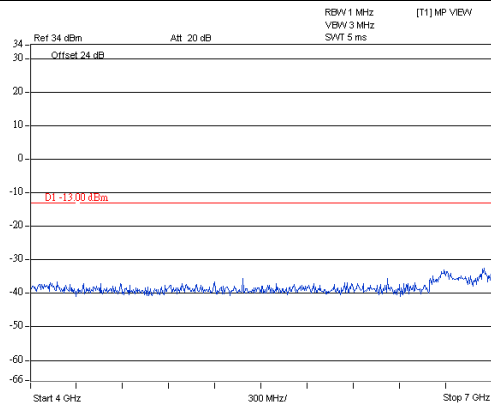
HSDPA**Channel 4182****Frequency Range : 9kHz~1GHz****Frequency Range : 1GHz~4GHz****Frequency Range : 4GHz~7GHz****Frequency Range : 7GHz~9GHz**

HSDPA
Channel 4233
Frequency Range : 9kHz~1GHz **Frequency Range : 1GHz~4GHz**

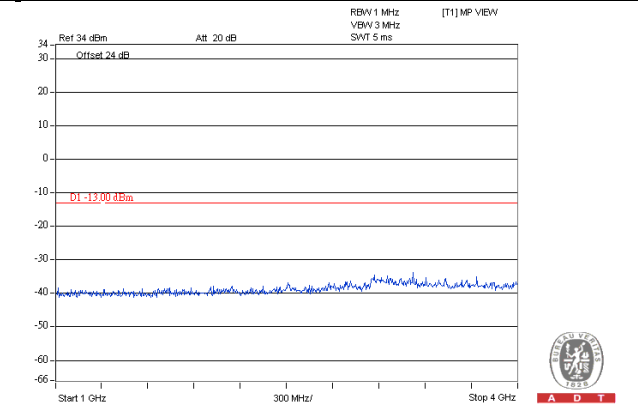
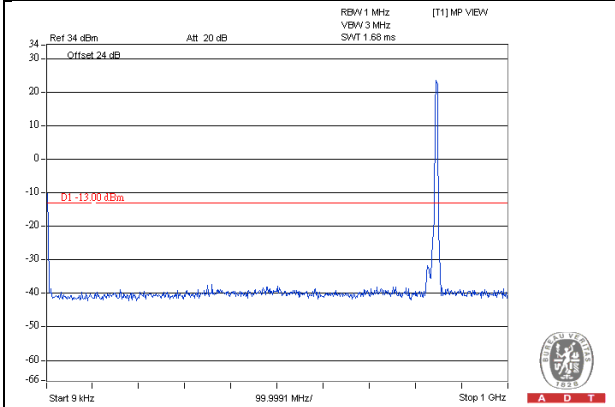

Frequency Range : 4GHz~7GHz **Frequency Range : 7GHz~9GHz**

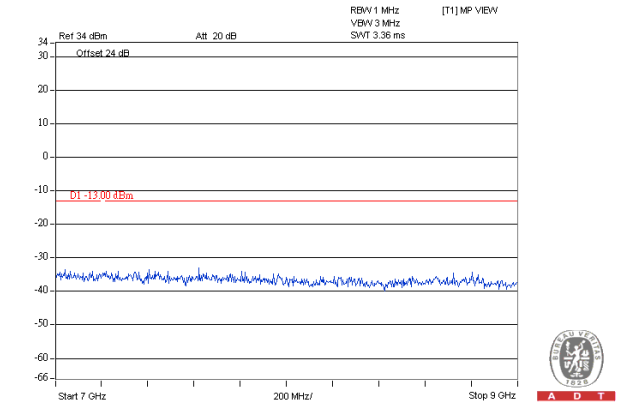
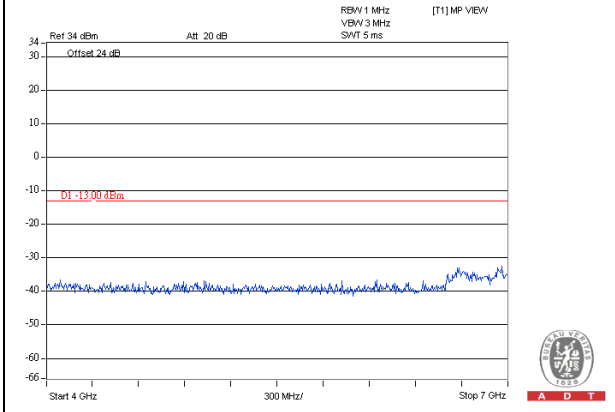

HSUPA
Channel 4132
Frequency Range : 9kHz~1GHz **Frequency Range : 1GHz~4GHz**

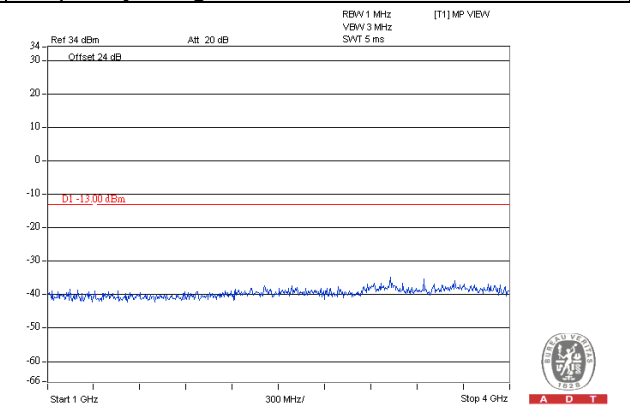
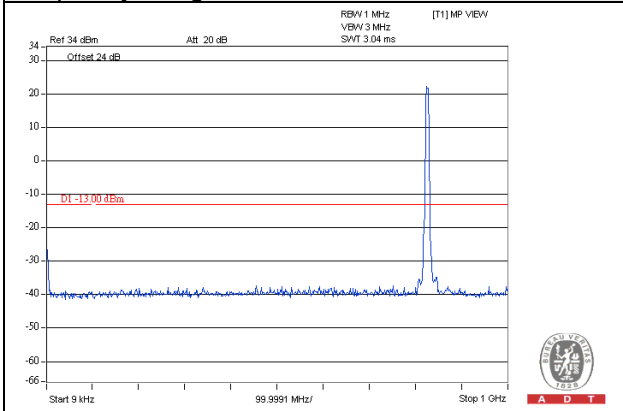

Frequency Range : 4GHz~7GHz **Frequency Range : 7GHz~9GHz**

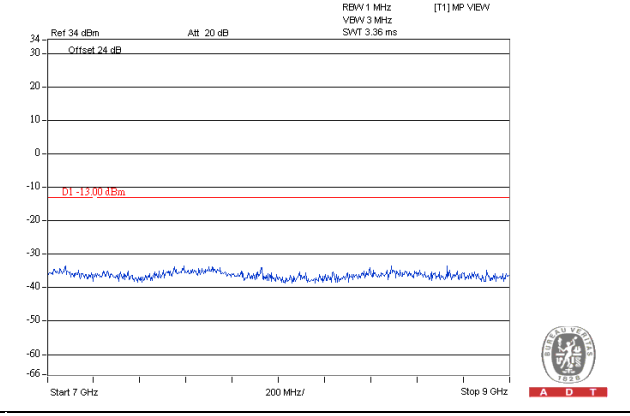
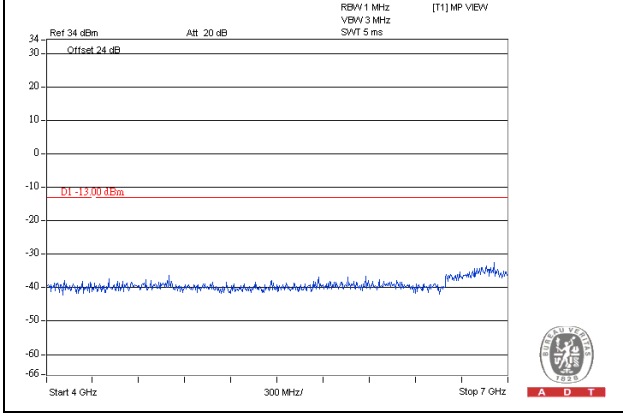

HSUPA
Channel 4182
Frequency Range : 9kHz~1GHz **Frequency Range : 1GHz~4GHz**

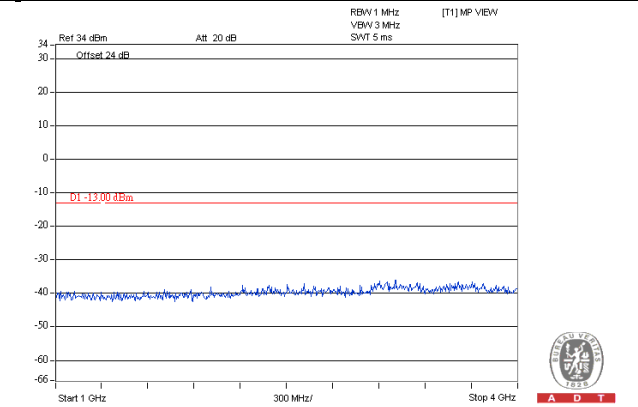
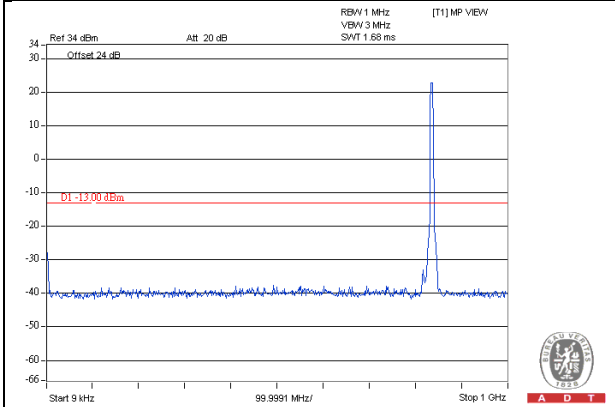

Frequency Range : 4GHz~7GHz

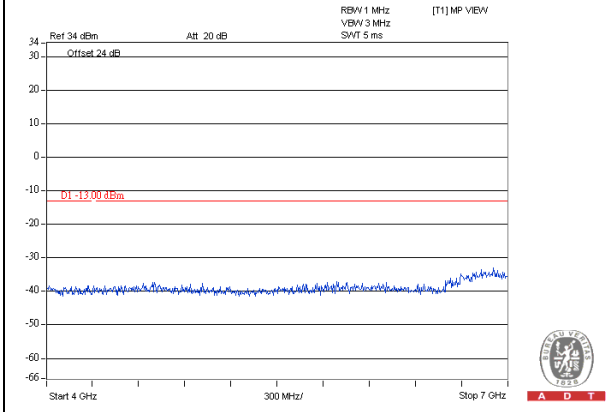

Frequency Range : 7GHz~9GHz

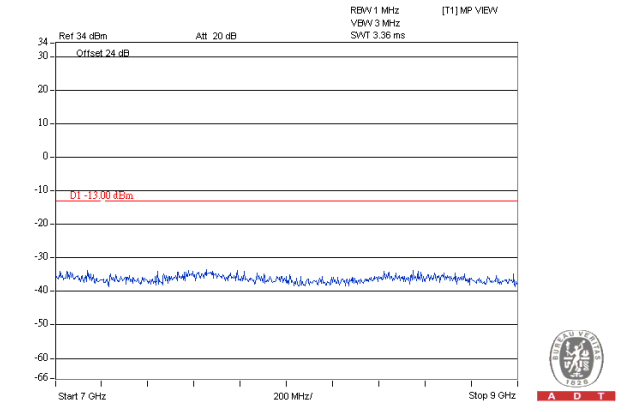

HSUPA
Channel 4233
Frequency Range : 9kHz~1GHz **Frequency Range : 1GHz~4GHz**

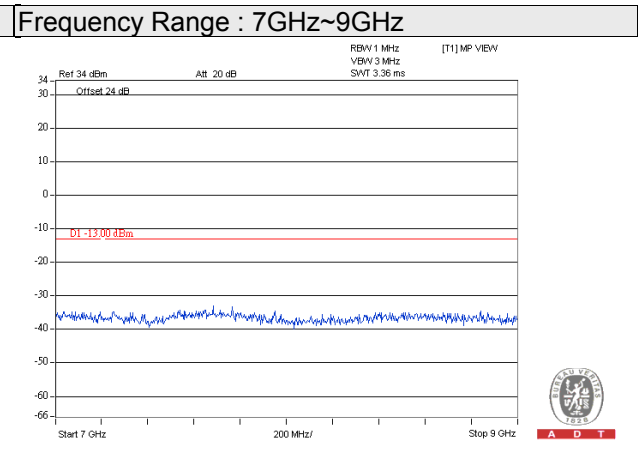
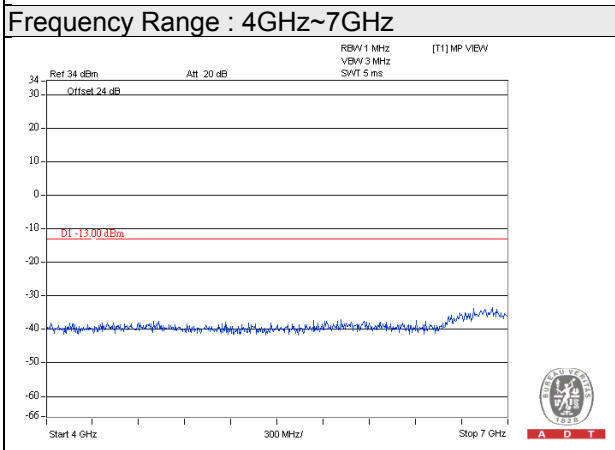
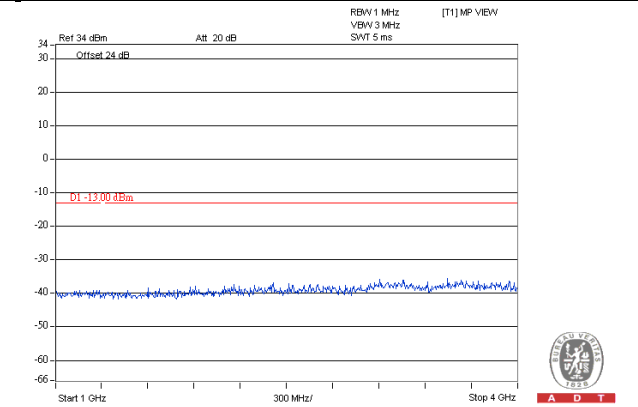
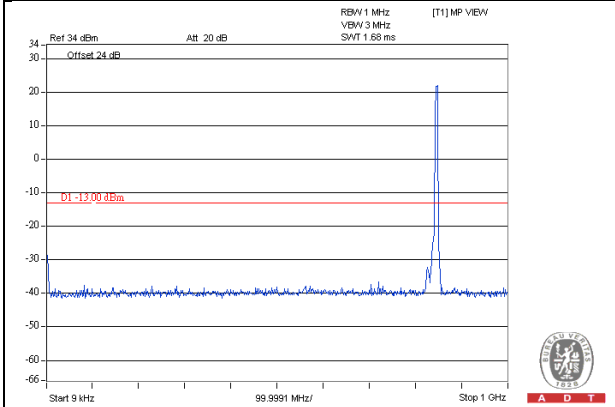

4.7 Radiated Emission Measurement

4.7.1 Limits of Radiated Emission Measurement

The power of any emission outside of the authorized operating frequency ranges must be attenuated below the transmitting power (P) by a factor of at least $43 + 10 \log(P)$ dB. The emission limit equal to -13dBm .

4.7.2 Test Procedure

- a. Substitution method is used for E.I.R.P measurement. In the semi-anechoic chamber, EUT placed on the 0.8m height of Turn Table, rotated the table around 360 degrees to search the maximum radiation power and receiver antenna shall be rotated vertical and horizontal polarization and moved height from 1m to 4m to find the maximum polar radiated power. The "Read Value" is the spectrum reading the maximum power value.
- b. The substitution horn antenna is substituted for EUT at the same position and signals generator export the CW signal to the substitution antenna via a TX cable. Rotated the Turn Table and moved receiving antenna to find the maximum radiation power. Adjust output power level of S.G to get a Value of spectrum reading equal to "Read Value " of step a. Record the power level of S.G
- c. $\text{EIRP} = \text{Output power level of S.G} - \text{TX cable loss} + \text{Antenna gain of substitution horn}$.
- d. E.R.P power can be calculated form E.I.R.P power by subtracting the gain of dipole, $\text{E.R.P power} = \text{E.I.R.P power} - 2.15\text{dBi}$.

NOTE: The resolution bandwidth and video bandwidth of test receiver/spectrum analyzer is 1MHz/3MHz.

4.7.3 Deviation from Test Standard

No deviation.

4.7.4 Test Setup

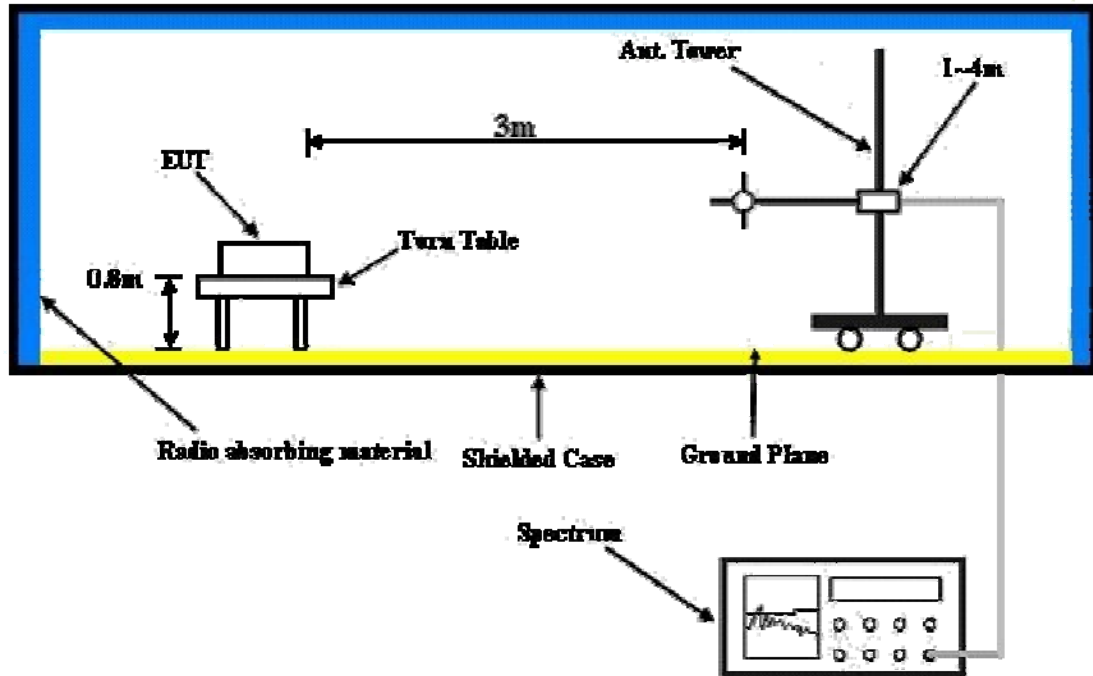

For the actual test configuration, please refer to the attached file (Test Setup Photo).

4.7.5 Test Results

BELOW 1GHz

GPRS:

Mode	TX channel 128	Frequency Range	Below 1000 MHz
Environmental Conditions	25deg. C, 65%RH	Input Power	120Vac, 60Hz
Tested By	Chris Lin		

Antenna Polarity & Test Distance: Horizontal at 3 M

No.	Freq. (MHz)	Reading (dBm)	S.G Power Value (dBm)	Correction Factor (dB)	ERP (dBm)	Limit (dBm)	Margin (dB)
1	41.64	-46.05	-34.63	-10.62	-45.25	-13.00	-32.25
2	231.76	-60.56	-76.41	5.42	-70.99	-13.00	-57.99
3	392.78	-68.74	-77.19	5.25	-71.94	-13.00	-58.94
4	619.76	-68.64	-74.44	4.60	-69.84	-13.00	-56.84
5	833.16	-65.82	-66.17	3.98	-62.19	-13.00	-49.19
6	939.86	-62.88	-61.84	3.93	-57.91	-13.00	-44.91

Antenna Polarity & Test Distance: Vertical at 3 M

No.	Freq. (MHz)	Reading (dBm)	S.G Power Value (dBm)	Correction Factor (dB)	ERP (dBm)	Limit (dBm)	Margin (dB)
1	43.58	-33.08	-31.16	-10.30	-41.46	-13.00	-28.46
2	144.46	-61.71	-66.59	-0.25	-66.84	-13.00	-53.84
3	243.40	-63.84	-71.62	5.40	-66.22	-13.00	-53.22
4	381.14	-61.20	-69.91	5.25	-64.66	-13.00	-51.66
5	734.22	-65.82	-67.23	4.82	-62.41	-13.00	-49.41
6	937.92	-66.37	-63.64	3.92	-59.72	-13.00	-46.72

Remarks:

1. Output Power (dBm) = S.G Value (dBm) + Correction Factor (dB).
2. Correction Factor (dB) = Substitution Antenna Gain (dB) + Cable Loss (dB).



WCDMA:

Mode	TX channel 4132	Frequency Range	Below 1000 MHz
Environmental Conditions	22deg. C, 71%RH	Input Power	120Vac, 60 Hz
Tested By	Chris Lin		

Antenna Polarity & Test Distance: Horizontal at 3 M

No.	Freq. (MHz)	Reading (dBm)	S.G Power Value (dBm)	Correction Factor (dB)	ERP (dBm)	Limit (dBm)	Margin (dB)
1	43.58	-49.78	-39.15	-10.30	-49.45	-13.00	-36.45
2	138.64	-57.73	-65.79	-0.30	-66.09	-13.00	-53.09
3	340.40	-63.09	-73.93	5.19	-68.74	-13.00	-55.74
4	520.82	-56.84	-64.71	4.80	-59.91	-13.00	-46.91
5	613.94	-59.60	-65.53	4.53	-61.00	-13.00	-48.00
6	910.76	-61.38	-60.65	3.92	-56.73	-13.00	-43.73

Antenna Polarity & Test Distance: Vertical at 3 M

No.	Freq. (MHz)	Reading (dBm)	S.G Power Value (dBm)	Correction Factor (dB)	ERP (dBm)	Limit (dBm)	Margin (dB)
1	47.46	-34.50	-32.49	-10.16	-42.65	-13.00	-29.65
2	140.58	-54.90	-60.24	-0.31	-60.55	-13.00	-47.55
3	295.78	-57.02	-65.15	5.15	-60.00	-13.00	-47.00
4	617.82	-67.61	-69.33	4.58	-64.75	-13.00	-51.75
5	792.42	-67.24	-67.22	4.12	-63.10	-13.00	-50.10
6	939.86	-63.75	-61.04	3.93	-57.11	-13.00	-44.11

Remarks:

1. Output Power (dBm) = S.G Value (dBm) + Correction Factor (dB).
2. Correction Factor (dB) = Substitution Antenna Gain (dB) + Cable Loss (dB).



ABOVE 1GHz

GPRS:

Mode	TX channel 128	Frequency Range	Above 1000MHz
Environmental Conditions	25deg. C, 65%RH	Input Power	120Vac, 60 Hz
Tested By	Chris Lin		

Antenna Polarity & Test Distance: Horizontal at 3 M

No.	Freq. (MHz)	Reading (dBm)	S.G Power Value (dBm)	Correction Factor (dB)	ERP (dBm)	Limit (dBm)	Margin (dB)
1	1648.40	-60.12	-63.37	5.48	-57.89	-13.00	-44.89

Antenna Polarity & Test Distance: Vertical at 3 M

No.	Freq. (MHz)	Reading (dBm)	S.G Power Value (dBm)	Correction Factor (dB)	ERP (dBm)	Limit (dBm)	Margin (dB)
1	1648.40	-53.14	-54.26	5.48	-48.78	-13.00	-35.78

Remarks:

1. Output Power (dBm) = S.G Value (dBm) + Correction Factor (dB).
2. Correction Factor (dB) = Substitution Antenna Gain (dB) + Cable Loss (dB).

Mode	TX channel 189	Frequency Range	Above 1000MHz
Environmental Conditions	25deg. C, 65%RH	Input Power	120Vac, 60 Hz
Tested By	Chris Lin		

Antenna Polarity & Test Distance: Horizontal at 3 M

No.	Freq. (MHz)	Reading (dBm)	S.G Power Value (dBm)	Correction Factor (dB)	ERP (dBm)	Limit (dBm)	Margin (dB)
1	1685.20	-60.31	-63.25	5.57	-57.68	-13.00	-44.68

Antenna Polarity & Test Distance: Vertical at 3 M

No.	Freq. (MHz)	Reading (dBm)	S.G Power Value (dBm)	Correction Factor (dB)	ERP (dBm)	Limit (dBm)	Margin (dB)
1	1685.20	-60.52	-61.19	5.57	-55.62	-13.00	-42.62

Remarks:

1. Output Power (dBm) = S.G Value (dBm) + Correction Factor (dB).
2. Correction Factor (dB) = Substitution Antenna Gain (dB) + Cable Loss (dB).



Mode	TX channel 251	Frequency Range	Above 1000MHz
Environmental Conditions	25deg. C, 65%RH	Input Power	120Vac, 60 Hz
Tested By	Chris Lin		

Antenna Polarity & Test Distance: Horizontal at 3 M

No.	Freq. (MHz)	Reading (dBm)	S.G Power Value (dBm)	Correction Factor (dB)	ERP (dBm)	Limit (dBm)	Margin (dB)
1	1697.60	-58.76	-61.59	5.59	-56.00	-13.00	-43.00

Antenna Polarity & Test Distance: Vertical at 3 M

No.	Freq. (MHz)	Reading (dBm)	S.G Power Value (dBm)	Correction Factor (dB)	ERP (dBm)	Limit (dBm)	Margin (dB)
1	1697.60	-50.09	-50.59	5.59	-45.00	-13.00	-32.00

Remarks:

1. Output Power (dBm) = S.G Value (dBm) + Correction Factor (dB).
2. Correction Factor (dB) = Substitution Antenna Gain (dB) + Cable Loss (dB).

WCDMA:

Mode	TX channel 4132	Frequency Range	Above 1000MHz
Environmental Conditions	25deg. C, 65%RH	Input Power	120Vac, 60 Hz
Tested By	Chris Lin		

Antenna Polarity & Test Distance: Horizontal at 3 M

No.	Freq. (MHz)	Reading (dBm)	S.G Power Value (dBm)	Correction Factor (dB)	ERP (dBm)	Limit (dBm)	Margin (dB)
1	1652.80	-59.87	-63.08	5.49	-57.59	-13.00	-44.59

Antenna Polarity & Test Distance: Vertical at 3 M

No.	Freq. (MHz)	Reading (dBm)	S.G Power Value (dBm)	Correction Factor (dB)	ERP (dBm)	Limit (dBm)	Margin (dB)
1	1652.80	-58.35	-59.41	5.49	-53.92	-13.00	-40.92

Remarks:

1. Output Power (dBm) = S.G Value (dBm) + Correction Factor (dB).
2. Correction Factor (dB) = Substitution Antenna Gain (dB) + Cable Loss (dB).

Mode	TX channel 4182	Frequency Range	Above 1000MHz
Environmental Conditions	25deg. C, 65%RH	Input Power	120Vac, 60 Hz
Tested By	Chris Lin		

Antenna Polarity & Test Distance: Horizontal at 3 M

No.	Freq. (MHz)	Reading (dBm)	S.G Power Value (dBm)	Correction Factor (dB)	ERP (dBm)	Limit (dBm)	Margin (dB)
1	1672.80	-59.34	-62.39	5.54	-56.85	-13.00	-43.85

Antenna Polarity & Test Distance: Vertical at 3 M

No.	Freq. (MHz)	Reading (dBm)	S.G Power Value (dBm)	Correction Factor (dB)	ERP (dBm)	Limit (dBm)	Margin (dB)
1	1672.80	-57.82	-58.64	5.54	-53.10	-13.00	-40.10

Remarks:

1. Output Power (dBm) = S.G Value (dBm) + Correction Factor (dB).
2. Correction Factor (dB) = Substitution Antenna Gain (dB) + Cable Loss (dB).



Mode	TX channel 4233	Frequency Range	Above 1000MHz
Environmental Conditions	25deg. C, 65%RH	Input Power	120Vac, 60 Hz
Tested By	Chris Lin		

Antenna Polarity & Test Distance: Horizontal at 3 M

No.	Freq. (MHz)	Reading (dBm)	S.G Power Value (dBm)	Correction Factor (dB)	ERP (dBm)	Limit (dBm)	Margin (dB)
1	1693.20	-60.22	-63.10	5.59	-57.51	-13.00	-44.51

Antenna Polarity & Test Distance: Vertical at 3 M

No.	Freq. (MHz)	Reading (dBm)	S.G Power Value (dBm)	Correction Factor (dB)	ERP (dBm)	Limit (dBm)	Margin (dB)
1	1693.20	-57.95	-58.52	5.59	-52.93	-13.00	-39.93

Remarks:

1. Output Power (dBm) = S.G Value (dBm) + Correction Factor (dB).
2. Correction Factor (dB) = Substitution Antenna Gain (dB) + Cable Loss (dB).

5 Pictures of Test Arrangements

Please refer to the attached file (Test Setup Photo).

Appendix – Information on the Testing Laboratories

We, Bureau Veritas Consumer Products Services (H.K.) Ltd., Taoyuan Branch, were founded in 1988 to provide our best service in EMC, Radio, Telecom and Safety consultation. Our laboratories are accredited and approved according to ISO/IEC 17025.

If you have any comments, please feel free to contact us at the following:

Linko EMC/RF Lab

Tel: 886-2-26052180

Fax: 886-2-26051924

Hsin Chu EMC/RF Lab/Telecom Lab

Tel: 886-3-5935343

Fax: 886-3-5935342

Hwa Ya EMC/RF/Safety

Tel: 886-3-3183232

Fax: 886-3-3270892

Email: service.adt@tw.bureauveritas.com

Web Site: www.bureauveritas-adt.com

The address and road map of all our labs can be found in our web site also.

--- END ---