



# FCC TEST REPORT (WLAN)

**REPORT NO.:** RF150114C11-3

**MODEL NO.:** PA-MR04LN

**FCC ID:** 2AA5WPAMR04LN

**RECEIVED:** Jan. 14, 2015

**TESTED:** Jan. 16 ~ Feb. 10, 2015

**ISSUED:** Mar. 02, 2015

**APPLICANT:** NEC Platforms, Ltd.

**ADDRESS:** 800, Shimomata, Kakegawa-shi, Shizuoka  
436-8501, Japan

**ISSUED BY:** Bureau Veritas Consumer Products Services (H.K.)  
Ltd., Taoyuan Branch

**LAB ADDRESS:** No. 47-2, 14th Ling, Chia Pau Vil., Lin Kou Dist.,  
New Taipei City, Taiwan, R.O.C.

**TEST LOCATION:** No.19, Hwa Ya 2nd Rd., Wen Hwa Vil., Kwei Shan  
Dist., Taoyuan City 33383, TAIWAN (R.O.C.)

This report should not be used by the client to claim product certification, approval, or endorsement by TAF or any government agencies.



This report is for your exclusive use. Any copying or replication of this report to or for any other person or entity, or use of our name or trademark, is permitted only with our prior written permission. This report sets forth our findings solely with respect to the test samples identified herein. The results set forth in this report are not indicative or representative of the quality or characteristics of the lot from which a test sample was taken or any similar or identical product unless specifically and expressly noted. Our report includes all of the tests requested by you and the results thereof based upon the information that you provided to us. You have 60 days from date of issuance of this report to notify us of any material error or omission caused by our negligence, provided, however, that such notice shall be in writing and shall specifically address the issue you wish to raise. A failure to raise such issue within the prescribed time shall constitute your unqualified acceptance of the completeness of this report, the tests conducted and the correctness of the report contents. Unless specific mention, the uncertainty of measurement has been explicitly taken into account to declare the compliance or non-compliance to the specification.



A D T

## TABLE OF CONTENTS

RELEASE CONTROL RECORD .....	4
1. CERTIFICATION.....	5
2. SUMMARY OF TEST RESULTS .....	6
2.1 MEASUREMENT UNCERTAINTY .....	6
3. GENERAL INFORMATION.....	7
3.1 GENERAL DESCRIPTION OF EUT.....	7
3.2 DESCRIPTION OF TEST MODES.....	9
3.2.1 TEST MODE APPLICABILITY AND TESTED CHANNEL DETAIL.....	10
3.3 DUTY CYCLE OF TEST SIGNAL.....	12
3.4 DESCRIPTION OF SUPPORT UNITS.....	13
3.4.1 CONFIGURATION OF SYSTEM UNDER TEST.....	13
3.5 GENERAL DESCRIPTION OF APPLIED STANDARDS.....	14
4. TEST TYPES AND RESULTS .....	15
4.1 RADIATED EMISSION AND BANDEDGE MEASUREMENT .....	15
4.1.1 LIMITS OF RADIATED EMISSION AND BANDEDGE MEASUREMENT.....	15
4.1.2 TEST INSTRUMENTS.....	16
4.1.3 TEST PROCEDURES .....	17
4.1.4 DEVIATION FROM TEST STANDARD .....	17
4.1.5 TEST SETUP.....	18
4.1.6 EUT OPERATING CONDITIONS.....	19
4.1.7 TEST RESULTS .....	20
4.2 CONDUCTED EMISSION MEASUREMENT.....	33
4.2.1 LIMITS OF CONDUCTED EMISSION MEASUREMENT .....	33
4.2.2 TEST INSTRUMENTS.....	33
4.2.3 TEST PROCEDURES .....	34
4.2.4 DEVIATION FROM TEST STANDARD .....	34
4.2.5 TEST SETUP.....	34
4.2.6 EUT OPERATING CONDITIONS.....	34
4.2.7 TEST RESULTS .....	35
4.3 6dB BANDWIDTH MEASUREMENT .....	37
4.3.1 LIMITS OF 6dB BANDWIDTH MEASUREMENT.....	37
4.3.2 TEST SETUP.....	37
4.3.3 TEST INSTRUMENTS.....	37
4.3.4 TEST PROCEDURE.....	37
4.3.5 DEVIATION FROM TEST STANDARD .....	37
4.3.6 EUT OPERATING CONDITIONS.....	37
4.3.7 TEST RESULTS .....	38
4.4 CONDUCTED OUTPUT POWER .....	40
4.4.1 LIMITS OF CONDUCTED OUTPUT POWER MEASUREMENT .....	40



A D T

4.4.2	TEST SETUP .....	40
4.4.3	TEST INSTRUMENTS.....	40
4.4.4	TEST PROCEDURES .....	40
4.4.5	DEVIATION FROM TEST STANDARD .....	41
4.4.6	EUT OPERATING CONDITIONS .....	41
4.4.7	TEST RESULTS .....	42
4.5	POWER SPECTRAL DENSITY MEASUREMENT.....	44
4.5.1	LIMITS OF POWER SPECTRAL DENSITY MEASUREMENT.....	44
4.5.2	TEST SETUP.....	44
4.5.3	TEST INSTRUMENTS.....	44
4.5.4	TEST PROCEDURE.....	44
4.5.5	DEVIATION FROM TEST STANDARD .....	44
4.5.6	EUT OPERATING CONDITION .....	45
4.5.7	TEST RESULTS .....	46
4.6	CONDUCTED OUT OF BAND EMISSION MEASUREMENT .....	48
4.6.1	LIMITS OF CONDUCTED OUT OF BAND EMISSION MEASUREMENT.....	48
4.6.2	TEST SETUP.....	48
4.6.3	TEST INSTRUMENTS.....	48
4.6.4	TEST PROCEDURE.....	49
4.6.5	DEVIATION FROM TEST STANDARD .....	49
4.6.6	EUT OPERATING CONDITION .....	49
4.6.7	TEST RESULTS .....	49
5.	PHOTOGRAPHS OF THE TEST CONFIGURATION .....	58
6.	INFORMATION ON THE TESTING LABORATORIES.....	59
7.	APPENDIX A – MODIFICATIONS RECORDERS FOR ENGINEERING CHANGES TO THE EUT BY THE LAB.....	60



## RELEASE CONTROL RECORD

ISSUE NO.	REASON FOR CHANGE	DATE ISSUED
RF150114C11-3	Original release.	Mar. 02, 2015



A D T

## 1. CERTIFICATION

**PRODUCT:** AtermMR04LN

**MODEL NO.:** PA-MR04LN

**BRAND:** NEC

**APPLICANT:** NEC Platforms, Ltd.

**TESTED:** Jan. 16 ~ Feb. 10, 2015

**TEST SAMPLE:** ENGINEERING SAMPLE

**STANDARDS:** **FCC Part 15, Subpart C (Section 15.247)**

ANSI C63.10-2009

The above equipment (model: PA-MR04LN) has been tested by **Bureau Veritas Consumer Products Services (H.K.) Ltd., Taoyuan Branch**, and found compliance with the requirement of the above standards. The test record, data evaluation & Equipment Under Test (EUT) configurations represented herein are true and accurate accounts of the measurements of the sample's EMC characteristics under the conditions specified in this report.

**PREPARED BY:** Ivy Lin , **DATE:** Mar. 02, 2015  
Ivy Lin / Specialist

**APPROVED BY:** Ken Liu , **DATE:** Mar. 02, 2015  
Ken Liu / Senior Manager

## 2. SUMMARY OF TEST RESULTS

The EUT has been tested according to the following specifications:

APPLIED STANDARD: FCC PART 15, SUBPART C (SECTION 15.247)			
STANDARD SECTION	TEST TYPE	RESULT	REMARK
15.207	AC Power Conducted Emission	PASS	Meet the requirement of limit. Minimum passing margin is -9.45dB at 1.15878MHz.
15.205 & 209	Radiated Emissions	PASS	Meet the requirement of limit. Minimum passing margin is -0.3dB at 2483.50MHz.
15.247(d)	Band Edge Measurement	PASS	Meet the requirement of limit. Minimum passing margin is -0.3dB at 2483.50MHz.
15.247(d)	Antenna Port Emission	PASS	Meet the requirement of limit.
15.247(a)(2)	6dB bandwidth	PASS	Meet the requirement of limit.
15.247(b)	Conducted power	PASS	Meet the requirement of limit.
15.247(e)	Power Spectral Density	PASS	Meet the requirement of limit.
15.203	Antenna Requirement	PASS	Antenna connector is UFL not a standard connector.

### 2.1 MEASUREMENT UNCERTAINTY

Where relevant, the following measurement uncertainty levels have been estimated for tests performed on the EUT as specified in CISPR 16-4-2:

MEASUREMENT	FREQUENCY	UNCERTAINTY
Conducted emissions	150kHz~30MHz	2.44 dB
Radiated emissions	30MHz ~ 200MHz	3.59 dB
	200MHz ~1000MHz	3.60 dB
	1GHz ~ 18GHz	2.29 dB
	18GHz ~ 40GHz	2.29 dB

This uncertainty represents an expanded uncertainty expressed at approximately the 95% confidence level using a coverage factor of  $k = 2$ .



### 3. GENERAL INFORMATION

#### 3.1 GENERAL DESCRIPTION OF EUT

<b>EUT</b>	AtermMR04LN
<b>MODEL NO.</b>	PA-MR04LN
<b>POWER SUPPLY</b>	5Vdc (adapter) 3.8Vdc (battery)
<b>MODULATION TYPE</b>	CCK, DQPSK, DBPSK for DSSS 64QAM, 16QAM, QPSK, BPSK for OFDM
<b>MODULATION TECHNOLOGY</b>	DSSS, OFDM
<b>TRANSFER RATE</b>	802.11b:11.0/ 5.5/ 2.0/ 1.0Mbps 802.11g: 54.0/ 48.0/ 36.0/ 24.0/ 18.0/ 12.0/ 9.0/ 6.0Mbps 802.11n: up to 300.0Mbps
<b>OPERATING FREQUENCY</b>	2412 ~ 2462MHz
<b>NUMBER OF CHANNEL</b>	11 for 802.11b, 802.11g, 802.11n (20MHz) 7 for 802.11n (40MHz)
<b>OUTPUT POWER</b>	300.617mW
<b>ANTENNA TYPE</b>	Refer to Note
<b>ANTENNA CONNECTOR</b>	Refer to Note
<b>DATA CABLE</b>	N/A
<b>I/O PORTS</b>	Refer to user's manual
<b>ACCESSORY DEVICES</b>	N/A

**NOTE:**

1. The EUT incorporates a MIMO function. Physically, the EUT provides two completed transmitters and two receivers.

<b>MODULATION MODE</b>	<b>TX FUNCTION</b>
802.11b	2TX
802.11g	2TX
802.11n (20MHz)	2TX
802.11n (40MHz)	2TX

2. The EUT uses the following antennas.

	<b>Antenna Type</b>	<b>Gain (dBi)</b>	<b>Antenna Connector</b>
Ant 1	Inverted F	-1.70	UFL
Ant 2	Inverted F	-0.15	UFL



A D T

3. The EUT uses following adapter, battery and USB cable.

<b>Adapter (Support unit only)</b>	
<b>BRAND:</b>	NEC
<b>MODEL:</b>	AL1-004001-001
<b>INPUT:</b>	100-240Vac, 50/60Hz, 140mA
<b>OUTPUT:</b>	5Vdc, 1.0A

<b>Li-ion Battery (Support unit only)</b>	
<b>BRAND:</b>	NEC
<b>MODEL:</b>	AL1-003388-001
<b>INPUT:</b>	3.8Vdc, 2300mAh

<b>USB cable (Support unit only)</b>	1.0m non-shielded cable with one core
--	---------------------------------------

4. The above EUT information is declared by manufacturer and for more detailed features description, please refer to the manufacturer's specifications or user's manual.





### 3.2 DESCRIPTION OF TEST MODES

11 channels are provided for 802.11b, 802.11g and 802.11n (20MHz):

CHANNEL	FREQUENCY	CHANNEL	FREQUENCY
1	2412MHz	7	2442MHz
2	2417MHz	8	2447MHz
3	2422MHz	9	2452MHz
4	2427MHz	10	2457MHz
5	2432MHz	11	2462MHz
6	2437MHz		

7 channels are provided for 802.11n (40MHz):

CHANNEL	FREQUENCY	CHANNEL	FREQUENCY
3	2422MHz	7	2442MHz
4	2427MHz	8	2447MHz
5	2432MHz	9	2452MHz
6	2437MHz		

### 3.2.1 TEST MODE APPLICABILITY AND TESTED CHANNEL DETAIL

EUT CONFIGURE MODE	APPLICABLE TO				DESCRIPTION
	RE≥1G	RE<1G	PLC	APCM	
-	√	√	√	√	-

Where **RE≥1G**: Radiated Emission above 1GHz      **RE<1G**: Radiated Emission below 1GHz  
**PLC**: Power Line Conducted Emission      **APCM**: Antenna Port Conducted Measurement

**NOTE:** The EUT had been pre-tested on the positioned of each 3 axis. The worst case was found when positioned on **Y-plane**.

#### **RADIATED EMISSION TEST (ABOVE 1GHz):**

- Pre-Scan has been conducted to determine the worst-case mode from all possible combinations between available modulations, data rates and antenna ports (if EUT with antenna diversity architecture).
- Following channel(s) was (were) selected for the final test as listed below.

EUT CONFIGURE MODE	MODE	AVAILABLE CHANNEL	TESTED CHANNEL	MODULATION TECHNOLOGY	MODULATION TYPE	DATA RATE (Mbps)
-	802.11b	1 to 11	1, 6, 11	DSSS	DBPSK	1.0
-	802.11g	1 to 11	1, 6, 11	OFDM	BPSK	6.0
-	802.11n (20MHz)	1 to 11	1, 6, 11	OFDM	BPSK	7.2
-	802.11n (40MHz)	3 to 9	3, 6, 9	OFDM	BPSK	15.0

#### **RADIATED EMISSION TEST (BELOW 1GHz):**

- Pre-Scan has been conducted to determine the worst-case mode from all possible combinations between available modulations, data rates and antenna ports (if EUT with antenna diversity architecture).
- Following channel(s) was (were) selected for the final test as listed below.

EUT CONFIGURE MODE	MODE	AVAILABLE CHANNEL	TESTED CHANNEL	MODULATION TECHNOLOGY	MODULATION TYPE	DATA RATE (Mbps)
-	802.11g	1 to 11	1	OFDM	BPSK	6.0

#### **POWER LINE CONDUCTED EMISSION TEST:**

- Pre-Scan has been conducted to determine the worst-case mode from all possible combinations between available modulations, data rates and antenna ports (if EUT with antenna diversity architecture).
- Following channel(s) was (were) selected for the final test as listed below.

EUT CONFIGURE MODE	MODE	AVAILABLE CHANNEL	TESTED CHANNEL	MODULATION TECHNOLOGY	MODULATION TYPE	DATA RATE (Mbps)
-	802.11g	1 to 11	1	OFDM	BPSK	6.0



**BANDEDGE MEASUREMENT:**

- Pre-Scan has been conducted to determine the worst-case mode from all possible combinations between available modulations, data rates and antenna ports (if EUT with antenna diversity architecture).
- Following channel(s) was (were) selected for the final test as listed below.

EUT CONFIGURE MODE	MODE	AVAILABLE CHANNEL	TESTED CHANNEL	MODULATION TECHNOLOGY	MODULATION TYPE	DATA RATE (Mbps)
-	802.11b	1 to 11	1, 11	DSSS	DBPSK	1.0
-	802.11g	1 to 11	1, 11	OFDM	BPSK	6.0
-	802.11n (20MHz)	1 to 11	1, 11	OFDM	BPSK	7.2
-	802.11n (40MHz)	3 to 9	3, 9	OFDM	BPSK	15.0

**ANTENNA PORT CONDUCTED MEASUREMENT:**

- This item includes all test value of each mode, but only includes spectrum plot of worst value of each mode.
- Pre-Scan has been conducted to determine the worst-case mode from all possible combinations between available modulations, data rates and antenna ports (if EUT with antenna diversity architecture).
- Following channel(s) was (were) selected for the final test as listed below.

EUT CONFIGURE MODE	MODE	AVAILABLE CHANNEL	TESTED CHANNEL	MODULATION TECHNOLOGY	MODULATION TYPE	DATA RATE (Mbps)
-	802.11b	1 to 11	1, 6, 11	DSSS	DBPSK	1.0
-	802.11g	1 to 11	1, 6, 11	OFDM	BPSK	6.0
-	802.11n (20MHz)	1 to 11	1, 6, 11	OFDM	BPSK	7.2
-	802.11n (40MHz)	3 to 9	3, 6, 9	OFDM	BPSK	15.0

**TEST CONDITION:**

APPLICABLE TO	ENVIRONMENTAL CONDITIONS	INPUT POWER	TESTED BY
RE≥1G	25deg. C, 65%RH	120Vac, 60Hz	Chris Lin
RE<1G	25deg. C, 65%RH	120Vac, 60Hz	Chris Lin
PLC	24deg. C, 65%RH	120Vac, 60Hz	Alan Wu
APCM	25deg. C, 60%RH	120Vac, 60Hz	Cedric Wu

### 3.3 DUTY CYCLE OF TEST SIGNAL

Duty cycle of test signal is > 98 %

**802.11b:** Duty cycle =  $12.430/12.575 = 0.988$

Duty cycle of test signal is < 98%

**802.11g:** Duty cycle =  $2.061/2.166 = 0.952$ , Duty factor =  $10 * \log( 1/0.952) = 0.21$

**802.11n (20MHz):** Duty cycle =  $1.922/2.036 = 0.944$ , Duty factor =  $10 * \log( 1/0.944) = 0.25$

**802.11n (40MHz):** Duty cycle =  $0.943/1.059 = 0.890$ , Duty factor =  $10 * \log( 1/0.890) = 0.51$

**802.11b**

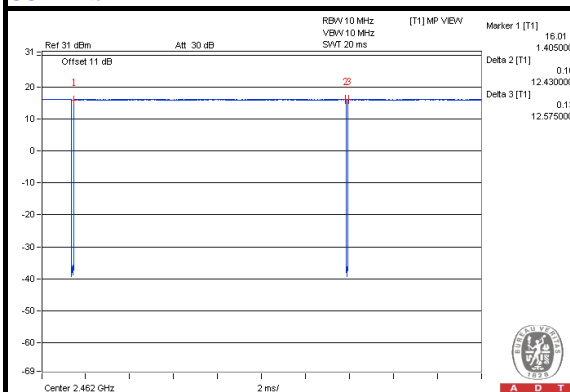

**802.11g**

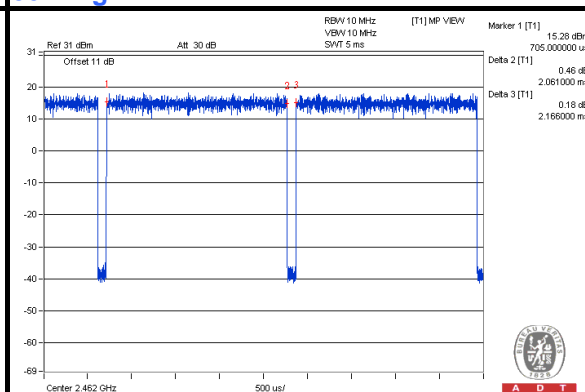

**802.11n (20MHz)**

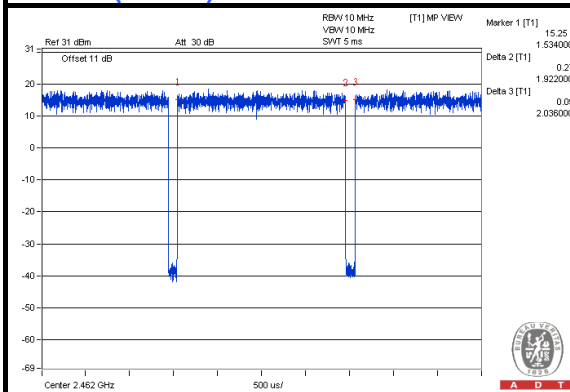

**802.11n (40MHz)**

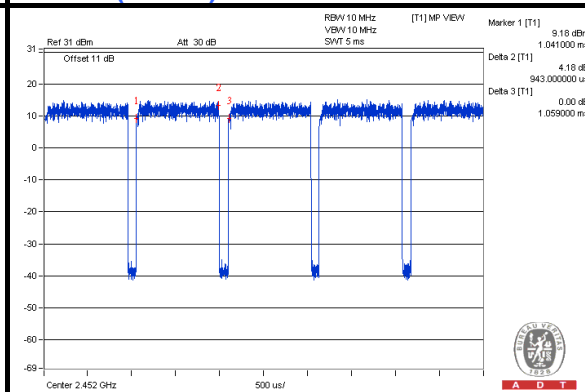

### 3.4 DESCRIPTION OF SUPPORT UNITS

The EUT has been tested as an independent unit.

#### 3.4.1 CONFIGURATION OF SYSTEM UNDER TEST

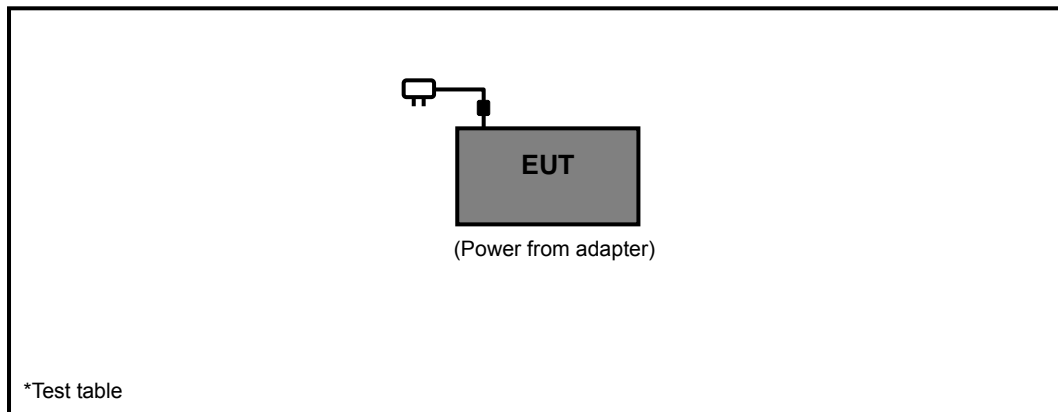



### **3.5 GENERAL DESCRIPTION OF APPLIED STANDARDS**

The EUT is a RF Product. According to the specifications of the manufacturer, it must comply with the requirements of the following standards:

**FCC Part 15, Subpart C (15.247)**

**558074 D01 DTS Meas Guidance v03r02**

**662911 D01 Multiple Transmitter Output v02r01**

**ANSI C63.10-2009**

All test items have been performed and recorded as per the above standards.

## 4. TEST TYPES AND RESULTS

### 4.1 RADIATED EMISSION AND BANDEDGE MEASUREMENT

#### 4.1.1 LIMITS OF RADIATED EMISSION AND BANDEDGE MEASUREMENT

Radiated emissions which fall in the restricted bands must comply with the radiated emission limits specified as below table. Other emissions shall be at least 20dB below the highest level of the desired power:

FREQUENCIES (MHz)	FIELD STRENGTH (microvolts/meter)	MEASUREMENT DISTANCE (meters)
0.009 ~ 0.490	2400/F(kHz)	300
0.490 ~ 1.705	24000/F(kHz)	30
1.705 ~ 30.0	30	30
30 ~ 88	100	3
88 ~ 216	150	3
216 ~ 960	200	3
Above 960	500	3

**NOTE:**

1. The lower limit shall apply at the transition frequencies.
2. Emission level (dBuV/m) = 20 log Emission level (uV/m).
3. For frequencies above 1000MHz, the field strength limits are based on average detector, however, the peak field strength of any emission shall not exceed the maximum permitted average limits, specified above by more than 20dB under any condition of modulation.



#### 4.1.2 TEST INSTRUMENTS

DESCRIPTION & MANUFACTURER	MODEL NO.	SERIAL NO.	DATE OF CALIBRATION	DUE DATE OF CALIBRATION
Test Receiver ROHDE & SCHWARZ	ESCI	100424	Oct. 06, 2014	Oct. 05, 2015
Spectrum Analyzer ROHDE & SCHWARZ	FSP40	100039	Mar. 03, 2014	Mar. 02, 2015
BILOG Antenna SCHWARZBECK	VULB9168	9168-155	Feb. 26, 2014	Feb. 25, 2015
HORN Antenna SCHWARZBECK	BBHA 9120D	9120D-1170	Aug. 26, 2014	Aug. 25, 2015
HORN Antenna SCHWARZBECK	BBHA 9170	BBHA9170241	Feb. 17, 2014	Feb. 16, 2015
Preamplifier Agilent	8449B	3008A01961	Oct. 18, 2014	Oct. 17, 2015
Preamplifier Agilent	8447D	2944A10738	Oct. 18, 2014	Oct. 17, 2015
RF signal cable HUBER+SUHNNER	SUCOFLEX 104	309220/4	Aug. 09, 2014	Aug. 08, 2015
RF signal cable HUBER+SUHNNER	SUCOFLEX 104	250724/4	Aug. 09, 2014	Aug. 08, 2015
RF signal cable HUBER+SUHNNER	SUCOFLEX 104	295012/4	Aug. 09, 2014	Aug. 08, 2015
Software BV ADT	ADT_Radiated_ V7.6.15.9.4	NA	NA	NA
Antenna Tower inn-co GmbH	MA 4000	010303	NA	NA
Antenna Tower Controller inn-co GmbH	CO2000	019303	NA	NA
Turn Table BV ADT	TT100.	TT93021704	NA	NA
Turn Table Controller BV ADT	SC100.	SC93021704	NA	NA
High Speed Peak Power Meter	ML2495A	0824011	Jul. 26, 2014	Jul. 25, 2015
Power Sensor	MA2411B	0738171	Jul. 26, 2014	Jul. 25, 2015

- NOTE:**
1. The calibration interval of the above test instruments is 12 months and the calibrations are traceable to NML/ROC and NIST/USA.
  2. The test was performed in HwaYa Chamber 4.
  3. The horn antenna and HP preamplifier (model: 8449B) are used only for the measurement of emission frequency above 1GHz if tested.
  4. The FCC Site Registration No. is 460141.
  5. The IC Site Registration No. is IC7450F-4.



#### 4.1.3 TEST PROCEDURES

- a. The EUT was placed on the top of a rotating table 0.8 meters above the ground at a 3 meters semi-anechoic chamber. The table was rotated 360 degrees to determine the position of the highest radiation.
- b. The EUT was set 3 meters away from the interference-receiving antenna, which was mounted on the top of a variable-height antenna tower.
- c. Height of receiving antenna is varied from one meter to four meters above the ground to determine the maximum value of the field strength. Both horizontal and vertical polarizations of the antenna are set to make the measurement.
- d. For each suspected emission, the EUT was arranged to its worst case and then the antenna was tuned to heights from 1 meter to 4 meters and the rotatable table was turned from 0 degrees to 360 degrees to find the maximum reading.
- e. The test-receiver system was set to Peak Detect Function and Specified Bandwidth with Maximum Hold Mode.
- f. If the emission level of the EUT in peak mode was lower than the limit specified, then testing could be stopped and the peak values of the EUT would be reported. Otherwise the emissions would be re-tested one by one using peak, quasi-peak or average method as specified and then reported in a data sheet.

**NOTE:**

1. The resolution bandwidth and video bandwidth of test receiver/spectrum analyzer is 120kHz for Quasi-peak detection at frequency below 1GHz.
2. The resolution bandwidth of test receiver/spectrum analyzer is 1MHz and video bandwidth is 3MHz for Peak detection at frequency above 1GHz.
3. The resolution bandwidth of test receiver/spectrum analyzer is 1MHz and the video bandwidth is  $\geq 1/T$  (Duty cycle < 98%) or 10Hz(Duty cycle > 98%) for Average detection (AV) at frequency above 1GHz.
4. All modes of operation were investigated and the worst-case emissions are reported.

#### 4.1.4 DEVIATION FROM TEST STANDARD

No deviation.

#### 4.1.5 TEST SETUP

##### Frequency range 30MHz~1GHz

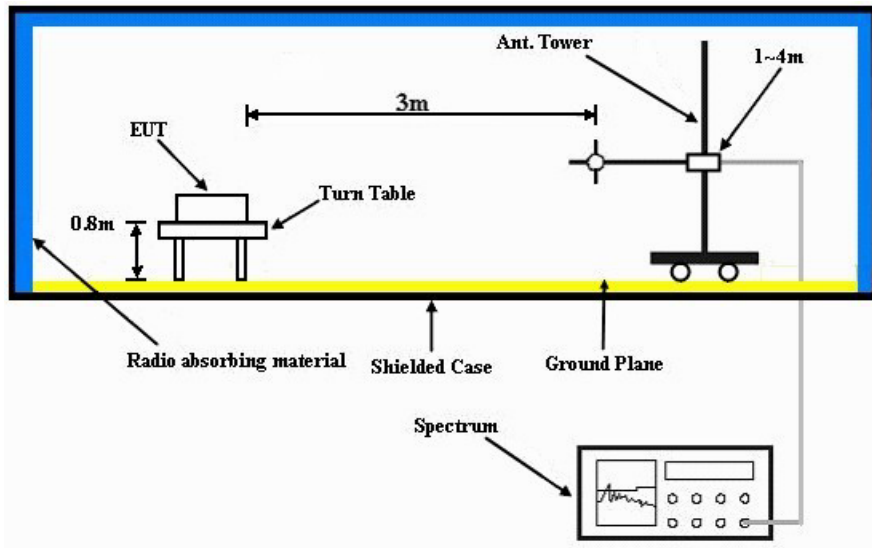

##### Frequency range above 1GHz

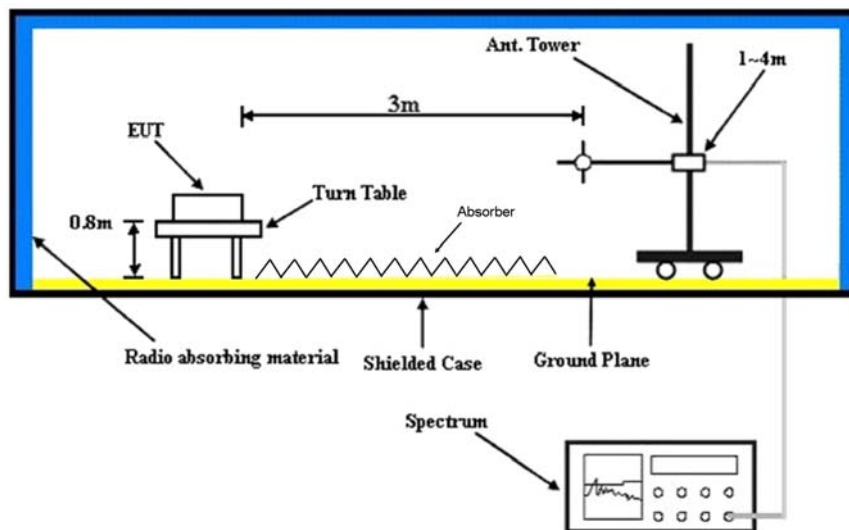

For the actual test configuration, please refer to the attached file (Test Setup Photo).



A D T

#### 4.1.6 EUT OPERATING CONDITIONS

- a. Placed the EUT on the testing table.
- b. Set the EUT under transmission condition continuously at specific channel frequency.



A D T

### 4.1.7 TEST RESULTS

#### ABOVE 1GHz DATA :

#### 802.11b

EUT TEST CONDITION		MEASUREMENT DETAIL	
CHANNEL	Channel 1	FREQUENCY RANGE	1 ~ 25GHz
INPUT POWER (SYSTEM)	120Vac, 60 Hz	DETECTOR FUNCTION	Peak (PK) Average (AV)
ENVIRONMENTAL CONDITIONS	25deg. C, 65%RH	TESTED BY	Chris Lin

ANTENNA POLARITY & TEST DISTANCE: HORIZONTAL AT 3 M								
NO.	FREQ. (MHz)	EMISSION LEVEL (dBuV/m)	LIMIT (dBuV/m)	MARGIN (dB)	ANTENNA HEIGHT (m)	TABLE ANGLE (Degree)	RAW VALUE (dBuV)	CORRECTION FACTOR (dB/m)
1	2390.00	55.7 PK	74.0	-18.3	1.15 H	196	23.50	32.20
2	2390.00	44.8 AV	54.0	-9.2	1.15 H	196	12.60	32.20
3	*2412.00	108.0 PK			1.31 H	156	75.80	32.20
4	*2412.00	104.1 AV			1.31 H	156	71.90	32.20
5	4824.00	54.8 PK	74.0	-19.2	1.51 H	59	50.00	4.80
6	4824.00	51.1 AV	54.0	-2.9	1.51 H	59	46.30	4.80
ANTENNA POLARITY & TEST DISTANCE: VERTICAL AT 3 M								
NO.	FREQ. (MHz)	EMISSION LEVEL (dBuV/m)	LIMIT (dBuV/m)	MARGIN (dB)	ANTENNA HEIGHT (m)	TABLE ANGLE (Degree)	RAW VALUE (dBuV)	CORRECTION FACTOR (dB/m)
1	2390.00	56.2 PK	74.0	-17.8	1.05 V	123	24.00	32.20
2	2390.00	45.1 AV	54.0	-8.9	1.05 V	123	12.90	32.20
3	*2412.00	101.4 PK			1.00 V	266	69.20	32.20
4	*2412.00	97.7 AV			1.00 V	266	65.50	32.20
5	4824.00	50.4 PK	74.0	-23.6	1.13 V	117	45.60	4.80
6	4824.00	45.3 AV	54.0	-8.7	1.13 V	117	40.50	4.80

#### REMARKS:

1. Emission Level(dBuV/m) = Raw Value(dBuV) + Correction Factor(dB/m)
2. Correction Factor(dB/m) = Antenna Factor(dB/m) + Cable Factor(dB)  
– Pre-Amplifier Factor(dB)
3. The other emission levels were very low against the limit.
4. Margin value = Emission Level – Limit value
5. “ \* “: Fundamental frequency.



A D T

EUT TEST CONDITION		MEASUREMENT DETAIL	
CHANNEL	Channel 6	FREQUENCY RANGE	1 ~ 25GHz
INPUT POWER (SYSTEM)	120Vac, 60 Hz	DETECTOR FUNCTION	Peak (PK) Average (AV)
ENVIRONMENTAL CONDITIONS	25deg. C, 65%RH	TESTED BY	Chris Lin

ANTENNA POLARITY & TEST DISTANCE: HORIZONTAL AT 3 M								
NO.	FREQ. (MHz)	EMISSION LEVEL (dBuV/m)	LIMIT (dBuV/m)	MARGIN (dB)	ANTENNA HEIGHT (m)	TABLE ANGLE (Degree)	RAW VALUE (dBuV)	CORRECTION FACTOR (dB/m)
1	*2437.00	107.7 PK			1.33 H	157	75.50	32.20
2	*2437.00	103.9 AV			1.33 H	157	71.70	32.20
3	4874.00	53.6 PK	74.0	-20.4	1.28 H	50	48.70	4.90
4	4874.00	50.2 AV	54.0	-3.8	1.28 H	50	45.30	4.90
ANTENNA POLARITY & TEST DISTANCE: VERTICAL AT 3 M								
NO.	FREQ. (MHz)	EMISSION LEVEL (dBuV/m)	LIMIT (dBuV/m)	MARGIN (dB)	ANTENNA HEIGHT (m)	TABLE ANGLE (Degree)	RAW VALUE (dBuV)	CORRECTION FACTOR (dB/m)
1	*2437.00	100.8 PK			1.19 V	187	68.60	32.20
2	*2437.00	97.1 AV			1.19 V	187	64.90	32.20
3	4874.00	52.4 PK	74.0	-21.6	1.24 V	116	47.50	4.90
4	4874.00	48.2 AV	54.0	-5.8	1.24 V	116	43.30	4.90

**REMARKS:**

1. Emission Level(dBuV/m) = Raw Value(dBuV) + Correction Factor(dB/m)
2. Correction Factor(dB/m) = Antenna Factor(dB/m) + Cable Factor(dB)  
– Pre-Amplifier Factor(dB)
3. The other emission levels were very low against the limit.
4. Margin value = Emission Level – Limit value
5. “ \* “: Fundamental frequency.



A D T

EUT TEST CONDITION		MEASUREMENT DETAIL	
CHANNEL	Channel 11	FREQUENCY RANGE	1 ~ 25GHz
INPUT POWER (SYSTEM)	120Vac, 60 Hz	DETECTOR FUNCTION	Peak (PK) Average (AV)
ENVIRONMENTAL CONDITIONS	25deg. C, 65%RH	TESTED BY	Chris Lin

ANTENNA POLARITY & TEST DISTANCE: HORIZONTAL AT 3 M								
NO.	FREQ. (MHz)	EMISSION LEVEL (dBuV/m)	LIMIT (dBuV/m)	MARGIN (dB)	ANTENNA HEIGHT (m)	TABLE ANGLE (Degree)	RAW VALUE (dBuV)	CORRECTION FACTOR (dB/m)
1	*2462.00	107.7 PK			1.31 H	158	75.40	32.30
2	*2462.00	104.0 AV			1.31 H	158	71.70	32.30
3	2483.50	56.8 PK	74.0	-17.2	1.35 H	168	24.40	32.40
4	2483.50	45.3 AV	54.0	-8.7	1.35 H	168	12.90	32.40
5	4924.00	52.4 PK	74.0	-21.6	1.00 H	167	47.40	5.00
6	4924.00	48.3 AV	54.0	-5.7	1.00 H	167	43.30	5.00
ANTENNA POLARITY & TEST DISTANCE: VERTICAL AT 3 M								
NO.	FREQ. (MHz)	EMISSION LEVEL (dBuV/m)	LIMIT (dBuV/m)	MARGIN (dB)	ANTENNA HEIGHT (m)	TABLE ANGLE (Degree)	RAW VALUE (dBuV)	CORRECTION FACTOR (dB/m)
1	*2462.00	101.0 PK			1.00 V	265	68.70	32.30
2	*2462.00	96.8 AV			1.00 V	265	64.50	32.30
3	2483.50	56.3 PK	74.0	-17.7	1.23 V	69	23.90	32.40
4	2483.50	45.0 AV	54.0	-9.0	1.23 V	69	12.60	32.40
5	4924.00	52.0 PK	74.0	-22.0	1.25 V	117	47.00	5.00
6	4924.00	47.9 AV	54.0	-6.1	1.25 V	117	42.90	5.00

**REMARKS:**

1. Emission Level(dBuV/m) = Raw Value(dBuV) + Correction Factor(dB/m)
2. Correction Factor(dB/m) = Antenna Factor(dB/m) + Cable Factor(dB)  
– Pre-Amplifier Factor(dB)
3. The other emission levels were very low against the limit.
4. Margin value = Emission Level – Limit value
5. “ \* “: Fundamental frequency.



A D T

802.11g

EUT TEST CONDITION		MEASUREMENT DETAIL	
CHANNEL	Channel 1	FREQUENCY RANGE	1 ~ 25GHz
INPUT POWER (SYSTEM)	120Vac, 60 Hz	DETECTOR FUNCTION	Peak (PK) Average (AV)
ENVIRONMENTAL CONDITIONS	25deg. C, 65%RH	TESTED BY	Chris Lin

**ANTENNA POLARITY & TEST DISTANCE: HORIZONTAL AT 3 M**

NO.	FREQ. (MHz)	EMISSION LEVEL (dBuV/m)	LIMIT (dBuV/m)	MARGIN (dB)	ANTENNA HEIGHT (m)	TABLE ANGLE (Degree)	RAW VALUE (dBuV)	CORRECTION FACTOR (dB/m)
1	2390.00	56.7 PK	74.0	-17.3	1.90 H	156	24.50	32.20
2	2390.00	46.8 AV	54.0	-7.2	1.90 H	156	14.60	32.20
3	*2412.00	108.6 PK			1.33 H	158	76.40	32.20
4	*2412.00	98.0 AV			1.33 H	158	65.80	32.20
5	4824.00	48.3 PK	74.0	-25.7	1.12 H	135	43.50	4.80
6	4824.00	37.0 AV	54.0	-17.0	1.12 H	135	32.20	4.80

**ANTENNA POLARITY & TEST DISTANCE: VERTICAL AT 3 M**

NO.	FREQ. (MHz)	EMISSION LEVEL (dBuV/m)	LIMIT (dBuV/m)	MARGIN (dB)	ANTENNA HEIGHT (m)	TABLE ANGLE (Degree)	RAW VALUE (dBuV)	CORRECTION FACTOR (dB/m)
1	2390.00	56.4 PK	74.0	-17.6	1.13 V	117	24.20	32.20
2	2390.00	44.4 AV	54.0	-9.6	1.13 V	117	12.20	32.20
3	*2412.00	100.6 PK			1.00 V	183	68.40	32.20
4	*2412.00	91.8 AV			1.00 V	183	59.60	32.20
5	4824.00	48.4 PK	74.0	-25.6	1.27 V	48	43.60	4.80
6	4824.00	34.9 AV	54.0	-19.1	1.27 V	48	30.10	4.80

**REMARKS:**

1. Emission Level(dBuV/m) = Raw Value(dBuV) + Correction Factor(dB/m)
2. Correction Factor(dB/m) = Antenna Factor(dB/m) + Cable Factor(dB)  
– Pre-Amplifier Factor(dB)
3. The other emission levels were very low against the limit.
4. Margin value = Emission Level – Limit value
5. “ \* “: Fundamental frequency.



A D T

EUT TEST CONDITION		MEASUREMENT DETAIL	
CHANNEL	Channel 6	FREQUENCY RANGE	1 ~ 25GHz
INPUT POWER (SYSTEM)	120Vac, 60 Hz	DETECTOR FUNCTION	Peak (PK) Average (AV)
ENVIRONMENTAL CONDITIONS	25deg. C, 65%RH	TESTED BY	Chris Lin

ANTENNA POLARITY & TEST DISTANCE: HORIZONTAL AT 3 M								
NO.	FREQ. (MHz)	EMISSION LEVEL (dBuV/m)	LIMIT (dBuV/m)	MARGIN (dB)	ANTENNA HEIGHT (m)	TABLE ANGLE (Degree)	RAW VALUE (dBuV)	CORRECTION FACTOR (dB/m)
1	*2437.00	108.1 PK			1.34 H	161	75.90	32.20
2	*2437.00	97.7 AV			1.34 H	161	65.50	32.20
3	4874.00	50.8 PK	74.0	-23.2	1.00 H	53	45.90	4.90
4	4874.00	39.6 AV	54.0	-14.4	1.00 H	53	34.70	4.90
ANTENNA POLARITY & TEST DISTANCE: VERTICAL AT 3 M								
NO.	FREQ. (MHz)	EMISSION LEVEL (dBuV/m)	LIMIT (dBuV/m)	MARGIN (dB)	ANTENNA HEIGHT (m)	TABLE ANGLE (Degree)	RAW VALUE (dBuV)	CORRECTION FACTOR (dB/m)
1	*2437.00	101.3 PK			1.00 V	273	69.10	32.20
2	*2437.00	92.0 AV			1.00 V	273	59.80	32.20
3	4874.00	50.7 PK	74.0	-23.3	1.13 V	90	45.80	4.90
4	4874.00	38.1 AV	54.0	-15.9	1.13 V	90	33.20	4.90

**REMARKS:**

- Emission Level(dBuV/m) = Raw Value(dBuV) + Correction Factor(dB/m)
- Correction Factor(dB/m) = Antenna Factor(dB/m) + Cable Factor(dB)  
– Pre-Amplifier Factor(dB)
- The other emission levels were very low against the limit.
- Margin value = Emission Level – Limit value
- \* \*: Fundamental frequency.





A D T

EUT TEST CONDITION		MEASUREMENT DETAIL	
CHANNEL	Channel 11	FREQUENCY RANGE	1 ~ 25GHz
INPUT POWER (SYSTEM)	120Vac, 60 Hz	DETECTOR FUNCTION	Peak (PK) Average (AV)
ENVIRONMENTAL CONDITIONS	25deg. C, 65%RH	TESTED BY	Chris Lin

ANTENNA POLARITY & TEST DISTANCE: HORIZONTAL AT 3 M								
NO.	FREQ. (MHz)	EMISSION LEVEL (dBuV/m)	LIMIT (dBuV/m)	MARGIN (dB)	ANTENNA HEIGHT (m)	TABLE ANGLE (Degree)	RAW VALUE (dBuV)	CORRECTION FACTOR (dB/m)
1	*2462.00	107.6 PK			1.33 H	160	75.30	32.30
2	*2462.00	96.5 AV			1.33 H	160	64.20	32.30
3	2483.50	62.6 PK	74.0	-11.4	1.29 H	319	30.20	32.40
4	2483.50	49.1 AV	54.0	-4.9	1.29 H	319	16.70	32.40
5	4924.00	48.9 PK	74.0	-25.1	1.37 H	52	43.90	5.00
6	4924.00	36.8 AV	54.0	-17.2	1.37 H	52	31.80	5.00
ANTENNA POLARITY & TEST DISTANCE: VERTICAL AT 3 M								
NO.	FREQ. (MHz)	EMISSION LEVEL (dBuV/m)	LIMIT (dBuV/m)	MARGIN (dB)	ANTENNA HEIGHT (m)	TABLE ANGLE (Degree)	RAW VALUE (dBuV)	CORRECTION FACTOR (dB/m)
1	*2462.00	101.8 PK			1.00 V	85	69.50	32.30
2	*2462.00	92.2 AV			1.00 V	85	59.90	32.30
3	2483.50	60.2 PK	74.0	-13.8	1.05 V	95	27.80	32.40
4	2483.50	47.6 AV	54.0	-6.4	1.05 V	95	15.20	32.40
5	4924.00	47.1 PK	74.0	-26.9	1.12 V	332	42.10	5.00
6	4924.00	35.6 AV	54.0	-18.4	1.12 V	332	30.60	5.00

**REMARKS:**

1. Emission Level(dBuV/m) = Raw Value(dBuV) + Correction Factor(dB/m)
2. Correction Factor(dB/m) = Antenna Factor(dB/m) + Cable Factor(dB)  
– Pre-Amplifier Factor(dB)
3. The other emission levels were very low against the limit.
4. Margin value = Emission Level – Limit value
5. “ \* “: Fundamental frequency.



A D T

802.11n (20MHz)

EUT TEST CONDITION		MEASUREMENT DETAIL	
CHANNEL	Channel 1	FREQUENCY RANGE	1 ~ 25GHz
INPUT POWER (SYSTEM)	120Vac, 60 Hz	DETECTOR FUNCTION	Peak (PK) Average (AV)
ENVIRONMENTAL CONDITIONS	25deg. C, 65%RH	TESTED BY	Chris Lin

ANTENNA POLARITY & TEST DISTANCE: HORIZONTAL AT 3 M

NO.	FREQ. (MHz)	EMISSION LEVEL (dBuV/m)	LIMIT (dBuV/m)	MARGIN (dB)	ANTENNA HEIGHT (m)	TABLE ANGLE (Degree)	RAW VALUE (dBuV)	CORRECTION FACTOR (dB/m)
1	2390.00	58.9 PK	74.0	-15.1	1.33 H	149	26.70	32.20
2	2390.00	47.9 AV	54.0	-6.1	1.33 H	149	15.70	32.20
3	*2412.00	107.6 PK			1.34 H	165	75.40	32.20
4	*2412.00	97.0 AV			1.34 H	165	64.80	32.20
5	4824.00	50.6 PK	74.0	-23.4	1.66 H	58	45.80	4.80
6	4824.00	36.6 AV	54.0	-17.4	1.66 H	58	31.80	4.80

ANTENNA POLARITY & TEST DISTANCE: VERTICAL AT 3 M

NO.	FREQ. (MHz)	EMISSION LEVEL (dBuV/m)	LIMIT (dBuV/m)	MARGIN (dB)	ANTENNA HEIGHT (m)	TABLE ANGLE (Degree)	RAW VALUE (dBuV)	CORRECTION FACTOR (dB/m)
1	2390.00	58.4 PK	74.0	-15.6	1.25 V	210	26.20	32.20
2	2390.00	45.9 AV	54.0	-8.1	1.25 V	210	13.70	32.20
3	*2412.00	101.7 PK			1.19 V	185	69.50	32.20
4	*2412.00	92.8 AV			1.19 V	185	60.60	32.20
5	4824.00	45.7 PK	74.0	-28.3	1.10 V	165	40.90	4.80
6	4824.00	34.4 AV	54.0	-19.6	1.10 V	165	29.60	4.80

REMARKS:

1. Emission Level(dBuV/m) = Raw Value(dBuV) + Correction Factor(dB/m)
2. Correction Factor(dB/m) = Antenna Factor(dB/m) + Cable Factor(dB)  
- Pre-Amplifier Factor(dB)
3. The other emission levels were very low against the limit.
4. Margin value = Emission Level – Limit value
5. “ \* “: Fundamental frequency.



A D T

EUT TEST CONDITION		MEASUREMENT DETAIL	
CHANNEL	Channel 6	FREQUENCY RANGE	1 ~ 25GHz
INPUT POWER (SYSTEM)	120Vac, 60 Hz	DETECTOR FUNCTION	Peak (PK) Average (AV)
ENVIRONMENTAL CONDITIONS	25deg. C, 65%RH	TESTED BY	Chris Lin

**ANTENNA POLARITY & TEST DISTANCE: HORIZONTAL AT 3 M**

NO.	FREQ. (MHz)	EMISSION LEVEL (dBuV/m)	LIMIT (dBuV/m)	MARGIN (dB)	ANTENNA HEIGHT (m)	TABLE ANGLE (Degree)	RAW VALUE (dBuV)	CORRECTION FACTOR (dB/m)
1	*2437.00	107.7 PK			1.34 H	159	75.50	32.20
2	*2437.00	96.8 AV			1.34 H	159	64.60	32.20
3	4874.00	53.1 PK	74.0	-20.9	1.35 H	54	48.20	4.90
4	4874.00	38.3 AV	54.0	-15.7	1.35 H	54	33.40	4.90

**ANTENNA POLARITY & TEST DISTANCE: VERTICAL AT 3 M**

NO.	FREQ. (MHz)	EMISSION LEVEL (dBuV/m)	LIMIT (dBuV/m)	MARGIN (dB)	ANTENNA HEIGHT (m)	TABLE ANGLE (Degree)	RAW VALUE (dBuV)	CORRECTION FACTOR (dB/m)
1	*2437.00	101.9 PK			1.00 V	276	69.70	32.20
2	*2437.00	91.6 AV			1.00 V	276	59.40	32.20
3	4874.00	49.4 PK	74.0	-24.6	1.37 V	110	44.50	4.90
4	4874.00	36.3 AV	54.0	-17.7	1.37 V	110	31.40	4.90

**REMARKS:**

- Emission Level(dBuV/m) = Raw Value(dBuV) + Correction Factor(dB/m)
- Correction Factor(dB/m) = Antenna Factor(dB/m) + Cable Factor(dB)  
– Pre-Amplifier Factor(dB)
- The other emission levels were very low against the limit.
- Margin value = Emission Level – Limit value
- \* \*: Fundamental frequency.



A D T

EUT TEST CONDITION		MEASUREMENT DETAIL	
CHANNEL	Channel 11	FREQUENCY RANGE	1 ~ 25GHz
INPUT POWER (SYSTEM)	120Vac, 60 Hz	DETECTOR FUNCTION	Peak (PK) Average (AV)
ENVIRONMENTAL CONDITIONS	25deg. C, 65%RH	TESTED BY	Chris Lin

ANTENNA POLARITY & TEST DISTANCE: HORIZONTAL AT 3 M								
NO.	FREQ. (MHz)	EMISSION LEVEL (dBuV/m)	LIMIT (dBuV/m)	MARGIN (dB)	ANTENNA HEIGHT (m)	TABLE ANGLE (Degree)	RAW VALUE (dBuV)	CORRECTION FACTOR (dB/m)
1	*2462.00	107.6 PK			1.33 H	160	75.30	32.30
2	*2462.00	96.6 AV			1.33 H	160	64.30	32.30
3	2483.50	64.9 PK	74.0	-9.1	1.26 H	322	32.50	32.40
4	2483.50	52.4 AV	54.0	-1.6	1.26 H	322	20.00	32.40
5	4924.00	51.2 PK	74.0	-22.8	1.52 H	55	46.20	5.00
6	4924.00	37.3 AV	54.0	-16.7	1.52 H	55	32.30	5.00
ANTENNA POLARITY & TEST DISTANCE: VERTICAL AT 3 M								
NO.	FREQ. (MHz)	EMISSION LEVEL (dBuV/m)	LIMIT (dBuV/m)	MARGIN (dB)	ANTENNA HEIGHT (m)	TABLE ANGLE (Degree)	RAW VALUE (dBuV)	CORRECTION FACTOR (dB/m)
1	*2462.00	101.2 PK			1.00 V	281	68.90	32.30
2	*2462.00	91.6 AV			1.00 V	281	59.30	32.30
3	2483.50	63.2 PK	74.0	-10.8	1.00 V	284	30.80	32.40
4	2483.50	49.5 AV	54.0	-4.5	1.00 V	284	17.10	32.40
5	4924.00	48.4 PK	74.0	-25.6	1.25 V	317	43.40	5.00
6	4924.00	35.1 AV	54.0	-18.9	1.25 V	317	30.10	5.00

**REMARKS:**

1. Emission Level(dBuV/m) = Raw Value(dBuV) + Correction Factor(dB/m)
2. Correction Factor(dB/m) = Antenna Factor(dB/m) + Cable Factor(dB)  
– Pre-Amplifier Factor(dB)
3. The other emission levels were very low against the limit.
4. Margin value = Emission Level – Limit value
5. “ \* “: Fundamental frequency.



A D T

802.11n (40MHz)

EUT TEST CONDITION		MEASUREMENT DETAIL	
CHANNEL	Channel 3	FREQUENCY RANGE	1 ~ 25GHz
INPUT POWER (SYSTEM)	120Vac, 60 Hz	DETECTOR FUNCTION	Peak (PK) Average (AV)
ENVIRONMENTAL CONDITIONS	25deg. C, 65%RH	TESTED BY	Chris Lin

ANTENNA POLARITY & TEST DISTANCE: HORIZONTAL AT 3 M

NO.	FREQ. (MHz)	EMISSION LEVEL (dBuV/m)	LIMIT (dBuV/m)	MARGIN (dB)	ANTENNA HEIGHT (m)	TABLE ANGLE (Degree)	RAW VALUE (dBuV)	CORRECTION FACTOR (dB/m)
1	2390.00	67.9 PK	74.0	-6.1	1.06 H	161	35.70	32.20
2	2390.00	52.3 AV	54.0	-1.7	1.06 H	161	20.10	32.20
3	*2422.00	105.7 PK			1.05 H	155	73.40	32.30
4	*2422.00	96.2 AV			1.05 H	155	63.90	32.30
5	4844.00	48.1 PK	74.0	-25.9	1.09 H	135	43.20	4.90
6	4844.00	36.3 AV	54.0	-17.7	1.09 H	135	31.40	4.90

ANTENNA POLARITY & TEST DISTANCE: VERTICAL AT 3 M

NO.	FREQ. (MHz)	EMISSION LEVEL (dBuV/m)	LIMIT (dBuV/m)	MARGIN (dB)	ANTENNA HEIGHT (m)	TABLE ANGLE (Degree)	RAW VALUE (dBuV)	CORRECTION FACTOR (dB/m)
1	2390.00	60.9 PK	74.0	-13.1	1.00 V	187	28.70	32.20
2	2390.00	48.2 AV	54.0	-5.8	1.00 V	187	16.00	32.20
3	*2422.00	101.0 PK			1.02 V	163	68.70	32.30
4	*2422.00	90.3 AV			1.02 V	163	58.00	32.30
5	4844.00	46.1 PK	74.0	-27.9	1.21 V	317	41.20	4.90
6	4844.00	34.6 AV	54.0	-19.4	1.21 V	317	29.70	4.90

REMARKS:

1. Emission Level(dBuV/m) = Raw Value(dBuV) + Correction Factor(dB/m)
2. Correction Factor(dB/m) = Antenna Factor(dB/m) + Cable Factor(dB)  
- Pre-Amplifier Factor(dB)
3. The other emission levels were very low against the limit.
4. Margin value = Emission Level – Limit value
5. “ \* “: Fundamental frequency.



A D T

EUT TEST CONDITION		MEASUREMENT DETAIL	
CHANNEL	Channel 6	FREQUENCY RANGE	1 ~ 25GHz
INPUT POWER (SYSTEM)	120Vac, 60 Hz	DETECTOR FUNCTION	Peak (PK) Average (AV)
ENVIRONMENTAL CONDITIONS	25deg. C, 65%RH	TESTED BY	Chris Lin

ANTENNA POLARITY & TEST DISTANCE: HORIZONTAL AT 3 M								
NO.	FREQ. (MHz)	EMISSION LEVEL (dBuV/m)	LIMIT (dBuV/m)	MARGIN (dB)	ANTENNA HEIGHT (m)	TABLE ANGLE (Degree)	RAW VALUE (dBuV)	CORRECTION FACTOR (dB/m)
1	*2437.00	105.4 PK			1.34 H	157	73.20	32.20
2	*2437.00	96.1 AV			1.34 H	157	63.90	32.20
3	4874.00	49.5 PK	74.0	-24.5	1.12 H	55	44.60	4.90
4	4874.00	37.5 AV	54.0	-16.5	1.12 H	55	32.60	4.90
ANTENNA POLARITY & TEST DISTANCE: VERTICAL AT 3 M								
NO.	FREQ. (MHz)	EMISSION LEVEL (dBuV/m)	LIMIT (dBuV/m)	MARGIN (dB)	ANTENNA HEIGHT (m)	TABLE ANGLE (Degree)	RAW VALUE (dBuV)	CORRECTION FACTOR (dB/m)
1	*2437.00	100.3 PK			1.00 V	266	68.10	32.20
2	*2437.00	90.7 AV			1.00 V	266	58.50	32.20
3	4874.00	47.6 PK	74.0	-26.4	1.12 V	311	42.70	4.90
4	4874.00	35.9 AV	54.0	-18.1	1.12 V	311	31.00	4.90

**REMARKS:**

- Emission Level(dBuV/m) = Raw Value(dBuV) + Correction Factor(dB/m)
- Correction Factor(dB/m) = Antenna Factor(dB/m) + Cable Factor(dB)  
– Pre-Amplifier Factor(dB)
- The other emission levels were very low against the limit.
- Margin value = Emission Level – Limit value
- “ \* “: Fundamental frequency.



A D T

EUT TEST CONDITION		MEASUREMENT DETAIL	
CHANNEL	Channel 9	FREQUENCY RANGE	1 ~ 25GHz
INPUT POWER (SYSTEM)	120Vac, 60 Hz	DETECTOR FUNCTION	Peak (PK) Average (AV)
ENVIRONMENTAL CONDITIONS	25deg. C, 65%RH	TESTED BY	Chris Lin

ANTENNA POLARITY & TEST DISTANCE: HORIZONTAL AT 3 M								
NO.	FREQ. (MHz)	EMISSION LEVEL (dBuV/m)	LIMIT (dBuV/m)	MARGIN (dB)	ANTENNA HEIGHT (m)	TABLE ANGLE (Degree)	RAW VALUE (dBuV)	CORRECTION FACTOR (dB/m)
1	*2452.00	105.1 PK			1.06 H	157	72.80	32.30
2	*2452.00	95.8 AV			1.06 H	157	63.50	32.30
3	2483.50	65.2 PK	74.0	-8.8	1.03 H	318	32.80	32.40
4	<b>2483.50</b>	<b>53.7 AV</b>	<b>54.0</b>	<b>-0.3</b>	<b>1.03 H</b>	<b>318</b>	<b>21.30</b>	<b>32.40</b>
5	4904.00	47.4 PK	74.0	-26.6	1.02 H	19	42.40	5.00
6	4904.00	35.2 AV	54.0	-18.8	1.02 H	19	30.20	5.00
ANTENNA POLARITY & TEST DISTANCE: VERTICAL AT 3 M								
NO.	FREQ. (MHz)	EMISSION LEVEL (dBuV/m)	LIMIT (dBuV/m)	MARGIN (dB)	ANTENNA HEIGHT (m)	TABLE ANGLE (Degree)	RAW VALUE (dBuV)	CORRECTION FACTOR (dB/m)
1	*2452.00	100.3 PK			1.00 V	277	68.00	32.30
2	*2452.00	90.0 AV			1.00 V	277	57.70	32.30
3	2483.50	65.6 PK	74.0	-8.4	1.12 V	12	33.20	32.40
4	2483.50	53.4 AV	54.0	-0.6	1.12 V	12	21.00	32.40
5	4904.00	46.6 PK	74.0	-27.4	1.17 V	41	41.60	5.00
6	4904.00	34.8 AV	54.0	-19.2	1.17 V	41	29.80	5.00

**REMARKS:**

1. Emission Level(dBuV/m) = Raw Value(dBuV) + Correction Factor(dB/m)
2. Correction Factor(dB/m) = Antenna Factor(dB/m) + Cable Factor(dB)  
– Pre-Amplifier Factor(dB)
3. The other emission levels were very low against the limit.
4. Margin value = Emission Level – Limit value
5. “ \* “: Fundamental frequency.



A D T

## BELOW 1GHz WORST-CASE DATA : 802.11g

EUT TEST CONDITION		MEASUREMENT DETAIL	
CHANNEL	Channel 1	FREQUENCY RANGE	Below 1000MHz
INPUT POWER (SYSTEM)	120Vac, 60 Hz	DETECTOR FUNCTION	Quasi-Peak
ENVIRONMENTAL CONDITIONS	25deg. C, 65%RH	TESTED BY	Chris Lin

ANTENNA POLARITY & TEST DISTANCE: HORIZONTAL AT 3 M								
NO.	FREQ. (MHz)	EMISSION LEVEL (dBuV/m)	LIMIT (dBuV/m)	MARGIN (dB)	ANTENNA HEIGHT (m)	TABLE ANGLE (Degree)	RAW VALUE (dBuV)	CORRECTION FACTOR (dB/m)
1	41.54	25.1 QP	40.0	-14.9	1.24 H	81	39.60	-14.50
2	165.73	25.3 QP	43.5	-18.2	1.99 H	6	39.00	-13.70
3	287.97	19.9 QP	46.0	-26.1	1.24 H	130	32.60	-12.70
4	431.56	23.1 QP	46.0	-22.9	1.00 H	87	33.10	-10.00
5	792.48	31.9 QP	46.0	-14.1	1.49 H	310	35.10	-3.20
6	936.07	40.2 QP	46.0	-5.8	1.00 H	216	41.00	-0.80
ANTENNA POLARITY & TEST DISTANCE: VERTICAL AT 3 M								
NO.	FREQ. (MHz)	EMISSION LEVEL (dBuV/m)	LIMIT (dBuV/m)	MARGIN (dB)	ANTENNA HEIGHT (m)	TABLE ANGLE (Degree)	RAW VALUE (dBuV)	CORRECTION FACTOR (dB/m)
1	44.56	31.1 QP	40.0	-8.9	1.07 V	5	45.30	-14.20
2	159.91	24.0 QP	43.5	-19.5	1.24 V	175	37.60	-13.60
3	431.56	31.5 QP	46.0	-14.5	1.24 V	13	41.50	-10.00
4	676.05	23.6 QP	46.0	-22.4	1.00 V	8	29.20	-5.60
5	792.48	30.9 QP	46.0	-15.1	1.24 V	265	34.10	-3.20
6	938.01	39.4 QP	46.0	-6.6	1.99 V	104	40.20	-0.80

## REMARKS:

1. Emission Level(dBuV/m) = Raw Value(dBuV) + Correction Factor(dB/m)
2. Correction Factor(dB/m) = Antenna Factor(dB/m) + Cable Factor(dB)  
– Pre-Amplifier Factor (dB)
3. The other emission levels were very low against the limit.
4. Margin value = Emission Level – Limit value



## 4.2 CONDUCTED EMISSION MEASUREMENT

### 4.2.1 LIMITS OF CONDUCTED EMISSION MEASUREMENT

FREQUENCY OF EMISSION (MHz)	CONDUCTED LIMIT (dB $\mu$ V)	
	Quasi-peak	Average
0.15 ~ 0.5	66 to 56	56 to 46
0.5 ~ 5	56	46
5 ~ 30	60	50

- NOTE:**
1. The lower limit shall apply at the transition frequencies.
  2. The limit decreases in line with the logarithm of the frequency in the range of 0.15 to 0.50MHz.
  3. All emanations from a class A/B digital device or system, including any network of conductors and apparatus connected thereto, shall not exceed the level of field strengths specified above.

### 4.2.2 TEST INSTRUMENTS

DESCRIPTION & MANUFACTURER	MODEL NO.	SERIAL NO.	DATE OF CALIBRATION	DUE DATE OF CALIBRATION
Test Receiver ROHDE & SCHWARZ	ESCS30	100289	Dec. 01, 2014	Nov. 30, 2015
RF signal cable Woken	5D-FB	Cable-HYC01-01	Dec. 26, 2014	Dec. 25, 2015
LISN ROHDE & SCHWARZ (EUT)	ESH3-Z5	835239/001	Feb. 13, 2014	Feb. 12, 2015
LISN ROHDE & SCHWARZ (Peripheral)	ESH3-Z5	100311	Jul. 21, 2014	Jul. 20, 2015
Software ADT	BV ADT_Cond_ V7.3.7.3	NA	NA	NA

- Notes:
1. The calibration interval of the above test instruments is 12 months and the calibrations are traceable to NML/ROC and NIST/USA.
  2. The test was performed in HwaYa Shielded Room 1.
  3. The VCCI Site Registration No. is C-2040.

#### 4.2.3 TEST PROCEDURES

- a. The EUT was placed 0.4 meters from the conducting wall of the shielded room with EUT being connected to the power mains through a line impedance stabilization network (LISN). Other support units were connected to the power mains through another LISN. The two LISNs provide 50 ohm/ 50uH of coupling impedance for the measuring instrument.
- b. Both lines of the power mains connected to the EUT were checked for maximum conducted interference.
- c. The frequency range from 150kHz to 30MHz was searched. Emission levels under (Limit - 20dB) was not recorded.

**NOTE:** All modes of operation were investigated and the worst-case emissions are reported.

#### 4.2.4 DEVIATION FROM TEST STANDARD

No deviation.

#### 4.2.5 TEST SETUP

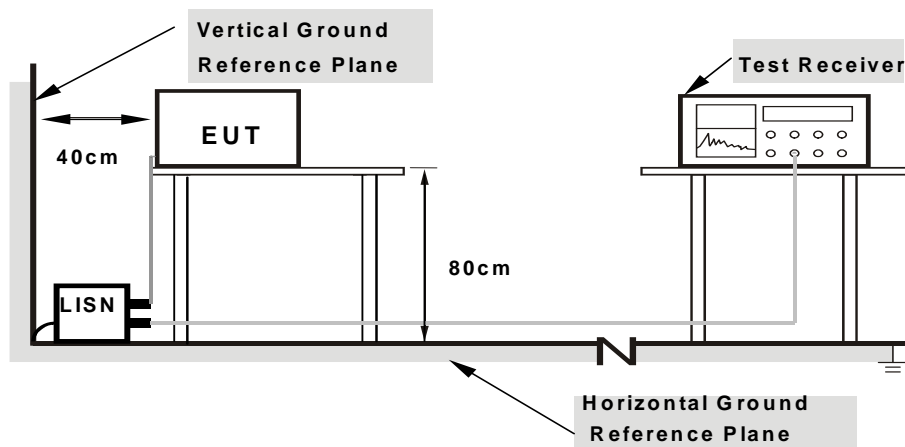

- Note:**
1. Support units were connected to second LISN.
  2. Both of LISNs (AMN) are 80 cm from EUT and at least 80 from other units and other metal planes

For the actual test configuration, please refer to the attached file (Test Setup Photo).

#### 4.2.6 EUT OPERATING CONDITIONS

Same as 4.1.6.

## 4.2.7 TEST RESULTS

### CONDUCTED WORST-CASE DATA : 802.11g

PHASE	Line 1	6dB BANDWIDTH	9kHz
-------	--------	---------------	------

No	Freq. [MHz]	Corr. Factor (dB)	Reading Value		Emission Level		Limit		Margin	
			[dB (uV)]		[dB (uV)]		[dB (uV)]		(dB)	
			Q.P.	AV.	Q.P.	AV.	Q.P.	AV.	Q.P.	AV.
1	0.79124	0.18	35.92	15.85	36.10	16.03	56.00	46.00	-19.90	-29.97
2	0.91245	0.20	40.74	21.13	40.94	21.33	56.00	46.00	-15.06	-24.67
3	0.99456	0.21	42.14	22.87	42.35	23.08	56.00	46.00	-13.65	-22.92
4	1.07276	0.21	45.75	26.42	45.96	26.63	56.00	46.00	-10.04	-19.37
5	1.15878	0.22	46.33	26.88	46.55	27.10	56.00	46.00	-9.45	-18.90
6	1.24871	0.22	46.16	26.58	46.38	26.80	56.00	46.00	-9.62	-19.20

#### REMARKS:

1. Q.P. and AV. are abbreviations of quasi-peak and average individually.
2. The emission levels of other frequencies were very low against the limit.
3. Margin value = Emission level - Limit value
4. Correction factor = Insertion loss + Cable loss
5. Emission Level = Correction Factor + Reading Value.

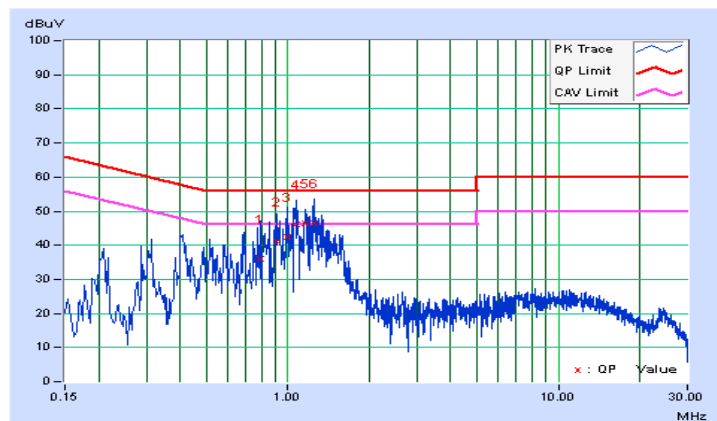

<b>PHASE</b>	Line 2	<b>6dB BANDWIDTH</b>	9kHz
--------------	--------	----------------------	------

No	Freq. [MHz]	Corr. Factor (dB)	Reading Value		Emission Level		Limit		Margin	
			[dB (uV)]		[dB (uV)]		[dB (uV)]		(dB)	
			Q.P.	AV.	Q.P.	AV.	Q.P.	AV.	Q.P.	AV.
1	0.20865	0.09	34.28	17.15	34.37	17.24	63.26	53.26	-28.89	-36.02
2	0.30640	0.13	38.25	19.55	38.38	19.68	60.07	50.07	-21.68	-30.38
3	0.41197	0.17	37.60	19.51	37.77	19.68	57.61	47.61	-19.84	-27.93
4	0.92418	0.21	34.80	16.14	35.01	16.35	56.00	46.00	-20.99	-29.65
5	1.09231	0.22	37.98	19.04	38.20	19.26	56.00	46.00	-17.80	-26.74
6	1.27217	0.22	40.06	21.42	40.28	21.64	56.00	46.00	-15.72	-24.36

**REMARKS:**

1. Q.P. and AV. are abbreviations of quasi-peak and average individually.
2. The emission levels of other frequencies were very low against the limit.
3. Margin value = Emission level - Limit value
4. Correction factor = Insertion loss + Cable loss
5. Emission Level = Correction Factor + Reading Value.

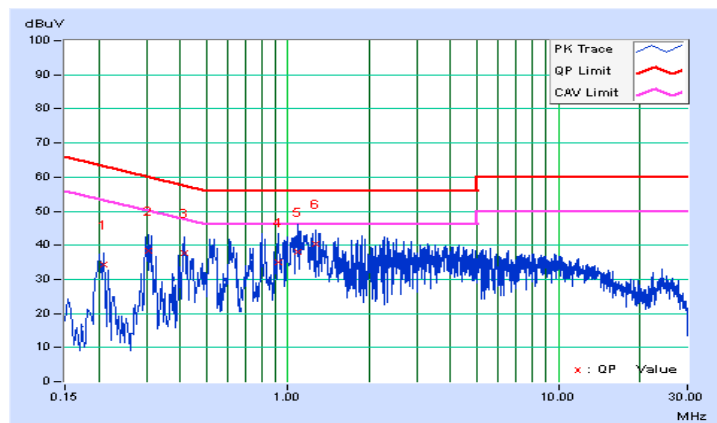

## 4.3 6dB BANDWIDTH MEASUREMENT

### 4.3.1 LIMITS OF 6dB BANDWIDTH MEASUREMENT

The minimum of 6dB Bandwidth Measurement is 0.5 MHz.

### 4.3.2 TEST SETUP

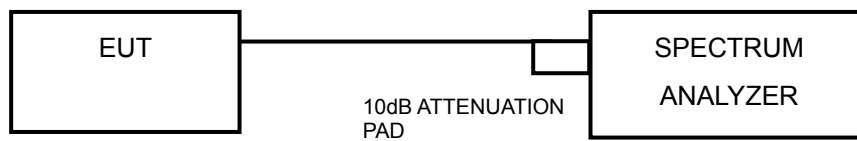

### 4.3.3 TEST INSTRUMENTS

Refer to section 4.1.2 to get information of above instrument.

### 4.3.4 TEST PROCEDURE

- a. Set resolution bandwidth (RBW) = 100kHz
- b. Set the video bandwidth (VBW)  $\geq 3 \times$  RBW, Detector = Peak.
- c. Trace mode = max hold.
- d. Sweep = auto couple.
- e. Measure the maximum width of the emission that is constrained by the frequencies associated with the two amplitude points (upper and lower) that are attenuated by 6 dB relative to the maximum level measured in the fundamental emission

### 4.3.5 DEVIATION FROM TEST STANDARD

No deviation.

### 4.3.6 EUT OPERATING CONDITIONS

The software provided by client to enable the EUT under transmission condition continuously at lowest, middle and highest channel frequencies individually.



### 4.3.7 TEST RESULTS

#### 802.11b

CHANNEL	FREQUENCY (MHz)	6dB BANDWIDTH (MHz)		MINIMUM LIMIT (MHz)	PASS / FAIL
		CHAIN 0	CHAIN 1		
1	2412	8.10	8.10	0.5	PASS
6	2437	8.10	8.10	0.5	PASS
11	2462	7.62	8.11	0.5	PASS

#### 802.11g

CHANNEL	FREQUENCY (MHz)	6dB BANDWIDTH (MHz)		MINIMUM LIMIT (MHz)	PASS / FAIL
		CHAIN 0	CHAIN 1		
1	2412	16.35	16.34	0.5	PASS
6	2437	16.08	15.98	0.5	PASS
11	2462	16.10	16.13	0.5	PASS

#### 802.11n (20MHz)

CHANNEL	FREQUENCY (MHz)	6dB BANDWIDTH (MHz)		MINIMUM LIMIT (MHz)	PASS / FAIL
		CHAIN 0	CHAIN 1		
1	2412	16.91	16.88	0.5	PASS
6	2437	16.84	16.06	0.5	PASS
11	2462	16.94	16.94	0.5	PASS

#### 802.11n (40MHz)

CHANNEL	FREQUENCY (MHz)	6dB BANDWIDTH (MHz)		MINIMUM LIMIT (MHz)	PASS / FAIL
		CHAIN 0	CHAIN 1		
3	2422	35.46	35.49	0.5	PASS
6	2437	35.28	35.18	0.5	PASS
9	2452	35.48	35.75	0.5	PASS



A D T

### SPECTRUM PLOT OF WORST VALUE

#### 802.11b

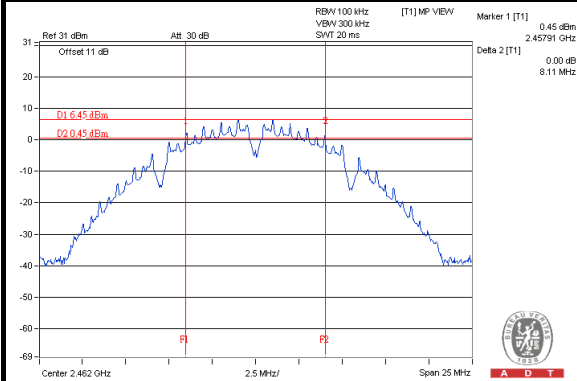

#### 802.11g

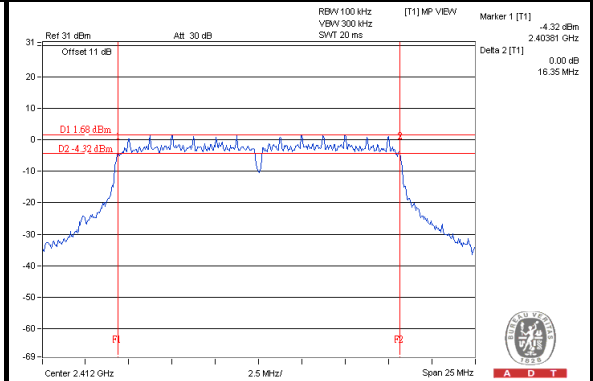

#### 802.11n (20MHz)

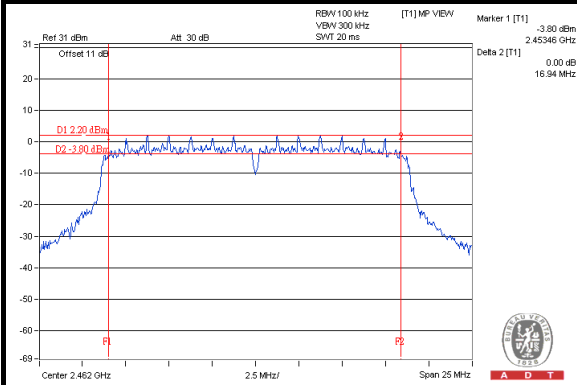

#### 802.11n (40MHz)

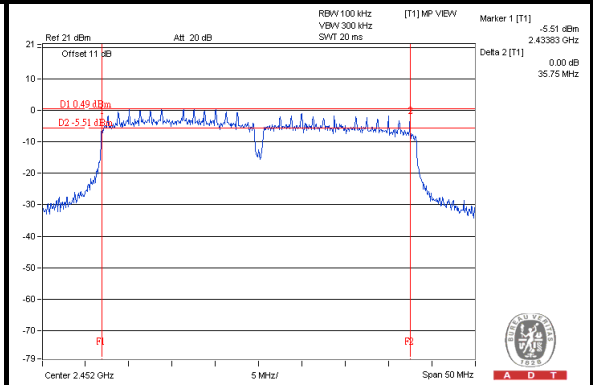

## 4.4 CONDUCTED OUTPUT POWER

### 4.4.1 LIMITS OF CONDUCTED OUTPUT POWER MEASUREMENT

For systems using digital modulation in the 2400–2483.5 MHz bands: 1 Watt (30dBm)

Per KDB 662911 D01 Multiple Transmitter Output v02r01 Method of conducted output power measurement on IEEE 802.11 devices,

Array Gain = 0 dB (i.e., no array gain) for  $NANT \leq 4$ ;

Array Gain = 0 dB (i.e., no array gain) for channel widths  $\geq 40$  MHz for any NANT;

Array Gain =  $5 \log(NANT/NSS)$  dB or 3 dB, whichever is less for 20-MHz channel widths with  $NANT \geq 5$ .

For power measurements on all other devices: Array Gain =  $10 \log(NANT/NSS)$  dB.

### 4.4.2 TEST SETUP

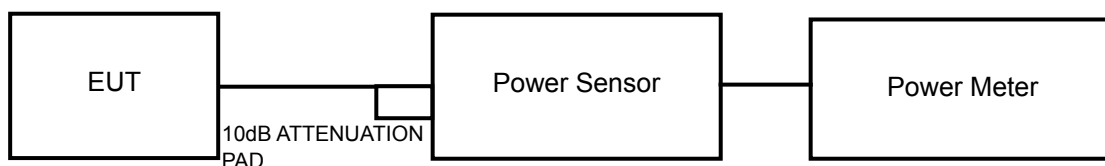

### 4.4.3 TEST INSTRUMENTS

Refer to section 4.1.2 to get information of above instrument.

### 4.4.4 TEST PROCEDURES

A peak / average power sensor was used on the output port of the EUT. A power meter was used to read the response of the peak / average power sensor. Record the power level.



#### 4.4.5 DEVIATION FROM TEST STANDARD

No deviation.

#### 4.4.6 EUT OPERATING CONDITIONS

Same as Item 4.3.6.



A D T

#### 4.4.7 TEST RESULTS

##### FOR PEAK POWER

###### 802.11b

CHAN.	FREQ. (MHz)	PEAK POWER (dBm)		TOTAL POWER (mW)	TOTAL POWER (dBm)	LIMIT (dBm)	PASS / FAIL
		CHAIN 0	CHAIN 1				
1	2412	15.01	15.28	65.425	18.16	30	PASS
6	2437	15.42	15.68	71.817	18.56	30	PASS
11	2462	15.64	15.12	69.153	18.40	30	PASS

###### 802.11g

CHAN.	FREQ. (MHz)	PEAK POWER (dBm)		TOTAL POWER (mW)	TOTAL POWER (dBm)	LIMIT (dBm)	PASS / FAIL
		CHAIN 0	CHAIN 1				
1	2412	21.28	22.21	<b>300.617</b>	24.78	30	PASS
6	2437	21.52	21.07	269.844	24.31	30	PASS
11	2462	21.47	21.28	274.557	24.39	30	PASS

###### 802.11n (20MHz)

CHAN.	FREQ. (MHz)	PEAK POWER (dBm)		TOTAL POWER (mW)	TOTAL POWER (dBm)	LIMIT (dBm)	PASS / FAIL
		CHAIN 0	CHAIN 1				
1	2412	20.92	21.48	264.20	24.22	30	PASS
6	2437	20.98	21.58	269.194	24.30	30	PASS
11	2462	21.62	21.28	279.487	24.46	30	PASS

###### 802.11n (40MHz)

CHAN.	FREQ. (MHz)	PEAK POWER (dBm)		TOTAL POWER (mW)	TOTAL POWER (dBm)	LIMIT (dBm)	PASS / FAIL
		CHAIN 0	CHAIN 1				
3	2422	21.52	21.47	282.187	24.51	30	PASS
6	2437	21.41	21.54	280.918	24.49	30	PASS
9	2452	20.44	20.62	226.007	23.54	30	PASS



A D T

## FOR AVERAGE POWER

### 802.11b

CHAN.	FREQUENCY (MHz)	AVG. POWER (dBm)		TOTAL POWER (mW)	TOTAL POWER (dBm)
		CHAIN 0	CHAIN 1		
1	2412	11.92	12.22	32.232	15.08
6	2437	12.51	12.72	36.531	15.63
11	2462	12.58	11.85	33.424	15.24

### 802.11g

CHAN.	FREQUENCY (MHz)	AVG. POWER (dBm)		TOTAL POWER (mW)	TOTAL POWER (dBm)
		CHAIN 0	CHAIN 1		
1	2412	12.41	12.85	36.693	15.65
6	2437	13.01	13.21	40.940	16.12
11	2462	13.12	12.85	39.787	16.00

### 802.11n (20MHz)

CHAN.	FREQUENCY (MHz)	AVG. POWER (dBm)		TOTAL POWER (mW)	TOTAL POWER (dBm)
		CHAIN 0	CHAIN 1		
1	2412	12.28	13.12	37.416	15.73
6	2437	12.62	13.11	38.745	15.88
11	2462	13.14	12.91	40.149	16.04

### 802.11n (40MHz)

CHAN.	FREQUENCY (MHz)	AVG. POWER (dBm)		TOTAL POWER (mW)	TOTAL POWER (dBm)
		CHAIN 0	CHAIN 1		
3	2422	12.82	12.61	37.382	15.73
6	2437	11.92	12.62	33.841	15.29
9	2452	10.82	11.75	27.040	14.32

## 4.5 POWER SPECTRAL DENSITY MEASUREMENT

### 4.5.1 LIMITS OF POWER SPECTRAL DENSITY MEASUREMENT

The Maximum of Power Spectral Density Measurement is 8dBm.

### 4.5.2 TEST SETUP

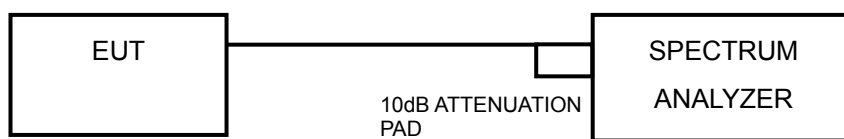

### 4.5.3 TEST INSTRUMENTS

Refer to section 4.1.2 to get information of above instrument.

### 4.5.4 TEST PROCEDURE

- a) Set analyzer center frequency to DTS channel center frequency.
- b) Set the span to 1.5 times the DTS bandwidth.
- c) Set the RBW to:  $3 \text{ kHz} \leq \text{RBW} \leq 100 \text{ kHz}$ .
- d) Set the VBW  $\geq 3 \times \text{RBW}$ .
- e) Detector = peak.
- f) Sweep time = auto couple.
- g) Trace mode = max hold.
- h) Allow trace to fully stabilize.
- i) Use the peak marker function to determine the maximum amplitude level within the RBW.

#### 4.5.5 DEVIATION FROM TEST STANDARD

No deviation.

#### 4.5.6 EUT OPERATING CONDITION

Same as Item 4.3.6

## 4.5.7 TEST RESULTS

### 802.11b

TX chain	Channel	Freq. (MHz)	PSD (dBm/3kHz)	10 log (N=2) dB	Total PSD (dBm/3kHz)	Limit (dBm/3kHz)	PASS /FAIL
0	1	2412	-12.60	3.01	-9.59	8	PASS
	6	2437	-13.13	3.01	-10.12	8	PASS
	11	2462	-11.63	3.01	-8.62	8	PASS
1	1	2412	-10.33	3.01	-7.32	8	PASS
	6	2437	-11.38	3.01	-8.37	8	PASS
	11	2462	-11.62	3.01	-8.61	8	PASS

**NOTE:** Directional gain =  $-0.15\text{dBi} + 10\log(2) = 2.86\text{dBi} < 6\text{dBi}$  , so the power density limit shall not be reduced.

### 802.11g

TX chain	Channel	Freq. (MHz)	PSD (dBm/3kHz)	10 log (N=2) dB	Total PSD (dBm/3kHz)	Limit (dBm/3kHz)	PASS /FAIL
0	1	2412	-14.74	3.01	-11.73	8	PASS
	6	2437	-15.97	3.01	-12.96	8	PASS
	11	2462	-15.35	3.01	-12.34	8	PASS
1	1	2412	-14.69	3.01	-11.68	8	PASS
	6	2437	-13.86	3.01	-10.85	8	PASS
	11	2462	-14.34	3.01	-11.33	8	PASS

**NOTE:** Directional gain =  $-0.15\text{dBi} + 10\log(2) = 2.86\text{dBi} < 6\text{dBi}$  , so the power density limit shall not be reduced.

### 802.11n (20MHz)

TX chain	Channel	Freq. (MHz)	PSD (dBm/3kHz)	10 log (N=2) dB	Total PSD (dBm/3kHz)	Limit (dBm/3kHz)	PASS /FAIL
0	1	2412	-13.81	3.01	-10.80	8	PASS
	6	2437	-15.18	3.01	-12.17	8	PASS
	11	2462	-15.14	3.01	-12.13	8	PASS
1	1	2412	-14.47	3.01	-11.46	8	PASS
	6	2437	-14.48	3.01	-11.47	8	PASS
	11	2462	-14.17	3.01	-11.16	8	PASS

**NOTE:** Directional gain =  $-0.15\text{dBi} + 10\log(2) = 2.86\text{dBi} < 6\text{dBi}$  , so the power density limit shall not be reduced.

**802.11n (40MHz)**

TX chain	Channel	Freq. (MHz)	PSD (dBm/3kHz)	10 log (N=2) dB	Total PSD (dBm/3kHz)	Limit (dBm/3kHz)	PASS /FAIL
0	3	2422	-16.36	3.01	-13.35	8	PASS
	6	2437	-17.73	3.01	-14.72	8	PASS
	9	2452	-15.83	3.01	-12.82	8	PASS
1	3	2422	-15.55	3.01	-12.54	8	PASS
	6	2437	-16.08	3.01	-13.07	8	PASS
	9	2452	-15.02	3.01	-12.01	8	PASS

**NOTE:** Directional gain =  $-0.15\text{dBi} + 10\log(2) = 2.86\text{dBi} < 6\text{dBi}$  , so the power density limit shall not be reduced.

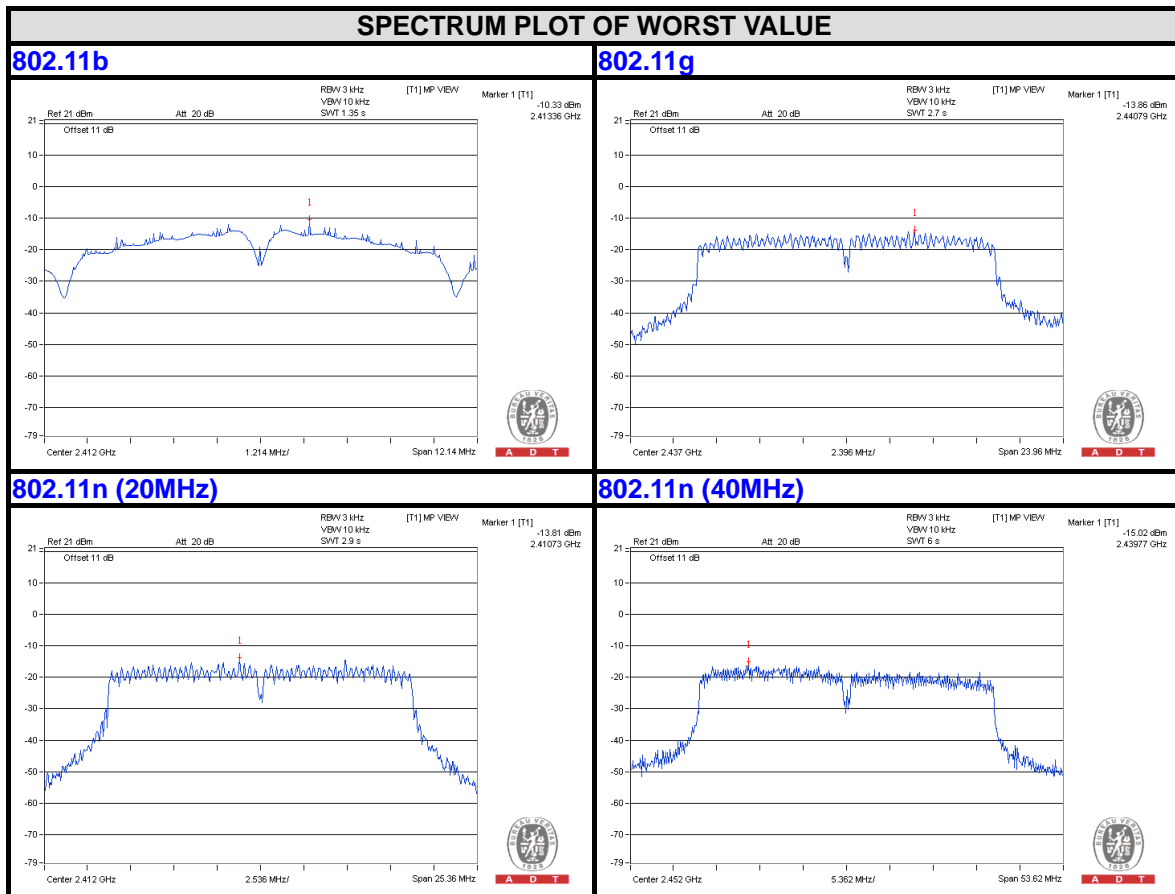

## 4.6 CONDUCTED OUT OF BAND EMISSION MEASUREMENT

### 4.6.1 LIMITS OF CONDUCTED OUT OF BAND EMISSION MEASUREMENT

Below  $-20\text{dB}$  of the highest emission level of operating band (in 100kHz Resolution Bandwidth).

### 4.6.2 TEST SETUP

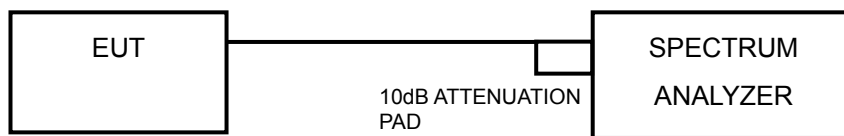

### 4.6.3 TEST INSTRUMENTS

Refer to section 4.1.2 to get information of above instrument.



#### 4.6.4 TEST PROCEDURE

##### **MEASUREMENT PROCEDURE REF**

1. Set the RBW = 100 kHz.
2. Set the VBW  $\geq$  300 kHz.
3. Detector = peak.
4. Sweep time = auto couple.
5. Trace mode = max hold.
6. Allow trace to fully stabilize.
7. Use the peak marker function to determine the maximum power level in any 100 kHz band segment within the fundamental EBW.

##### **MEASUREMENT PROCEDURE OOBE**

1. Set RBW = 100 kHz.
2. Set VBW  $\geq$  300 kHz.
3. Detector = peak.
4. Sweep = auto couple.
5. Trace Mode = max hold.
6. Allow trace to fully stabilize.
7. Use the peak marker function to determine the maximum amplitude level.

#### 4.6.5 DEVIATION FROM TEST STANDARD

No deviation.

#### 4.6.6 EUT OPERATING CONDITION

Same as Item 4.3.6

#### 4.6.7 TEST RESULTS

The conducted emission test is performed on each TX port of operating mode without summing or adding  $10\log(N)$  since the limit is relative emission limit.

The spectrum plots are attached on the following pages. D1 line indicates the highest level, and D2 line indicates the 20dB offset below D1. It shows compliance with the requirement.



A D T

### 802.11b: CHAIN 0

#### CH 1

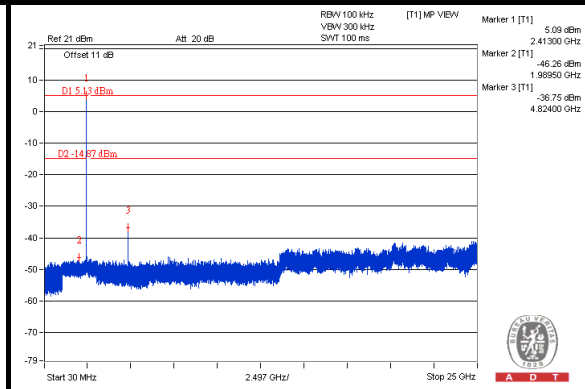
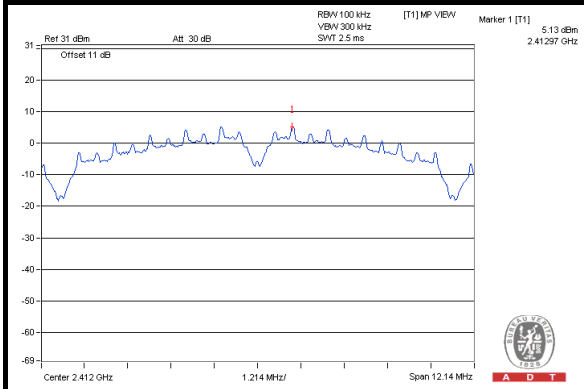

#### CH 6

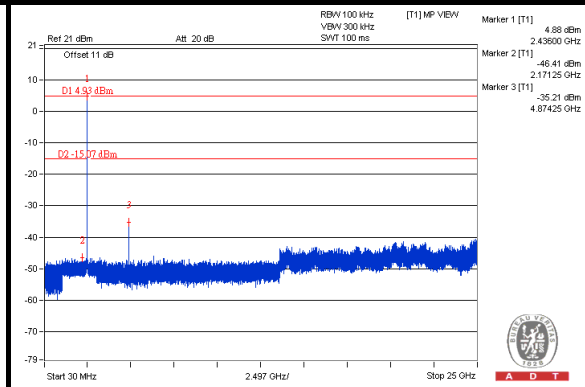
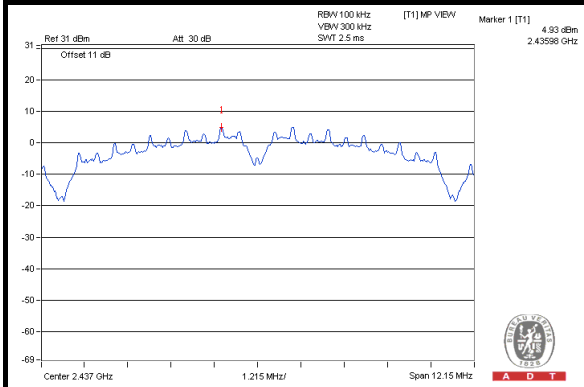

#### CH 11

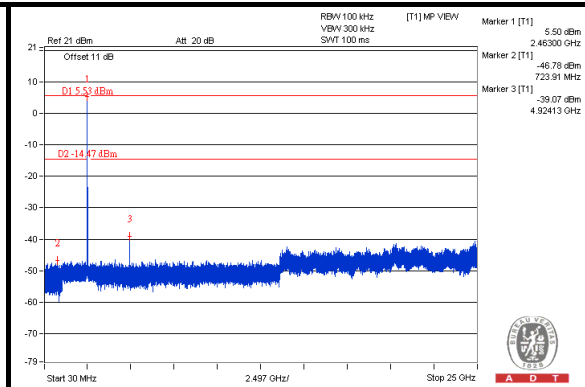
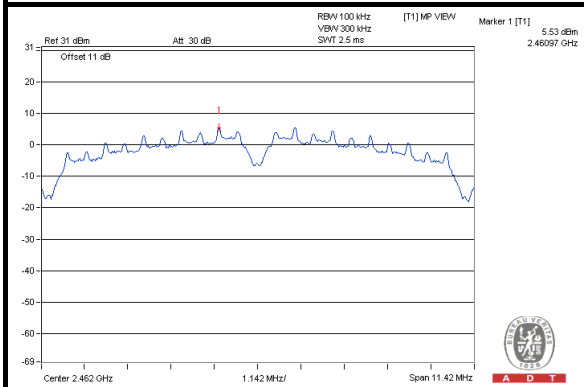

#### CH 1 Band edge

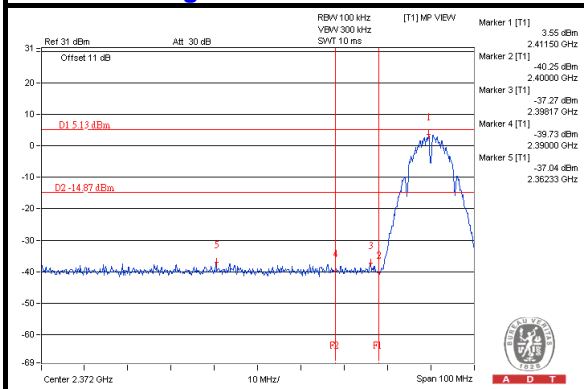

#### CH 11 Band edge

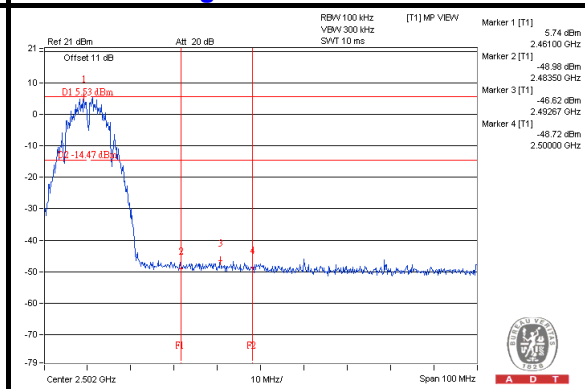



A D T

### CHAIN 1

#### CH 1

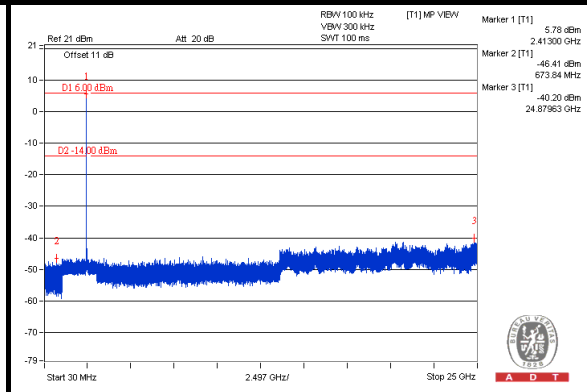
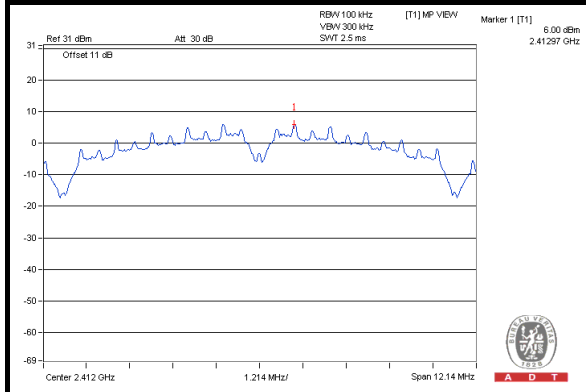

#### CH 6

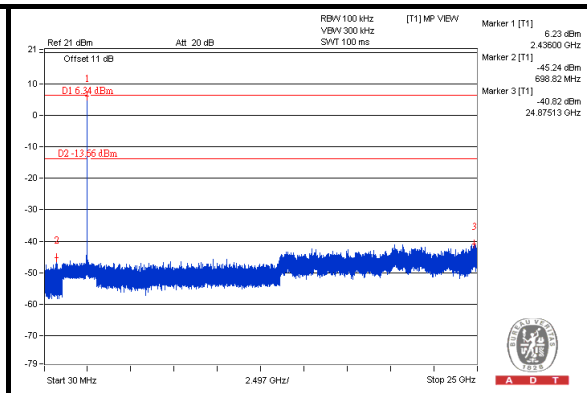
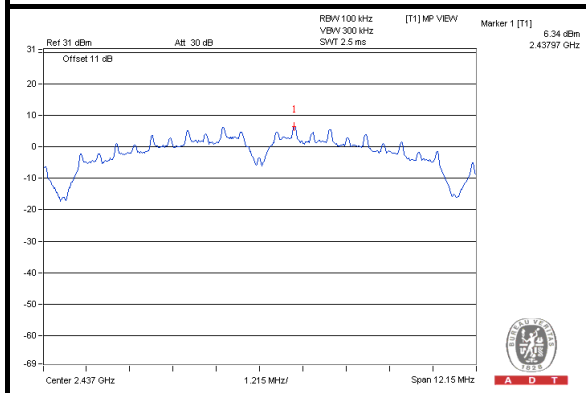

#### CH 11

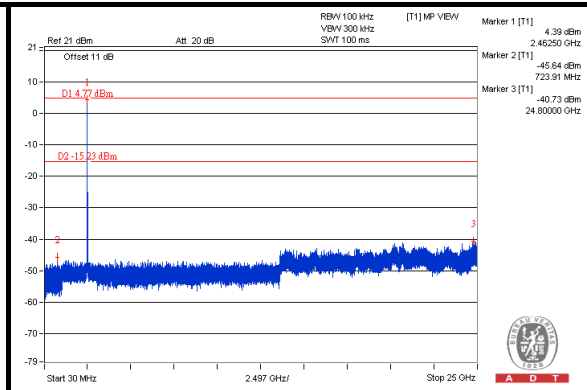
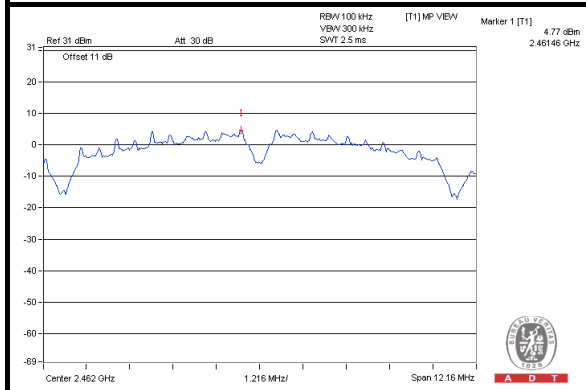

#### CH 1 Band edge

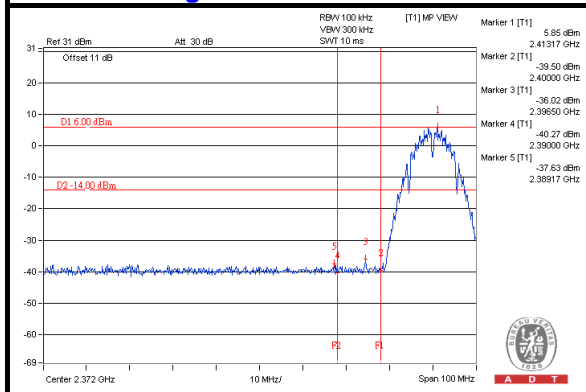

#### CH 11 Band edge

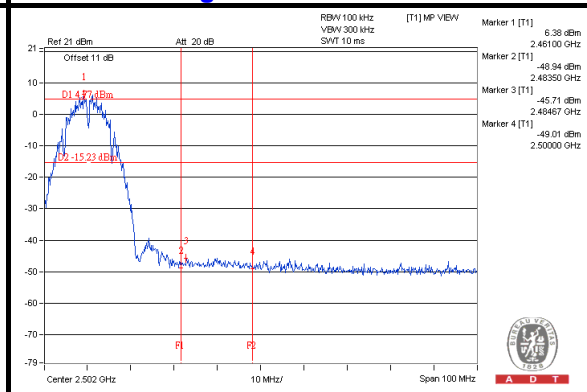



A D T

### 802.11g: CHAIN 0

#### CH 1

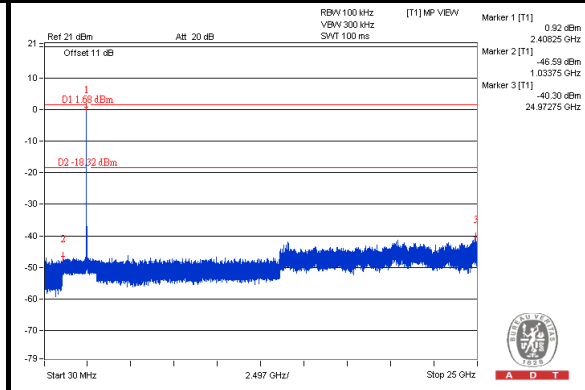
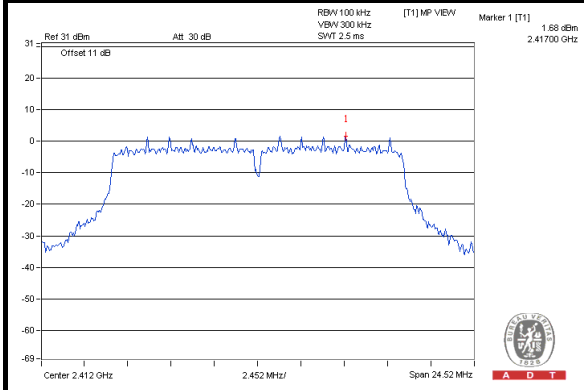

#### CH 6

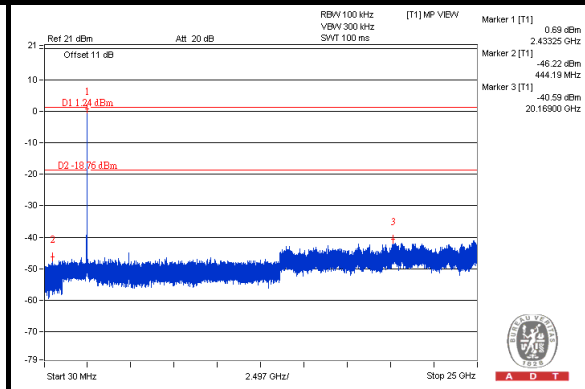
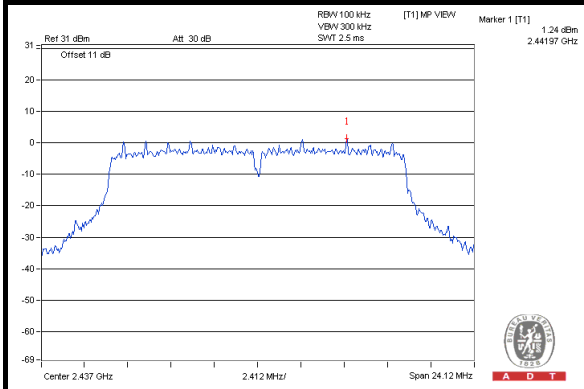

#### CH 11

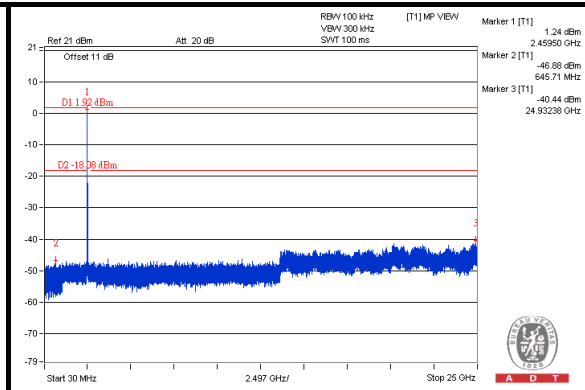
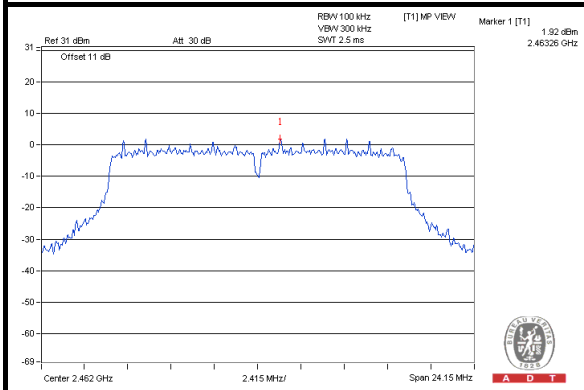

#### CH 1 Band edge

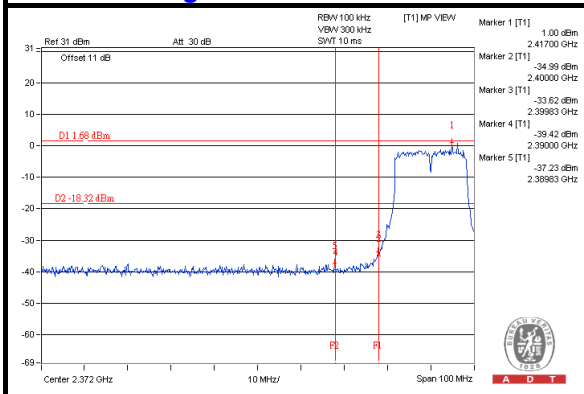

#### CH 11 Band edge

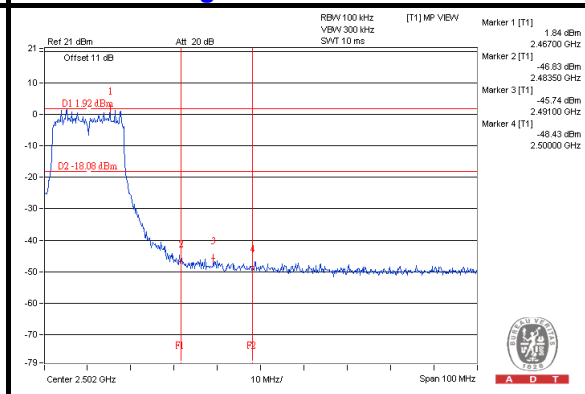



A D T

### CHAIN 1

#### CH 1

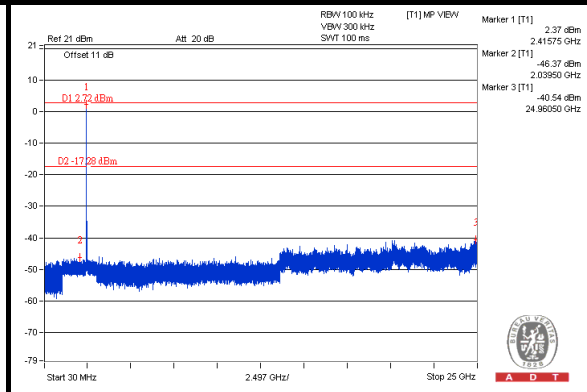
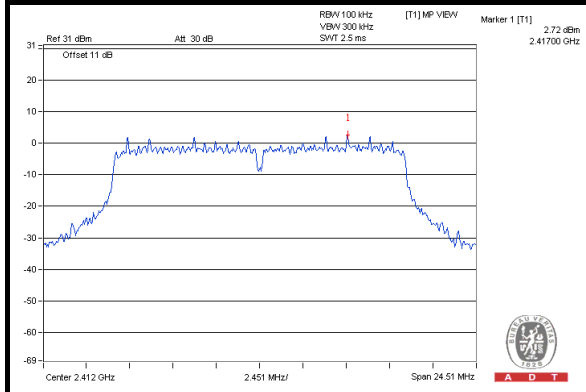

#### CH 6

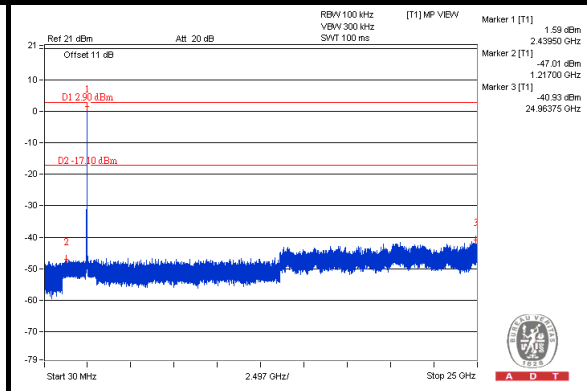
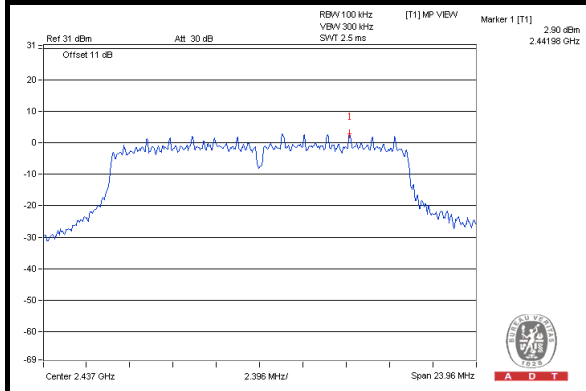

#### CH 11

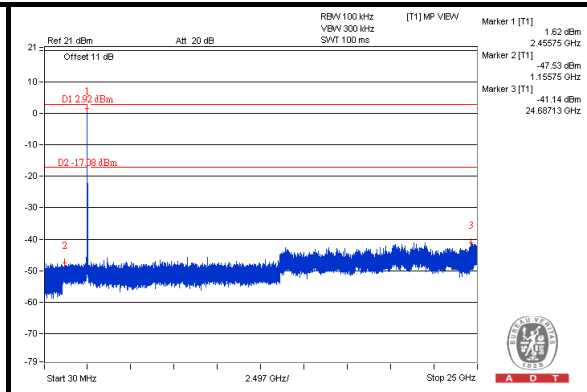
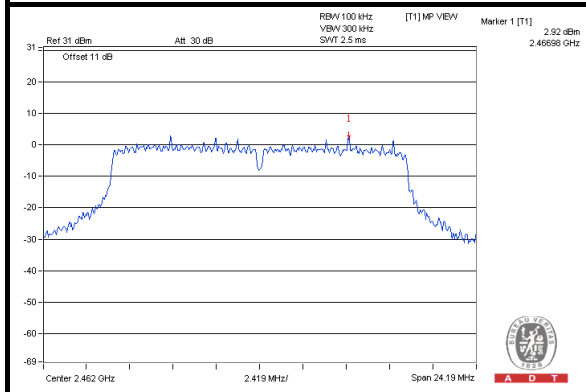

#### CH 1 Band edge

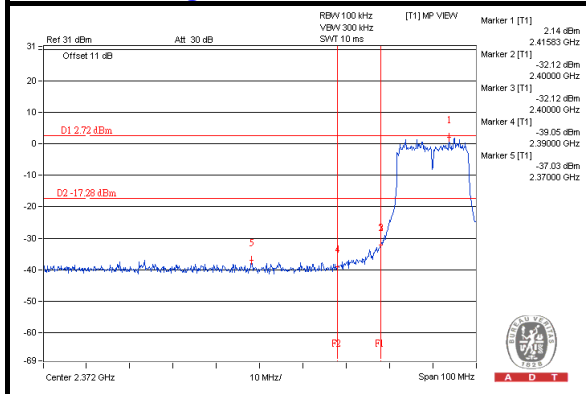

#### CH 11 Band edge

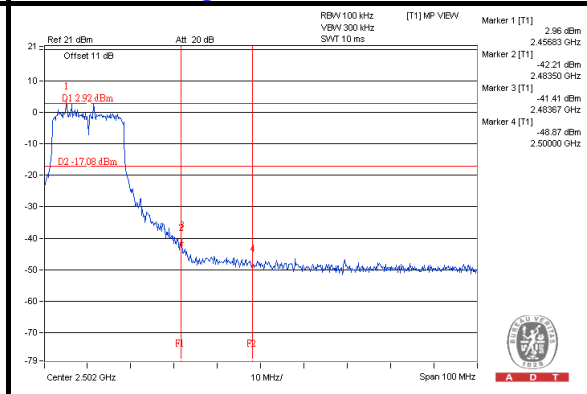



A D T

### 802.11n (20MHz): CHAIN 0

#### CH 1

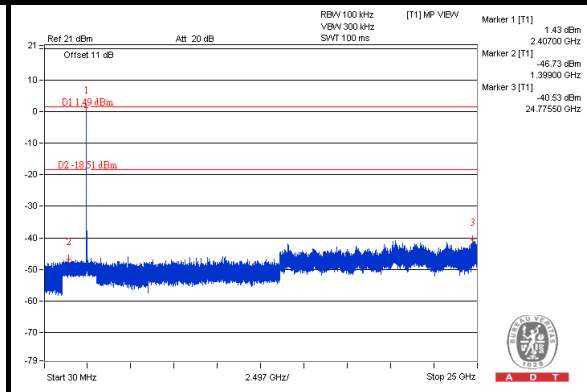
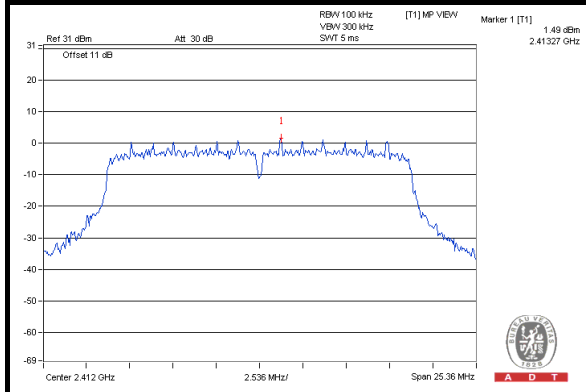

#### CH 6

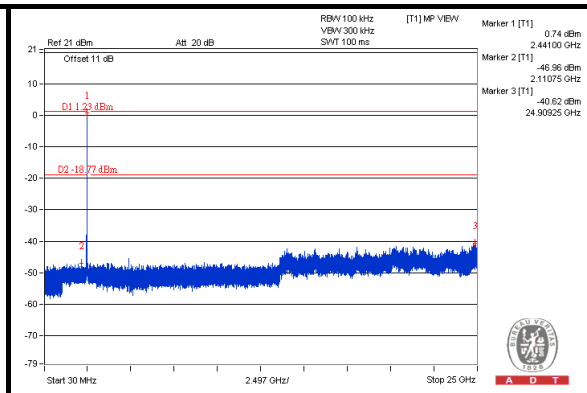
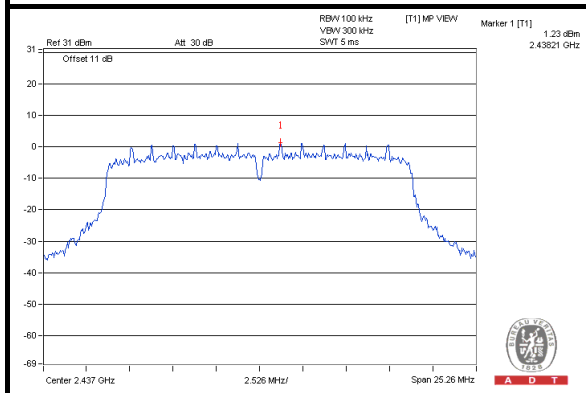

#### CH 11

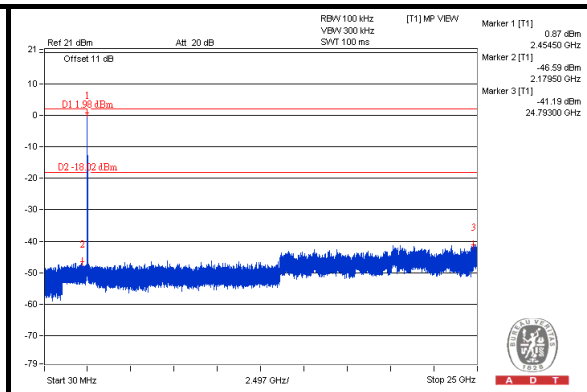
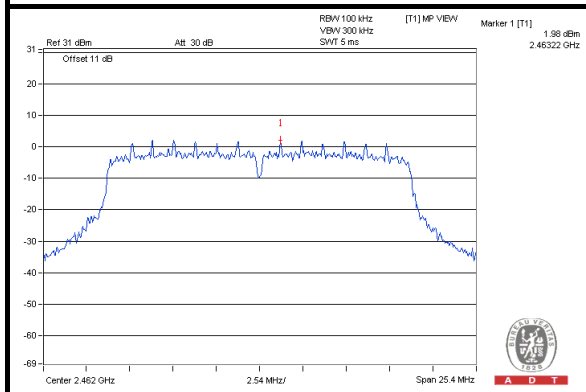

#### CH 1 Band edge

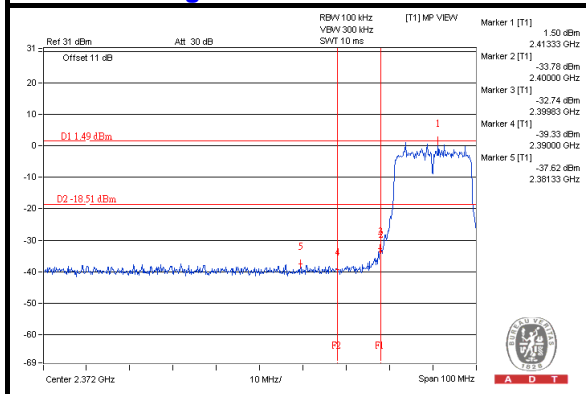

#### CH 11 Band edge

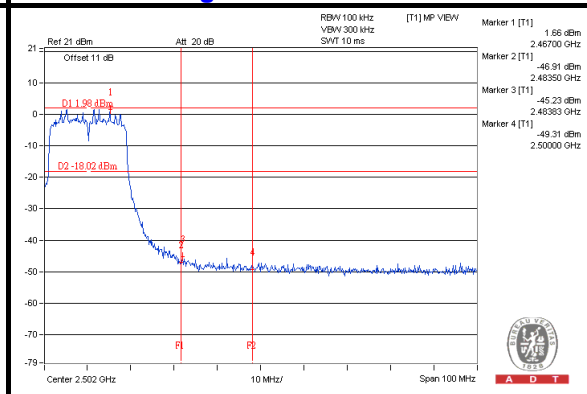



A D T

### CHAIN 1

#### CH 1

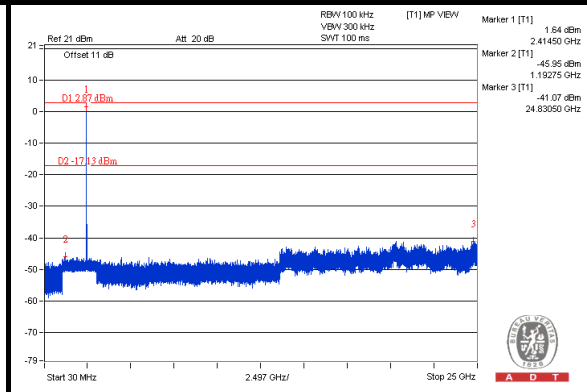
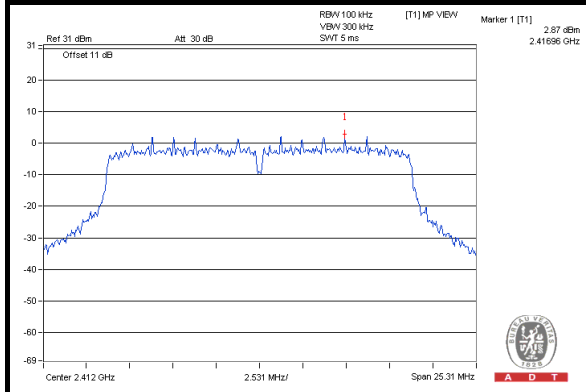

#### CH 6

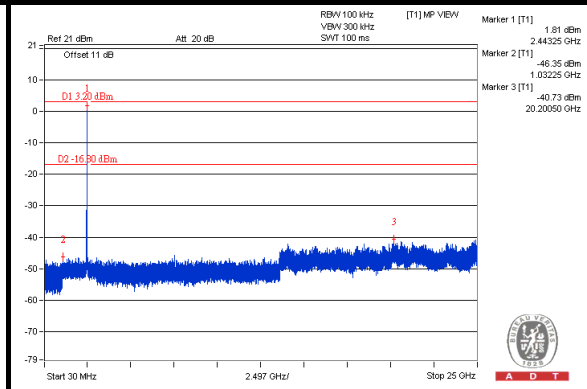
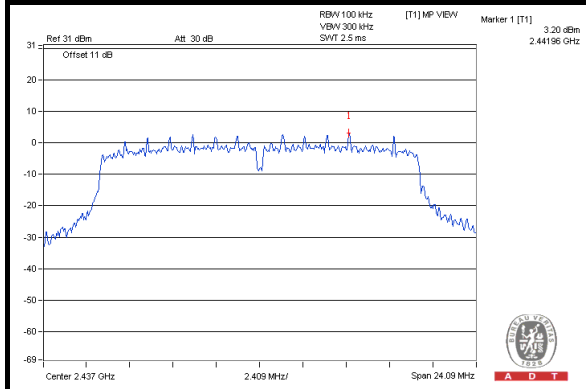

#### CH 11

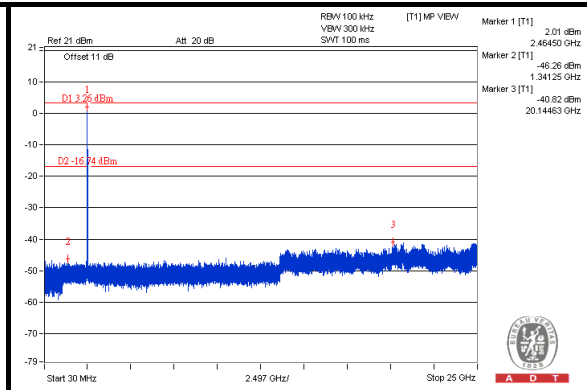
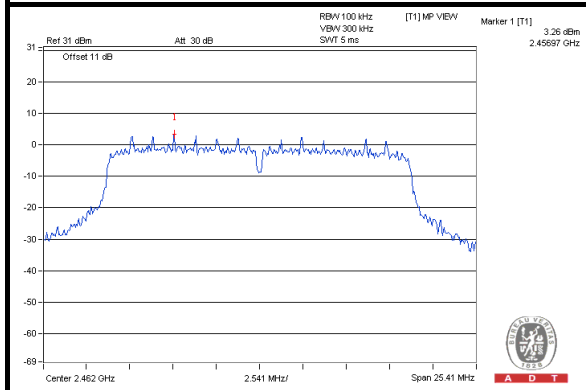

#### CH 1 Band edge

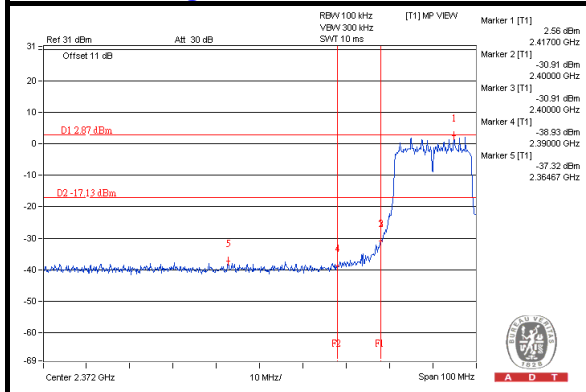

#### CH 11 Band edge

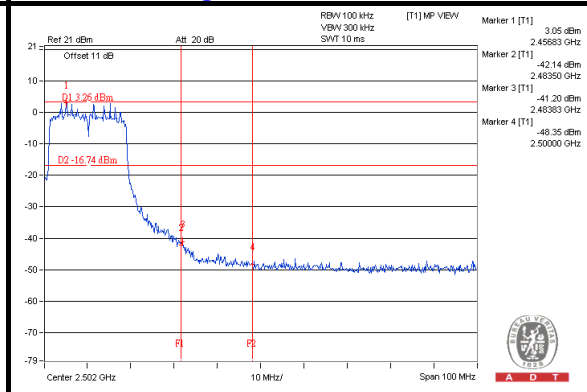



A D T

### 802.11n (40MHz): CHAIN 0

#### CH 3

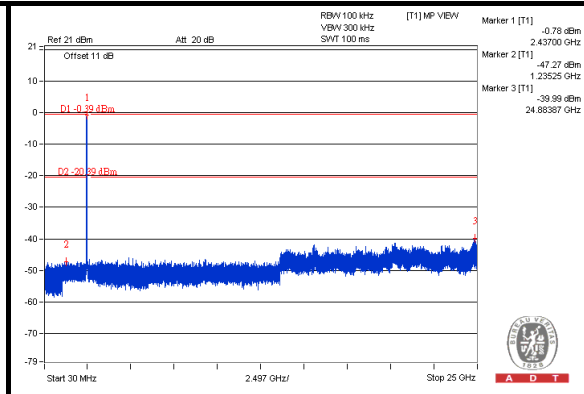
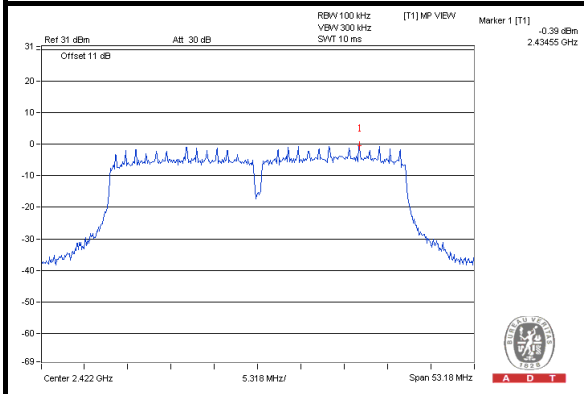

#### CH 6

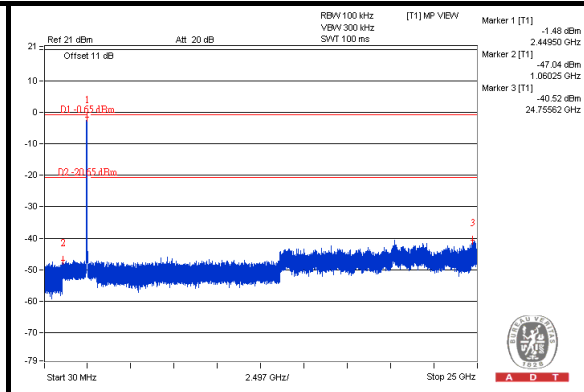
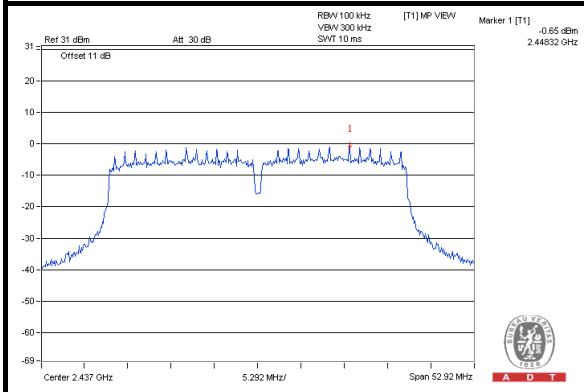

#### CH 9

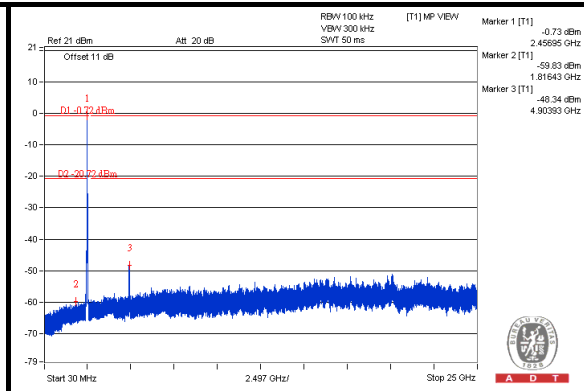
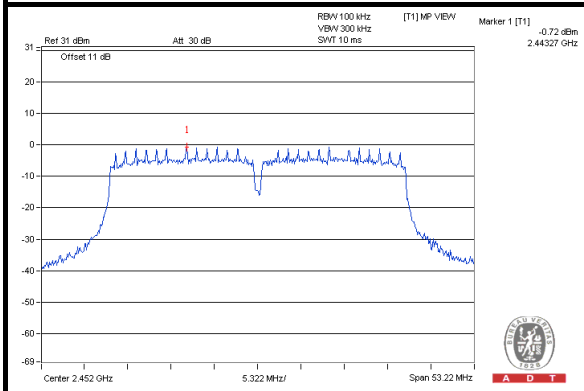

#### CH 3 Band edge

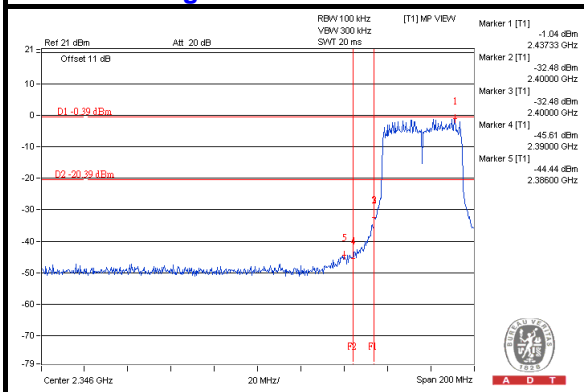

#### CH 9 Band edge

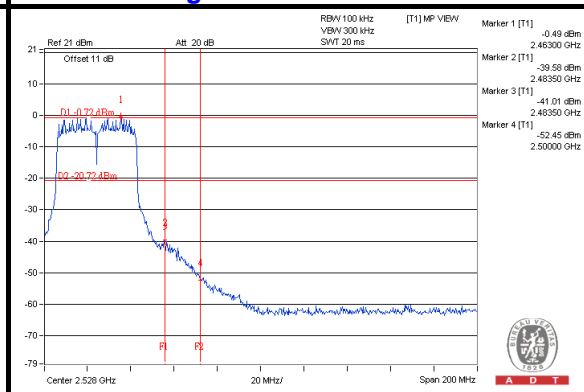





A D T

### CHAIN 1

### CH 3

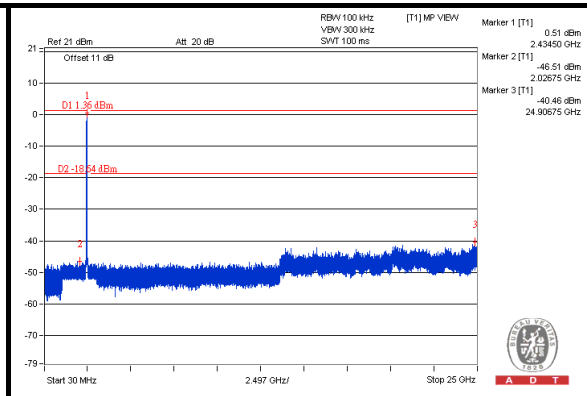
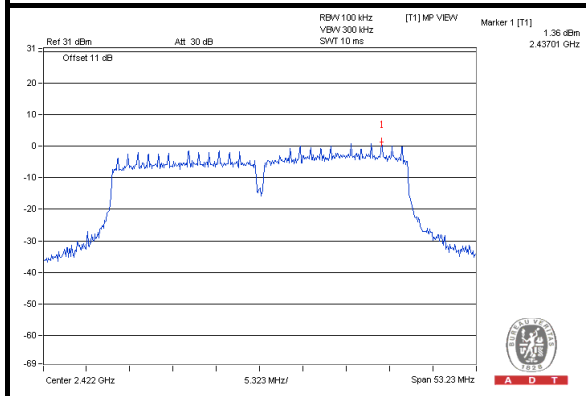

### CH 6

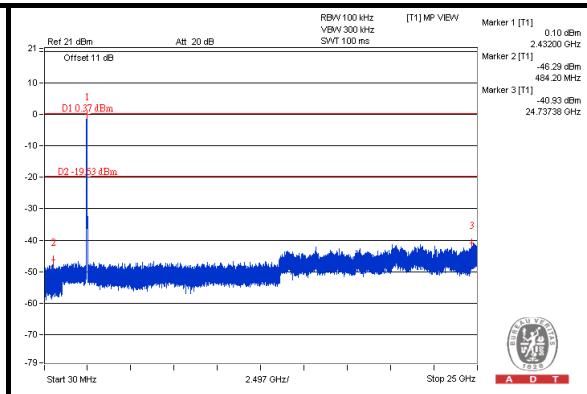
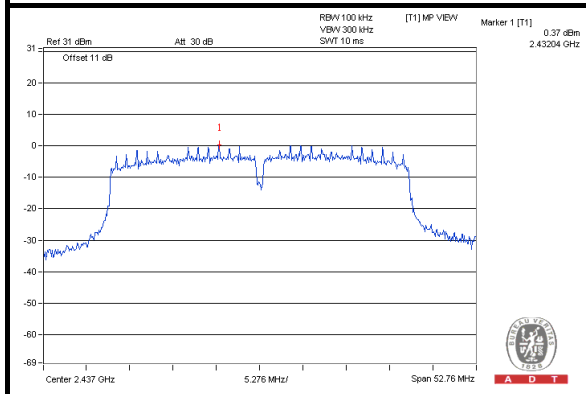

### CH 9

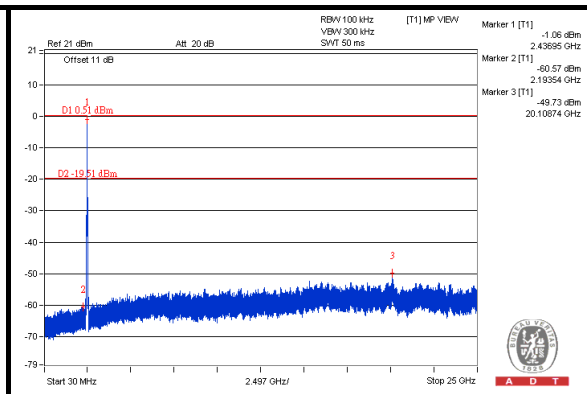
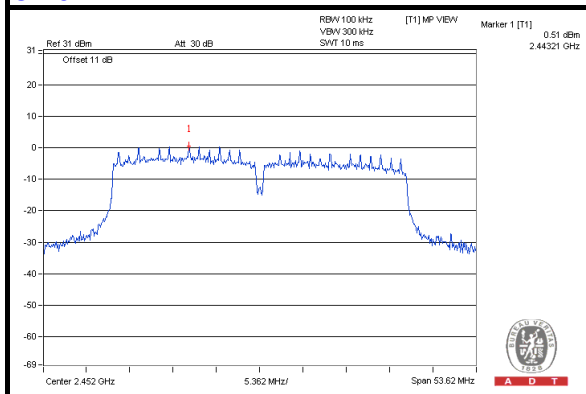

### CH 3 Band edge

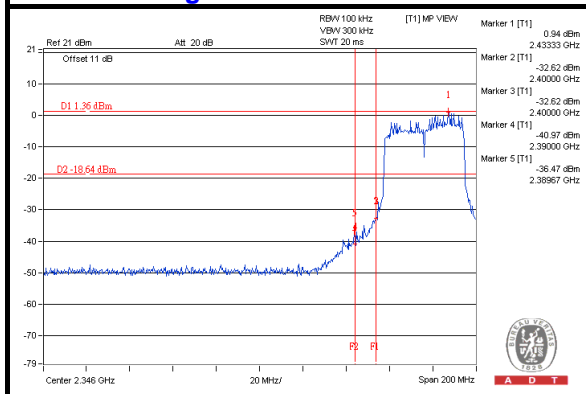

### CH 9 Band edge

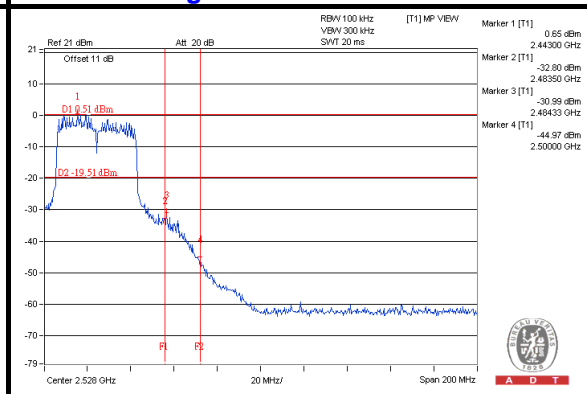

## 5. PHOTOGRAPHS OF THE TEST CONFIGURATION

Please refer to the attached file (Test Setup Photo).



## 6. INFORMATION ON THE TESTING LABORATORIES

We, Bureau Veritas Consumer Products Services (H.K.) Ltd., Taoyuan Branch, were founded in 1988 to provide our best service in EMC, Radio, Telecom and Safety consultation. Our laboratories are accredited and approved according to ISO/IEC 17025.

If you have any comments, please feel free to contact us at the following:

**Linko EMC/RF Lab:**

Tel: 886-2-26052180

Fax: 886-2-26051924

**Hsin Chu EMC/RF/Telecom Lab:**

Tel: 886-3-5935343

Fax: 886-3-5935342

**Hwa Ya EMC/RF/Safety Lab:**

Tel: 886-3-3183232

Fax: 886-3-3270892

**Email:** [service.adt@tw.bureauveritas.com](mailto:service.adt@tw.bureauveritas.com)

**Web Site:** [www.bureauveritas-adt.com](http://www.bureauveritas-adt.com)

The address and road map of all our labs can be found in our web site also.



A D T

## **7. APPENDIX A – MODIFICATIONS RECORDERS FOR ENGINEERING CHANGES TO THE EUT BY THE LAB**

No any modifications are made to the EUT by the lab during the test.

**---END---**