



A D T

FCC TEST REPORT (PART 22)

REPORT NO.: RF131024C22
MODEL NO.: PA-MR03LN
FCC ID: 2AA5WPAMR03LN
RECEIVED: Oct. 24, 2013
TESTED: Dec. 21 ~ Dec. 25, 2013
ISSUED: Jan. 13, 2014

APPLICANT: NEC Access Technica, Ltd.

ADDRESS: 800, Shimomata, Kakegawa-shi, Shizuoka
436-8501, Japan

ISSUED BY: Bureau Veritas Consumer Products Services
(H.K.) Ltd., Taoyuan Branch

LAB ADDRESS: No. 47, 14th Ling, Chia Pau Vil., Lin Kou Dist., New
Taipei City, Taiwan, R.O.C.

TEST LOCATION: No. 19, Hwa Ya 2nd Rd, Wen Hwa Tsuen, Kwei
Shan Hsiang, Taoyuan Hsien 333, Taiwan, R.O.C.

This report should not be used by the client to claim product certification, approval, or endorsement by TAF or any government agencies.



This report is for your exclusive use. Any copying or replication of this report to or for any other person or entity, or use of our name or trademark, is permitted only with our prior written permission. This report sets forth our findings solely with respect to the test samples identified herein. The results set forth in this report are not indicative or representative of the quality or characteristics of the lot from which a test sample was taken or any similar or identical product unless specifically and expressly noted. Our report includes all of the tests requested by you and the results thereof based upon the information that you provided to us. You have 60 days from date of issuance of this report to notify us of any material error or omission caused by our negligence, provided, however, that such notice shall be in writing and shall specifically address the issue you wish to raise. A failure to raise such issue within the prescribed time shall constitute your unqualified acceptance of the completeness of this report, the tests conducted and the correctness of the report contents. Unless specific mention, the uncertainty of measurement has been explicitly taken into account to declare the compliance or non-compliance to the specification.



TABLE OF CONTENTS

RELEASE CONTROL RECORD.....	3
1 CERTIFICATION	4
2 SUMMARY OF TEST RESULTS.....	5
2.1 MEASUREMENT UNCERTAINTY	5
2.2 TEST SITE AND INSTRUMENTS	6
3 GENERAL INFORMATION.....	7
3.1 GENERAL DESCRIPTION OF EUT.....	7
3.2 CONFIGURATION OF SYSTEM UNDER TEST.....	8
3.3 DESCRIPTION OF SUPPORT UNITS.....	8
3.4 TEST ITEM AND TEST CONFIGURATION	10
3.5 EUT OPERATING CONDITIONS.....	11
3.6 GENERAL DESCRIPTION OF APPLIED STANDARDS.....	11
4 TEST TYPES AND RESULTS	12
4.1 OUTPUT POWER MEASUREMENT	12
4.1.1 LIMITS OF OUTPUT POWER MEASUREMENT	12
4.1.2 TEST PROCEDURES	12
4.1.3 TEST SETUP.....	13
4.1.4 TEST RESULTS	14
4.2 FREQUENCY STABILITY MEASUREMENT	17
4.2.1 LIMITS OF FREQUENCY STABILITY MEASUREMENT	17
4.2.2 TEST PROCEDURE	17
4.2.3 TEST SETUP.....	17
4.2.4 TEST RESULTS	18
4.3 OCCUPIED BANDWIDTH MEASUREMENT.....	19
4.3.1 TEST PROCEDURES	19
4.3.2 TEST SETUP.....	19
4.3.3 TEST RESULTS	20
4.4 BAND EDGE MEASUREMENT	21
4.4.1 LIMITS OF BAND EDGE MEASUREMENT.....	21
4.4.2 TEST SETUP.....	21
4.4.3 TEST PROCEDURES	21
4.4.4 TEST RESULTS	22
4.5 CONDUCTED SPURIOUS EMISSIONS.....	24
4.5.1 LIMITS OF CONDUCTED SPURIOUS EMISSIONS MEASUREMENT	24
4.5.2 TEST PROCEDURE	24
4.5.3 TEST SETUP.....	24
4.5.4 TEST RESULTS	25
4.6 RADIATED EMISSION MEASUREMENT	37
4.6.1 LIMITS OF RADIATED EMISSION MEASUREMENT	37
4.6.2 TEST PROCEDURES	37
4.6.3 DEVIATION FROM TEST STANDARD	37
4.6.4 TEST SETUP.....	38
4.6.5 TEST RESULTS	39
5 PHOTOGRAPHS OF THE TEST CONFIGURATION	49
6 INFORMATION ON THE TESTING LABORATORIES.....	50
7 APPENDIX A – MODIFICATIONS RECORDERS FOR ENGINEERING CHANGES TO THE EUT BY THE LAB	51



A D T

RELEASE CONTROL RECORD

ISSUE NO.	REASON FOR CHANGE	DATE ISSUED
RF131024C22	Original release	Jan. 13, 2014



A D T

1 CERTIFICATION

PRODUCT: PA MR03LN

MODEL: PA-MR03LN

BRAND: NEC

APPLICANT: NEC Access Technica, Ltd.

TESTED: Dec. 21 ~ Dec. 25, 2013

TEST SAMPLE: ENGINEERING SAMPLE

STANDARDS: FCC PART 22, Subpart H

The above equipment (model: PA-MR03LN) has been tested by **Bureau Veritas Consumer Products Services (H.K.) Ltd., Taoyuan Branch**, and found compliance with the requirement of the above standards. The test record, data evaluation & Equipment Under Test (EUT) configurations represented herein are true and accurate accounts of the measurements of the sample's EMC characteristics under the conditions specified in this report.

PREPARED BY :  , **DATE** : Jan. 13, 2014
Pettie Chen / Senior Specialist

APPROVED BY :  , **DATE** : Jan. 13, 2014
Anderson Chiu / Senior Engineer



2 SUMMARY OF TEST RESULTS

The EUT has been tested according to the following specifications:

APPLIED STANDARD: FCC Part 22 & Part 2			
STANDARD SECTION	TEST TYPE	RESULT	REMARK
2.1046 22.913 (a)	Effective radiated power	PASS	Meet the requirement of limit.
2.1055 22.355	Frequency Stability	PASS	Meet the requirement of limit.
2.1049	Occupied Bandwidth	PASS	Meet the requirement of limit.
22.917	Band Edge Measurements	PASS	Meet the requirement of limit.
2.1051 22.917	Conducted Spurious Emissions	PASS	Meet the requirement of limit.
2.1053 22.917	Radiated Spurious Emissions	PASS	Meet the requirement of limit. Minimum passing margin is -25.86dB at 2472.60MHz.

2.1 MEASUREMENT UNCERTAINTY

Where relevant, the following measurement uncertainty levels have been estimated for tests performed on the EUT as specified in CISPR 16-4-2:

MEASUREMENT	FREQUENCY	UNCERTAINTY
Radiated emissions	30MHz ~ 200MHz	3.19 dB
	200MHz ~ 1000MHz	3.21 dB
	1GHz ~ 18GHz	2.26 dB
	18GHz ~ 40GHz	1.94 dB

This uncertainty represents an expanded uncertainty expressed at approximately the 95% confidence level using a coverage factor of $k=2$.



2.2 TEST SITE AND INSTRUMENTS

DESCRIPTION & MANUFACTURER	MODEL NO.	SERIAL NO.	DATE OF CALIBRATION	DUE DATE OF CALIBRATION
Test Receiver ROHDE & SCHWARZ	ESCI	100424	Sep. 09, 2013	Sep. 08, 2014
Spectrum Analyzer ROHDE & SCHWARZ	FSU 43	100115	Dec. 18, 2013	Dec. 17, 2014
BILOG Antenna SCHWARZBECK	VULB9168	9168-155	Mar. 25, 2013	Mar. 24, 2014
HORN Antenna SCHWARZBECK	BBHA 9120D	9120D-405	Feb. 21, 2013	Feb. 20, 2014
HORN Antenna SCHWARZBECK	BBHA 9170	148	Jul. 15, 2013	Jul. 14, 2014
Preamplifier Agilent	8449B	3008A01961	Oct. 28, 2013	Oct. 27, 2014
Preamplifier Agilent	8447D	2944A10738	Oct. 18, 2013	Oct. 17, 2014
RF signal cable HUBER+SUHNNER	SUCOFLEX 104	309220/4	Aug. 26, 2013	Aug. 25, 2014
RF signal cable HUBER+SUHNNER	SUCOFLEX 104	250724/4	Aug. 26, 2013	Aug. 25, 2014
RF signal cable HUBER+SUHNNER	SUCOFLEX 104	295012/4	Aug. 26, 2013	Aug. 25, 2014
Software BV ADT	ADT_Radiated_ V7.6.15.9.4	NA	NA	NA
Antenna Tower inn-co GmbH	MA 4000	010303	NA	NA
Antenna Tower Controller inn-co GmbH	CO2000	019303	NA	NA
Turn Table BV ADT	TT100.	TT93021704	NA	NA
Turn Table Controller BV ADT	SC100.	SC93021704	NA	NA
Mini-Circuits Power Splitter	ZN2PD-9G	NA	Sep. 09, 2013	Sep. 08, 2014
JFW 20dB attenuation	50HF-020-SMA	NA	NA	NA

- NOTE:**
1. The calibration interval of the above test instruments is 12 months and the calibrations are traceable to NML/ROC and NIST/USA.
 2. The test was performed in HwaYa Chamber 3.
 3. The horn antenna and HP preamplifier (model: 8449B) are used only for the measurement of emission frequency above 1GHz if tested.
 4. The FCC Site Registration No. is 988962.
 5. The IC Site Registration No. is IC 7450F-3.

3 GENERAL INFORMATION

3.1 GENERAL DESCRIPTION OF EUT

EUT	PA MR03LN
MODEL NO.	PA-MR03LN
POWER SUPPLY	3.8Vdc (Battery) 5Vdc (adapter)
MODULATION TYPE	GPRS: GMSK WCDMA : BPSK
FREQUENCY RANGE	GPRS: 824.2MHz ~ 848.8MHz WCDMA: 826.4MHz ~ 846.6MHz
MAX. ERP POWER	GPRS: 0.716Watts (28.55dBm) WCDMA: 0.106Watts (20.27dBm)
EMISSION DESIGNATOR	GPRS: 260KG7W WCDMA: 4M17F9W
MULTI-SLOTS CLASS	10
WCDMA RELEASE VERSION	6
ANTENNA TYPE	PCB antenna with -1.18dBi gain
I/O PORTS	Refer to users' manual
DATA CABLE	NA
ACCESSORY DEVICES	Battery

NOTE:

- The EUT consumes power from the following battery and adapter.

ITEM	BRAND	MODEL	SPECIFICATION
Adapter (Support unit)	NEC	AL1-004001-001	I/P: 100-240Vac~50/60Hz 140mA O/P: 5Vdc, 1.0A
Li-ion Battery (Accessory)	SANYO	AL1-003388-001	Rating: 3.8Vdc, 2300mAh

- The following support units provided by client.

ITEM	BRAND	MODEL	SPECIFICATION
Ethernet Cable	NA	AL1-001423-001	2.0m non-shielded cable without core
USB Cable	NA	AL1-003329-005	1.0m non-shielded cable without core
PA-MR03L-EX3C	NEC	EX3C cradle	NA

- The above EUT information was declared by manufacturer and for more detailed features description, please refer to the manufacturer's specifications or User's Manual.

3.2 CONFIGURATION OF SYSTEM UNDER TEST

Test Mode A

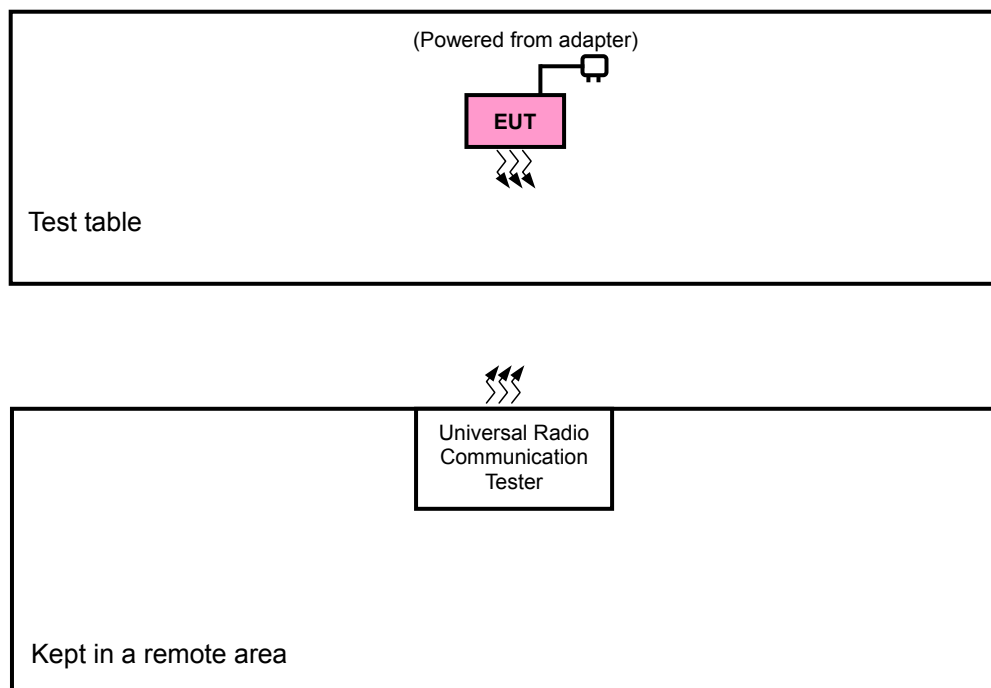

Test Mode B

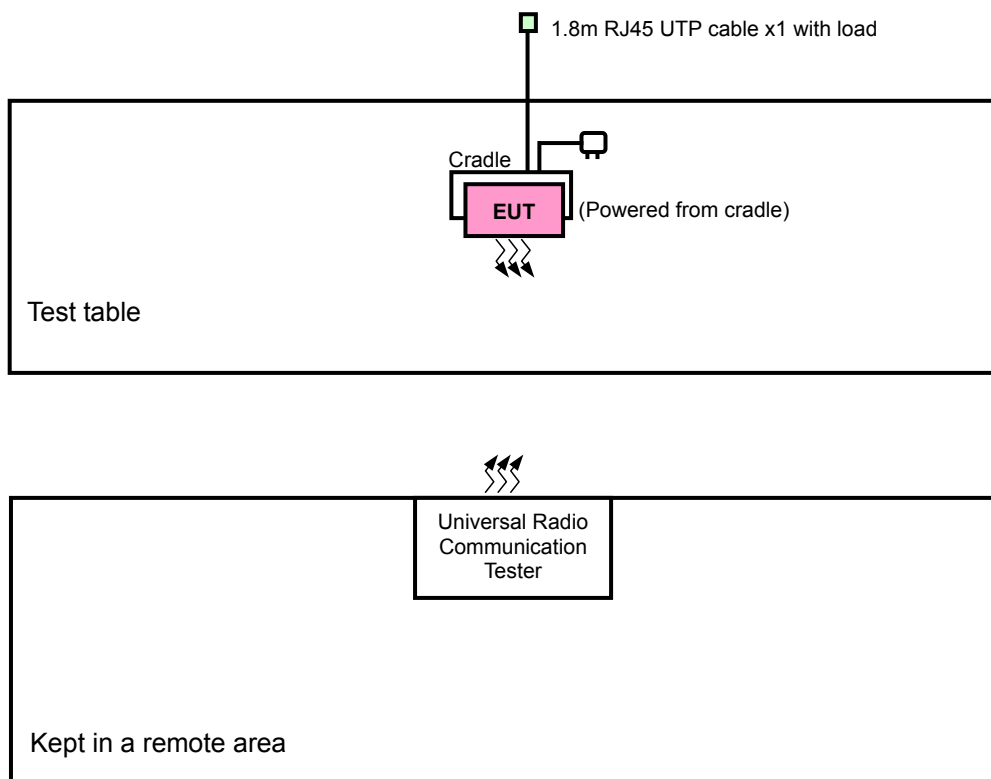

3.3 DESCRIPTION OF SUPPORT UNITS

The EUT has been tested as an independent unit together with other necessary accessories or support units. The following support units or accessories were used to form a representative test configuration during the tests.

NO.	PRODUCT	BRAND	MODEL NO.	SERIAL NO.	FCC ID
1	PA-MR03L-EX3C	NEC	EX3C cradle	NA	NA
2	Universal Radio Communication Tester	R&S	CMU200	104958	NA

NO.	SIGNAL CABLE DESCRIPTION OF THE ABOVE SUPPORT UNITS
1	1.0m non-shielded USB cable without core
2	NA

NOTE:

1. All power cords of the above support units are non-shielded (1.8m).
2. Item 1 was provided by client.
3. Item 2 act as a communication partner to transfer data.



3.4 TEST ITEM AND TEST CONFIGURATION

Pre-Scan has been conducted to determine the worst-case mode from all possible combinations between available modulations, data rates, XYZ axis and antenna ports. The worst case was found when positioned on X-plane (For Test Mode A), Y-plane (For Test Mode B). Following channel(s) was (were) selected for the final test as listed below:

EUT CONFIGURE MODE	DESCRIPTION
A	Power from adapter
B	Power from cradle

GPRS MODE

EUT CONFIGURE MODE	TEST ITEM	AVAILABLE CHANNEL	TESTED CHANNEL	MODE
B	ERP	128 to 251	128, 189, 251	GPRS
B	FREQUENCY STABILITY	128 to 251	189	GPRS
B	OCCUPIED BANDWIDTH	128 to 251	128, 189, 251	GPRS
B	BAND EDGE	128 to 251	128, 251	GPRS
B	CONDUCTED EMISSION	128 to 251	128, 189, 251	GPRS
A, B	RADIATED EMISSION (30MHz~1GHz)	128 to 251	189	GPRS
B	RADIATED EMISSION (Above 1GHz)	128 to 251	128, 189, 251	GPRS

WCDMA MODE

EUT CONFIGURE MODE	TEST ITEM	AVAILABLE CHANNEL	TESTED CHANNEL	MODE
B	ERP	4132 to 4233	4132, 4182, 4233	WCDMA
B	FREQUENCY STABILITY	4132 to 4233	4182	WCDMA
B	OCCUPIED BANDWIDTH	4132 to 4233	4132, 4182, 4233	WCDMA, HSDPA, HSUPA
B	BAND EDGE	4132 to 4233	4132, 4233	WCDMA, HSDPA, HSUPA
B	CONDUCTED EMISSION	4132 to 4233	4132, 4182, 4233	WCDMA, HSDPA, HSUPA
A, B	RADIATED EMISSION (30MHz~1GHz)	4132 to 4233	4132	WCDMA
B	RADIATED EMISSION (Above 1GHz)	4132 to 4233	4132, 4182, 4233	WCDMA



A D T

TEST CONDITION:

TEST ITEM	ENVIRONMENTAL CONDITIONS	INPUT POWER	TESTED BY
ERP	26deg. C, 65%RH	120Vac, 60Hz	Match Tsui
FREQUENCY STABILITY	26deg. C, 65%RH	120Vac, 60Hz	Match Tsui
OCCUPIED BANDWIDTH	26deg. C, 65%RH	120Vac, 60Hz	Match Tsui
BAND EDGE	26deg. C, 65%RH	120Vac, 60Hz	Match Tsui
CONDCUDED EMISSION	26deg. C, 65%RH	120Vac, 60Hz	Match Tsui
RADIATED EMISSION	26deg. C, 68%RH	120Vac, 60Hz	Brad Tung

3.5 EUT OPERATING CONDITIONS

The EUT makes a call to the communication simulator. The communication simulator station system controlled a EUT to export maximum output power under transmission mode and specific channel frequency

3.6 GENERAL DESCRIPTION OF APPLIED STANDARDS

The EUT is a RF product. According to the specifications of the manufacturer, it must comply with the requirements of the following standards:

FCC 47 CFR Part 2

FCC 47 CFR Part 22

ANSI/TIA/EIA-603-C 2004

NOTE: All test items have been performed and recorded as per the above standards.



4 TEST TYPES AND RESULTS

4.1 OUTPUT POWER MEASUREMENT

4.1.1 LIMITS OF OUTPUT POWER MEASUREMENT

Mobile / Portable station are limited to 7 watts e.r.p.

4.1.2 TEST PROCEDURES

EIRP / ERP MEASUREMENT:

- a. All measurements were done at low, middle and high operational frequency range. RBW and VBW is 1MHz for GPRS and 5MHz for WCDMA mode.
- b. Substitution method is used for E.I.R.P measurement. In the semi-anechoic chamber, EUT placed on the 0.8m height of Turn Table, rotated the table around 360 degrees to search the maximum radiation power and receiver antenna shall be rotated vertical and horizontal polarization and moved height from 1m to 4m to find the maximum polar radiated power. The “Read Value” is the spectrum reading the maximum power value.
- c. The substitution horn antenna is substituted for EUT at the same position and signals generator export the CW signal to the substitution antenna via a tx cable. Rotated the Turn Table and moved receiving antenna to find the maximum radiation power. Adjust output power level of S.G to get a Value of spectrum reading equal to “Read Value” of step b. Record the power level of S.G
- d. $EIRP = \text{Output power level of S.G} - \text{TX cable loss} + \text{Antenna gain of substitution horn.}$ E.R.P power can be calculated form E.I.R.P power by subtracting the gain of dipole, $E.R.P \text{ power} = E.I.P.R \text{ power} - 2.15\text{dBi}.$

CONDUCTED POWER MEASUREMENT:

The EUT was set up for the maximum power with GPRS & WCDMA link data modulation and link up with simulator. Set the EUT to transmit under low, middle and high channel and record the power level shown on simulator.

4.1.3 TEST SETUP

EIRP / ERP MEASUREMENT:

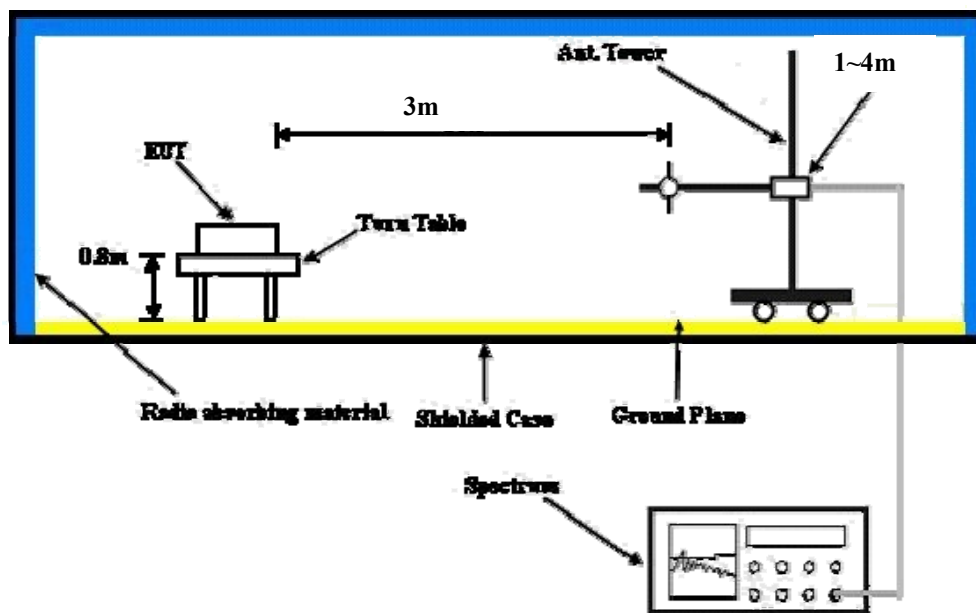

For the actual test configuration, please refer to the attached file (Test Setup Photo).

CONDUCTED POWER MEASUREMENT:

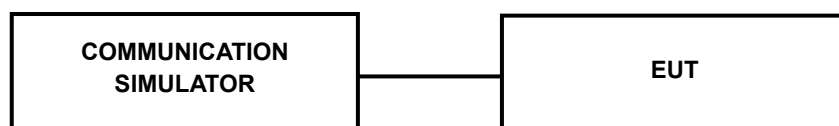

For the actual test configuration, please refer to the attached file (Test Setup Photo).



4.1.4 TEST RESULTS

CONDUCTED OUTPUT POWER (dBm)

Band	GSM850		
Channel	128	189	251
Frequency (MHz)	824.2	836.4	848.8
GPRS 8	30.68	31.00	30.86
GPRS 10	30.52	30.85	30.70
GPRS 11	30.29	30.62	30.47
GPRS 12	29.07	29.40	29.25

Band	WCDMA V		
Channel	4132	4182	4233
Frequency (MHz)	826.4	836.4	846.6
RMC 12.2K	23.03	22.84	23.05
HSDPA Subtest-1	22.96	22.77	22.98
HSDPA Subtest-2	22.95	22.76	22.97
HSDPA Subtest-3	22.45	22.26	22.47
HSDPA Subtest-4	22.45	22.26	22.47
HSUPA Subtest-1	22.45	22.26	22.47
HSUPA Subtest-2	20.40	20.21	20.42
HSUPA Subtest-3	21.19	21.00	21.21
HSUPA Subtest-4	20.35	20.16	20.37
HSUPA Subtest-5	22.01	21.82	22.03



A D T

ERP POWER (dBm)**FOR GPRS MODE:**

MODE		TX channel 128					
ANTENNA POLARITY & TEST DISTANCE: HORIZONTAL AT 3 M							
No.	Freq. (MHz)	Reading (dBm)	S.G Power Value (dBm)	Correction Factor (dB)	ERP (dBm)	Limit (dBm)	Margin (dB)
1	824.2	-2.03	28.37	0.01	28.38	38.45	-10.07
ANTENNA POLARITY & TEST DISTANCE: VERTICAL AT 3 M							
No.	Freq. (MHz)	Reading (dBm)	S.G Power Value (dBm)	Correction Factor (dB)	ERP (dBm)	Limit (dBm)	Margin (dB)
1	824.2	-7.25	21.77	0.01	21.78	38.45	-16.67

MODE		TX channel 189					
ANTENNA POLARITY & TEST DISTANCE: HORIZONTAL AT 3 M							
No.	Freq. (MHz)	Reading (dBm)	S.G Power Value (dBm)	Correction Factor (dB)	ERP (dBm)	Limit (dBm)	Margin (dB)
1	836.4	-1.05	28.26	0.29	28.55	38.45	-9.90
ANTENNA POLARITY & TEST DISTANCE: VERTICAL AT 3 M							
No.	Freq. (MHz)	Reading (dBm)	S.G Power Value (dBm)	Correction Factor (dB)	ERP (dBm)	Limit (dBm)	Margin (dB)
1	836.4	-7.42	22.03	0.29	22.32	38.45	-16.13

MODE		TX channel 251					
ANTENNA POLARITY & TEST DISTANCE: HORIZONTAL AT 3 M							
No.	Freq. (MHz)	Reading (dBm)	S.G Power Value (dBm)	Correction Factor (dB)	ERP (dBm)	Limit (dBm)	Margin (dB)
1	848.8	-1.19	27.95	0.51	28.46	38.45	-9.99
ANTENNA POLARITY & TEST DISTANCE: VERTICAL AT 3 M							
No.	Freq. (MHz)	Reading (dBm)	S.G Power Value (dBm)	Correction Factor (dB)	ERP (dBm)	Limit (dBm)	Margin (dB)
1	848.8	-7.86	21.56	0.51	22.07	38.45	-16.38

NOTE: ERP (dBm) = S.G Power Value (dBm) + Correction Factor (dB).



FOR WCDMA MODE:

MODE		TX channel 4132					
ANTENNA POLARITY & TEST DISTANCE: HORIZONTAL AT 3 M							
No.	Freq. (MHz)	Reading (dBm)	S.G Power Value (dBm)	Correction Factor (dB)	ERP (dBm)	Limit (dBm)	Margin (dB)
1	826.4	-9.99	20.21	0.06	20.27	38.45	-18.18
ANTENNA POLARITY & TEST DISTANCE: VERTICAL AT 3 M							
No.	Freq. (MHz)	Reading (dBm)	S.G Power Value (dBm)	Correction Factor (dB)	ERP (dBm)	Limit (dBm)	Margin (dB)
1	826.4	-16.52	12.58	0.06	12.64	38.45	-25.81

MODE		TX channel 4182					
ANTENNA POLARITY & TEST DISTANCE: HORIZONTAL AT 3 M							
No.	Freq. (MHz)	Reading (dBm)	S.G Power Value (dBm)	Correction Factor (dB)	ERP (dBm)	Limit (dBm)	Margin (dB)
1	836.4	-9.98	19.33	0.29	19.62	38.45	-18.83
ANTENNA POLARITY & TEST DISTANCE: VERTICAL AT 3 M							
No.	Freq. (MHz)	Reading (dBm)	S.G Power Value (dBm)	Correction Factor (dB)	ERP (dBm)	Limit (dBm)	Margin (dB)
1	836.4	-16.58	12.87	0.29	13.16	38.45	-25.29

MODE		TX channel 4233					
ANTENNA POLARITY & TEST DISTANCE: HORIZONTAL AT 3 M							
No.	Freq. (MHz)	Reading (dBm)	S.G Power Value (dBm)	Correction Factor (dB)	ERP (dBm)	Limit (dBm)	Margin (dB)
1	846.6	-9.68	19.49	0.47	19.96	38.45	-18.49
ANTENNA POLARITY & TEST DISTANCE: VERTICAL AT 3 M							
No.	Freq. (MHz)	Reading (dBm)	S.G Power Value (dBm)	Correction Factor (dB)	ERP (dBm)	Limit (dBm)	Margin (dB)
1	846.6	-16.42	13.01	0.47	13.48	38.45	-24.97

NOTE: ERP (dBm) = S.G Power Value (dBm) + Correction Factor (dB).

4.2 FREQUENCY STABILITY MEASUREMENT

4.2.1 LIMITS OF FREQUENCY STABILITY MEASUREMENT

1.5 ppm is for base and fixed station. 2.5 ppm is for mobile station.

4.2.2 TEST PROCEDURE

- Device is placed at the oven room. The oven room could control the temperatures and humidity. Power warm up is at least 15 min and power applied should perform before recording frequency error.
- EUT is connected the external power supply to control the DC input power. The test voltage range is from minimum to maximum working voltage. Each step shall be record the frequency error rate.
- The temperature range step is 10 degrees in this test items. All temperature levels shall be hold the $\pm 0.5^{\circ}\text{C}$ during the measurement testing. The each temperature step shall be at least 0.5 hours, consider the EUT could be test under the stability condition.

NOTE: The frequency error was recorded frequency error from the communication simulator.

4.2.3 TEST SETUP

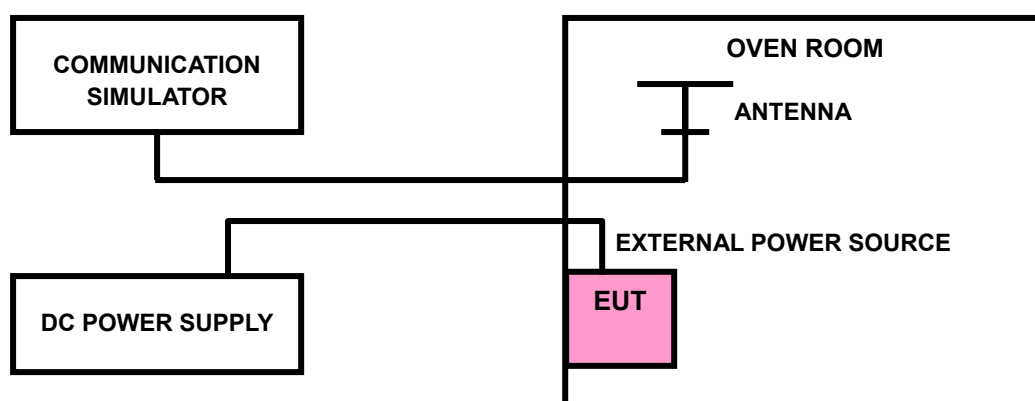



4.2.4 TEST RESULTS

FREQUENCY ERROR vs. VOLTAGE

VOLTAGE (Volts)	FREQUENCY ERROR (ppm)		LIMIT (ppm)
	GPRS	WCDMA	
4.5	-0.035	-0.035	2.5
3.8	-0.023	-0.029	2.5
3.3	-0.029	-0.027	2.5

NOTE: The applicant defined the normal working voltage of the battery is from 3.3Vdc to 4.5Vdc.

FREQUENCY ERROR vs. TEMPERATURE.

TEMP. (°C)	FREQUENCY ERROR (ppm)		LIMIT (ppm)
	GPRS	WCDMA	
50	-0.037	-0.045	2.5
40	-0.039	-0.050	2.5
30	-0.032	-0.041	2.5
20	-0.023	-0.029	2.5
10	-0.029	-0.047	2.5
0	-0.041	-0.047	2.5
-10	-0.044	-0.051	2.5
-20	-0.053	-0.055	2.5

4.3 OCCUPIED BANDWIDTH MEASUREMENT

4.3.1 TEST PROCEDURES

The EUT makes a call to the communication simulator. All measurements were done at low, middle and high operational frequency range. The communication simulator station system controlled a EUT to export maximum output power under transmission mode and specific channel frequency. Use OBW measurement function of Spectrum analyzer to measure 99 % occupied bandwidth.

4.3.2 TEST SETUP

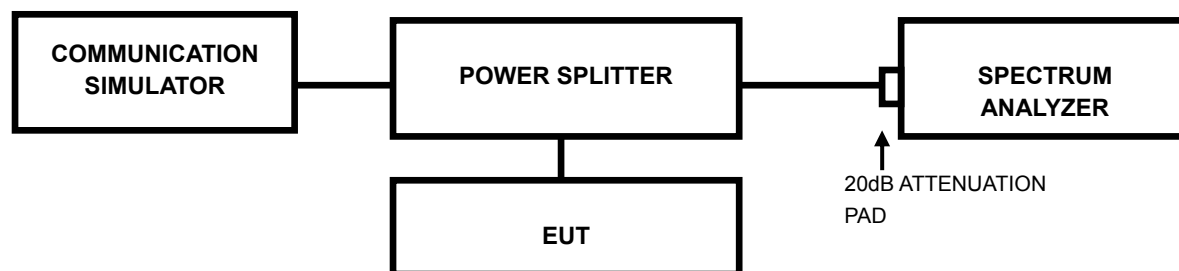

4.3.3 TEST RESULTS

CHANNEL	FREQUENCY (MHz)	99% OCCUPIED BANDWIDTH (kHz)	CHANNEL	FREQUENCY (MHz)	99% OCCUPIED BANDWIDTH (MHz)		
		GPRS			WCDMA	HSDPA	HSUPA
128	824.2	255.0	4132	826.4	4.12	4.13	4.17
189	836.4	250.0	4182	836.4	4.17	4.17	4.15
251	848.8	260.0	4233	846.6	4.15	4.17	4.17

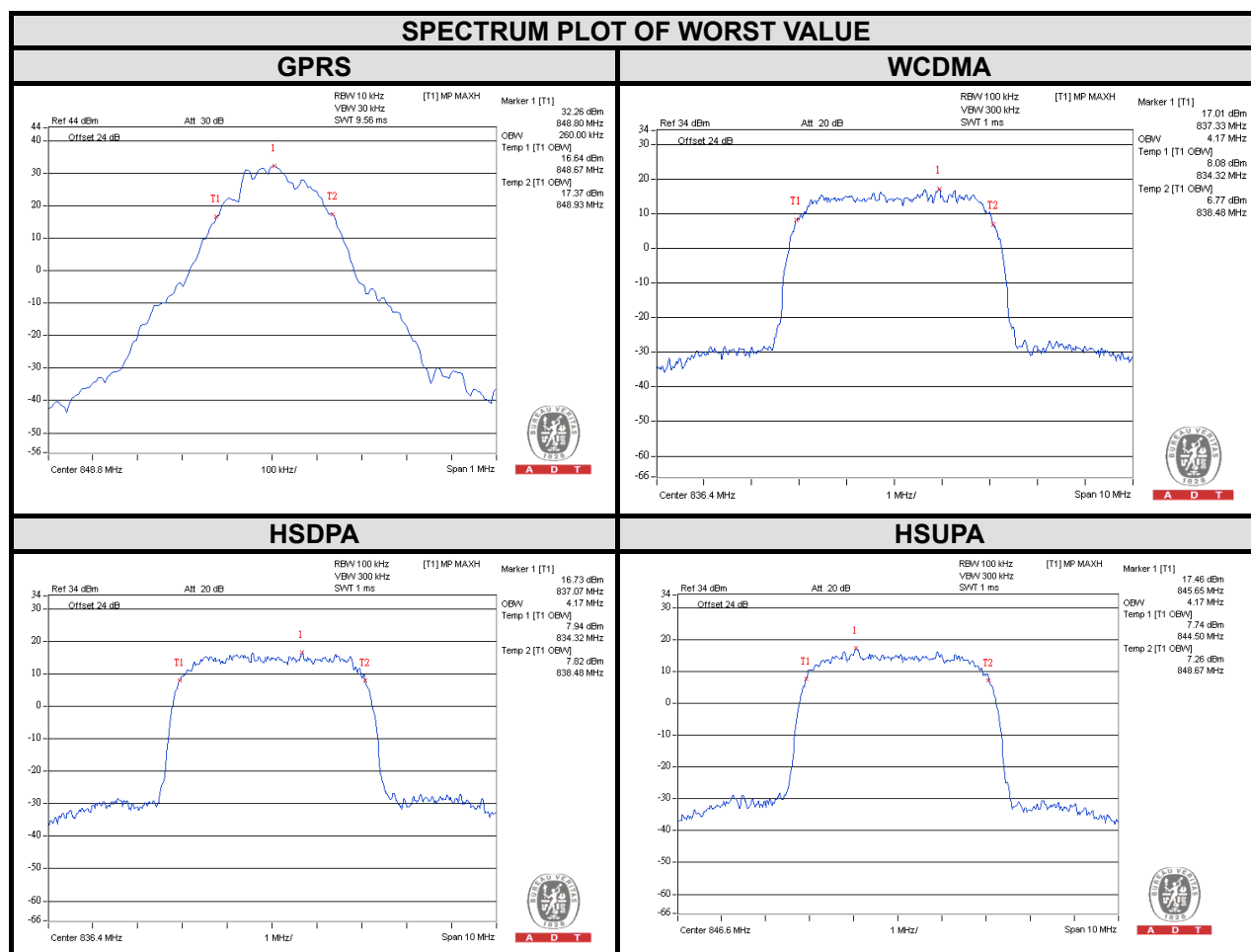

4.4 BAND EDGE MEASUREMENT

4.4.1 LIMITS OF BAND EDGE MEASUREMENT

Power of any emission outside of the authorized operating frequency ranges must be attenuated below the transmitting power (P) by a factor of at least $43 + 10 \log(P)$ dB. In the 1 MHz bands immediately outside and adjacent to the frequency block a resolution bandwidth of at least one percent of the emission bandwidth of the fundamental emission of the transmitter may be employed.

4.4.2 TEST SETUP

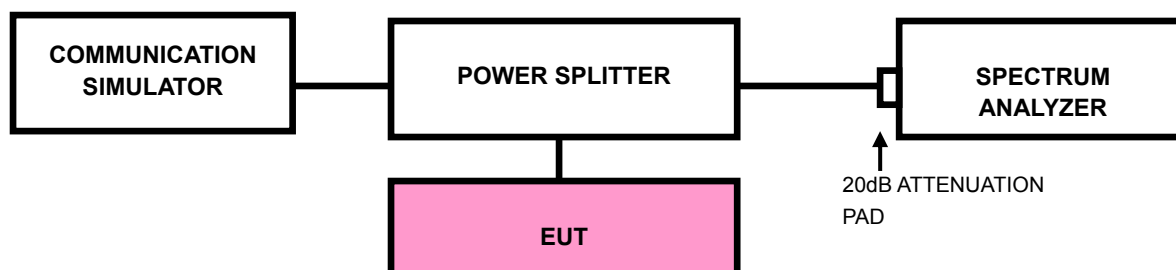

4.4.3 TEST PROCEDURES

- All measurements were done at low and high operational frequency range.
- The center frequency of spectrum is the band edge frequency and span is 1.5 MHz. RB of the spectrum is 3kHz and VB of the spectrum is 10kHz (GPRS).
- The center frequency of spectrum is the band edge frequency and span is 10MHz. RB of the spectrum is 100kHz and VB of the spectrum is 300kHz (WCDMA/HSDPA/HSUPA).
- Record the max trace plot into the test report.



A D T

4.4.4 TEST RESULTS

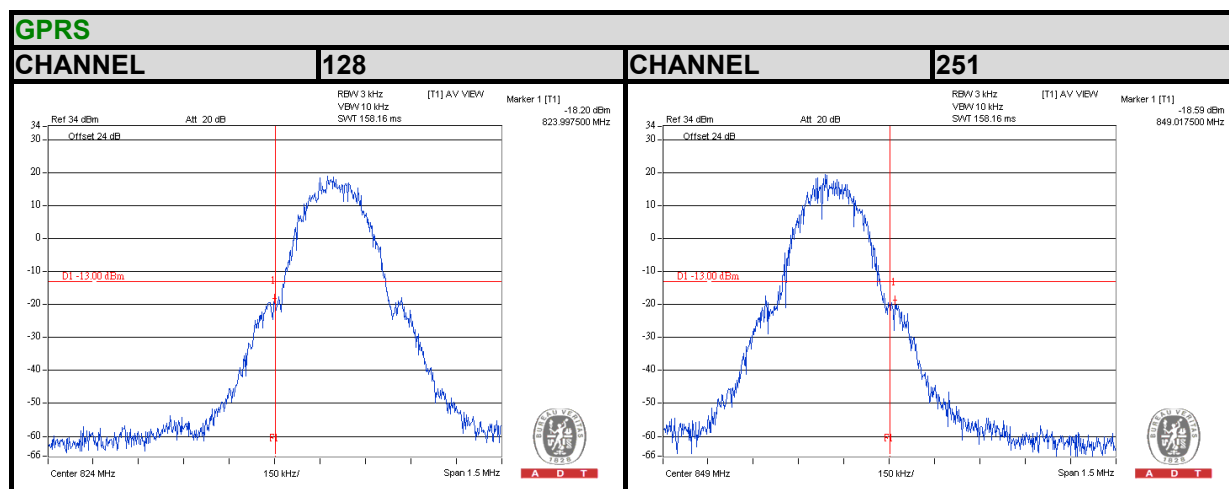



A D T

WCDMA

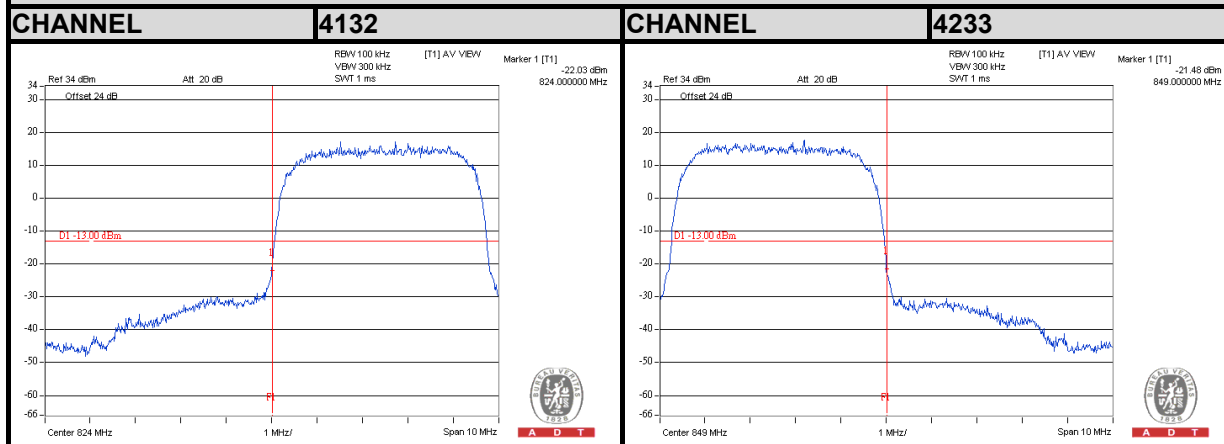

HSDPA

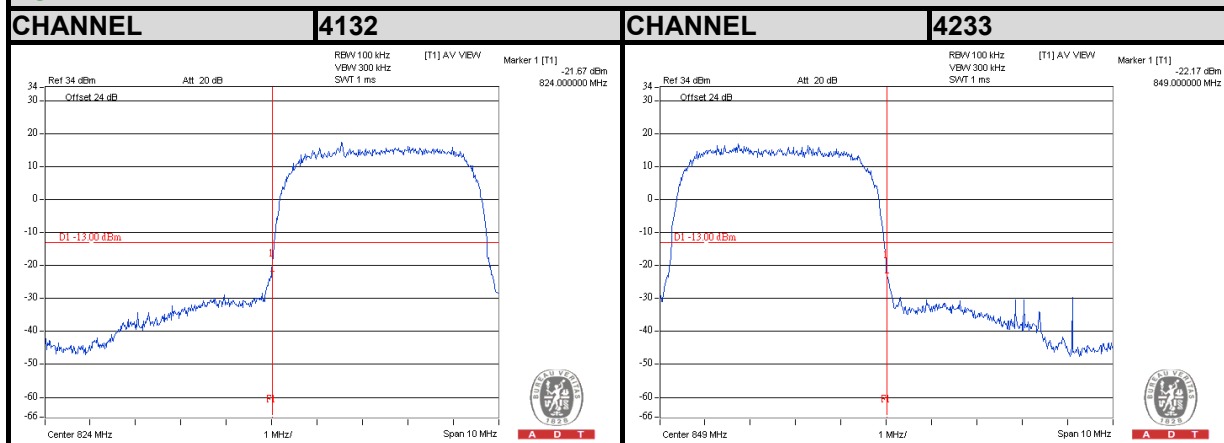

HSUPA

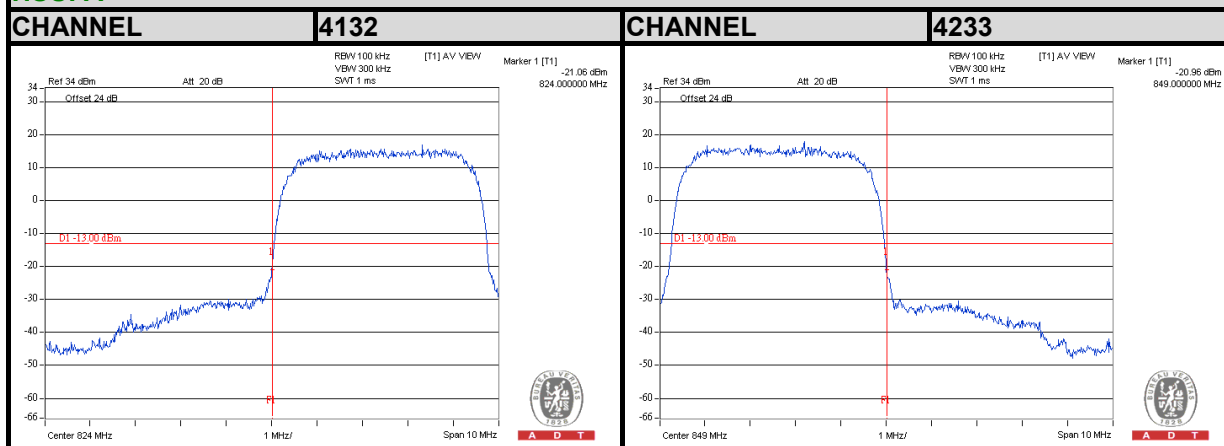

4.5 CONDUCTED SPURIOUS EMISSIONS

4.5.1 LIMITS OF CONDUCTED SPURIOUS EMISSIONS MEASUREMENT

The power of any emission outside of the authorized operating frequency ranges must be attenuated below the transmitting power (P) by a factor of at least $43 + 10 \log(P)$ dB. The emission limit equal to -13dBm .

4.5.2 TEST PROCEDURE

- a. The EUT makes a phone call to the communication simulator. All measurements were done at low, middle and high operational frequency range.
- b. Measuring frequency range is from 9 kHz to 9GHz. 20dB attenuation pad is connected with spectrum. RBW=1MHz and VBW=3MHz is used for conducted emission measurement.

4.5.3 TEST SETUP

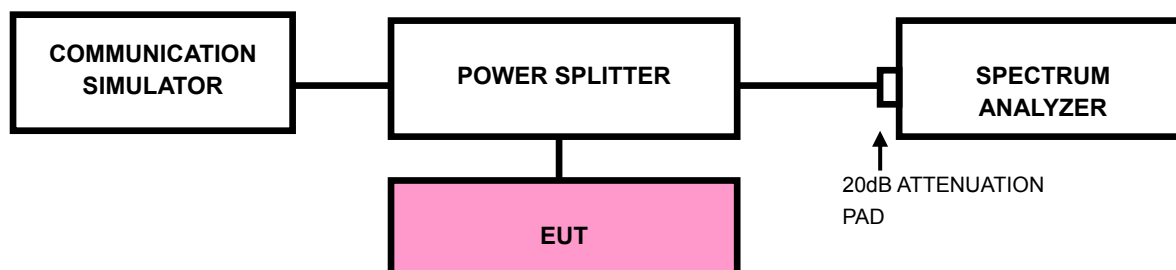

4.5.4 TEST RESULTS

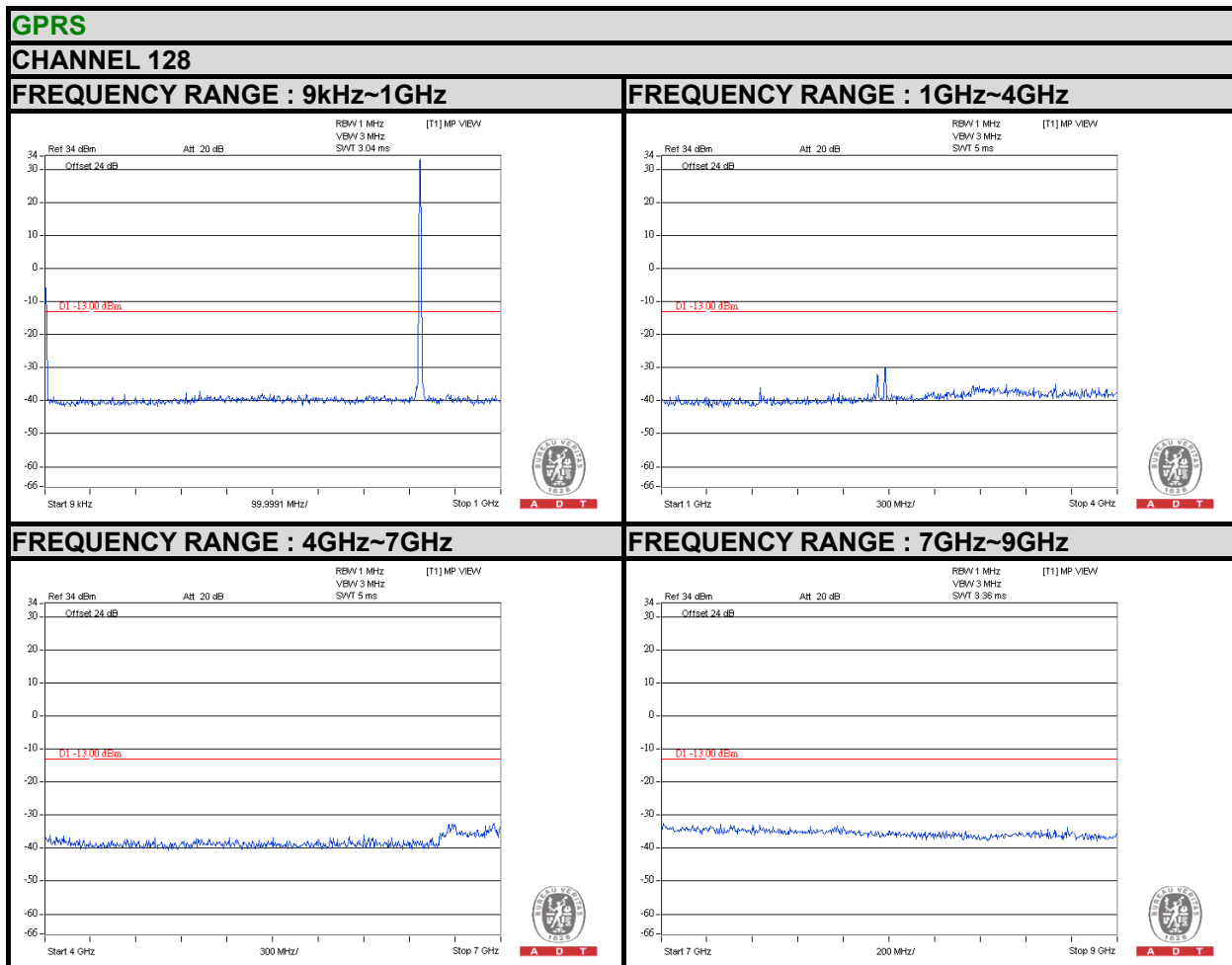



A D T

GPRS

CHANNEL 189

FREQUENCY RANGE : 9kHz~1GHz

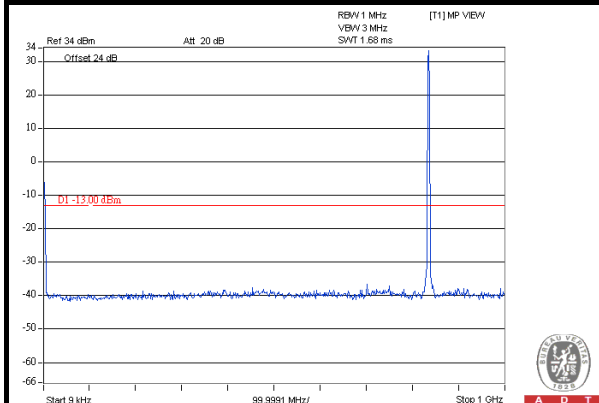

FREQUENCY RANGE : 1GHz~4GHz

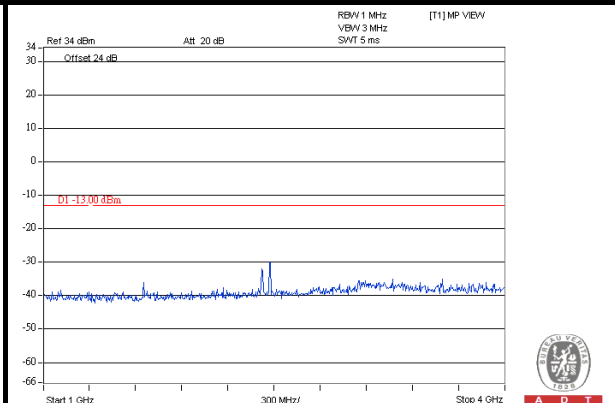

FREQUENCY RANGE : 4GHz~7GHz

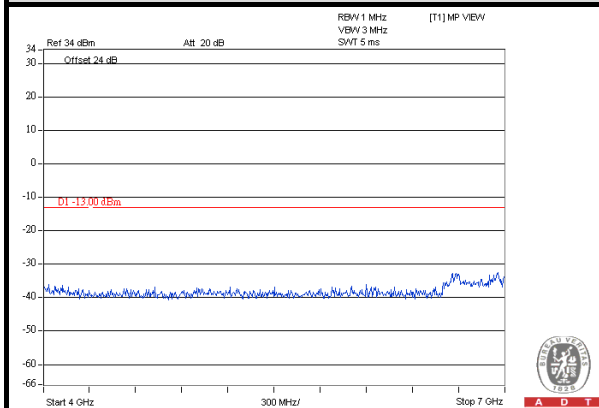

FREQUENCY RANGE : 7GHz~9GHz

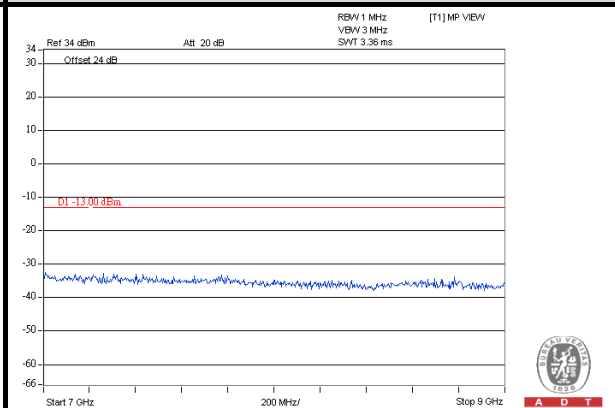



A D T

GPRS

CHANNEL 251

FREQUENCY RANGE : 9kHz~1GHz

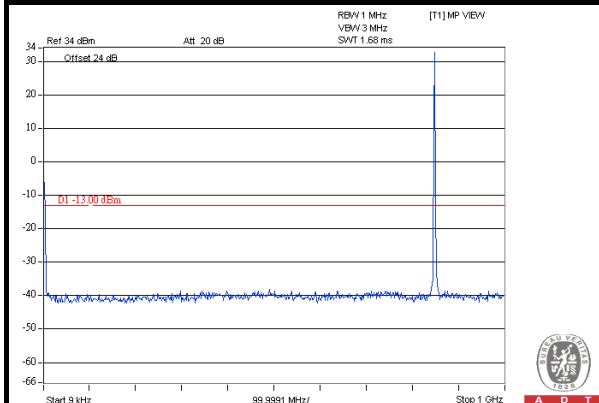

FREQUENCY RANGE : 1GHz~4GHz

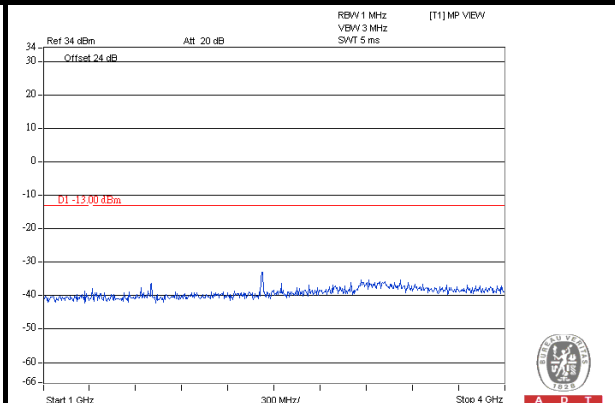

FREQUENCY RANGE : 4GHz~7GHz

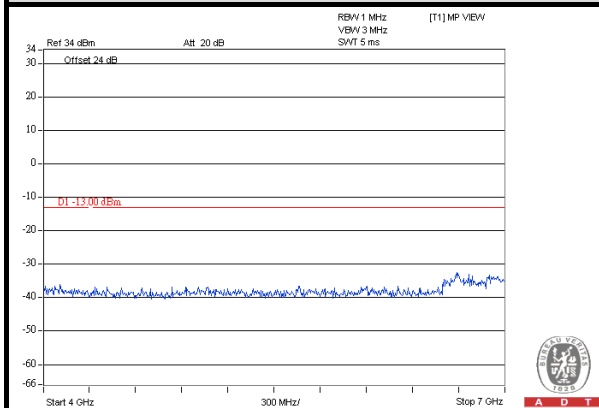

FREQUENCY RANGE : 7GHz~9GHz

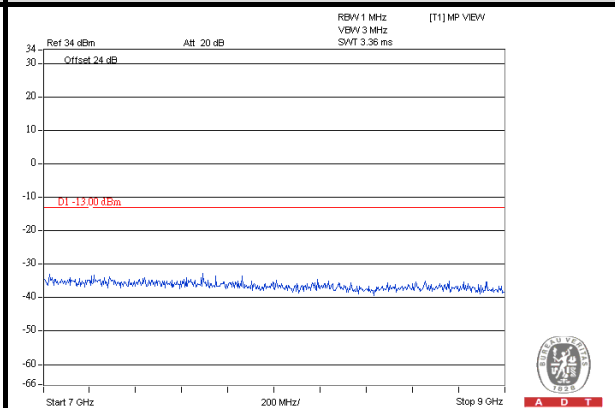



A D T

WCDMA

CHANNEL 4132

FREQUENCY RANGE : 9kHz~1GHz

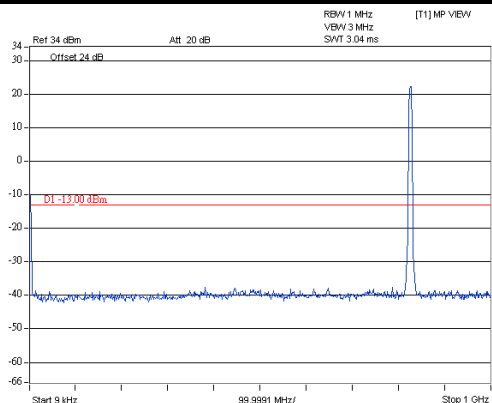

FREQUENCY RANGE : 1GHz~4GHz

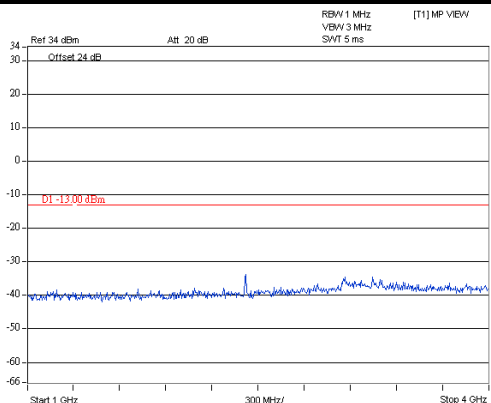

FREQUENCY RANGE : 4GHz~7GHz

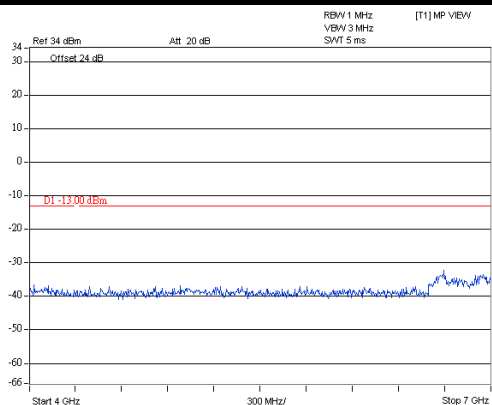

FREQUENCY RANGE : 7GHz~9GHz

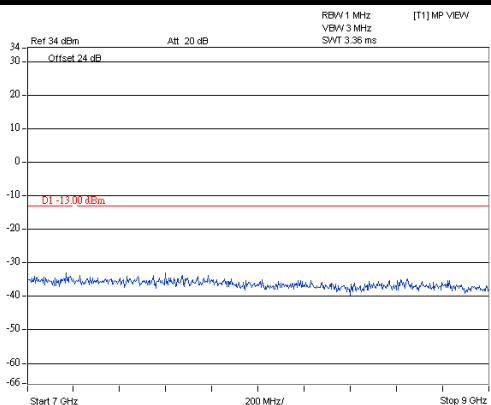

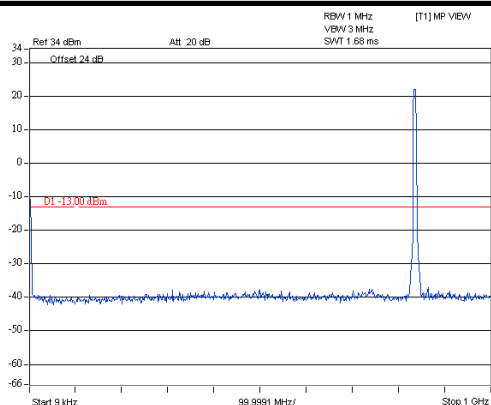
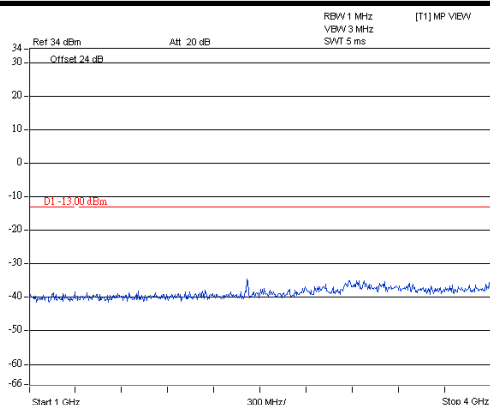
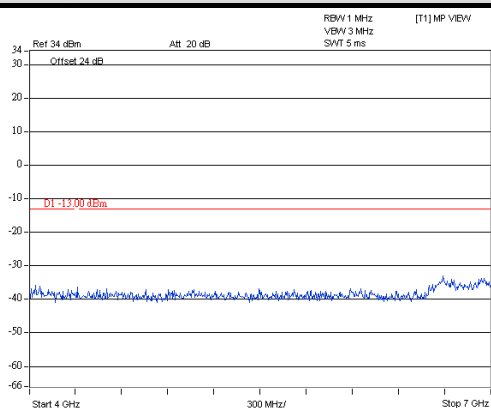
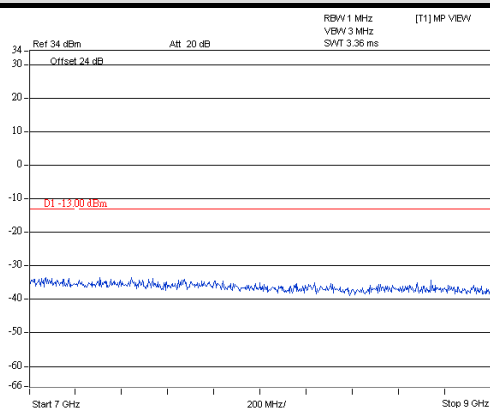
WCDMA**CHANNEL 4182****FREQUENCY RANGE : 9kHz~1GHz****FREQUENCY RANGE : 1GHz~4GHz****FREQUENCY RANGE : 4GHz~7GHz****FREQUENCY RANGE : 7GHz~9GHz**

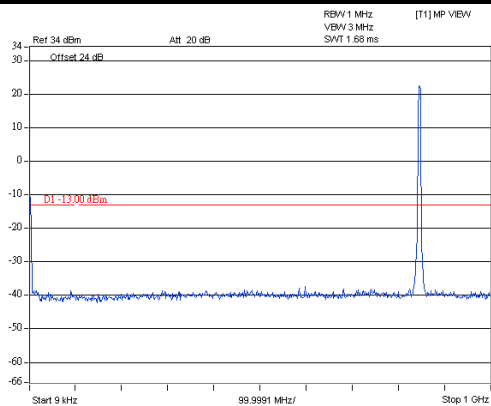
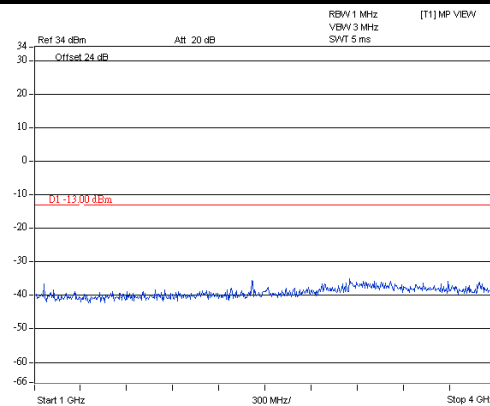
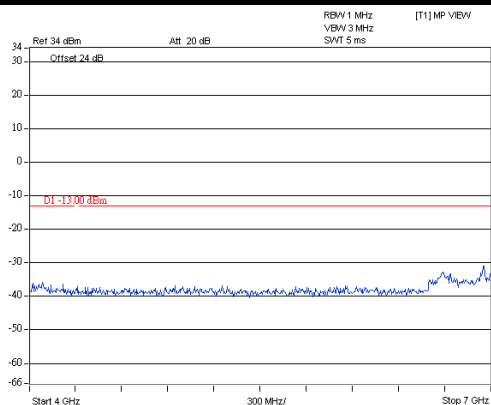
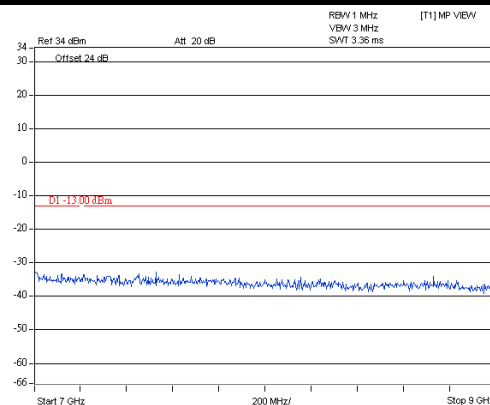
WCDMA**CHANNEL 4233****FREQUENCY RANGE : 9kHz~1GHz****FREQUENCY RANGE : 1GHz~4GHz****FREQUENCY RANGE : 4GHz~7GHz****FREQUENCY RANGE : 7GHz~9GHz**



A D T

HSDPA

CHANNEL 4132

FREQUENCY RANGE : 9kHz~1GHz

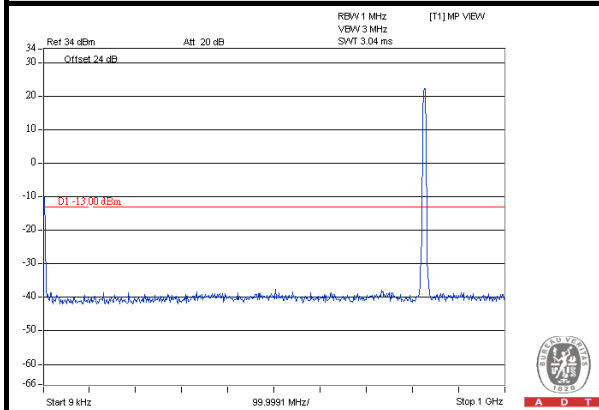

FREQUENCY RANGE : 1GHz~4GHz

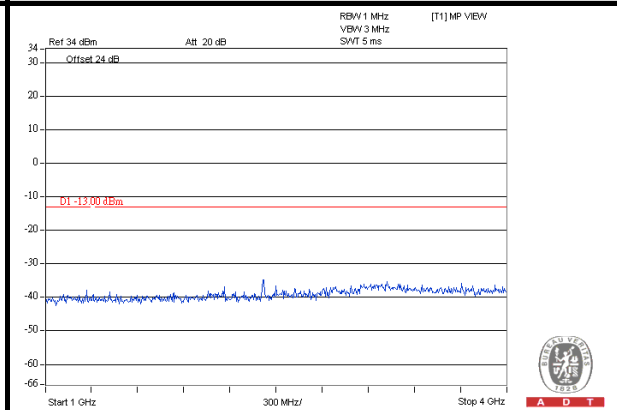

FREQUENCY RANGE : 4GHz~7GHz

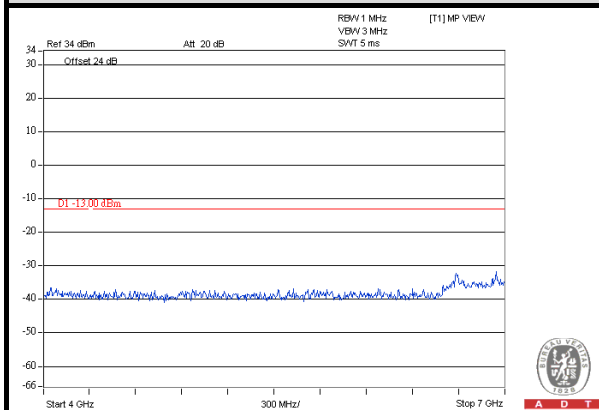

FREQUENCY RANGE : 7GHz~9GHz

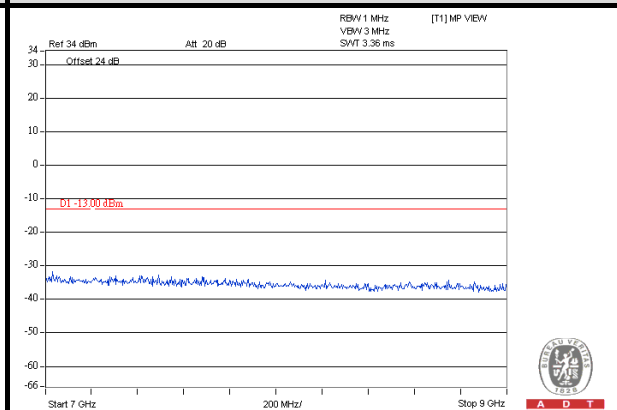



A D T

HSDPA

CHANNEL 4182

FREQUENCY RANGE : 9kHz~1GHz

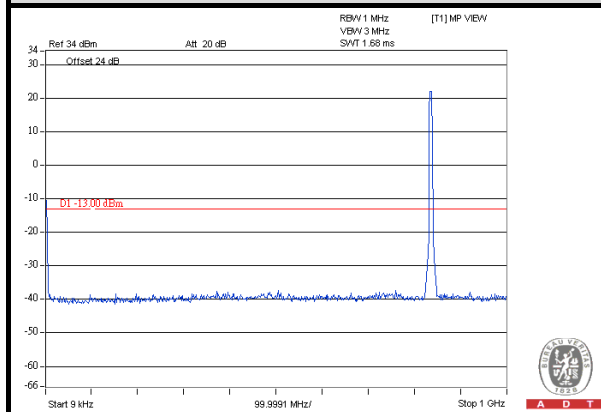

FREQUENCY RANGE : 1GHz~4GHz

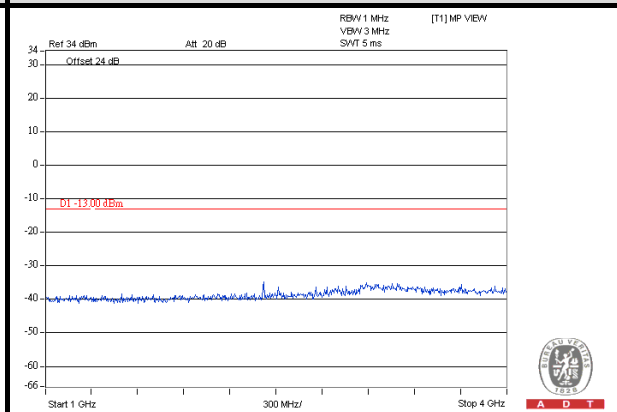

FREQUENCY RANGE : 4GHz~7GHz

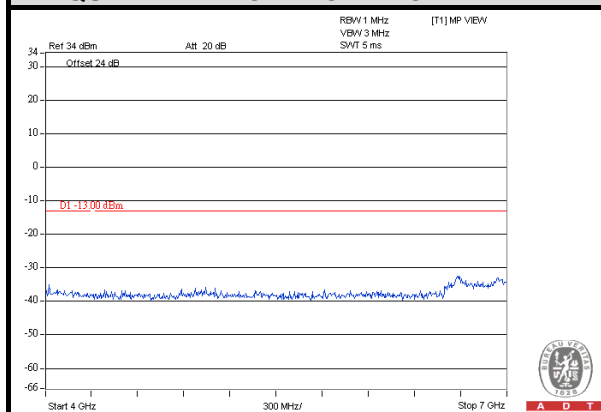

FREQUENCY RANGE : 7GHz~9GHz

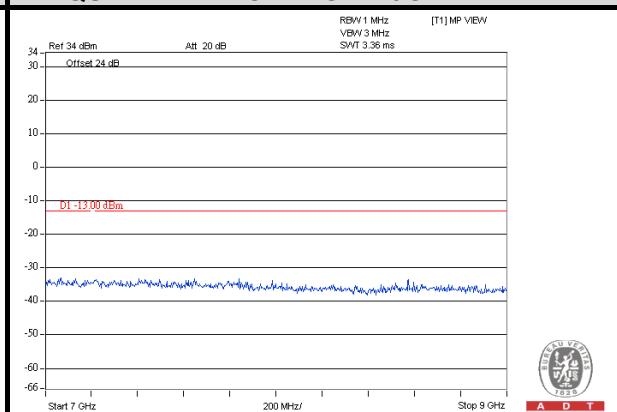

HSDPA

CHANNEL 4233

FREQUENCY RANGE : 9kHz~1GHz

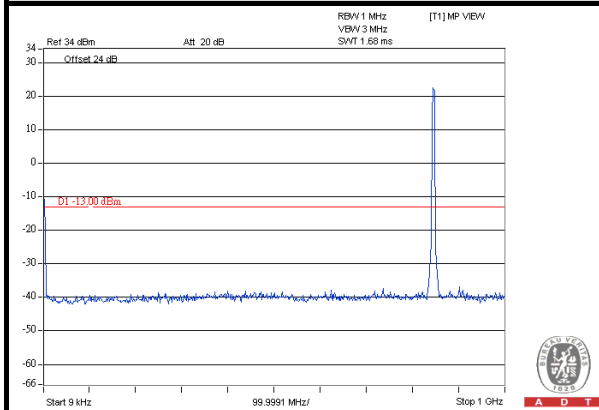

FREQUENCY RANGE : 1GHz~4GHz

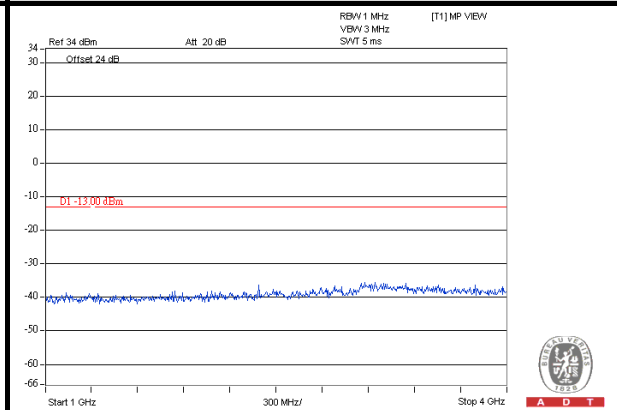

FREQUENCY RANGE : 4GHz~7GHz

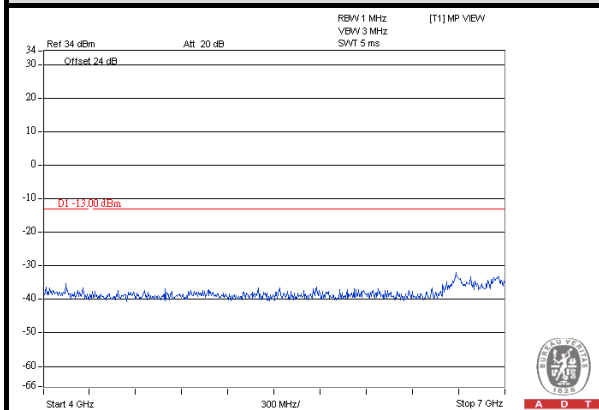

FREQUENCY RANGE : 7GHz~9GHz

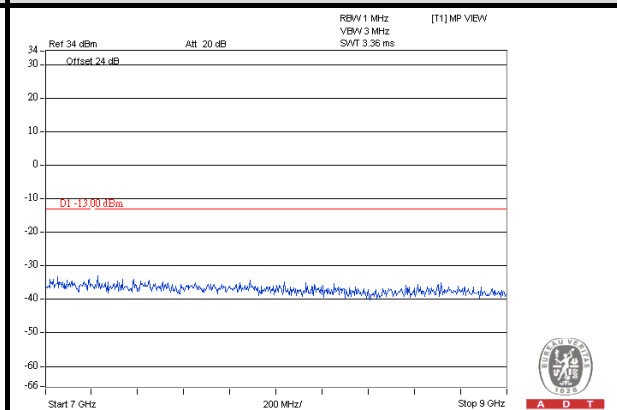

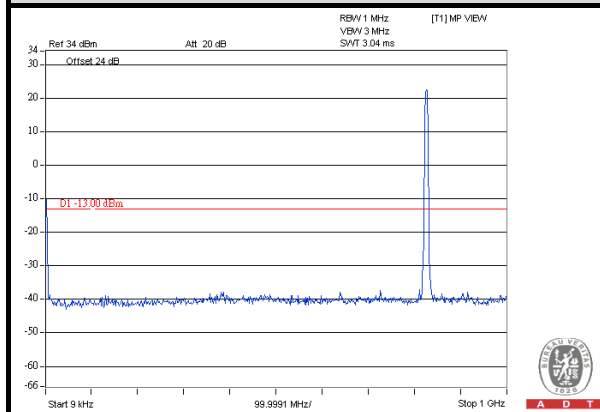
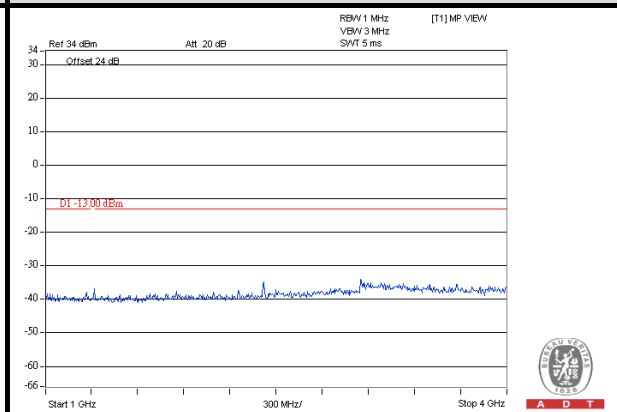
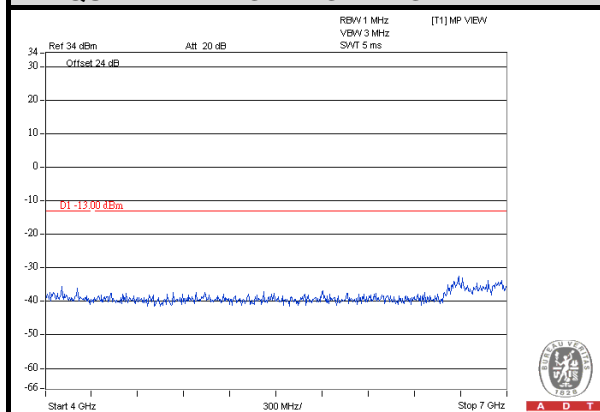
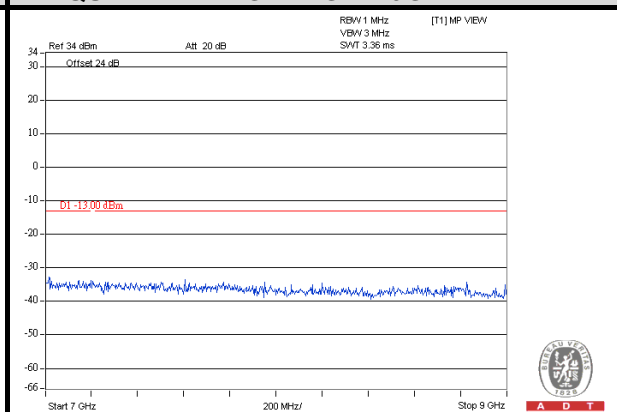
HSUPA**CHANNEL 4132****FREQUENCY RANGE : 9kHz~1GHz****FREQUENCY RANGE : 1GHz~4GHz****FREQUENCY RANGE : 4GHz~7GHz****FREQUENCY RANGE : 7GHz~9GHz**

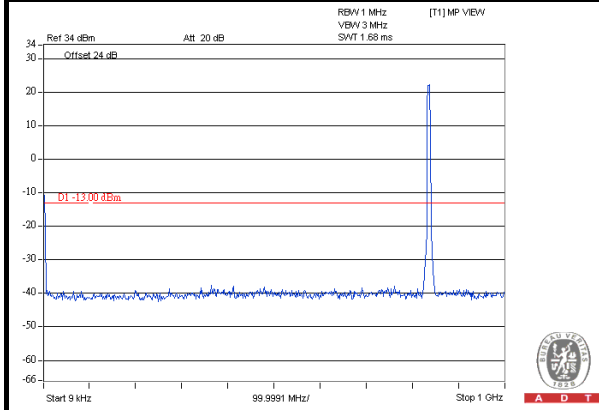
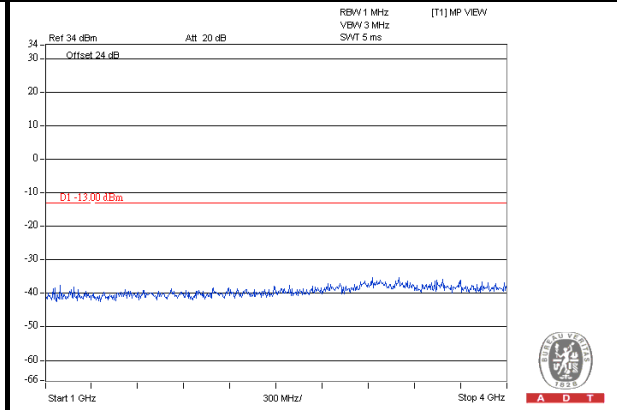
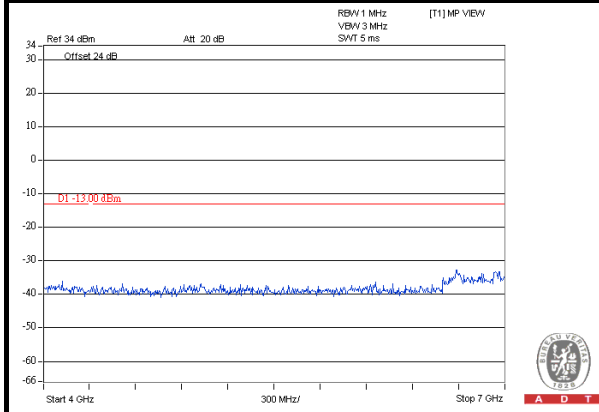
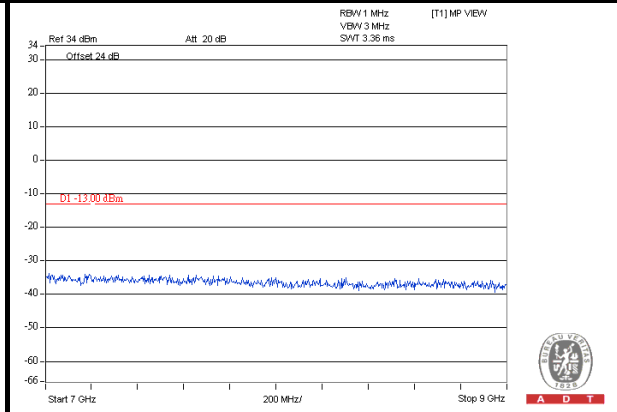
HSUPA**CHANNEL 4182****FREQUENCY RANGE : 9kHz~1GHz****FREQUENCY RANGE : 1GHz~4GHz****FREQUENCY RANGE : 4GHz~7GHz****FREQUENCY RANGE : 7GHz~9GHz**



A D T

HSUPA

CHANNEL 4233

FREQUENCY RANGE : 9kHz~1GHz

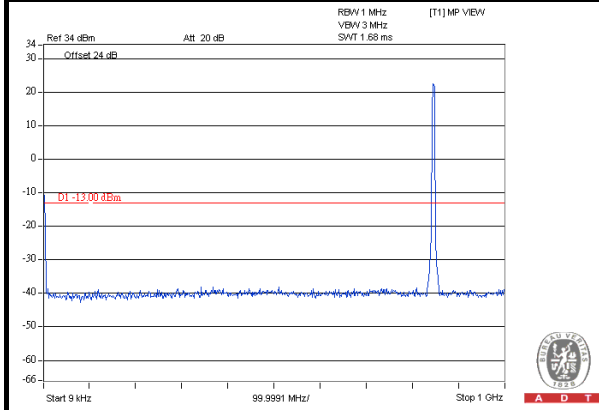

FREQUENCY RANGE : 1GHz~4GHz

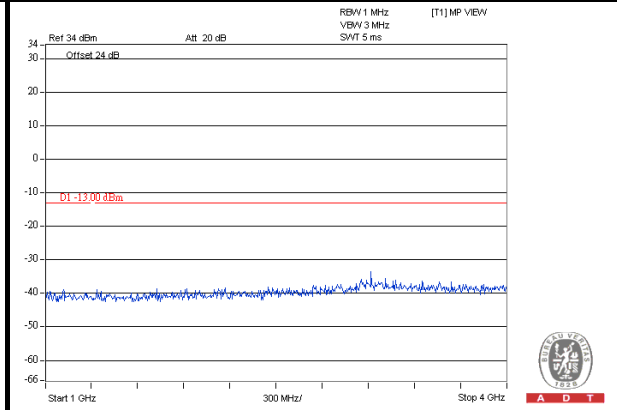

FREQUENCY RANGE : 4GHz~7GHz

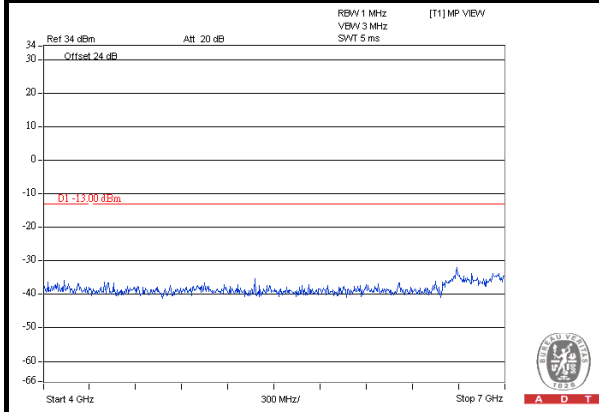

FREQUENCY RANGE : 7GHz~9GHz

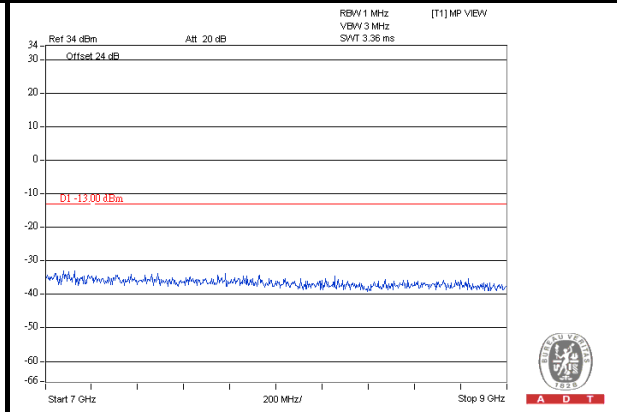



4.6 RADIATED EMISSION MEASUREMENT

4.6.1 LIMITS OF RADIATED EMISSION MEASUREMENT

The power of any emission outside of the authorized operating frequency ranges must be attenuated below the transmitting power (P) by a factor of at least $43 + 10 \log(P)$ dB. The emission limit equal to -13dBm .

4.6.2 TEST PROCEDURES

- a. Substitution method is used for E.I.R.P measurement. In the semi-anechoic chamber, EUT placed on the 0.8m height of Turn Table, rotated the table around 360 degrees to search the maximum radiation power and receiver antenna shall be rotated vertical and horizontal polarization and moved height from 1m to 4m to find the maximum polar radiated power. The “Read Value” is the spectrum reading the maximum power value.
- b. The substitution horn antenna is substituted for EUT at the same position and signals generator export the CW signal to the substitution antenna via a TX cable. Rotated the Turn Table and moved receiving antenna to find the maximum radiation power. Adjust output power level of S.G to get a Value of spectrum reading equal to “Read Value” of step a. Record the power level of S.G
- c. $\text{EIRP} = \text{Output power level of S.G} - \text{TX cable loss} + \text{Antenna gain of substitution horn}$.
- d. E.R.P power can be calculated form E.I.R.P power by subtracting the gain of dipole, $\text{E.R.P power} = \text{E.I.P.R power} - 2.15\text{dBi}$.

NOTE: The resolution bandwidth and video bandwidth of test receiver/spectrum analyzer is 1MHz/3MHz.

4.6.3 DEVIATION FROM TEST STANDARD

No deviation

4.6.4 TEST SETUP

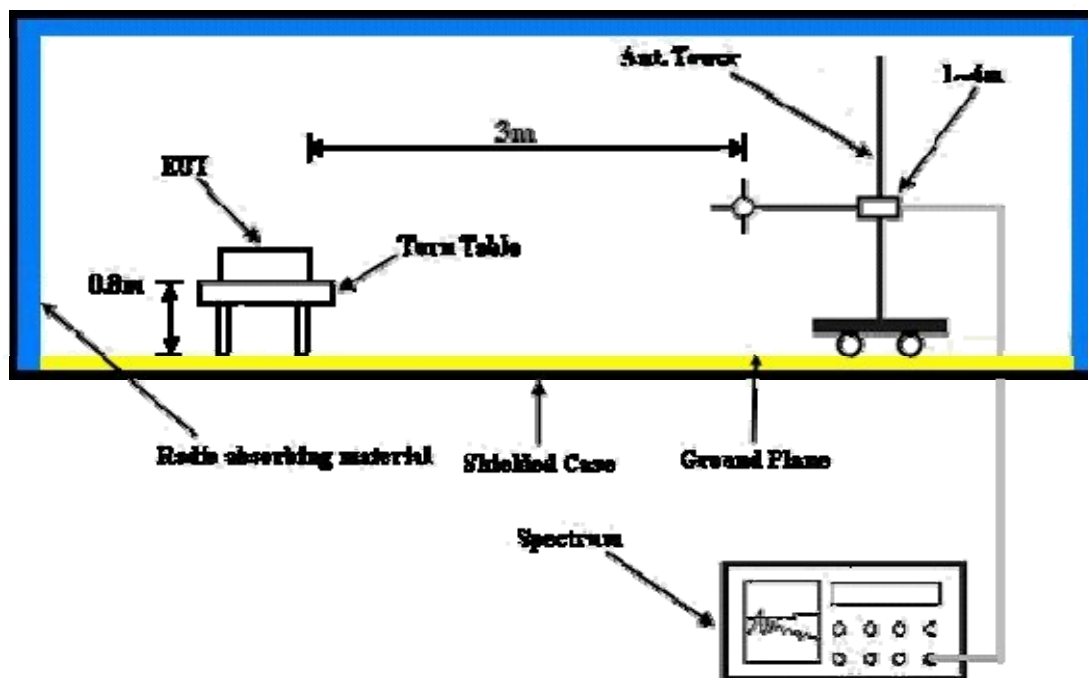

For the actual test configuration, please refer to the attached file (Test Setup Photo).



A D T

4.6.5 TEST RESULTS

Below 1GHz

GPRS

MODE	TX channel 189	FREQUENCY RANGE	Below 1000MHz
ENVIRONMENTAL CONDITIONS	25deg. C, 68%RH	INPUT POWER	120Vac, 60Hz
TEST MODE	A	TESTED BY	Brad Tung

ANTENNA POLARITY & TEST DISTANCE: HORIZONTAL AT 3 M							
No.	Freq. (MHz)	Reading (dBm)	S.G Power Value (dBm)	Correction Factor (dB)	ERP (dBm)	Limit (dBm)	Margin (dB)
1	47.46	-57.49	-47.34	-10.16	-57.50	-13.00	-44.50
2	61.04	-53.37	-50.79	-7.33	-58.12	-13.00	-45.12
3	204.60	-58.74	-72.38	5.46	-66.92	-13.00	-53.92
4	322.94	-59.81	-70.27	5.16	-65.11	-13.00	-52.11
5	396.66	-60.64	-67.47	5.27	-62.20	-13.00	-49.20
6	468.44	-62.91	-69.61	5.00	-64.61	-13.00	-51.61

ANTENNA POLARITY & TEST DISTANCE: VERTICAL AT 3 M							
No.	Freq. (MHz)	Reading (dBm)	S.G Power Value (dBm)	Correction Factor (dB)	ERP (dBm)	Limit (dBm)	Margin (dB)
1	59.10	-40.22	-40.45	-7.79	-48.24	-13.00	-35.24
2	179.38	-58.99	-63.90	2.83	-61.07	-13.00	-48.07
3	319.06	-63.48	-70.70	5.15	-65.55	-13.00	-52.55
4	394.72	-60.34	-65.98	5.26	-60.72	-13.00	-47.72
5	513.06	-57.22	-61.23	4.83	-56.40	-13.00	-43.40
6	528.58	-57.12	-60.76	4.74	-56.02	-13.00	-43.02

REMARKS:

1. ERP(dBm) = S.G Power Value (dBm) + Correction Factor (dB).
2. Correction Factor = gain of substitution antenna + cable loss



A D T

MODE	TX channel 189	FREQUENCY RANGE	Below 1000MHz
ENVIRONMENTAL CONDITIONS	25deg. C, 68%RH	INPUT POWER	120Vac, 60Hz
TEST MODE	B	TESTED BY	Brad Tung

ANTENNA POLARITY & TEST DISTANCE: HORIZONTAL AT 3 M							
No.	Freq. (MHz)	Reading (dBm)	S.G Power Value (dBm)	Correction Factor (dB)	ERP (dBm)	Limit (dBm)	Margin (dB)
1	57.16	-54.76	-49.89	-8.21	-58.10	-13.00	-45.10
2	101.78	-58.92	-67.48	0.80	-66.68	-13.00	-53.68
3	208.48	-59.71	-73.51	5.46	-68.05	-13.00	-55.05
4	321.00	-58.25	-68.78	5.15	-63.63	-13.00	-50.63
5	400.54	-60.81	-67.58	5.28	-62.30	-13.00	-49.30
6	452.92	-63.41	-69.94	5.06	-64.88	-13.00	-51.88

ANTENNA POLARITY & TEST DISTANCE: VERTICAL AT 3 M							
No.	Freq. (MHz)	Reading (dBm)	S.G Power Value (dBm)	Correction Factor (dB)	ERP (dBm)	Limit (dBm)	Margin (dB)
1	57.16	-41.05	-40.69	-8.21	-48.90	-13.00	-35.90
2	105.66	-58.56	-65.32	0.65	-64.67	-13.00	-51.67
3	266.68	-62.76	-71.94	5.31	-66.63	-13.00	-53.63
4	321.00	-63.80	-70.98	5.15	-65.83	-13.00	-52.83
5	489.78	-58.34	-62.99	4.92	-58.07	-13.00	-45.07
6	526.64	-57.42	-61.12	4.76	-56.36	-13.00	-43.36

REMARKS:

1. $ERP(dBm) = S.G\ Power\ Value\ (dBm) + Correction\ Factor\ (dB)$.
2. Correction Factor = gain of substitution antenna + cable loss



A D T

WCDMA

MODE	TX channel 4132	FREQUENCY RANGE	Below 1000MHz
ENVIRONMENTAL CONDITIONS	25deg. C, 68%RH	INPUT POWER	120Vac, 60Hz
TEST MODE	A	TESTED BY	Sun Lin

ANTENNA POLARITY & TEST DISTANCE: HORIZONTAL AT 3 M							
No.	Freq. (MHz)	Reading (dBm)	S.G Power Value (dBm)	Correction Factor (dB)	ERP (dBm)	Limit (dBm)	Margin (dB)
1	57.16	-47.41	-42.54	-8.21	-50.75	-13.00	-37.75
2	92.08	-33.15	-42.68	1.07	-41.61	-13.00	-28.61
3	105.66	-38.19	-46.64	0.65	-45.99	-13.00	-32.99
4	140.58	-44.39	-50.88	-0.31	-51.19	-13.00	-38.19
5	350.10	-48.79	-58.27	5.21	-53.06	-13.00	-40.06
6	449.04	-51.94	-58.41	5.08	-53.33	-13.00	-40.33
ANTENNA POLARITY & TEST DISTANCE: VERTICAL AT 3 M							
No.	Freq. (MHz)	Reading (dBm)	S.G Power Value (dBm)	Correction Factor (dB)	ERP (dBm)	Limit (dBm)	Margin (dB)
1	53.28	-33.10	-31.57	-9.05	-40.62	-13.00	-27.62
2	82.38	-32.90	-38.52	-0.98	-39.50	-13.00	-26.50
3	233.70	-46.80	-56.09	5.42	-50.67	-13.00	-37.67
4	315.18	-41.32	-48.68	5.15	-43.53	-13.00	-30.53
5	763.32	-57.08	-54.62	4.48	-50.14	-13.00	-37.14
6	871.96	-55.66	-51.16	3.94	-47.22	-13.00	-34.22

REMARKS:

1. ERP(dBm) = S.G Power Value (dBm) + Correction Factor (dB).
2. Correction Factor = gain of substitution antenna + cable loss



A D T

MODE	TX channel 4132	FREQUENCY RANGE	Below 1000MHz
ENVIRONMENTAL CONDITIONS	25deg. C, 68%RH	INPUT POWER	120Vac, 60Hz
TEST MODE	B	TESTED BY	Sun Lin

ANTENNA POLARITY & TEST DISTANCE: HORIZONTAL AT 3 M							
No.	Freq. (MHz)	Reading (dBm)	S.G Power Value (dBm)	Correction Factor (dB)	ERP (dBm)	Limit (dBm)	Margin (dB)
1	30.00	-49.94	-36.12	-12.18	-48.30	-13.00	-35.30
2	53.28	-52.63	-45.46	-9.05	-54.51	-13.00	-41.51
3	86.26	-52.65	-61.63	0.09	-61.54	-13.00	-48.54
4	191.02	-50.04	-62.60	4.33	-58.27	-13.00	-45.27
5	340.40	-55.14	-64.89	5.19	-59.70	-13.00	-46.70
6	474.26	-56.64	-63.33	4.99	-58.34	-13.00	-45.34
ANTENNA POLARITY & TEST DISTANCE: VERTICAL AT 3 M							
No.	Freq. (MHz)	Reading (dBm)	S.G Power Value (dBm)	Correction Factor (dB)	ERP (dBm)	Limit (dBm)	Margin (dB)
1	31.94	-35.43	-33.03	-11.93	-44.96	-13.00	-31.96
2	49.40	-35.52	-32.87	-9.85	-42.72	-13.00	-29.72
3	103.72	-41.26	-48.09	0.73	-47.36	-13.00	-34.36
4	225.94	-44.52	-54.05	5.44	-48.61	-13.00	-35.61
5	291.90	-49.80	-58.02	5.17	-52.85	-13.00	-39.85
6	474.26	-50.89	-55.61	4.99	-50.62	-13.00	-37.62

REMARKS:

1. $ERP(dBm) = S.G \text{ Power Value (dBm)} + \text{Correction Factor (dB)}$.
2. Correction Factor = gain of substitution antenna + cable loss



A D T

ABOVE 1GHz

GPRS

MODE	TX channel 128	FREQUENCY RANGE	Above 1000MHz
ENVIRONMENTAL CONDITIONS	25deg. C, 68%RH	INPUT POWER	120Vac, 60Hz
TESTED BY	Brad Tung		

ANTENNA POLARITY & TEST DISTANCE: HORIZONTAL AT 3 M							
No.	Freq. (MHz)	Reading (dBm)	S.G Power Value (dBm)	Correction Factor (dB)	ERP (dBm)	Limit (dBm)	Margin (dB)
1	2472.60	-51.02	-50.48	6.43	-44.05	-13.00	-31.05

ANTENNA POLARITY & TEST DISTANCE: VERTICAL AT 3 M							
No.	Freq. (MHz)	Reading (dBm)	S.G Power Value (dBm)	Correction Factor (dB)	ERP (dBm)	Limit (dBm)	Margin (dB)
1	2472.60	-46.22	-45.29	6.43	-38.86	-13.00	-25.86

REMARKS:

1. $ERP(dBm) = S.G \text{ Power Value (dBm)} + \text{Correction Factor (dB)}$.
2. Correction Factor = gain of substitution antenna + cable loss



A D T

MODE	TX channel 189	FREQUENCY RANGE	Above 1000MHz
ENVIRONMENTAL CONDITIONS	25deg. C, 68%RH	INPUT POWER	120Vac, 60Hz
TESTED BY	Brad Tung		

ANTENNA POLARITY & TEST DISTANCE: HORIZONTAL AT 3 M							
No.	Freq. (MHz)	Reading (dBm)	S.G Power Value (dBm)	Correction Factor (dB)	ERP (dBm)	Limit (dBm)	Margin (dB)
1	2509.20	-51.75	-51.34	6.45	-44.89	-13.00	-31.89

ANTENNA POLARITY & TEST DISTANCE: VERTICAL AT 3 M							
No.	Freq. (MHz)	Reading (dBm)	S.G Power Value (dBm)	Correction Factor (dB)	ERP (dBm)	Limit (dBm)	Margin (dB)
1	2509.20	-46.57	-45.54	6.45	-39.09	-13.00	-26.09

REMARKS:

1. $ERP(dBm) = S.G \text{ Power Value (dBm)} + \text{Correction Factor (dB)}$.
2. Correction Factor = gain of substitution antenna + cable loss



A D T

MODE	TX channel 251	FREQUENCY RANGE	Above 1000MHz
ENVIRONMENTAL CONDITIONS	25deg. C, 68%RH	INPUT POWER	120Vac, 60Hz
TESTED BY	Brad Tung		

ANTENNA POLARITY & TEST DISTANCE: HORIZONTAL AT 3 M							
No.	Freq. (MHz)	Reading (dBm)	S.G Power Value (dBm)	Correction Factor (dB)	ERP (dBm)	Limit (dBm)	Margin (dB)
1	2546.40	-51.71	-51.07	6.44	-44.63	-13.00	-31.63

ANTENNA POLARITY & TEST DISTANCE: VERTICAL AT 3 M							
No.	Freq. (MHz)	Reading (dBm)	S.G Power Value (dBm)	Correction Factor (dB)	ERP (dBm)	Limit (dBm)	Margin (dB)
1	2546.40	-46.88	-45.74	6.44	-39.30	-13.00	-26.30

REMARKS:

1. $ERP(dBm) = S.G \text{ Power Value (dBm)} + \text{Correction Factor (dB)}$.
2. $\text{Correction Factor} = \text{gain of substitution antenna} + \text{cable loss}$



A D T

WCDMA

MODE	TX channel 4132	FREQUENCY RANGE	Above 1000MHz
ENVIRONMENTAL CONDITIONS	25deg. C, 68%RH	INPUT POWER	120Vac, 60Hz
TESTED BY	Brad Tung		

ANTENNA POLARITY & TEST DISTANCE: HORIZONTAL AT 3 M							
No.	Freq. (MHz)	Reading (dBm)	S.G Power Value (dBm)	Correction Factor (dB)	ERP (dBm)	Limit (dBm)	Margin (dB)
1	1652.80	-58.42	-59.40	5.49	-53.91	-13.00	-40.91

ANTENNA POLARITY & TEST DISTANCE: VERTICAL AT 3 M							
No.	Freq. (MHz)	Reading (dBm)	S.G Power Value (dBm)	Correction Factor (dB)	ERP (dBm)	Limit (dBm)	Margin (dB)
1	1652.80	-59.14	-63.26	5.49	-57.77	-13.00	-44.77

REMARKS:

1. $ERP(dBm) = S.G \text{ Power Value (dBm)} + \text{Correction Factor (dB)}$.
2. Correction Factor = gain of substitution antenna + cable loss



A D T

MODE	TX channel 4182	FREQUENCY RANGE	Above 1000MHz
ENVIRONMENTAL CONDITIONS	25deg. C, 68%RH	INPUT POWER	120Vac, 60Hz
TESTED BY	Brad Tung		

ANTENNA POLARITY & TEST DISTANCE: HORIZONTAL AT 3 M							
No.	Freq. (MHz)	Reading (dBm)	S.G Power Value (dBm)	Correction Factor (dB)	ERP (dBm)	Limit (dBm)	Margin (dB)
1	1672.80	-56.15	-57.19	5.54	-51.65	-13.00	-38.65

ANTENNA POLARITY & TEST DISTANCE: VERTICAL AT 3 M							
No.	Freq. (MHz)	Reading (dBm)	S.G Power Value (dBm)	Correction Factor (dB)	ERP (dBm)	Limit (dBm)	Margin (dB)
1	1672.80	-59.94	-64.01	5.54	-58.47	-13.00	-45.47

REMARKS:

1. $ERP(dBm) = S.G \text{ Power Value (dBm)} + \text{Correction Factor (dB)}$.
2. Correction Factor = gain of substitution antenna + cable loss



A D T

MODE	TX channel 4233	FREQUENCY RANGE	Above 1000MHz
ENVIRONMENTAL CONDITIONS	25deg. C, 68%RH	INPUT POWER	120Vac, 60Hz
TESTED BY	Brad Tung		

ANTENNA POLARITY & TEST DISTANCE: HORIZONTAL AT 3 M							
No.	Freq. (MHz)	Reading (dBm)	S.G Power Value (dBm)	Correction Factor (dB)	ERP (dBm)	Limit (dBm)	Margin (dB)
1	1693.20	-57.25	-58.35	5.59	-52.76	-13.00	-39.76

ANTENNA POLARITY & TEST DISTANCE: VERTICAL AT 3 M							
No.	Freq. (MHz)	Reading (dBm)	S.G Power Value (dBm)	Correction Factor (dB)	ERP (dBm)	Limit (dBm)	Margin (dB)
1	1693.20	-57.78	-61.80	5.59	-56.21	-13.00	-43.21

REMARKS:

1. $ERP(dBm) = S.G\ Power\ Value\ (dBm) + Correction\ Factor\ (dB)$.
2. Correction Factor = gain of substitution antenna + cable loss



A D T

5 PHOTOGRAPHS OF THE TEST CONFIGURATION

Please refer to the attached file (Test Setup Photo).



A D T

6 INFORMATION ON THE TESTING LABORATORIES

We, Bureau Veritas Consumer Products Services (H.K.) Ltd., Taoyuan Branch, were founded in 1988 to provide our best service in EMC, Radio, Telecom and Safety consultation. Our laboratories are accredited and approved according to ISO/IEC 17025.

If you have any comments, please feel free to contact us at the following:

Linko EMC/RF Lab:

Tel: 886-2-26052180

Fax: 886-2-26051924

Hsin Chu EMC/RF Lab:

Tel: 886-3-5935343

Fax: 886-3-5935342

Hwa Ya EMC/RF/Safety/Telecom Lab:

Tel: 886-3-3183232

Fax: 886-3-3270892

Email: service.adt@tw.bureauveritas.com

Web Site: www.adt.com.tw

The address and road map of all our labs can be found in our web site also.



A D T

7 APPENDIX A – MODIFICATIONS RECORDERS FOR ENGINEERING CHANGES TO THE EUT BY THE LAB

No any modifications are made to the EUT by the lab during the test.

---END---