

KMP8S3AA1-1A

Instruction Manual

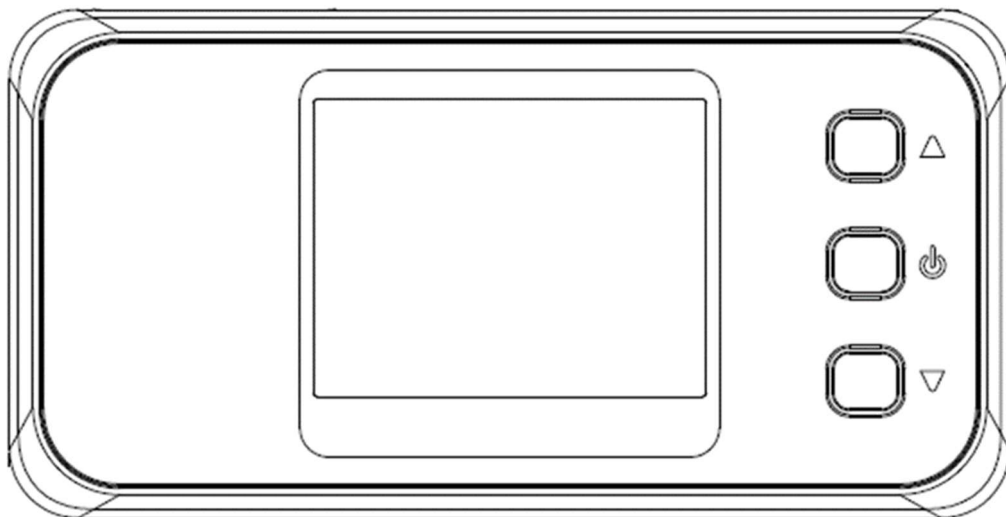

Contents

Contents.....	2
Important Product Information	3
Safety Instructions	4
Notice.....	8
1. Package Contents.....	11
2. Part Names and Functions.....	12
3. Using nanoSIM Card.....	13
4. Charging the Battery Pack	14
5. Web Setting.....	15
6. Products Specifications.....	18

Windows® and Windows 10® are registered trademarks of Microsoft Corporation in the United States and other countries.
Windows 10® is an operating system.

Copyright© NEC Platforms, Ltd. 2022

Important Product Information

Important safety information regarding radio frequency (RF) exposure and use when worn

The product "KMP8S3AA1-1A" is declared to conform with the essential requirements of European Union Directive 2014/53/EC RE Directive.

This wireless portable device complies with the EU requirements for exposure to radio waves.

Your wireless portable device is a radio transceiver and receiver. It is designed not to exceed the SAR* (Specific Absorption Rate) limits** for exposure to radiofrequency (RF) energy by European Union Directives. The Max. SAR* value is ****W/kg (10 g) when it is worn on the body. To comply with the RF Exposure limits

For body-worn operating conditions please use belt-clips, holsters, and/or accessories that have no metallic component in the assembly and must provide at least 0.5cm separation between the device and the user's body.

* The exposure standard for wireless portable devices employs a unit of measurement known as the Specific Absorption Rate, or SAR.

** The SAR limit recommended by the International Commission on Non-Ionizing Radiation Protection (ICNIRP) is 2W/kg averaged over 10g of tissue.

*** Tests for SAR have been conducted using standard operating positions with the transmitting at its highest certified power level in all tested frequency bands. Although the SAR is determined at the highest certified power level, the actual SAR level of the wireless portable device while operating can be well below the maximum value. This is because the wireless portable device is designed to operate at multiple power levels so as to use only the power required to reach the network. In general, the closer you are to a base station antenna, the lower the power output.

RE Directive



We, NEC Platforms, Ltd. hereby, declare that the residential gateway model KMP8S3AA1-1A is in compliance with the essential requirements and other relevant provisions of Directive 2014/53/EC.

Safety Instructions

Please read these Safety Instructions carefully before using this product. These Safety Instructions show items that must be followed to prevent danger to any person and damage to property. Alert symbols below are important to fully understand these Safety Instructions.

Alert symbols in this instruction manual



Warning

: Indicates a hazardous situation which could result in death or serious injury.



Caution

: Indicates a situation which could result in minor injury or physical damage.

Other alert symbols

■ Warnings and cautions



Flammable



Electric shock



High Temperature

■ Prohibited actions



General



No disassembly



No water



No wet hands



No naked flames



Warning

Battery

- Do not get any metal objects such as wire come into contact with the battery terminal.

Do not carry or store the terminal together with any metal objects such as a necklace.

Ignition, explosion, overheating or leakage of the battery pack may result.





Warning

- Do not throw the product into fire.
Ignition, explosion, overheating or leakage of the battery may result.
- Do not pierce the product with a nail, hit it with a hammer or step on it.
Ignition, explosion, overheating or leakage of the battery may result.
- If the battery fluid gets into your eyes, immediately flush with clean water and consult a doctor. Do not rub the eyes. Otherwise, blindness may result.
- If the battery leaks or emits unusual odor, immediately stop using the terminal and keep away from the open fire.
Otherwise, the leaked battery fluid may ignite, resulting in fire or burst.
- Be careful not to let your pets bite the product.
Otherwise, Ignition, explosion, overheating or leakage of the battery may result.



Caution

CAUTION : RISK OF EXPLOSION IF BATTERY IS REPLACED BY AN INCORRECT TYPE. DISPOSE OF USED BATTERIES ACCORDING TO THE INSTRUCTIONS



Warning

In these cases

- Do not dispose of old batteries with ordinary household waste.
Ignition or environmental damage may result.
Cover the battery terminals with a non-conductive tape and dispose of them in accordance with local waste disposal regulations.



● Do not use or charge a wet product.
Ignition, explosion, overheating or leakage of the battery may result.



● If the liquid inside the battery leaks out, keep the liquid away from your skin such as face or hands. Otherwise, blindness or injury to your skin may result.
If the liquid gets into your eyes or mouth, or attaches to your skin or clothing, flush with clean water immediately.
If the liquid gets into your eyes or mouth, immediately flush with water and then consult a doctor.





Warning

Other warnings

- Turn off this product in any place where use of a wireless device is prohibited, for example in an airplane or hospital. Otherwise, it may influence electronics and medical devices, and cause an incident.
- Do not place or use this product near high-precision electronics or devices which handle weak signals, for example pacemakers. Otherwise, electronics such as pacemakers may malfunction. Do not use this product near medical electronics, or in any place where you are prohibited from using this product, for example in a hospital.
- Do not place this product near vases, pots, cups, cosmetics, vessels with chemicals or water, or near any small metal objects (staples etc.) which could fall through the ventilation slots. If this product gets wet or a short circuit occurs, it may cause a fire, electric shock or malfunction.
- Do not place or use this product in a humid location such as a bathroom and humidifier. Otherwise, a fire, electric shock or malfunction may occur.



Notice

Indicates a situation which could result in this product performing poorly or malfunctioning.

What you must not do

- Do not drop or hit this product. Otherwise, it may malfunction.
- Do not leave this product in a cold place such as an ice warehouse. Otherwise, this product may operate abnormally.
- Disconnect all cords before moving this product. Otherwise, it may malfunction.
- This product may operate abnormally if the connecting cords are disconnected when it is on, or if the connection is unstable. When this product is on, do not touch the connecting parts.
- Do not turn on this product immediately after you turn it off. Wait at least 10 seconds to restart. It may not turn on if you attempt to turn it back on immediately.

Other warnings

- If you turn off or disconnect this product during data communication, communication may fail or data may be damaged. If your data are important, check them against the original.

Notes on wireless LAN

- The standard values of wireless LAN are the maximum theoretical values when communication is carried out with other products with the same configuration as this product. The standard values may not indicate the actual data transfer rate.
- The interconnectivity of this product with other products is not guaranteed.
- Wireless LAN transmission distance and transmission speed varies greatly depending on objects in the surrounding environment such as walls and furniture.

Security notes on wireless LAN products

Wireless LAN has the advantage of a LAN connection without the use of LAN cables if the device is placed within the reach of radio waves. You can send and receive information between devices that use radio waves such as a computer and the wireless LAN access point (base unit). On the other hand, you may encounter the following problems if you do not complete the settings related to security because the radio waves reach beyond all obstacles such as walls if within a certain range.

- Interception of information: Some malicious computer users may intercept radio waves intentionally to discover your IDs, passwords, credit card numbers, e-mails, etc.
- Unauthorized intrusion: Some malicious computer users may access personal or office networks to gain personal or confidential information and send out false data. Also, they may intercept communication content, rewrite it, and then send it out. Furthermore, they may send out computer viruses to destroy data and systems.

Wireless LAN products already have security systems so there is a low probability that any of the above problems will occur if you use the product with these settings.

You should be fully aware of problems which may happen to you if you do not do your security configuration. We recommend that you use this product only after making the security setting you judge to be necessary based on a proper understanding of the problems which may occur if security settings are not configured.

We, NEC Platforms, Ltd., do not take responsibility for any damage caused by a security problem occurring because of a lack of a security measure or an unavoidable issue with the wireless LAN specifications.

In addition, we recommend changing the encryption key and PIN code of the wireless LAN access point (base unit) on a regular basis to ensure safe use of the wireless LAN.

1. Package Contents

This product package contains the following items.

- KMP8S3AA1-1A Terminal

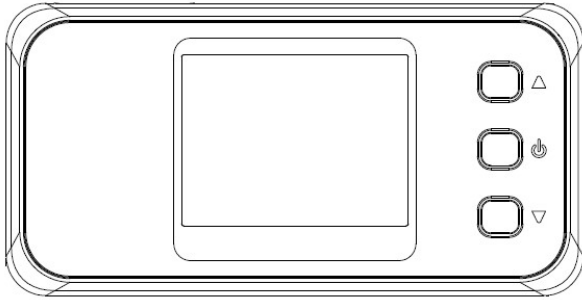

- Instruction manual



2. Part Names and Functions

TOP Side

< KMP8S3AA1-1A >

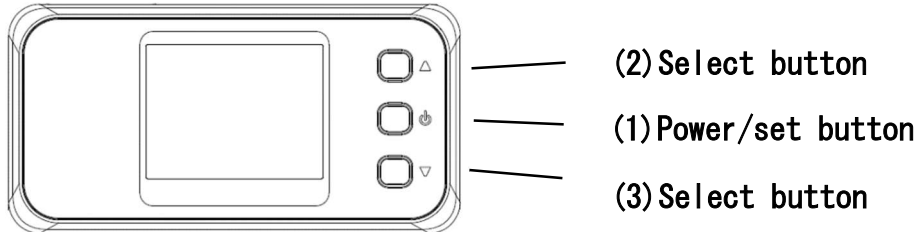

(4) USB slot

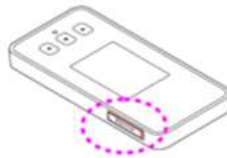

(5) nanoIC Card

Indicators

Name	Display	Description
(1) Power /set button	●	Hold down the button to turn on/off. Short press the button to enter.
(2) Select button	▲	Slide the menu upward.
(3) Select button	▼	Slide the menu downward

Slot

Name	Description
(4) USB slot	USB TypeC
(5) nanoIC Card slot	Insert nanoSIM card

3. Using nanoSIM Card

A nanoSIM is an IC Card that stores personal information such as your phone number. Without the nanoSIM installed in this terminal, you cannot use data communication. For details on handling the nanoSIM, refer to the nanoSIM manual.

When inseting and removing the nanoSIM, hold this terminal with both hands.

<Inseting the nanoSIM>

With the IC chip side up, insert a nanoSIM to the nanoSIM slot.

<Removing the nanoSIM>

Push nanoSIM & Slide the nanoSIM to remove.

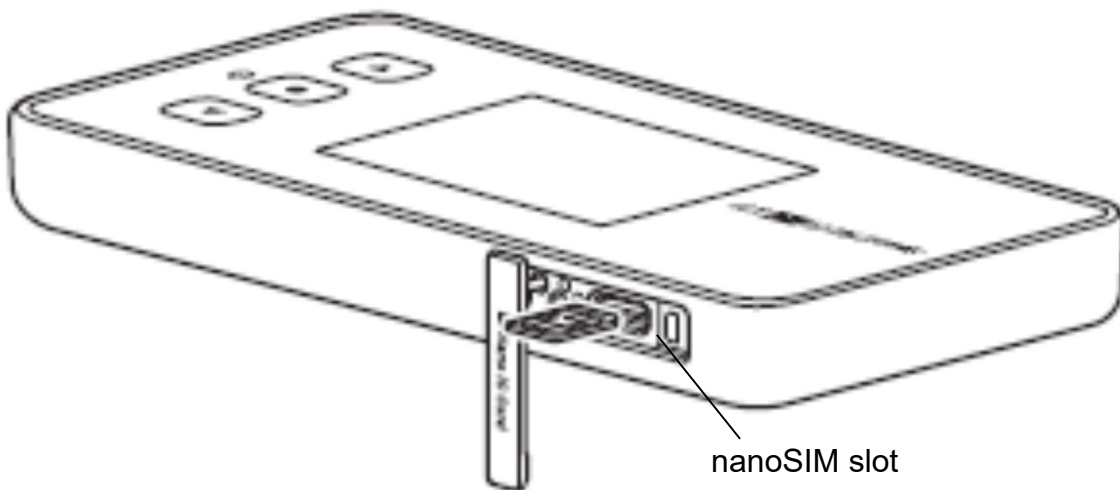

4. Charging the Battery Pack

Charging the Battery Pack

(1) Connect to The USB port of this product and PC with an attached USB TypeC cable.

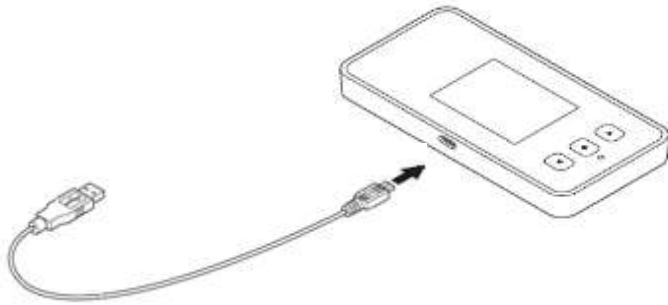

5. Web Setting

- (1) Start the PC and others.
- (2) Start a WWW browser, enter "http://192.168.128.1/".
- (3) Enter the password and click “ログイン”.
The password is "admin" (initial value)

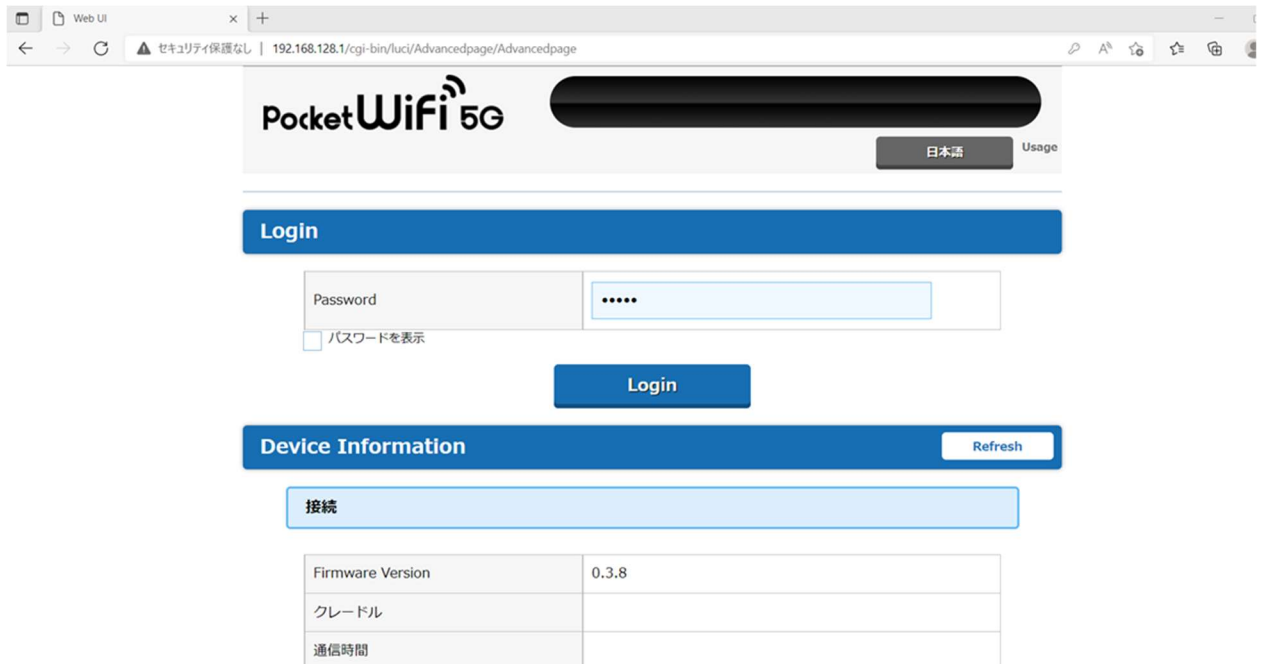

- (2) The "Administrator password changing" screen appears. Change the administrator's password as you like, and write it down in the "Administrator's password" box below and click "変更". If you do not want to change the administrator password, click "スキップ".

The screenshot shows the top navigation bar with the Pocket WiFi 5G logo, a status bar (No SIM, 2.4G, 98%), and buttons for Japanese, Usage, and Logout. Below is a blue header for "Web UIのログインパスワードの変更(Initial Setting for Web UI Login Password)".

本製品は、第三者による不意のアクセスや設定変更を防止するため、Web UIのログインパスワードを変更することをお勧めします。パスワードで使用できるのは、半角英数字と記号です。(?と全角文字、一部の特殊記号は使用できません。)

名前や生年月日など、他人から類推されやすい単語を用いることは避けてください。

Web UIのログインパスワードは、Web UIの[メンテナンス]-[Web UIのログインパスワードの変更]でも変更できます。

「Web UIのログインパスワードの初期値」は、本製品ディスプレイ上の[情報]→[端末情報]でご確認ください。

※Web UIにパスワードを入力する際は本製品電源ボタンを1回押して、ディスプレイを消灯して下さい。

Initial Settings for Web UI Login Password
In order to prevent accidental access or change settings by a third party, this product is designed to be accessed for the first time to enter the Web UI login password.
Using the word which is easy to be guessed from others should avoid a name, a birth date, etc.
Refer to the "Web UI initial login password" from [Information]-[Device Information] on the product display.
To enter the password on the Web UI, press the product power button once to turn off the display.

Web UIのログインパスワードの変更(Initial Setting for Web UI Login Password)

初期パスワード(Initial Password)	<input type="text"/>
新しいパスワード(New Password)	<input type="text"/>
新しいパスワード再入力(Re-Enter)	<input type="text"/>

変更(Set) スキップ(Skip)

Bottom navigation bar: Pocket WiFi 5G, Usage, お客様サポート, Logout.

Do not forget to write down your administrator's password. The password is essential to the configuration of this product. You need to enter the password to open the configuration screen. If you forget the password, you will need to initialize this product. Note that all the configurations you have saved will be deleted during initialization.

Administrator's password	
--------------------------	--

(5) Select the menu you want to modify, and proceed.

The screenshot displays the PocketWifi 5G management interface. At the top, the status bar shows 'No SIM', signal strength, '2.4G' Wi-Fi, and a 98% battery level. The main header includes the 'PocketWifi 5G' logo, a '日本語' button, 'Home' and 'Usage' icons, and a 'Logout' button.

The main content area is titled 'Device Information' with a 'Refresh' button. Below this are two expandable sections: '接続' (Connection) and '通信量' (Usage), both with 'Open' buttons.

The settings are organized into eight categories, each with a list of sub-options:

- Network Settings** (Gear icon):
 - Basic Settings
 - Connection Settings
 - Profile Settings
 - Traffic Counter
- Wi-Fiスポット** (Wi-Fi icon):
 - Wi-Fiスポット
- Wi-Fi Settings** (Wi-Fi icon):
 - オーナー-SSID設定
 - Wi-Fi Settings (Guest SSID)
 - MAC Address Filter
 - WPS Settings
- ECO Settings** (Leaf icon):
 - ECO Settings
- Security Settings** (Shield icon):
 - Security Settings
- Advanced Settings** (Gears icon):
 - LAN Settings
 - IPv4 Packet Filter Settings
 - IPv6 Packet Filter Settings
 - Port Mapping Settings
 - ドメインフィルタ設定
 - Other Settings
- Maintenance** (Wrench icon):
 - Changing the Administrator Password
 - Saving and Restoration of Settings
 - Initialization
 - Update Firmware
 - PIN Code Management
 - Restart
- Information** (Info icon):
 - Current Info
 - 接続履歴
 - UPnP Info
 - お知らせ
 - Manual

The footer contains the 'PocketWifi 5G' logo, 'Home' and 'Usage' icons, a link to 'お客様サポート' (Customer Support), and a 'Logout' button.

6. Products Specifications

Item		Condition	
WAN	Antenna	Antenna built in	
	3G_Band2	Frequency	UL:1850-1910MHz, DL:1930-1990MHz
	3G_Band4	Frequency	UL:1710-1755MHz, DL:2110-2155MHz
	LTE_Band2	Frequency	UL:1850-1910MHz, DL:1930-1990MHz
	LTE_Band4	Frequency	UL:1710-1755MHz, DL:2110-2155MHz
	LTE_Band12	Frequency	UL:699-716MHz, DL:729-746MHz
	LTE_Band17	Frequency	UL:704-716MHz, DL:734-746MHz
	LTE_Band26	Frequency	UL:814-849MHz, DL:859-894MHz
	LTE_Band41	Frequency	UL:2570-2620MHz, DL:2570-2620MHz
Wireless LAN	Antenna	Antenna built in	
	IEEE802.11b	Frequency band/CH	2.4GHz (2412-2462MHz)/1-11ch
		Bit rate	1/2/5.5/11Mbps
	IEEE802.11g	Frequency band/CH	2.4GHz (2412-2462MHz)/1-11ch
		Bit rate	6/9/12/18/24/36/48/54Mbps
	IEEE802.11n	Frequency band/CH	2.4GHz (2412-2462MHz)/1-11ch
		Bit rate	6.5 Mbps to 150 Mbps (HT20/40)
	IEEE802.11ax	Frequency band/CH	2.4GHz (2412-2462MHz)/1-11ch
Bit rate		7.3Mbps to 458.8Mbps (HE20/40)	
USB port	Physical interface	Type C connector	
	Port	1ports	
	Type	USB3.0	
Operating conditions		Temperature: 0 to 35 °C Humidity: 10 to 90%	
Dimensions		Approx. 128(W) x 65(D) x 14.5(H) mm	
Power consumption		7.0W	
Weight		Approx. 0.175kg	

(*1): Bluetooth is supported only remote wake-up function.
Tethering function is not supported.

Battery

Model name	GXE-005945, 1ICP6/48/97
Battery type	Lithium ion battery
Nominal voltage	3.8V
Nominal capacity	4000mAh

RF power listing (Conducted Power Table)

<u>Technology</u>	<u>Band</u>	Target Power (dBm)
WCDMA	2	24.0
	4	24.0
LTE	2	23.0
	4	23.0
	12	23.0
	17	23.0
	41	23.0 (HPUE 26.0)

<u>Technology/Band</u>	<u>Mode</u>	Target Power (dBm)
WLAN 2.4GHz	802.11b	17.0
	802.11g	16.0
	802.11n HT20	16.0
	802.11n HT40	13.5
	802.11ax HE20	16.0
	802.11ax HE40	13.5

Notice

- (1) All rights reserved. No part of this manual may be copied or reproduced without prior permission.
- (2) Contents of this manual may change without notice.
- (3) We take every possible precaution to ensure the accuracy of this manual, but if anything is unclear or erroneous in the content, please contact us. (<http://www.necat.co.jp/>)
- (4) We assume no responsibility whatsoever for any failure, malfunction, accident, trouble or damage resulting from external causes such as erroneous operation, natural disasters, faults power cuts, etc.
- (5) Please note that we shall not be responsible for any damage resulting from security problems if no security measures are in place or the wireless LAN specification is insecure.
- (6) If the product is damaged in accidentally through inappropriate use or unpredictable circumstances (e.g. thunderstorms or electric current leakage), the product may not operate properly. Please read this manual and follow the instructions carefully.



Disposing of your used NEC product

In the European Union

EU-wide legislation as implemented in each Member State requires that used electrical and electronic products carrying the mark (left) must be disposed of separately from normal household waste. *This includes the residential gateway or electrical accessories, such as the AC Adaptor.*

When you dispose of such products, please follow the guidance of your local authority and/or ask the shop where you purchased the product.

The mark on the electrical and electronic products only applies to the current European Union Member States.

Outside the European Union

If you wish to dispose of used electrical and electronic products outside the European Union, please contact your local authority and ask for the correct method of disposal.

Europe – EU Declaration of Conformity

This device complies with the essential requirements of the RE Directive 2014/53/EC. The following test methods have been applied in order to prove presumption of conformity with the essential requirements of the RE Directive 2014/53/EC:

- EN 300 328 V2.2.2 (2019-07)
 - EN 301 489-1 V2.2.3 (2019-11)
 - EN 301 489-17 V3.1.1 (2017-02)
 - Draft EN 301 489-52 V1.1.0 (2016-11)
 - ETSI EN 301 908-1 V13.1.1 (2019-11)
 - EN 301 908-2 V11.1.2
 - EN 301 908-13 V13.1.1
 - EN 55032:2015+A11:2020, Class B
 - EN 61000-3-2:2014
 - EN 61000-3-3:2013
 - EN55035:2017
 - EN 50566:2017,EN 62209-2:2010+A1:2019,IEC 62209-2:2010+AMD1:2019
 - EN 62368-1:2014+A11:2017
-

Federal Communication Commission Interference Statement

This device complies with Part 15 of the FCC Rules. Operation is subject to the following two conditions: (1) This device may not cause harmful interference, and (2) this device must accept any interference received, including interference that may cause undesired operation.

This equipment has been tested and found to comply with the limits for a Class B digital device, pursuant to Part 15 of the FCC Rules. These limits are designed to provide reasonable protection against harmful interference in a residential installation. This equipment generates, uses and can radiate radio frequency energy and, if not installed and used in accordance with the instructions, may cause harmful interference to radio communications. However, there is no guarantee that interference will not occur in a particular installation. If this equipment does cause harmful interference to radio or television reception, which can be determined by turning the equipment off and on, the user is encouraged to try to correct the interference by one of the following measures:

- Reorient or relocate the receiving antenna.
- Increase the separation between the equipment and receiver.
- Connect the equipment into an outlet on a circuit different from that to which the receiver is connected.
- Consult the dealer or an experienced radio/TV technician for help.

FCC Caution: Any changes or modifications not expressly approved by the party responsible for compliance could void the user's authority to operate this equipment.

This transmitter must not be co-located or operating in conjunction with any other antenna or transmitter.

Important safety information regarding radio frequency (RF) exposure and use when worn

The product “KMP8S3AA1-1A” is declared to conform with the essential requirements of the Federal Communications Commission of the U.S. Government.

This wireless portable device complies with the FCC requirements for exposure to radio waves.

Your wireless portable device is a radio transceiver and receiver. It is designed not to exceed the SAR* (Specific Absorption Rate) limits** for exposure to radiofrequency (RF) energy by the FCC Directives.

The Max. SAR* value is T.B.D W/kg (1 g) when it is worn on the body. To comply with the RF Exposure limits.

For body worn operation, this device has been tested and meets the FCC RF exposure guidelines. During communication, please use an accessory designated for this product and which positions the device a minimum of 0.1cm from the body.

The use of accessories that do not satisfy these requirements may not comply with FCC RF exposure requirements and should be avoided.

* The exposure standard for wireless portable devices employs a unit of measurement known as the Specific Absorption Rate, or SAR.

** The SAR limit recommended by the FCC is 1.6W/kg averaged over 1g of tissue.

*** Tests for SAR have been conducted using standard operating positions with the transmitting at its highest certified power level in all tested frequency bands. Although the SAR is determined at the highest certified power level, the actual SAR level of the wireless portable device while operating can be well below the maximum value. This is because the wireless portable device is designed to operate at multiple power levels so as to use only the power required to reach the network. In general, the closer you are to a base station antenna, the lower the power output.

Body-worn Operation

This device was tested for typical body-worn operations. To comply with RF exposure requirements, a minimum separation distance of 10mm must be maintained between the user's body and the handset, including the antenna.

Third-party belt-clips, holsters, and similar accessories used by this device should not contain any metallic components.

Body-worn accessories that do not meet these requirements may not comply with RF exposure requirements and should be avoided.

Radiation Exposure Statement

The product complies with the FCC portable RF exposure limit set forth for an uncontrolled environment and are safe for intended operation as described in this manual. The further RF exposure reduction can be achieved if the product can be kept as far as possible from the user body or set the device to lower output power if such function is available.

FCC ID Location

FCC ID is indicated on the LED.
In the main menu, select "Information"
In the sub menu, select "cert".

