



MEASUREMENT REPORT

FCC ID : 2AA5FW4239

APPLICANT : Medical Intubation Technology Corp.

Application Type : Certification

Product : Wi-Fi Φ 3.9mm 2ways borescope

Model No. : W4239

Trademark : **Mitcorp**

FCC Classification : (DTS) Digital Transmission System

FCC Rule Part(s) : Part 15.247

Test Procedure(s) : ANSI C63.10-2013

Received Date : December 20, 2023

Test Date : December 29, 2023~January 10, 2024

Tested By : *Kaunaz Lee*
(Kaunaz Lee)

Reviewed By : *Paddy Chen*
(Paddy Chen)

Approved By : *Chenz Ker*
(Chenz Ker)



The test results only relate to the samples tested.

This equipment has been shown to be capable of compliance with the applicable technical standards as indicated in the measurement report and was tested in accordance with the measurement procedures specified in ANSI C63.10. Test results reported herein relate only to the item(s) tested.

The test report shall not be reproduced except in full without the written approval of MRT Technology (Taiwan) Co., Ltd.

Revision History

Report No.	Version	Description	Issue Date	Note
2312TW6501-U2	1.0	Original Report	2024-01-19	

CONTENTS

Description	Page
§2.1033 General Information	5
1. INTRODUCTION	6
1.1. Scope.....	6
1.2. MRT Test Location.....	6
2. PRODUCT INFORMATION	7
2.1. Equipment Description	7
2.2. Working Frequencies for this Report	8
2.3. Test Mode.....	10
2.4. Configuration of Tested System	10
2.5. Test System Details	11
2.6. Test Software	11
2.7. Test Configuration.....	12
2.8. EMI Suppression Device(s)/Modifications	12
2.9. Labeling Requirements	12
3. DESCRIPTION of TEST	13
3.1. Evaluation Procedure.....	13
3.2. AC Line Conducted Emissions	13
3.3. Radiated Emissions	14
4. ANTENNA REQUIREMENTS.....	15
5. TEST EQUIPMENT CALIBRATION DATE.....	16
6. MEASUREMENT UNCERTAINTY.....	17
7. TEST RESULT	18
7.1. Summary.....	18
7.2. 6dB Bandwidth Measurement	19
7.2.1. Test Limit.....	19
7.2.2. Test Procedure used	19
7.2.3. Test Setting	19
7.2.4. Test Setup	19
7.2.5. Test Result	20
7.3. Output Power Measurement.....	23
7.3.1. Test Limit.....	23
7.3.2. Test Procedure Used.....	23
7.3.3. Test Setting	23
7.3.4. Test Setup	23
7.3.5. Test Result of Output Power	24
7.4. Power Spectral Density Measurement	25
7.4.1. Test Limit.....	25
7.4.2. Test Procedure Used.....	25
7.4.3. Test Setting	25
7.4.4. Test Setup	25

7.4.5.	Test Result	26
7.5.	Out-of-Band Spurious Emissions Emissions Measurement.....	29
7.5.1.	Test Limit.....	29
7.5.2.	Test Procedure Used.....	29
7.5.3.	Test Settiting	29
7.5.4.	Test Setup	29
7.5.5.	Test Result	30
7.6.	Radiated Spurious Emission Measurement.....	34
7.6.1.	Test Limit.....	34
7.6.2.	Test Procedure Used.....	34
7.6.3.	Test Setting	34
7.6.4.	Test Setup	36
7.6.5.	Test Result	38
7.7.	Radiated Restricted Band Edge Measurement.....	58
7.7.1.	Test Limit.....	58
7.7.2.	Test Procedure Used.....	58
7.7.3.	Test Setting	58
7.7.4.	Test Setup	60
7.7.5.	Test Result	61
7.8.	AC Conducted Emissions Measurement.....	85
7.8.1.	Test Limit.....	85
7.8.2.	Test Setup.....	85
7.8.3.	Test Result	86
8.	CONCLUSION	90
	Appendix A : Test Photograph	91
	Appendix B : External Photograph.....	91
	Appendix C : Internal Photograph	91

§2.1033 General Information

Applicant	Medical Intubation Technology Corp.
Applicant Address	2F, No.75, Wenhua 1st Rd., Guishan District, Taoyuan 33382, Taiwan
Manufacturer	Medical Intubation Technology Corp.
Manufacturer Address	2F, No.75, Wenhua 1st Rd., Guishan District, Taoyuan 33382, Taiwan
Test Site	MRT Technology (Taiwan) Co., Ltd
Test Site Address	No. 38, Fuxing Second Rd., Guishan Dist., Taoyuan City 333, Taiwan (R.O.C)
MRT FCC Registration No.	291082
FCC Rule Part(s)	Part 15.247
Test Device Serial No.	#1-1 <input type="checkbox"/> Production <input checked="" type="checkbox"/> Pre-Production <input type="checkbox"/> Engineering

Test Facility / Accreditations

1. MRT facility is a FCC registered (Reg. No. 291082) test facility with the site description report on file and is designated by the FCC as an Accredited Test Firm.
2. MRT facility is an IC registered (MRT Reg. No. 21723) test laboratory with the site description on file at Industry Canada.
3. MRT Lab is accredited to ISO 17025 by the Taiwan Accreditation Foundation (TAF Cert. No. 3261) in EMC, Telecommunications and Radio testing for FCC (Designation Number: TW3261), Industry Canada, EU and TELEC Rules.

1. INTRODUCTION

1.1. Scope

Measurement and determination of electromagnetic emissions (EMC) of radio frequency devices including intentional and/or unintentional radiators for compliance with the technical rules and regulations of the Federal Communications Commission and the Industry Canada Certification and Engineering Bureau.

1.2. MRT Test Location

The map below shows the location of the MRT LABORATORY, its proximity to the Taoyuan City. These measurement tests were conducted at the MRT Technology (Taiwan) Co., Ltd. Facility located at No.38, Fuxing 2nd Rd., Guishan Dist., Taoyuan City 33377, Taiwan (R.O.C).

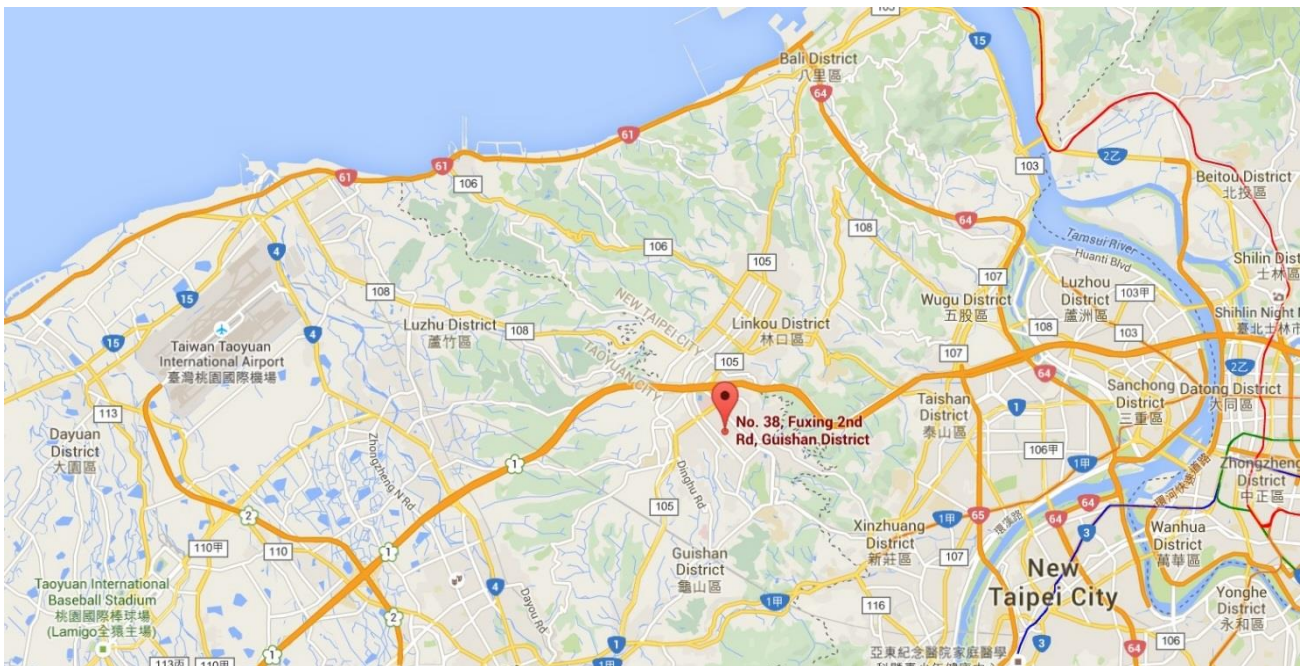

2. PRODUCT INFORMATION

2.1. Equipment Description

Product Name	Wi-Fi Φ 3.9mm 2ways borescope
Model No.	W4239
Trademark	
Wi-Fi Specification	802.11b/g/n (1TX / 1RX)
Frequency Range	<u>2.4GHz:</u> For 802.11b/g/n-HT20: 2412 ~ 2462 MHz
Type of Modulation	802.11b: DSSS, DBPSK, DQPSK, CCK 802.11g/n-20M: OFDM, BPSK, QPSK, 16QAM, 64QAM
Accessory	
USB Type A Adapter	Brand: BILLION Model No: BA018-050300HXX Input: AC 100-240V~0.5A, 50/60Hz Output: DC 5.0V, 3.0A

2.2. Working Frequencies for this Report

802.11b/g/n-HT20

Channel	Frequency	Channel	Frequency	Channel	Frequency
01	2412 MHz	02	2417 MHz	03	2422 MHz
04	2427 MHz	05	2432 MHz	06	2437 MHz
07	2442 MHz	08	2447 MHz	09	2452 MHz
10	2457 MHz	11	2462 MHz	--	--

Duty Cycle

Test Mode	Duty Cycle
802.11b	100%
802.11g	100%
802.11 n-HT20	100%

802.11b	802.11g																																																																								
<table border="1"> <thead> <tr> <th>MKR</th> <th>MODE</th> <th>TRIG</th> <th>SCL</th> <th>X</th> <th>Y</th> <th>FUNCTION</th> <th>FUNCTION WIDTH</th> <th>FUNCTION VALUE</th> </tr> </thead> <tbody> <tr> <td>1</td> <td>N</td> <td>1</td> <td>t</td> <td>39.83 ms</td> <td>0.06 dBm</td> <td></td> <td></td> <td></td> </tr> <tr> <td>2</td> <td>N</td> <td>1</td> <td>t</td> <td>39.83 ms</td> <td>0.06 dBm</td> <td></td> <td></td> <td></td> </tr> <tr> <td>3</td> <td>N</td> <td>1</td> <td>t</td> <td>39.83 ms</td> <td>0.06 dBm</td> <td></td> <td></td> <td></td> </tr> </tbody> </table>	MKR	MODE	TRIG	SCL	X	Y	FUNCTION	FUNCTION WIDTH	FUNCTION VALUE	1	N	1	t	39.83 ms	0.06 dBm				2	N	1	t	39.83 ms	0.06 dBm				3	N	1	t	39.83 ms	0.06 dBm				<table border="1"> <thead> <tr> <th>MKR</th> <th>MODE</th> <th>TRIG</th> <th>SCL</th> <th>X</th> <th>Y</th> <th>FUNCTION</th> <th>FUNCTION WIDTH</th> <th>FUNCTION VALUE</th> </tr> </thead> <tbody> <tr> <td>1</td> <td>N</td> <td>1</td> <td>t</td> <td>50.73 ms</td> <td>4.53 dBm</td> <td></td> <td></td> <td></td> </tr> <tr> <td>2</td> <td>N</td> <td>1</td> <td>t</td> <td>50.73 ms</td> <td>4.53 dBm</td> <td></td> <td></td> <td></td> </tr> <tr> <td>3</td> <td>N</td> <td>1</td> <td>t</td> <td>50.73 ms</td> <td>4.53 dBm</td> <td></td> <td></td> <td></td> </tr> </tbody> </table>	MKR	MODE	TRIG	SCL	X	Y	FUNCTION	FUNCTION WIDTH	FUNCTION VALUE	1	N	1	t	50.73 ms	4.53 dBm				2	N	1	t	50.73 ms	4.53 dBm				3	N	1	t	50.73 ms	4.53 dBm			
MKR	MODE	TRIG	SCL	X	Y	FUNCTION	FUNCTION WIDTH	FUNCTION VALUE																																																																	
1	N	1	t	39.83 ms	0.06 dBm																																																																				
2	N	1	t	39.83 ms	0.06 dBm																																																																				
3	N	1	t	39.83 ms	0.06 dBm																																																																				
MKR	MODE	TRIG	SCL	X	Y	FUNCTION	FUNCTION WIDTH	FUNCTION VALUE																																																																	
1	N	1	t	50.73 ms	4.53 dBm																																																																				
2	N	1	t	50.73 ms	4.53 dBm																																																																				
3	N	1	t	50.73 ms	4.53 dBm																																																																				
802.11 n20																																																																									
<table border="1"> <thead> <tr> <th>MKR</th> <th>MODE</th> <th>TRIG</th> <th>SCL</th> <th>X</th> <th>Y</th> <th>FUNCTION</th> <th>FUNCTION WIDTH</th> <th>FUNCTION VALUE</th> </tr> </thead> <tbody> <tr> <td>1</td> <td>N</td> <td>1</td> <td>t</td> <td>22.88 ms</td> <td>4.21 dBm</td> <td></td> <td></td> <td></td> </tr> <tr> <td>2</td> <td>N</td> <td>1</td> <td>t</td> <td>22.88 ms</td> <td>4.21 dBm</td> <td></td> <td></td> <td></td> </tr> <tr> <td>3</td> <td>N</td> <td>1</td> <td>t</td> <td>22.88 ms</td> <td>4.21 dBm</td> <td></td> <td></td> <td></td> </tr> </tbody> </table>	MKR	MODE	TRIG	SCL	X	Y	FUNCTION	FUNCTION WIDTH	FUNCTION VALUE	1	N	1	t	22.88 ms	4.21 dBm				2	N	1	t	22.88 ms	4.21 dBm				3	N	1	t	22.88 ms	4.21 dBm																																								
MKR	MODE	TRIG	SCL	X	Y	FUNCTION	FUNCTION WIDTH	FUNCTION VALUE																																																																	
1	N	1	t	22.88 ms	4.21 dBm																																																																				
2	N	1	t	22.88 ms	4.21 dBm																																																																				
3	N	1	t	22.88 ms	4.21 dBm																																																																				

2.3. Test Mode

Test Mode	Mode 1: Transmit by 802.11b
	Mode 2: Transmit by 802.11g
	Mode 3: Transmit by 802.11n-20M

Note:

- Regarding to the operation frequency, the lowest, middle and highest frequency are selected to perform the test.

2.4. Configuration of Tested System

Connection Diagram

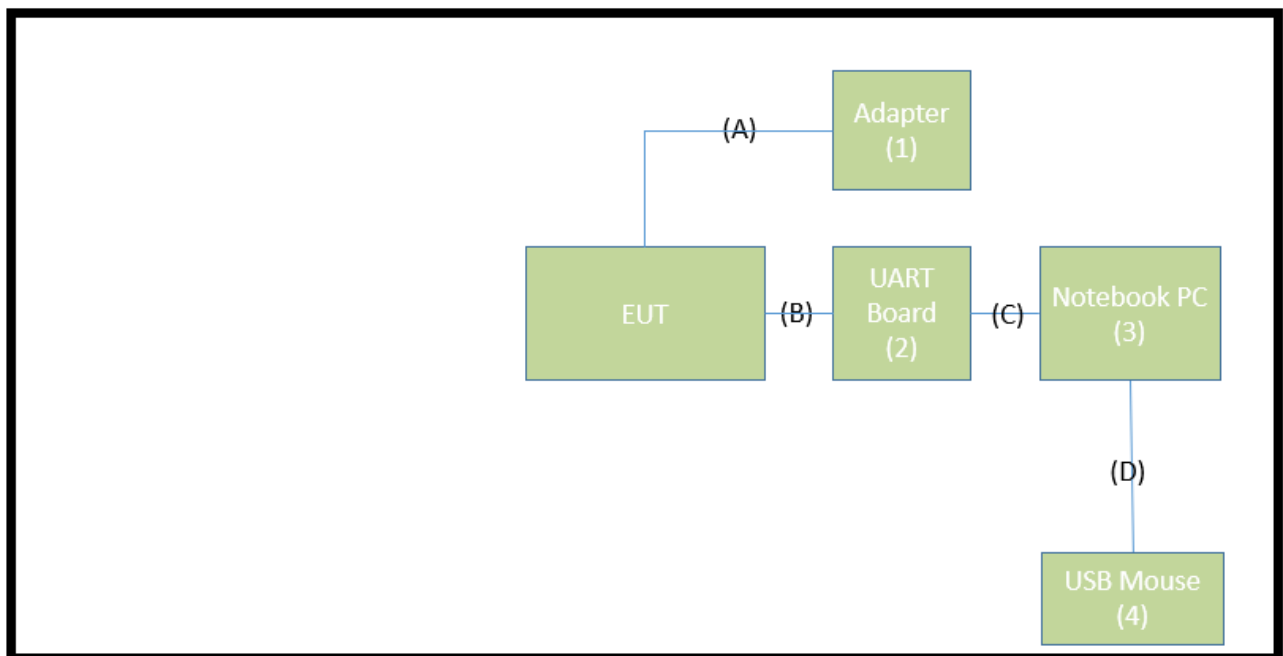

	Signal Cable Type	Signal Cable Description
A	USB Cable	Shielded 1.0m With Core*1
B	Signal Cable	Non- Shielded, 0.2m
C	USB Cable	Shielded, 1.0m
D	USB Mouse Cable	Shielded, 1.8m

2.5. Test System Details

The types for all equipment, and descriptions of all cables used in the tested system (including inserted cards) are:

No.	Product	Manufacturer	Model No.	Serial No.	Power Cord
1	Adapter	BILLION	BA018-050300HXX	N/A	N/A
2	UART Board	GZUt	CH340G	N/A	N/A
3	Notebook PC	Dell	P65F	N/A	Non-shielded, 0.8m
4	USB Mouse	Logitech	M90	N/A	N/A

2.6. Test Software

The test utility software used during testing was “Tera Term v4.98”.

2.7. Test Configuration

This device was tested per the guidance of ANSI C63.10-2013. ANSI C63.10-2013 was used to reference the appropriate EUT setup for radiated spurious emissions testing and AC line conducted testing.

2.8. EMI Suppression Device(s)/Modifications

No EMI suppression device(s) were added and/or no modifications were made during testing.

2.9. Labeling Requirements

Per 2.1074 & 15.19; Docket 95-19

The label shall be permanently affixed at a conspicuous location on the device; instruction manual or pamphlet supplied to the user and be readily visible to the purchaser at the time of purchase. However, when the device is so small wherein placement of the label with specified statement is not practical, only the FCC ID must be displayed on the device per Section 15.19(a)(5). Please see attachment for FCC ID label and label location.

3. DESCRIPTION of TEST

3.1. Evaluation Procedure

The measurement procedures described in the American National Standard for Testing Unlicensed Wireless Devices (ANSI C63.10-2013), and the guidance provided in KDB 558074 D01v05 were used in the measurement of the device.

Deviation from measurement procedure.....None

3.2. AC Line Conducted Emissions

The line-conducted facility is located inside an 9'x4'x3' shielded enclosure. A 1m x 2m wooden table 80cm high is placed 40cm away from the vertical wall and 80cm away from the sidewall of the shielded room. Two 10kHz-30MHz, 50Ω/50uH Line-Impedance Stabilization Networks (LISNs) are bonded to the shielded room floor. Power to the LISNs is filtered by external high-current high-insertion loss power line filters. These filters attenuate ambient signal noise from entering the measurement lines. These filters are also bonded to the shielded enclosure.

The EUT is powered from one LISN and the support equipment is powered from the second LISN. All interconnecting cables more than 1 meter were shortened to a 1 meter length by non-inductive bundling (serpentine fashion) and draped over the back edge of the test table. All cables were at least 40cm above the horizontal reference ground-plane. Power cables for support equipment were routed down to the second LISN while ensuring that that cables were not draped over the second LISN.

Sufficient time for the EUT, support equipment, and test equipment was allowed in order for them to warm up to their normal operating condition. The RF output of the LISN was connected to the receiver and exploratory measurements were made to determine the frequencies producing the maximum emission from the EUT. The receiver was scanned from 150kHz to 30MHz. The detector function was set to peak mode for exploratory measurements while the bandwidth of the analyzer was set to 9kHz. The EUT, support equipment, and interconnecting cables were arranged and manipulated to maximize each emission. Each emission was also maximized by varying: power lines, the mode of operation or data exchange speed, or support equipment which determined the worst-case emission. Once the worst case emissions have been identified, the one EUT cable configuration/arrangement and mode of operation that produced these emissions are used for final measurements on the same test site. The analyzer is set to CISPR quasi-peak and average detectors with a 9kHz resolution bandwidth for final measurements.

An extension cord was used to connect to a single LISN which powered by EUT. The extension cord was calibrated with LISN, the impedance and insertion loss are compliance with the requirements as stated in ANSI C63.10-2013.

Line conducted emissions test results are shown in Section 7.8.

3.3. Radiated Emissions

The radiated test facilities consisted of an indoor 3 meter semi-anechoic chamber used for final measurements and exploratory measurements, when necessary. The measurement area is contained within the semi-anechoic chamber which is shielded from any ambient interference. For measurements above 1GHz absorbers are arranged on the floor between the turn table and the antenna mast in such a way so as to maximize the reduction of reflections. For measurements below 1GHz, the absorbers are removed. A MF Model 210SS turntable is used for radiated measurement. It is a continuously rotatable, remote controlled, metallic turntable and 2 meters (6.56 ft.) in diameter. The turn table is flush with the raised floor of the chamber in order to maintain its function as a ground plane. An 80cm high PVC support structure is placed on top of the turntable. For all measurements, the spectrum was scanned through all EUT azimuths and from 1 to 4 meter receive antenna height using a broadband antenna from 30MHz up to the upper frequency shown in 15.33(b)(1) depending on the highest frequency generated or used in the device or on which the device operates or tunes. For frequencies above 1GHz, linearly polarized double ridge horn antennas were used. For frequencies below 30MHz, a calibrated loop antenna was used. When exploratory measurements were necessary, they were performed at 1 meter test distance inside the semi-anechoic chamber using broadband antennas, broadband amplifiers, and spectrum analyzers to determine the frequencies and modes producing the maximum emissions. Sufficient time for the EUT, support equipment, and test equipment was allowed in order for them to warm up to their normal operating condition. The test set-up for frequencies below 1GHz was placed on top of the 0.8 meter high, 1 x 1.5 meter table; and test set-up for frequencies 1-40GHz was placed on top of the 1.5 meter high, 1 x 1.5 meter table. The EUT, support equipment, and interconnecting cables were arranged and manipulated to maximize each emission. Appropriate precaution was taken to ensure that all emissions from the EUT were maximized and investigated. The system configuration, clock speed, mode of operation or video resolution, if applicable, turntable azimuth, and receive antenna height was noted for each frequency found.

Final measurements were made in the semi-anechoic chamber using calibrated, linearly polarized broadband and horn antennas. The test setup was configured to the setup that produced the worst case emissions. The spectrum analyzer was set to investigate all frequencies required for testing to compare the highest radiated disturbances with respect to the specified limits. The turntable containing the EUT was rotated through 360 degrees and the height of the receive antenna was varied 1 to 4 meters and stopped at the azimuth and height producing the maximum emission. Each emission was maximized by changing the orientation of the EUT through three orthogonal planes and changing the polarity of the receive antenna, which produced the worst-case emissions.

According to 3dB Beam-Width of horn antenna, the horn antenna should be always directed to the EUT when rising height.

Radiated emissions test results are shown in Section 7.6 & 7.7 .

4. ANTENNA REQUIREMENTS

Excerpt from §15.203 of the FCC Rules/Regulations:

“An intentional radiator antenna shall be designed to ensure that no antenna other than that furnished by the responsible party can be used with the device. The use of a permanently attached antenna or of an antenna that uses a unique coupling to the intentional radiator shall be considered sufficient to comply with the provisions of this section.”

- The antenna of the **Wi-Fi Φ 3.9mm 2ways borescope**, is permanently attached.
- There are no provisions for connection to an external antenna.

Conclusion:

The EUT unit complies with the requirement of §15.203.

Antenna List

No.	Manufacturer	Part No.	Antenna Type	Peak Gain
1	LB-LINK	WNZ7915	PCB	2.0dBi

5. TEST EQUIPMENT CALIBRATION DATE

Conducted Emissions – SR2

Instrument	Manufacturer	Type No.	Asset No.	Cali. Interval	Cali. Due Date
Two-Line V-Network	R&S	ENV216	MRTTWA00019	1 year	2024/3/7
Cable	Rosnol	N1C50-RG400- B1C50-500CM	MRTTWE00013	1 year	2024/6/15
EMI Test Receiver	R&S	ESR3	MRTTWA00009	1 year	2024/3/8

Radiated Emissions – AC1

Instrument	Manufacturer	Type No.	Asset No.	Cali. Interval	Cali. Due Date
Active Loop Antenna	SCHWARZBECK	FMZB 1519B	MRTTWA00002	1 year	2024/5/22
Broadband TRILOG Antenna	SCHWARZBECK	VULB 9162	MRTTWA00001	1 year	2024/10/31
Broadband Hornantenna	SCHWARZBECK	BBHA 9120D	MRTTWA00003	1 year	2024/3/24
Broadband Preamplifier	SCHWARZBECK	BBV 9718	MRTTWA00005	1 year	2024/3/24
Breitband Hornantenna	SCHWARZBECK	BBHA 9170	MRTTWA00004	1 year	2024/3/20
Broadband Amplifier	SCHWARZBECK	BBV 9721	MRTTWA00006	1 year	2024/3/27
EMI Test Receiver	R&S	ESR3	MRTTWA00009	1 year	2024/3/8
Signal Analyzer	R&S	FSV40	MRTTWA00007	1 year	2024/3/14
Antenna Cable	HUBERSUHNER	SF106	MRTTWE00010	1 year	2024/6/13
Cable	Rosnol	K1K50-UP0264- K1K50-4M	MRTTWE00012	1 year	2024/6/18
Temperature/Humidity Meter	TFA	35.1078.10.IT	MRTTWA00032	1 year	2024/6/4

Conducted Test Equipment – SR6

Instrument	Manufacturer	Type No.	Asset No.	Cali. Interval	Cali. Due Date
X-Series USB Peak and Average Power Sensor	KEYSIGHT	U2021XA	MRTTWA00014	1 year	2024/4/19
X-Series USB Peak and Average Power Sensor	KEYSIGHT	U2021XA	MRTTWA00015	1 year	2024/3/16
EXA Signal Analyzer	KEYSIGHT	N9010A	MRTTWA00012	1 year	2024/10/17
EXA Signal Analyzer	KEYSIGHT	N9010B	MRTTWA00074	1 year	2024/7/19
DIVA PLUS Funk-Wetterstation	TFA	35.1083	MRTTWA00050	1 year	2024/6/15

Test Software

Software	Version	Function
e3	9.160520a	EMI Test Software
EMI	V3	EMI Test Software

6. MEASUREMENT UNCERTAINTY

Where relevant, the following test uncertainty levels have been estimated for tests performed on the EUT as specified in CISPR 16-4-2. This uncertainty represents an expanded uncertainty expressed at approximately the 95% confidence level using a coverage factor of $k = 2$.

Conducted Emission- Power Line
Measuring Uncertainty for a Level of Confidence of 95% ($U=2Uc(y)$): 0.15MHz~30MHz: $\pm 2.53\text{dB}$
Radiated Spurious Emission
Measuring Uncertainty for a Level of Confidence of 95% ($U=2Uc(y)$): 9kHz~30MHz: $\pm 3.92\text{dB}$ 30MHz~1GHz: $\pm 4.25\text{dB}$ 1GHz~18GHz: $\pm 4.40\text{dB}$ 18GHz~40GHz: $\pm 4.45\text{dB}$
Frequency Error
Measuring Uncertainty for a Level of Confidence of 95% ($U=2Uc(y)$): $\pm 78.4\text{Hz}$
Conducted Power
Measuring Uncertainty for a Level of Confidence of 95% ($U=2Uc(y)$): $\pm 0.84\text{dB}$
Conducted Spurious Emission
Measuring Uncertainty for a Level of Confidence of 95% ($U=2Uc(y)$): $\pm 2.65\text{ dB}$
Occupied Bandwidth
Measuring Uncertainty for a Level of Confidence of 95% ($U=2Uc(y)$): $\pm 3.3\%$
Temp. / Humidity
Measuring Uncertainty for a Level of Confidence of 95% ($U=2Uc(y)$): $\pm 0.82^\circ\text{C} / \pm 3\%$
DC Voltage
Measuring Uncertainty for a Level of Confidence of 95% ($U=2Uc(y)$): $\pm 0.3\%$

7. TEST RESULT

7.1. Summary

Product Name: Wi-Fi Φ 3.9mm 2ways borescope
FCC Classification: (DTS) Digital Transmission System
Data Rate(s) Tested: 1Mbps ~ 11Mbps (b); 6Mbps ~ 54Mbps (g);
6.5/7.2Mbps ~ 65/72.2Mbps (n-20M);

FCC Part Section(s)	Test Description	Test Limit	Test Condition	Test Result	Reference
15.247(a)(2)	6dB Bandwidth	$\geq 500\text{kHz}$	Conducted	Pass	Section 7.2
15.247(b)(3)	Output Power	$\leq 30.00\text{dBm}$		Pass	Section 7.3
15.247(e)	Power Spectral Density	$\leq 8.00\text{dBm}/3\text{kHz}$		Pass	Section 7.4
15.247(d)	Out-of-Band Emissions	Conducted $\geq 20\text{dBc}$		Pass	Section 7.5
15.205 15.209	Spurious Emission	< FCC 15.209 limits	Radiated	Pass	Section 7.6
15.205 15.209	Band Edge Measurement	$\cong 74\text{dBuV/m(Peak)}$ $\cong 54\text{dBuV/m(Average)}$		Pass	Section 7.7
15.207	AC Conducted Emissions 150kHz - 30MHz	< FCC 15.207 limits	Line Conducted	Pass	Section 7.8

Notes:

- Determining compliance is based on the test results met the regulation limits or requirements declared by clients, and the test results don't take into account the value of measurement uncertainty.
- All modes of operation and data rates were investigated. For radiated emission test, every axis (X, Y, Z) was also verified. The test results shown in the following sections represent the worst case emissions.
- The analyzer plots shown in this section were all taken with a correction table loaded into the analyzer. The correction table was used to account for the losses of the cables and attenuators used as part of the system to connect the EUT to the analyzer at all frequencies of interest.
- All antenna port conducted emissions testing was performed on a test bench with the antenna port of the EUT connected to the spectrum analyzer through calibrated cables and attenuators.

7.2. 6dB Bandwidth Measurement

7.2.1. Test Limit

The minimum 6dB bandwidth shall be at least 500 kHz.

7.2.2. Test Procedure used

ANSI C63.10 - 2013 Section 11.8

7.2.3. Test Setting

1. The Spectrum's automatic bandwidth measurement capability was used to perform the 6dB bandwidth measurement. The "X" dB bandwidth parameter was set to $X = 6$. The bandwidth measurement was not influenced by any intermediate power nulls in the fundamental emission.
2. Set RBW = 100 kHz
3. VBW $\geq 3 \times$ RBW
4. Detector = Peak
5. Trace mode = max hold
6. Sweep = auto couple
7. Allow the trace was allowed to stabilize

7.2.4. Test Setup

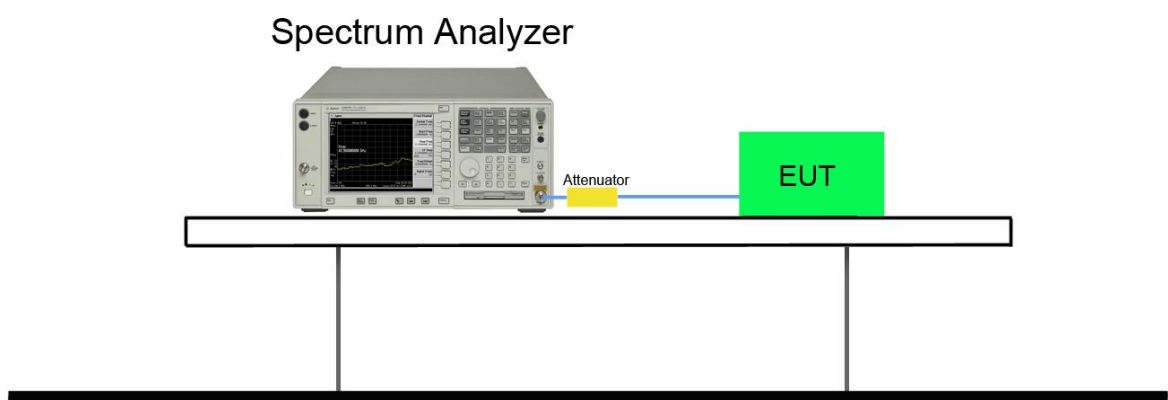

7.2.5. Test Result

Test Mode	Channel No.	Frequency (MHz)	6dB Bandwidth (MHz)	Limit (MHz)	Result
802.11b	01	2412	10.07	≥ 0.5	Pass
802.11b	06	2437	10.06	≥ 0.5	Pass
802.11b	11	2462	10.07	≥ 0.5	Pass
802.11g	01	2412	16.56	≥ 0.5	Pass
802.11g	06	2437	16.56	≥ 0.5	Pass
802.11g	11	2462	16.56	≥ 0.5	Pass
802.11n-20M	01	2412	17.81	≥ 0.5	Pass
802.11n-20M	06	2437	17.82	≥ 0.5	Pass
802.11n-20M	11	2462	17.83	≥ 0.5	Pass

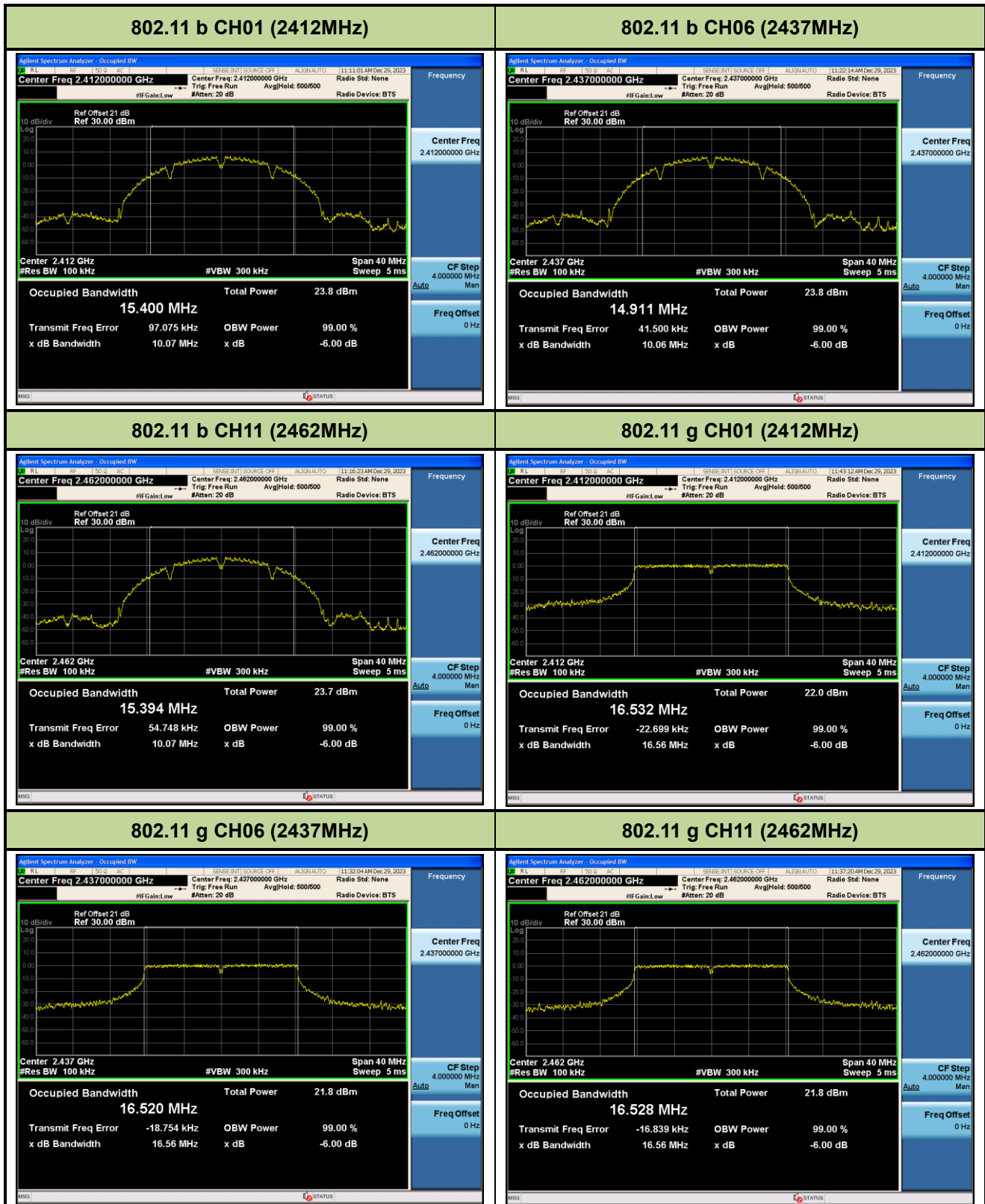

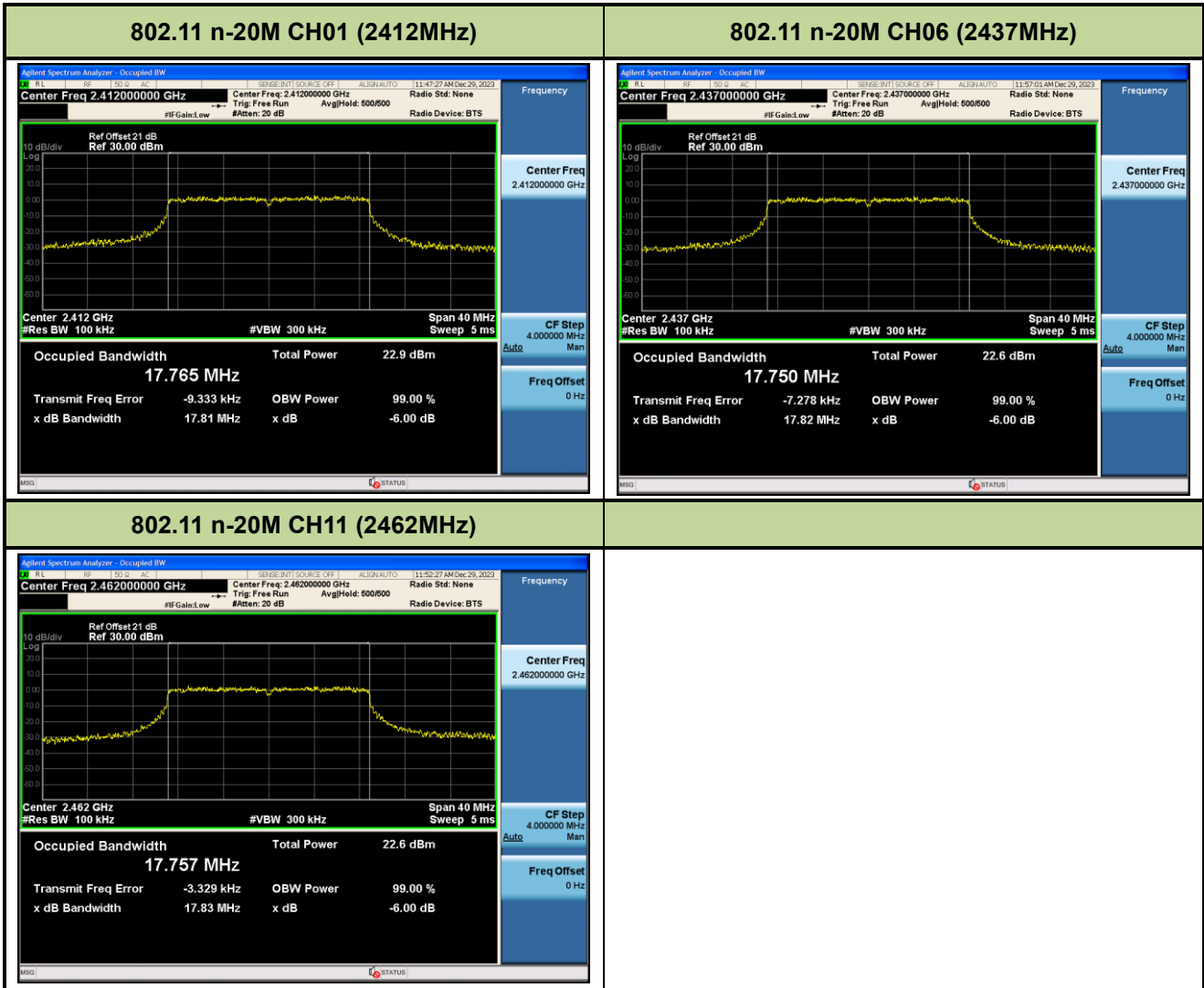

7.3. Output Power Measurement

7.3.1. Test Limit

The maximum out power shall be less 1 Watt (30dBm).

7.3.2. Test Procedure Used

ANSI C63.10 - 2013 Section 11.9.2.3.2

7.3.3. Test Setting

Peak Power Measurement

The maximum peak conducted output power may be measured using a broadband peak RF power meter. The power meter shall have a video bandwidth that is greater than or equal to the DTS bandwidth and shall utilize a fast-responding diode detector.

Average Power Measurement

Average power measurements were performed only when the EUT was transmitting at its maximum power control level using a broadband power meter with a pulse sensor. The power meter implemented triggering and gating capabilities which were set up such that power measurements were recorded only during the ON time of the transmitter. The trace was averaged over 100 traces to obtain the final measured average power.

7.3.4. Test Setup

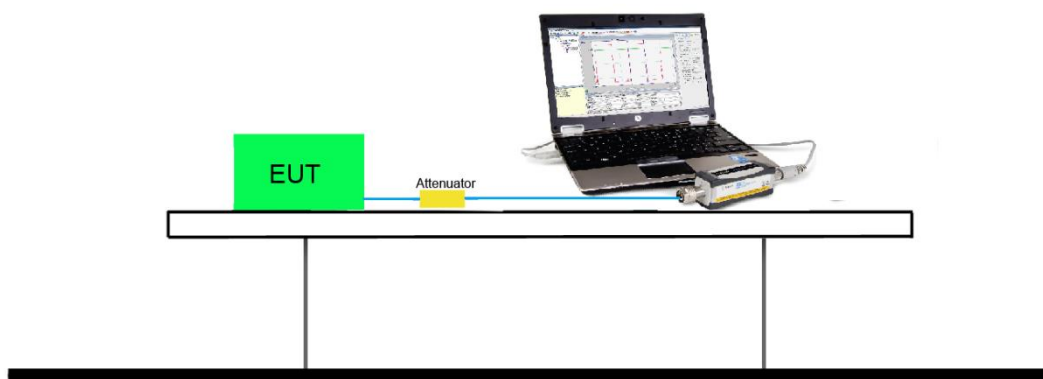

7.3.5. Test Result of Output Power

Model	Rate	Ch.	Freq. (MHz)	Peak Power (dBm)	Power Limit (dBm)
802.11b	1M	1	2412	21.37	30.00
	1M	6	2437	21.70	30.00
	1M	11	2462	21.32	30.00
802.11g	6M	1	2412	24.20	30.00
	6M	6	2437	24.46	30.00
	6M	11	2462	24.45	30.00
802.11n-HT20	MCS0	1	2412	24.37	30.00
	MCS0	6	2437	24.31	30.00
	MCS0	11	2462	24.39	30.00

Note: Output power = Reading value on power meter + cable loss ◦

7.4. Power Spectral Density Measurement

7.4.1. Test Limit

The maximum permissible power spectral density is 8dBm in any 3 kHz band.

7.4.2. Test Procedure Used

ANSI C63.10 - 2013 Section 11.10.5

7.4.3. Test Setting

This procedure shall be used if maximum peak conducted output power was used to demonstrate compliance, and is optional if the maximum conducted (average) output power was used to demonstrate compliance.

- a) Set analyzer center frequency to DTS channel center frequency.
- b) Set the span to 1.5 times the DTS bandwidth.
- c) Set the RBW to: 3 kHz.
- d) Set the VBW $\geq 3 \times$ RBW.
- e) Detector = peak.
- f) Sweep time = auto couple.
- g) Trace mode = max hold.
- h) Allow trace to fully stabilize.
- i) Use the peak marker function to determine the maximum amplitude level within the RBW.

7.4.4. Test Setup

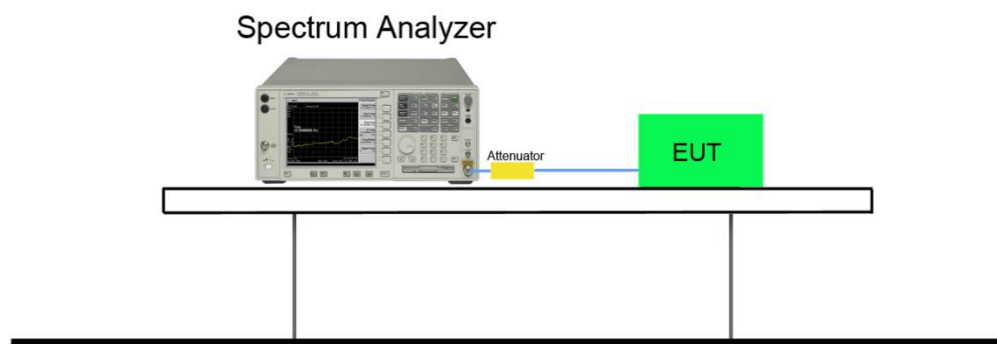

7.4.5. Test Result

Test Mode	Channel No.	Freq. (MHz)	PSD (dBm)	Limit (dBm)	Result
11b	1	2412	-5.307	≤ 8	Pass
11b	6	2437	-4.290	≤ 8	Pass
11b	11	2462	-3.768	≤ 8	Pass
11g	1	2412	-5.728	≤ 8	Pass
11g	6	2437	-4.802	≤ 8	Pass
11g	11	2462	-4.337	≤ 8	Pass
11n-20M	1	2412	-5.806	≤ 8	Pass
11n-20M	6	2437	-4.968	≤ 8	Pass
11n-20M	11	2462	-4.422	≤ 8	Pass

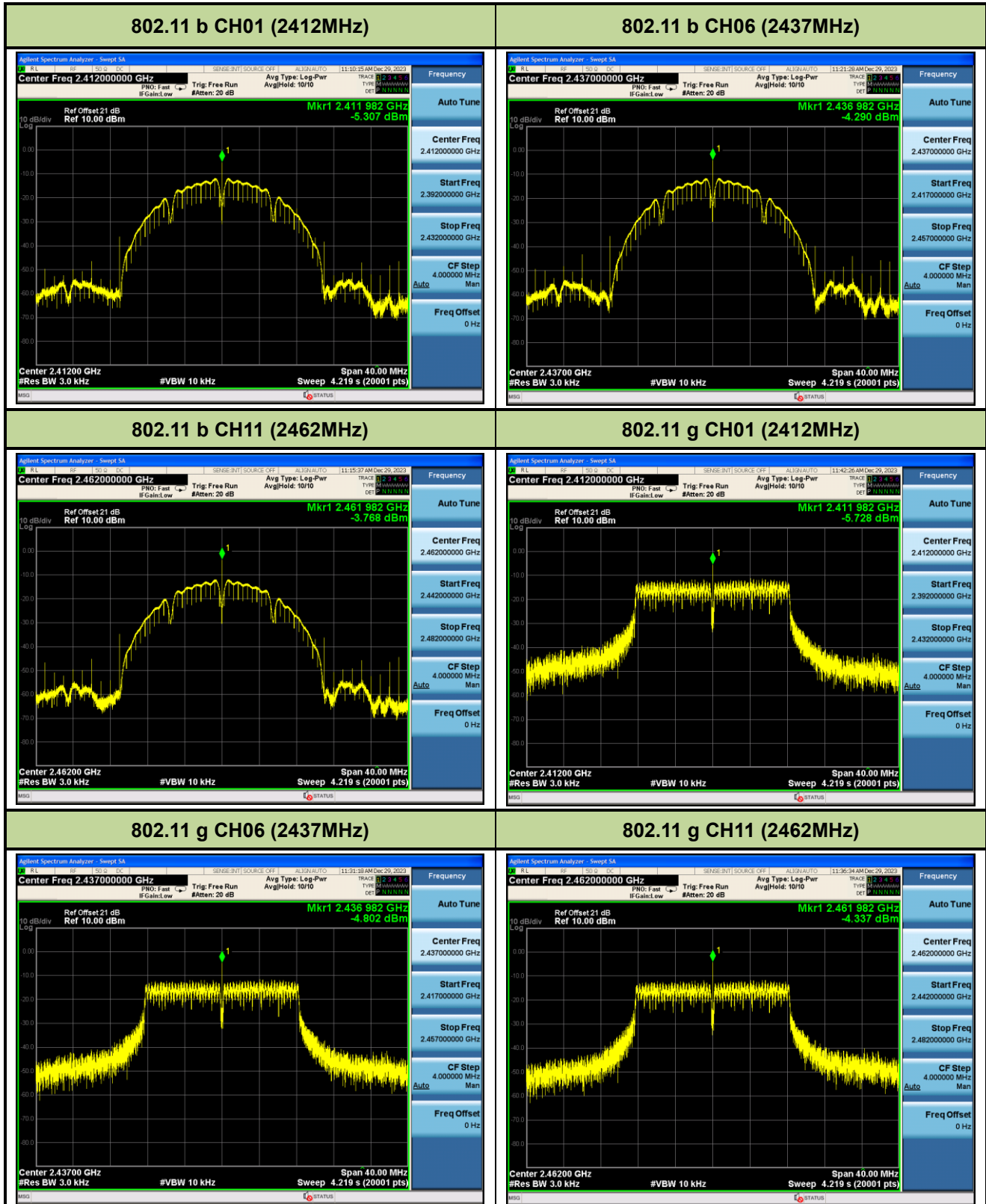

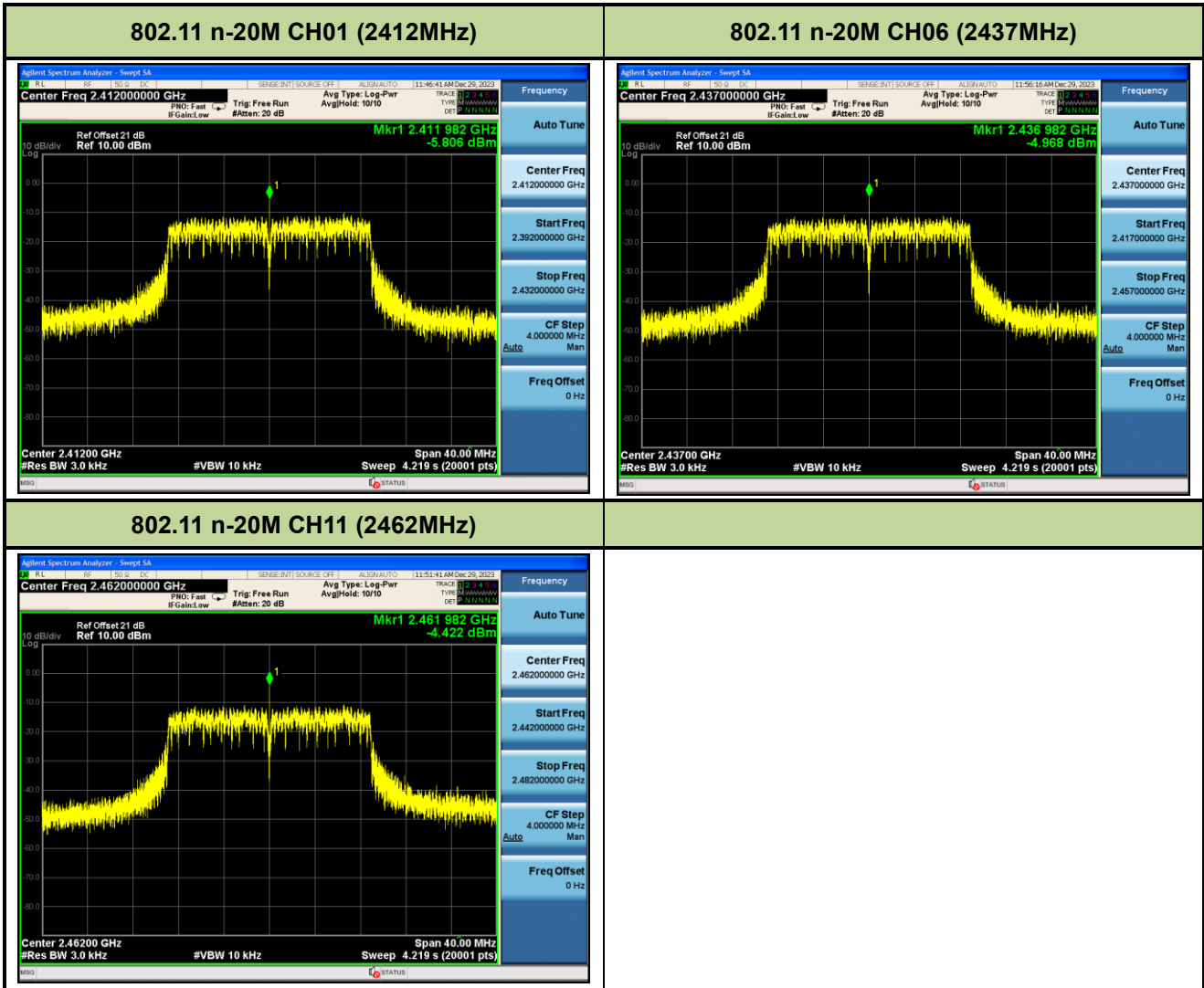

7.5. Out-of-Band Spurious Emissions Emissions Measurement

7.5.1. Test Limit

In any 100 kHz bandwidth outside the frequency band in which the spread spectrum or digitally modulated intentional radiator is operating, the radio frequency power that is produced by the intentional radiator shall be at least 20 dB below that in the 100 kHz bandwidth within the band that contains the highest level of the desired power, based on RF conducted measurement, provided the transmitter demonstrates compliance with the peak conducted power limits.

7.5.2. Test Procedure Used

ANSI C63.10 - 2013 Section 11.11

7.5.3. Test Setting

- (a) Set instrument center frequency to DTS channel center frequency
- (b) Set the span to ≥ 1.5 times the DTS bandwidth
- (c) Set the RBW = 100 kHz
- (d) Set the VBW $\geq 3 \times$ RBW
- (e) Detector = peak
- (f) Sweep time = auto couple
- (g) Trace mode = max hold
- (h) Allow trace to fully stabilize

7.5.4. Test Setup

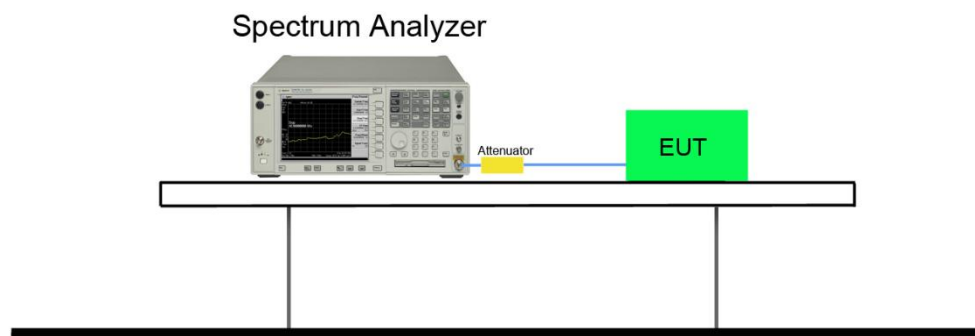

7.5.5. Test Result

Test Mode	Channel No.	Frequency (MHz)	Limit	Result
802.11b	01	2412	20dBc	Pass
802.11b	06	2437	20dBc	Pass
802.11b	11	2462	20dBc	Pass
802.11g	01	2412	20dBc	Pass
802.11g	06	2437	20dBc	Pass
802.11g	11	2462	20dBc	Pass
802.11n-20M	01	2412	20dBc	Pass
802.11n-20M	06	2437	20dBc	Pass
802.11n-20M	11	2462	20dBc	Pass

802.11 b CH01 (2412MHz)

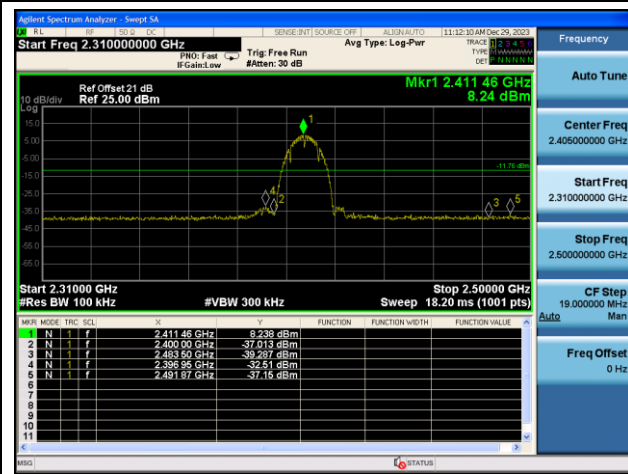

802.11 b CH01 (2412MHz)

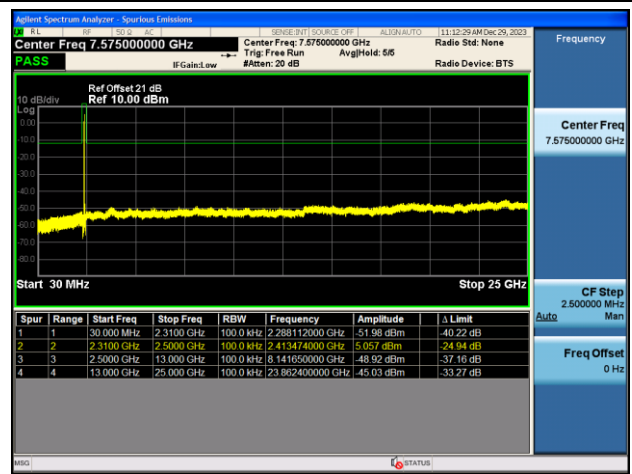

802.11 b CH06 (2437MHz)

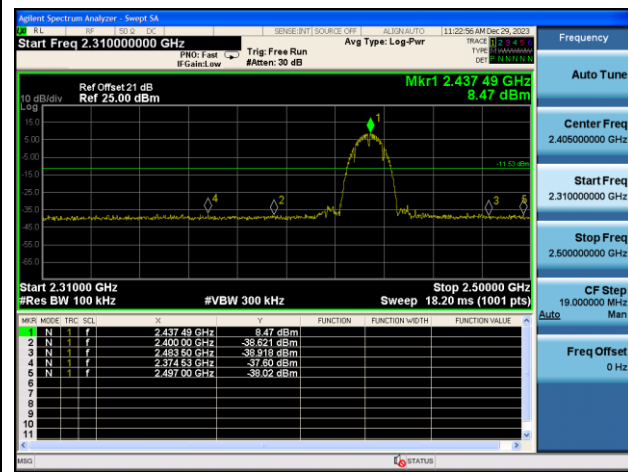

802.11 b CH06 (2437MHz)

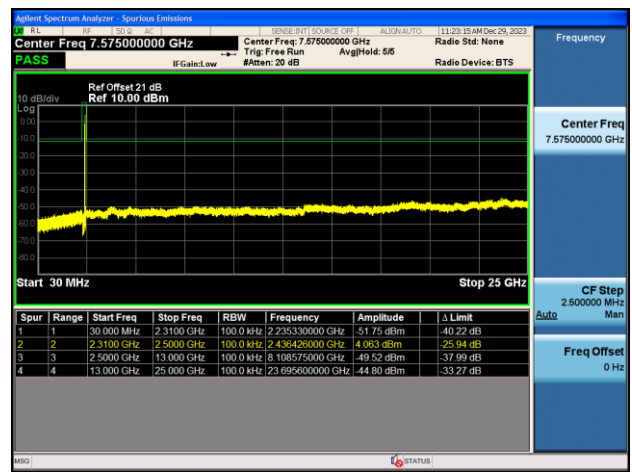

802.11 b CH11 (2462MHz)

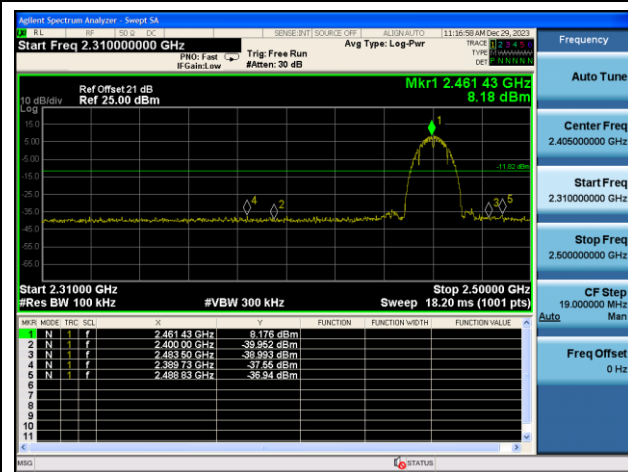

802.11 b CH11 (2462MHz)

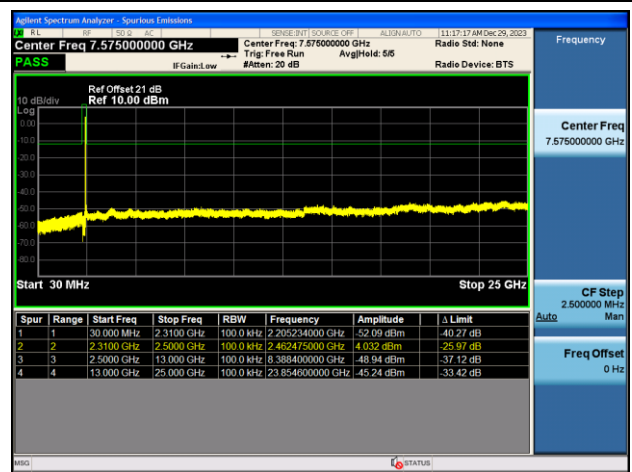

802.11 g CH01 (2412MHz)

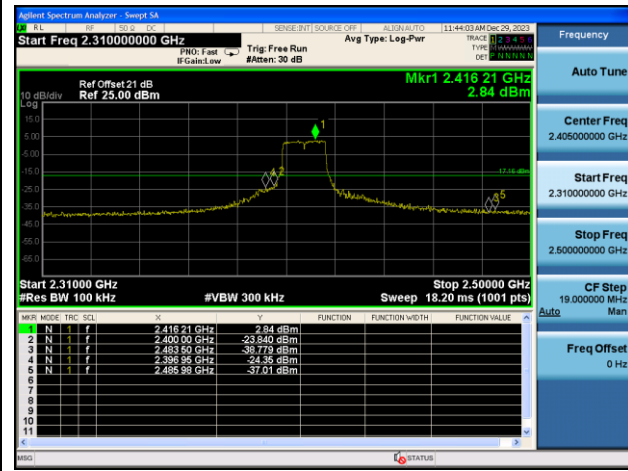

802.11 g CH01 (2412MHz)

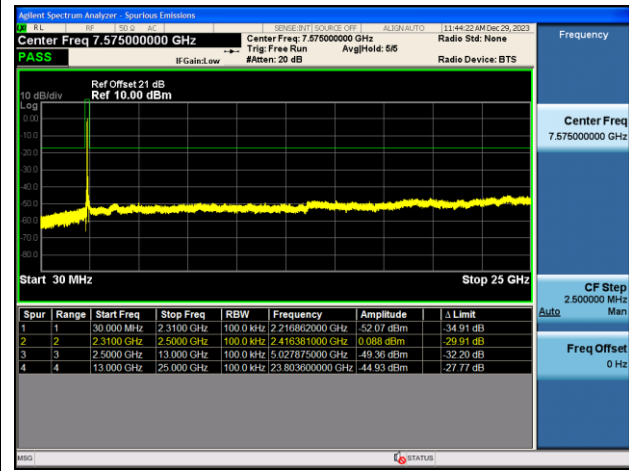

802.11 g CH06 (2437MHz)

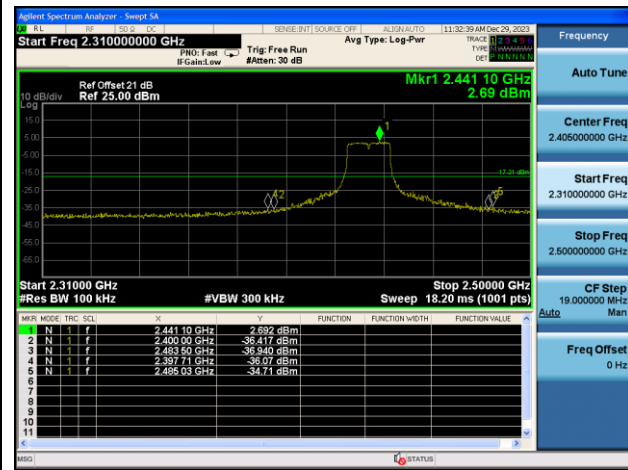

802.11 g CH06 (2437MHz)

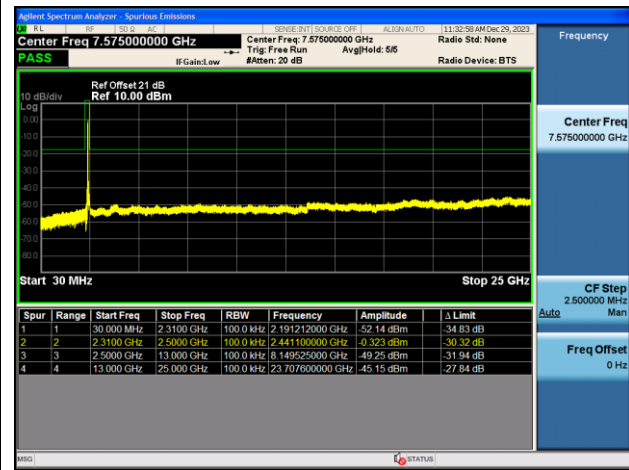

802.11 g CH11 (2462MHz)

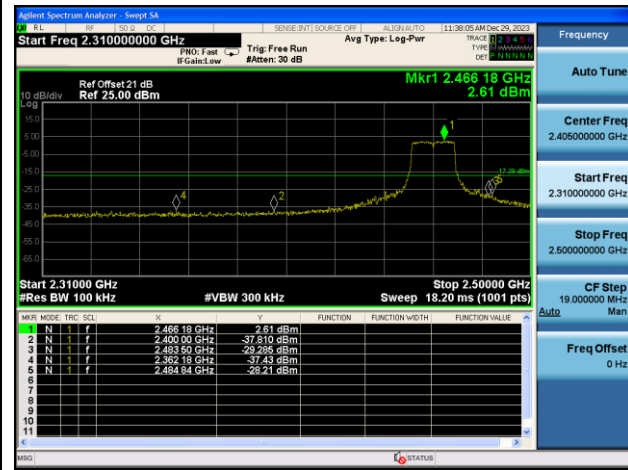

802.11 g CH11 (2462MHz)

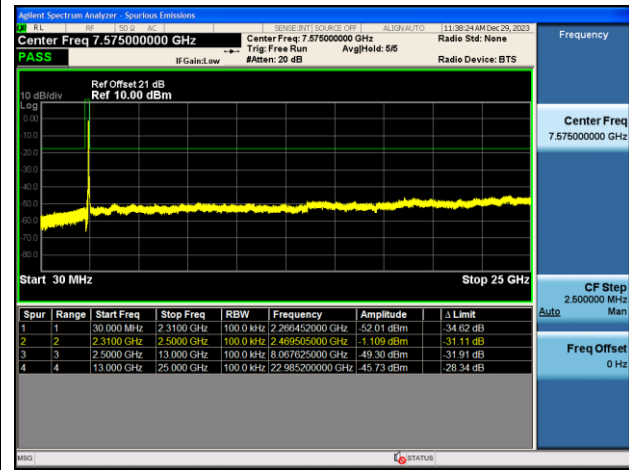

802.11 n20 CH01 (2412MHz)



802.11 n20 CH01 (2412MHz)

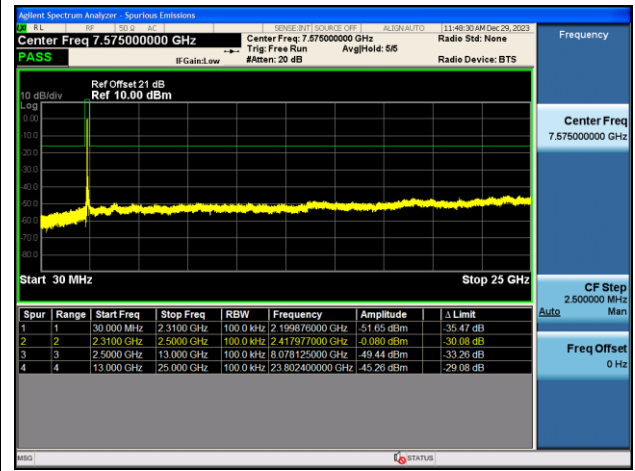

802.11 n20 CH06 (2437MHz)



802.11 n20 CH06 (2437MHz)

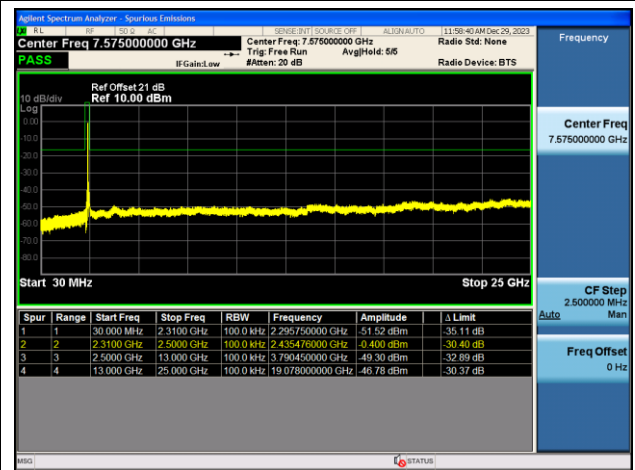

802.11 n20 CH11 (2462MHz)



802.11 n20 CH11 (2462MHz)

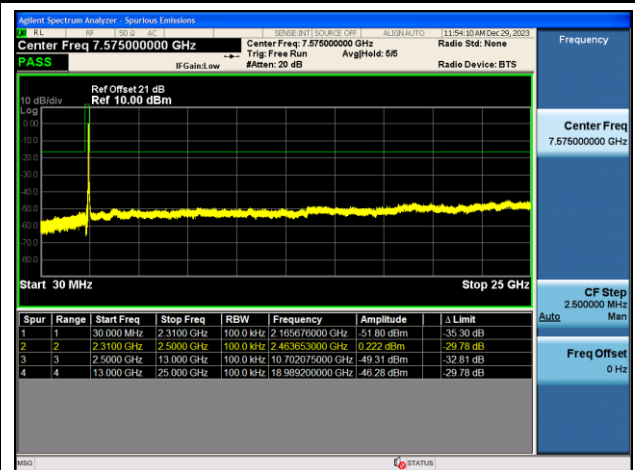

7.6. Radiated Spurious Emission Measurement

7.6.1. Test Limit

All out of band emissions appearing in a restricted band as specified in Section 15.205 of the Title 47 CFR must not exceed the limits shown in Table per Section 15.209.

FCC Part 15 Subpart C Paragraph 15.209		
Frequency [MHz]	Field Strength [V/m]	Measured Distance [Meters]
0.009 - 0.490	2400/F (kHz)	300
0.490 - 1.705	24000/F (kHz)	30
1.705 - 30	30	30
30 - 88	100	3
88 - 216	150	3
216 - 960	200	3
Above 960	500	3

7.6.2. Test Procedure Used

ANSI C63.10 - 2013 - Section 11.11 & 11.12

ANSI C63.10 - 2013 Section 6.3 (General Requirements)

ANSI C63.10 - 2013 Section 6.4 (Standard test method below 30MHz)

ANSI C63.10 - 2013 Section 6.5 (Standard test method above 30MHz to 1GHz)

ANSI C63.10 - 2013 Section 6.6 (Standard test method above 1GHz)

7.6.3. Test Setting

Peak Field Strength Measurements

1. Analyzer center frequency was set to the frequency of the radiated spurious emission of interest
2. RBW = as specified in Table 1
3. VBW = 3MHz

4. Detector = peak
5. Sweep time = auto couple
6. Trace mode = max hold
7. Trace was allowed to stabilize

Table 1 - RBW as a function of frequency

Frequency	RBW
9 ~ 150 kHz	200 ~ 300 Hz
0.15 ~ 30 MHz	9 ~ 10 kHz
30 ~ 1000 MHz	100 ~ 120 kHz
> 1000 MHz	1 MHz

Average Field Strength Measurements

1. Analyzer center frequency was set to the frequency of the radiated spurious emission of interest
2. RBW = 1MHz
3. VBW \geq 1/T
4. De As an alternative, the instrument may be set to linear detector mode. Ensure that video filtering is applied in linear voltage domain (rather than in a log or dB domain). Some instruments require linear display mode in order to accomplish this. Others have a setting for Average-VBW Type, which can be set to "Voltage" regardless of the display mode
5. Detector = Peak
6. Sweep time = auto
7. Trace mode = max hold
8. Allow max hold to run for at least 50 times (1/duty cycle) traces

7.6.4. Test Setup

9kHz ~ 30MHz Test Setup:

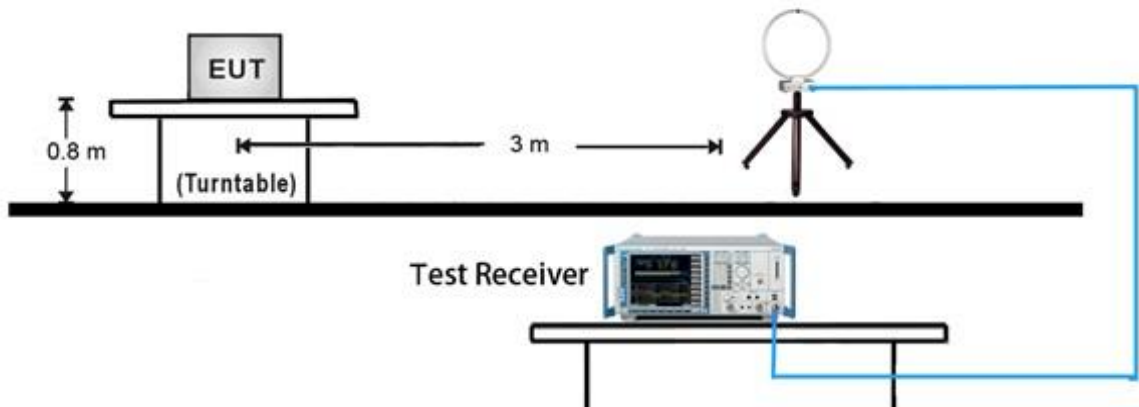

30MHz ~ 1GHz Test Setup:

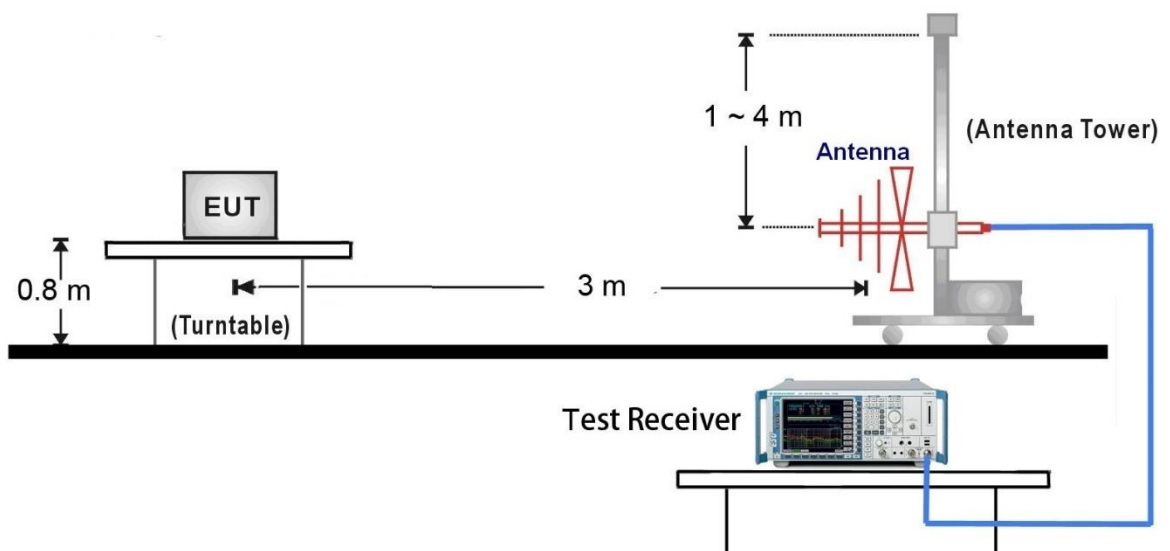

1GHz ~ 18GHz Test Setup:

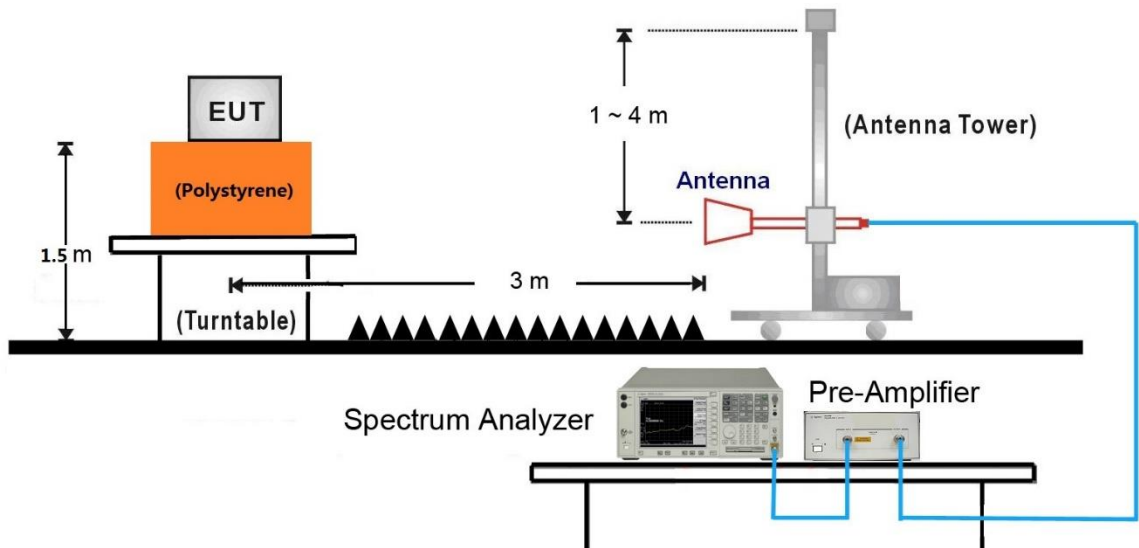

18GHz ~ 25GHz Test Setup:

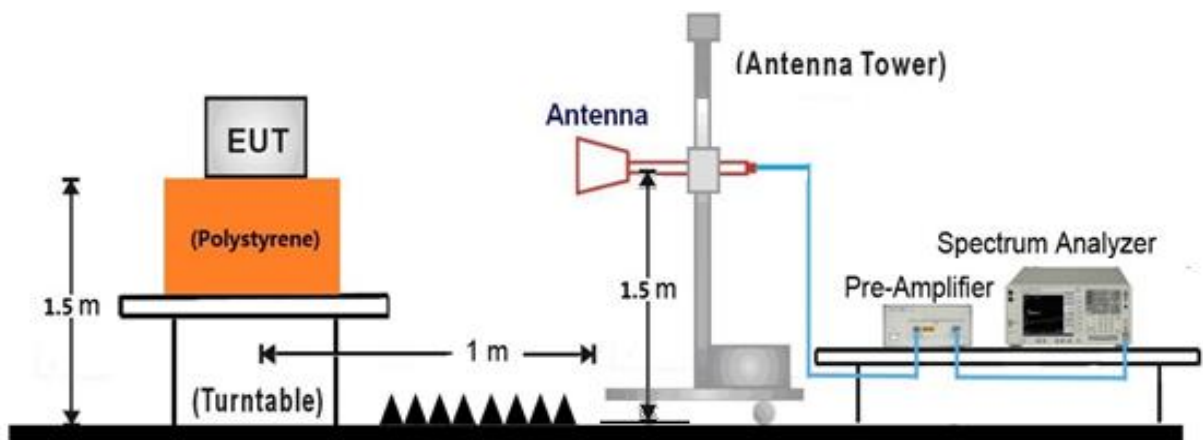

7.6.5. Test Result

EUT	Wi-Fi Φ 3.9mm 2ways borescope	Date of Test	2023-12-30
Factor	VULB 9162	Temp. / Humidity	24°C /64%
Polarity	Horizontal	Site / Test Engineer	AC1 / Todd
Test Mode	802.11n-20MHz_TX_CH 6_ANT 0	Test Voltage	AC 120V/60Hz

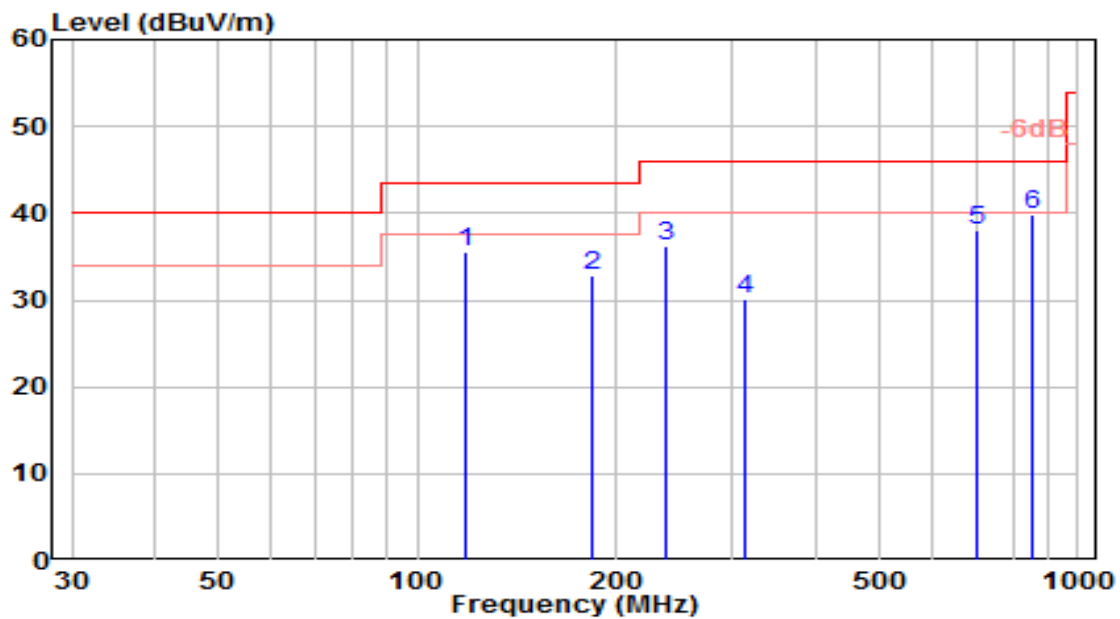

No	Frequency (MHz)	Reading (dBuV)	C.F (dB/m)	Measurement (dBuV/m)	Margin (dB)	Limit (dBuV/m)	Height (cm)	Angle (deg)	Remark (QP/PK/AV)
1	118.270	18.24	17.25	35.49	-8.01	43.50	150	300	QP
2	184.230	15.85	16.97	32.82	-10.68	43.50	100	80	QP
3	237.580	16.79	19.49	36.28	-9.72	46.00	100	260	QP
4	312.270	8.96	21.22	30.18	-15.82	46.00	100	255	QP
5	700.270	9.67	28.41	38.07	-7.93	46.00	100	50	QP
6	* 850.620	8.85	31.08	39.93	-6.07	46.00	100	150	QP

Note:

- " *", means this data is the worst emission level.
- C.F (Correction Factor) = Antenna Factor (dB/m)+ Cable Loss (dB).
- Measurement (dBuV/m) = Reading(dBuV) + C.F (Correction Factor).
- The emission levels of other frequencies are very lower than the limit and not show in test report.

EUT	Wi-Fi Φ3.9mm 2ways borescope	Date of Test	2023-12-30
Factor	VULB 9162	Temp. / Humidity	24°C /64%
Polarity	Vertical	Site / Test Engineer	AC1 / Todd
Test Mode	802.11n-20MHz_TX_CH 6_ANT 0	Test Voltage	AC 120V/60Hz

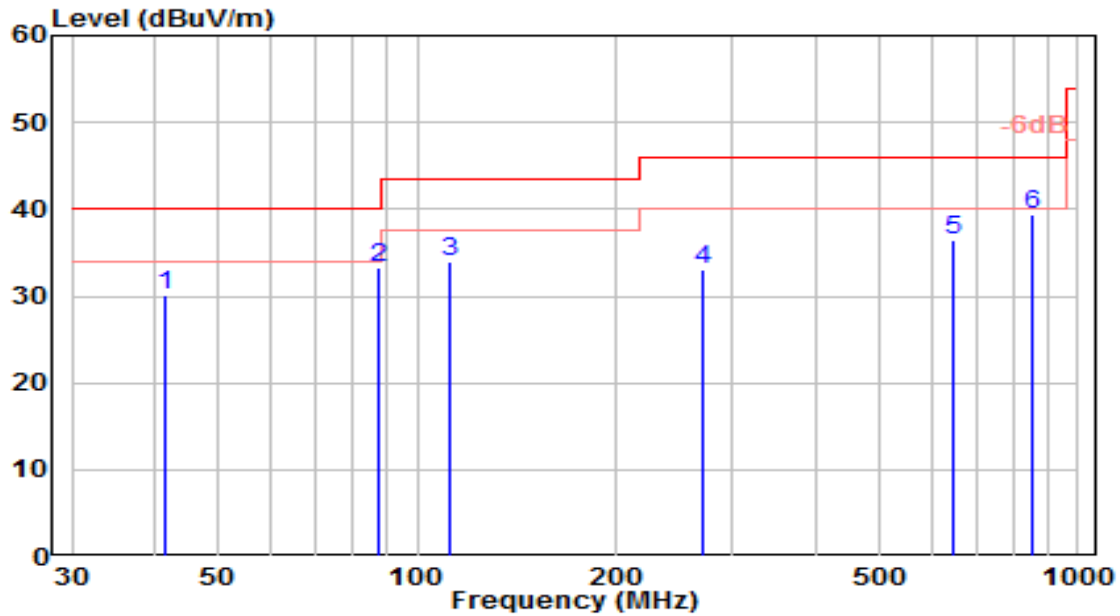

No	Frequency (MHz)	Reading (dBuV)	C.F (dB/m)	Measurement (dBuV/m)	Margin (dB)	Limit (dBuV/m)	Height (cm)	Angle (deg)	Remark (QP/PK/AV)
1	41.640	10.14	20.06	30.20	-9.80	40.00	100	150	QP
2	87.230	17.23	16.11	33.33	-6.67	40.00	100	340	QP
3	112.450	15.70	18.15	33.86	-9.64	43.50	100	240	QP
4	269.590	12.99	20.09	33.07	-12.93	46.00	150	175	QP
5	649.830	8.83	27.60	36.43	-9.57	46.00	100	355	QP
6	* 850.620	8.37	31.08	39.45	-6.55	46.00	100	360	QP

Note:

- "*" means this data is the worst emission level.
- C.F (Correction Factor) = Antenna Factor (dB/m)+ Cable Loss (dB).
- Measurement (dBuV/m) = Reading(dBuV) + C.F (Correction Factor).
- The emission levels of other frequencies are very lower than the limit and not show in test report.

EUT	Wi-Fi Φ3.9mm 2ways borescope	Date of Test	2023-12-29
Factor	BBHA 9120D & BBHA 9170	Temp. / Humidity	24°C /64%
Polarity	Horizontal	Site / Test Engineer	AC1 / Todd
Test Mode	802.11b_TX_CH 1_ANT 0	Test Voltage	AC 120V/60Hz

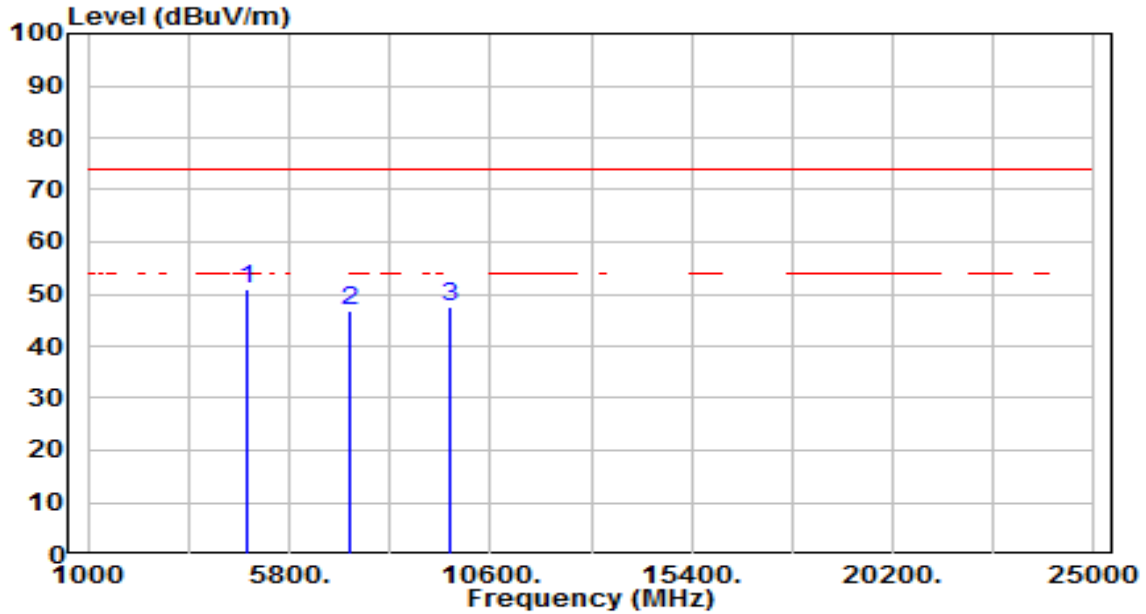

No	Frequency (MHz)	Reading (dBuV)	C.F (dB/m)	Measurement (dBuV/m)	Margin (dB)	Limit (dBuV/m)	Height (cm)	Angle (deg)	Remark (QP/PK/AV)
1	* 4824.000	47.44	3.66	51.10	-22.90	74.00	100	311	Peak
2	7236.000	35.31	11.57	46.88	-27.12	74.00	100	220	Peak
3	9648.000	32.16	15.56	47.71	-26.29	74.00	100	149	Peak

Note:

- "*", means this data is the worst emission level.
- C.F (Correction Factor) = Antenna Factor (dB/m)+ Cable Loss (dB) – Pre-amplifier(dB).
- Measurement (dBuV/m) = Reading(dBuV) + C.F (Correction Factor).
- The emission levels of other frequencies are very lower than the limit and not show in test report.

EUT	Wi-Fi Φ3.9mm 2ways borescope	Date of Test	2023-12-29
Factor	BBHA 9120D & BBHA 9170	Temp. / Humidity	24°C /64%
Polarity	Vertical	Site / Test Engineer	AC1 / Todd
Test Mode	802.11b_TX_CH 1_ANT 0	Test Voltage	AC 120V/60Hz

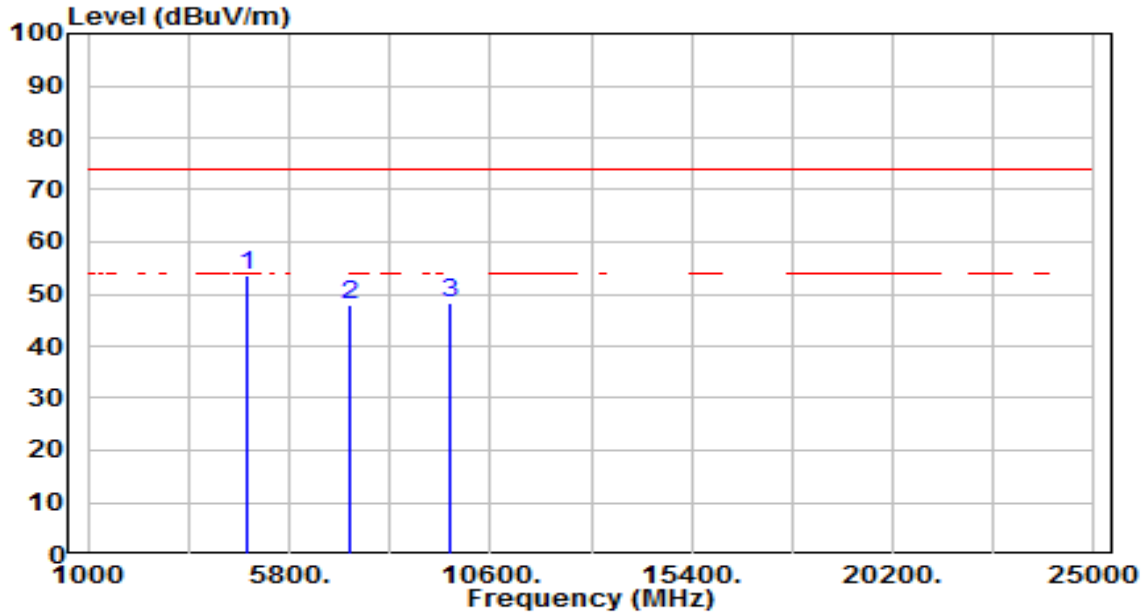

No	Frequency (MHz)	Reading (dBUV)	C.F (dB/m)	Measurement (dBUV/m)	Margin (dB)	Limit (dBUV/m)	Height (cm)	Angle (deg)	Remark (QP/PK/AV)
1	* 4824.000	49.83	3.66	53.50	-20.50	74.00	100	359	Peak
2	7236.000	36.32	11.57	47.89	-26.11	74.00	100	13	Peak
3	9648.000	32.83	15.56	48.38	-25.62	74.00	100	90	Peak

Note:

1. " *", means this data is the worst emission level.
2. C.F (Correction Factor) = Antenna Factor (dB/m)+ Cable Loss (dB) – Pre-amplifier(dB).
3. Measurement (dBUV/m) = Reading(dBUV) + C.F (Correction Factor).
4. The emission levels of other frequencies are very lower than the limit and not show in test report.

EUT	Wi-Fi Φ3.9mm 2ways borescope	Date of Test	2023-12-29
Factor	BBHA 9120D & BBHA 9170	Temp. / Humidity	24°C /64%
Polarity	Horizontal	Site / Test Engineer	AC1 / Todd
Test Mode	802.11b_TX_CH 6_ANT 0	Test Voltage	AC 120V/60Hz

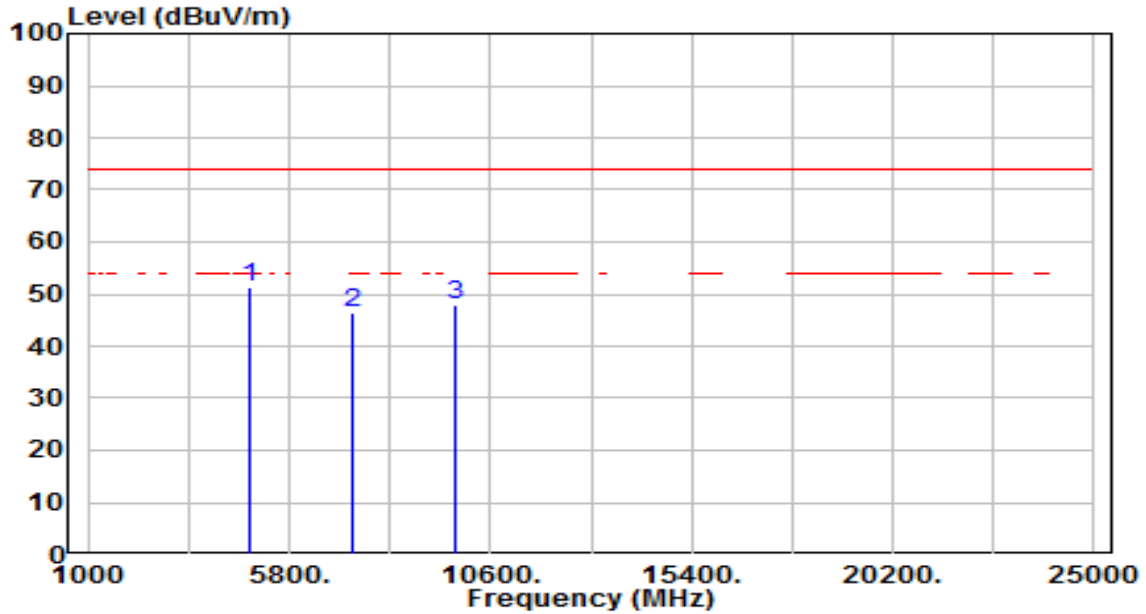

No	Frequency (MHz)	Reading (dBuV)	C.F (dB/m)	Measurement (dBuV/m)	Margin (dB)	Limit (dBuV/m)	Height (cm)	Angle (deg)	Remark (QP/PK/AV)
1	* 4874.000	47.58	3.77	51.35	-22.65	74.00	100	317	Peak
2	7311.000	34.63	11.83	46.46	-27.54	74.00	100	1	Peak
3	9748.000	32.18	15.78	47.96	-26.04	74.00	100	126	Peak

Note:

- "*", means this data is the worst emission level.
- C.F (Correction Factor) = Antenna Factor (dB/m)+ Cable Loss (dB) – Pre-amplifier(dB).
- Measurement (dBuV/m) = Reading(dBuV) + C.F (Correction Factor).
- The emission levels of other frequencies are very lower than the limit and not show in test report.

EUT	Wi-Fi Φ3.9mm 2ways borescope	Date of Test	2023-12-29
Factor	BBHA 9120D & BBHA 9170	Temp. / Humidity	24°C /64%
Polarity	Vertical	Site / Test Engineer	AC1 / Todd
Test Mode	802.11b_TX_CH 6_ANT 0	Test Voltage	AC 120V/60Hz

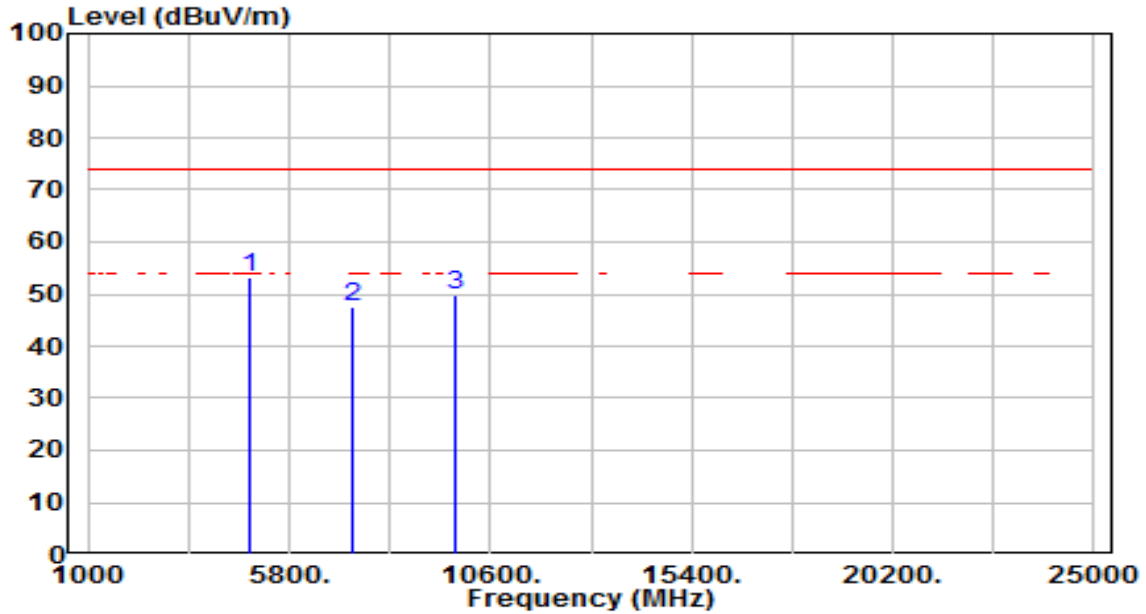

No	Frequency (MHz)	Reading (dBUV)	C.F (dB/m)	Measurement (dBUV/m)	Margin (dB)	Limit (dBUV/m)	Height (cm)	Angle (deg)	Remark (QP/PK/AV)
1	* 4874.000	49.62	3.77	53.40	-20.60	74.00	100	44	Peak
2	7311.000	35.73	11.83	47.57	-26.43	74.00	100	3	Peak
3	9748.000	33.95	15.78	49.72	-24.28	74.00	100	98	Peak

Note:

1. " *", means this data is the worst emission level.
2. C.F (Correction Factor) = Antenna Factor (dB/m)+ Cable Loss (dB) – Pre-amplifier(dB).
3. Measurement (dBUV/m) = Reading(dBUV) + C.F (Correction Factor).
4. The emission levels of other frequencies are very lower than the limit and not show in test report.

EUT	Wi-Fi Φ3.9mm 2ways borescope	Date of Test	2023-12-29
Factor	BBHA 9120D & BBHA 9170	Temp. / Humidity	24°C /64%
Polarity	Horizontal	Site / Test Engineer	AC1 / Todd
Test Mode	802.11b_TX_CH 11_ANT 0	Test Voltage	AC 120V/60Hz

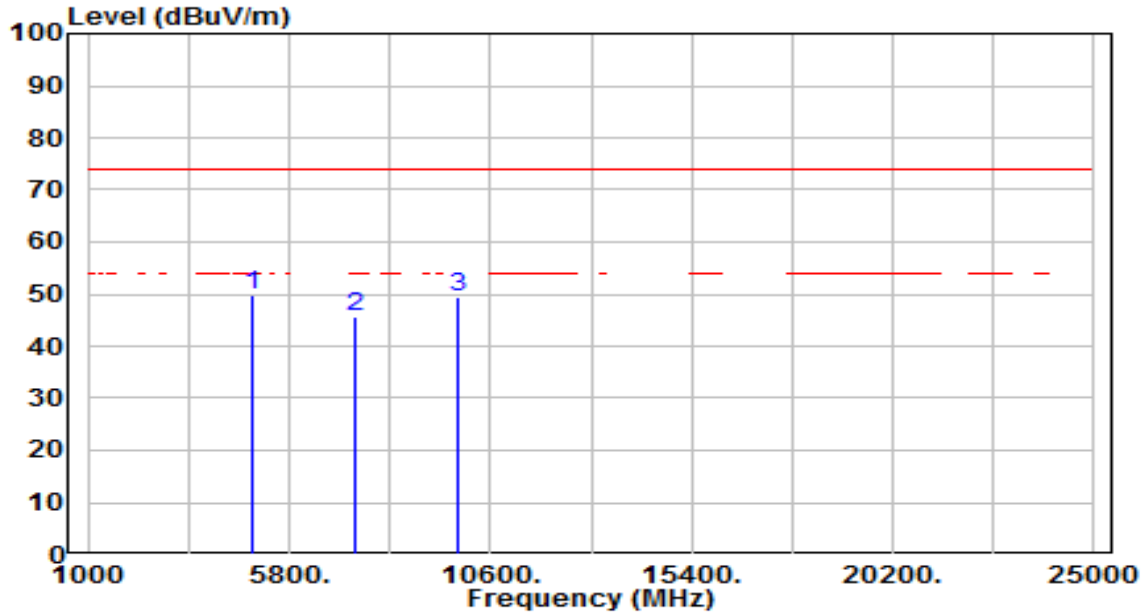

No	Frequency (MHz)	Reading (dBUV)	C.F (dB/m)	Measurement (dBUV/m)	Margin (dB)	Limit (dBUV/m)	Height (cm)	Angle (deg)	Remark (QP/PK/AV)
1	* 4924.000	45.84	3.88	49.72	-24.28	74.00	100	140	Peak
2	7386.000	33.72	12.10	45.82	-28.18	74.00	100	178	Peak
3	9848.000	33.24	16.00	49.25	-24.75	74.00	100	189	Peak

Note:

1. " *", means this data is the worst emission level.
2. C.F (Correction Factor) = Antenna Factor (dB/m)+ Cable Loss (dB) – Pre-amplifier(dB).
3. Measurement (dBUV/m) = Reading(dBUV) + C.F (Correction Factor).
4. The emission levels of other frequencies are very lower than the limit and not show in test report.

EUT	Wi-Fi Φ3.9mm 2ways borescope	Date of Test	2023-12-29
Factor	BBHA 9120D & BBHA 9170	Temp. / Humidity	24°C /64%
Polarity	Vertical	Site / Test Engineer	AC1 / Todd
Test Mode	802.11b_TX_CH 11_ANT 0	Test Voltage	AC 120V/60Hz

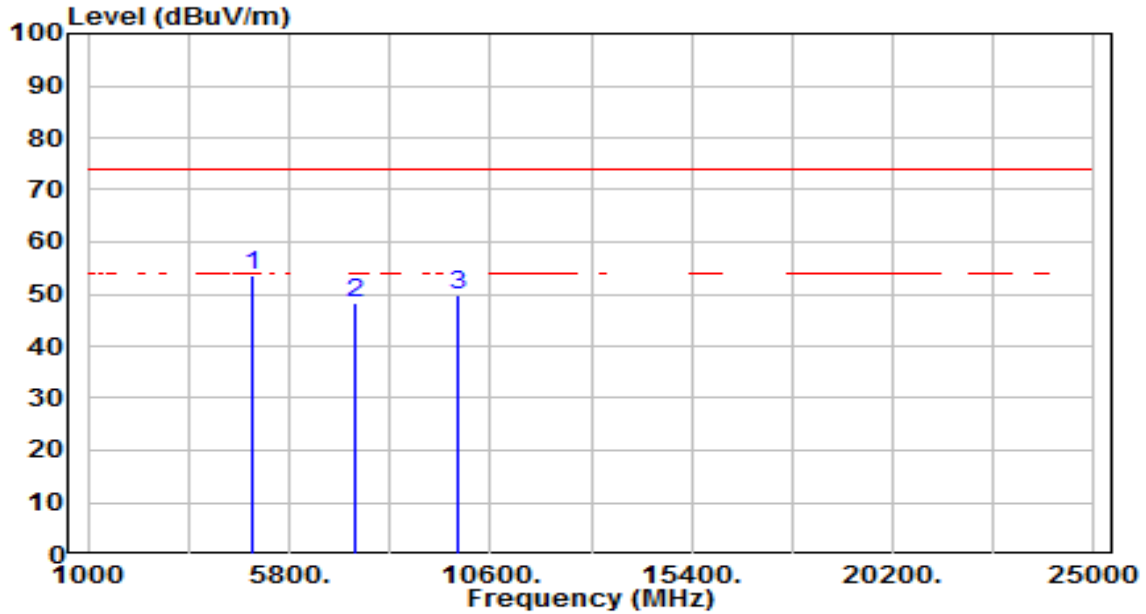

No	Frequency (MHz)	Reading (dBuV)	C.F (dB/m)	Measurement (dBuV/m)	Margin (dB)	Limit (dBuV/m)	Height (cm)	Angle (deg)	Remark (QP/PK/AV)
1	* 4924.000	49.72	3.88	53.61	-20.39	74.00	100	22	Peak
2	7386.000	36.17	12.10	48.27	-25.73	74.00	100	18	Peak
3	9848.000	33.66	16.00	49.66	-24.34	74.00	100	253	Peak

Note:

1. " *", means this data is the worst emission level.
2. C.F (Correction Factor) = Antenna Factor (dB/m)+ Cable Loss (dB) – Pre-amplifier(dB).
3. Measurement (dBuV/m) = Reading(dBuV) + C.F (Correction Factor).
4. The emission levels of other frequencies are very lower than the limit and not show in test report.

EUT	Wi-Fi Φ3.9mm 2ways borescope	Date of Test	2023-12-29
Factor	BBHA 9120D & BBHA 9170	Temp. / Humidity	24°C /64%
Polarity	Horizontal	Site / Test Engineer	AC1 / Todd
Test Mode	802.11g_TX_CH 1_ANT 0	Test Voltage	AC 120V/60Hz

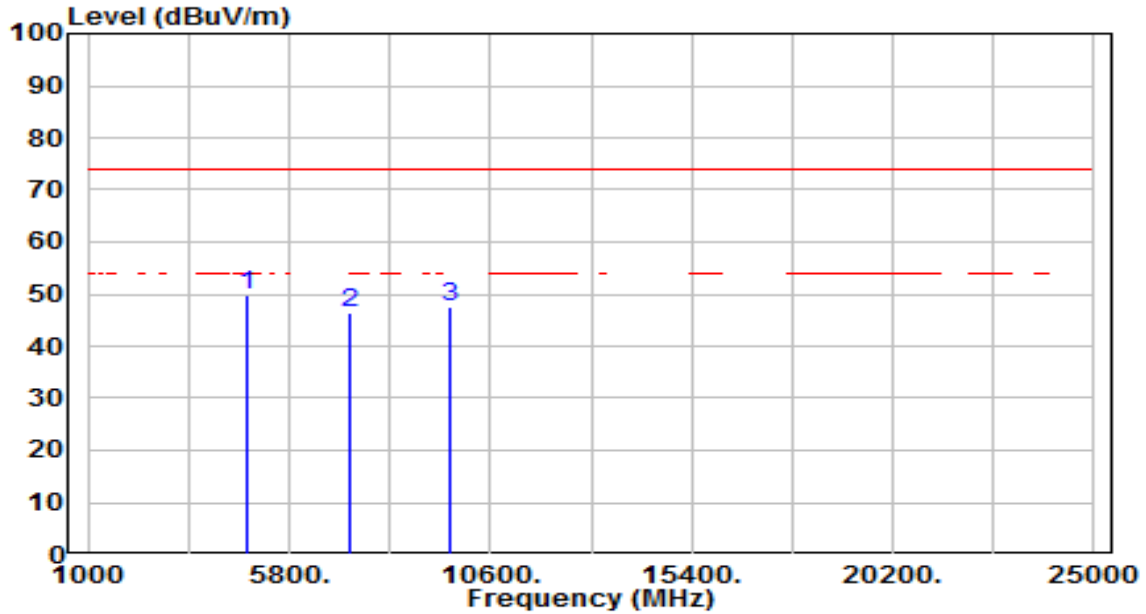

No	Frequency (MHz)	Reading (dBuV)	C.F (dB/m)	Measurement (dBuV/m)	Margin (dB)	Limit (dBuV/m)	Height (cm)	Angle (deg)	Remark (QP/PK/AV)
1	* 4824.000	46.09	3.66	49.75	-24.25	74.00	100	316	Peak
2	7236.000	34.76	11.57	46.33	-27.67	74.00	100	327	Peak
3	9648.000	32.08	15.56	47.64	-26.36	74.00	100	316	Peak

Note:

1. " *", means this data is the worst emission level.
2. C.F (Correction Factor) = Antenna Factor (dB/m)+ Cable Loss (dB) – Pre-amplifier(dB).
3. Measurement (dBuV/m) = Reading(dBuV) + C.F (Correction Factor).
4. The emission levels of other frequencies are very lower than the limit and not show in test report.

EUT	Wi-Fi Φ3.9mm 2ways borescope	Date of Test	2023-12-29
Factor	BBHA 9120D & BBHA 9170	Temp. / Humidity	24°C /64%
Polarity	Vertical	Site / Test Engineer	AC1 / Todd
Test Mode	802.11g_TX_CH 1_ANT 0	Test Voltage	AC 120V/60Hz

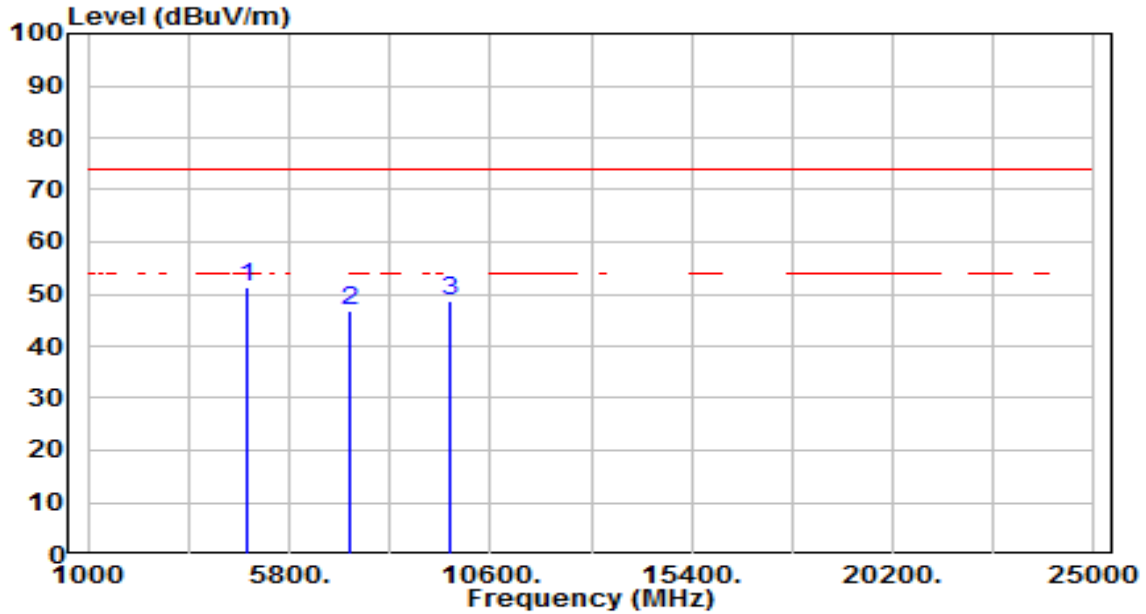

No	Frequency (MHz)	Reading (dBuV)	C.F (dB/m)	Measurement (dBuV/m)	Margin (dB)	Limit (dBuV/m)	Height (cm)	Angle (deg)	Remark (QP/PK/AV)
1	* 4824.000	47.78	3.66	51.44	-22.56	74.00	100	4	Peak
2	7236.000	35.28	11.57	46.85	-27.15	74.00	100	344	Peak
3	9648.000	32.95	15.56	48.50	-25.50	74.00	100	323	Peak

Note:

1. " *", means this data is the worst emission level.
2. C.F (Correction Factor) = Antenna Factor (dB/m)+ Cable Loss (dB) – Pre-amplifier(dB).
3. Measurement (dBuV/m) = Reading(dBuV) + C.F (Correction Factor).
4. The emission levels of other frequencies are very lower than the limit and not show in test report.

EUT	Wi-Fi Φ3.9mm 2ways borescope	Date of Test	2023-12-29
Factor	BBHA 9120D & BBHA 9170	Temp. / Humidity	24°C /64%
Polarity	Horizontal	Site / Test Engineer	AC1 / Todd
Test Mode	802.11g_TX_CH 6_ANT 0	Test Voltage	AC 120V/60Hz

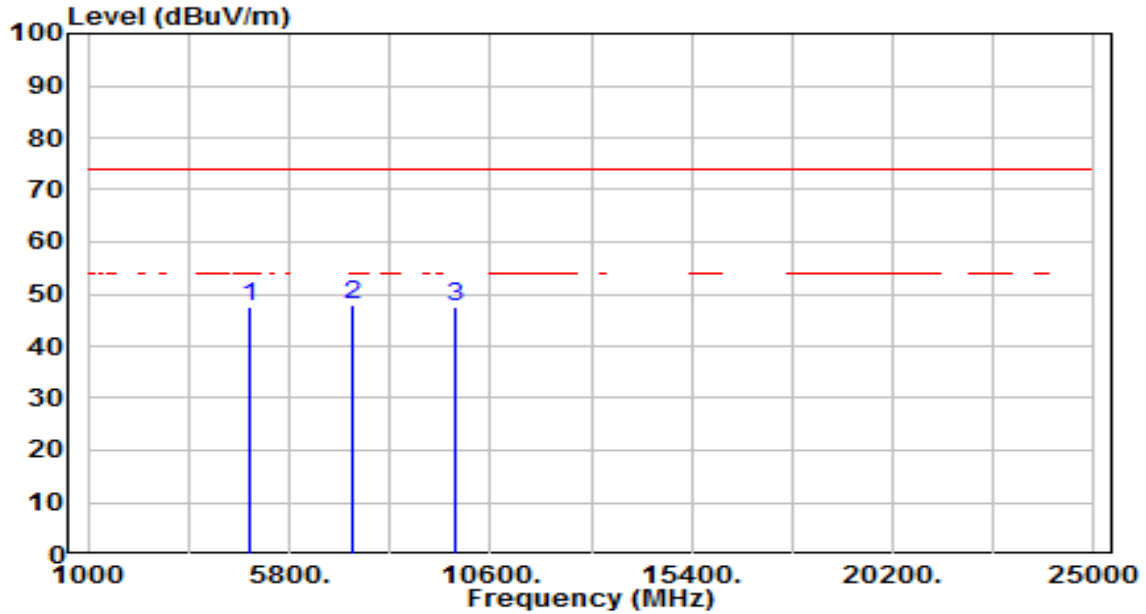

No	Frequency (MHz)	Reading (dBuV)	C.F (dB/m)	Measurement (dBuV/m)	Margin (dB)	Limit (dBuV/m)	Height (cm)	Angle (deg)	Remark (QP/PK/AV)
1	4874.000	43.69	3.77	47.47	-26.53	74.00	100	93	Peak
2	* 7311.000	36.19	11.83	48.03	-25.97	74.00	100	316	Peak
3	9748.000	31.92	15.78	47.70	-26.30	74.00	100	241	Peak

Note:

- "*", means this data is the worst emission level.
- C.F (Correction Factor) = Antenna Factor (dB/m)+ Cable Loss (dB) – Pre-amplifier(dB).
- Measurement (dBuV/m) = Reading(dBuV) + C.F (Correction Factor).
- The emission levels of other frequencies are very lower than the limit and not show in test report.

EUT	Wi-Fi Φ3.9mm 2ways borescope	Date of Test	2023-12-29
Factor	BBHA 9120D & BBHA 9170	Temp. / Humidity	24°C /64%
Polarity	Vertical	Site / Test Engineer	AC1 / Todd
Test Mode	802.11g_TX_CH 6_ANT 0	Test Voltage	AC 120V/60Hz

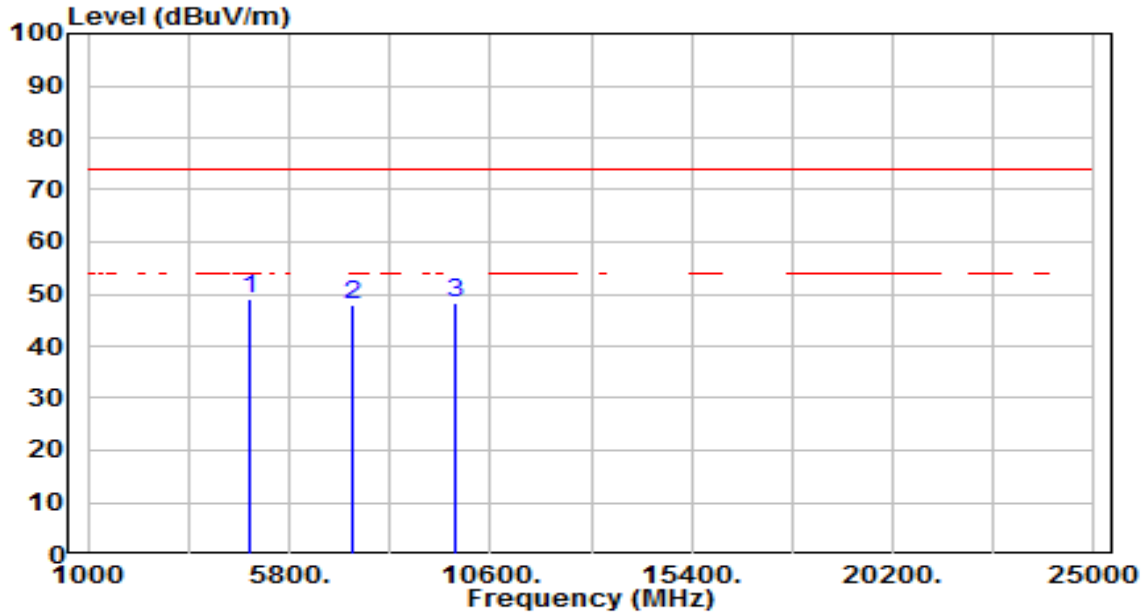

No	Frequency (MHz)	Reading (dBuV)	C.F (dB/m)	Measurement (dBuV/m)	Margin (dB)	Limit (dBuV/m)	Height (cm)	Angle (deg)	Remark (QP/PK/AV)
1	* 4874.000	45.36	3.77	49.14	-24.86	74.00	100	30	Peak
2	7311.000	36.17	11.83	48.01	-25.99	74.00	100	16	Peak
3	9748.000	32.63	15.78	48.41	-25.59	74.00	100	192	Peak

Note:

- "*", means this data is the worst emission level.
- C.F (Correction Factor) = Antenna Factor (dB/m)+ Cable Loss (dB) – Pre-amplifier(dB).
- Measurement (dBuV/m) = Reading(dBuV) + C.F (Correction Factor).
- The emission levels of other frequencies are very lower than the limit and not show in test report.

EUT	Wi-Fi Φ3.9mm 2ways borescope	Date of Test	2023-12-29
Factor	BBHA 9120D & BBHA 9170	Temp. / Humidity	24°C /64%
Polarity	Horizontal	Site / Test Engineer	AC1 / Todd
Test Mode	802.11g_TX_CH 11_ANT 0	Test Voltage	AC 120V/60Hz

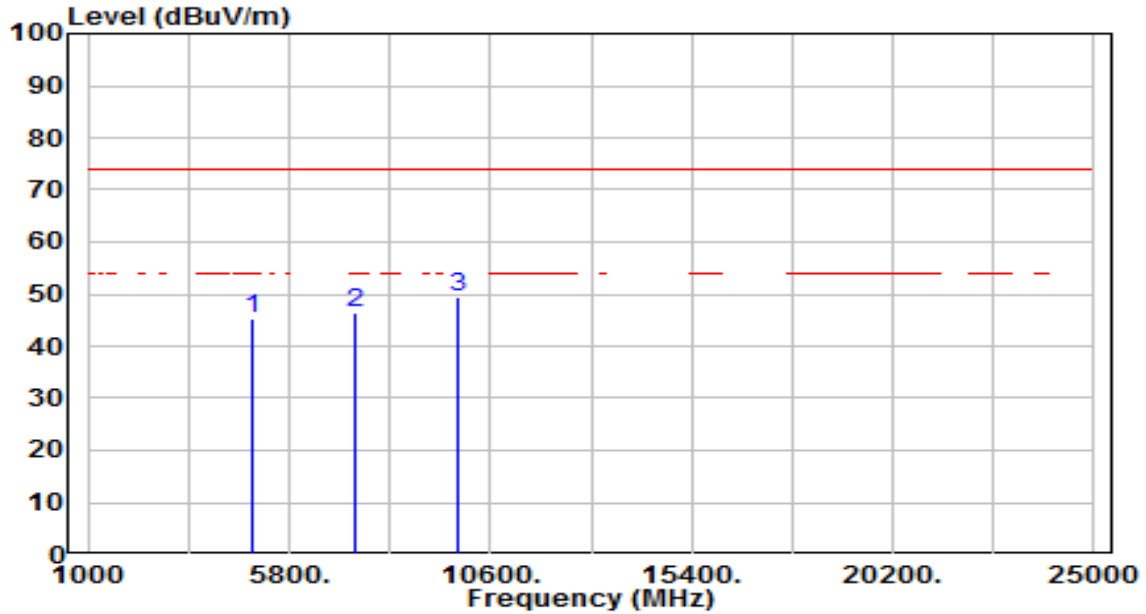

No	Frequency (MHz)	Reading (dBuV)	C.F (dB/m)	Measurement (dBuV/m)	Margin (dB)	Limit (dBuV/m)	Height (cm)	Angle (deg)	Remark (QP/PK/AV)
1	4924.000	41.46	3.88	45.34	-28.66	74.00	100	132	Peak
2	7386.000	34.28	12.10	46.38	-27.62	74.00	100	217	Peak
3	* 9848.000	33.35	16.00	49.35	-24.65	74.00	100	100	Peak

Note:

1. " *", means this data is the worst emission level.
2. C.F (Correction Factor) = Antenna Factor (dB/m)+ Cable Loss (dB) – Pre-amplifier(dB).
3. Measurement (dBuV/m) = Reading(dBuV) + C.F (Correction Factor).
4. The emission levels of other frequencies are very lower than the limit and not show in test report.

EUT	Wi-Fi Φ3.9mm 2ways borescope	Date of Test	2023-12-29
Factor	BBHA 9120D & BBHA 9170	Temp. / Humidity	24°C /64%
Polarity	Vertical	Site / Test Engineer	AC1 / Todd
Test Mode	802.11g_TX_CH 11_ANT 0	Test Voltage	AC 120V/60Hz

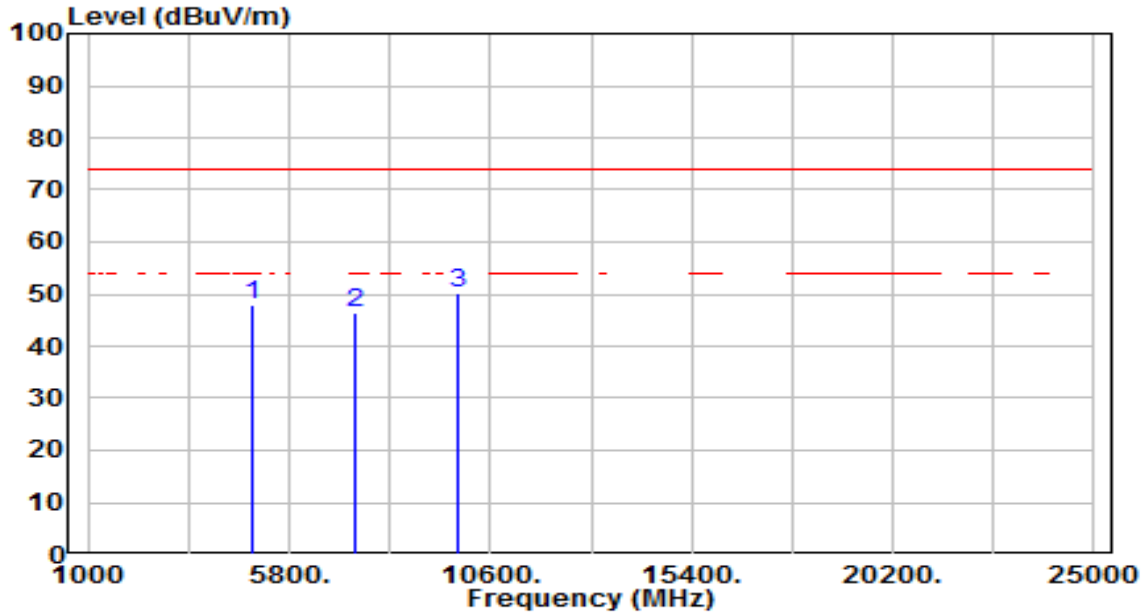

No	Frequency (MHz)	Reading (dBuV)	C.F (dB/m)	Measurement (dBuV/m)	Margin (dB)	Limit (dBuV/m)	Height (cm)	Angle (deg)	Remark (QP/PK/AV)
1	4924.000	44.02	3.88	47.90	-26.10	74.00	100	27	Peak
2	7386.000	34.40	12.10	46.50	-27.50	74.00	100	16	Peak
3	* 9848.000	34.07	16.00	50.07	-23.93	74.00	100	169	Peak

Note:

1. " *", means this data is the worst emission level.
2. C.F (Correction Factor) = Antenna Factor (dB/m)+ Cable Loss (dB) – Pre-amplifier(dB).
3. Measurement (dBuV/m) = Reading(dBuV) + C.F (Correction Factor).
4. The emission levels of other frequencies are very lower than the limit and not show in test report.

EUT	Wi-Fi Φ3.9mm 2ways borescope	Date of Test	2023-12-29
Factor	BBHA 9120D & BBHA 9170	Temp. / Humidity	24°C /64%
Polarity	Horizontal	Site / Test Engineer	AC1 / Todd
Test Mode	802.11n-20MHz_TX_CH 1_ANT 0	Test Voltage	AC 120V/60Hz

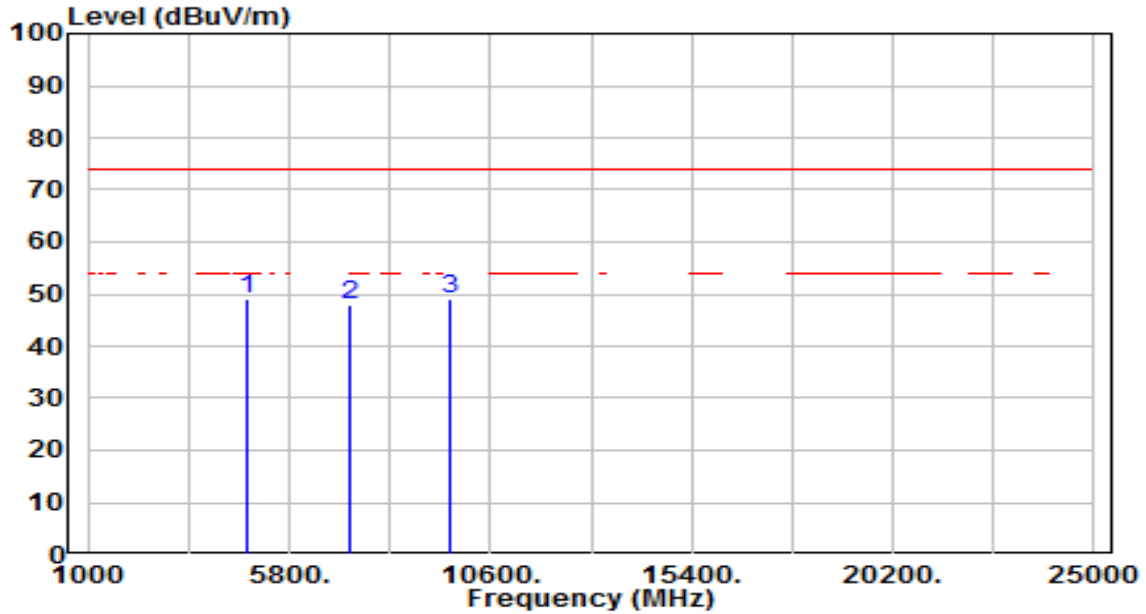

No	Frequency (MHz)	Reading (dBuV)	C.F (dB/m)	Measurement (dBuV/m)	Margin (dB)	Limit (dBuV/m)	Height (cm)	Angle (deg)	Remark (QP/PK/AV)
1	4824.000	45.36	3.66	49.02	-24.98	74.00	100	89	Peak
2	7236.000	36.26	11.57	47.83	-26.17	74.00	100	213	Peak
3	* 9648.000	33.54	15.56	49.09	-24.91	74.00	100	29	Peak

Note:

1. " *", means this data is the worst emission level.
2. C.F (Correction Factor) = Antenna Factor (dB/m)+ Cable Loss (dB) – Pre-amplifier(dB).
3. Measurement (dBuV/m) = Reading(dBuV) + C.F (Correction Factor).
4. The emission levels of other frequencies are very lower than the limit and not show in test report.

EUT	Wi-Fi Φ3.9mm 2ways borescope	Date of Test	2023-12-29
Factor	BBHA 9120D & BBHA 9170	Temp. / Humidity	24°C /64%
Polarity	Vertical	Site / Test Engineer	AC1 / Todd
Test Mode	802.11n-20MHz_TX_CH 1_ANT 0	Test Voltage	AC 120V/60Hz

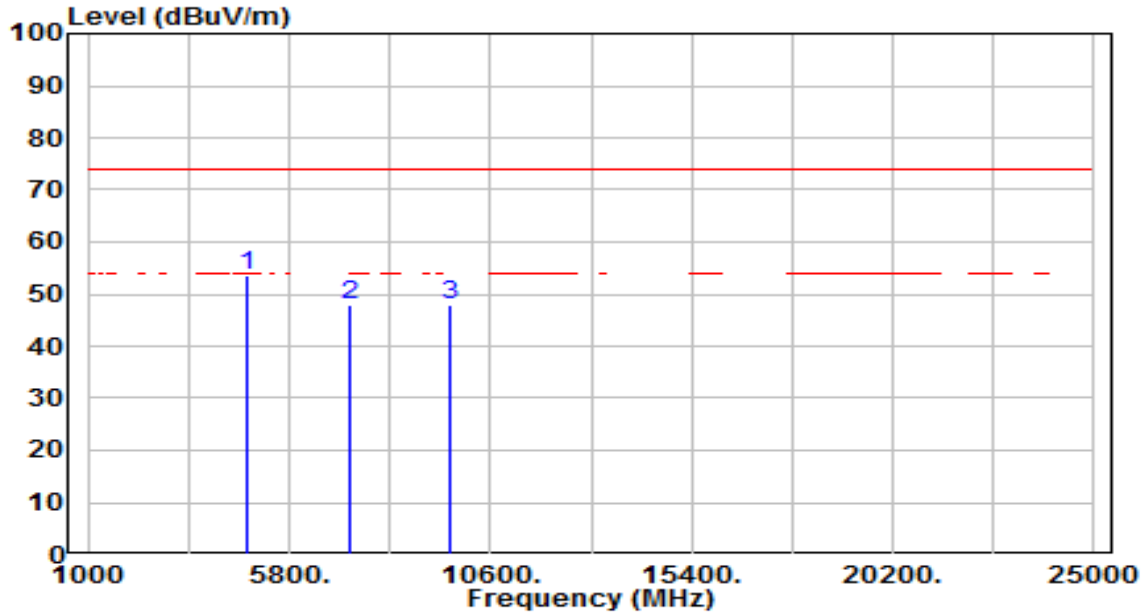

No	Frequency (MHz)	Reading (dBuV)	C.F (dB/m)	Measurement (dBuV/m)	Margin (dB)	Limit (dBuV/m)	Height (cm)	Angle (deg)	Remark (QP/PK/AV)
1	* 4824.000	49.92	3.66	53.59	-20.41	74.00	100	16	Peak
2	7236.000	36.18	11.57	47.75	-26.25	74.00	100	23	Peak
3	9648.000	32.44	15.56	47.99	-26.01	74.00	100	338	Peak

Note:

- "*", means this data is the worst emission level.
- C.F (Correction Factor) = Antenna Factor (dB/m)+ Cable Loss (dB) – Pre-amplifier(dB).
- Measurement (dBuV/m) = Reading(dBuV) + C.F (Correction Factor).
- The emission levels of other frequencies are very lower than the limit and not show in test report.

EUT	Wi-Fi Φ3.9mm 2ways borescope	Date of Test	2023-12-29
Factor	BBHA 9120D & BBHA 9170	Temp. / Humidity	24°C /64%
Polarity	Horizontal	Site / Test Engineer	AC1 / Todd
Test Mode	802.11n-20MHz_TX_CH 6_ANT 0	Test Voltage	AC 120V/60Hz

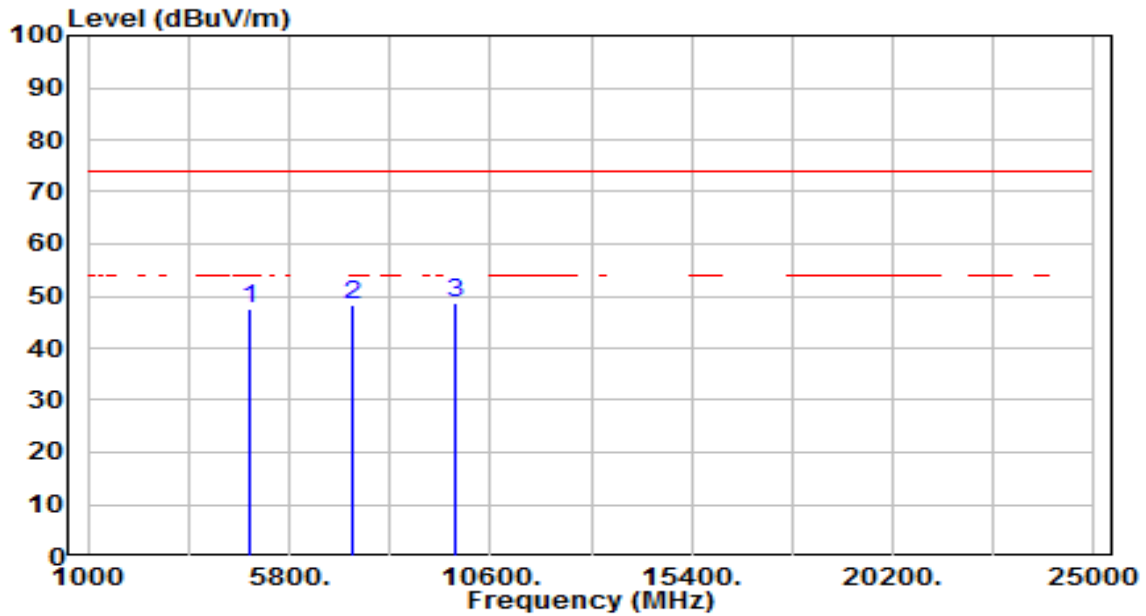

No	Frequency (MHz)	Reading (dBuV)	C.F (dB/m)	Measurement (dBuV/m)	Margin (dB)	Limit (dBuV/m)	Height (cm)	Angle (deg)	Remark (QP/PK/AV)
1	4874.000	43.68	3.77	47.46	-26.54	74.00	100	312	Peak
2	7311.000	36.37	11.83	48.20	-25.80	74.00	100	344	Peak
3	* 9748.000	32.90	15.78	48.68	-25.32	74.00	100	220	Peak

Note:

- "*", means this data is the worst emission level.
- C.F (Correction Factor) = Antenna Factor (dB/m)+ Cable Loss (dB) – Pre-amplifier(dB).
- Measurement (dBuV/m) = Reading(dBuV) + C.F (Correction Factor).
- The emission levels of other frequencies are very lower than the limit and not show in test report.

EUT	Wi-Fi Φ3.9mm 2ways borescope	Date of Test	2023-12-29
Factor	BBHA 9120D & BBHA 9170	Temp. / Humidity	24°C /64%
Polarity	Vertical	Site / Test Engineer	AC1 / Todd
Test Mode	802.11n-20MHz_TX_CH 6_ANT 0	Test Voltage	AC 120V/60Hz

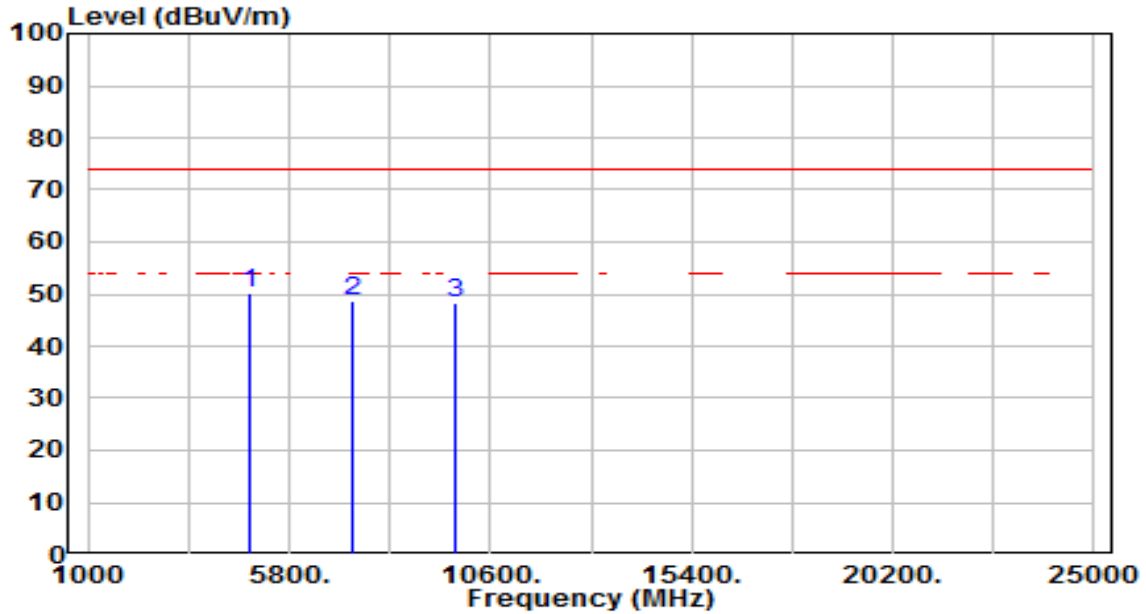

No	Frequency (MHz)	Reading (dBuV)	C.F (dB/m)	Measurement (dBuV/m)	Margin (dB)	Limit (dBuV/m)	Height (cm)	Angle (deg)	Remark (QP/PK/AV)
1	* 4874.000	46.49	3.77	50.26	-23.74	74.00	100	3	Peak
2	7311.000	36.70	11.83	48.54	-25.46	74.00	100	9	Peak
3	9748.000	32.45	15.78	48.23	-25.77	74.00	100	34	Peak

Note:

- "*", means this data is the worst emission level.
- C.F (Correction Factor) = Antenna Factor (dB/m)+ Cable Loss (dB) – Pre-amplifier(dB).
- Measurement (dBuV/m) = Reading(dBuV) + C.F (Correction Factor).
- The emission levels of other frequencies are very lower than the limit and not show in test report.

EUT	Wi-Fi Φ3.9mm 2ways borescope	Date of Test	2023-12-29
Factor	BBHA 9120D & BBHA 9170	Temp. / Humidity	24°C /64%
Polarity	Horizontal	Site / Test Engineer	AC1 / Todd
Test Mode	802.11n-20MHz_TX_CH 11_ANT 0	Test Voltage	AC 120V/60Hz

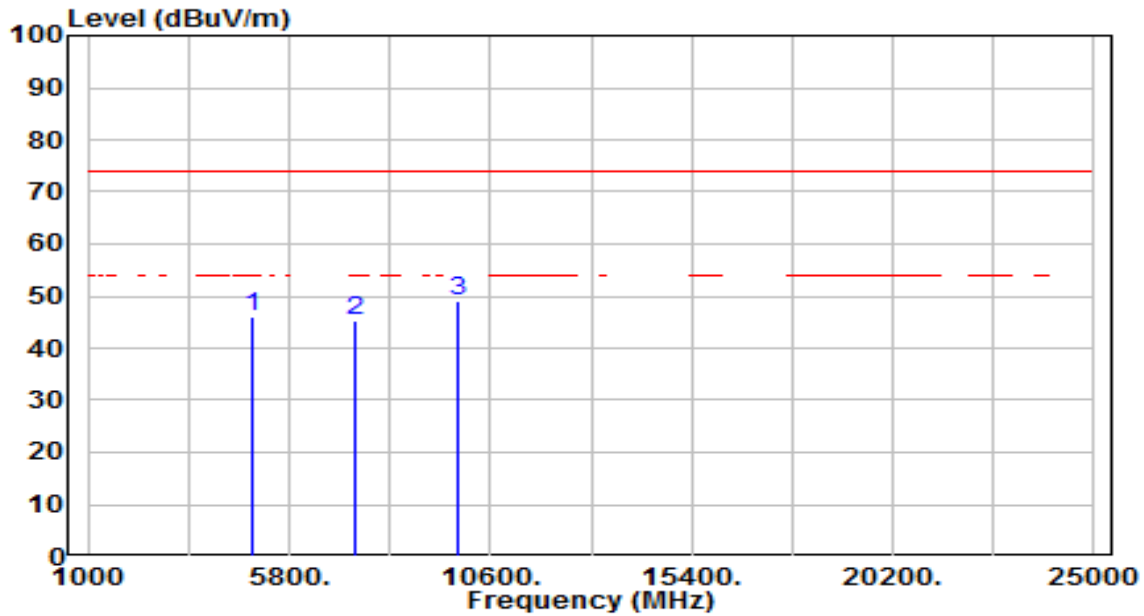

No	Frequency (MHz)	Reading (dBuV)	C.F (dB/m)	Measurement (dBuV/m)	Margin (dB)	Limit (dBuV/m)	Height (cm)	Angle (deg)	Remark (QP/PK/AV)
1	4924.000	42.00	3.88	45.88	-28.12	74.00	100	313	Peak
2	7386.000	33.23	12.10	45.33	-28.67	74.00	100	97	Peak
3	* 9848.000	33.24	16.00	49.24	-24.76	74.00	100	295	Peak

Note:

- "*", means this data is the worst emission level.
- C.F (Correction Factor) = Antenna Factor (dB/m)+ Cable Loss (dB) – Pre-amplifier(dB).
- Measurement (dBuV/m) = Reading(dBuV) + C.F (Correction Factor).
- The emission levels of other frequencies are very lower than the limit and not show in test report.

EUT	Wi-Fi Φ3.9mm 2ways borescope	Date of Test	2023-12-29
Factor	BBHA 9120D & BBHA 9170	Temp. / Humidity	24°C /64%
Polarity	Vertical	Site / Test Engineer	AC1 / Todd
Test Mode	802.11n-20MHz_TX_CH 11_ANT 0	Test Voltage	AC 120V/60Hz

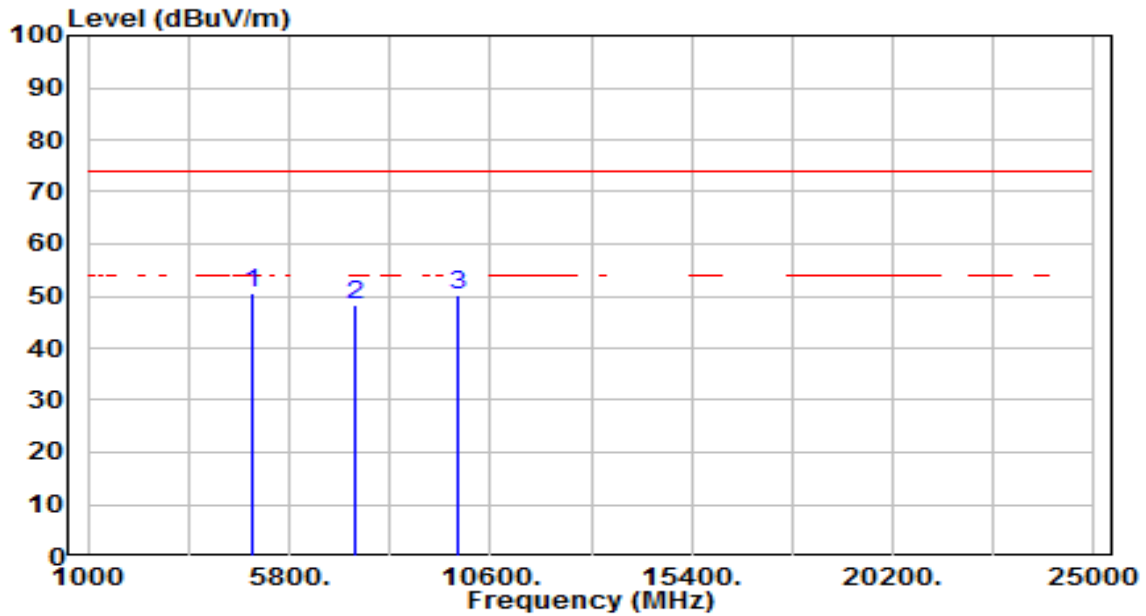

No	Frequency (MHz)	Reading (dBuV)	C.F (dB/m)	Measurement (dBuV/m)	Margin (dB)	Limit (dBuV/m)	Height (cm)	Angle (deg)	Remark (QP/PK/AV)
1	* 4924.000	46.56	3.88	50.44	-23.56	74.00	100	34	Peak
2	7386.000	36.04	12.10	48.14	-25.86	74.00	100	16	Peak
3	9848.000	34.27	16.00	50.28	-23.72	74.00	100	94	Peak

Note:

- "*", means this data is the worst emission level.
- C.F (Correction Factor) = Antenna Factor (dB/m)+ Cable Loss (dB) – Pre-amplifier(dB).
- Measurement (dBuV/m) = Reading(dBuV) + C.F (Correction Factor).
- The emission levels of other frequencies are very lower than the limit and not show in test report.

7.7. Radiated Restricted Band Edge Measurement

7.7.1. Test Limit

All out of band emissions appearing in a restricted band as specified in Section 15.205 of the Title 47 CFR must not exceed the limits shown in Table per Section 15.209.

FCC Part 15 Subpart C Paragraph 15.209		
Frequency [MHz]	Field Strength [V/m]	Measured Distance [Meters]
0.009 - 0.490	2400/F (kHz)	300
0.490 - 1.705	24000/F (kHz)	30
1.705 – 30	30	30
30 – 88	100	3
88 – 216	150	3
216 – 960	200	3
Above 960	500	3

7.7.2. Test Procedure Used

ANSI C63.10 - 2013 Section 6.3 (General Requirements)

ANSI C63.10 - 2013 Section 6.6 (Standard test method above 1GHz)

7.7.3. Test Setting

Peak Field Strength Measurements

1. Analyzer center frequency was set to the frequency of the radiated spurious emission of interest
2. RBW = as specified in Table 1
3. VBW = 3 * RBW
4. Detector = peak
5. Sweep time = auto couple
6. Trace mode = max hold

- Trace was allowed to stabilize

Table 1 - RBW as a function of frequency

Frequency	RBW
9 ~ 150 kHz	200 ~ 300 Hz
0.15 ~ 30 MHz	9 ~ 10 kHz
30 ~ 1000 MHz	100 ~ 120 kHz
> 1000 MHz	1 MHz

Average Field Strength Measurements

- Analyzer center frequency was set to the frequency of the radiated spurious emission of interest
- RBW = 1MHz
- VBW $\geq 1/T$
- De As an alternative, the instrument may be set to linear detector mode. Ensure that video filtering is applied in linear voltage domain (rather than in a log or dB domain). Some instruments require linear display mode in order to accomplish this. Others have a setting for Average-VBW Type, which can be set to "Voltage" regardless of the display mode
- Detector = Peak
- Sweep time = auto
- Trace mode = max hold
- Allow max hold to run for at least 50 times (1/duty cycle) traces

7.7.4. Test Setup

1GHz ~ 18GHz Test Setup:

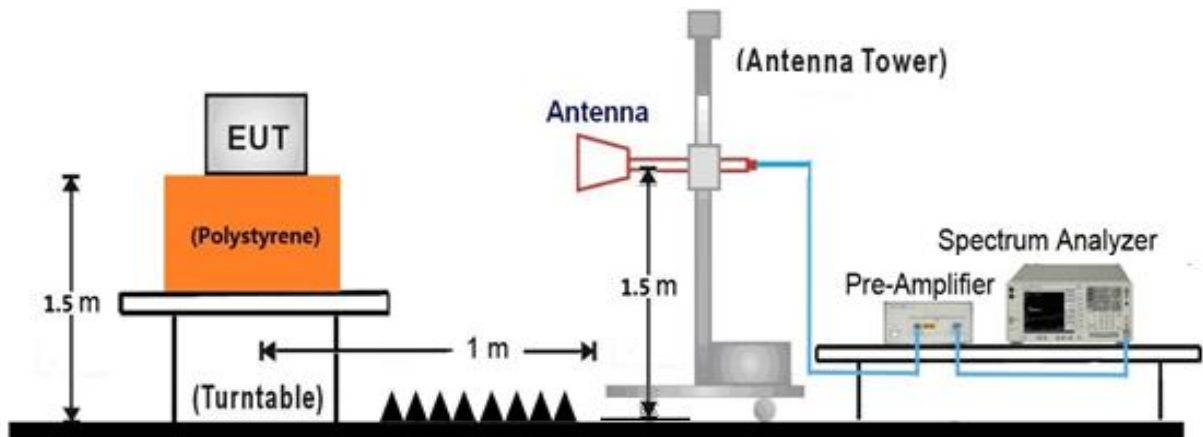

7.7.5. Test Result

EUT	Wi-Fi Φ3.9mm 2ways borescope	Date of Test	2023-12-29
Factor	BBHA 9120D	Temp. / Humidity	24°C /64%
Polarity	Horizontal	Site / Test Engineer	AC1 / Todd
Test Mode	802.11b_TX_CH 1_ANT 0	Test Voltage	AC 120V/60Hz

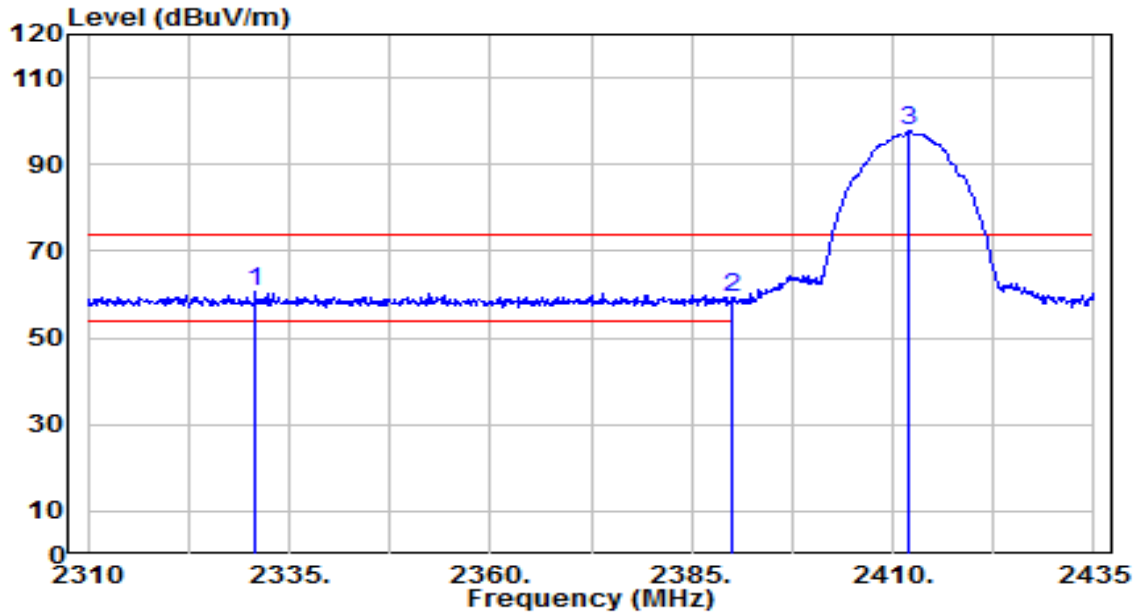

No	Frequency (MHz)	Reading (dBuV)	C.F (dB/m)	Measurement (dBuV/m)	Margin (dB)	Limit (dBuV/m)	Height (cm)	Angle (deg)	Remark (QP/PK/AV)
1	* 2330.875	29.02	31.66	60.68	-13.32	74.00	130	40	Peak
2	2390.000	27.43	31.87	59.30	-14.70	74.00	130	40	Peak
3	2412.000	66.02	31.95	97.97	N/A	N/A	130	40	Peak

Note:

1. " *", means this data is the worst emission level.
2. C.F (Correction Factor) = Antenna Factor (dB/m)+ Cable Loss (dB).
3. Measurement (dBuV/m) = Reading(dBuV) + C.F (Correction Factor).
4. The emission levels of other frequencies are very lower than the limit and not show in test report.

EUT	Wi-Fi Φ3.9mm 2ways borescope	Date of Test	2023-12-29
Factor	BBHA 9120D	Temp. / Humidity	24°C /64%
Polarity	Horizontal	Site / Test Engineer	AC1 / Todd
Test Mode	802.11b_TX_CH 1_ANT 0	Test Voltage	AC 120V/60Hz

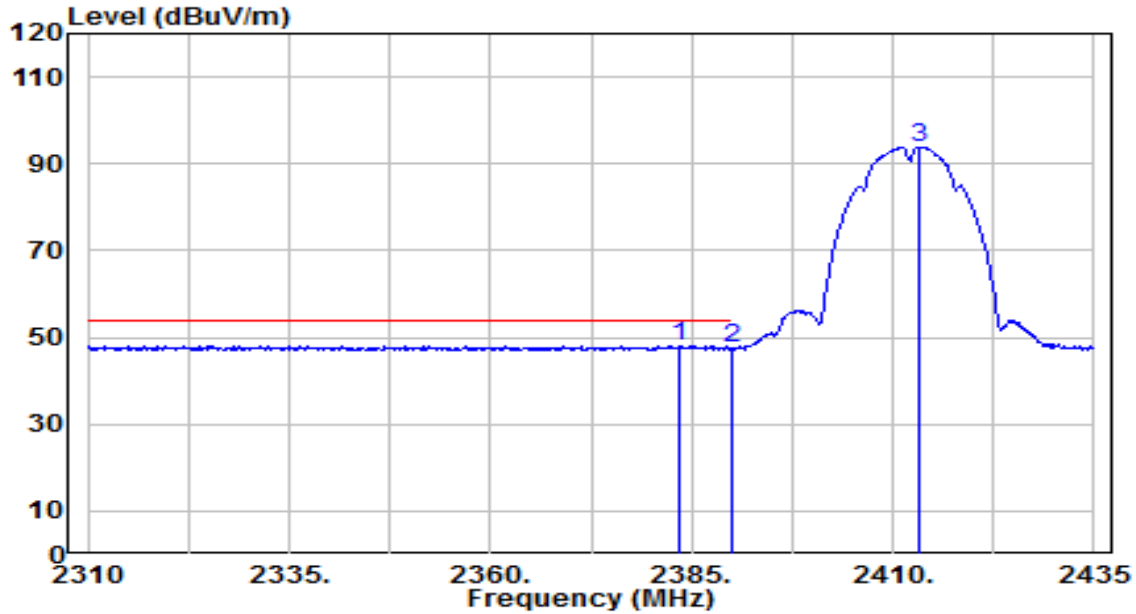

No	Frequency (MHz)	Reading (dBUV)	C.F (dB/m)	Measurement (dBUV/m)	Margin (dB)	Limit (dBUV/m)	Height (cm)	Angle (deg)	Remark (QP/PK/AV)	
1	*	2383.625	16.23	31.85	48.07	-5.93	54.00	130	40	Average
2		2390.000	15.78	31.87	47.65	-6.35	54.00	130	40	Average
3		2413.250	61.91	31.95	93.87	N/A	N/A	130	40	Average

Note:

1. " *", means this data is the worst emission level.
2. C.F (Correction Factor) = Antenna Factor (dB/m)+ Cable Loss (dB).
3. Measurement (dBUV/m) = Reading(dBUV) + C.F (Correction Factor).
4. The emission levels of other frequencies are very lower than the limit and not show in test report.

EUT	Wi-Fi Φ3.9mm 2ways borescope	Date of Test	2023-12-29
Factor	BBHA 9120D	Temp. / Humidity	24°C /64%
Polarity	Vertical	Site / Test Engineer	AC1 / Todd
Test Mode	802.11b_TX_CH 1_ANT 0	Test Voltage	AC 120V/60Hz

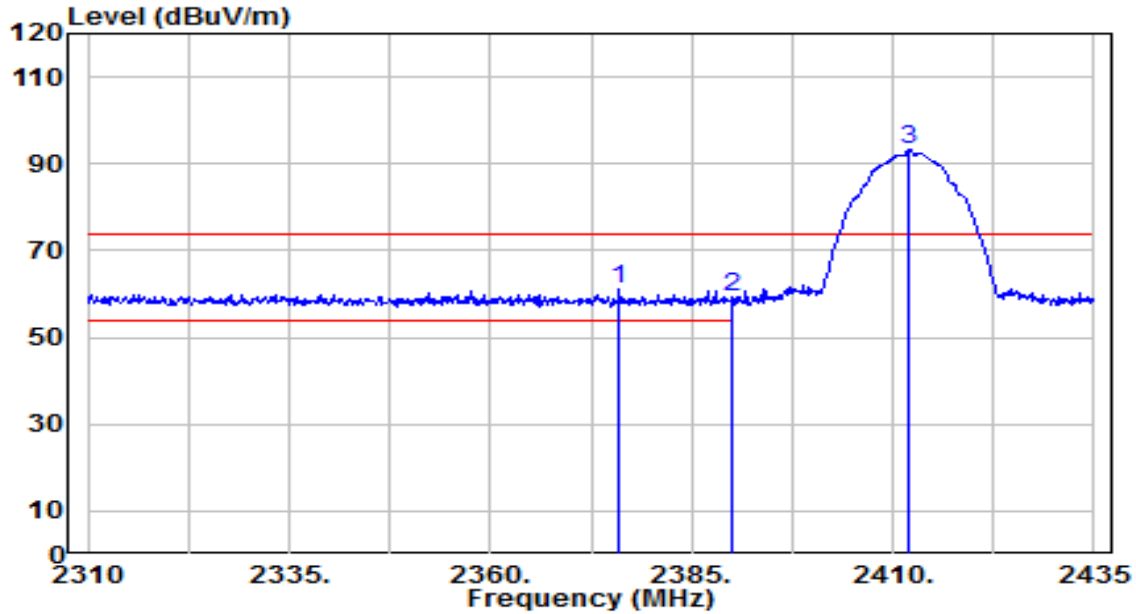

No	Frequency (MHz)	Reading (dBuV)	C.F (dB/m)	Measurement (dBuV/m)	Margin (dB)	Limit (dBuV/m)	Height (cm)	Angle (deg)	Remark (QP/PK/AV)
1	* 2376.000	29.20	31.82	61.02	-12.98	74.00	150	205	Peak
2	2390.000	27.49	31.87	59.36	-14.64	74.00	150	205	Peak
3	2412.000	61.22	31.95	93.17	N/A	N/A	150	205	Peak

Note:

1. " *", means this data is the worst emission level.
2. C.F (Correction Factor) = Antenna Factor (dB/m)+ Cable Loss (dB).
3. Measurement (dBuV/m) = Reading(dBuV) + C.F (Correction Factor).
4. The emission levels of other frequencies are very lower than the limit and not show in test report.

EUT	Wi-Fi Φ3.9mm 2ways borescope	Date of Test	2023-12-29
Factor	BBHA 9120D	Temp. / Humidity	24°C /64%
Polarity	Vertical	Site / Test Engineer	AC1 / Todd
Test Mode	802.11b_TX_CH 1_ANT 0	Test Voltage	AC 120V/60Hz

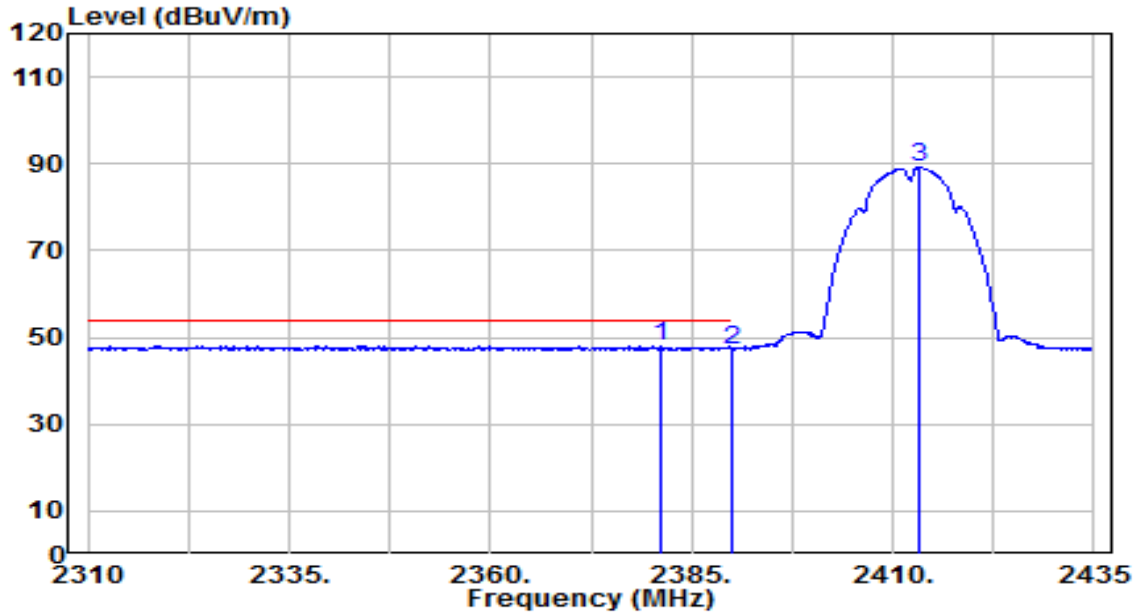

No	Frequency (MHz)	Reading (dBUV)	C.F (dB/m)	Measurement (dBUV/m)	Margin (dB)	Limit (dBUV/m)	Height (cm)	Angle (deg)	Remark (QP/PK/AV)
1	* 2381.250	16.17	31.84	48.01	-5.99	54.00	150	205	Average
2	2390.000	15.45	31.87	47.32	-6.68	54.00	150	205	Average
3	2413.375	57.18	31.95	89.13	N/A	N/A	150	205	Average

Note:

1. " *", means this data is the worst emission level.
2. C.F (Correction Factor) = Antenna Factor (dB/m)+ Cable Loss (dB).
3. Measurement (dBUV/m) = Reading(dBUV) + C.F (Correction Factor).
4. The emission levels of other frequencies are very lower than the limit and not show in test report.

EUT	Wi-Fi Φ3.9mm 2ways borescope	Date of Test	2023-12-29
Factor	BBHA 9120D	Temp. / Humidity	24°C /64%
Polarity	Horizontal	Site / Test Engineer	AC1 / Todd
Test Mode	802.11b_TX_CH 11_ANT 0	Test Voltage	AC 120V/60Hz

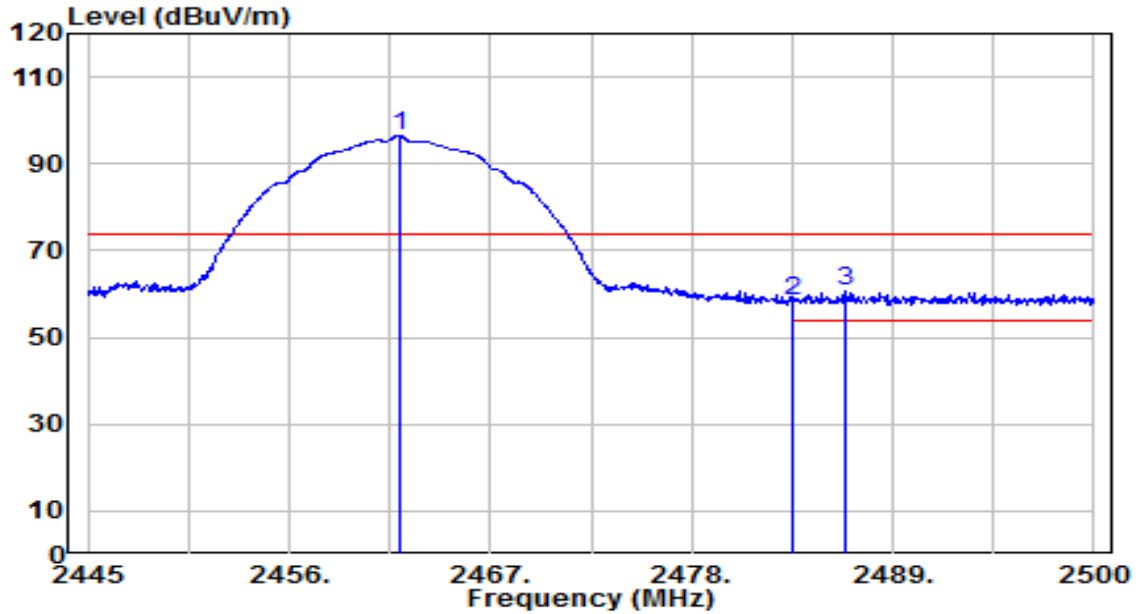

No	Frequency (MHz)	Reading (dBUV)	C.F (dB/m)	Measurement (dBUV/m)	Margin (dB)	Limit (dBUV/m)	Height (cm)	Angle (deg)	Remark (QP/PK/AV)
1	2461.995	64.42	32.13	96.55	N/A	N/A	145	35	Peak
2	2483.500	26.35	32.20	58.55	-15.45	74.00	145	35	Peak
3	* 2486.360	28.45	32.21	60.66	-13.34	74.00	145	35	Peak

Note:

1. " *", means this data is the worst emission level.
2. C.F (Correction Factor) = Antenna Factor (dB/m)+ Cable Loss (dB).
3. Measurement (dBUV/m) = Reading(dBUV) + C.F (Correction Factor).
4. The emission levels of other frequencies are very lower than the limit and not show in test report.

EUT	Wi-Fi Φ3.9mm 2ways borescope	Date of Test	2023-12-29
Factor	BBHA 9120D	Temp. / Humidity	24°C /64%
Polarity	Horizontal	Site / Test Engineer	AC1 / Todd
Test Mode	802.11b_TX_CH 11_ANT 0	Test Voltage	AC 120V/60Hz

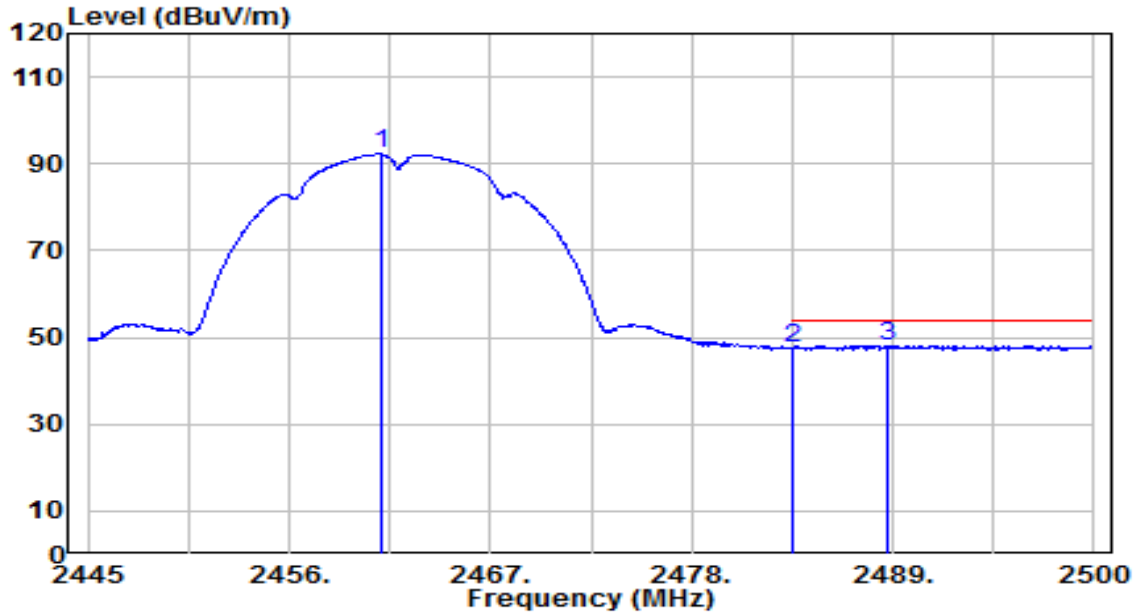

No	Frequency (MHz)	Reading (dBUV)	C.F (dB/m)	Measurement (dBUV/m)	Margin (dB)	Limit (dBUV/m)	Height (cm)	Angle (deg)	Remark (QP/PK/AV)
1	2461.005	60.13	32.12	92.26	N/A	N/A	145	35	Average
2	2483.500	15.20	32.20	47.40	-6.60	54.00	145	35	Average
3	* 2488.780	15.96	32.22	48.18	-5.82	54.00	145	35	Average

Note:

1. " *", means this data is the worst emission level.
2. C.F (Correction Factor) = Antenna Factor (dB/m)+ Cable Loss (dB).
3. Measurement (dBUV/m) = Reading(dBUV) + C.F (Correction Factor).
4. The emission levels of other frequencies are very lower than the limit and not show in test report.

EUT	Wi-Fi Ø3.9mm 2ways borescope	Date of Test	2023-12-29
Factor	BBHA 9120D	Temp. / Humidity	24°C /64%
Polarity	Vertical	Site / Test Engineer	AC1 / Todd
Test Mode	802.11b_TX_CH 11_ANT 0	Test Voltage	AC 120V/60Hz

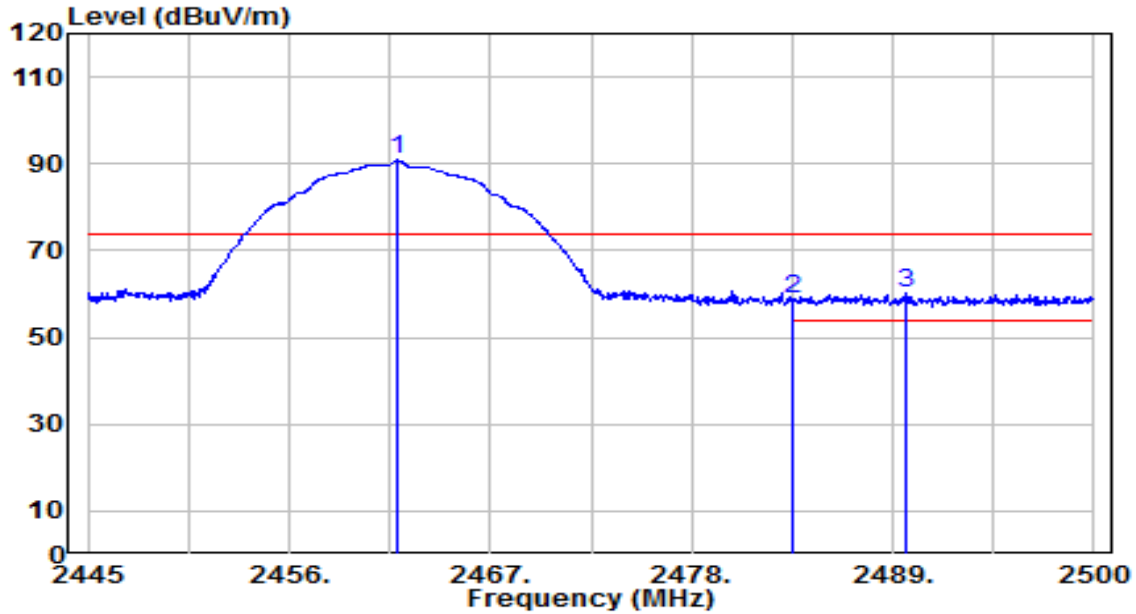

No	Frequency (MHz)	Reading (dBUV)	C.F (dB/m)	Measurement (dBUV/m)	Margin (dB)	Limit (dBUV/m)	Height (cm)	Angle (deg)	Remark (QP/PK/AV)
1	2461.940	58.68	32.13	90.80	N/A	N/A	155	210	Peak
2	2483.500	26.52	32.20	58.72	-15.28	74.00	155	210	Peak
3	* 2489.660	27.80	32.22	60.02	-13.98	74.00	155	210	Peak

Note:

1. " *", means this data is the worst emission level.
2. C.F (Correction Factor) = Antenna Factor (dB/m)+ Cable Loss (dB).
3. Measurement (dBUV/m) = Reading(dBUV) + C.F (Correction Factor).
4. The emission levels of other frequencies are very lower than the limit and not show in test report.

EUT	Wi-Fi Φ3.9mm 2ways borescope	Date of Test	2023-12-29
Factor	BBHA 9120D	Temp. / Humidity	24°C /64%
Polarity	Vertical	Site / Test Engineer	AC1 / Todd
Test Mode	802.11b_TX_CH 11_ANT 0	Test Voltage	AC 120V/60Hz

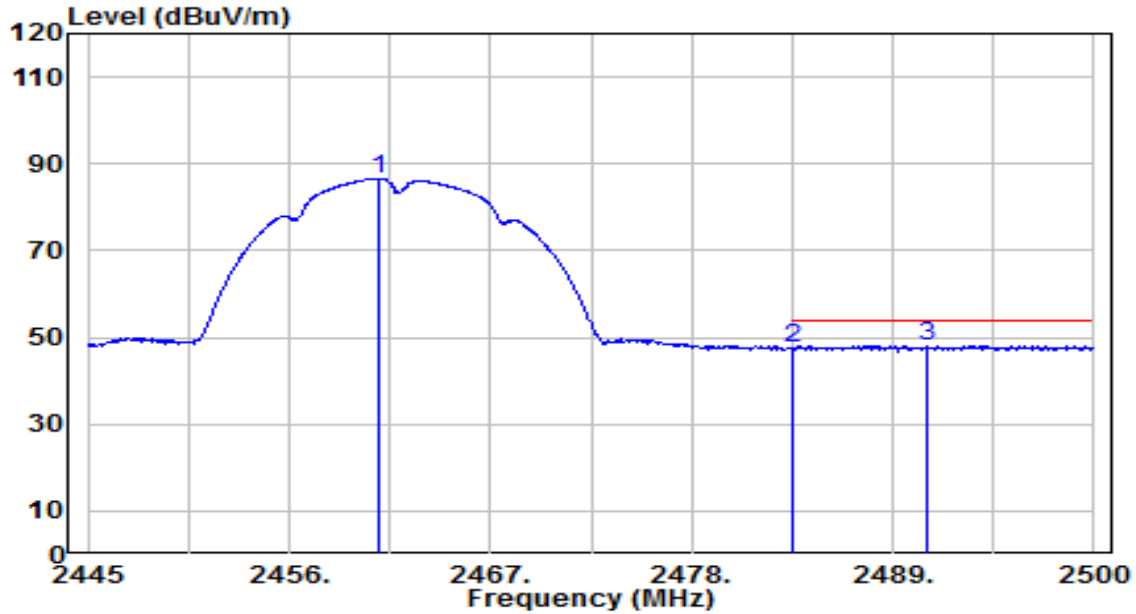

No	Frequency (MHz)	Reading (dBuV)	C.F (dB/m)	Measurement (dBuV/m)	Margin (dB)	Limit (dBuV/m)	Height (cm)	Angle (deg)	Remark (QP/PK/AV)
1	2460.840	54.51	32.12	86.63	N/A	N/A	155	210	Average
2	2483.500	15.43	32.20	47.64	-6.36	54.00	155	210	Average
3	* 2490.870	15.80	32.23	48.02	-5.98	54.00	155	210	Average

Note:

1. " *", means this data is the worst emission level.
2. C.F (Correction Factor) = Antenna Factor (dB/m)+ Cable Loss (dB).
3. Measurement (dBuV/m) = Reading(dBuV) + C.F (Correction Factor).
4. The emission levels of other frequencies are very lower than the limit and not show in test report.

EUT	Wi-Fi Φ3.9mm 2ways borescope	Date of Test	2023-12-29
Factor	BBHA 9120D	Temp. / Humidity	24°C /64%
Polarity	Horizontal	Site / Test Engineer	AC1 / Todd
Test Mode	802.11g_TX_CH 1_ANT 0	Test Voltage	AC 120V/60Hz

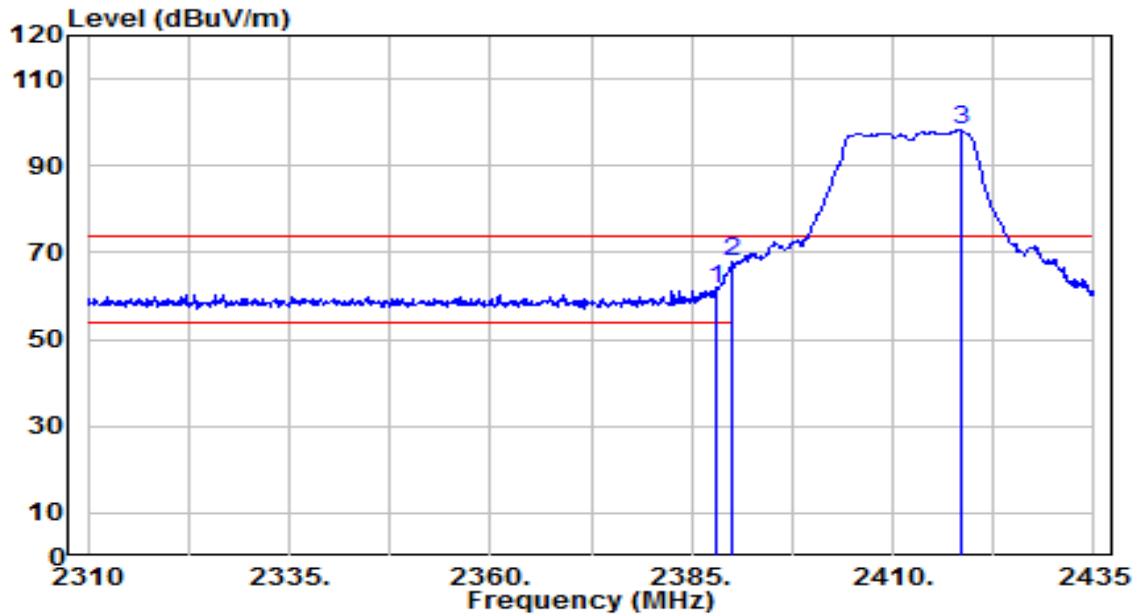

No	Frequency (MHz)	Reading (dBUV)	C.F (dB/m)	Measurement (dBUV/m)	Margin (dB)	Limit (dBUV/m)	Height (cm)	Angle (deg)	Remark (QP/PK/AV)
1	2388.000	29.73	31.86	61.60	-12.40	74.00	130	40	Peak
2	* 2390.000	36.00	31.87	67.87	-6.13	74.00	130	40	Peak
3	2418.375	66.28	31.97	98.25	N/A	N/A	130	40	Peak

Note:

- "*", means this data is the worst emission level.
- C.F (Correction Factor) = Antenna Factor (dB/m)+ Cable Loss (dB).
- Measurement (dBUV/m) = Reading(dBUV) + C.F (Correction Factor).
- The emission levels of other frequencies are very lower than the limit and not show in test report.

EUT	Wi-Fi Φ3.9mm 2ways borescope	Date of Test	2023-12-29
Factor	BBHA 9120D	Temp. / Humidity	24°C /64%
Polarity	Horizontal	Site / Test Engineer	AC1 / Todd
Test Mode	802.11g_TX_CH 1_ANT 0	Test Voltage	AC 120V/60Hz

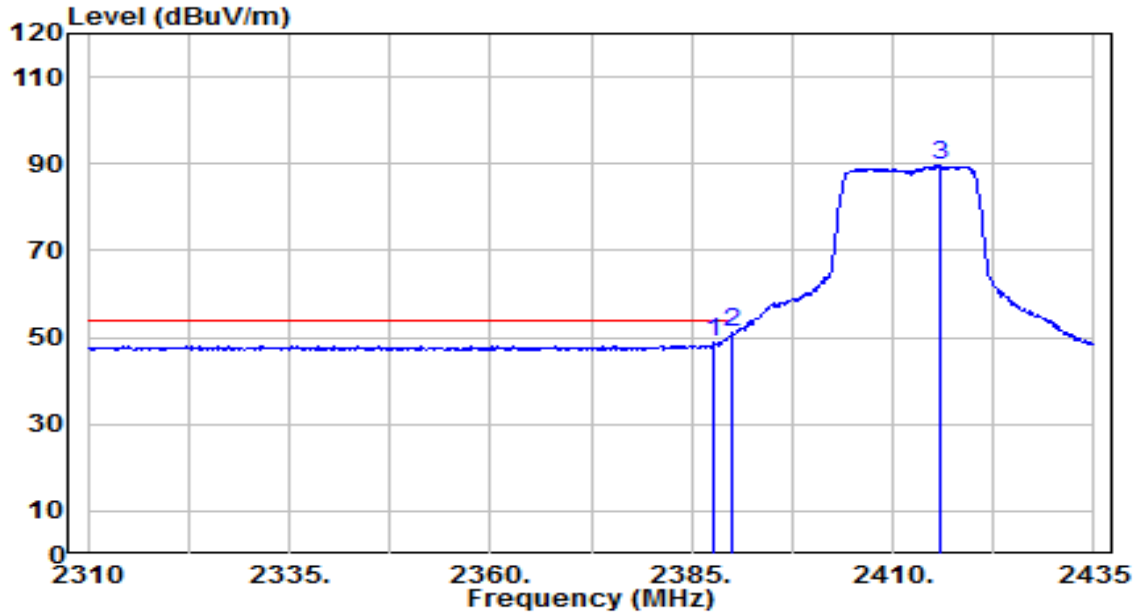

No	Frequency (MHz)	Reading (dBuV)	C.F (dB/m)	Measurement (dBuV/m)	Margin (dB)	Limit (dBuV/m)	Height (cm)	Angle (deg)	Remark (QP/PK/AV)
1	2387.875	16.84	31.86	48.70	-5.30	54.00	130	40	Average
2	* 2390.000	19.08	31.87	50.95	-3.05	54.00	130	40	Average
3	2416.000	57.49	31.96	89.45	N/A	N/A	130	40	Average

Note:

- "*", means this data is the worst emission level.
- C.F (Correction Factor) = Antenna Factor (dB/m)+ Cable Loss (dB).
- Measurement (dBuV/m) = Reading(dBuV) + C.F (Correction Factor).
- The emission levels of other frequencies are very lower than the limit and not show in test report.

EUT	Wi-Fi Φ3.9mm 2ways borescope	Date of Test	2023-12-29
Factor	BBHA 9120D	Temp. / Humidity	24°C /64%
Polarity	Vertical	Site / Test Engineer	AC1 / Todd
Test Mode	802.11g_TX_CH 1_ANT 0	Test Voltage	AC 120V/60Hz

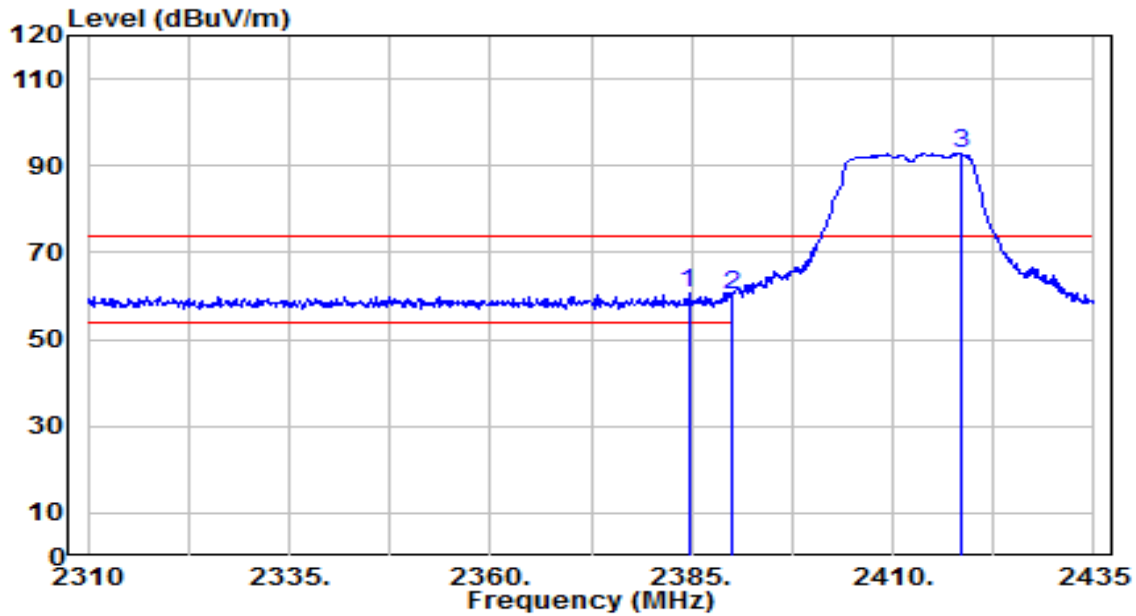

No	Frequency (MHz)	Reading (dBuV)	C.F (dB/m)	Measurement (dBuV/m)	Margin (dB)	Limit (dBuV/m)	Height (cm)	Angle (deg)	Remark (QP/PK/AV)
1	* 2384.625	28.63	31.85	60.48	-13.52	74.00	150	205	Peak
2	2390.000	28.33	31.87	60.20	-13.80	74.00	150	205	Peak
3	2418.375	60.94	31.97	92.91	N/A	N/A	150	205	Peak

Note:

- "*", means this data is the worst emission level.
- C.F (Correction Factor) = Antenna Factor (dB/m)+ Cable Loss (dB).
- Measurement (dBuV/m) = Reading(dBuV) + C.F (Correction Factor).
- The emission levels of other frequencies are very lower than the limit and not show in test report.

EUT	Wi-Fi Φ3.9mm 2ways borescope	Date of Test	2023-12-29
Factor	BBHA 9120D	Temp. / Humidity	24°C /64%
Polarity	Vertical	Site / Test Engineer	AC1 / Todd
Test Mode	802.11g_TX_CH 1_ANT 0	Test Voltage	AC 120V/60Hz

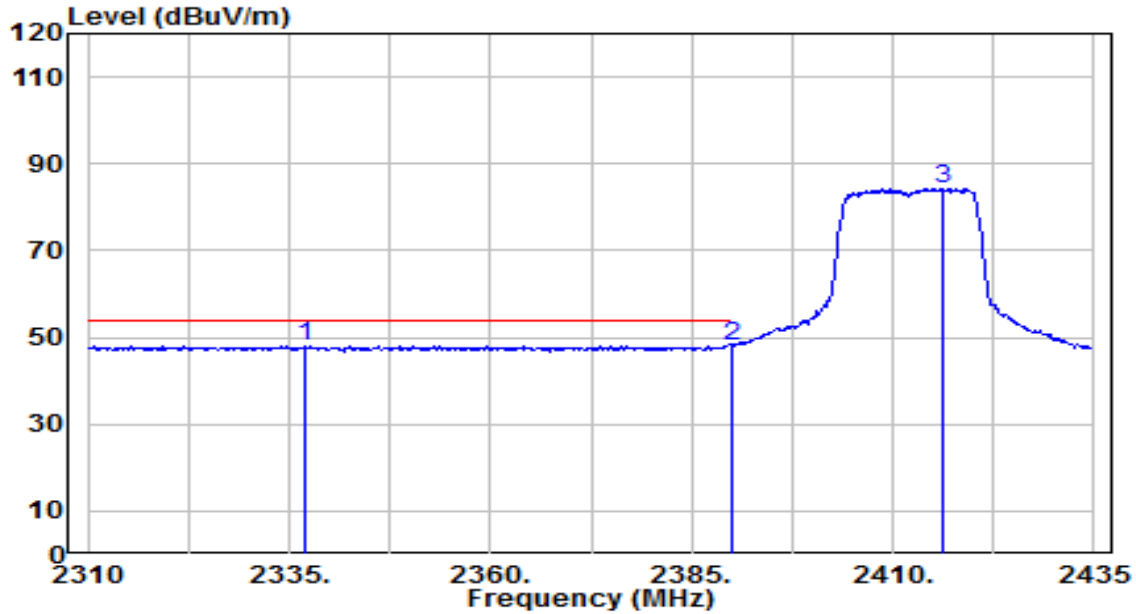

No	Frequency (MHz)	Reading (dBUV)	C.F (dB/m)	Measurement (dBUV/m)	Margin (dB)	Limit (dBUV/m)	Height (cm)	Angle (deg)	Remark (QP/PK/AV)
1	2337.125	16.29	31.68	47.98	-6.02	54.00	150	205	Average
2	* 2390.000	16.17	31.87	48.04	-5.96	54.00	150	205	Average
3	2416.250	52.39	31.96	84.35	N/A	N/A	150	205	Average

Note:

- "*", means this data is the worst emission level.
- C.F (Correction Factor) = Antenna Factor (dB/m)+ Cable Loss (dB).
- Measurement (dBUV/m) = Reading(dBUV) + C.F (Correction Factor).
- The emission levels of other frequencies are very lower than the limit and not show in test report.

EUT	Wi-Fi Φ3.9mm 2ways borescope	Date of Test	2023-12-29
Factor	BBHA 9120D	Temp. / Humidity	24°C /64%
Polarity	Horizontal	Site / Test Engineer	AC1 / Todd
Test Mode	802.11g_TX_CH 11_ANT 0	Test Voltage	AC 120V/60Hz

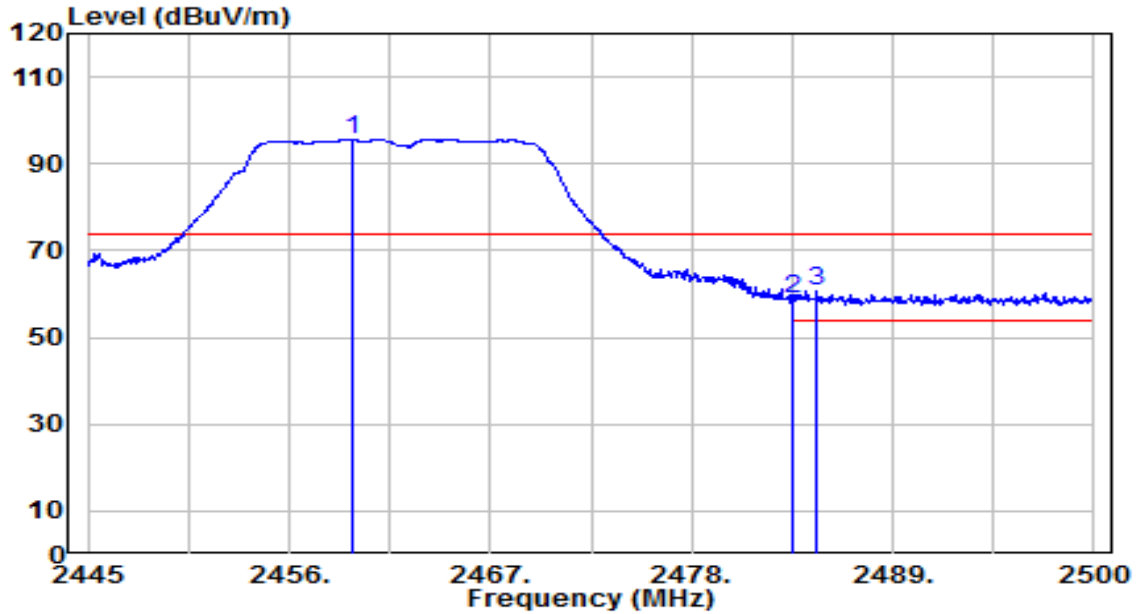

No	Frequency (MHz)	Reading (dBuV)	C.F (dB/m)	Measurement (dBuV/m)	Margin (dB)	Limit (dBuV/m)	Height (cm)	Angle (deg)	Remark (QP/PK/AV)
1	2459.410	63.45	32.12	95.57	N/A	N/A	145	35	Peak
2	2483.500	26.57	32.20	58.77	-15.23	74.00	145	35	Peak
3	* 2484.820	28.33	32.21	60.54	-13.46	74.00	145	35	Peak

Note:

1. " *", means this data is the worst emission level.
2. C.F (Correction Factor) = Antenna Factor (dB/m)+ Cable Loss (dB).
3. Measurement (dBuV/m) = Reading(dBuV) + C.F (Correction Factor).
4. The emission levels of other frequencies are very lower than the limit and not show in test report.

EUT	Wi-Fi Φ3.9mm 2ways borescope	Date of Test	2023-12-29
Factor	BBHA 9120D	Temp. / Humidity	24°C /64%
Polarity	Horizontal	Site / Test Engineer	AC1 / Todd
Test Mode	802.11g_TX_CH 11_ANT 0	Test Voltage	AC 120V/60Hz

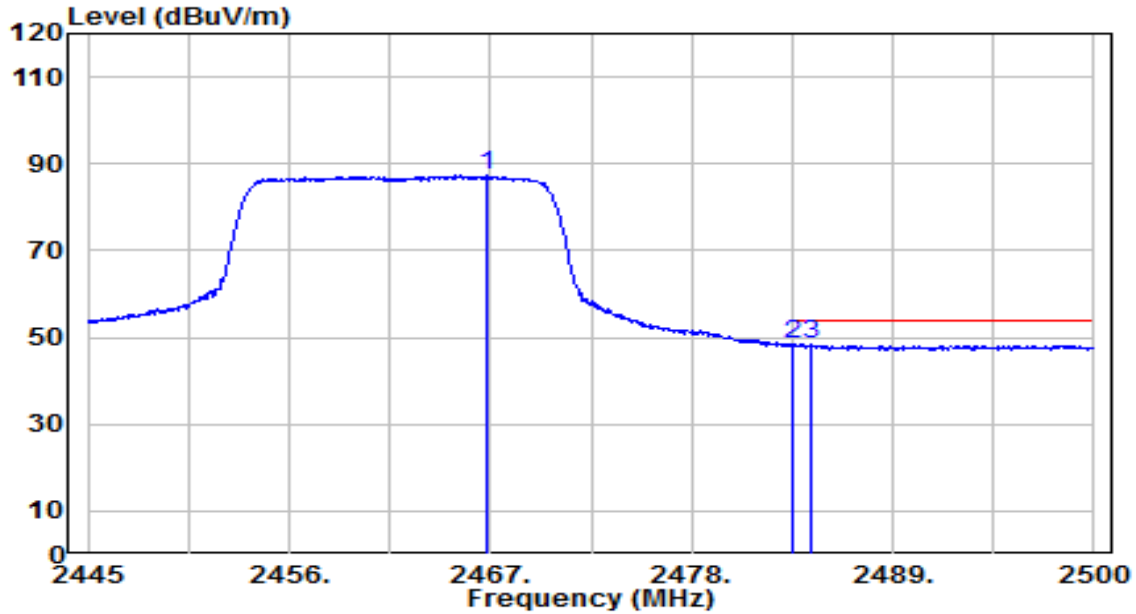

No	Frequency (MHz)	Reading (dBUV)	C.F (dB/m)	Measurement (dBUV/m)	Margin (dB)	Limit (dBUV/m)	Height (cm)	Angle (deg)	Remark (QP/PK/AV)
1	2466.780	55.13	32.14	87.27	N/A	N/A	145	35	Average
2	* 2483.500	16.26	32.20	48.46	-5.54	54.00	145	35	Average
3	2484.490	16.17	32.21	48.38	-5.62	54.00	145	35	Average

Note:

- "*", means this data is the worst emission level.
- C.F (Correction Factor) = Antenna Factor (dB/m)+ Cable Loss (dB).
- Measurement (dBUV/m) = Reading(dBUV) + C.F (Correction Factor).
- The emission levels of other frequencies are very lower than the limit and not show in test report.

EUT	Wi-Fi Φ3.9mm 2ways borescope	Date of Test	2023-12-29
Factor	BBHA 9120D	Temp. / Humidity	24°C /64%
Polarity	Vertical	Site / Test Engineer	AC1 / Todd
Test Mode	802.11g_TX_CH 11_ANT 0	Test Voltage	AC 120V/60Hz

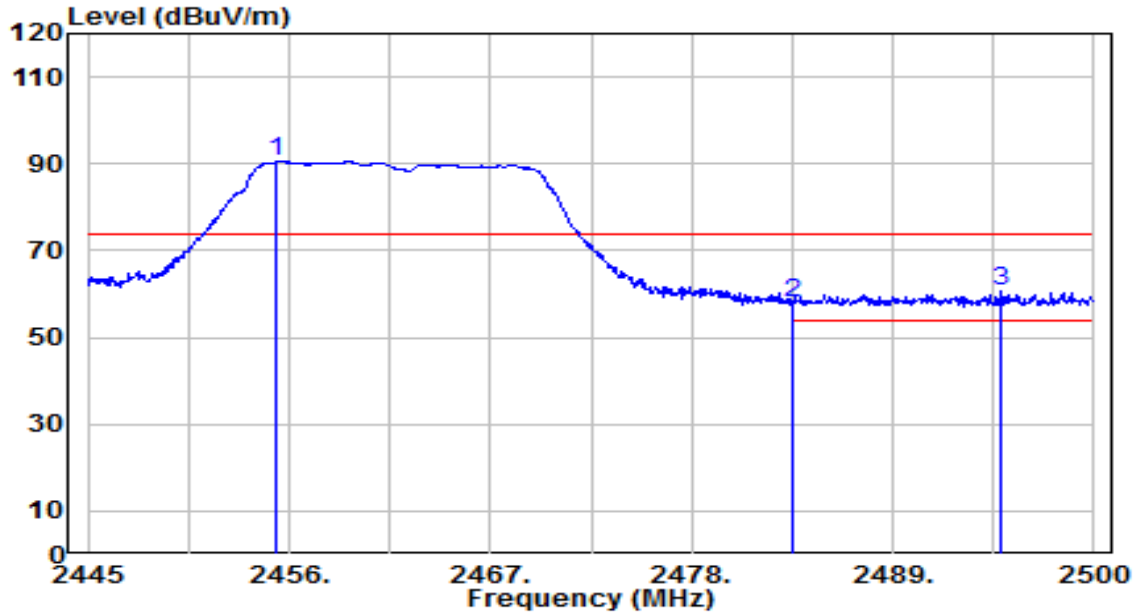

No	Frequency (MHz)	Reading (dBUV)	C.F (dB/m)	Measurement (dBUV/m)	Margin (dB)	Limit (dBUV/m)	Height (cm)	Angle (deg)	Remark (QP/PK/AV)
1	2455.340	58.38	32.10	90.49	N/A	N/A	155	210	Peak
2	2483.500	25.94	32.20	58.14	-15.86	74.00	155	210	Peak
3	* 2494.940	28.51	32.24	60.75	-13.25	74.00	155	210	Peak

Note:

- "*", means this data is the worst emission level.
- C.F (Correction Factor) = Antenna Factor (dB/m)+ Cable Loss (dB).
- Measurement (dBUV/m) = Reading(dBUV) + C.F (Correction Factor).
- The emission levels of other frequencies are very lower than the limit and not show in test report.

EUT	Wi-Fi Φ3.9mm 2ways borescope	Date of Test	2023-12-29
Factor	BBHA 9120D	Temp. / Humidity	24°C /64%
Polarity	Vertical	Site / Test Engineer	AC1 / Todd
Test Mode	802.11g_TX_CH 11_ANT 0	Test Voltage	AC 120V/60Hz

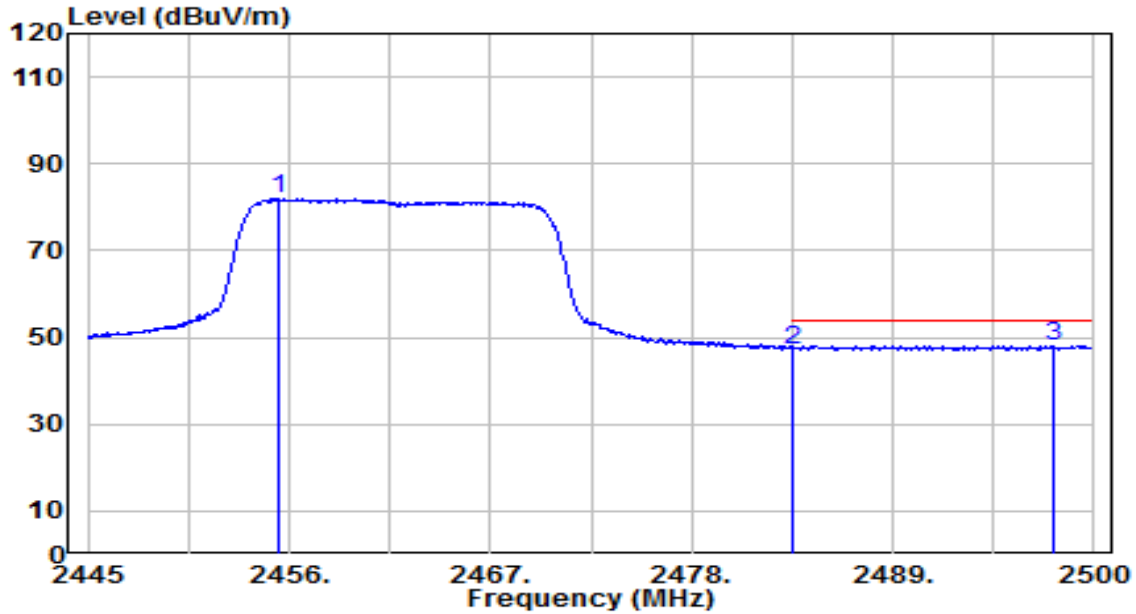

No	Frequency (MHz)	Reading (dBUV)	C.F (dB/m)	Measurement (dBUV/m)	Margin (dB)	Limit (dBUV/m)	Height (cm)	Angle (deg)	Remark (QP/PK/AV)
1	2455.450	49.85	32.10	81.95	N/A	N/A	155	210	Average
2	2483.500	14.96	32.20	47.17	-6.83	54.00	155	210	Average
3	* 2497.855	15.79	32.25	48.04	-5.96	54.00	155	210	Average

Note:

1. " *", means this data is the worst emission level.
2. C.F (Correction Factor) = Antenna Factor (dB/m)+ Cable Loss (dB).
3. Measurement (dBUV/m) = Reading(dBUV) + C.F (Correction Factor).
4. The emission levels of other frequencies are very lower than the limit and not show in test report.

EUT	Wi-Fi Φ3.9mm 2ways borescope	Date of Test	2023-12-29
Factor	BBHA 9120D	Temp. / Humidity	24°C /64%
Polarity	Horizontal	Site / Test Engineer	AC1 / Todd
Test Mode	802.11n-20MHz_TX_CH 1_ANT 0	Test Voltage	AC 120V/60Hz

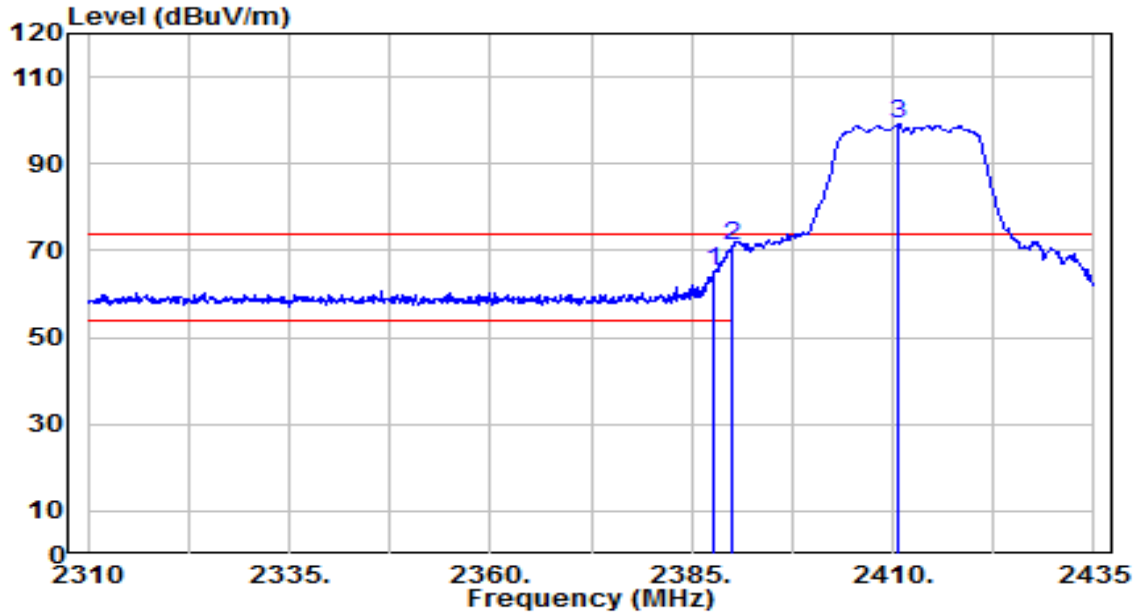

No	Frequency (MHz)	Reading (dBuV)	C.F (dB/m)	Measurement (dBuV/m)	Margin (dB)	Limit (dBuV/m)	Height (cm)	Angle (deg)	Remark (QP/PK/AV)
1	2387.750	33.43	31.86	65.29	-8.71	74.00	130	40	Peak
2	* 2390.000	39.44	31.87	71.31	-2.69	74.00	130	40	Peak
3	2410.625	67.38	31.94	99.33	N/A	N/A	130	40	Peak

Note:

- "*", means this data is the worst emission level.
- C.F (Correction Factor) = Antenna Factor (dB/m)+ Cable Loss (dB).
- Measurement (dBuV/m) = Reading(dBuV) + C.F (Correction Factor).
- The emission levels of other frequencies are very lower than the limit and not show in test report.

EUT	Wi-Fi Φ3.9mm 2ways borescope	Date of Test	2023-12-29
Factor	BBHA 9120D	Temp. / Humidity	24°C /64%
Polarity	Horizontal	Site / Test Engineer	AC1 / Todd
Test Mode	802.11n-20MHz_TX_CH 1_ANT 0	Test Voltage	AC 120V/60Hz

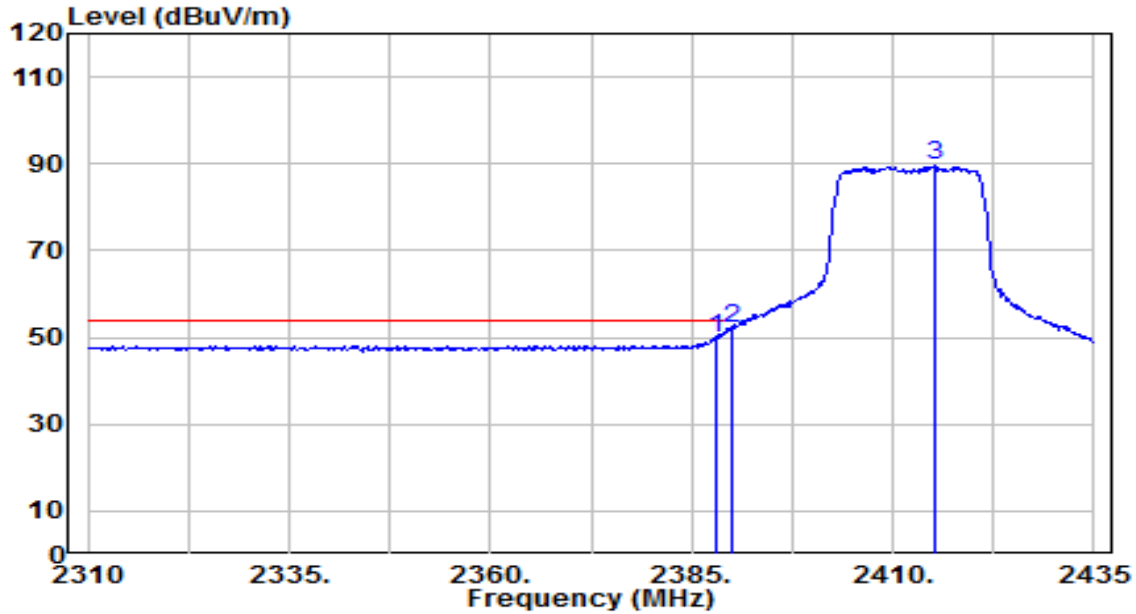

No	Frequency (MHz)	Reading (dBuV)	C.F (dB/m)	Measurement (dBuV/m)	Margin (dB)	Limit (dBuV/m)	Height (cm)	Angle (deg)	Remark (QP/PK/AV)
1	2388.000	17.92	31.86	49.79	-4.21	54.00	130	40	Average
2	* 2390.000	20.27	31.87	52.14	-1.86	54.00	130	40	Average
3	2415.250	57.67	31.96	89.63	N/A	N/A	130	40	Average

Note:

- "*", means this data is the worst emission level.
- C.F (Correction Factor) = Antenna Factor (dB/m)+ Cable Loss (dB).
- Measurement (dBuV/m) = Reading(dBuV) + C.F (Correction Factor).
- The emission levels of other frequencies are very lower than the limit and not show in test report.

EUT	Wi-Fi Φ3.9mm 2ways borescope	Date of Test	2023-12-29
Factor	BBHA 9120D	Temp. / Humidity	24°C /64%
Polarity	Vertical	Site / Test Engineer	AC1 / Todd
Test Mode	802.11n-20MHz_TX_CH 1_ANT 0	Test Voltage	AC 120V/60Hz

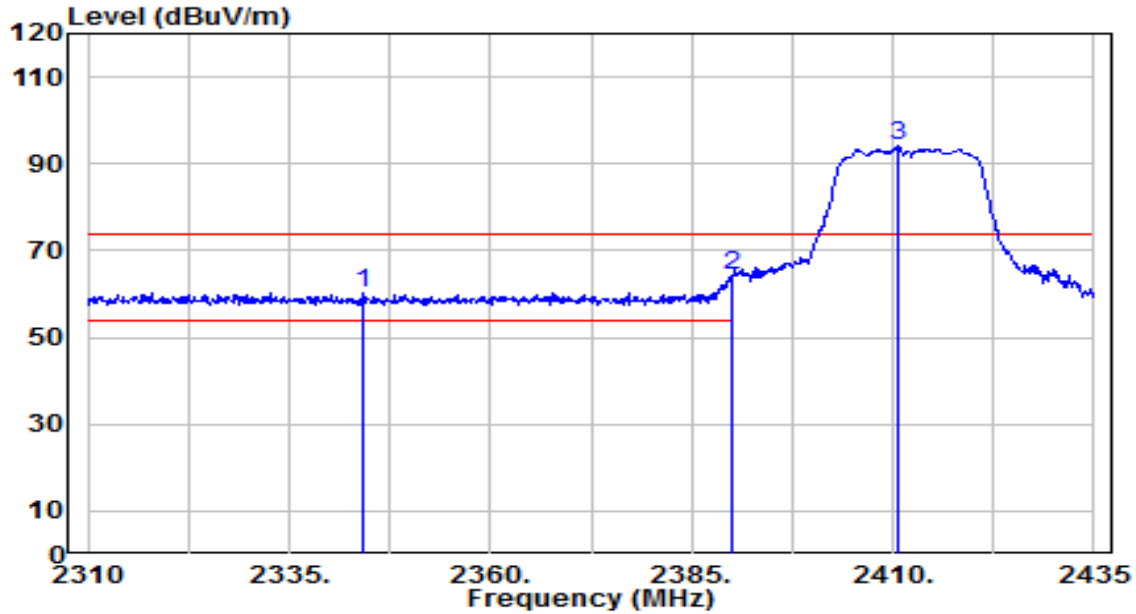

No	Frequency (MHz)	Reading (dBuV)	C.F (dB/m)	Measurement (dBuV/m)	Margin (dB)	Limit (dBuV/m)	Height (cm)	Angle (deg)	Remark (QP/PK/AV)
1	2344.250	28.49	31.71	60.20	-13.80	74.00	150	205	Peak
2	* 2390.000	32.43	31.87	64.30	-9.70	74.00	150	205	Peak
3	2410.625	62.20	31.94	94.15	N/A	N/A	150	205	Peak

Note:

- "*", means this data is the worst emission level.
- C.F (Correction Factor) = Antenna Factor (dB/m)+ Cable Loss (dB).
- Measurement (dBuV/m) = Reading(dBuV) + C.F (Correction Factor).
- The emission levels of other frequencies are very lower than the limit and not show in test report.

EUT	Wi-Fi Φ3.9mm 2ways borescope	Date of Test	2023-12-29
Factor	BBHA 9120D	Temp. / Humidity	24°C /64%
Polarity	Vertical	Site / Test Engineer	AC1 / Todd
Test Mode	802.11n-20MHz_TX_CH 1_ANT 0	Test Voltage	AC 120V/60Hz

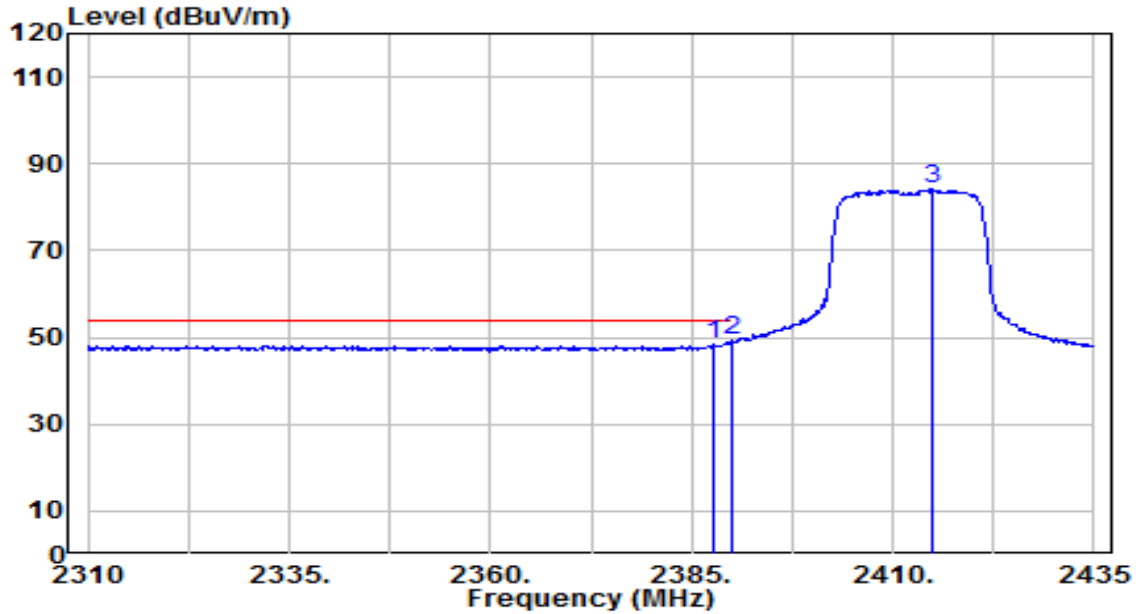

No	Frequency (MHz)	Reading (dBuV)	C.F (dB/m)	Measurement (dBuV/m)	Margin (dB)	Limit (dBuV/m)	Height (cm)	Angle (deg)	Remark (QP/PK/AV)
1	2387.875	16.48	31.86	48.35	-5.65	54.00	150	205	Average
2	* 2390.000	17.29	31.87	49.16	-4.84	54.00	150	205	Average
3	2415.000	52.20	31.96	84.15	N/A	N/A	150	205	Average

Note:

- "*", means this data is the worst emission level.
- C.F (Correction Factor) = Antenna Factor (dB/m)+ Cable Loss (dB).
- Measurement (dBuV/m) = Reading(dBuV) + C.F (Correction Factor).
- The emission levels of other frequencies are very lower than the limit and not show in test report.

EUT	Wi-Fi Φ3.9mm 2ways borescope	Date of Test	2023-12-29
Factor	BBHA 9120D	Temp. / Humidity	24°C /64%
Polarity	Horizontal	Site / Test Engineer	AC1 / Todd
Test Mode	802.11n-20MHz_TX_CH 11_ANT 0	Test Voltage	AC 120V/60Hz

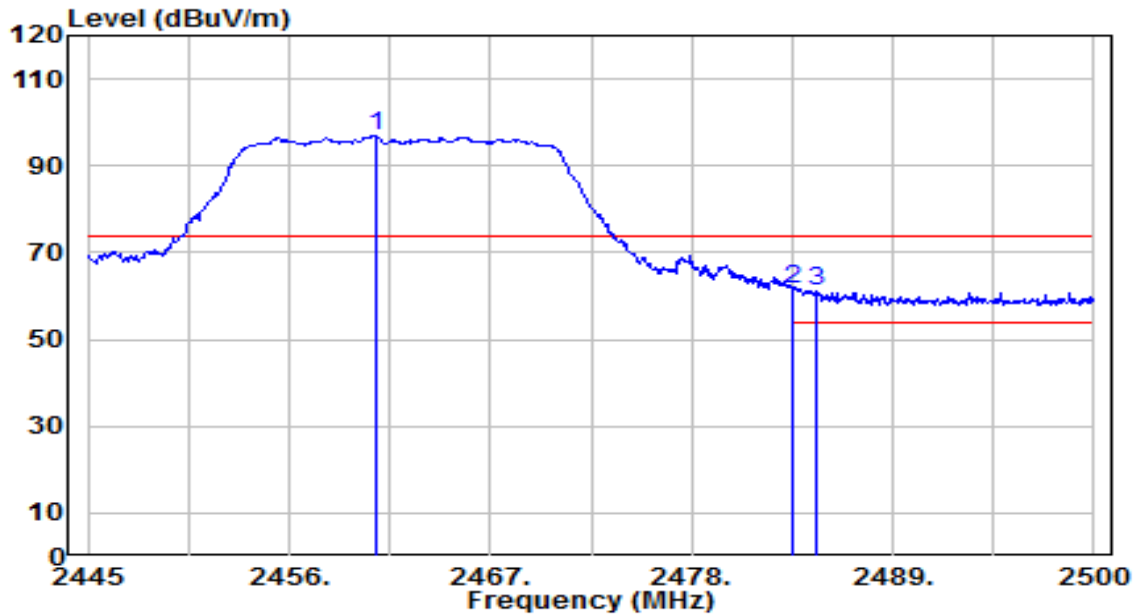

No	Frequency (MHz)	Reading (dBUV)	C.F (dB/m)	Measurement (dBUV/m)	Margin (dB)	Limit (dBUV/m)	Height (cm)	Angle (deg)	Remark (QP/PK/AV)
1	2460.730	64.73	32.12	96.85	N/A	N/A	145	35	Peak
2	* 2483.500	29.29	32.20	61.49	-12.51	74.00	145	35	Peak
3	2484.875	28.99	32.21	61.19	-12.81	74.00	145	35	Peak

Note:

- "*", means this data is the worst emission level.
- C.F (Correction Factor) = Antenna Factor (dB/m)+ Cable Loss (dB).
- Measurement (dBUV/m) = Reading(dBUV) + C.F (Correction Factor).
- The emission levels of other frequencies are very lower than the limit and not show in test report.

EUT	Wi-Fi Φ3.9mm 2ways borescope	Date of Test	2023-12-29
Factor	BBHA 9120D	Temp. / Humidity	24°C /64%
Polarity	Horizontal	Site / Test Engineer	AC1 / Todd
Test Mode	802.11n-20MHz_TX_CH 11_ANT 0	Test Voltage	AC 120V/60Hz

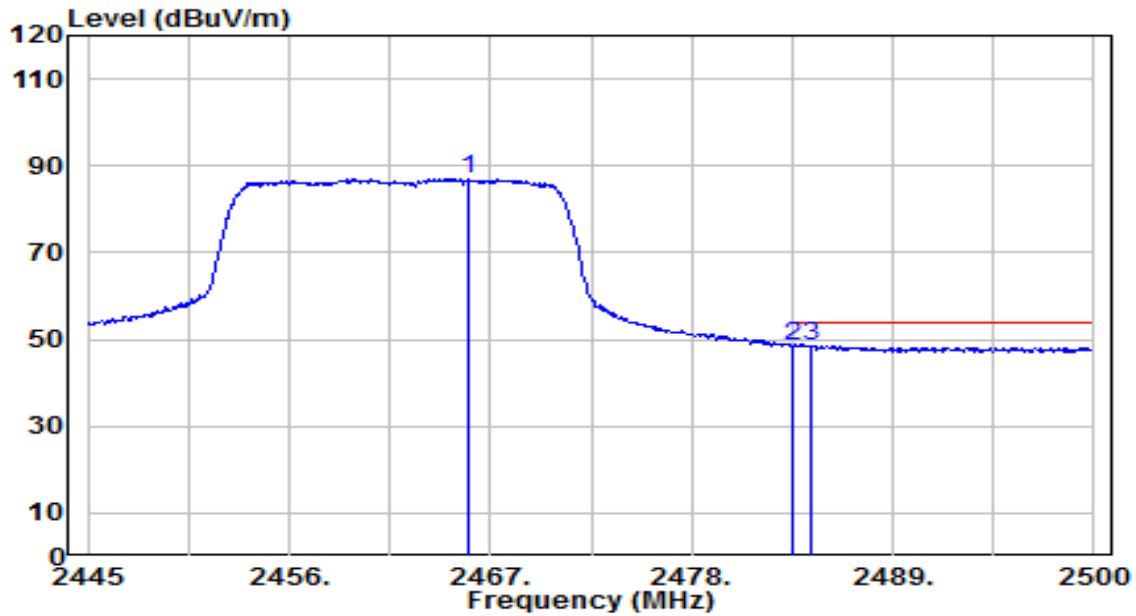

No	Frequency (MHz)	Reading (dBuV)	C.F (dB/m)	Measurement (dBuV/m)	Margin (dB)	Limit (dBuV/m)	Height (cm)	Angle (deg)	Remark (QP/PK/AV)
1	2465.790	54.87	32.14	87.01	N/A	N/A	145	35	Average
2	* 2483.500	16.28	32.20	48.48	-5.52	54.00	145	35	Average
3	2484.490	16.27	32.21	48.48	-5.52	54.00	145	35	Average

Note:

- "*", means this data is the worst emission level.
- C.F (Correction Factor) = Antenna Factor (dB/m)+ Cable Loss (dB).
- Measurement (dBuV/m) = Reading(dBuV) + C.F (Correction Factor).
- The emission levels of other frequencies are very lower than the limit and not show in test report.

EUT	Wi-Fi Φ3.9mm 2ways borescope	Date of Test	2023-12-29
Factor	BBHA 9120D	Temp. / Humidity	24°C /64%
Polarity	Vertical	Site / Test Engineer	AC1 / Todd
Test Mode	802.11n-20MHz_TX_CH 11_ANT 0	Test Voltage	AC 120V/60Hz

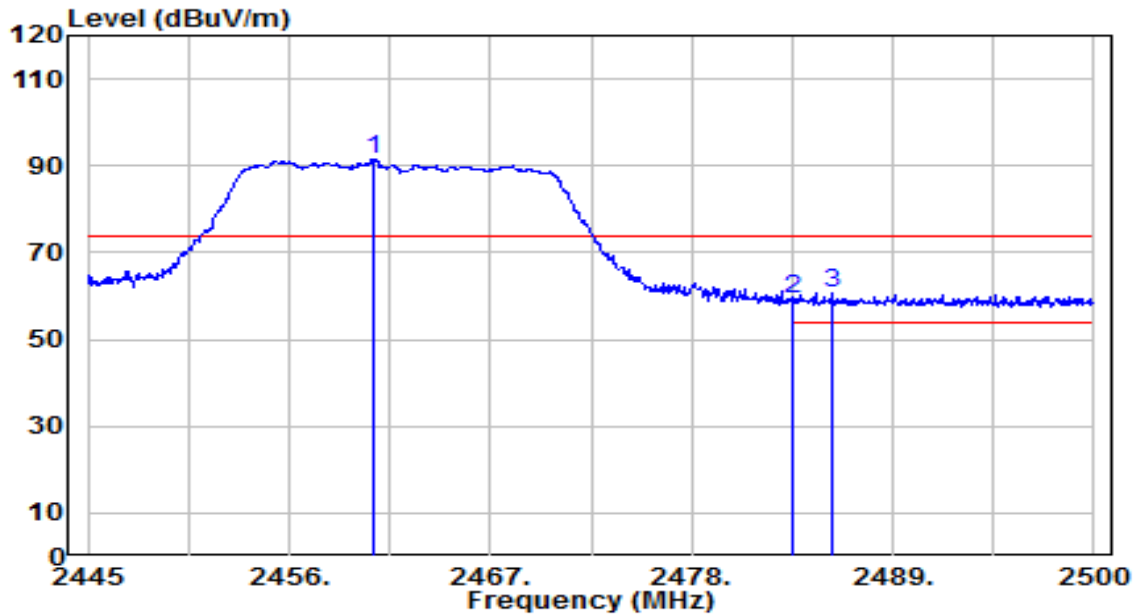

No	Frequency (MHz)	Reading (dBuV)	C.F (dB/m)	Measurement (dBuV/m)	Margin (dB)	Limit (dBuV/m)	Height (cm)	Angle (deg)	Remark (QP/PK/AV)
1	2460.565	59.45	32.12	91.57	N/A	N/A	155	210	Peak
2	2483.500	27.03	32.20	59.23	-14.77	74.00	155	210	Peak
3	* 2485.645	28.60	32.21	60.81	-13.19	74.00	155	210	Peak

Note:

- "*", means this data is the worst emission level.
- C.F (Correction Factor) = Antenna Factor (dB/m)+ Cable Loss (dB).
- Measurement (dBuV/m) = Reading(dBuV) + C.F (Correction Factor).
- The emission levels of other frequencies are very lower than the limit and not show in test report.

EUT	Wi-Fi Φ3.9mm 2ways borescope	Date of Test	2023-12-29
Factor	BBHA 9120D	Temp. / Humidity	24°C /64%
Polarity	Vertical	Site / Test Engineer	AC1 / Todd
Test Mode	802.11n-20MHz_TX_CH 11_ANT 0	Test Voltage	AC 120V/60Hz

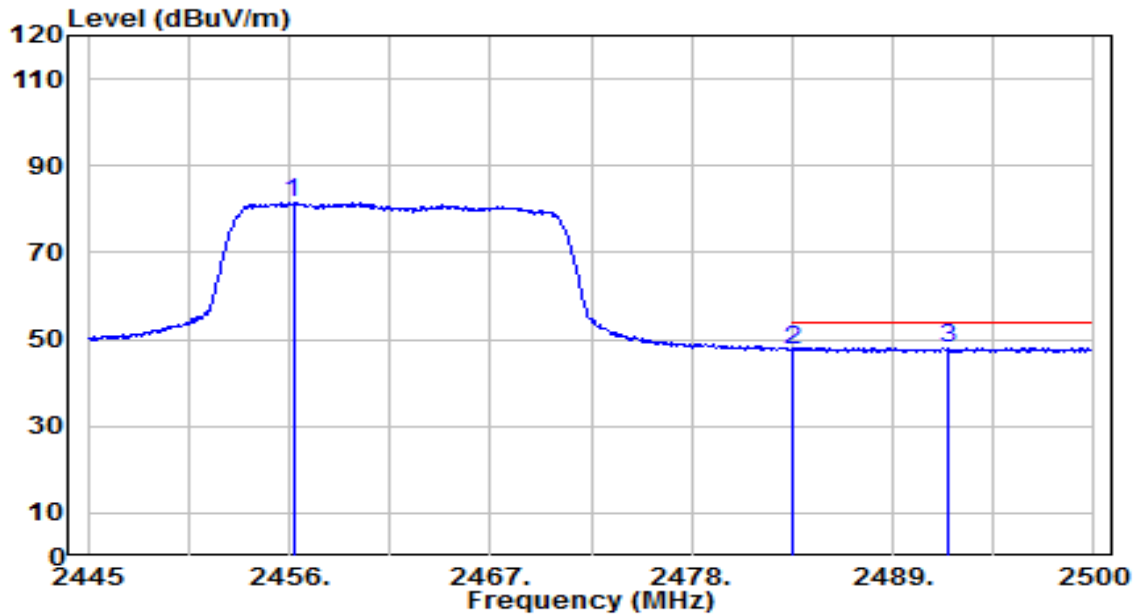

No	Frequency (MHz)	Reading (dBUV)	C.F (dB/m)	Measurement (dBUV/m)	Margin (dB)	Limit (dBUV/m)	Height (cm)	Angle (deg)	Remark (QP/PK/AV)
1	2456.220	49.44	32.11	81.55	N/A	N/A	155	210	Average
2	2483.500	15.50	32.20	47.70	-6.30	54.00	155	210	Average
3	* 2491.970	15.85	32.23	48.08	-5.92	54.00	155	210	Average

Note:

1. " *", means this data is the worst emission level.
2. C.F (Correction Factor) = Antenna Factor (dB/m)+ Cable Loss (dB).
3. Measurement (dBUV/m) = Reading(dBUV) + C.F (Correction Factor).
4. The emission levels of other frequencies are very lower than the limit and not show in test report.

7.8. AC Conducted Emissions Measurement

7.8.1. Test Limit

FCC Part 15 Subpart C Paragraph 15.207 / RSS-Gen Limits		
Frequency (MHz)	QP (dB μ V)	Average (dB μ V)
0.15 - 0.50	66 - 56	56 - 46
0.50 - 5.0	56	46
5.0 - 30	60	50

Note 1: The lower limit shall apply at the transition frequencies.

Note 2: The limit decreases linearly with the logarithm of the frequency in the range 0.15MHz to 0.5MHz.

7.8.2. Test Setup

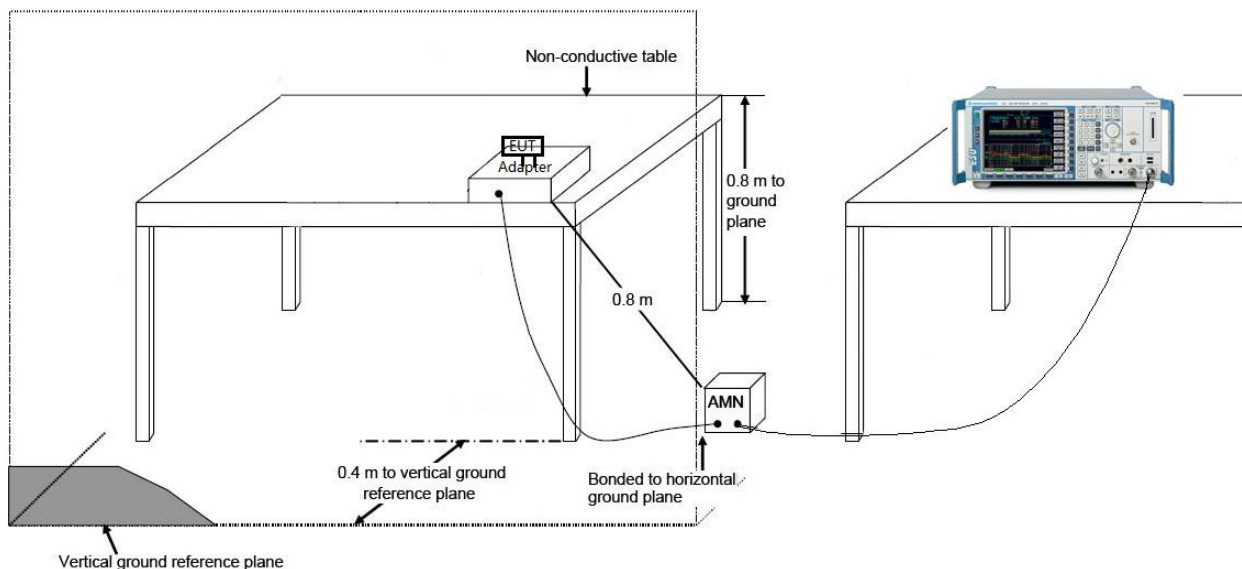

7.8.3. Test Result

EUT	Wi-Fi Φ3.9mm 2ways borescope	Date of Test	2024-01-10
Factor	CE_ENV216-L1 (Filter ON)	Temp. / Humidity	23.8°C /49%
Polarity	Line1	Site / Test Engineer	SR2 / Bob
Test Mode	802.11n-20MHz_TX_CH 6_ANT 0	Test Voltage	AC 120V/60Hz

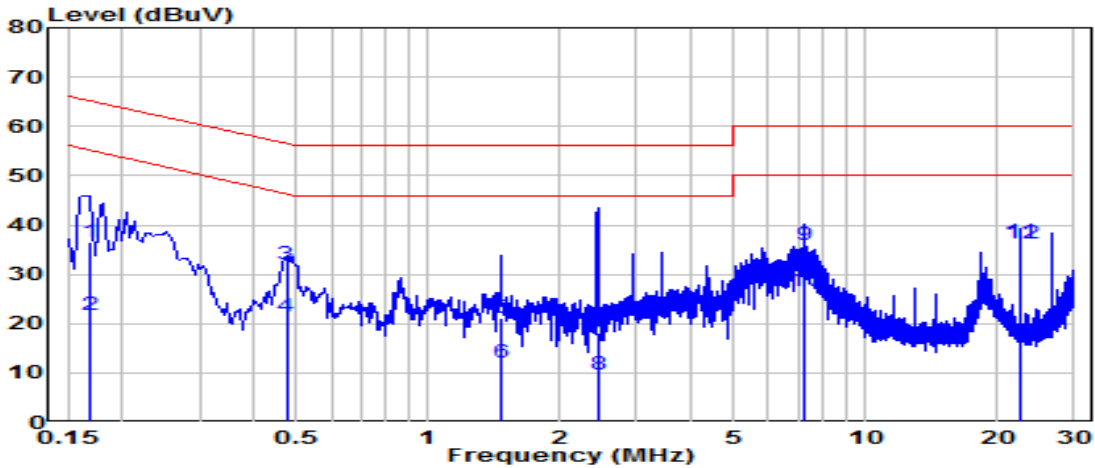

No	Frequency (MHz)	Reading (dBuV)	C.F (dB)	Measurement (dBuV)	Margin (dB)	Limit (dBuV)	Remark (QP/PK/AV)
1	0.168	26.83	9.62	36.45	-28.61	65.06	QP
2	0.168	12.26	9.62	21.88	-33.18	55.06	Average
3	0.474	22.39	9.64	32.03	-24.42	56.44	QP
4	0.474	11.88	9.64	21.52	-24.92	46.44	Average
5	1.468	11.46	9.68	21.14	-34.86	56.00	QP
6	1.468	2.29	9.68	11.97	-34.03	46.00	Average
7	2.440	8.40	9.70	18.10	-37.90	56.00	QP
8	2.440	-0.08	9.70	9.62	-36.38	46.00	Average
9	7.219	26.02	9.80	35.82	-24.18	60.00	QP
10	7.219	16.66	9.80	26.45	-23.55	50.00	Average
11	*	22.526	9.92	36.41	-23.59	60.00	QP
12	*	22.526	9.92	36.14	-13.86	50.00	Average

Note:

1. " *", means this data is the worst emission level.
2. C.F (Correction Factor) = LISN Factor (dB)+ Cable Loss (dB).
3. Measurement (dBuV) = Reading(dBuV) + C.F (Correction Factor).

EUT	Wi-Fi Φ3.9mm 2ways borescope	Date of Test	2024-01-10
Factor	CE_ENV216-N (Filter ON)	Temp. / Humidity	23.8°C /49%
Polarity	Neutral	Site / Test Engineer	SR2 / Bob
Test Mode	802.11n-20MHz_TX_CH 6_ANT 0	Test Voltage	AC 120V/60Hz

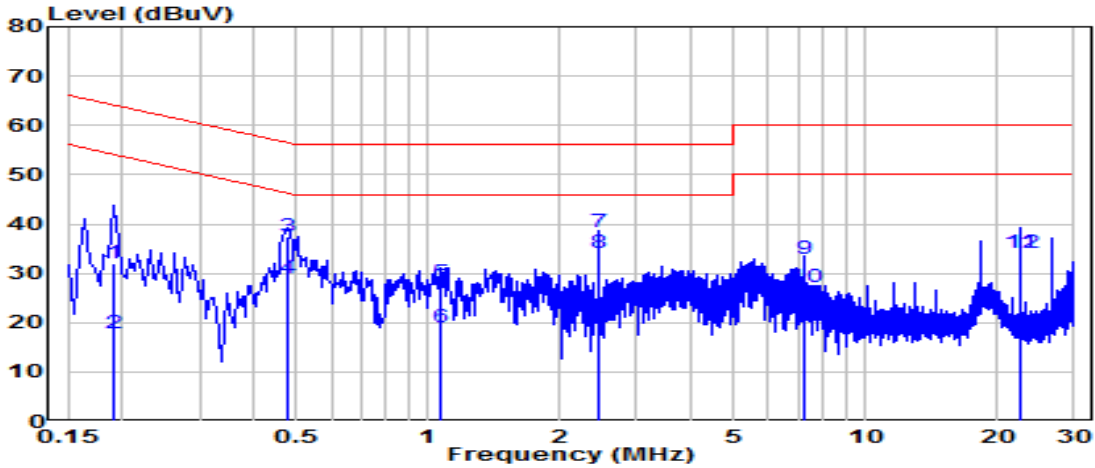

No	Frequency (MHz)	Reading (dBuV)	C.F (dB)	Measurement (dBuV)	Margin (dB)	Limit (dBuV)	Remark (QP/PK/AV)
1	0.190	22.47	9.62	32.10	-31.92	64.01	QP
2	0.190	8.27	9.62	17.89	-36.13	54.01	Average
3	0.478	27.82	9.64	37.46	-18.90	56.37	QP
4	0.478	19.38	9.64	29.02	-17.35	46.37	Average
5	1.072	18.49	9.67	28.17	-27.83	56.00	QP
6	1.072	9.35	9.67	19.02	-26.98	46.00	Average
7	* 2.449	28.59	9.70	38.29	-17.71	56.00	QP
8	* 2.449	24.33	9.70	34.03	-11.97	46.00	Average
9	7.223	22.99	9.80	32.79	-27.21	60.00	QP
10	7.223	17.34	9.80	27.15	-22.85	50.00	Average
11	22.526	24.25	10.01	34.26	-25.74	60.00	QP
12	22.526	24.12	10.01	34.13	-15.87	50.00	Average

Note:

1. " *", means this data is the worst emission level.
2. C.F (Correction Factor) = LISN Factor (dB)+ Cable Loss (dB).
3. Measurement (dBuV) = Reading(dBuV) + C.F (Correction Factor).

EUT	Wi-Fi Φ3.9mm 2ways borescope	Date of Test	2024-01-10
Factor	CE_ENV216-L1 (Filter ON)	Temp. / Humidity	23.8°C /49%
Polarity	Line1	Site / Test Engineer	SR2 / Bob
Test Mode	802.11n-20MHz_TX_CH 6_ANT 0	Test Voltage	AC 240V/60Hz

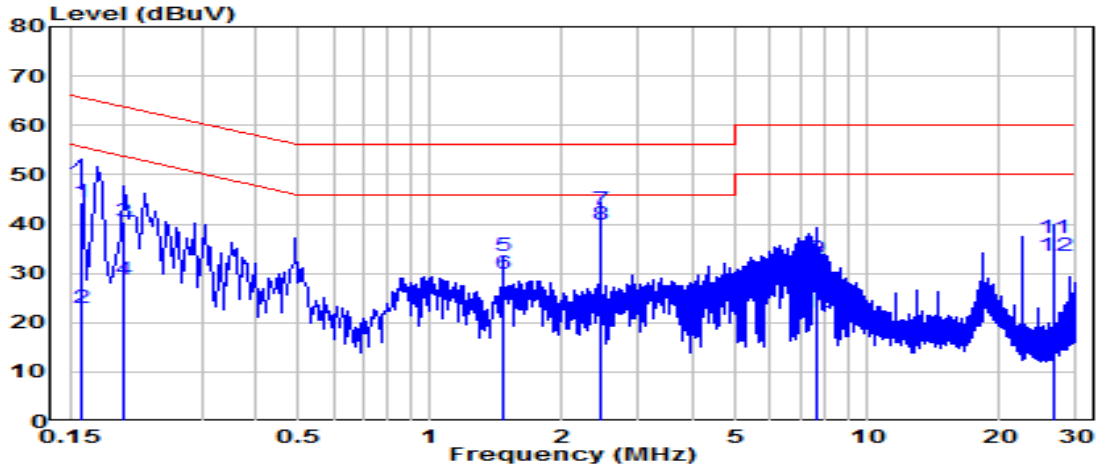

No	Frequency (MHz)	Reading (dBuV)	C.F (dB)	Measurement (dBuV)	Margin (dB)	Limit (dBuV)	Remark (QP/PK/AV)
1	0.159	34.68	9.62	44.30	-21.21	65.52	QP
2	0.159	13.45	9.62	23.07	-32.44	55.52	Average
3	0.199	30.75	9.62	40.37	-23.26	63.63	QP
4	0.199	18.98	9.62	28.60	-25.03	53.63	Average
5	1.468	23.76	9.68	33.44	-22.56	56.00	QP
6	1.468	20.27	9.68	29.95	-16.05	46.00	Average
7	* 2.449	33.23	9.70	42.93	-13.07	56.00	QP
8	* 2.449	30.11	9.70	39.81	-6.19	46.00	Average
9	7.619	22.96	9.81	32.77	-27.23	60.00	QP
10	7.619	12.32	9.81	22.12	-27.88	50.00	Average
11	26.621	27.28	9.91	37.19	-22.81	60.00	QP
12	26.621	23.63	9.91	33.54	-16.46	50.00	Average

Note:

1. " *", means this data is the worst emission level.
2. C.F (Correction Factor) = LISN Factor (dB)+ Cable Loss (dB).
3. Measurement (dBuV) = Reading(dBuV) + C.F (Correction Factor).

EUT	Wi-Fi Φ3.9mm 2ways borescope	Date of Test	2024-01-10
Factor	CE_ENV216-N (Filter ON)	Temp. / Humidity	23.8°C /49%
Polarity	Neutral	Site / Test Engineer	SR2 / Bob
Test Mode	802.11n-20MHz_TX_CH 6_ANT 0	Test Voltage	AC 240V/60Hz

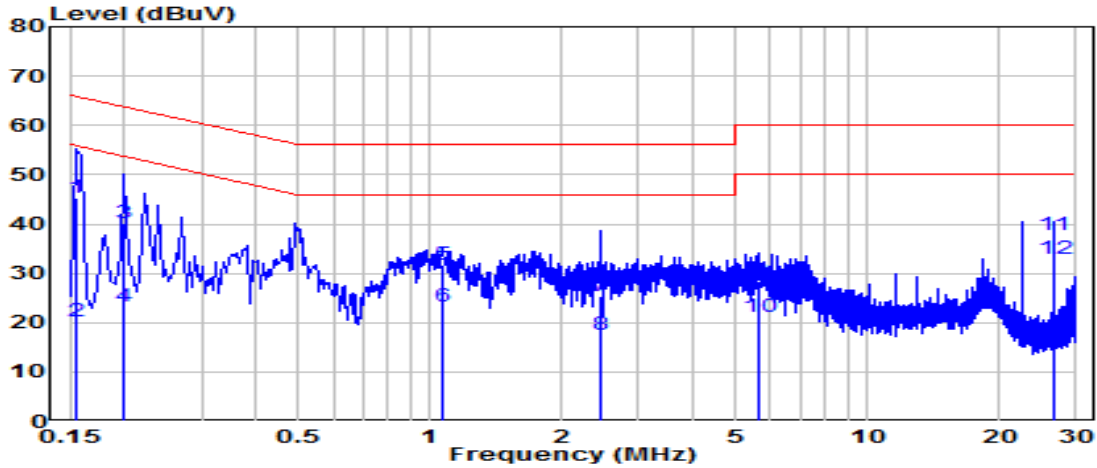

No	Frequency (MHz)	Reading (dBuV)	C.F (dB)	Measurement (dBuV)	Margin (dB)	Limit (dBuV)	Remark (QP/PK/AV)
1	0.154	35.63	9.62	45.25	-20.51	65.75	QP
2	0.154	10.58	9.62	20.20	-35.55	55.75	Average
3	0.199	30.56	9.62	40.18	-23.45	63.63	QP
4	0.199	13.60	9.62	23.22	-30.41	53.63	Average
5	1.072	21.96	9.67	31.63	-24.37	56.00	QP
6	1.072	13.64	9.67	23.31	-22.69	46.00	Average
7	2.445	15.72	9.70	25.42	-30.58	56.00	QP
8	2.445	7.79	9.70	17.49	-28.51	46.00	Average
9	5.630	18.72	9.76	28.48	-31.52	60.00	QP
10	5.630	11.45	9.76	21.21	-28.79	50.00	Average
11	* 26.621	27.58	10.03	37.61	-22.39	60.00	QP
12	* 26.621	23.02	10.03	33.05	-16.95	50.00	Average

Note:

1. " *", means this data is the worst emission level.
2. C.F (Correction Factor) = LISN Factor (dB)+ Cable Loss (dB).
3. Measurement (dBuV) = Reading(dBuV) + C.F (Correction Factor).

8. CONCLUSION

The data collected relate only the item(s) tested and show that the **Wi-Fi Φ 3.9mm 2ways borescope** is in compliance with Part 15C of the FCC Rules.

Appendix A : Test Photograph

Refer to “2312TW6501-UT” file.

Appendix B : External Photograph

Refer to “2312TW6501-UE” file.

Appendix C : Internal Photograph

Refer to “2312TW6501-UI” file.

————— The End —————