

FCC Test Report

Report No.: RF190119C10-1 R2

FCC ID: 2AA3N-TTR01

Test Model: PLTN-TTR01

Received Date: Jan. 19, 2019

Test Date: Jan. 31 ~ Mar. 15, 2019

Issued Date: Jun. 09, 2020

Applicant: Peloton Interactive Inc.

Address: 125 W 25th Street, 11th Floor, New York, NY, 10001, USA

Issued By: Bureau Veritas Consumer Products Services (H.K.) Ltd., Taoyuan Branch
Lin Kou Laboratories

Lab Address: No. 47-2, 14th Ling, Chia Pau Vil., Lin Kou Dist., New Taipei City, Taiwan

Test Location: No. 19, Hwa Ya 2nd Rd., Wen Hwa Vil., Kwei Shan Dist., Taoyuan City
33383, TAIWAN

**FCC Registration /
Designation Number:** 788550 / TW0003



This report is for your exclusive use. Any copying or replication of this report to or for any other person or entity, or use of our name or trademark, is permitted only with our prior written permission. This report sets forth our findings solely with respect to the test samples identified herein. The results set forth in this report are not indicative or representative of the quality or characteristics of the lot from which a test sample was taken or any similar or identical product specifically and expressly noted. Our report includes all of the tests requested by you and the results thereof based upon the information that you provided to us. You have 60 days from date of issuance of this report to notify us of any material error or omission caused by our negligence, provided, however, that such notice shall be in writing and shall specifically address the issue you wish to raise. A failure to raise such issue within the prescribed time shall constitute your unqualified acceptance of the completeness of this report, the tests conducted and the correctness of the report contents. Unless specific mention, the uncertainty of measurement has been explicitly taken into account to declare the compliance or non-compliance to the specification. The report must not be used by the client to claim product certification, approval, or endorsement by TAF or any government agencies.

Table of Contents

Release Control Record	4
1 Certificate of Conformity	5
2 Summary of Test Results	6
2.1 Measurement Uncertainty.....	6
2.2 Modification Record.....	6
3 General Information	7
3.1 General Description of EUT.....	7
3.2 Description of Test Modes.....	9
3.2.1 Test Mode Applicability and Tested Channel Detail.....	11
3.3 Duty Cycle of Test Signal.....	13
3.4 Description of Support Units.....	15
3.4.1 Configuration of System under Test.....	15
3.5 General Description of Applied Standards.....	15
4 Test Types and Results	16
4.1 Radiated Emission and Bandedge Measurement.....	16
4.1.1 Limits of Radiated Emission and Bandedge Measurement.....	16
4.1.2 Test Instruments.....	17
4.1.3 Test Procedures.....	18
4.1.4 Deviation from Test Standard.....	18
4.1.5 Test Setup.....	19
4.1.6 EUT Operating Conditions.....	20
4.1.7 Test Results.....	21
4.2 Conducted Emission Measurement.....	99
4.2.1 Limits of Conducted Emission Measurement.....	99
4.2.2 Test Instruments.....	99
4.2.3 Test Procedures.....	100
4.2.4 Deviation from Test Standard.....	100
4.2.5 Test Setup.....	100
4.2.6 EUT Operating Conditions.....	100
4.2.7 Test Results.....	101
4.3 Transmit Power Measurement.....	105
4.3.1 Limits of Transmit Power Measurement.....	105
4.3.2 Test Setup.....	105
4.3.3 Test Instruments.....	105
4.3.4 Test Procedure.....	106
4.3.5 Deviation from Test Standard.....	106
4.3.6 EUT Operating Conditions.....	106
4.3.7 Test Result.....	107
4.4 Occupied Bandwidth Measurement.....	120
4.4.1 Test Setup.....	120
4.4.2 Test Instruments.....	120
4.4.3 Test Procedure.....	120
4.4.4 Test Result.....	121
4.5 Peak Power Spectral Density Measurement.....	127
4.5.1 Limits of Peak Power Spectral Density Measurement.....	127
4.5.2 Test Setup.....	127
4.5.3 Test Instruments.....	127
4.5.4 Test Procedures.....	127
4.5.5 Deviation from Test Standard.....	128
4.5.6 EUT Operating Conditions.....	128
4.5.7 Test Results.....	129
4.6 Frequency Stability.....	140
4.6.1 Limits of Frequency Stability Measurement.....	140

4.6.2	Test Setup.....	140
4.6.3	Test Instruments	140
4.6.4	Test Procedure	140
4.6.5	Deviation from Test Standard	141
4.6.6	EUT Operating Condition	141
4.6.7	Test Results	141
4.7	6dB Bandwidth Measurement.....	143
4.7.1	Limits of 6dB Bandwidth Measurement.....	143
4.7.2	Test Setup.....	143
4.7.3	Test Instruments	143
4.7.4	Test Procedure	143
4.7.5	Deviation from Test Standard	143
4.7.6	EUT Operating Condition	143
4.7.7	Test Results	144
5	Pictures of Test Arrangements.....	148
	Annex A- Radiated Out of Band Emission (OOBE) Measurement (For U-NII-3 band).....	149
	Appendix – Information of the Testing Laboratories	155

Release Control Record

Issue No.	Description	Date Issued
RF190119C10-1	Original release	Mar. 18, 2019
RF190119C10-1 R1	Revised transmit power, all antenna port conducted measurement data had been revised	May 08, 2019
RF190119C10-1 R2	Revised item 3.4 description of Support Units	Jun. 09, 2020

1 Certificate of Conformity

Product: Peloton Console
Brand: PELOTON
Test Model: PLTN-TTR01
Sample Status: Engineering sample
Applicant: Peloton Interactive Inc.
Test Date: Jan. 31 ~ Mar. 15, 2019
Standards: 47 CFR FCC Part 15, Subpart E (Section 15.407)
ANSI C63.10:2013

The above equipment has been tested by **Bureau Veritas Consumer Products Services (H.K.) Ltd., Taoyuan Branch**, and found compliance with the requirement of the above standards. The test record, data evaluation & Equipment Under Test (EUT) configurations represented herein are true and accurate accounts of the measurements of the sample's RF characteristics under the conditions specified in this report.

Prepared by : Celine Chou , **Date:** Jun. 09, 2020
Celine Chou / Senior Specialist

Approved by : Bruce Chen , **Date:** Jun. 09, 2020
Bruce Chen / Senior Project Engineer

2 Summary of Test Results

47 CFR FCC Part 15, Subpart E (Section 15.407)			
FCC Clause	Test Item	Result	Remarks
15.407(b)(6)	AC Power Conducted Emissions	Pass	Meet the requirement of limit. Minimum passing margin is -8.82dB at 2.27625MHz.
15.407(b)(1/2/3/4(i/ii)/6)	Radiated Emissions & Band Edge Measurement	Pass	Meet the requirement of limit. Minimum passing margin is -0.4dB at 5350.00MHz and 5725.00MHz.
15.407(a)(1/2/3)	Max Average Transmit Power	Pass	Meet the requirement of limit.
---	Occupied Bandwidth Measurement	-	Reference only.
15.407(a)(1/2/3)	Peak Power Spectral Density	Pass	Meet the requirement of limit.
15.407(e)	6dB bandwidth	Pass	Meet the requirement of limit. (U-NII-3 Band only)
15.407(g)	Frequency Stability	Pass	Meet the requirement of limit.
15.203	Antenna Requirement	Pass	Antenna connector is i-pex(MHF) not a standard connector.

Note:

- Determining compliance based on the results of the compliance measurement, not taking into account measurement instrumentation uncertainty.
- For U-NII-3 band compliance with rule part 15.407(b)(4)(i), the OOB test plots were recorded in Annex A.

2.1 Measurement Uncertainty

Where relevant, the following measurement uncertainty levels have been estimated for tests performed on the EUT as specified in CISPR 16-4-2:

Measurement	Frequency	Expanded Uncertainty (k=2) (±)
Conducted Emissions at mains ports	150kHz ~ 30MHz	2.94 dB
Radiated Emissions up to 1 GHz	9kHz ~ 30MHz	3.04 dB
	30MHz ~ 200MHz	3.59 dB
	200MHz ~ 1000MHz	3.60 dB
Radiated Emissions above 1 GHz	1GHz ~ 18GHz	2.29 dB
	18GHz ~ 40GHz	2.29 dB

2.2 Modification Record

There were no modifications required for compliance.

3 General Information

3.1 General Description of EUT

Product	Peloton Console
Brand	PELTON
Test Model	PLTN-TTR01
Sample Status	Engineering sample
Power Supply Rating	20Vdc from adapter
Modulation Type	256QAM, 64QAM, 16QAM, QPSK, BPSK
Modulation Technology	OFDM
Transfer Rate	802.11a: 54/48/36/24/18/12/9/6Mbps 802.11n: up to 300Mbps 802.11ac: up to 867Mbps
Operating Frequency	5180 ~ 5240MHz, 5260 ~ 5320MHz, 5500 ~ 5700MHz, 5745 ~ 5825MHz
Number of Channel	5180 ~ 5240MHz: 802.11a, 802.11n (HT20), 802.11ac (VHT20): 4 802.11n (HT40), 802.11ac (VHT40): 2 802.11ac (VHT80): 1 5260 ~ 5320MHz: 802.11a, 802.11n (HT20), 802.11ac (VHT20): 4 802.11n (HT40), 802.11ac (VHT40): 2 802.11ac (VHT80): 1 5500 ~ 5700MHz: 802.11a, 802.11n (HT20), 802.11ac (VHT20): 8 802.11n (HT40), 802.11ac (VHT40): 3 802.11ac (VHT80): 1 5745 ~ 5825MHz: 802.11a, 802.11n (HT20), 802.11ac (VHT20): 5 802.11n (HT40), 802.11ac (VHT40): 2 802.11ac (VHT80): 1
Output Power	1TX: 5180 ~ 5240MHz: 110.917mW 5260 ~ 5320MHz: 113.501mW 5500 ~ 5700MHz: 190.546mW 5745 ~ 5825MHz: 239.332mW 2TX: 5180 ~ 5240MHz: 114.695mW 5260 ~ 5320MHz: 116.155mW 5500 ~ 5700MHz: 248.053mW 5745 ~ 5825MHz: 447.336mW
Antenna Type	Refer to note
Antenna Connector	Refer to note
Accessory Device	Adapter, Exercise Bike
Cable Supplied	NA

Note:

1. The EUT incorporates a MIMO function. Physically, the EUT provides 2 completed transmitters and 2 receivers.

Modulation Mode	TX Function
802.11a	1TX/2TX
802.11n (HT20)	1TX/2TX
802.11n (HT40)	1TX/2TX
802.11ac (VHT20)	1TX/2TX
802.11ac (VHT40)	1TX/2TX
802.11ac (VHT80)	1TX/2TX

* The modulation and bandwidth are similar for 802.11n mode for 20MHz/40MHz and 802.11ac mode for 20MHz/40MHz, therefore investigated worst case to representative mode in test report. (Final test mode refer section 3.2.1)

2. The EUT consumes power from the following Adapter.

Adapter	
Brand	PELTON
Model	FSP065-APDC8R01
Input Power	100-240Vac, 50-60Hz, 1.7A
Output Power	5Vdc, 3A or 9Vdc, 3A or 20Vdc, 3.25A, 65W Max.
Power Line	AC: 1.7m non-shielded power cable without core DC: 1.5m non-shielded power cable without core attached on adapter

3. The following antennas were provided to the EUT.

Ant. No.	Brand	Model	Type	Connector	Gain (dBi)	
					2.4G	5G
Main	Peloton	UI8(Topaz)	PIFA	i-pex(MHF)	-0.19	0.58
AUX	Peloton	UI8(Topaz)	PIFA	i-pex(MHF)	0.28	2.34

* For 1TX, AUX ant. was the max. gain and chosen for final test

4. Spurious emission of the simultaneous operation mode as below and the test data please refer to report no.: RF190119C10-7.

No	Mode
1	WLAN 2.4GHz + WLAN 5GHz
2	BT + WLAN 5GHz
3	ANT+ + WLAN 5GHz

3.2 Description of Test Modes

For 5180 ~ 5240MHz:

4 channels are provided for 802.11a, 802.11n (HT20), 802.11ac (VHT20):

Channel	Frequency	Channel	Frequency
36	5180 MHz	44	5220 MHz
40	5200 MHz	48	5240 MHz

2 channels are provided for 802.11n (HT40), 802.11ac (VHT40):

Channel	Frequency	Channel	Frequency
38	5190 MHz	46	5230 MHz

1 channel is provided for 802.11ac (VHT80):

Channel	Frequency
42	5210MHz

For 5260 ~ 5320MHz:

4 channels are provided for 802.11a, 802.11n (HT20), 802.11ac (VHT20):

Channel	Frequency	Channel	Frequency
52	5260 MHz	60	5300 MHz
56	5280 MHz	64	5320 MHz

2 channels are provided for 802.11n (HT40), 802.11ac (VHT40):

Channel	Frequency	Channel	Frequency
54	5270 MHz	62	5310 MHz

1 channel is provided for 802.11ac (VHT80):

Channel	Frequency
58	5290MHz

For 5500 ~ 5700MHz:

8 channels are provided for 802.11a, 802.11n (HT20), 802.11ac (VHT20):

Channel	Frequency	Channel	Frequency
100	5500 MHz	116	5580 MHz
104	5520 MHz	132	5660 MHz
108	5540 MHz	136	5680 MHz
112	5560 MHz	140	5700 MHz

3 channels are provided for 802.11n (HT40), 802.11ac (VHT40):

Channel	Frequency	Channel	Frequency
102	5510 MHz	134	5670 MHz
110	5550 MHz		

1 channel is provided for 802.11ac (VHT80):

Channel	Frequency
106	5530 MHz

For 5745 ~ 5825MHz:

5 channels are provided for 802.11a, 802.11n (HT20), 802.11ac (VHT20):

Channel	Frequency	Channel	Frequency
149	5745MHz	161	5805MHz
153	5765MHz	165	5825MHz
157	5785MHz		

2 channels are provided for 802.11n (HT40), 802.11ac (VHT40):

Channel	Frequency	Channel	Frequency
151	5755MHz	159	5795MHz

1 channel is provided for 802.11ac (VHT80):

Channel	Frequency
155	5775MHz

3.2.1 Test Mode Applicability and Tested Channel Detail

EUT Configure Mode	Applicable to				Description
	RE \geq 1G	RE<1G	PLC	APCM	
A	√	√	√	√	EUT + Adapter
B	-	√	√	-	EUT + Exercise Bike + Adapter

Where RE \geq 1G: Radiated Emission above 1GHz & Bandedge Measurement
 RE<1G: Radiated Emission below 1GHz
 PLC: Power Line Conducted Emission
 APCM: Antenna Port Conducted Measurement

Radiated Emission Test (Above 1GHz):

- Pre-Scan has been conducted to determine the worst-case mode from all possible combinations between available modulations, data rates and antenna ports (if EUT with antenna diversity architecture).
- Following channel(s) was (were) selected for the final test as listed below.

EUT Configure Mode	Mode	Frequency Band (MHz)	Available Channel	Tested Channel	Modulation Technology	Data Rate (Mbps)	TX Function
A	802.11a	5180-5240	36 to 48	36, 40, 48	OFDM	6.0	1TX, 2TX
	802.11n (HT20)		36 to 48	36, 40, 48	OFDM	6.5	1TX, 2TX
	802.11n (HT40)		38 to 46	38, 46	OFDM	13.5	1TX, 2TX
	802.11ac (VHT80)		42	42	OFDM	29.3	1TX, 2TX
A	802.11a	5260-5320	52 to 64	52, 60, 64	OFDM	6.0	1TX, 2TX
	802.11n (HT20)		52 to 64	52, 60, 64	OFDM	6.5	1TX, 2TX
	802.11n (HT40)		54 to 62	54, 62	OFDM	13.5	1TX, 2TX
	802.11ac (VHT80)		58	58	OFDM	29.3	1TX, 2TX
A	802.11a	5500-5700	100 to 140	100, 116, 140	OFDM	6.0	1TX, 2TX
	802.11n (HT20)		100 to 140	100, 116, 140	OFDM	6.5	1TX, 2TX
	802.11n (HT40)		102 to 134	102, 110, 134	OFDM	13.5	1TX, 2TX
	802.11ac (VHT80)		106	106	OFDM	29.3	1TX, 2TX
A	802.11a	5745-5825	149 to 165	149, 157, 165	OFDM	6.0	1TX, 2TX
	802.11n (HT20)		149 to 165	149, 157, 165	OFDM	6.5	1TX, 2TX
	802.11n (HT40)		151 to 159	151, 159	OFDM	13.5	1TX, 2TX
	802.11ac (VHT80)		155	155	OFDM	29.3	1TX, 2TX

Radiated Emission Test (Below 1GHz):

- Pre-Scan has been conducted to determine the worst-case mode from all possible combinations between available modulations, data rates and antenna ports (if EUT with antenna diversity architecture).
- Following channel(s) was (were) selected for the final test as listed below.

EUT Configure Mode	Mode	Frequency Band (MHz)	Available Channel	Tested Channel	Modulation Technology	Data Rate (Mbps)	TX Function
A, B	802.11a	5180-5240	36 to 48	157	OFDM	6.0	2TX
	802.11a	5260-5320	52 to 64		OFDM	6.0	
	802.11a	5500-5700	100 to 140		OFDM	6.0	
	802.11a	5745-5825	149 to 165		OFDM	6.0	

Power Line Conducted Emission Test:

- Pre-Scan has been conducted to determine the worst-case mode from all possible combinations between available modulations, data rates and antenna ports (if EUT with antenna diversity architecture).
- Following channel(s) was (were) selected for the final test as listed below.

EUT Configure Mode	Mode	Frequency Band (MHz)	Available Channel	Tested Channel	Modulation Technology	Data Rate (Mbps)	TX Function
A, B	802.11a	5180-5240	36 to 48	157	OFDM	6.0	2TX
	802.11a	5260-5320	52 to 64		OFDM	6.0	
	802.11a	5500-5700	100 to 140		OFDM	6.0	
	802.11a	5745-5825	149 to 165		OFDM	6.0	

Antenna Port Conducted Measurement:

- This item includes all test value of each mode, but only includes spectrum plot of worst value of each mode.
- Pre-Scan has been conducted to determine the worst-case mode from all possible combinations between available modulations, data rates and antenna ports (if EUT with antenna diversity architecture).
- Following channel(s) was (were) selected for the final test as listed below.

EUT Configure Mode	Mode	Frequency Band (MHz)	Available Channel	Tested Channel	Modulation Technology	Data Rate (Mbps)	TX Function
A	802.11a	5180-5240	36 to 48	36, 40, 48	OFDM	6.0	1TX, 2TX
	802.11n (HT20)		36 to 48	36, 40, 48	OFDM	6.5	1TX, 2TX
	802.11n (HT40)		38 to 46	38, 46	OFDM	13.5	1TX, 2TX
	802.11ac (VHT80)		42	42	OFDM	29.3	1TX, 2TX
A	802.11a	5260-5320	52 to 64	52, 60, 64	OFDM	6.0	1TX, 2TX
	802.11n (HT20)		52 to 64	52, 60, 64	OFDM	6.5	1TX, 2TX
	802.11n (HT40)		54 to 62	54, 62	OFDM	13.5	1TX, 2TX
	802.11ac (VHT80)		58	58	OFDM	29.3	1TX, 2TX
A	802.11a	5500-5700	100 to 140	100, 116, 140	OFDM	6.0	1TX, 2TX
	802.11n (HT20)		100 to 140	100, 116, 140	OFDM	6.5	1TX, 2TX
	802.11n (HT40)		102 to 134	102, 110, 134	OFDM	13.5	1TX, 2TX
	802.11ac (VHT80)		106	106	OFDM	29.3	1TX, 2TX
A	802.11a	5745-5825	149 to 165	149, 157, 165	OFDM	6.0	1TX, 2TX
	802.11n (HT20)		149 to 165	149, 157, 165	OFDM	6.5	1TX, 2TX
	802.11n (HT40)		151 to 159	151, 159	OFDM	13.5	1TX, 2TX
	802.11ac (VHT80)		155	155	OFDM	29.3	1TX, 2TX

Test Condition:

Applicable to	Environmental Conditions	Input Power	Tested by
RE≥1G	22 deg. C, 66% RH	120Vac, 60Hz	Han Wu Greg Lin Tim Chen
RE<1G	21 deg. C, 68% RH 22 deg. C, 66% RH	120Vac, 60Hz	Willy Cheng Greg Lin
PLC	25 deg. C, 75% RH	120Vac, 60Hz	Willy Cheng Jones Chang
APCM	25 deg. C, 60% RH	120Vac, 60Hz	Allen Wu

3.3 Duty Cycle of Test Signal

1TX

Duty cycle of test signal is < 98%, duty factor is required.

802.11a: Duty cycle = 2.060/2.122 = 0.971, Duty factor = $10 \cdot \log(1/0.971) = 0.13$

802.11n (HT20): Duty cycle = 1.920/1.967 = 0.976, Duty factor = $10 \cdot \log(1/0.976) = 0.11$

802.11n (HT40): Duty cycle = 0.941/0.980 = 0.960, Duty factor = $10 \cdot \log(1/0.960) = 0.18$

802.11ac (VHT80): Duty cycle = 0.462/0.517 = 0.894, Duty factor = $10 \cdot \log(1/0.894) = 0.49$

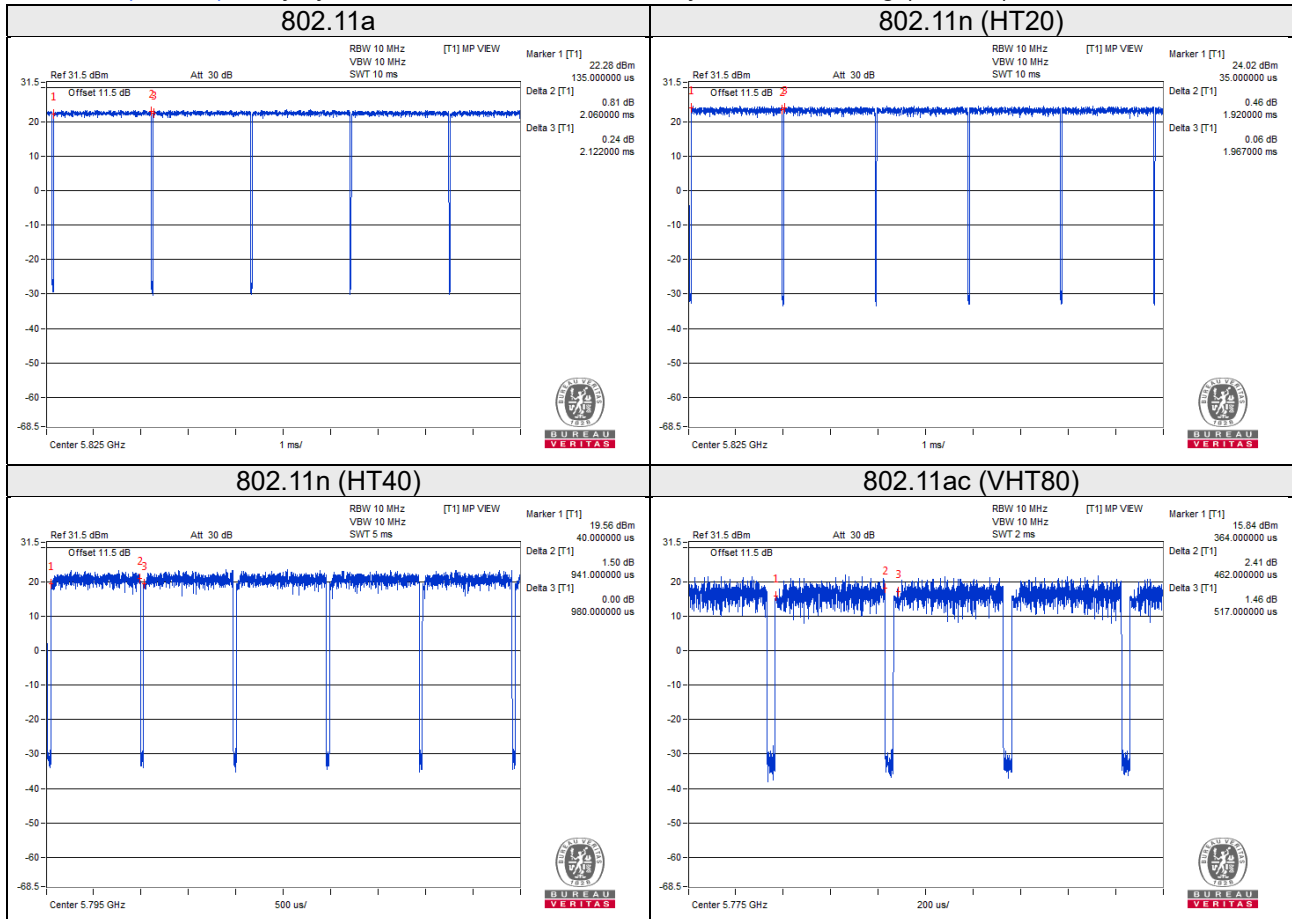

2TX

802.11a, 802.11n (HT20): Duty cycle of test signal is $\geq 98\%$, duty factor is not required.

802.11n (HT40), 802.11ac (VHT80): Duty cycle of test signal is $< 98\%$, duty factor is required.

802.11a: Duty cycle = $2.062/2.105 = 0.980$

802.11n (HT20): Duty cycle = $1.925/1.965 = 0.980$

802.11n (HT40): Duty cycle = $0.945/0.986 = 0.958$, Duty factor = $10 * \log (1/0.958) = 0.18$

802.11ac (VHT80): Duty cycle = $0.464/0.501 = 0.926$, Duty factor = $10 * \log (1/0.926) = 0.33$

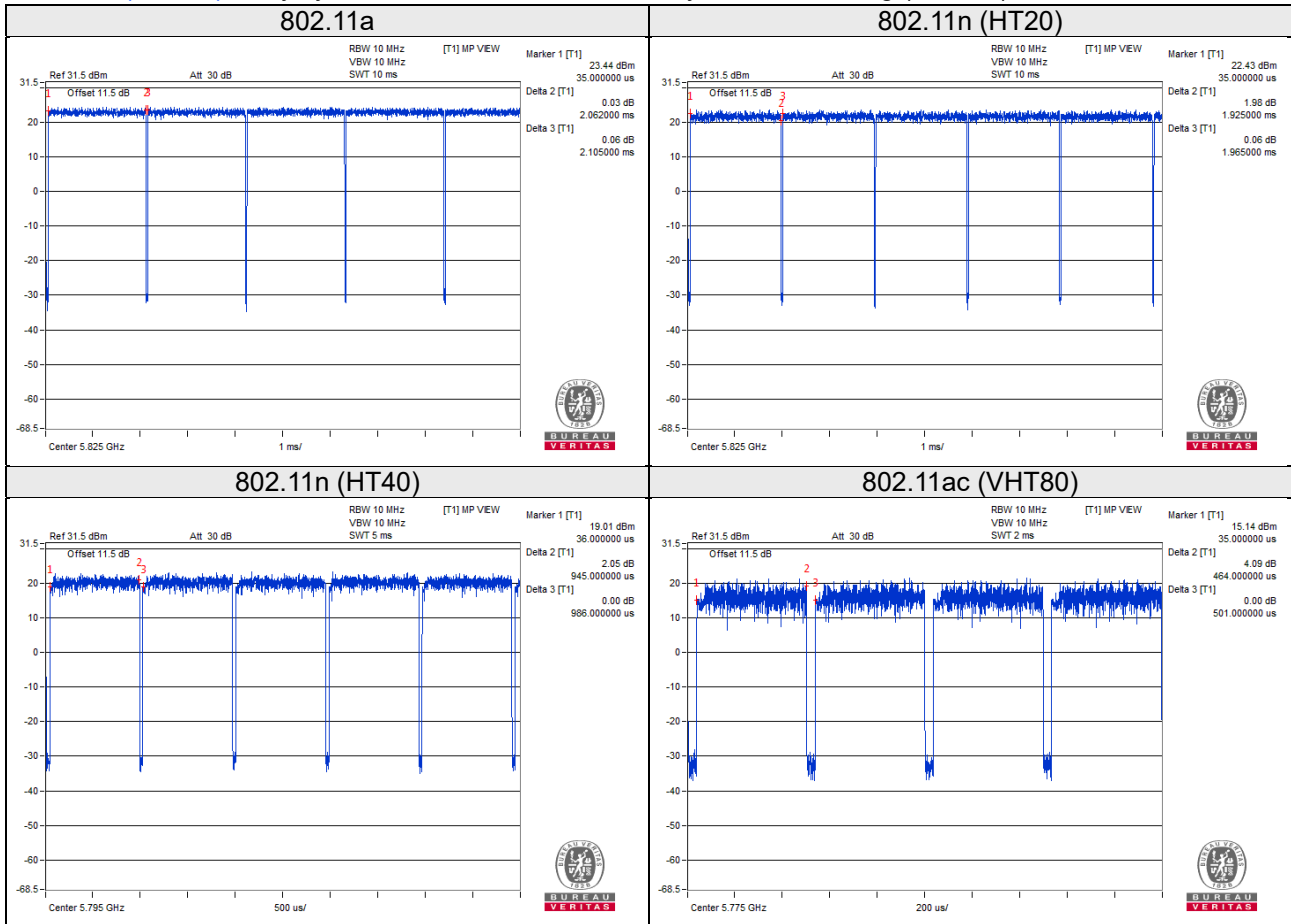

3.4 Description of Support Units

The EUT has been tested as an independent unit.
Exercise Bike and adapter included as representative accessories.

3.4.1 Configuration of System under Test

Test Mode A

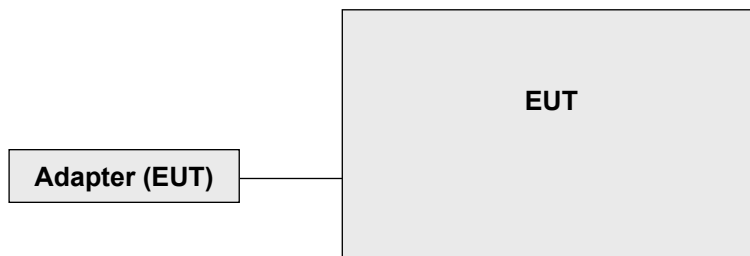

Test Mode B

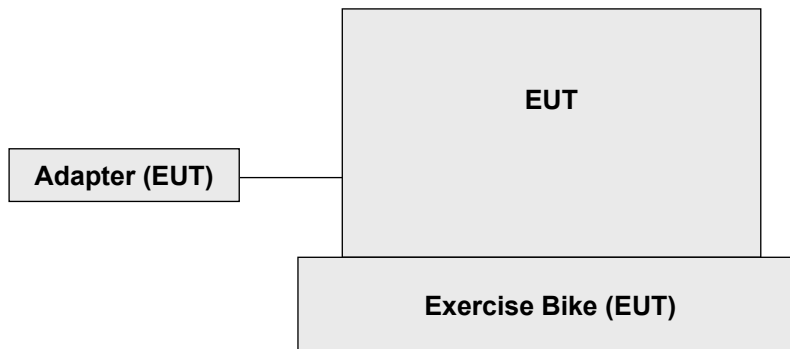

3.5 General Description of Applied Standards

The EUT is a RF Product. According to the specifications of the manufacturer, it must comply with the requirements of the following standards:

FCC Part 15, Subpart E (15.407)

KDB 789033 D02 General UNII Test Procedure New Rules v02r01

KDB 662911 D01 Multiple Transmitter Output v02r01

ANSI C63.10:2013

All test items have been performed and recorded as per the above standards.

4 Test Types and Results

4.1 Radiated Emission and Bandedge Measurement

4.1.1 Limits of Radiated Emission and Bandedge Measurement

Radiated emissions which fall in the restricted bands must comply with the radiated emission limits specified as below table.

Frequencies (MHz)	Field Strength (microvolts/meter)	Measurement Distance (meters)
0.009 ~ 0.490	2400/F(kHz)	300
0.490 ~ 1.705	24000/F(kHz)	30
1.705 ~ 30.0	30	30
30 ~ 88	100	3
88 ~ 216	150	3
216 ~ 960	200	3
Above 960	500	3

Note:

1. The lower limit shall apply at the transition frequencies.
2. Emission level (dBuV/m) = 20 log Emission level (uV/m).
3. For frequencies above 1000MHz, the field strength limits are based on average detector, however, the peak field strength of any emission shall not exceed the maximum permitted average limits, specified above by more than 20dB under any condition of modulation.

Limits of unwanted emission out of the restricted bands

Applicable To		Limit	
789033 D02 General UNII Test Procedure New Rules v02r01		Field Strength at 3m	
		PK: 74 (dBµV/m)	AV: 54 (dBµV/m)
Frequency Band	Applicable To	EIRP Limit	Equivalent Field Strength at 3m
5150~5250 MHz	15.407(b)(1)	PK: -27 (dBm/MHz)	PK: 68.2(dBµV/m)
5250~5350 MHz	15.407(b)(2)		
5470~5725 MHz	15.407(b)(3)		
5725~5850 MHz	<input checked="" type="checkbox"/> 15.407(b)(4)(i)	PK: -27 (dBm/MHz) ^{*1} PK: 10 (dBm/MHz) ^{*2} PK: 15.6 (dBm/MHz) ^{*3} PK: 27 (dBm/MHz) ^{*4}	PK: 68.2(dBµV/m) ^{*1} PK: 105.2 (dBµV/m) ^{*2} PK: 110.8(dBµV/m) ^{*3} PK: 122.2 (dBµV/m) ^{*4}
	<input type="checkbox"/> 15.407(b)(4)(ii)	Emission limits in section 15.247(d)	
^{*1} beyond 75 MHz or more above of the band edge.		^{*2} below the band edge increasing linearly to 10 dBm/MHz at 25 MHz above.	
^{*3} below the band edge increasing linearly to a level of 15.6 dBm/MHz at 5 MHz above.		^{*4} from 5 MHz above or below the band edge increasing linearly to a level of 27 dBm/MHz at the band edge.	

Note: The following formula is used to convert the equipment isotropic radiated power (eirp) to field strength:

$$E = \frac{1000000 \sqrt{30P}}{3} \text{ } \mu\text{V/m, where P is the eirp (Watts).}$$

4.1.2 Test Instruments

Description & Manufacturer	Model No.	Serial No.	Cal. Date	Cal. Due
Test Receiver KEYSIGHT	N9038A	MY55420137	Apr. 11, 2018	Apr. 10, 2019
Spectrum Analyzer ROHDE & SCHWARZ	FSP40	100269	May 29, 2018	May 28, 2019
BILOG Antenna SCHWARZBECK	VULB9168	9168-160	Nov. 21, 2018	Nov. 20, 2019
HORN Antenna SCHWARZBECK	BBHA 9120 D	9120D-1169	Nov. 25, 2018	Nov. 24, 2019
HORN Antenna SCHWARZBECK	BBHA 9170	BBHA9170241	Nov. 25, 2018	Nov. 24, 2019
Loop Antenna TESEQ	HLA 6121	45745	Jun. 14, 2018	Jun. 13, 2019
Preamplifier Agilent (Below 1GHz)	8447D	2944A10638	Aug. 08, 2018	Aug. 07, 2019
Preamplifier Agilent (Above 1GHz)	8449B	3008A02367	Mar. 16, 2018	Mar. 15, 2019
RF signal cable HUBER+SUHNER&EMCI	SUCOFLEX 104 & EMC104-SM-SM80 00	CABLE-CH9-02 (248780+171006)	Jan. 19, 2019	Jan. 18, 2020
RF signal cable HUBER+SUHNER	SUCOFLEX 104	CABLE-CH9-(250795/4)	Aug. 08, 2018	Aug. 07, 2019
RF signal cable Woken	8D-FB	Cable-CH9-01	Jul. 31, 2018	Jul. 30, 2019
Software BV ADT	ADT_Radiated_ V7.6.15.9.5	NA	NA	NA
Antenna Tower EMCO	2070/2080	512.835.4684	NA	NA
Turn Table EMCO	2087-2.03	NA	NA	NA
Antenna Tower & Turn BV ADT	AT100	AT93021705	NA	NA
Turn Table BV ADT	TT100	TT93021705	NA	NA
Turn Table Controller BV ADT	SC100	SC93021705	NA	NA
Boresight Antenna Fixture	FBA-01	FBA-SIP01	NA	NA
Pre-amplifier (18GHz-40GHz) EMC	EMC184045B	980175	Nov. 14, 2018	Nov. 13, 2019
USB Wideband Power Sensor KEYSIGHT	U2021XA	MY55050005/MY55190 004/MY55190007/MY55 210005	Jul. 17, 2018	Jul. 16, 2019

- Note: 1. The calibration interval of the above test instruments is 12 months and the calibrations are traceable to NML/ROC and NIST/USA.
 2. The test was performed in HwaYa Chamber 9.
 3. The FCC Designation Number is TW0003. The number will be varied with the Lab location and scope as attached.
 4. The IC Site Registration No. is 7450F-9.

4.1.3 Test Procedures

For Radiated emission below 30MHz

- a. The EUT was placed on the top of a rotating table 0.8 meters above the ground at a 3 meter chamber room. The table was rotated 360 degrees to determine the position of the highest radiation.
- b. The EUT was set 3 meters away from the interference-receiving antenna, which was mounted on the top of a variable-height antenna tower.
- c. Parallel, perpendicular, and ground-parallel orientations of the antenna are set to make the measurement.
- d. For each suspected emission, the EUT was arranged to its worst case and the rotatable table was turned from 0 degrees to 360 degrees to find the maximum reading.
- e. The test-receiver system was set to Quasi-Peak Detect Function and Specified Bandwidth with Maximum Hold Mode.

Note:

1. The resolution bandwidth and video bandwidth of test receiver/spectrum analyzer is 9kHz at frequency below 30MHz.

For Radiated emission above 30MHz

- a. The EUT was placed on the top of a rotating table 0.8 meters (for 30MHz ~ 1GHz) / 1.5 meters (for above 1GHz) above the ground at 3 meter chamber room for test. The table was rotated 360 degrees to determine the position of the highest radiation.
- b. The EUT was set 3 meters away from the interference-receiving antenna, which was mounted on the top of a variable-height antenna tower.
- c. The height of antenna is varied from one meter to four meters above the ground to determine the maximum value of the field strength. Both horizontal and vertical polarizations of the antenna are set to make the measurement.
- d. For each suspected emission, the EUT was arranged to its worst case and then the antenna was tuned to heights from 1 meter to 4 meters and the rotatable table was turned from 0 degrees to 360 degrees to find the maximum reading.
- e. The test-receiver system was set to quasi-peak detect function and specified bandwidth with maximum hold mode when the test frequency is below 1 GHz.
- f. The test-receiver system was set to peak and average detect function and specified bandwidth with maximum hold mode when the test frequency is above 1 GHz. If the peak reading value also meets average limit, measurement with the average detector is unnecessary.

Note:

1. The resolution bandwidth and video bandwidth of test receiver/spectrum analyzer is 120kHz for Quasi-peak detection (QP) at frequency below 1GHz.
2. The resolution bandwidth of test receiver/spectrum analyzer is 1 MHz and the video bandwidth is 3 MHz for Peak detection (PK) at frequency above 1GHz.
3. The resolution bandwidth of test receiver/spectrum analyzer is 1MHz and the video bandwidth is $\geq 1/T$ (Duty cycle < 98%) or 10Hz (Duty cycle $\geq 98\%$) for Average detection (AV) at frequency above 1GHz.
4. All modes of operation were investigated and the worst-case emissions are reported.

4.1.4 Deviation from Test Standard

No deviation.

4.1.5 Test Setup

For Radiated emission below 30MHz

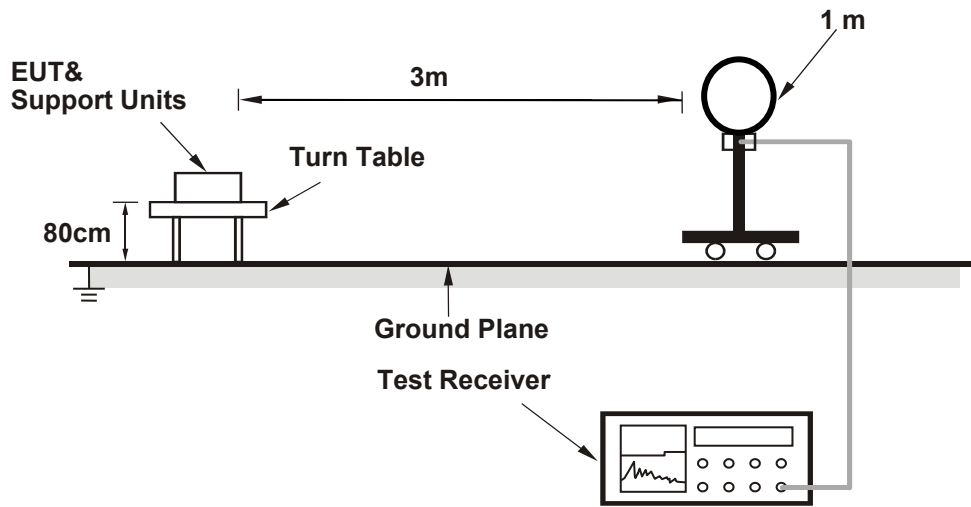

For Radiated emission 30MHz to 1GHz

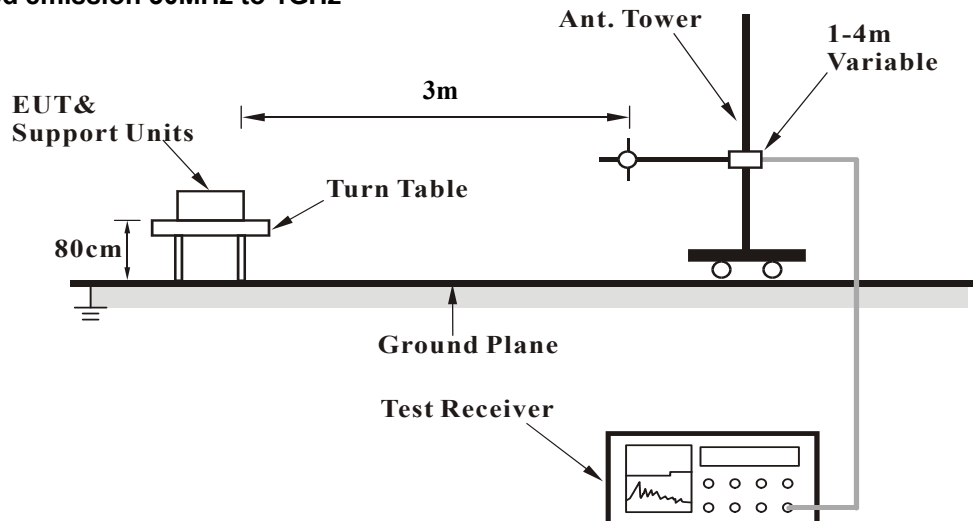

For Radiated emission above 1GHz

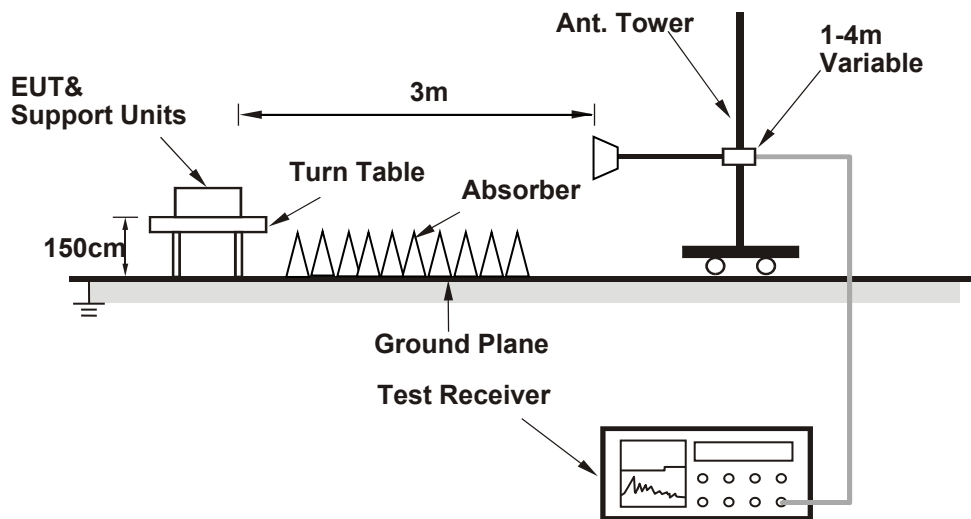

For the actual test configuration, please refer to the attached file (Test Setup Photo).

4.1.6 EUT Operating Conditions

- a. Set the EUT under transmission condition continuously at specific channel frequency.

4.1.7 Test Results

Above 1GHz data:

1TX

802.11a

CHANNEL	TX Channel 36	DETECTOR FUNCTION	Peak (PK) Average (AV)
FREQUENCY RANGE	1GHz ~ 40GHz		

ANTENNA POLARITY & TEST DISTANCE: HORIZONTAL AT 3 M								
NO.	FREQ. (MHz)	EMISSION LEVEL (dBuV/m)	LIMIT (dBuV/m)	MARGIN (dB)	ANTENNA HEIGHT (m)	TABLE ANGLE (Degree)	RAW VALUE (dBuV)	CORRECTION FACTOR (dB/m)
1	5150.00	62.0 PK	74.0	-12.0	2.19 H	25	60.9	1.1
2	5150.00	48.9 AV	54.0	-5.1	2.19 H	25	47.8	1.1
3	*5180.00	108.9 PK			2.29 H	16	70.9	38.0
4	*5180.00	98.9 AV			2.29 H	16	60.9	38.0
5	#10360.00	53.8 PK	68.2	-14.4	2.47 H	208	40.2	13.6

ANTENNA POLARITY & TEST DISTANCE: VERTICAL AT 3 M								
NO.	FREQ. (MHz)	EMISSION LEVEL (dBuV/m)	LIMIT (dBuV/m)	MARGIN (dB)	ANTENNA HEIGHT (m)	TABLE ANGLE (Degree)	RAW VALUE (dBuV)	CORRECTION FACTOR (dB/m)
1	5150.00	63.8 PK	74.0	-10.2	1.63 V	1	62.7	1.1
2	5150.00	49.6 AV	54.0	-4.4	1.63 V	1	48.5	1.1
3	*5180.00	110.1 PK			1.73 V	8	72.1	38.0
4	*5180.00	100.0 AV			1.73 V	8	62.0	38.0
5	#10360.00	54.4 PK	68.2	-13.8	3.54 V	162	40.8	13.6

Remarks:

1. Emission Level(dBuV/m) = Raw Value(dBuV) + Correction Factor(dB/m)
2. Correction Factor(dB/m) = Antenna Factor(dB/m) + Cable Factor(dB) – Pre-Amplifier Factor(dB)
3. The other emission levels were very low against the limit
4. Margin value = Emission Level – Limit value
5. " * ": Fundamental frequency
6. " # ": The radiated frequency is out of the restricted band

CHANNEL	TX Channel 40	DETECTOR FUNCTION	Peak (PK) Average (AV)
FREQUENCY RANGE	1GHz ~ 40GHz		

ANTENNA POLARITY & TEST DISTANCE: HORIZONTAL AT 3 M

NO.	FREQ. (MHz)	EMISSION LEVEL (dBuV/m)	LIMIT (dBuV/m)	MARGIN (dB)	ANTENNA HEIGHT (m)	TABLE ANGLE (Degree)	RAW VALUE (dBuV)	CORRECTION FACTOR (dB/m)
1	*5200.00	110.1 PK			2.43 H	11	72.2	37.9
2	*5200.00	100.3 AV			2.43 H	11	62.4	37.9
3	#10400.00	54.1 PK	68.2	-14.1	2.62 H	214	40.3	13.8

ANTENNA POLARITY & TEST DISTANCE: VERTICAL AT 3 M

NO.	FREQ. (MHz)	EMISSION LEVEL (dBuV/m)	LIMIT (dBuV/m)	MARGIN (dB)	ANTENNA HEIGHT (m)	TABLE ANGLE (Degree)	RAW VALUE (dBuV)	CORRECTION FACTOR (dB/m)
1	*5200.00	111.3 PK			1.19 V	181	73.4	37.9
2	*5200.00	101.5 AV			1.19 V	181	63.6	37.9
3	#10400.00	54.9 PK	68.2	-13.3	3.28 V	157	41.1	13.8

Remarks:

1. Emission Level(dBuV/m) = Raw Value(dBuV) + Correction Factor(dB/m)
2. Correction Factor(dB/m) = Antenna Factor(dB/m) + Cable Factor(dB) – Pre-Amplifier Factor(dB)
3. The other emission levels were very low against the limit
4. Margin value = Emission Level – Limit value
5. " * ": Fundamental frequency
6. " # ": The radiated frequency is out of the restricted band

CHANNEL	TX Channel 48	DETECTOR FUNCTION	Peak (PK) Average (AV)
FREQUENCY RANGE	1GHz ~ 40GHz		

ANTENNA POLARITY & TEST DISTANCE: HORIZONTAL AT 3 M								
NO.	FREQ. (MHz)	EMISSION LEVEL (dBuV/m)	LIMIT (dBuV/m)	MARGIN (dB)	ANTENNA HEIGHT (m)	TABLE ANGLE (Degree)	RAW VALUE (dBuV)	CORRECTION FACTOR (dB/m)
1	*5240.00	109.8 PK			2.52 H	17	72.1	37.7
2	*5240.00	99.9 AV			2.52 H	17	62.2	37.7
3	5350.00	50.7 PK	74.0	-23.3	2.46 H	9	49.8	0.9
4	5350.00	37.7 AV	54.0	-16.3	2.46 H	9	36.8	0.9
5	#10480.00	53.9 PK	68.2	-14.3	2.44 H	206	40.2	13.7

ANTENNA POLARITY & TEST DISTANCE: VERTICAL AT 3 M								
NO.	FREQ. (MHz)	EMISSION LEVEL (dBuV/m)	LIMIT (dBuV/m)	MARGIN (dB)	ANTENNA HEIGHT (m)	TABLE ANGLE (Degree)	RAW VALUE (dBuV)	CORRECTION FACTOR (dB/m)
1	*5240.00	110.9 PK			1.15 V	182	73.2	37.7
2	*5240.00	100.9 AV			1.15 V	182	63.2	37.7
3	5350.00	51.7 PK	74.0	-22.3	1.24 V	163	50.8	0.9
4	5350.00	38.5 AV	54.0	-15.5	1.24 V	163	37.6	0.9
5	#10480.00	54.6 PK	68.2	-13.6	3.47 V	156	40.9	13.7

Remarks:

1. Emission Level(dBuV/m) = Raw Value(dBuV) + Correction Factor(dB/m)
2. Correction Factor(dB/m) = Antenna Factor(dB/m) + Cable Factor(dB) – Pre-Amplifier Factor(dB)
3. The other emission levels were very low against the limit
4. Margin value = Emission Level – Limit value
5. " * ": Fundamental frequency
6. " # ": The radiated frequency is out of the restricted band

CHANNEL	TX Channel 52	DETECTOR FUNCTION	Peak (PK) Average (AV)
FREQUENCY RANGE	1GHz ~ 40GHz		

ANTENNA POLARITY & TEST DISTANCE: HORIZONTAL AT 3 M								
NO.	FREQ. (MHz)	EMISSION LEVEL (dBuV/m)	LIMIT (dBuV/m)	MARGIN (dB)	ANTENNA HEIGHT (m)	TABLE ANGLE (Degree)	RAW VALUE (dBuV)	CORRECTION FACTOR (dB/m)
1	5150.00	51.3 PK	74.0	-22.7	2.41 H	15	50.2	1.1
2	5150.00	38.0 AV	54.0	-16.0	2.41 H	15	36.9	1.1
3	*5260.00	109.2 PK			2.33 H	21	71.6	37.6
4	*5260.00	98.8 AV			2.33 H	21	61.2	37.6
5	#10520.00	53.5 PK	68.2	-14.7	2.55 H	217	39.8	13.7

ANTENNA POLARITY & TEST DISTANCE: VERTICAL AT 3 M								
NO.	FREQ. (MHz)	EMISSION LEVEL (dBuV/m)	LIMIT (dBuV/m)	MARGIN (dB)	ANTENNA HEIGHT (m)	TABLE ANGLE (Degree)	RAW VALUE (dBuV)	CORRECTION FACTOR (dB/m)
1	5150.00	51.9 PK	74.0	-22.1	1.29 V	201	50.8	1.1
2	5150.00	38.3 AV	54.0	-15.7	1.29 V	201	37.2	1.1
3	*5260.00	110.8 PK			1.25 V	180	73.2	37.6
4	*5260.00	100.3 AV			1.25 V	180	62.7	37.6
5	#10520.00	54.5 PK	68.2	-13.7	3.23 V	148	40.8	13.7

Remarks:

1. Emission Level(dBuV/m) = Raw Value(dBuV) + Correction Factor(dB/m)
2. Correction Factor(dB/m) = Antenna Factor(dB/m) + Cable Factor(dB) – Pre-Amplifier Factor(dB)
3. The other emission levels were very low against the limit
4. Margin value = Emission Level – Limit value
5. " * ": Fundamental frequency
6. " # ": The radiated frequency is out of the restricted band

CHANNEL	TX Channel 60	DETECTOR FUNCTION	Peak (PK) Average (AV)
FREQUENCY RANGE	1GHz ~ 40GHz		

ANTENNA POLARITY & TEST DISTANCE: HORIZONTAL AT 3 M

NO.	FREQ. (MHz)	EMISSION LEVEL (dBuV/m)	LIMIT (dBuV/m)	MARGIN (dB)	ANTENNA HEIGHT (m)	TABLE ANGLE (Degree)	RAW VALUE (dBuV)	CORRECTION FACTOR (dB/m)
1	*5300.00	108.1 PK			2.41 H	20	70.5	37.6
2	*5300.00	98.0 AV			2.41 H	20	60.4	37.6
3	10600.00	54.2 PK	74.0	-19.8	2.55 H	227	40.3	13.9
4	10600.00	41.3 AV	54.0	-12.7	2.55 H	227	27.4	13.9

ANTENNA POLARITY & TEST DISTANCE: VERTICAL AT 3 M

NO.	FREQ. (MHz)	EMISSION LEVEL (dBuV/m)	LIMIT (dBuV/m)	MARGIN (dB)	ANTENNA HEIGHT (m)	TABLE ANGLE (Degree)	RAW VALUE (dBuV)	CORRECTION FACTOR (dB/m)
1	*5300.00	110.2 PK			1.39 V	180	72.6	37.6
2	*5300.00	100.1 AV			1.39 V	180	62.5	37.6
3	10600.00	55.1 PK	74.0	-18.9	3.27 V	138	41.2	13.9
4	10600.00	41.7 AV	54.0	-12.3	3.27 V	138	27.8	13.9

Remarks:

1. Emission Level(dBuV/m) = Raw Value(dBuV) + Correction Factor(dB/m)
2. Correction Factor(dB/m) = Antenna Factor(dB/m) + Cable Factor(dB) – Pre-Amplifier Factor(dB)
3. The other emission levels were very low against the limit
4. Margin value = Emission Level – Limit value
5. " * ": Fundamental frequency

CHANNEL	TX Channel 64	DETECTOR FUNCTION	Peak (PK) Average (AV)
FREQUENCY RANGE	1GHz ~ 40GHz		

ANTENNA POLARITY & TEST DISTANCE: HORIZONTAL AT 3 M								
NO.	FREQ. (MHz)	EMISSION LEVEL (dBuV/m)	LIMIT (dBuV/m)	MARGIN (dB)	ANTENNA HEIGHT (m)	TABLE ANGLE (Degree)	RAW VALUE (dBuV)	CORRECTION FACTOR (dB/m)
1	*5320.00	107.1 PK			2.36 H	19	69.4	37.7
2	*5320.00	97.0 AV			2.36 H	19	59.3	37.7
3	5350.00	61.3 PK	74.0	-12.7	2.48 H	22	60.4	0.9
4	5350.00	50.7 AV	54.0	-3.3	2.48 H	22	49.8	0.9
5	10640.00	54.4 PK	74.0	-19.6	2.67 H	211	40.4	14.0
6	10640.00	41.3 AV	54.0	-12.7	2.67 H	211	27.3	14.0

ANTENNA POLARITY & TEST DISTANCE: VERTICAL AT 3 M								
NO.	FREQ. (MHz)	EMISSION LEVEL (dBuV/m)	LIMIT (dBuV/m)	MARGIN (dB)	ANTENNA HEIGHT (m)	TABLE ANGLE (Degree)	RAW VALUE (dBuV)	CORRECTION FACTOR (dB/m)
1	*5320.00	109.0 PK			1.20 V	180	71.3	37.7
2	*5320.00	98.9 AV			1.20 V	180	61.2	37.7
3	5350.00	63.1 PK	74.0	-10.9	1.45 V	179	62.2	0.9
4	5350.00	52.6 AV	54.0	-1.4	1.45 V	179	51.7	0.9
5	10640.00	55.3 PK	74.0	-18.7	3.23 V	166	41.3	14.0
6	10640.00	42.1 AV	54.0	-11.9	3.23 V	166	28.1	14.0

Remarks:

1. Emission Level(dBuV/m) = Raw Value(dBuV) + Correction Factor(dB/m)
2. Correction Factor(dB/m) = Antenna Factor(dB/m) + Cable Factor(dB) – Pre-Amplifier Factor(dB)
3. The other emission levels were very low against the limit
4. Margin value = Emission Level – Limit value
5. " * ": Fundamental frequency

CHANNEL	TX Channel 100	DETECTOR FUNCTION	Peak (PK) Average (AV)
FREQUENCY RANGE	1GHz ~ 40GHz		

ANTENNA POLARITY & TEST DISTANCE: HORIZONTAL AT 3 M								
NO.	FREQ. (MHz)	EMISSION LEVEL (dBuV/m)	LIMIT (dBuV/m)	MARGIN (dB)	ANTENNA HEIGHT (m)	TABLE ANGLE (Degree)	RAW VALUE (dBuV)	CORRECTION FACTOR (dB/m)
1	5460.00	62.9 PK	74.0	-11.1	1.97 H	201	61.6	1.3
2	5460.00	45.8 AV	54.0	-8.2	1.97 H	201	44.5	1.3
3	#5470.00	64.4 PK	68.2	-3.8	2.01 H	199	63.1	1.3
4	*5500.00	110.6 PK			2.05 H	210	72.4	38.2
5	*5500.00	99.4 AV			2.05 H	210	61.2	38.2
6	11000.00	54.1 PK	74.0	-19.9	1.32 H	186	38.8	15.3
7	11000.00	42.7 AV	54.0	-11.3	1.32 H	186	27.4	15.3

ANTENNA POLARITY & TEST DISTANCE: VERTICAL AT 3 M								
NO.	FREQ. (MHz)	EMISSION LEVEL (dBuV/m)	LIMIT (dBuV/m)	MARGIN (dB)	ANTENNA HEIGHT (m)	TABLE ANGLE (Degree)	RAW VALUE (dBuV)	CORRECTION FACTOR (dB/m)
1	5460.00	62.2 PK	74.0	-11.8	1.05 V	193	60.9	1.3
2	5460.00	48.1 AV	54.0	-5.9	1.05 V	193	46.8	1.3
3	#5470.00	67.0 PK	68.2	-1.2	1.04 V	195	65.7	1.3
4	*5500.00	109.9 PK			1.14 V	191	71.7	38.2
5	*5500.00	98.8 AV			1.14 V	191	60.6	38.2
6	11000.00	53.5 PK	74.0	-20.5	1.22 V	193	38.2	15.3
7	11000.00	42.4 AV	54.0	-11.6	1.22 V	193	27.1	15.3

Remarks:

1. Emission Level(dBuV/m) = Raw Value(dBuV) + Correction Factor(dB/m)
2. Correction Factor(dB/m) = Antenna Factor(dB/m) + Cable Factor(dB) – Pre-Amplifier Factor(dB)
3. The other emission levels were very low against the limit
4. Margin value = Emission Level – Limit value
5. " * ": Fundamental frequency
6. " # ": The radiated frequency is out of the restricted band

CHANNEL	TX Channel 116	DETECTOR FUNCTION	Peak (PK) Average (AV)
FREQUENCY RANGE	1GHz ~ 40GHz		

ANTENNA POLARITY & TEST DISTANCE: HORIZONTAL AT 3 M

NO.	FREQ. (MHz)	EMISSION LEVEL (dBuV/m)	LIMIT (dBuV/m)	MARGIN (dB)	ANTENNA HEIGHT (m)	TABLE ANGLE (Degree)	RAW VALUE (dBuV)	CORRECTION FACTOR (dB/m)
1	*5580.00	111.7 PK			1.66 H	210	73.5	38.2
2	*5580.00	100.2 AV			1.66 H	210	62.0	38.2
3	11160.00	52.0 PK	74.0	-22.0	1.27 H	195	37.3	14.7
4	11160.00	41.8 AV	54.0	-12.2	1.27 H	195	27.1	14.7

ANTENNA POLARITY & TEST DISTANCE: VERTICAL AT 3 M

NO.	FREQ. (MHz)	EMISSION LEVEL (dBuV/m)	LIMIT (dBuV/m)	MARGIN (dB)	ANTENNA HEIGHT (m)	TABLE ANGLE (Degree)	RAW VALUE (dBuV)	CORRECTION FACTOR (dB/m)
1	*5580.00	109.7 PK			1.00 V	200	71.5	38.2
2	*5580.00	98.0 AV			1.00 V	200	59.8	38.2
3	11160.00	52.2 PK	74.0	-21.8	1.33 V	189	37.5	14.7
4	11160.00	42.2 AV	54.0	-11.8	1.33 V	189	27.5	14.7

Remarks:

1. Emission Level(dBuV/m) = Raw Value(dBuV) + Correction Factor(dB/m)
2. Correction Factor(dB/m) = Antenna Factor(dB/m) + Cable Factor(dB) – Pre-Amplifier Factor(dB)
3. The other emission levels were very low against the limit
4. Margin value = Emission Level – Limit value
5. " * ": Fundamental frequency

CHANNEL	TX Channel 140	DETECTOR FUNCTION	Peak (PK) Average (AV)
FREQUENCY RANGE	1GHz ~ 40GHz		

ANTENNA POLARITY & TEST DISTANCE: HORIZONTAL AT 3 M								
NO.	FREQ. (MHz)	EMISSION LEVEL (dBuV/m)	LIMIT (dBuV/m)	MARGIN (dB)	ANTENNA HEIGHT (m)	TABLE ANGLE (Degree)	RAW VALUE (dBuV)	CORRECTION FACTOR (dB/m)
1	*5700.00	111.7 PK			1.65 H	204	73.3	38.4
2	*5700.00	100.0 AV			1.65 H	204	61.6	38.4
3	#5725.00	66.9 PK	68.2	-1.3	1.63 H	201	65.3	1.6
4	11400.00	51.5 PK	74.0	-22.5	1.32 H	191	36.9	14.6
5	11400.00	41.1 AV	54.0	-12.9	1.32 H	191	26.5	14.6

ANTENNA POLARITY & TEST DISTANCE: VERTICAL AT 3 M								
NO.	FREQ. (MHz)	EMISSION LEVEL (dBuV/m)	LIMIT (dBuV/m)	MARGIN (dB)	ANTENNA HEIGHT (m)	TABLE ANGLE (Degree)	RAW VALUE (dBuV)	CORRECTION FACTOR (dB/m)
1	*5700.00	111.9 PK			1.08 V	200	73.5	38.4
2	*5700.00	100.2 AV			1.08 V	200	61.8	38.4
3	#5725.00	67.3 PK	68.2	-0.9	1.10 V	198	65.7	1.6
4	11400.00	52.3 PK	74.0	-21.7	1.29 V	184	37.7	14.6
5	11400.00	41.2 AV	54.0	-12.8	1.29 V	184	26.6	14.6

Remarks:

1. Emission Level(dBuV/m) = Raw Value(dBuV) + Correction Factor(dB/m)
2. Correction Factor(dB/m) = Antenna Factor(dB/m) + Cable Factor(dB) – Pre-Amplifier Factor(dB)
3. The other emission levels were very low against the limit
4. Margin value = Emission Level – Limit value
5. " * ": Fundamental frequency
6. " # ": The radiated frequency is out of the restricted band

CHANNEL	TX Channel 149	DETECTOR FUNCTION	Peak (PK) Average (AV)
FREQUENCY RANGE	1GHz ~ 40GHz		

ANTENNA POLARITY & TEST DISTANCE: HORIZONTAL AT 3 M

NO.	FREQ. (MHz)	EMISSION LEVEL (dBuV/m)	LIMIT (dBuV/m)	MARGIN (dB)	ANTENNA HEIGHT (m)	TABLE ANGLE (Degree)	RAW VALUE (dBuV)	CORRECTION FACTOR (dB/m)
1	#5639.20	51.4 PK	68.2	-16.8	1.23 H	115	49.9	1.5
2	*5745.00	110.2 PK			1.91 H	356	71.7	38.5
3	*5745.00	99.4 AV			1.91 H	356	60.9	38.5
4	#5933.60	51.9 PK	68.2	-16.3	1.07 H	306	49.5	2.4
5	11490.00	54.9 PK	74.0	-19.1	1.85 H	269	41.0	13.9
6	11490.00	40.9 AV	54.0	-13.1	1.85 H	269	27.0	13.9

ANTENNA POLARITY & TEST DISTANCE: VERTICAL AT 3 M

NO.	FREQ. (MHz)	EMISSION LEVEL (dBuV/m)	LIMIT (dBuV/m)	MARGIN (dB)	ANTENNA HEIGHT (m)	TABLE ANGLE (Degree)	RAW VALUE (dBuV)	CORRECTION FACTOR (dB/m)
1	#5635.20	50.9 PK	68.2	-17.3	1.08 V	147	49.4	1.5
2	*5745.00	112.0 PK			1.85 V	360	73.5	38.5
3	*5745.00	101.2 AV			1.85 V	360	62.7	38.5
4	#5939.20	50.9 PK	68.2	-17.3	1.13 V	332	48.5	2.4
5	11490.00	54.5 PK	74.0	-19.5	1.84 V	360	40.6	13.9
6	11490.00	41.4 AV	54.0	-12.6	1.84 V	360	27.5	13.9

Remarks:

1. Emission Level(dBuV/m) = Raw Value(dBuV) + Correction Factor(dB/m)
2. Correction Factor(dB/m) = Antenna Factor(dB/m) + Cable Factor(dB) – Pre-Amplifier Factor(dB)
3. The other emission levels were very low against the limit
4. Margin value = Emission Level – Limit value
5. " * ": Fundamental frequency
6. " # ": The radiated frequency is out of the restricted band

CHANNEL	TX Channel 157	DETECTOR FUNCTION	Peak (PK) Average (AV)
FREQUENCY RANGE	1GHz ~ 40GHz		

ANTENNA POLARITY & TEST DISTANCE: HORIZONTAL AT 3 M

NO.	FREQ. (MHz)	EMISSION LEVEL (dBuV/m)	LIMIT (dBuV/m)	MARGIN (dB)	ANTENNA HEIGHT (m)	TABLE ANGLE (Degree)	RAW VALUE (dBuV)	CORRECTION FACTOR (dB/m)
1	#5624.80	50.1 PK	68.2	-18.1	1.38 H	221	48.7	1.4
2	*5785.00	108.1 PK			1.98 H	266	69.4	38.7
3	*5785.00	97.0 AV			1.98 H	266	58.3	38.7
4	#5955.20	51.6 PK	68.2	-16.6	1.19 H	177	49.2	2.4
5	11750.00	52.9 PK	74.0	-21.1	1.51 H	217	39.3	13.6
6	11750.00	40.7 AV	54.0	-13.3	1.51 H	217	27.1	13.6

ANTENNA POLARITY & TEST DISTANCE: VERTICAL AT 3 M

NO.	FREQ. (MHz)	EMISSION LEVEL (dBuV/m)	LIMIT (dBuV/m)	MARGIN (dB)	ANTENNA HEIGHT (m)	TABLE ANGLE (Degree)	RAW VALUE (dBuV)	CORRECTION FACTOR (dB/m)
1	#5646.40	50.5 PK	68.2	-17.7	1.36 V	208	48.9	1.6
2	*5785.00	111.9 PK			1.82 V	360	73.2	38.7
3	*5785.00	101.6 AV			1.82 V	360	62.9	38.7
4	#5947.20	51.2 PK	68.2	-17.0	1.78 V	111	48.8	2.4
5	11750.00	52.7 PK	74.0	-21.3	1.77 V	360	39.1	13.6
6	11750.00	40.3 AV	54.0	-13.7	1.77 V	360	26.7	13.6

Remarks:

1. Emission Level(dBuV/m) = Raw Value(dBuV) + Correction Factor(dB/m)
2. Correction Factor(dB/m) = Antenna Factor(dB/m) + Cable Factor(dB) – Pre-Amplifier Factor(dB)
3. The other emission levels were very low against the limit
4. Margin value = Emission Level – Limit value
5. " * ": Fundamental frequency
6. " # ": The radiated frequency is out of the restricted band

CHANNEL	TX Channel 165	DETECTOR FUNCTION	Peak (PK) Average (AV)
FREQUENCY RANGE	1GHz ~ 40GHz		

ANTENNA POLARITY & TEST DISTANCE: HORIZONTAL AT 3 M

NO.	FREQ. (MHz)	EMISSION LEVEL (dBuV/m)	LIMIT (dBuV/m)	MARGIN (dB)	ANTENNA HEIGHT (m)	TABLE ANGLE (Degree)	RAW VALUE (dBuV)	CORRECTION FACTOR (dB/m)
1	#5624.00	50.1 PK	68.2	-18.1	1.33 H	229	48.7	1.4
2	*5825.00	109.6 PK			1.96 H	335	70.8	38.8
3	*5825.00	99.6 AV			1.96 H	335	60.8	38.8
4	#5960.00	52.0 PK	68.2	-16.2	1.04 H	158	49.5	2.5
5	11650.00	53.8 PK	74.0	-20.2	1.62 H	117	40.0	13.8
6	11650.00	42.0 AV	54.0	-12.0	1.62 H	117	28.2	13.8

ANTENNA POLARITY & TEST DISTANCE: VERTICAL AT 3 M

NO.	FREQ. (MHz)	EMISSION LEVEL (dBuV/m)	LIMIT (dBuV/m)	MARGIN (dB)	ANTENNA HEIGHT (m)	TABLE ANGLE (Degree)	RAW VALUE (dBuV)	CORRECTION FACTOR (dB/m)
1	#5639.20	50.6 PK	68.2	-17.6	1.05 V	221	49.1	1.5
2	*5825.00	110.5 PK			1.33 V	360	71.7	38.8
3	*5825.00	100.2 AV			1.33 V	360	61.4	38.8
4	#5949.60	51.6 PK	68.2	-16.6	1.78 V	334	49.2	2.4
5	11650.00	53.2 PK	74.0	-20.8	1.30 V	360	39.4	13.8
6	11650.00	41.6 AV	54.0	-12.4	1.30 V	360	27.8	13.8

Remarks:

1. Emission Level(dBuV/m) = Raw Value(dBuV) + Correction Factor(dB/m)
2. Correction Factor(dB/m) = Antenna Factor(dB/m) + Cable Factor(dB) – Pre-Amplifier Factor(dB)
3. The other emission levels were very low against the limit
4. Margin value = Emission Level – Limit value
5. " * ": Fundamental frequency
6. " # ": The radiated frequency is out of the restricted band

802.11n (HT20)

CHANNEL	TX Channel 36	DETECTOR FUNCTION	Peak (PK) Average (AV)
FREQUENCY RANGE	1GHz ~ 40GHz		

ANTENNA POLARITY & TEST DISTANCE: HORIZONTAL AT 3 M								
NO.	FREQ. (MHz)	EMISSION LEVEL (dBuV/m)	LIMIT (dBuV/m)	MARGIN (dB)	ANTENNA HEIGHT (m)	TABLE ANGLE (Degree)	RAW VALUE (dBuV)	CORRECTION FACTOR (dB/m)
1	5150.00	58.7 PK	74.0	-15.3	2.57 H	18	57.6	1.1
2	5150.00	45.9 AV	54.0	-8.1	2.57 H	18	44.8	1.1
3	*5180.00	108.1 PK			2.63 H	12	70.1	38.0
4	*5180.00	97.5 AV			2.63 H	12	59.5	38.0
5	#10360.00	54.0 PK	68.2	-14.2	2.51 H	208	40.4	13.6

ANTENNA POLARITY & TEST DISTANCE: VERTICAL AT 3 M								
NO.	FREQ. (MHz)	EMISSION LEVEL (dBuV/m)	LIMIT (dBuV/m)	MARGIN (dB)	ANTENNA HEIGHT (m)	TABLE ANGLE (Degree)	RAW VALUE (dBuV)	CORRECTION FACTOR (dB/m)
1	5150.00	61.6 PK	74.0	-12.4	1.28 V	181	60.5	1.1
2	5150.00	48.3 AV	54.0	-5.7	1.28 V	181	47.2	1.1
3	*5180.00	110.6 PK			1.26 V	182	72.6	38.0
4	*5180.00	99.9 AV			1.26 V	182	61.9	38.0
5	#10360.00	54.4 PK	68.2	-13.8	3.19 V	143	40.8	13.6

Remarks:

1. Emission Level(dBuV/m) = Raw Value(dBuV) + Correction Factor(dB/m)
2. Correction Factor(dB/m) = Antenna Factor(dB/m) + Cable Factor(dB) – Pre-Amplifier Factor(dB)
3. The other emission levels were very low against the limit
4. Margin value = Emission Level – Limit value
5. " * ": Fundamental frequency
6. " # ": The radiated frequency is out of the restricted band

CHANNEL	TX Channel 40	DETECTOR FUNCTION	Peak (PK) Average (AV)
FREQUENCY RANGE	1GHz ~ 40GHz		

ANTENNA POLARITY & TEST DISTANCE: HORIZONTAL AT 3 M

NO.	FREQ. (MHz)	EMISSION LEVEL (dBuV/m)	LIMIT (dBuV/m)	MARGIN (dB)	ANTENNA HEIGHT (m)	TABLE ANGLE (Degree)	RAW VALUE (dBuV)	CORRECTION FACTOR (dB/m)
1	*5200.00	107.7 PK			2.58 H	17	69.8	37.9
2	*5200.00	97.2 AV			2.58 H	17	59.3	37.9
3	#10400.00	54.2 PK	68.2	-14.0	2.45 H	211	40.4	13.8

ANTENNA POLARITY & TEST DISTANCE: VERTICAL AT 3 M

NO.	FREQ. (MHz)	EMISSION LEVEL (dBuV/m)	LIMIT (dBuV/m)	MARGIN (dB)	ANTENNA HEIGHT (m)	TABLE ANGLE (Degree)	RAW VALUE (dBuV)	CORRECTION FACTOR (dB/m)
1	*5200.00	110.3 PK			1.16 V	181	72.4	37.9
2	*5200.00	99.7 AV			1.16 V	181	61.8	37.9
3	#10400.00	55.0 PK	68.2	-13.2	3.34 V	159	41.2	13.8

Remarks:

1. Emission Level(dBuV/m) = Raw Value(dBuV) + Correction Factor(dB/m)
2. Correction Factor(dB/m) = Antenna Factor(dB/m) + Cable Factor(dB) – Pre-Amplifier Factor(dB)
3. The other emission levels were very low against the limit
4. Margin value = Emission Level – Limit value
5. " * ": Fundamental frequency
6. " # ": The radiated frequency is out of the restricted band

CHANNEL	TX Channel 48	DETECTOR FUNCTION	Peak (PK) Average (AV)
FREQUENCY RANGE	1GHz ~ 40GHz		

ANTENNA POLARITY & TEST DISTANCE: HORIZONTAL AT 3 M								
NO.	FREQ. (MHz)	EMISSION LEVEL (dBuV/m)	LIMIT (dBuV/m)	MARGIN (dB)	ANTENNA HEIGHT (m)	TABLE ANGLE (Degree)	RAW VALUE (dBuV)	CORRECTION FACTOR (dB/m)
1	*5240.00	108.2 PK			2.61 H	17	70.5	37.7
2	*5240.00	97.9 AV			2.61 H	17	60.2	37.7
3	5350.00	51.1 PK	74.0	-22.9	2.54 H	14	50.2	0.9
4	5350.00	38.0 AV	54.0	-16.0	2.54 H	14	37.1	0.9
5	#10480.00	54.0 PK	68.2	-14.2	2.37 H	216	40.3	13.7

ANTENNA POLARITY & TEST DISTANCE: VERTICAL AT 3 M								
NO.	FREQ. (MHz)	EMISSION LEVEL (dBuV/m)	LIMIT (dBuV/m)	MARGIN (dB)	ANTENNA HEIGHT (m)	TABLE ANGLE (Degree)	RAW VALUE (dBuV)	CORRECTION FACTOR (dB/m)
1	*5240.00	110.6 PK			1.15 V	180	72.9	37.7
2	*5240.00	100.2 AV			1.15 V	180	62.5	37.7
3	5350.00	51.3 PK	74.0	-22.7	1.21 V	173	50.4	0.9
4	5350.00	38.7 AV	54.0	-15.3	1.21 V	173	37.8	0.9
5	#10480.00	54.7 PK	68.2	-13.5	3.09 V	128	41.0	13.7

Remarks:

1. Emission Level(dBuV/m) = Raw Value(dBuV) + Correction Factor(dB/m)
2. Correction Factor(dB/m) = Antenna Factor(dB/m) + Cable Factor(dB) – Pre-Amplifier Factor(dB)
3. The other emission levels were very low against the limit
4. Margin value = Emission Level – Limit value
5. " * ": Fundamental frequency
6. " # ": The radiated frequency is out of the restricted band

CHANNEL	TX Channel 52	DETECTOR FUNCTION	Peak (PK) Average (AV)
FREQUENCY RANGE	1GHz ~ 40GHz		

ANTENNA POLARITY & TEST DISTANCE: HORIZONTAL AT 3 M

NO.	FREQ. (MHz)	EMISSION LEVEL (dBuV/m)	LIMIT (dBuV/m)	MARGIN (dB)	ANTENNA HEIGHT (m)	TABLE ANGLE (Degree)	RAW VALUE (dBuV)	CORRECTION FACTOR (dB/m)
1	5150.00	51.4 PK	74.0	-22.6	2.47 H	9	50.3	1.1
2	5150.00	38.2 AV	54.0	-15.8	2.47 H	9	37.1	1.1
3	*5260.00	107.5 PK			2.38 H	18	69.9	37.6
4	*5260.00	97.4 AV			2.38 H	18	59.8	37.6
5	#10520.00	53.8 PK	68.2	-14.4	2.43 H	204	40.1	13.7

ANTENNA POLARITY & TEST DISTANCE: VERTICAL AT 3 M

NO.	FREQ. (MHz)	EMISSION LEVEL (dBuV/m)	LIMIT (dBuV/m)	MARGIN (dB)	ANTENNA HEIGHT (m)	TABLE ANGLE (Degree)	RAW VALUE (dBuV)	CORRECTION FACTOR (dB/m)
1	5150.00	51.9 PK	74.0	-22.1	1.27 V	176	50.8	1.1
2	5150.00	38.7 AV	54.0	-15.3	1.27 V	176	37.6	1.1
3	*5260.00	110.8 PK			1.22 V	183	73.2	37.6
4	*5260.00	99.7 AV			1.22 V	183	62.1	37.6
5	#10520.00	54.6 PK	68.2	-13.6	3.37 V	212	40.9	13.7

Remarks:

1. Emission Level(dBuV/m) = Raw Value(dBuV) + Correction Factor(dB/m)
2. Correction Factor(dB/m) = Antenna Factor(dB/m) + Cable Factor(dB) – Pre-Amplifier Factor(dB)
3. The other emission levels were very low against the limit
4. Margin value = Emission Level – Limit value
5. " * ": Fundamental frequency
6. " # ": The radiated frequency is out of the restricted band

CHANNEL	TX Channel 60	DETECTOR FUNCTION	Peak (PK) Average (AV)
FREQUENCY RANGE	1GHz ~ 40GHz		

ANTENNA POLARITY & TEST DISTANCE: HORIZONTAL AT 3 M

NO.	FREQ. (MHz)	EMISSION LEVEL (dBuV/m)	LIMIT (dBuV/m)	MARGIN (dB)	ANTENNA HEIGHT (m)	TABLE ANGLE (Degree)	RAW VALUE (dBuV)	CORRECTION FACTOR (dB/m)
1	*5300.00	107.2 PK			2.44 H	19	69.6	37.6
2	*5300.00	97.1 AV			2.44 H	19	59.5	37.6
3	10600.00	54.3 PK	74.0	-19.7	2.49 H	218	40.4	13.9
4	10600.00	41.2 AV	54.0	-12.8	2.49 H	218	27.3	13.9

ANTENNA POLARITY & TEST DISTANCE: VERTICAL AT 3 M

NO.	FREQ. (MHz)	EMISSION LEVEL (dBuV/m)	LIMIT (dBuV/m)	MARGIN (dB)	ANTENNA HEIGHT (m)	TABLE ANGLE (Degree)	RAW VALUE (dBuV)	CORRECTION FACTOR (dB/m)
1	*5300.00	109.9 PK			1.54 V	183	72.3	37.6
2	*5300.00	99.2 AV			1.54 V	183	61.6	37.6
3	10600.00	55.1 PK	74.0	-18.9	3.46 V	152	41.2	13.9
4	10600.00	41.7 AV	54.0	-12.3	3.46 V	152	27.8	13.9

Remarks:

1. Emission Level(dBuV/m) = Raw Value(dBuV) + Correction Factor(dB/m)
2. Correction Factor(dB/m) = Antenna Factor(dB/m) + Cable Factor(dB) – Pre-Amplifier Factor(dB)
3. The other emission levels were very low against the limit
4. Margin value = Emission Level – Limit value
5. " * ": Fundamental frequency

CHANNEL	TX Channel 64	DETECTOR FUNCTION	Peak (PK) Average (AV)
FREQUENCY RANGE	1GHz ~ 40GHz		

ANTENNA POLARITY & TEST DISTANCE: HORIZONTAL AT 3 M

NO.	FREQ. (MHz)	EMISSION LEVEL (dBuV/m)	LIMIT (dBuV/m)	MARGIN (dB)	ANTENNA HEIGHT (m)	TABLE ANGLE (Degree)	RAW VALUE (dBuV)	CORRECTION FACTOR (dB/m)
1	*5320.00	106.3 PK			2.43 H	15	68.6	37.7
2	*5320.00	96.1 AV			2.43 H	15	58.4	37.7
3	5350.00	62.8 PK	74.0	-11.2	2.52 H	19	61.9	0.9
4	5350.00	50.8 AV	54.0	-3.2	2.52 H	19	49.9	0.9
5	10640.00	54.3 PK	74.0	-19.7	2.62 H	219	40.3	14.0
6	10640.00	40.6 AV	54.0	-13.4	2.62 H	219	26.6	14.0

ANTENNA POLARITY & TEST DISTANCE: VERTICAL AT 3 M

NO.	FREQ. (MHz)	EMISSION LEVEL (dBuV/m)	LIMIT (dBuV/m)	MARGIN (dB)	ANTENNA HEIGHT (m)	TABLE ANGLE (Degree)	RAW VALUE (dBuV)	CORRECTION FACTOR (dB/m)
1	*5320.00	108.8 PK			1.49 V	184	71.1	37.7
2	*5320.00	98.3 AV			1.49 V	184	60.6	37.7
3	5350.00	65.1 PK	74.0	-8.9	1.53 V	181	64.2	0.9
4	5350.00	52.7 AV	54.0	-1.3	1.53 V	181	51.8	0.9
5	10640.00	54.8 PK	74.0	-19.2	3.36 V	167	40.8	14.0
6	10640.00	40.9 AV	54.0	-13.1	3.36 V	167	26.9	14.0

Remarks:

1. Emission Level(dBuV/m) = Raw Value(dBuV) + Correction Factor(dB/m)
2. Correction Factor(dB/m) = Antenna Factor(dB/m) + Cable Factor(dB) – Pre-Amplifier Factor(dB)
3. The other emission levels were very low against the limit
4. Margin value = Emission Level – Limit value
5. " * ": Fundamental frequency

CHANNEL	TX Channel 100	DETECTOR FUNCTION	Peak (PK) Average (AV)
FREQUENCY RANGE	1GHz ~ 40GHz		

ANTENNA POLARITY & TEST DISTANCE: HORIZONTAL AT 3 M

NO.	FREQ. (MHz)	EMISSION LEVEL (dBuV/m)	LIMIT (dBuV/m)	MARGIN (dB)	ANTENNA HEIGHT (m)	TABLE ANGLE (Degree)	RAW VALUE (dBuV)	CORRECTION FACTOR (dB/m)
1	5460.00	61.8 PK	74.0	-12.2	1.99 H	172	60.5	1.3
2	5460.00	45.8 AV	54.0	-8.2	1.99 H	172	44.5	1.3
3	#5470.00	65.5 PK	68.2	-2.7	2.10 H	172	64.2	1.3
4	*5500.00	109.5 PK			2.19 H	176	71.3	38.2
5	*5500.00	97.7 AV			2.19 H	176	59.5	38.2
6	11000.00	52.6 PK	74.0	-21.4	1.21 H	182	37.3	15.3
7	11000.00	41.8 AV	54.0	-12.2	1.21 H	182	26.5	15.3

ANTENNA POLARITY & TEST DISTANCE: VERTICAL AT 3 M

NO.	FREQ. (MHz)	EMISSION LEVEL (dBuV/m)	LIMIT (dBuV/m)	MARGIN (dB)	ANTENNA HEIGHT (m)	TABLE ANGLE (Degree)	RAW VALUE (dBuV)	CORRECTION FACTOR (dB/m)
1	5460.00	61.1 PK	74.0	-12.9	1.08 V	196	59.8	1.3
2	5460.00	47.7 AV	54.0	-6.3	1.08 V	196	46.4	1.3
3	#5470.00	66.7 PK	68.2	-1.5	1.06 V	193	65.4	1.3
4	*5500.00	109.4 PK			1.10 V	199	71.2	38.2
5	*5500.00	98.6 AV			1.10 V	199	60.4	38.2
6	11000.00	53.1 PK	74.0	-20.9	1.23 V	186	37.8	15.3
7	11000.00	42.1 AV	54.0	-11.9	1.23 V	186	26.8	15.3

Remarks:

1. Emission Level(dBuV/m) = Raw Value(dBuV) + Correction Factor(dB/m)
2. Correction Factor(dB/m) = Antenna Factor(dB/m) + Cable Factor(dB) – Pre-Amplifier Factor(dB)
3. The other emission levels were very low against the limit
4. Margin value = Emission Level – Limit value
5. " * ": Fundamental frequency
6. " # ": The radiated frequency is out of the restricted band

CHANNEL	TX Channel 116	DETECTOR FUNCTION	Peak (PK) Average (AV)
FREQUENCY RANGE	1GHz ~ 40GHz		

ANTENNA POLARITY & TEST DISTANCE: HORIZONTAL AT 3 M

NO.	FREQ. (MHz)	EMISSION LEVEL (dBuV/m)	LIMIT (dBuV/m)	MARGIN (dB)	ANTENNA HEIGHT (m)	TABLE ANGLE (Degree)	RAW VALUE (dBuV)	CORRECTION FACTOR (dB/m)
1	*5580.00	111.5 PK			1.67 H	210	73.3	38.2
2	*5580.00	99.7 AV			1.67 H	210	61.5	38.2
3	11160.00	52.3 PK	74.0	-21.7	1.71 H	196	37.6	14.7
4	11160.00	41.9 AV	54.0	-12.1	1.71 H	196	27.2	14.7

ANTENNA POLARITY & TEST DISTANCE: VERTICAL AT 3 M

NO.	FREQ. (MHz)	EMISSION LEVEL (dBuV/m)	LIMIT (dBuV/m)	MARGIN (dB)	ANTENNA HEIGHT (m)	TABLE ANGLE (Degree)	RAW VALUE (dBuV)	CORRECTION FACTOR (dB/m)
1	*5580.00	109.0 PK			1.13 V	197	70.8	38.2
2	*5580.00	97.3 AV			1.13 V	197	59.1	38.2
3	11160.00	52.8 PK	74.0	-21.2	1.37 V	182	38.1	14.7
4	11160.00	42.4 AV	54.0	-11.6	1.37 V	182	27.7	14.7

Remarks:

1. Emission Level(dBuV/m) = Raw Value(dBuV) + Correction Factor(dB/m)
2. Correction Factor(dB/m) = Antenna Factor(dB/m) + Cable Factor(dB) – Pre-Amplifier Factor(dB)
3. The other emission levels were very low against the limit
4. Margin value = Emission Level – Limit value
5. " * ": Fundamental frequency

CHANNEL	TX Channel 140	DETECTOR FUNCTION	Peak (PK) Average (AV)
FREQUENCY RANGE	1GHz ~ 40GHz		

ANTENNA POLARITY & TEST DISTANCE: HORIZONTAL AT 3 M								
NO.	FREQ. (MHz)	EMISSION LEVEL (dBuV/m)	LIMIT (dBuV/m)	MARGIN (dB)	ANTENNA HEIGHT (m)	TABLE ANGLE (Degree)	RAW VALUE (dBuV)	CORRECTION FACTOR (dB/m)
1	*5700.00	111.5 PK			1.90 H	212	73.1	38.4
2	*5700.00	99.8 AV			1.90 H	212	61.4	38.4
3	#5725.00	66.9 PK	68.2	-1.3	1.88 H	207	65.3	1.6
4	11400.00	52.3 PK	74.0	-21.7	1.85 H	177	37.7	14.6
5	11400.00	41.4 AV	54.0	-12.6	1.85 H	177	26.8	14.6

ANTENNA POLARITY & TEST DISTANCE: VERTICAL AT 3 M								
NO.	FREQ. (MHz)	EMISSION LEVEL (dBuV/m)	LIMIT (dBuV/m)	MARGIN (dB)	ANTENNA HEIGHT (m)	TABLE ANGLE (Degree)	RAW VALUE (dBuV)	CORRECTION FACTOR (dB/m)
1	*5700.00	111.2 PK			1.09 V	197	72.8	38.4
2	*5700.00	99.5 AV			1.09 V	197	61.1	38.4
3	#5725.00	66.2 PK	68.2	-2.0	1.11 V	202	64.6	1.6
4	11400.00	52.7 PK	74.0	-21.3	1.24 V	184	38.1	14.6
5	11400.00	41.8 AV	54.0	-12.2	1.24 V	184	27.2	14.6

Remarks:

1. Emission Level(dBuV/m) = Raw Value(dBuV) + Correction Factor(dB/m)
2. Correction Factor(dB/m) = Antenna Factor(dB/m) + Cable Factor(dB) – Pre-Amplifier Factor(dB)
3. The other emission levels were very low against the limit
4. Margin value = Emission Level – Limit value
5. " * ": Fundamental frequency
6. " # ": The radiated frequency is out of the restricted band

CHANNEL	TX Channel 149	DETECTOR FUNCTION	Peak (PK) Average (AV)
FREQUENCY RANGE	1GHz ~ 40GHz		

ANTENNA POLARITY & TEST DISTANCE: HORIZONTAL AT 3 M

NO.	FREQ. (MHz)	EMISSION LEVEL (dBuV/m)	LIMIT (dBuV/m)	MARGIN (dB)	ANTENNA HEIGHT (m)	TABLE ANGLE (Degree)	RAW VALUE (dBuV)	CORRECTION FACTOR (dB/m)
1	#5613.60	51.8 PK	68.2	-16.4	1.39 H	204	50.4	1.4
2	*5745.00	111.6 PK			2.11 H	335	73.1	38.5
3	*5745.00	100.6 AV			2.11 H	335	62.1	38.5
4	#5956.80	52.0 PK	68.2	-16.2	1.44 H	39	49.6	2.4
5	11490.00	52.6 PK	74.0	-21.4	1.47 H	193	38.7	13.9
6	11490.00	41.5 AV	54.0	-12.5	1.47 H	193	27.6	13.9

ANTENNA POLARITY & TEST DISTANCE: VERTICAL AT 3 M

NO.	FREQ. (MHz)	EMISSION LEVEL (dBuV/m)	LIMIT (dBuV/m)	MARGIN (dB)	ANTENNA HEIGHT (m)	TABLE ANGLE (Degree)	RAW VALUE (dBuV)	CORRECTION FACTOR (dB/m)
1	#5629.60	50.4 PK	68.2	-17.8	1.71 V	306	49.0	1.4
2	*5745.00	111.6 PK			1.32 V	360	73.1	38.5
3	*5745.00	100.8 AV			1.32 V	360	62.3	38.5
4	#5952.00	51.6 PK	68.2	-16.6	2.05 V	199	49.2	2.4
5	11490.00	53.4 PK	74.0	-20.6	1.41 V	360	39.5	13.9
6	11490.00	41.8 AV	54.0	-12.2	1.41 V	360	27.9	13.9

Remarks:

1. Emission Level(dBuV/m) = Raw Value(dBuV) + Correction Factor(dB/m)
2. Correction Factor(dB/m) = Antenna Factor(dB/m) + Cable Factor(dB) – Pre-Amplifier Factor(dB)
3. The other emission levels were very low against the limit
4. Margin value = Emission Level – Limit value
5. " * ": Fundamental frequency
6. " # ": The radiated frequency is out of the restricted band

CHANNEL	TX Channel 157	DETECTOR FUNCTION	Peak (PK) Average (AV)
FREQUENCY RANGE	1GHz ~ 40GHz		

ANTENNA POLARITY & TEST DISTANCE: HORIZONTAL AT 3 M

NO.	FREQ. (MHz)	EMISSION LEVEL (dBuV/m)	LIMIT (dBuV/m)	MARGIN (dB)	ANTENNA HEIGHT (m)	TABLE ANGLE (Degree)	RAW VALUE (dBuV)	CORRECTION FACTOR (dB/m)
1	#5638.40	50.6 PK	68.2	-17.6	1.22 H	108	49.1	1.5
2	*5785.00	112.0 PK			2.14 H	333	73.3	38.7
3	*5785.00	101.1 AV			2.14 H	333	62.4	38.7
4	#5936.00	51.4 PK	68.2	-16.8	3.21 H	118	49.0	2.4
5	11570.00	52.1 PK	74.0	-21.9	2.08 H	331	38.3	13.8
6	11570.00	41.0 AV	54.0	-13.0	2.08 H	331	27.2	13.8

ANTENNA POLARITY & TEST DISTANCE: VERTICAL AT 3 M

NO.	FREQ. (MHz)	EMISSION LEVEL (dBuV/m)	LIMIT (dBuV/m)	MARGIN (dB)	ANTENNA HEIGHT (m)	TABLE ANGLE (Degree)	RAW VALUE (dBuV)	CORRECTION FACTOR (dB/m)
1	#5618.40	51.5 PK	68.2	-16.7	1.77 V	221	50.1	1.4
2	*5785.00	112.0 PK			1.48 V	360	73.3	38.7
3	*5785.00	101.0 AV			1.48 V	360	62.3	38.7
4	#5954.40	50.8 PK	68.2	-17.4	1.09 V	303	48.4	2.4
5	11570.00	52.6 PK	74.0	-21.4	1.51 V	360	38.8	13.8
6	11570.00	41.4 AV	54.0	-12.6	1.51 V	360	27.6	13.8

Remarks:

1. Emission Level(dBuV/m) = Raw Value(dBuV) + Correction Factor(dB/m)
2. Correction Factor(dB/m) = Antenna Factor(dB/m) + Cable Factor(dB) – Pre-Amplifier Factor(dB)
3. The other emission levels were very low against the limit
4. Margin value = Emission Level – Limit value
5. " * ": Fundamental frequency
6. " # ": The radiated frequency is out of the restricted band

CHANNEL	TX Channel 165	DETECTOR FUNCTION	Peak (PK) Average (AV)
FREQUENCY RANGE	1GHz ~ 40GHz		

ANTENNA POLARITY & TEST DISTANCE: HORIZONTAL AT 3 M

NO.	FREQ. (MHz)	EMISSION LEVEL (dBuV/m)	LIMIT (dBuV/m)	MARGIN (dB)	ANTENNA HEIGHT (m)	TABLE ANGLE (Degree)	RAW VALUE (dBuV)	CORRECTION FACTOR (dB/m)
1	#5617.60	50.6 PK	68.2	-17.6	1.04 H	211	49.2	1.4
2	*5825.00	110.4 PK			2.18 H	348	71.6	38.8
3	*5825.00	98.8 AV			2.18 H	348	60.0	38.8
4	#5948.00	51.7 PK	68.2	-16.5	1.12 H	201	49.3	2.4
5	11650.00	53.0 PK	74.0	-21.0	1.59 H	227	39.2	13.8
6	11650.00	41.9 AV	54.0	-12.1	1.59 H	227	28.1	13.8

ANTENNA POLARITY & TEST DISTANCE: VERTICAL AT 3 M

NO.	FREQ. (MHz)	EMISSION LEVEL (dBuV/m)	LIMIT (dBuV/m)	MARGIN (dB)	ANTENNA HEIGHT (m)	TABLE ANGLE (Degree)	RAW VALUE (dBuV)	CORRECTION FACTOR (dB/m)
1	#5628.80	50.1 PK	68.2	-18.1	1.99 V	230	48.7	1.4
2	*5825.00	109.8 PK			1.32 V	360	71.0	38.8
3	*5825.00	99.5 AV			1.32 V	360	60.7	38.8
4	#5944.80	50.2 PK	68.2	-18.0	1.78 V	120	47.8	2.4
5	11650.00	58.0 PK	74.0	-16.0	1.30 V	360	44.2	13.8
6	11650.00	45.6 AV	54.0	-8.4	1.30 V	360	31.8	13.8

Remarks:

1. Emission Level(dBuV/m) = Raw Value(dBuV) + Correction Factor(dB/m)
2. Correction Factor(dB/m) = Antenna Factor(dB/m) + Cable Factor(dB) – Pre-Amplifier Factor(dB)
3. The other emission levels were very low against the limit
4. Margin value = Emission Level – Limit value
5. " * ": Fundamental frequency
6. " # ": The radiated frequency is out of the restricted band

802.11n (HT40)

CHANNEL	TX Channel 38	DETECTOR FUNCTION	Peak (PK) Average (AV)
FREQUENCY RANGE	1GHz ~ 40GHz		

ANTENNA POLARITY & TEST DISTANCE: HORIZONTAL AT 3 M								
NO.	FREQ. (MHz)	EMISSION LEVEL (dBuV/m)	LIMIT (dBuV/m)	MARGIN (dB)	ANTENNA HEIGHT (m)	TABLE ANGLE (Degree)	RAW VALUE (dBuV)	CORRECTION FACTOR (dB/m)
1	5150.00	62.3 PK	74.0	-11.7	2.61 H	11	61.2	1.1
2	5150.00	50.4 AV	54.0	-3.6	2.61 H	11	49.3	1.1
3	*5190.00	102.7 PK			2.66 H	18	64.8	37.9
4	*5190.00	92.7 AV			2.66 H	18	54.8	37.9
5	#10380.00	54.0 PK	68.2	-14.2	2.59 H	207	40.2	13.8

ANTENNA POLARITY & TEST DISTANCE: VERTICAL AT 3 M								
NO.	FREQ. (MHz)	EMISSION LEVEL (dBuV/m)	LIMIT (dBuV/m)	MARGIN (dB)	ANTENNA HEIGHT (m)	TABLE ANGLE (Degree)	RAW VALUE (dBuV)	CORRECTION FACTOR (dB/m)
1	5150.00	64.5 PK	74.0	-9.5	1.30 V	181	63.4	1.1
2	5150.00	52.5 AV	54.0	-1.5	1.30 V	181	51.4	1.1
3	*5190.00	105.0 PK			1.24 V	182	67.1	37.9
4	*5190.00	95.0 AV			1.24 V	182	57.1	37.9
5	#10380.00	54.9 PK	68.2	-13.3	3.24 V	155	41.1	13.8

Remarks:

1. Emission Level(dBuV/m) = Raw Value(dBuV) + Correction Factor(dB/m)
2. Correction Factor(dB/m) = Antenna Factor(dB/m) + Cable Factor(dB) – Pre-Amplifier Factor(dB)
3. The other emission levels were very low against the limit
4. Margin value = Emission Level – Limit value
5. " * ": Fundamental frequency
6. " # ": The radiated frequency is out of the restricted band

CHANNEL	TX Channel 46	DETECTOR FUNCTION	Peak (PK) Average (AV)
FREQUENCY RANGE	1GHz ~ 40GHz		

ANTENNA POLARITY & TEST DISTANCE: HORIZONTAL AT 3 M								
NO.	FREQ. (MHz)	EMISSION LEVEL (dBuV/m)	LIMIT (dBuV/m)	MARGIN (dB)	ANTENNA HEIGHT (m)	TABLE ANGLE (Degree)	RAW VALUE (dBuV)	CORRECTION FACTOR (dB/m)
1	*5230.00	105.1 PK			2.61 H	15	67.4	37.7
2	*5230.00	95.0 AV			2.61 H	15	57.3	37.7
3	5350.00	51.2 PK	74.0	-22.8	2.55 H	6	50.3	0.9
4	5350.00	38.5 AV	54.0	-15.5	2.55 H	6	37.6	0.9
5	#10460.00	54.2 PK	68.2	-14.0	2.53 H	210	40.5	13.7

ANTENNA POLARITY & TEST DISTANCE: VERTICAL AT 3 M								
NO.	FREQ. (MHz)	EMISSION LEVEL (dBuV/m)	LIMIT (dBuV/m)	MARGIN (dB)	ANTENNA HEIGHT (m)	TABLE ANGLE (Degree)	RAW VALUE (dBuV)	CORRECTION FACTOR (dB/m)
1	*5230.00	107.3 PK			1.19 V	182	69.6	37.7
2	*5230.00	97.2 AV			1.19 V	182	59.5	37.7
3	5350.00	52.3 PK	74.0	-21.7	1.61 V	189	51.4	0.9
4	5350.00	40.6 AV	54.0	-13.4	1.61 V	189	39.7	0.9
5	#10460.00	55.0 PK	68.2	-13.2	3.22 V	151	41.3	13.7

Remarks:

1. Emission Level(dBuV/m) = Raw Value(dBuV) + Correction Factor(dB/m)
2. Correction Factor(dB/m) = Antenna Factor(dB/m) + Cable Factor(dB) – Pre-Amplifier Factor(dB)
3. The other emission levels were very low against the limit
4. Margin value = Emission Level – Limit value
5. " * ": Fundamental frequency
6. " # ": The radiated frequency is out of the restricted band

CHANNEL	TX Channel 54	DETECTOR FUNCTION	Peak (PK) Average (AV)
FREQUENCY RANGE	1GHz ~ 40GHz		

ANTENNA POLARITY & TEST DISTANCE: HORIZONTAL AT 3 M								
NO.	FREQ. (MHz)	EMISSION LEVEL (dBuV/m)	LIMIT (dBuV/m)	MARGIN (dB)	ANTENNA HEIGHT (m)	TABLE ANGLE (Degree)	RAW VALUE (dBuV)	CORRECTION FACTOR (dB/m)
1	5150.00	54.9 PK	74.0	-19.1	2.47 H	16	53.8	1.1
2	5150.00	41.3 AV	54.0	-12.7	2.47 H	16	40.2	1.1
3	*5270.00	106.0 PK			2.41 H	23	68.4	37.6
4	*5270.00	95.4 AV			2.41 H	23	57.8	37.6
5	#10540.00	54.0 PK	68.2	-14.2	2.64 H	223	40.2	13.8

ANTENNA POLARITY & TEST DISTANCE: VERTICAL AT 3 M								
NO.	FREQ. (MHz)	EMISSION LEVEL (dBuV/m)	LIMIT (dBuV/m)	MARGIN (dB)	ANTENNA HEIGHT (m)	TABLE ANGLE (Degree)	RAW VALUE (dBuV)	CORRECTION FACTOR (dB/m)
1	5150.00	57.2 PK	74.0	-16.8	1.24 V	181	56.1	1.1
2	5150.00	43.2 AV	54.0	-10.8	1.24 V	181	42.1	1.1
3	*5270.00	108.4 PK			1.49 V	181	70.8	37.6
4	*5270.00	97.7 AV			1.49 V	181	60.1	37.6
5	#10540.00	54.9 PK	68.2	-13.3	3.42 V	158	41.1	13.8

Remarks:

1. Emission Level(dBuV/m) = Raw Value(dBuV) + Correction Factor(dB/m)
2. Correction Factor(dB/m) = Antenna Factor(dB/m) + Cable Factor(dB) – Pre-Amplifier Factor(dB)
3. The other emission levels were very low against the limit
4. Margin value = Emission Level – Limit value
5. " * ": Fundamental frequency
6. " # ": The radiated frequency is out of the restricted band

CHANNEL	TX Channel 62	DETECTOR FUNCTION	Peak (PK) Average (AV)
FREQUENCY RANGE	1GHz ~ 40GHz		

ANTENNA POLARITY & TEST DISTANCE: HORIZONTAL AT 3 M								
NO.	FREQ. (MHz)	EMISSION LEVEL (dBuV/m)	LIMIT (dBuV/m)	MARGIN (dB)	ANTENNA HEIGHT (m)	TABLE ANGLE (Degree)	RAW VALUE (dBuV)	CORRECTION FACTOR (dB/m)
1	*5310.00	100.5 PK			2.47 H	23	62.8	37.7
2	*5310.00	90.6 AV			2.47 H	23	52.9	37.7
3	5350.00	62.0 PK	74.0	-12.0	2.52 H	7	61.1	0.9
4	5350.00	50.5 AV	54.0	-3.5	2.52 H	7	49.6	0.9
5	10620.00	54.6 PK	74.0	-19.4	2.47 H	215	40.5	14.1
6	10620.00	41.3 AV	54.0	-12.7	2.47 H	215	27.2	14.1

ANTENNA POLARITY & TEST DISTANCE: VERTICAL AT 3 M								
NO.	FREQ. (MHz)	EMISSION LEVEL (dBuV/m)	LIMIT (dBuV/m)	MARGIN (dB)	ANTENNA HEIGHT (m)	TABLE ANGLE (Degree)	RAW VALUE (dBuV)	CORRECTION FACTOR (dB/m)
1	*5310.00	102.4 PK			1.51 V	180	64.7	37.7
2	*5310.00	92.8 AV			1.51 V	180	55.1	37.7
3	5350.00	64.1 PK	74.0	-9.9	1.53 V	182	63.2	0.9
4	5350.00	52.7 AV	54.0	-1.3	1.53 V	182	51.8	0.9
5	10620.00	55.5 PK	74.0	-18.5	3.31 V	162	41.4	14.1
6	10620.00	42.2 AV	54.0	-11.8	3.31 V	162	28.1	14.1

Remarks:

1. Emission Level(dBuV/m) = Raw Value(dBuV) + Correction Factor(dB/m)
2. Correction Factor(dB/m) = Antenna Factor(dB/m) + Cable Factor(dB) – Pre-Amplifier Factor(dB)
3. The other emission levels were very low against the limit
4. Margin value = Emission Level – Limit value
5. " * ": Fundamental frequency

CHANNEL	TX Channel 102	DETECTOR FUNCTION	Peak (PK) Average (AV)
FREQUENCY RANGE	1GHz ~ 40GHz		

ANTENNA POLARITY & TEST DISTANCE: HORIZONTAL AT 3 M

NO.	FREQ. (MHz)	EMISSION LEVEL (dBuV/m)	LIMIT (dBuV/m)	MARGIN (dB)	ANTENNA HEIGHT (m)	TABLE ANGLE (Degree)	RAW VALUE (dBuV)	CORRECTION FACTOR (dB/m)
1	5460.00	60.7 PK	74.0	-13.3	2.05 H	214	59.4	1.3
2	5460.00	47.8 AV	54.0	-6.2	2.05 H	214	46.5	1.3
3	#5470.00	66.9 PK	68.2	-1.3	1.97 H	213	65.6	1.3
4	*5510.00	105.0 PK			2.02 H	210	66.7	38.3
5	*5510.00	93.3 AV			2.02 H	210	55.0	38.3
6	11020.00	53.6 PK	74.0	-20.4	1.93 H	202	38.3	15.3
7	11020.00	42.5 AV	54.0	-11.5	1.93 H	202	27.2	15.3

ANTENNA POLARITY & TEST DISTANCE: VERTICAL AT 3 M

NO.	FREQ. (MHz)	EMISSION LEVEL (dBuV/m)	LIMIT (dBuV/m)	MARGIN (dB)	ANTENNA HEIGHT (m)	TABLE ANGLE (Degree)	RAW VALUE (dBuV)	CORRECTION FACTOR (dB/m)
1	5460.00	61.0 PK	74.0	-13.0	1.06 V	191	59.7	1.3
2	5460.00	46.9 AV	54.0	-7.1	1.06 V	191	45.6	1.3
3	#5470.00	67.3 PK	68.2	-0.9	1.06 V	190	66.0	1.3
4	*5510.00	104.6 PK			1.63 V	191	66.3	38.3
5	*5510.00	92.5 AV			1.63 V	191	54.2	38.3
6	11020.00	54.1 PK	74.0	-19.9	1.53 V	182	38.8	15.3
7	11020.00	42.7 AV	54.0	-11.3	1.53 V	182	27.4	15.3

Remarks:

1. Emission Level(dBuV/m) = Raw Value(dBuV) + Correction Factor(dB/m)
2. Correction Factor(dB/m) = Antenna Factor(dB/m) + Cable Factor(dB) – Pre-Amplifier Factor(dB)
3. The other emission levels were very low against the limit
4. Margin value = Emission Level – Limit value
5. " * ": Fundamental frequency
6. " # ": The radiated frequency is out of the restricted band

CHANNEL	TX Channel 110	DETECTOR FUNCTION	Peak (PK) Average (AV)
FREQUENCY RANGE	1GHz ~ 40GHz		

ANTENNA POLARITY & TEST DISTANCE: HORIZONTAL AT 3 M

NO.	FREQ. (MHz)	EMISSION LEVEL (dBuV/m)	LIMIT (dBuV/m)	MARGIN (dB)	ANTENNA HEIGHT (m)	TABLE ANGLE (Degree)	RAW VALUE (dBuV)	CORRECTION FACTOR (dB/m)
1	*5550.00	109.7 PK			1.97 H	212	71.5	38.2
2	*5550.00	98.0 AV			1.97 H	212	59.8	38.2
3	11100.00	52.1 PK	74.0	-21.9	1.86 H	198	37.3	14.8
4	11100.00	42.2 AV	54.0	-11.8	1.86 H	198	27.4	14.8

ANTENNA POLARITY & TEST DISTANCE: VERTICAL AT 3 M

NO.	FREQ. (MHz)	EMISSION LEVEL (dBuV/m)	LIMIT (dBuV/m)	MARGIN (dB)	ANTENNA HEIGHT (m)	TABLE ANGLE (Degree)	RAW VALUE (dBuV)	CORRECTION FACTOR (dB/m)
1	*5550.00	108.2 PK			1.52 V	196	70.0	38.2
2	*5550.00	95.5 AV			1.52 V	196	57.3	38.2
3	11100.00	52.5 PK	74.0	-21.5	1.41 V	192	37.7	14.8
4	11100.00	41.6 AV	54.0	-12.4	1.41 V	192	26.8	14.8

Remarks:

1. Emission Level(dBuV/m) = Raw Value(dBuV) + Correction Factor(dB/m)
2. Correction Factor(dB/m) = Antenna Factor(dB/m) + Cable Factor(dB) – Pre-Amplifier Factor(dB)
3. The other emission levels were very low against the limit
4. Margin value = Emission Level – Limit value
5. " * ": Fundamental frequency

CHANNEL	TX Channel 134	DETECTOR FUNCTION	Peak (PK) Average (AV)
FREQUENCY RANGE	1GHz ~ 40GHz		

ANTENNA POLARITY & TEST DISTANCE: HORIZONTAL AT 3 M								
NO.	FREQ. (MHz)	EMISSION LEVEL (dBuV/m)	LIMIT (dBuV/m)	MARGIN (dB)	ANTENNA HEIGHT (m)	TABLE ANGLE (Degree)	RAW VALUE (dBuV)	CORRECTION FACTOR (dB/m)
1	*5670.00	109.2 PK			1.81 H	212	70.7	38.5
2	*5670.00	97.0 AV			1.81 H	212	58.5	38.5
3	#5725.00	65.9 PK	68.2	-2.3	1.83 H	216	64.3	1.6
4	11340.00	53.4 PK	74.0	-20.6	1.22 H	193	38.7	14.7
5	11340.00	41.3 AV	54.0	-12.7	1.22 H	193	26.6	14.7

ANTENNA POLARITY & TEST DISTANCE: VERTICAL AT 3 M								
NO.	FREQ. (MHz)	EMISSION LEVEL (dBuV/m)	LIMIT (dBuV/m)	MARGIN (dB)	ANTENNA HEIGHT (m)	TABLE ANGLE (Degree)	RAW VALUE (dBuV)	CORRECTION FACTOR (dB/m)
1	*5670.00	108.0 PK			1.05 V	200	69.5	38.5
2	*5670.00	95.9 AV			1.05 V	200	57.4	38.5
3	#5725.00	66.9 PK	68.2	-1.3	1.07 V	195	65.3	1.6
4	11340.00	52.9 PK	74.0	-21.1	1.23 V	181	38.2	14.7
5	11340.00	41.8 AV	54.0	-12.2	1.23 V	181	27.1	14.7

Remarks:

1. Emission Level(dBuV/m) = Raw Value(dBuV) + Correction Factor(dB/m)
2. Correction Factor(dB/m) = Antenna Factor(dB/m) + Cable Factor(dB) – Pre-Amplifier Factor(dB)
3. The other emission levels were very low against the limit
4. Margin value = Emission Level – Limit value
5. " * ": Fundamental frequency
6. " # ": The radiated frequency is out of the restricted band

CHANNEL	TX Channel 151	DETECTOR FUNCTION	Peak (PK) Average (AV)
FREQUENCY RANGE	1GHz ~ 40GHz		

ANTENNA POLARITY & TEST DISTANCE: HORIZONTAL AT 3 M

NO.	FREQ. (MHz)	EMISSION LEVEL (dBuV/m)	LIMIT (dBuV/m)	MARGIN (dB)	ANTENNA HEIGHT (m)	TABLE ANGLE (Degree)	RAW VALUE (dBuV)	CORRECTION FACTOR (dB/m)
1	#5649.60	51.5 PK	68.2	-16.7	1.45 H	233	49.9	1.6
2	*5755.00	106.8 PK			2.10 H	333	68.2	38.6
3	*5755.00	96.8 AV			2.10 H	333	58.2	38.6
4	#5924.80	51.7 PK	68.3	-16.6	1.86 H	219	49.3	2.4
5	11510.00	53.3 PK	74.0	-20.7	1.99 H	337	39.4	13.9
6	11510.00	42.4 AV	54.0	-11.6	1.99 H	337	28.5	13.9

ANTENNA POLARITY & TEST DISTANCE: VERTICAL AT 3 M

NO.	FREQ. (MHz)	EMISSION LEVEL (dBuV/m)	LIMIT (dBuV/m)	MARGIN (dB)	ANTENNA HEIGHT (m)	TABLE ANGLE (Degree)	RAW VALUE (dBuV)	CORRECTION FACTOR (dB/m)
1	#5645.60	51.7 PK	68.2	-16.5	1.23 V	209	50.1	1.6
2	*5755.00	106.8 PK			1.42 V	360	68.2	38.6
3	*5755.00	96.4 AV			1.42 V	360	57.8	38.6
4	#5977.60	52.7 PK	68.2	-15.5	1.66 V	337	50.2	2.5
5	11510.00	53.5 PK	74.0	-20.5	1.32 V	29	39.6	13.9
6	11510.00	42.8 AV	54.0	-11.2	1.32 V	29	28.9	13.9

Remarks:

1. Emission Level(dBuV/m) = Raw Value(dBuV) + Correction Factor(dB/m)
2. Correction Factor(dB/m) = Antenna Factor(dB/m) + Cable Factor(dB) – Pre-Amplifier Factor(dB)
3. The other emission levels were very low against the limit
4. Margin value = Emission Level – Limit value
5. " * ": Fundamental frequency
6. " # ": The radiated frequency is out of the restricted band

CHANNEL	TX Channel 159	DETECTOR FUNCTION	Peak (PK) Average (AV)
FREQUENCY RANGE	1GHz ~ 40GHz		

ANTENNA POLARITY & TEST DISTANCE: HORIZONTAL AT 3 M

NO.	FREQ. (MHz)	EMISSION LEVEL (dBuV/m)	LIMIT (dBuV/m)	MARGIN (dB)	ANTENNA HEIGHT (m)	TABLE ANGLE (Degree)	RAW VALUE (dBuV)	CORRECTION FACTOR (dB/m)
1	#5644.80	50.8 PK	68.2	-17.4	1.62 H	207	49.2	1.6
2	*5795.00	107.2 PK			1.97 H	334	68.5	38.7
3	*5795.00	97.2 AV			1.97 H	334	58.5	38.7
4	#5942.40	51.0 PK	68.2	-17.2	1.29 H	331	48.6	2.4
5	11590.00	53.1 PK	74.0	-20.9	1.77 H	312	39.3	13.8
6	11590.00	41.6 AV	54.0	-12.4	1.77 H	312	27.8	13.8

ANTENNA POLARITY & TEST DISTANCE: VERTICAL AT 3 M

NO.	FREQ. (MHz)	EMISSION LEVEL (dBuV/m)	LIMIT (dBuV/m)	MARGIN (dB)	ANTENNA HEIGHT (m)	TABLE ANGLE (Degree)	RAW VALUE (dBuV)	CORRECTION FACTOR (dB/m)
1	#5614.40	49.9 PK	68.2	-18.3	1.32 V	107	48.5	1.4
2	*5795.00	107.1 PK			1.41 V	360	68.4	38.7
3	*5795.00	97.0 AV			1.41 V	360	58.3	38.7
4	#5996.80	51.7 PK	68.2	-16.5	1.74 V	221	49.3	2.4
5	11590.00	53.3 PK	74.0	-20.7	1.44 V	28	39.5	13.8
6	11590.00	41.4 AV	54.0	-12.6	1.44 V	28	27.6	13.8

Remarks:

1. Emission Level(dBuV/m) = Raw Value(dBuV) + Correction Factor(dB/m)
2. Correction Factor(dB/m) = Antenna Factor(dB/m) + Cable Factor(dB) – Pre-Amplifier Factor(dB)
3. The other emission levels were very low against the limit
4. Margin value = Emission Level – Limit value
5. " * ": Fundamental frequency
6. " # ": The radiated frequency is out of the restricted band

802.11ac (VHT80)

CHANNEL	TX Channel 42	DETECTOR FUNCTION	Peak (PK) Average (AV)
FREQUENCY RANGE	1GHz ~ 40GHz		

ANTENNA POLARITY & TEST DISTANCE: HORIZONTAL AT 3 M

NO.	FREQ. (MHz)	EMISSION LEVEL (dBuV/m)	LIMIT (dBuV/m)	MARGIN (dB)	ANTENNA HEIGHT (m)	TABLE ANGLE (Degree)	RAW VALUE (dBuV)	CORRECTION FACTOR (dB/m)
1	5150.00	61.3 PK	74.0	-12.7	2.58 H	9	60.2	1.1
2	5150.00	51.0 AV	54.0	-3.0	2.58 H	9	49.9	1.1
3	*5210.00	99.0 PK			2.62 H	13	61.2	37.8
4	*5210.00	88.7 AV			2.62 H	13	50.9	37.8
5	5350.00	50.5 PK	74.0	-23.5	2.51 H	19	49.6	0.9
6	5350.00	38.3 AV	54.0	-15.7	2.51 H	19	37.4	0.9
7	#10420.00	54.0 PK	68.2	-14.2	2.34 H	207	40.2	13.8

ANTENNA POLARITY & TEST DISTANCE: VERTICAL AT 3 M

NO.	FREQ. (MHz)	EMISSION LEVEL (dBuV/m)	LIMIT (dBuV/m)	MARGIN (dB)	ANTENNA HEIGHT (m)	TABLE ANGLE (Degree)	RAW VALUE (dBuV)	CORRECTION FACTOR (dB/m)
1	5150.00	63.7 PK	74.0	-10.3	1.19 V	181	62.6	1.1
2	5150.00	53.2 AV	54.0	-0.8	1.19 V	181	52.1	1.1
3	*5210.00	101.3 PK			1.17 V	182	63.5	37.8
4	*5210.00	90.9 AV			1.17 V	182	53.1	37.8
5	5350.00	51.2 PK	74.0	-22.8	1.54 V	192	50.3	0.9
6	5350.00	39.8 AV	54.0	-14.2	1.54 V	192	38.9	0.9
7	#10420.00	54.7 PK	68.2	-13.5	3.31 V	165	40.9	13.8

Remarks:

1. Emission Level(dBuV/m) = Raw Value(dBuV) + Correction Factor(dB/m)
2. Correction Factor(dB/m) = Antenna Factor(dB/m) + Cable Factor(dB) – Pre-Amplifier Factor(dB)
3. The other emission levels were very low against the limit
4. Margin value = Emission Level – Limit value
5. " * ": Fundamental frequency
6. " # ": The radiated frequency is out of the restricted band

CHANNEL	TX Channel 58	DETECTOR FUNCTION	Peak (PK) Average (AV)
FREQUENCY RANGE	1GHz ~ 40GHz		

ANTENNA POLARITY & TEST DISTANCE: HORIZONTAL AT 3 M								
NO.	FREQ. (MHz)	EMISSION LEVEL (dBuV/m)	LIMIT (dBuV/m)	MARGIN (dB)	ANTENNA HEIGHT (m)	TABLE ANGLE (Degree)	RAW VALUE (dBuV)	CORRECTION FACTOR (dB/m)
1	*5290.00	97.1 PK			2.51 H	18	59.5	37.6
2	*5290.00	86.9 AV			2.51 H	18	49.3	37.6
3	5350.00	61.1 PK	74.0	-12.9	2.46 H	6	60.2	0.9
4	5350.00	50.6 AV	54.0	-3.4	2.46 H	6	49.7	0.9
5	#10580.00	53.7 PK	68.2	-14.5	2.61 H	203	39.8	13.9

ANTENNA POLARITY & TEST DISTANCE: VERTICAL AT 3 M								
NO.	FREQ. (MHz)	EMISSION LEVEL (dBuV/m)	LIMIT (dBuV/m)	MARGIN (dB)	ANTENNA HEIGHT (m)	TABLE ANGLE (Degree)	RAW VALUE (dBuV)	CORRECTION FACTOR (dB/m)
1	*5290.00	99.1 PK			1.38 V	181	61.5	37.6
2	*5290.00	89.1 AV			1.38 V	181	51.5	37.6
3	5350.00	63.0 PK	74.0	-11.0	1.45 V	182	62.1	0.9
4	5350.00	52.7 AV	54.0	-1.3	1.45 V	182	51.8	0.9
5	#10580.00	54.6 PK	68.2	-13.6	3.26 V	161	40.7	13.9

Remarks:

1. Emission Level(dBuV/m) = Raw Value(dBuV) + Correction Factor(dB/m)
2. Correction Factor(dB/m) = Antenna Factor(dB/m) + Cable Factor(dB) – Pre-Amplifier Factor(dB)
3. The other emission levels were very low against the limit
4. Margin value = Emission Level – Limit value
5. " * ": Fundamental frequency
6. " # ": The radiated frequency is out of the restricted band

CHANNEL	TX Channel 106	DETECTOR FUNCTION	Peak (PK) Average (AV)
FREQUENCY RANGE	1GHz ~ 40GHz		

ANTENNA POLARITY & TEST DISTANCE: HORIZONTAL AT 3 M

NO.	FREQ. (MHz)	EMISSION LEVEL (dBuV/m)	LIMIT (dBuV/m)	MARGIN (dB)	ANTENNA HEIGHT (m)	TABLE ANGLE (Degree)	RAW VALUE (dBuV)	CORRECTION FACTOR (dB/m)
1	5460.00	59.5 PK	74.0	-14.5	1.79 H	208	58.2	1.3
2	5460.00	45.4 AV	54.0	-8.6	1.79 H	208	44.1	1.3
3	#5470.00	61.9 PK	68.2	-6.3	1.70 H	210	60.6	1.3
4	*5530.00	100.5 PK			1.75 H	212	62.3	38.2
5	*5530.00	88.7 AV			1.75 H	212	50.5	38.2
6	#5725.00	52.3 PK	68.2	-15.9	1.66 H	199	50.7	1.6
7	11060.00	52.4 PK	74.0	-21.6	1.81 H	223	37.4	15.0
8	11060.00	41.9 AV	54.0	-12.1	1.81 H	223	26.9	15.0

ANTENNA POLARITY & TEST DISTANCE: VERTICAL AT 3 M

NO.	FREQ. (MHz)	EMISSION LEVEL (dBuV/m)	LIMIT (dBuV/m)	MARGIN (dB)	ANTENNA HEIGHT (m)	TABLE ANGLE (Degree)	RAW VALUE (dBuV)	CORRECTION FACTOR (dB/m)
1	5460.00	60.0 PK	74.0	-14.0	1.61 V	190	58.7	1.3
2	5460.00	45.0 AV	54.0	-9.0	1.61 V	190	43.7	1.3
3	#5470.00	66.7 PK	68.2	-1.5	1.63 V	191	65.4	1.3
4	*5530.00	99.9 PK			1.53 V	193	61.7	38.2
5	*5530.00	87.3 AV			1.53 V	193	49.1	38.2
6	#5725.00	52.6 PK	68.2	-15.6	1.63 V	193	51.0	1.6
7	11060.00	52.9 PK	74.0	-21.1	1.51 V	188	37.9	15.0
8	11060.00	42.4 AV	54.0	-11.6	1.51 V	188	27.4	15.0

Remarks:

1. Emission Level(dBuV/m) = Raw Value(dBuV) + Correction Factor(dB/m)
2. Correction Factor(dB/m) = Antenna Factor(dB/m) + Cable Factor(dB) – Pre-Amplifier Factor(dB)
3. The other emission levels were very low against the limit
4. Margin value = Emission Level – Limit value
5. " * ": Fundamental frequency
6. " # ": The radiated frequency is out of the restricted band

CHANNEL	TX Channel 155	DETECTOR FUNCTION	Peak (PK) Average (AV)
FREQUENCY RANGE	1GHz ~ 40GHz		

ANTENNA POLARITY & TEST DISTANCE: HORIZONTAL AT 3 M

NO.	FREQ. (MHz)	EMISSION LEVEL (dBuV/m)	LIMIT (dBuV/m)	MARGIN (dB)	ANTENNA HEIGHT (m)	TABLE ANGLE (Degree)	RAW VALUE (dBuV)	CORRECTION FACTOR (dB/m)
1	#5643.20	64.5 PK	68.2	-3.7	2.03 H	334	62.9	1.6
2	#5650.00	65.5 PK	68.2	-2.7	2.22 H	331	64.0	1.5
3	*5775.00	105.5 PK			2.20 H	334	66.9	38.6
4	*5775.00	94.7 AV			2.20 H	334	56.1	38.6
5	#5925.00	59.9 PK	68.2	-8.3	2.29 H	324	57.5	2.4
6	#5928.00	59.2 PK	68.2	-9.0	1.74 H	339	56.8	2.4
7	11550.00	56.1 PK	74.0	-17.9	2.07 H	327	42.3	13.8
8	11550.00	41.4 AV	54.0	-12.6	2.07 H	327	27.6	13.8

ANTENNA POLARITY & TEST DISTANCE: VERTICAL AT 3 M

NO.	FREQ. (MHz)	EMISSION LEVEL (dBuV/m)	LIMIT (dBuV/m)	MARGIN (dB)	ANTENNA HEIGHT (m)	TABLE ANGLE (Degree)	RAW VALUE (dBuV)	CORRECTION FACTOR (dB/m)
1	#5643.20	62.6 PK	68.2	-5.6	1.17 V	202	61.0	1.6
2	#5650.00	64.4 PK	68.2	-3.8	1.34 V	360	62.9	1.5
3	*5775.00	104.9 PK			1.38 V	360	66.3	38.6
4	*5775.00	94.3 AV			1.38 V	360	55.7	38.6
5	#5925.00	52.9 PK	68.2	-15.3	1.43 V	360	50.5	2.4
6	#5929.60	62.6 PK	68.2	-5.6	1.36 V	194	60.2	2.4
7	11550.00	54.9 PK	74.0	-19.1	1.35 V	222	41.1	13.8
8	11550.00	40.9 AV	54.0	-13.1	1.35 V	222	27.1	13.8

Remarks:

1. Emission Level(dBuV/m) = Raw Value(dBuV) + Correction Factor(dB/m)
2. Correction Factor(dB/m) = Antenna Factor(dB/m) + Cable Factor(dB) – Pre-Amplifier Factor(dB)
3. The other emission levels were very low against the limit
4. Margin value = Emission Level – Limit value
5. " * ": Fundamental frequency
6. " # ": The radiated frequency is out of the restricted band

2TX

802.11a

CHANNEL	TX Channel 36	DETECTOR FUNCTION	Peak (PK) Average (AV)
FREQUENCY RANGE	1GHz ~ 40GHz		

ANTENNA POLARITY & TEST DISTANCE: HORIZONTAL AT 3 M

NO.	FREQ. (MHz)	EMISSION LEVEL (dBuV/m)	LIMIT (dBuV/m)	MARGIN (dB)	ANTENNA HEIGHT (m)	TABLE ANGLE (Degree)	RAW VALUE (dBuV)	CORRECTION FACTOR (dB/m)
1	5150.00	64.9 PK	74.0	-9.1	1.91 H	342	63.8	1.1
2	5150.00	51.0 AV	54.0	-3.0	1.91 H	342	49.9	1.1
3	*5180.00	113.1 PK			2.97 H	14	75.1	38.0
4	*5180.00	103.6 AV			2.97 H	14	65.6	38.0
5	#10360.00	54.0 PK	68.2	-14.2	2.55 H	204	40.4	13.6

ANTENNA POLARITY & TEST DISTANCE: VERTICAL AT 3 M

NO.	FREQ. (MHz)	EMISSION LEVEL (dBuV/m)	LIMIT (dBuV/m)	MARGIN (dB)	ANTENNA HEIGHT (m)	TABLE ANGLE (Degree)	RAW VALUE (dBuV)	CORRECTION FACTOR (dB/m)
1	5150.00	62.6 PK	74.0	-11.4	1.23 V	3	61.5	1.1
2	5150.00	48.7 AV	54.0	-5.3	1.23 V	3	47.6	1.1
3	*5180.00	113.4 PK			1.22 V	3	75.4	38.0
4	*5180.00	103.7 AV			1.22 V	3	65.7	38.0
5	#10360.00	52.9 PK	68.2	-15.3	3.56 V	163	39.3	13.6

Remarks:

1. Emission Level(dBuV/m) = Raw Value(dBuV) + Correction Factor(dB/m)
2. Correction Factor(dB/m) = Antenna Factor(dB/m) + Cable Factor(dB) – Pre-Amplifier Factor(dB)
3. The other emission levels were very low against the limit
4. Margin value = Emission Level – Limit value
5. " * ": Fundamental frequency
6. " # ": The radiated frequency is out of the restricted band

CHANNEL	TX Channel 40	DETECTOR FUNCTION	Peak (PK) Average (AV)
FREQUENCY RANGE	1GHz ~ 40GHz		

ANTENNA POLARITY & TEST DISTANCE: HORIZONTAL AT 3 M

NO.	FREQ. (MHz)	EMISSION LEVEL (dBuV/m)	LIMIT (dBuV/m)	MARGIN (dB)	ANTENNA HEIGHT (m)	TABLE ANGLE (Degree)	RAW VALUE (dBuV)	CORRECTION FACTOR (dB/m)
1	*5200.00	115.5 PK			2.07 H	343	77.6	37.9
2	*5200.00	105.7 AV			2.07 H	343	67.8	37.9
3	#10400.00	52.9 PK	68.2	-15.3	2.42 H	202	39.1	13.8

ANTENNA POLARITY & TEST DISTANCE: VERTICAL AT 3 M

NO.	FREQ. (MHz)	EMISSION LEVEL (dBuV/m)	LIMIT (dBuV/m)	MARGIN (dB)	ANTENNA HEIGHT (m)	TABLE ANGLE (Degree)	RAW VALUE (dBuV)	CORRECTION FACTOR (dB/m)
1	*5200.00	105.6 PK			1.17 V	4	67.7	37.9
2	*5200.00	105.0 AV			1.17 V	4	67.1	37.9
3	#10400.00	53.5 PK	68.2	-14.7	3.55 V	163	39.7	13.8

Remarks:

1. Emission Level(dBuV/m) = Raw Value(dBuV) + Correction Factor(dB/m)
2. Correction Factor(dB/m) = Antenna Factor(dB/m) + Cable Factor(dB) – Pre-Amplifier Factor(dB)
3. The other emission levels were very low against the limit
4. Margin value = Emission Level – Limit value
5. " * ": Fundamental frequency
6. " # ": The radiated frequency is out of the restricted band

CHANNEL	TX Channel 48	DETECTOR FUNCTION	Peak (PK) Average (AV)
FREQUENCY RANGE	1GHz ~ 40GHz		

ANTENNA POLARITY & TEST DISTANCE: HORIZONTAL AT 3 M								
NO.	FREQ. (MHz)	EMISSION LEVEL (dBuV/m)	LIMIT (dBuV/m)	MARGIN (dB)	ANTENNA HEIGHT (m)	TABLE ANGLE (Degree)	RAW VALUE (dBuV)	CORRECTION FACTOR (dB/m)
1	*5240.00	115.1 PK			1.93 H	342	77.4	37.7
2	*5240.00	105.4 AV			1.93 H	342	67.7	37.7
3	5350.00	51.7 PK	74.0	-22.3	1.93 H	344	50.8	0.9
4	5350.00	37.7 AV	54.0	-16.3	1.93 H	344	36.8	0.9
5	#10480.00	54.1 PK	68.2	-14.1	2.42 H	213	40.4	13.7

ANTENNA POLARITY & TEST DISTANCE: VERTICAL AT 3 M								
NO.	FREQ. (MHz)	EMISSION LEVEL (dBuV/m)	LIMIT (dBuV/m)	MARGIN (dB)	ANTENNA HEIGHT (m)	TABLE ANGLE (Degree)	RAW VALUE (dBuV)	CORRECTION FACTOR (dB/m)
1	*5240.00	113.8 PK			1.18 V	1	76.1	37.7
2	*5240.00	104.2 AV			1.18 V	1	66.5	37.7
3	5350.00	51.0 PK	74.0	-23.0	1.21 V	4	50.1	0.9
4	5350.00	37.6 AV	54.0	-16.4	1.21 V	4	36.7	0.9
5	#10480.00	53.9 PK	68.2	-14.3	3.50 V	161	40.2	13.7

Remarks:

1. Emission Level(dBuV/m) = Raw Value(dBuV) + Correction Factor(dB/m)
2. Correction Factor(dB/m) = Antenna Factor(dB/m) + Cable Factor(dB) – Pre-Amplifier Factor(dB)
3. The other emission levels were very low against the limit
4. Margin value = Emission Level – Limit value
5. " * ": Fundamental frequency
6. " # ": The radiated frequency is out of the restricted band

CHANNEL	TX Channel 52	DETECTOR FUNCTION	Peak (PK) Average (AV)
FREQUENCY RANGE	1GHz ~ 40GHz		

ANTENNA POLARITY & TEST DISTANCE: HORIZONTAL AT 3 M								
NO.	FREQ. (MHz)	EMISSION LEVEL (dBuV/m)	LIMIT (dBuV/m)	MARGIN (dB)	ANTENNA HEIGHT (m)	TABLE ANGLE (Degree)	RAW VALUE (dBuV)	CORRECTION FACTOR (dB/m)
1	5150.00	51.4 PK	74.0	-22.6	2.76 H	10	50.3	1.1
2	5150.00	38.3 AV	54.0	-15.7	2.76 H	10	37.2	1.1
3	*5260.00	116.1 PK			2.61 H	22	78.5	37.6
4	*5260.00	105.1 AV			2.61 H	22	67.5	37.6
5	#10520.00	54.2 PK	68.2	-14.0	2.42 H	202	40.5	13.7

ANTENNA POLARITY & TEST DISTANCE: VERTICAL AT 3 M								
NO.	FREQ. (MHz)	EMISSION LEVEL (dBuV/m)	LIMIT (dBuV/m)	MARGIN (dB)	ANTENNA HEIGHT (m)	TABLE ANGLE (Degree)	RAW VALUE (dBuV)	CORRECTION FACTOR (dB/m)
1	5150.00	50.8 PK	74.0	-23.2	1.55 V	7	49.7	1.1
2	5150.00	37.9 AV	54.0	-16.1	1.55 V	7	36.8	1.1
3	*5260.00	115.3 PK			1.54 V	6	77.7	37.6
4	*5260.00	104.4 AV			1.54 V	6	66.8	37.6
5	#10520.00	55.2 PK	68.2	-13.0	3.47 V	160	41.5	13.7

Remarks:

1. Emission Level(dBuV/m) = Raw Value(dBuV) + Correction Factor(dB/m)
2. Correction Factor(dB/m) = Antenna Factor(dB/m) + Cable Factor(dB) – Pre-Amplifier Factor(dB)
3. The other emission levels were very low against the limit
4. Margin value = Emission Level – Limit value
5. " * ": Fundamental frequency
6. " # ": The radiated frequency is out of the restricted band

CHANNEL	TX Channel 60	DETECTOR FUNCTION	Peak (PK) Average (AV)
FREQUENCY RANGE	1GHz ~ 40GHz		

ANTENNA POLARITY & TEST DISTANCE: HORIZONTAL AT 3 M

NO.	FREQ. (MHz)	EMISSION LEVEL (dBuV/m)	LIMIT (dBuV/m)	MARGIN (dB)	ANTENNA HEIGHT (m)	TABLE ANGLE (Degree)	RAW VALUE (dBuV)	CORRECTION FACTOR (dB/m)
1	*5300.00	115.2 PK			2.77 H	9	77.6	37.6
2	*5300.00	105.4 AV			2.77 H	9	67.8	37.6
3	10600.00	54.9 PK	74.0	-19.1	2.48 H	196	41.0	13.9
4	10600.00	41.5 AV	54.0	-12.5	2.48 H	196	27.6	13.9

ANTENNA POLARITY & TEST DISTANCE: VERTICAL AT 3 M

NO.	FREQ. (MHz)	EMISSION LEVEL (dBuV/m)	LIMIT (dBuV/m)	MARGIN (dB)	ANTENNA HEIGHT (m)	TABLE ANGLE (Degree)	RAW VALUE (dBuV)	CORRECTION FACTOR (dB/m)
1	*5300.00	114.0 PK			1.52 V	14	76.4	37.6
2	*5300.00	104.2 AV			1.52 V	14	66.6	37.6
3	10600.00	53.3 PK	74.0	-20.7	3.50 V	167	39.4	13.9
4	10600.00	41.6 AV	54.0	-12.4	3.50 V	167	27.7	13.9

Remarks:

1. Emission Level(dBuV/m) = Raw Value(dBuV) + Correction Factor(dB/m)
2. Correction Factor(dB/m) = Antenna Factor(dB/m) + Cable Factor(dB) – Pre-Amplifier Factor(dB)
3. The other emission levels were very low against the limit
4. Margin value = Emission Level – Limit value
5. " * ": Fundamental frequency

CHANNEL	TX Channel 64	DETECTOR FUNCTION	Peak (PK) Average (AV)
FREQUENCY RANGE	1GHz ~ 40GHz		

ANTENNA POLARITY & TEST DISTANCE: HORIZONTAL AT 3 M								
NO.	FREQ. (MHz)	EMISSION LEVEL (dBuV/m)	LIMIT (dBuV/m)	MARGIN (dB)	ANTENNA HEIGHT (m)	TABLE ANGLE (Degree)	RAW VALUE (dBuV)	CORRECTION FACTOR (dB/m)
1	*5320.00	114.1 PK			2.78 H	17	76.4	37.7
2	*5320.00	104.4 AV			2.78 H	17	66.7	37.7
3	5350.00	66.6 PK	74.0	-7.4	2.77 H	13	65.7	0.9
4	5350.00	53.2 AV	54.0	-0.8	2.77 H	13	52.3	0.9
5	10640.00	53.0 PK	74.0	-21.0	2.48 H	196	39.0	14.0
6	10640.00	40.8 AV	54.0	-13.2	2.48 H	196	26.8	14.0

ANTENNA POLARITY & TEST DISTANCE: VERTICAL AT 3 M								
NO.	FREQ. (MHz)	EMISSION LEVEL (dBuV/m)	LIMIT (dBuV/m)	MARGIN (dB)	ANTENNA HEIGHT (m)	TABLE ANGLE (Degree)	RAW VALUE (dBuV)	CORRECTION FACTOR (dB/m)
1	*5320.00	112.8 PK			1.53 V	16	75.1	37.7
2	*5320.00	103.2 AV			1.53 V	16	65.5	37.7
3	5350.00	65.7 PK	74.0	-8.3	1.52 V	16	64.8	0.9
4	5350.00	51.9 AV	54.0	-2.1	1.52 V	16	51.0	0.9
5	10640.00	53.6 PK	74.0	-20.4	3.53 V	166	39.6	14.0
6	10640.00	42.2 AV	54.0	-11.8	3.53 V	166	28.2	14.0

Remarks:

1. Emission Level(dBuV/m) = Raw Value(dBuV) + Correction Factor(dB/m)
2. Correction Factor(dB/m) = Antenna Factor(dB/m) + Cable Factor(dB) – Pre-Amplifier Factor(dB)
3. The other emission levels were very low against the limit
4. Margin value = Emission Level – Limit value
5. " * ": Fundamental frequency

CHANNEL	TX Channel 100	DETECTOR FUNCTION	Peak (PK) Average (AV)
FREQUENCY RANGE	1GHz ~ 40GHz		

ANTENNA POLARITY & TEST DISTANCE: HORIZONTAL AT 3 M

NO.	FREQ. (MHz)	EMISSION LEVEL (dBuV/m)	LIMIT (dBuV/m)	MARGIN (dB)	ANTENNA HEIGHT (m)	TABLE ANGLE (Degree)	RAW VALUE (dBuV)	CORRECTION FACTOR (dB/m)
1	5460.00	59.0 PK	74.0	-15.0	2.76 H	357	57.7	1.3
2	5460.00	44.9 AV	54.0	-9.1	2.76 H	357	43.6	1.3
3	#5470.00	66.9 PK	68.2	-1.3	2.70 H	360	65.6	1.3
4	*5500.00	115.3 PK			2.72 H	358	77.1	38.2
5	*5500.00	104.5 AV			2.72 H	358	66.3	38.2
6	11000.00	54.9 PK	74.0	-19.1	2.53 H	197	39.6	15.3
7	11000.00	43.2 AV	54.0	-10.8	2.53 H	197	27.9	15.3

ANTENNA POLARITY & TEST DISTANCE: VERTICAL AT 3 M

NO.	FREQ. (MHz)	EMISSION LEVEL (dBuV/m)	LIMIT (dBuV/m)	MARGIN (dB)	ANTENNA HEIGHT (m)	TABLE ANGLE (Degree)	RAW VALUE (dBuV)	CORRECTION FACTOR (dB/m)
1	5460.00	59.4 PK	74.0	-14.6	1.56 V	26	58.1	1.3
2	5460.00	45.0 AV	54.0	-9.0	1.56 V	26	43.7	1.3
3	#5470.00	67.2 PK	68.2	-1.0	1.57 V	19	65.9	1.3
4	*5500.00	111.3 PK			1.54 V	17	73.1	38.2
5	*5500.00	101.0 AV			1.54 V	17	62.8	38.2
6	11000.00	54.1 PK	74.0	-19.9	3.51 V	162	38.8	15.3
7	11000.00	40.7 AV	54.0	-13.3	3.51 V	162	25.4	15.3

Remarks:

1. Emission Level(dBuV/m) = Raw Value(dBuV) + Correction Factor(dB/m)
2. Correction Factor(dB/m) = Antenna Factor(dB/m) + Cable Factor(dB) – Pre-Amplifier Factor(dB)
3. Margin value = Emission Level – Limit value
4. The other emission levels were very low against the limit.
5. " * ": Fundamental frequency.
6. " # ": The radiated frequency is out of the restricted band.

CHANNEL	TX Channel 116	DETECTOR FUNCTION	Peak (PK) Average (AV)
FREQUENCY RANGE	1GHz ~ 40GHz		

ANTENNA POLARITY & TEST DISTANCE: HORIZONTAL AT 3 M

NO.	FREQ. (MHz)	EMISSION LEVEL (dBuV/m)	LIMIT (dBuV/m)	MARGIN (dB)	ANTENNA HEIGHT (m)	TABLE ANGLE (Degree)	RAW VALUE (dBuV)	CORRECTION FACTOR (dB/m)
1	*5580.00	115.4 PK			2.59 H	360	77.1	38.3
2	*5580.00	105.0 AV			2.59 H	360	66.7	38.3
3	11160.00	53.2 PK	74.0	-20.8	2.41 H	193	38.5	14.7
4	11160.00	41.3 AV	54.0	-12.7	2.41 H	193	26.6	14.7

ANTENNA POLARITY & TEST DISTANCE: VERTICAL AT 3 M

NO.	FREQ. (MHz)	EMISSION LEVEL (dBuV/m)	LIMIT (dBuV/m)	MARGIN (dB)	ANTENNA HEIGHT (m)	TABLE ANGLE (Degree)	RAW VALUE (dBuV)	CORRECTION FACTOR (dB/m)
1	*5580.00	115.1 PK			1.59 V	15	76.8	38.3
2	*5580.00	104.0 AV			1.59 V	15	65.7	38.3
3	11160.00	53.8 PK	74.0	-20.2	3.59 V	170	39.1	14.7
4	11160.00	40.4 AV	54.0	-13.6	3.59 V	170	25.7	14.7

Remarks:

1. Emission Level(dBuV/m) = Raw Value(dBuV) + Correction Factor(dB/m)
2. Correction Factor(dB/m) = Antenna Factor(dB/m) + Cable Factor(dB) – Pre-Amplifier Factor(dB)
3. The other emission levels were very low against the limit
4. Margin value = Emission Level – Limit value
5. " * ": Fundamental frequency

CHANNEL	TX Channel 140	DETECTOR FUNCTION	Peak (PK) Average (AV)
FREQUENCY RANGE	1GHz ~ 40GHz		

ANTENNA POLARITY & TEST DISTANCE: HORIZONTAL AT 3 M								
NO.	FREQ. (MHz)	EMISSION LEVEL (dBuV/m)	LIMIT (dBuV/m)	MARGIN (dB)	ANTENNA HEIGHT (m)	TABLE ANGLE (Degree)	RAW VALUE (dBuV)	CORRECTION FACTOR (dB/m)
1	*5700.00	114.3 PK			2.58 H	360	75.9	38.4
2	*5700.00	104.0 AV			2.58 H	360	65.6	38.4
3	#5725.00	66.0 PK	68.2	-2.2	2.53 H	358	64.5	1.5
4	11400.00	54.2 PK	74.0	-19.8	2.51 H	199	39.6	14.6
5	11400.00	42.4 AV	54.0	-11.6	2.51 H	199	27.8	14.6

ANTENNA POLARITY & TEST DISTANCE: VERTICAL AT 3 M								
NO.	FREQ. (MHz)	EMISSION LEVEL (dBuV/m)	LIMIT (dBuV/m)	MARGIN (dB)	ANTENNA HEIGHT (m)	TABLE ANGLE (Degree)	RAW VALUE (dBuV)	CORRECTION FACTOR (dB/m)
1	*5700.00	114.6 PK			1.43 V	14	76.2	38.4
2	*5700.00	104.1 AV			1.43 V	14	65.7	38.4
3	#5725.00	67.0 PK	68.2	-1.2	1.40 V	11	65.5	1.5
4	11400.00	53.7 PK	74.0	-20.3	3.52 V	173	39.1	14.6
5	11400.00	40.2 AV	54.0	-13.8	3.52 V	173	25.6	14.6

Remarks:

1. Emission Level(dBuV/m) = Raw Value(dBuV) + Correction Factor(dB/m)
2. Correction Factor(dB/m) = Antenna Factor(dB/m) + Cable Factor(dB) – Pre-Amplifier Factor(dB)
3. The other emission levels were very low against the limit
4. Margin value = Emission Level – Limit value
5. " * ": Fundamental frequency
6. " # ": The radiated frequency is out of the restricted band

CHANNEL	TX Channel 149	DETECTOR FUNCTION	Peak (PK) Average (AV)
FREQUENCY RANGE	1GHz ~ 40GHz		

ANTENNA POLARITY & TEST DISTANCE: HORIZONTAL AT 3 M

NO.	FREQ. (MHz)	EMISSION LEVEL (dBuV/m)	LIMIT (dBuV/m)	MARGIN (dB)	ANTENNA HEIGHT (m)	TABLE ANGLE (Degree)	RAW VALUE (dBuV)	CORRECTION FACTOR (dB/m)
1	#5644.80	51.3 PK	68.2	-16.9	1.53 H	1	49.7	1.6
2	*5745.00	115.3 PK			1.53 H	1	76.8	38.5
3	*5745.00	105.3 AV			1.53 H	1	66.8	38.5
4	#5973.60	50.9 PK	68.2	-17.3	1.53 H	1	48.4	2.5
5	11490.00	53.9 PK	74.0	-20.1	2.43 H	199	40.0	13.9
6	11490.00	41.4 AV	54.0	-12.6	2.43 H	199	27.5	13.9

ANTENNA POLARITY & TEST DISTANCE: VERTICAL AT 3 M

NO.	FREQ. (MHz)	EMISSION LEVEL (dBuV/m)	LIMIT (dBuV/m)	MARGIN (dB)	ANTENNA HEIGHT (m)	TABLE ANGLE (Degree)	RAW VALUE (dBuV)	CORRECTION FACTOR (dB/m)
1	#5613.60	50.8 PK	68.2	-17.4	2.72 V	12	49.4	1.4
2	*5745.00	113.9 PK			2.72 V	12	75.4	38.5
3	*5745.00	103.7 AV			2.72 V	12	65.2	38.5
4	#5964.80	51.2 PK	68.2	-17.0	2.72 V	12	48.7	2.5
5	11490.00	54.7 PK	74.0	-19.3	3.55 V	166	40.8	13.9
6	11490.00	40.4 AV	54.0	-13.6	3.55 V	166	26.5	13.9

Remarks:

1. Emission Level(dBuV/m) = Raw Value(dBuV) + Correction Factor(dB/m)
2. Correction Factor(dB/m) = Antenna Factor(dB/m) + Cable Factor(dB) – Pre-Amplifier Factor(dB)
3. The other emission levels were very low against the limit
4. Margin value = Emission Level – Limit value
5. " * ": Fundamental frequency
6. " # ": The radiated frequency is out of the restricted band

CHANNEL	TX Channel 157	DETECTOR FUNCTION	Peak (PK) Average (AV)
FREQUENCY RANGE	1GHz ~ 40GHz		

ANTENNA POLARITY & TEST DISTANCE: HORIZONTAL AT 3 M								
NO.	FREQ. (MHz)	EMISSION LEVEL (dBuV/m)	LIMIT (dBuV/m)	MARGIN (dB)	ANTENNA HEIGHT (m)	TABLE ANGLE (Degree)	RAW VALUE (dBuV)	CORRECTION FACTOR (dB/m)
1	#5609.60	50.8 PK	68.2	-17.4	1.49 H	1	49.4	1.4
2	*5785.00	114.3 PK			1.49 H	1	75.6	38.7
3	*5785.00	104.4 AV			1.49 H	1	65.7	38.7
4	#5962.40	50.8 PK	68.2	-17.4	1.49 H	1	48.3	2.5
5	11570.00	54.1 PK	74.0	-19.9	2.49 H	195	40.3	13.8
6	11570.00	40.8 AV	54.0	-13.2	2.49 H	195	27.0	13.8

ANTENNA POLARITY & TEST DISTANCE: VERTICAL AT 3 M								
NO.	FREQ. (MHz)	EMISSION LEVEL (dBuV/m)	LIMIT (dBuV/m)	MARGIN (dB)	ANTENNA HEIGHT (m)	TABLE ANGLE (Degree)	RAW VALUE (dBuV)	CORRECTION FACTOR (dB/m)
1	#5602.40	50.5 PK	68.2	-17.7	2.80 V	17	49.1	1.4
2	*5785.00	113.1 PK			2.80 V	17	74.4	38.7
3	*5785.00	103.0 AV			2.80 V	17	64.3	38.7
4	#5966.40	51.3 PK	68.2	-16.9	2.80 V	17	48.8	2.5
5	11570.00	53.7 PK	74.0	-20.3	3.48 V	166	39.9	13.8
6	11570.00	41.8 AV	54.0	-12.2	3.48 V	166	28.0	13.8

Remarks:

1. Emission Level(dBuV/m) = Raw Value(dBuV) + Correction Factor(dB/m)
2. Correction Factor(dB/m) = Antenna Factor(dB/m) + Cable Factor(dB) – Pre-Amplifier Factor(dB)
3. The other emission levels were very low against the limit
4. Margin value = Emission Level – Limit value
5. " * ": Fundamental frequency
6. " # ": The radiated frequency is out of the restricted band

CHANNEL	TX Channel 165	DETECTOR FUNCTION	Peak (PK) Average (AV)
FREQUENCY RANGE	1GHz ~ 40GHz		

ANTENNA POLARITY & TEST DISTANCE: HORIZONTAL AT 3 M								
NO.	FREQ. (MHz)	EMISSION LEVEL (dBuV/m)	LIMIT (dBuV/m)	MARGIN (dB)	ANTENNA HEIGHT (m)	TABLE ANGLE (Degree)	RAW VALUE (dBuV)	CORRECTION FACTOR (dB/m)
1	#5603.20	49.8 PK	68.2	-18.4	1.33 H	1	48.4	1.4
2	*5825.00	113.7 PK			1.33 H	1	74.9	38.8
3	*5825.00	104.2 AV			1.33 H	1	65.4	38.8
4	#5991.20	50.8 PK	68.2	-17.4	1.33 H	1	48.4	2.4
5	11650.00	54.8 PK	74.0	-19.2	2.43 H	195	41.0	13.8
6	11650.00	40.9 AV	54.0	-13.1	2.43 H	195	27.1	13.8

ANTENNA POLARITY & TEST DISTANCE: VERTICAL AT 3 M								
NO.	FREQ. (MHz)	EMISSION LEVEL (dBuV/m)	LIMIT (dBuV/m)	MARGIN (dB)	ANTENNA HEIGHT (m)	TABLE ANGLE (Degree)	RAW VALUE (dBuV)	CORRECTION FACTOR (dB/m)
1	#5605.60	50.1 PK	68.2	-18.1	2.77 V	15	48.7	1.4
2	*5825.00	112.1 PK			2.77 V	15	73.3	38.8
3	*5825.00	102.6 AV			2.77 V	15	63.8	38.8
4	#5962.40	51.8 PK	68.2	-16.4	2.77 V	15	49.3	2.5
5	11650.00	53.3 PK	74.0	-20.7	3.48 V	160	39.5	13.8
6	11650.00	41.6 AV	54.0	-12.4	3.48 V	160	27.8	13.8

Remarks:

1. Emission Level(dBuV/m) = Raw Value(dBuV) + Correction Factor(dB/m)
2. Correction Factor(dB/m) = Antenna Factor(dB/m) + Cable Factor(dB) – Pre-Amplifier Factor(dB)
3. The other emission levels were very low against the limit
4. Margin value = Emission Level – Limit value
5. " * ": Fundamental frequency
6. " # ": The radiated frequency is out of the restricted band

802.11n (HT20)

CHANNEL	TX Channel 36	DETECTOR FUNCTION	Peak (PK) Average (AV)
FREQUENCY RANGE	1GHz ~ 40GHz		

ANTENNA POLARITY & TEST DISTANCE: HORIZONTAL AT 3 M								
NO.	FREQ. (MHz)	EMISSION LEVEL (dBuV/m)	LIMIT (dBuV/m)	MARGIN (dB)	ANTENNA HEIGHT (m)	TABLE ANGLE (Degree)	RAW VALUE (dBuV)	CORRECTION FACTOR (dB/m)
1	5150.00	65.3 PK	74.0	-8.7	1.73 H	341	64.2	1.1
2	5150.00	52.2 AV	54.0	-1.8	1.73 H	341	51.1	1.1
3	*5180.00	112.9 PK			1.76 H	356	74.9	38.0
4	*5180.00	102.7 AV			1.76 H	356	64.7	38.0
5	#10360.00	54.0 PK	68.2	-14.2	2.47 H	210	40.4	13.6

ANTENNA POLARITY & TEST DISTANCE: VERTICAL AT 3 M								
NO.	FREQ. (MHz)	EMISSION LEVEL (dBuV/m)	LIMIT (dBuV/m)	MARGIN (dB)	ANTENNA HEIGHT (m)	TABLE ANGLE (Degree)	RAW VALUE (dBuV)	CORRECTION FACTOR (dB/m)
1	5150.00	64.0 PK	74.0	-10.0	1.19 V	1	62.9	1.1
2	5150.00	50.9 AV	54.0	-3.1	1.19 V	1	49.8	1.1
3	*5180.00	111.8 PK			1.17 V	10	73.8	38.0
4	*5180.00	101.6 AV			1.17 V	10	63.6	38.0
5	#10360.00	53.9 PK	68.2	-14.3	3.53 V	162	40.3	13.6

Remarks:

1. Emission Level(dBuV/m) = Raw Value(dBuV) + Correction Factor(dB/m)
2. Correction Factor(dB/m) = Antenna Factor(dB/m) + Cable Factor(dB) – Pre-Amplifier Factor(dB)
3. The other emission levels were very low against the limit
4. Margin value = Emission Level – Limit value
5. " * ": Fundamental frequency
6. " # ": The radiated frequency is out of the restricted band

CHANNEL	TX Channel 40	DETECTOR FUNCTION	Peak (PK) Average (AV)
FREQUENCY RANGE	1GHz ~ 40GHz		

ANTENNA POLARITY & TEST DISTANCE: HORIZONTAL AT 3 M

NO.	FREQ. (MHz)	EMISSION LEVEL (dBuV/m)	LIMIT (dBuV/m)	MARGIN (dB)	ANTENNA HEIGHT (m)	TABLE ANGLE (Degree)	RAW VALUE (dBuV)	CORRECTION FACTOR (dB/m)
1	*5200.00	114.5 PK			1.72 H	11	76.6	37.9
2	*5200.00	104.2 AV			1.72 H	11	66.3	37.9
3	#10400.00	54.4 PK	68.2	-13.8	2.44 H	208	40.6	13.8

ANTENNA POLARITY & TEST DISTANCE: VERTICAL AT 3 M

NO.	FREQ. (MHz)	EMISSION LEVEL (dBuV/m)	LIMIT (dBuV/m)	MARGIN (dB)	ANTENNA HEIGHT (m)	TABLE ANGLE (Degree)	RAW VALUE (dBuV)	CORRECTION FACTOR (dB/m)
1	*5200.00	113.2 PK			1.13 V	7	75.3	37.9
2	*5200.00	103.0 AV			1.13 V	7	65.1	37.9
3	#10400.00	53.8 PK	68.2	-14.4	3.50 V	165	40.0	13.8

Remarks:

1. Emission Level(dBuV/m) = Raw Value(dBuV) + Correction Factor(dB/m)
2. Correction Factor(dB/m) = Antenna Factor(dB/m) + Cable Factor(dB) – Pre-Amplifier Factor(dB)
3. The other emission levels were very low against the limit
4. Margin value = Emission Level – Limit value
5. " * ": Fundamental frequency
6. " # ": The radiated frequency is out of the restricted band

CHANNEL	TX Channel 48	DETECTOR FUNCTION	Peak (PK) Average (AV)
FREQUENCY RANGE	1GHz ~ 40GHz		

ANTENNA POLARITY & TEST DISTANCE: HORIZONTAL AT 3 M								
NO.	FREQ. (MHz)	EMISSION LEVEL (dBuV/m)	LIMIT (dBuV/m)	MARGIN (dB)	ANTENNA HEIGHT (m)	TABLE ANGLE (Degree)	RAW VALUE (dBuV)	CORRECTION FACTOR (dB/m)
1	*5240.00	115.4 PK			1.99 H	350	77.7	37.7
2	*5240.00	104.8 AV			1.99 H	350	67.1	37.7
3	5350.00	50.9 PK	74.0	-23.1	1.98 H	355	50.0	0.9
4	5350.00	37.7 AV	54.0	-16.3	1.98 H	355	36.8	0.9
5	#10480.00	53.9 PK	68.2	-14.3	2.39 H	214	40.2	13.7

ANTENNA POLARITY & TEST DISTANCE: VERTICAL AT 3 M								
NO.	FREQ. (MHz)	EMISSION LEVEL (dBuV/m)	LIMIT (dBuV/m)	MARGIN (dB)	ANTENNA HEIGHT (m)	TABLE ANGLE (Degree)	RAW VALUE (dBuV)	CORRECTION FACTOR (dB/m)
1	*5240.00	114.2 PK			1.17 V	6	76.5	37.7
2	*5240.00	103.6 AV			1.17 V	6	65.9	37.7
3	5350.00	51.0 PK	74.0	-23.0	1.18 V	3	50.1	0.9
4	5350.00	37.6 AV	54.0	-16.4	1.18 V	3	36.7	0.9
5	#10480.00	53.8 PK	68.2	-14.4	3.50 V	166	40.1	13.7

Remarks:

1. Emission Level(dBuV/m) = Raw Value(dBuV) + Correction Factor(dB/m)
2. Correction Factor(dB/m) = Antenna Factor(dB/m) + Cable Factor(dB) – Pre-Amplifier Factor(dB)
3. The other emission levels were very low against the limit
4. Margin value = Emission Level – Limit value
5. " * ": Fundamental frequency
6. " # ": The radiated frequency is out of the restricted band

CHANNEL	TX Channel 52	DETECTOR FUNCTION	Peak (PK) Average (AV)
FREQUENCY RANGE	1GHz ~ 40GHz		

ANTENNA POLARITY & TEST DISTANCE: HORIZONTAL AT 3 M								
NO.	FREQ. (MHz)	EMISSION LEVEL (dBuV/m)	LIMIT (dBuV/m)	MARGIN (dB)	ANTENNA HEIGHT (m)	TABLE ANGLE (Degree)	RAW VALUE (dBuV)	CORRECTION FACTOR (dB/m)
1	5150.00	52.3 PK	74.0	-21.7	2.79 H	8	51.2	1.1
2	5150.00	39.0 AV	54.0	-15.0	2.79 H	8	37.9	1.1
3	*5260.00	115.2 PK			2.78 H	15	77.6	37.6
4	*5260.00	104.3 AV			2.78 H	15	66.7	37.6
5	#10520.00	54.0 PK	68.2	-14.2	2.37 H	205	40.3	13.7

ANTENNA POLARITY & TEST DISTANCE: VERTICAL AT 3 M								
NO.	FREQ. (MHz)	EMISSION LEVEL (dBuV/m)	LIMIT (dBuV/m)	MARGIN (dB)	ANTENNA HEIGHT (m)	TABLE ANGLE (Degree)	RAW VALUE (dBuV)	CORRECTION FACTOR (dB/m)
1	5150.00	51.4 PK	74.0	-22.6	1.55 V	8	50.3	1.1
2	5150.00	38.2 AV	54.0	-15.8	1.55 V	8	37.1	1.1
3	*5260.00	114.1 PK			1.53 V	6	76.5	37.6
4	*5260.00	103.2 AV			1.53 V	6	65.6	37.6
5	#10520.00	52.9 PK	68.2	-15.3	3.48 V	164	39.2	13.7

Remarks:

1. Emission Level(dBuV/m) = Raw Value(dBuV) + Correction Factor(dB/m)
2. Correction Factor(dB/m) = Antenna Factor(dB/m) + Cable Factor(dB) – Pre-Amplifier Factor(dB)
3. The other emission levels were very low against the limit
4. Margin value = Emission Level – Limit value
5. " * ": Fundamental frequency
6. " # ": The radiated frequency is out of the restricted band

CHANNEL	TX Channel 60	DETECTOR FUNCTION	Peak (PK) Average (AV)
FREQUENCY RANGE	1GHz ~ 40GHz		

ANTENNA POLARITY & TEST DISTANCE: HORIZONTAL AT 3 M

NO.	FREQ. (MHz)	EMISSION LEVEL (dBuV/m)	LIMIT (dBuV/m)	MARGIN (dB)	ANTENNA HEIGHT (m)	TABLE ANGLE (Degree)	RAW VALUE (dBuV)	CORRECTION FACTOR (dB/m)
1	*5300.00	115.2 PK			2.75 H	15	77.6	37.6
2	*5300.00	104.5 AV			2.75 H	15	66.9	37.6
3	10600.00	53.7 PK	74.0	-20.3	2.42 H	201	39.8	13.9
4	10600.00	40.8 AV	54.0	-13.2	2.42 H	201	26.9	13.9

ANTENNA POLARITY & TEST DISTANCE: VERTICAL AT 3 M

NO.	FREQ. (MHz)	EMISSION LEVEL (dBuV/m)	LIMIT (dBuV/m)	MARGIN (dB)	ANTENNA HEIGHT (m)	TABLE ANGLE (Degree)	RAW VALUE (dBuV)	CORRECTION FACTOR (dB/m)
1	*5300.00	114.0 PK			1.51 V	9	76.4	37.6
2	*5300.00	103.5 AV			1.51 V	9	65.9	37.6
3	10600.00	54.2 PK	74.0	-19.8	3.52 V	167	40.3	13.9
4	10600.00	41.9 AV	54.0	-12.1	3.52 V	167	28.0	13.9

Remarks:

1. Emission Level(dBuV/m) = Raw Value(dBuV) + Correction Factor(dB/m)
2. Correction Factor(dB/m) = Antenna Factor(dB/m) + Cable Factor(dB) – Pre-Amplifier Factor(dB)
3. The other emission levels were very low against the limit
4. Margin value = Emission Level – Limit value
5. " * ": Fundamental frequency

CHANNEL	TX Channel 64	DETECTOR FUNCTION	Peak (PK) Average (AV)
FREQUENCY RANGE	1GHz ~ 40GHz		

ANTENNA POLARITY & TEST DISTANCE: HORIZONTAL AT 3 M								
NO.	FREQ. (MHz)	EMISSION LEVEL (dBuV/m)	LIMIT (dBuV/m)	MARGIN (dB)	ANTENNA HEIGHT (m)	TABLE ANGLE (Degree)	RAW VALUE (dBuV)	CORRECTION FACTOR (dB/m)
1	*5320.00	114.0 PK			2.77 H	8	76.3	37.7
2	*5320.00	103.4 AV			2.77 H	8	65.7	37.7
3	5350.00	64.7 PK	74.0	-9.3	2.82 H	2	63.8	0.9
4	5350.00	53.3 AV	54.0	-0.7	2.82 H	2	52.4	0.9
5	10640.00	54.2 PK	74.0	-19.8	2.35 H	204	40.2	14.0
6	10640.00	40.5 AV	54.0	-13.5	2.35 H	204	26.5	14.0

ANTENNA POLARITY & TEST DISTANCE: VERTICAL AT 3 M								
NO.	FREQ. (MHz)	EMISSION LEVEL (dBuV/m)	LIMIT (dBuV/m)	MARGIN (dB)	ANTENNA HEIGHT (m)	TABLE ANGLE (Degree)	RAW VALUE (dBuV)	CORRECTION FACTOR (dB/m)
1	*5320.00	112.8 PK			1.77 V	11	75.1	37.7
2	*5320.00	102.4 AV			1.77 V	11	64.7	37.7
3	5350.00	63.8 PK	74.0	-10.2	1.42 V	17	62.9	0.9
4	5350.00	52.1 AV	54.0	-1.9	1.42 V	17	51.2	0.9
5	10640.00	53.6 PK	74.0	-20.4	3.47 V	163	39.6	14.0
6	10640.00	40.8 AV	54.0	-13.2	3.47 V	163	26.8	14.0

Remarks:

1. Emission Level(dBuV/m) = Raw Value(dBuV) + Correction Factor(dB/m)
2. Correction Factor(dB/m) = Antenna Factor(dB/m) + Cable Factor(dB) – Pre-Amplifier Factor(dB)
3. The other emission levels were very low against the limit
4. Margin value = Emission Level – Limit value
5. " * ": Fundamental frequency

CHANNEL	TX Channel 100	DETECTOR FUNCTION	Peak (PK) Average (AV)
FREQUENCY RANGE	1GHz ~ 40GHz		

ANTENNA POLARITY & TEST DISTANCE: HORIZONTAL AT 3 M

NO.	FREQ. (MHz)	EMISSION LEVEL (dBuV/m)	LIMIT (dBuV/m)	MARGIN (dB)	ANTENNA HEIGHT (m)	TABLE ANGLE (Degree)	RAW VALUE (dBuV)	CORRECTION FACTOR (dB/m)
1	5460.00	59.3 PK	74.0	-14.7	2.38 H	360	58.0	1.3
2	5460.00	44.3 AV	54.0	-9.7	2.38 H	360	43.0	1.3
3	#5470.00	67.2 PK	68.2	-1.0	2.35 H	360	65.9	1.3
4	*5500.00	115.7 PK			2.64 H	259	77.5	38.2
5	*5500.00	105.3 AV			2.64 H	259	67.1	38.2
6	11000.00	54.9 PK	74.0	-19.1	2.44 H	222	39.6	15.3
7	11000.00	43.2 AV	54.0	-10.8	2.44 H	222	27.9	15.3

ANTENNA POLARITY & TEST DISTANCE: VERTICAL AT 3 M

NO.	FREQ. (MHz)	EMISSION LEVEL (dBuV/m)	LIMIT (dBuV/m)	MARGIN (dB)	ANTENNA HEIGHT (m)	TABLE ANGLE (Degree)	RAW VALUE (dBuV)	CORRECTION FACTOR (dB/m)
1	5460.00	58.5 PK	74.0	-15.5	1.50 V	13	57.2	1.3
2	5460.00	45.6 AV	54.0	-8.4	1.50 V	13	44.3	1.3
3	#5470.00	67.4 PK	68.2	-0.8	1.48 V	15	66.1	1.3
4	*5500.00	112.9 PK			1.73 V	60	74.7	38.2
5	*5500.00	102.0 AV			1.52 V	15	63.8	38.2
6	11000.00	53.8 PK	74.0	-20.2	3.57 V	171	38.5	15.3
7	11000.00	40.9 AV	54.0	-13.1	3.57 V	171	25.6	15.3

Remarks:

1. Emission Level(dBuV/m) = Raw Value(dBuV) + Correction Factor(dB/m)
2. Correction Factor(dB/m) = Antenna Factor(dB/m) + Cable Factor(dB) – Pre-Amplifier Factor(dB)
3. The other emission levels were very low against the limit
4. Margin value = Emission Level – Limit value
5. " * ": Fundamental frequency
6. " # ": The radiated frequency is out of the restricted band

CHANNEL	TX Channel 116	DETECTOR FUNCTION	Peak (PK) Average (AV)
FREQUENCY RANGE	1GHz ~ 40GHz		

ANTENNA POLARITY & TEST DISTANCE: HORIZONTAL AT 3 M

NO.	FREQ. (MHz)	EMISSION LEVEL (dBuV/m)	LIMIT (dBuV/m)	MARGIN (dB)	ANTENNA HEIGHT (m)	TABLE ANGLE (Degree)	RAW VALUE (dBuV)	CORRECTION FACTOR (dB/m)
1	*5580.00	115.8 PK			2.18 H	358	77.5	38.3
2	*5580.00	104.8 AV			2.18 H	358	66.5	38.3
3	11160.00	53.5 PK	74.0	-20.5	2.53 H	205	38.8	14.7
4	11160.00	41.9 AV	54.0	-12.1	2.53 H	205	27.2	14.7

ANTENNA POLARITY & TEST DISTANCE: VERTICAL AT 3 M

NO.	FREQ. (MHz)	EMISSION LEVEL (dBuV/m)	LIMIT (dBuV/m)	MARGIN (dB)	ANTENNA HEIGHT (m)	TABLE ANGLE (Degree)	RAW VALUE (dBuV)	CORRECTION FACTOR (dB/m)
1	*5580.00	113.9 PK			1.38 V	15	75.6	38.3
2	*5580.00	103.2 AV			1.38 V	15	64.9	38.3
3	11160.00	53.1 PK	74.0	-20.9	3.51 V	162	38.4	14.7
4	11160.00	39.9 AV	54.0	-14.1	3.51 V	162	25.2	14.7

Remarks:

1. Emission Level(dBuV/m) = Raw Value(dBuV) + Correction Factor(dB/m)
2. Correction Factor(dB/m) = Antenna Factor(dB/m) + Cable Factor(dB) – Pre-Amplifier Factor(dB)
3. The other emission levels were very low against the limit
4. Margin value = Emission Level – Limit value
5. " * ": Fundamental frequency

CHANNEL	TX Channel 140	DETECTOR FUNCTION	Peak (PK) Average (AV)
FREQUENCY RANGE	1GHz ~ 40GHz		

ANTENNA POLARITY & TEST DISTANCE: HORIZONTAL AT 3 M								
NO.	FREQ. (MHz)	EMISSION LEVEL (dBuV/m)	LIMIT (dBuV/m)	MARGIN (dB)	ANTENNA HEIGHT (m)	TABLE ANGLE (Degree)	RAW VALUE (dBuV)	CORRECTION FACTOR (dB/m)
1	*5700.00	113.6 PK			2.35 H	360	75.2	38.4
2	*5700.00	103.2 AV			2.35 H	360	64.8	38.4
3	#5725.00	67.2 PK	68.2	-1.0	2.31 H	360	65.7	1.5
4	11400.00	54.1 PK	74.0	-19.9	2.57 H	191	39.5	14.6
5	11400.00	42.4 AV	54.0	-11.6	2.57 H	191	27.8	14.6

ANTENNA POLARITY & TEST DISTANCE: VERTICAL AT 3 M								
NO.	FREQ. (MHz)	EMISSION LEVEL (dBuV/m)	LIMIT (dBuV/m)	MARGIN (dB)	ANTENNA HEIGHT (m)	TABLE ANGLE (Degree)	RAW VALUE (dBuV)	CORRECTION FACTOR (dB/m)
1	*5700.00	113.9 PK			1.84 V	12	75.5	38.4
2	*5700.00	103.1 AV			1.84 V	12	64.7	38.4
3	#5725.00	67.5 PK	68.2	-0.7	1.77 V	16	66.0	1.5
4	11400.00	53.8 PK	74.0	-20.2	3.51 V	169	39.2	14.6
5	11400.00	40.7 AV	54.0	-13.3	3.51 V	169	26.1	14.6

Remarks:

1. Emission Level(dBuV/m) = Raw Value(dBuV) + Correction Factor(dB/m)
2. Correction Factor(dB/m) = Antenna Factor(dB/m) + Cable Factor(dB) – Pre-Amplifier Factor(dB)
3. The other emission levels were very low against the limit
4. Margin value = Emission Level – Limit value
5. " * ": Fundamental frequency
6. " # ": The radiated frequency is out of the restricted band

CHANNEL	TX Channel 149	DETECTOR FUNCTION	Peak (PK) Average (AV)
FREQUENCY RANGE	1GHz ~ 40GHz		

ANTENNA POLARITY & TEST DISTANCE: HORIZONTAL AT 3 M

NO.	FREQ. (MHz)	EMISSION LEVEL (dBuV/m)	LIMIT (dBuV/m)	MARGIN (dB)	ANTENNA HEIGHT (m)	TABLE ANGLE (Degree)	RAW VALUE (dBuV)	CORRECTION FACTOR (dB/m)
1	#5623.20	51.4 PK	68.2	-16.8	1.35 H	2	50.0	1.4
2	*5745.00	114.8 PK			1.35 H	2	76.3	38.5
3	*5745.00	104.1 AV			1.35 H	2	65.6	38.5
4	#5987.20	50.8 PK	68.2	-17.4	1.35 H	2	48.3	2.5
5	11490.00	53.0 PK	74.0	-21.0	2.40 H	195	39.1	13.9
6	11490.00	40.5 AV	54.0	-13.5	2.40 H	195	26.6	13.9

ANTENNA POLARITY & TEST DISTANCE: VERTICAL AT 3 M

NO.	FREQ. (MHz)	EMISSION LEVEL (dBuV/m)	LIMIT (dBuV/m)	MARGIN (dB)	ANTENNA HEIGHT (m)	TABLE ANGLE (Degree)	RAW VALUE (dBuV)	CORRECTION FACTOR (dB/m)
1	#5638.40	50.8 PK	68.2	-17.4	2.74 V	9	49.3	1.5
2	*5745.00	113.4 PK			2.74 V	9	74.9	38.5
3	*5745.00	102.9 AV			2.74 V	9	64.4	38.5
4	#5965.60	51.6 PK	68.2	-16.6	2.74 V	9	49.1	2.5
5	11490.00	53.1 PK	74.0	-20.9	3.50 V	167	39.2	13.9
6	11490.00	41.5 AV	54.0	-12.5	3.50 V	167	27.6	13.9

Remarks:

1. Emission Level(dBuV/m) = Raw Value(dBuV) + Correction Factor(dB/m)
2. Correction Factor(dB/m) = Antenna Factor(dB/m) + Cable Factor(dB) – Pre-Amplifier Factor(dB)
3. The other emission levels were very low against the limit
4. Margin value = Emission Level – Limit value
5. " * ": Fundamental frequency
6. " # ": The radiated frequency is out of the restricted band

CHANNEL	TX Channel 157	DETECTOR FUNCTION	Peak (PK) Average (AV)
FREQUENCY RANGE	1GHz ~ 40GHz		

ANTENNA POLARITY & TEST DISTANCE: HORIZONTAL AT 3 M								
NO.	FREQ. (MHz)	EMISSION LEVEL (dBuV/m)	LIMIT (dBuV/m)	MARGIN (dB)	ANTENNA HEIGHT (m)	TABLE ANGLE (Degree)	RAW VALUE (dBuV)	CORRECTION FACTOR (dB/m)
1	#5637.60	50.2 PK	68.2	-18.0	1.59 H	2	48.7	1.5
2	*5785.00	114.7 PK			1.59 H	2	76.0	38.7
3	*5785.00	104.3 AV			1.59 H	2	65.6	38.7
4	#5956.80	51.3 PK	68.2	-16.9	1.59 H	2	48.9	2.4
5	11570.00	53.0 PK	74.0	-21.0	2.40 H	205	39.2	13.8
6	11570.00	42.2 AV	54.0	-11.8	2.40 H	205	28.4	13.8

ANTENNA POLARITY & TEST DISTANCE: VERTICAL AT 3 M								
NO.	FREQ. (MHz)	EMISSION LEVEL (dBuV/m)	LIMIT (dBuV/m)	MARGIN (dB)	ANTENNA HEIGHT (m)	TABLE ANGLE (Degree)	RAW VALUE (dBuV)	CORRECTION FACTOR (dB/m)
1	#5627.20	50.7 PK	68.2	-17.5	2.74 V	9	49.3	1.4
2	*5785.00	113.0 PK			2.74 V	9	74.3	38.7
3	*5785.00	102.6 AV			2.74 V	9	63.9	38.7
4	#5988.80	50.6 PK	68.2	-17.6	2.74 V	9	48.1	2.5
5	11570.00	54.3 PK	74.0	-19.7	3.47 V	162	40.5	13.8
6	11570.00	41.4 AV	54.0	-12.6	3.47 V	162	27.6	13.8

Remarks:

1. Emission Level(dBuV/m) = Raw Value(dBuV) + Correction Factor(dB/m)
2. Correction Factor(dB/m) = Antenna Factor(dB/m) + Cable Factor(dB) – Pre-Amplifier Factor(dB)
3. The other emission levels were very low against the limit
4. Margin value = Emission Level – Limit value
5. " * ": Fundamental frequency
6. " # ": The radiated frequency is out of the restricted band

CHANNEL	TX Channel 165	DETECTOR FUNCTION	Peak (PK) Average (AV)
FREQUENCY RANGE	1GHz ~ 40GHz		

ANTENNA POLARITY & TEST DISTANCE: HORIZONTAL AT 3 M								
NO.	FREQ. (MHz)	EMISSION LEVEL (dBuV/m)	LIMIT (dBuV/m)	MARGIN (dB)	ANTENNA HEIGHT (m)	TABLE ANGLE (Degree)	RAW VALUE (dBuV)	CORRECTION FACTOR (dB/m)
1	#5643.20	50.7 PK	68.2	-17.5	1.61 H	1	49.1	1.6
2	*5825.00	114.7 PK			1.61 H	1	75.9	38.8
3	*5825.00	104.6 AV			1.61 H	1	65.8	38.8
4	#5925.60	50.9 PK	68.2	-17.3	1.61 H	1	48.5	2.4
5	11650.00	53.0 PK	74.0	-21.0	2.41 H	197	39.2	13.8
6	11650.00	41.9 AV	54.0	-12.1	2.41 H	197	28.1	13.8

ANTENNA POLARITY & TEST DISTANCE: VERTICAL AT 3 M								
NO.	FREQ. (MHz)	EMISSION LEVEL (dBuV/m)	LIMIT (dBuV/m)	MARGIN (dB)	ANTENNA HEIGHT (m)	TABLE ANGLE (Degree)	RAW VALUE (dBuV)	CORRECTION FACTOR (dB/m)
1	#5636.80	50.4 PK	68.2	-17.8	2.79 V	11	48.9	1.5
2	*5825.00	113.3 PK			2.79 V	11	74.5	38.8
3	*5825.00	103.4 AV			2.79 V	11	64.6	38.8
4	#5999.20	51.4 PK	68.2	-16.8	2.79 V	11	49.0	2.4
5	11650.00	54.8 PK	74.0	-19.2	3.55 V	166	41.0	13.8
6	11650.00	41.9 AV	54.0	-12.1	3.55 V	166	28.1	13.8

Remarks:

1. Emission Level(dBuV/m) = Raw Value(dBuV) + Correction Factor(dB/m)
2. Correction Factor(dB/m) = Antenna Factor(dB/m) + Cable Factor(dB) – Pre-Amplifier Factor(dB)
3. The other emission levels were very low against the limit
4. Margin value = Emission Level – Limit value
5. " * ": Fundamental frequency
6. " # ": The radiated frequency is out of the restricted band

802.11n (HT40)

CHANNEL	TX Channel 38	DETECTOR FUNCTION	Peak (PK) Average (AV)
FREQUENCY RANGE	1GHz ~ 40GHz		

ANTENNA POLARITY & TEST DISTANCE: HORIZONTAL AT 3 M								
NO.	FREQ. (MHz)	EMISSION LEVEL (dBuV/m)	LIMIT (dBuV/m)	MARGIN (dB)	ANTENNA HEIGHT (m)	TABLE ANGLE (Degree)	RAW VALUE (dBuV)	CORRECTION FACTOR (dB/m)
1	5150.00	65.5 PK	74.0	-8.5	1.88 H	357	64.4	1.1
2	5150.00	53.0 AV	54.0	-1.0	1.88 H	357	51.9	1.1
3	*5190.00	109.4 PK			1.96 H	341	71.5	37.9
4	*5190.00	99.4 AV			1.96 H	341	61.5	37.9
5	#10380.00	54.5 PK	68.2	-13.7	2.52 H	211	40.7	13.8

ANTENNA POLARITY & TEST DISTANCE: VERTICAL AT 3 M								
NO.	FREQ. (MHz)	EMISSION LEVEL (dBuV/m)	LIMIT (dBuV/m)	MARGIN (dB)	ANTENNA HEIGHT (m)	TABLE ANGLE (Degree)	RAW VALUE (dBuV)	CORRECTION FACTOR (dB/m)
1	5150.00	64.2 PK	74.0	-9.8	1.20 V	2	63.1	1.1
2	5150.00	50.9 AV	54.0	-3.1	1.20 V	2	49.8	1.1
3	*5190.00	108.1 PK			1.19 V	2	70.2	37.9
4	*5190.00	98.3 AV			1.19 V	2	60.4	37.9
5	#10380.00	54.5 PK	68.2	-13.7	3.63 V	162	40.7	13.8

Remarks:

1. Emission Level(dBuV/m) = Raw Value(dBuV) + Correction Factor(dB/m)
2. Correction Factor(dB/m) = Antenna Factor(dB/m) + Cable Factor(dB) – Pre-Amplifier Factor(dB)
3. The other emission levels were very low against the limit
4. Margin value = Emission Level – Limit value
5. " * ": Fundamental frequency
6. " # ": The radiated frequency is out of the restricted band

CHANNEL	TX Channel 46	DETECTOR FUNCTION	Peak (PK) Average (AV)
FREQUENCY RANGE	1GHz ~ 40GHz		

ANTENNA POLARITY & TEST DISTANCE: HORIZONTAL AT 3 M

NO.	FREQ. (MHz)	EMISSION LEVEL (dBuV/m)	LIMIT (dBuV/m)	MARGIN (dB)	ANTENNA HEIGHT (m)	TABLE ANGLE (Degree)	RAW VALUE (dBuV)	CORRECTION FACTOR (dB/m)
1	*5230.00	112.3 PK			1.76 H	341	74.6	37.7
2	*5230.00	102.3 AV			1.76 H	341	64.6	37.7
3	5350.00	54.2 PK	74.0	-19.8	1.77 H	342	53.3	0.9
4	5350.00	40.9 AV	54.0	-13.1	1.77 H	342	40.0	0.9
5	#10460.00	53.8 PK	68.2	-14.4	2.41 H	206	40.1	13.7

ANTENNA POLARITY & TEST DISTANCE: VERTICAL AT 3 M

NO.	FREQ. (MHz)	EMISSION LEVEL (dBuV/m)	LIMIT (dBuV/m)	MARGIN (dB)	ANTENNA HEIGHT (m)	TABLE ANGLE (Degree)	RAW VALUE (dBuV)	CORRECTION FACTOR (dB/m)
1	*5230.00	111.3 PK			1.28 V	5	73.6	37.7
2	*5230.00	101.5 AV			1.28 V	5	63.8	37.7
3	5350.00	52.7 PK	74.0	-21.3	1.29 V	3	51.8	0.9
4	5350.00	39.4 AV	54.0	-14.6	1.29 V	3	38.5	0.9
5	#10460.00	54.0 PK	68.2	-14.2	3.49 V	162	40.3	13.7

Remarks:

1. Emission Level(dBuV/m) = Raw Value(dBuV) + Correction Factor(dB/m)
2. Correction Factor(dB/m) = Antenna Factor(dB/m) + Cable Factor(dB) – Pre-Amplifier Factor(dB)
3. The other emission levels were very low against the limit
4. Margin value = Emission Level – Limit value
5. " * ": Fundamental frequency
6. " # ": The radiated frequency is out of the restricted band

CHANNEL	TX Channel 54	DETECTOR FUNCTION	Peak (PK) Average (AV)
FREQUENCY RANGE	1GHz ~ 40GHz		

ANTENNA POLARITY & TEST DISTANCE: HORIZONTAL AT 3 M

NO.	FREQ. (MHz)	EMISSION LEVEL (dBuV/m)	LIMIT (dBuV/m)	MARGIN (dB)	ANTENNA HEIGHT (m)	TABLE ANGLE (Degree)	RAW VALUE (dBuV)	CORRECTION FACTOR (dB/m)
1	5150.00	53.9 PK	74.0	-20.1	2.68 H	11	52.8	1.1
2	5150.00	40.7 AV	54.0	-13.3	2.68 H	11	39.6	1.1
3	*5270.00	112.5 PK			2.71 H	1	74.9	37.6
4	*5270.00	102.3 AV			2.71 H	1	64.7	37.6
5	#10540.00	54.2 PK	68.2	-14.0	2.47 H	204	40.4	13.8

ANTENNA POLARITY & TEST DISTANCE: VERTICAL AT 3 M

NO.	FREQ. (MHz)	EMISSION LEVEL (dBuV/m)	LIMIT (dBuV/m)	MARGIN (dB)	ANTENNA HEIGHT (m)	TABLE ANGLE (Degree)	RAW VALUE (dBuV)	CORRECTION FACTOR (dB/m)
1	5150.00	52.8 PK	74.0	-21.2	2.06 V	8	51.7	1.1
2	5150.00	39.5 AV	54.0	-14.5	2.06 V	8	38.4	1.1
3	*5270.00	111.4 PK			2.04 V	11	73.8	37.6
4	*5270.00	101.2 AV			2.04 V	11	63.6	37.6
5	#10540.00	53.0 PK	68.2	-15.2	3.55 V	163	39.2	13.8

Remarks:

1. Emission Level(dBuV/m) = Raw Value(dBuV) + Correction Factor(dB/m)
2. Correction Factor(dB/m) = Antenna Factor(dB/m) + Cable Factor(dB) – Pre-Amplifier Factor(dB)
3. The other emission levels were very low against the limit
4. Margin value = Emission Level – Limit value
5. " * ": Fundamental frequency
6. " # ": The radiated frequency is out of the restricted band

CHANNEL	TX Channel 62	DETECTOR FUNCTION	Peak (PK) Average (AV)
FREQUENCY RANGE	1GHz ~ 40GHz		

ANTENNA POLARITY & TEST DISTANCE: HORIZONTAL AT 3 M

NO.	FREQ. (MHz)	EMISSION LEVEL (dBuV/m)	LIMIT (dBuV/m)	MARGIN (dB)	ANTENNA HEIGHT (m)	TABLE ANGLE (Degree)	RAW VALUE (dBuV)	CORRECTION FACTOR (dB/m)
1	*5310.00	108.5 PK			2.77 H	9	70.8	37.7
2	*5310.00	98.7 AV			2.77 H	9	61.0	37.7
3	5350.00	68.7 PK	74.0	-5.3	2.77 H	4	67.8	0.9
4	5350.00	53.6 AV	54.0	-0.4	2.77 H	4	52.7	0.9
5	10620.00	53.7 PK	74.0	-20.3	2.36 H	203	39.6	14.1
6	10620.00	40.7 AV	54.0	-13.3	2.36 H	203	26.6	14.1

ANTENNA POLARITY & TEST DISTANCE: VERTICAL AT 3 M

NO.	FREQ. (MHz)	EMISSION LEVEL (dBuV/m)	LIMIT (dBuV/m)	MARGIN (dB)	ANTENNA HEIGHT (m)	TABLE ANGLE (Degree)	RAW VALUE (dBuV)	CORRECTION FACTOR (dB/m)
1	*5310.00	107.3 PK			1.57 V	5	69.6	37.7
2	*5310.00	97.6 AV			1.57 V	5	59.9	37.7
3	5350.00	67.3 PK	74.0	-6.7	2.05 V	11	66.4	0.9
4	5350.00	53.1 AV	54.0	-0.9	2.05 V	11	52.2	0.9
5	10620.00	53.1 PK	74.0	-20.9	3.57 V	163	39.0	14.1
6	10620.00	42.2 AV	54.0	-11.8	3.57 V	163	28.1	14.1

Remarks:

1. Emission Level(dBuV/m) = Raw Value(dBuV) + Correction Factor(dB/m)
2. Correction Factor(dB/m) = Antenna Factor(dB/m) + Cable Factor(dB) – Pre-Amplifier Factor(dB)
3. The other emission levels were very low against the limit
4. Margin value = Emission Level – Limit value
5. " * ": Fundamental frequency

CHANNEL	TX Channel 102	DETECTOR FUNCTION	Peak (PK) Average (AV)
FREQUENCY RANGE	1GHz ~ 40GHz		

ANTENNA POLARITY & TEST DISTANCE: HORIZONTAL AT 3 M								
NO.	FREQ. (MHz)	EMISSION LEVEL (dBuV/m)	LIMIT (dBuV/m)	MARGIN (dB)	ANTENNA HEIGHT (m)	TABLE ANGLE (Degree)	RAW VALUE (dBuV)	CORRECTION FACTOR (dB/m)
1	5460.00	60.4 PK	74.0	-13.6	2.15 H	359	59.1	1.3
2	5460.00	45.1 AV	54.0	-8.9	2.15 H	359	43.8	1.3
3	#5470.00	67.3 PK	68.2	-0.9	2.11 H	360	66.0	1.3
4	*5510.00	110.4 PK			2.11 H	357	72.2	38.2
5	*5510.00	100.0 AV			2.11 H	357	61.8	38.2
6	11020.00	53.6 PK	74.0	-20.4	2.59 H	211	38.4	15.2
7	11020.00	41.8 AV	54.0	-12.2	2.59 H	211	26.6	15.2

ANTENNA POLARITY & TEST DISTANCE: VERTICAL AT 3 M								
NO.	FREQ. (MHz)	EMISSION LEVEL (dBuV/m)	LIMIT (dBuV/m)	MARGIN (dB)	ANTENNA HEIGHT (m)	TABLE ANGLE (Degree)	RAW VALUE (dBuV)	CORRECTION FACTOR (dB/m)
1	5460.00	59.3 PK	74.0	-14.7	1.08 V	19	58.0	1.3
2	5460.00	46.6 AV	54.0	-7.4	1.08 V	19	45.3	1.3
3	#5470.00	66.8 PK	68.2	-1.4	1.06 V	15	65.5	1.3
4	*5510.00	108.3 PK			1.03 V	12	70.1	38.2
5	*5510.00	97.8 AV			1.03 V	12	59.6	38.2
6	11020.00	53.3 PK	74.0	-20.7	3.50 V	172	38.1	15.2
7	11020.00	41.1 AV	54.0	-12.9	3.50 V	172	25.9	15.2

Remarks:

1. Emission Level(dBuV/m) = Raw Value(dBuV) + Correction Factor(dB/m)
2. Correction Factor(dB/m) = Antenna Factor(dB/m) + Cable Factor(dB) – Pre-Amplifier Factor(dB)
3. The other emission levels were very low against the limit
4. Margin value = Emission Level – Limit value
5. " * ": Fundamental frequency
6. " # ": The radiated frequency is out of the restricted band

CHANNEL	TX Channel 110	DETECTOR FUNCTION	Peak (PK) Average (AV)
FREQUENCY RANGE	1GHz ~ 40GHz		

ANTENNA POLARITY & TEST DISTANCE: HORIZONTAL AT 3 M

NO.	FREQ. (MHz)	EMISSION LEVEL (dBuV/m)	LIMIT (dBuV/m)	MARGIN (dB)	ANTENNA HEIGHT (m)	TABLE ANGLE (Degree)	RAW VALUE (dBuV)	CORRECTION FACTOR (dB/m)
1	*5550.00	113.0 PK			2.08 H	357	74.8	38.2
2	*5550.00	102.5 AV			2.08 H	357	64.3	38.2
3	11100.00	53.5 PK	74.0	-20.5	2.54 H	211	38.6	14.9
4	11100.00	42.0 AV	54.0	-12.0	2.54 H	211	27.1	14.9

ANTENNA POLARITY & TEST DISTANCE: VERTICAL AT 3 M

NO.	FREQ. (MHz)	EMISSION LEVEL (dBuV/m)	LIMIT (dBuV/m)	MARGIN (dB)	ANTENNA HEIGHT (m)	TABLE ANGLE (Degree)	RAW VALUE (dBuV)	CORRECTION FACTOR (dB/m)
1	*5550.00	111.1 PK			1.99 V	17	72.9	38.2
2	*5550.00	100.4 AV			1.99 V	17	62.2	38.2
3	11100.00	53.1 PK	74.0	-20.9	3.59 V	169	38.2	14.9
4	11100.00	39.9 AV	54.0	-14.1	3.59 V	169	25.0	14.9

Remarks:

1. Emission Level(dBuV/m) = Raw Value(dBuV) + Correction Factor(dB/m)
2. Correction Factor(dB/m) = Antenna Factor(dB/m) + Cable Factor(dB) – Pre-Amplifier Factor(dB)
3. The other emission levels were very low against the limit
4. Margin value = Emission Level – Limit value
5. " * ": Fundamental frequency

CHANNEL	TX Channel 134	DETECTOR FUNCTION	Peak (PK) Average (AV)
FREQUENCY RANGE	1GHz ~ 40GHz		

ANTENNA POLARITY & TEST DISTANCE: HORIZONTAL AT 3 M								
NO.	FREQ. (MHz)	EMISSION LEVEL (dBuV/m)	LIMIT (dBuV/m)	MARGIN (dB)	ANTENNA HEIGHT (m)	TABLE ANGLE (Degree)	RAW VALUE (dBuV)	CORRECTION FACTOR (dB/m)
1	*5670.00	112.5 PK			1.98 H	357	74.1	38.4
2	*5670.00	102.0 AV			1.98 H	357	63.6	38.4
3	#5725.00	67.6 PK	68.2	-0.6	1.98 H	359	66.1	1.5
4	11340.00	54.3 PK	74.0	-19.7	2.43 H	211	39.6	14.7
5	11340.00	42.6 AV	54.0	-11.4	2.43 H	211	27.9	14.7

ANTENNA POLARITY & TEST DISTANCE: VERTICAL AT 3 M								
NO.	FREQ. (MHz)	EMISSION LEVEL (dBuV/m)	LIMIT (dBuV/m)	MARGIN (dB)	ANTENNA HEIGHT (m)	TABLE ANGLE (Degree)	RAW VALUE (dBuV)	CORRECTION FACTOR (dB/m)
1	*5670.00	110.6 PK			1.44 V	15	72.2	38.4
2	*5670.00	99.8 AV			1.44 V	15	61.4	38.4
3	#5725.00	67.8 PK	68.2	-0.4	1.41 V	17	66.2	1.5
4	11340.00	54.1 PK	74.0	-19.9	3.48 V	174	39.4	14.7
5	11340.00	40.5 AV	54.0	-13.5	3.48 V	174	25.8	14.7

Remarks:

1. Emission Level(dBuV/m) = Raw Value(dBuV) + Correction Factor(dB/m)
2. Correction Factor(dB/m) = Antenna Factor(dB/m) + Cable Factor(dB) – Pre-Amplifier Factor(dB)
3. The other emission levels were very low against the limit
4. Margin value = Emission Level – Limit value
5. " * ": Fundamental frequency
6. " # ": The radiated frequency is out of the restricted band

CHANNEL	TX Channel 151	DETECTOR FUNCTION	Peak (PK) Average (AV)
FREQUENCY RANGE	1GHz ~ 40GHz		

ANTENNA POLARITY & TEST DISTANCE: HORIZONTAL AT 3 M								
NO.	FREQ. (MHz)	EMISSION LEVEL (dBuV/m)	LIMIT (dBuV/m)	MARGIN (dB)	ANTENNA HEIGHT (m)	TABLE ANGLE (Degree)	RAW VALUE (dBuV)	CORRECTION FACTOR (dB/m)
1	#5648.80	52.4 PK	68.2	-15.8	1.54 H	3	50.8	1.6
2	*5755.00	110.5 PK			1.54 H	3	71.9	38.6
3	*5755.00	100.3 AV			1.54 H	3	61.7	38.6
4	#5978.40	53.2 PK	68.2	-15.0	1.54 H	3	50.7	2.5
5	11510.00	53.9 PK	74.0	-20.1	2.41 H	205	40.0	13.9
6	11510.00	42.3 AV	54.0	-11.7	2.41 H	205	28.4	13.9

ANTENNA POLARITY & TEST DISTANCE: VERTICAL AT 3 M								
NO.	FREQ. (MHz)	EMISSION LEVEL (dBuV/m)	LIMIT (dBuV/m)	MARGIN (dB)	ANTENNA HEIGHT (m)	TABLE ANGLE (Degree)	RAW VALUE (dBuV)	CORRECTION FACTOR (dB/m)
1	#5644.80	50.8 PK	68.2	-17.4	2.76 V	16	49.2	1.6
2	*5755.00	109.2 PK			2.76 V	16	70.6	38.6
3	*5755.00	99.0 AV			2.76 V	16	60.4	38.6
4	#5977.60	52.6 PK	68.2	-15.6	2.76 V	16	50.1	2.5
5	11510.00	53.3 PK	74.0	-20.7	3.51 V	167	39.4	13.9
6	11510.00	41.0 AV	54.0	-13.0	3.51 V	167	27.1	13.9

Remarks:

1. Emission Level(dBuV/m) = Raw Value(dBuV) + Correction Factor(dB/m)
2. Correction Factor(dB/m) = Antenna Factor(dB/m) + Cable Factor(dB) – Pre-Amplifier Factor(dB)
3. The other emission levels were very low against the limit
4. Margin value = Emission Level – Limit value
5. " * ": Fundamental frequency
6. " # ": The radiated frequency is out of the restricted band

CHANNEL	TX Channel 159	DETECTOR FUNCTION	Peak (PK) Average (AV)
FREQUENCY RANGE	1GHz ~ 40GHz		

ANTENNA POLARITY & TEST DISTANCE: HORIZONTAL AT 3 M								
NO.	FREQ. (MHz)	EMISSION LEVEL (dBuV/m)	LIMIT (dBuV/m)	MARGIN (dB)	ANTENNA HEIGHT (m)	TABLE ANGLE (Degree)	RAW VALUE (dBuV)	CORRECTION FACTOR (dB/m)
1	#5647.20	50.5 PK	68.2	-17.7	1.29 H	2	48.9	1.6
2	*5795.00	110.3 PK			1.29 H	2	71.6	38.7
3	*5795.00	90.8 AV			1.29 H	2	52.1	38.7
4	#5930.40	51.3 PK	68.2	-16.9	1.29 H	2	48.9	2.4
5	11590.00	53.0 PK	74.0	-21.0	2.50 H	202	39.2	13.8
6	11590.00	41.3 AV	54.0	-12.7	2.50 H	202	27.5	13.8

ANTENNA POLARITY & TEST DISTANCE: VERTICAL AT 3 M								
NO.	FREQ. (MHz)	EMISSION LEVEL (dBuV/m)	LIMIT (dBuV/m)	MARGIN (dB)	ANTENNA HEIGHT (m)	TABLE ANGLE (Degree)	RAW VALUE (dBuV)	CORRECTION FACTOR (dB/m)
1	#5604.00	49.9 PK	68.2	-18.3	2.75 V	9	48.5	1.4
2	*5795.00	108.9 PK			2.75 V	9	70.2	38.7
3	*5795.00	99.6 AV			2.75 V	9	60.9	38.7
4	#5992.00	50.8 PK	68.2	-17.4	2.75 V	9	48.4	2.4
5	11590.00	53.8 PK	74.0	-20.2	3.53 V	163	40.0	13.8
6	11590.00	41.9 AV	54.0	-12.1	3.53 V	163	28.1	13.8

Remarks:

1. Emission Level(dBuV/m) = Raw Value(dBuV) + Correction Factor(dB/m)
2. Correction Factor(dB/m) = Antenna Factor(dB/m) + Cable Factor(dB) – Pre-Amplifier Factor(dB)
3. The other emission levels were very low against the limit
4. Margin value = Emission Level – Limit value
5. " * ": Fundamental frequency
6. " # ": The radiated frequency is out of the restricted band

802.11ac (VHT80)

CHANNEL	TX Channel 42	DETECTOR FUNCTION	Peak (PK) Average (AV)
FREQUENCY RANGE	1GHz ~ 40GHz		

ANTENNA POLARITY & TEST DISTANCE: HORIZONTAL AT 3 M								
NO.	FREQ. (MHz)	EMISSION LEVEL (dBuV/m)	LIMIT (dBuV/m)	MARGIN (dB)	ANTENNA HEIGHT (m)	TABLE ANGLE (Degree)	RAW VALUE (dBuV)	CORRECTION FACTOR (dB/m)
1	5150.00	64.4 PK	74.0	-9.6	1.92 H	348	63.3	1.1
2	5150.00	53.2 AV	54.0	-0.8	1.92 H	348	52.1	1.1
3	*5210.00	104.6 PK			2.18 H	15	66.8	37.8
4	*5210.00	94.9 AV			2.18 H	15	57.1	37.8
5	5350.00	51.8 PK	74.0	-22.2	1.94 H	351	50.9	0.9
6	5350.00	38.8 AV	54.0	-15.2	1.94 H	351	37.9	0.9
7	#10420.00	54.2 PK	68.2	-14.0	2.45 H	213	40.4	13.8

ANTENNA POLARITY & TEST DISTANCE: VERTICAL AT 3 M								
NO.	FREQ. (MHz)	EMISSION LEVEL (dBuV/m)	LIMIT (dBuV/m)	MARGIN (dB)	ANTENNA HEIGHT (m)	TABLE ANGLE (Degree)	RAW VALUE (dBuV)	CORRECTION FACTOR (dB/m)
1	5150.00	63.3 PK	74.0	-10.7	1.23 V	1	62.2	1.1
2	5150.00	51.4 AV	54.0	-2.6	1.23 V	1	50.3	1.1
3	*5210.00	103.7 PK			1.23 V	2	65.9	37.8
4	*5210.00	94.1 AV			1.23 V	2	56.3	37.8
5	5350.00	50.6 PK	74.0	-23.4	1.18 V	1	49.7	0.9
6	5350.00	37.7 AV	54.0	-16.3	1.18 V	1	36.8	0.9
7	#10420.00	53.6 PK	68.2	-14.6	3.59 V	166	39.8	13.8

Remarks:

1. Emission Level(dBuV/m) = Raw Value(dBuV) + Correction Factor(dB/m)
2. Correction Factor(dB/m) = Antenna Factor(dB/m) + Cable Factor(dB) – Pre-Amplifier Factor(dB)
3. The other emission levels were very low against the limit
4. Margin value = Emission Level – Limit value
5. " * ": Fundamental frequency
6. " # ": The radiated frequency is out of the restricted band

CHANNEL	TX Channel 58	DETECTOR FUNCTION	Peak (PK) Average (AV)
FREQUENCY RANGE	1GHz ~ 40GHz		

ANTENNA POLARITY & TEST DISTANCE: HORIZONTAL AT 3 M

NO.	FREQ. (MHz)	EMISSION LEVEL (dBuV/m)	LIMIT (dBuV/m)	MARGIN (dB)	ANTENNA HEIGHT (m)	TABLE ANGLE (Degree)	RAW VALUE (dBuV)	CORRECTION FACTOR (dB/m)
1	5150.00	51.2 PK	74.0	-22.8	2.73 H	14	50.1	1.1
2	5150.00	38.2 AV	54.0	-15.8	2.73 H	14	37.1	1.1
3	*5290.00	102.7 PK			2.72 H	16	65.1	37.6
4	*5290.00	93.8 AV			2.72 H	16	56.2	37.6
5	5350.00	64.7 PK	74.0	-9.3	2.96 H	19	63.8	0.9
6	5350.00	52.6 AV	54.0	-1.4	2.96 H	19	51.7	0.9
7	#10580.00	53.5 PK	68.2	-14.7	2.48 H	197	39.6	13.9

ANTENNA POLARITY & TEST DISTANCE: VERTICAL AT 3 M

NO.	FREQ. (MHz)	EMISSION LEVEL (dBuV/m)	LIMIT (dBuV/m)	MARGIN (dB)	ANTENNA HEIGHT (m)	TABLE ANGLE (Degree)	RAW VALUE (dBuV)	CORRECTION FACTOR (dB/m)
1	5150.00	50.6 PK	74.0	-23.4	1.81 V	19	49.5	1.1
2	5150.00	37.6 AV	54.0	-16.4	1.81 V	19	36.5	1.1
3	*5290.00	102.3 PK			1.53 V	14	64.7	37.6
4	*5290.00	93.0 AV			1.53 V	14	55.4	37.6
5	5350.00	63.2 PK	74.0	-10.8	1.81 V	18	62.3	0.9
6	5350.00	53.0 AV	54.0	-1.0	1.81 V	18	52.1	0.9
7	#10580.00	54.1 PK	68.2	-14.1	3.54 V	164	40.2	13.9

Remarks:

1. Emission Level(dBuV/m) = Raw Value(dBuV) + Correction Factor(dB/m)
2. Correction Factor(dB/m) = Antenna Factor(dB/m) + Cable Factor(dB) – Pre-Amplifier Factor(dB)
3. The other emission levels were very low against the limit
4. Margin value = Emission Level – Limit value
5. " * ": Fundamental frequency
6. " # ": The radiated frequency is out of the restricted band

CHANNEL	TX Channel 106	DETECTOR FUNCTION	Peak (PK) Average (AV)
FREQUENCY RANGE	1GHz ~ 40GHz		

ANTENNA POLARITY & TEST DISTANCE: HORIZONTAL AT 3 M

NO.	FREQ. (MHz)	EMISSION LEVEL (dBuV/m)	LIMIT (dBuV/m)	MARGIN (dB)	ANTENNA HEIGHT (m)	TABLE ANGLE (Degree)	RAW VALUE (dBuV)	CORRECTION FACTOR (dB/m)
1	5460.00	65.5 PK	74.0	-8.5	1.78 H	353	64.2	1.3
2	5460.00	51.4 AV	54.0	-2.6	1.78 H	353	50.1	1.3
3	#5470.00	67.4 PK	68.2	-0.8	1.80 H	350	66.1	1.3
4	*5530.00	106.5 PK			1.82 H	356	68.3	38.2
5	*5530.00	97.1 AV			1.82 H	356	58.9	38.2
6	#5725.00	51.7 PK	68.2	-16.5	1.86 H	349	50.1	1.5
7	11060.00	54.6 PK	74.0	-19.4	2.48 H	211	39.6	15.0
8	11060.00	42.1 AV	54.0	-11.9	2.48 H	211	27.1	15.0

ANTENNA POLARITY & TEST DISTANCE: VERTICAL AT 3 M

NO.	FREQ. (MHz)	EMISSION LEVEL (dBuV/m)	LIMIT (dBuV/m)	MARGIN (dB)	ANTENNA HEIGHT (m)	TABLE ANGLE (Degree)	RAW VALUE (dBuV)	CORRECTION FACTOR (dB/m)
1	5460.00	64.4 PK	74.0	-9.6	1.48 V	22	63.1	1.3
2	5460.00	50.5 AV	54.0	-3.5	1.48 V	22	49.2	1.3
3	#5470.00	64.7 PK	68.2	-3.5	1.41 V	17	63.4	1.3
4	*5530.00	104.4 PK			1.44 V	15	66.2	38.2
5	*5530.00	94.6 AV			1.44 V	15	56.4	38.2
6	#5725.00	52.3 PK	68.2	-16.1	1.51 V	20	50.8	1.5
7	11060.00	54.3 PK	74.0	-19.7	3.54 V	162	39.3	15.0
8	11060.00	41.1 AV	54.0	-12.9	3.54 V	162	26.1	15.0

Remarks:

1. Emission Level(dBuV/m) = Raw Value(dBuV) + Correction Factor(dB/m)
2. Correction Factor(dB/m) = Antenna Factor(dB/m) + Cable Factor(dB) – Pre-Amplifier Factor(dB)
3. The other emission levels were very low against the limit
4. Margin value = Emission Level – Limit value
5. " * ": Fundamental frequency
6. " # ": The radiated frequency is out of the restricted band

CHANNEL	TX Channel 155	DETECTOR FUNCTION	Peak (PK) Average (AV)
FREQUENCY RANGE	1GHz ~ 40GHz		

ANTENNA POLARITY & TEST DISTANCE: HORIZONTAL AT 3 M

NO.	FREQ. (MHz)	EMISSION LEVEL (dBuV/m)	LIMIT (dBuV/m)	MARGIN (dB)	ANTENNA HEIGHT (m)	TABLE ANGLE (Degree)	RAW VALUE (dBuV)	CORRECTION FACTOR (dB/m)
1	#5648.80	64.2 PK	68.2	-4.0	1.81 H	359	62.6	1.6
2	#5650.00	67.2 PK	68.2	-1.0	1.81 H	359	65.7	1.5
3	*5775.00	109.5 PK			1.81 H	359	70.9	38.6
4	*5775.00	98.2 AV			1.81 H	359	59.6	38.6
5	#5925.00	65.8 PK	68.2	-2.4	1.81 H	359	63.4	2.4
6	#5929.60	62.9 PK	68.2	-5.3	1.81 H	359	60.5	2.4
7	11550.00	53.6 PK	74.0	-20.4	2.42 H	200	39.8	13.8
8	11550.00	41.3 AV	54.0	-12.7	2.42 H	200	27.5	13.8

ANTENNA POLARITY & TEST DISTANCE: VERTICAL AT 3 M

NO.	FREQ. (MHz)	EMISSION LEVEL (dBuV/m)	LIMIT (dBuV/m)	MARGIN (dB)	ANTENNA HEIGHT (m)	TABLE ANGLE (Degree)	RAW VALUE (dBuV)	CORRECTION FACTOR (dB/m)
1	#5644.00	61.9 PK	68.2	-6.3	1.89 V	344	60.3	1.6
2	#5650.00	64.0 PK	68.2	-4.2	1.89 V	344	62.5	1.5
3	*5775.00	106.3 PK			1.89 V	344	67.7	38.6
4	*5775.00	96.8 AV			1.89 V	344	58.2	38.6
5	#5925.00	64.4 PK	68.2	-3.8	1.89 V	344	62.0	2.4
6	#5929.60	62.4 PK	68.2	-5.8	1.89 V	344	60.0	2.4
7	11550.00	53.9 PK	74.0	-20.1	3.54 V	162	40.1	13.8
8	11550.00	40.9 AV	54.0	-13.1	3.54 V	162	27.1	13.8

Remarks:

1. Emission Level(dBuV/m) = Raw Value(dBuV) + Correction Factor(dB/m)
2. Correction Factor(dB/m) = Antenna Factor(dB/m) + Cable Factor(dB) – Pre-Amplifier Factor(dB)
3. The other emission levels were very low against the limit
4. Margin value = Emission Level – Limit value
5. " * ": Fundamental frequency
6. " # ": The radiated frequency is out of the restricted band

Below 1GHz Worst-Case Data:

802.11a

CHANNEL	TX Channel 157	DETECTOR FUNCTION	Quasi-Peak (QP)
FREQUENCY RANGE	9kHz ~ 1GHz		
TEST MODE	A		

ANTENNA POLARITY & TEST DISTANCE: HORIZONTAL AT 3 M

NO.	FREQ. (MHz)	EMISSION LEVEL (dBuV/m)	LIMIT (dBuV/m)	MARGIN (dB)	ANTENNA HEIGHT (m)	TABLE ANGLE (Degree)	RAW VALUE (dBuV)	CORRECTION FACTOR (dB/m)
1	62.95	31.9 QP	40.0	-8.1	2.00 H	127	42.2	-10.3
2	131.00	36.6 QP	43.5	-6.9	2.00 H	255	47.1	-10.5
3	162.11	35.7 QP	43.5	-7.8	1.51 H	336	44.7	-9.0
4	191.28	33.7 QP	43.5	-9.8	1.00 H	160	44.8	-11.1
5	214.61	39.4 QP	43.5	-4.1	1.00 H	15	50.3	-10.9
6	502.36	32.4 QP	46.0	-13.6	1.51 H	354	36.0	-3.6

Remarks:

1. Emission Level(dBuV/m) = Raw Value(dBuV) + Correction Factor(dB/m)
2. Correction Factor(dB/m) = Antenna Factor(dB/m) + Cable Factor(dB) – Pre-Amplifier Factor(dB)
3. The other emission levels were very low against the limit of frequency range 30MHz ~ 1000MHz
4. Margin value = Emission Level – Limit value
5. The emission levels were very low against the limit of frequency range 9kHz ~ 30MHz: the amplitude of spurious emissions attenuated more than 20 dB below the permissible value to be report

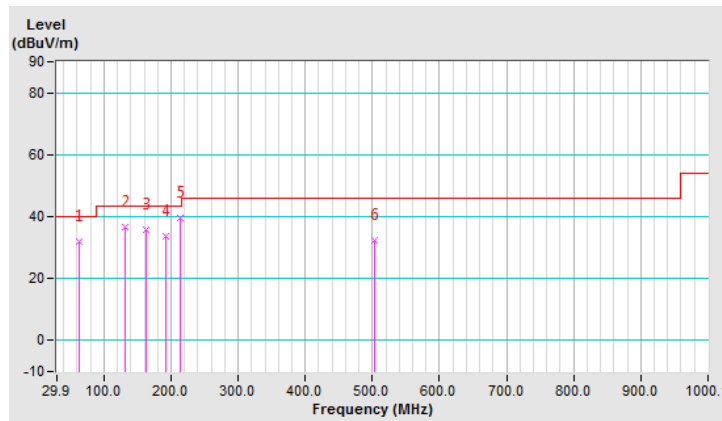

CHANNEL	TX Channel 157	DETECTOR FUNCTION	Quasi-Peak (QP)
FREQUENCY RANGE	9kHz ~ 1GHz		
TEST MODE	A		

ANTENNA POLARITY & TEST DISTANCE: VERTICAL AT 3 M								
NO.	FREQ. (MHz)	EMISSION LEVEL (dBuV/m)	LIMIT (dBuV/m)	MARGIN (dB)	ANTENNA HEIGHT (m)	TABLE ANGLE (Degree)	RAW VALUE (dBuV)	CORRECTION FACTOR (dB/m)
1	39.62	37.7 QP	40.0	-2.3	1.00 V	114	48.1	-10.4
2	62.95	37.3 QP	40.0	-2.7	1.00 V	38	47.6	-10.3
3	131.00	34.9 QP	43.5	-8.6	1.00 V	54	45.4	-10.5
4	214.61	32.7 QP	43.5	-10.8	1.00 V	317	43.6	-10.9
5	284.60	35.3 QP	46.0	-10.7	1.49 V	341	43.0	-7.7
6	640.41	32.1 QP	46.0	-13.9	1.99 V	7	32.7	-0.6

Remarks:

1. Emission Level(dBuV/m) = Raw Value(dBuV) + Correction Factor(dB/m)
2. Correction Factor(dB/m) = Antenna Factor(dB/m) + Cable Factor(dB) – Pre-Amplifier Factor(dB)
3. The other emission levels were very low against the limit of frequency range 30MHz ~ 1000MHz
4. Margin value = Emission Level – Limit value
5. The emission levels were very low against the limit of frequency range 9kHz ~ 30MHz: the amplitude of spurious emissions attenuated more than 20 dB below the permissible value to be report

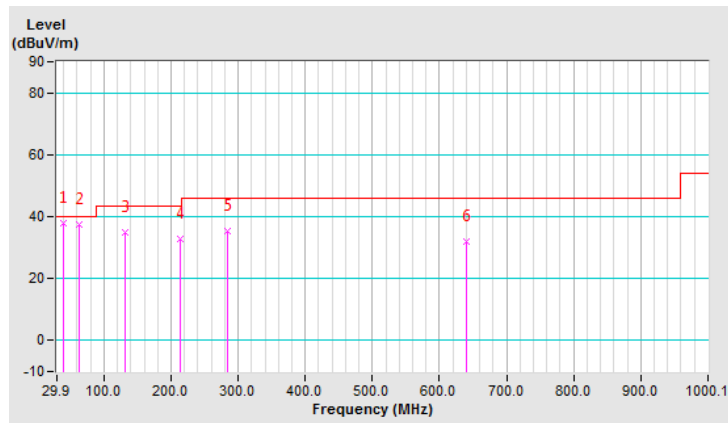

CHANNEL	TX Channel 157	DETECTOR FUNCTION	Quasi-Peak (QP)
FREQUENCY RANGE	9kHz ~ 1GHz		
TEST MODE	B		

ANTENNA POLARITY & TEST DISTANCE: HORIZONTAL AT 3 M								
NO.	FREQ. (MHz)	EMISSION LEVEL (dBuV/m)	LIMIT (dBuV/m)	MARGIN (dB)	ANTENNA HEIGHT (m)	TABLE ANGLE (Degree)	RAW VALUE (dBuV)	CORRECTION FACTOR (dB/m)
1	65.89	29.3 QP	40.0	-10.7	1.00 H	2	40.4	-11.1
2	87.23	18.5 QP	40.0	-21.5	1.00 H	54	33.2	-14.7
3	156.10	29.1 QP	43.5	-14.4	1.00 H	70	38.4	-9.3
4	233.70	18.6 QP	46.0	-27.4	1.00 H	15	29.1	-10.5
5	294.81	24.8 QP	46.0	-21.2	1.00 H	95	32.9	-8.1
6	368.53	24.5 QP	46.0	-21.5	1.00 H	240	31.3	-6.8

Remarks:

1. Emission Level(dBuV/m) = Raw Value(dBuV) + Correction Factor(dB/m)
2. Correction Factor(dB/m) = Antenna Factor(dB/m) + Cable Factor(dB) – Pre-Amplifier Factor(dB)
3. The other emission levels were very low against the limit of frequency range 30MHz ~ 1000MHz
4. Margin value = Emission Level – Limit value
5. The emission levels were very low against the limit of frequency range 9kHz ~ 30MHz: the amplitude of spurious emissions attenuated more than 20 dB below the permissible value to be report

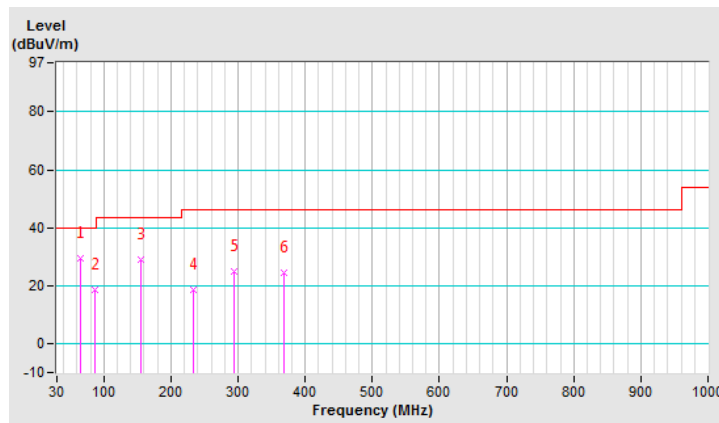

CHANNEL	TX Channel 157	DETECTOR FUNCTION	Quasi-Peak (QP)
FREQUENCY RANGE	9kHz ~ 1GHz		
TEST MODE	B		

ANTENNA POLARITY & TEST DISTANCE: VERTICAL AT 3 M								
NO.	FREQ. (MHz)	EMISSION LEVEL (dBuV/m)	LIMIT (dBuV/m)	MARGIN (dB)	ANTENNA HEIGHT (m)	TABLE ANGLE (Degree)	RAW VALUE (dBuV)	CORRECTION FACTOR (dB/m)
1	42.61	32.2 QP	40.0	-7.8	1.00 V	247	42.3	-10.1
2	54.25	30.3 QP	40.0	-9.7	1.00 V	199	40.4	-10.1
3	64.92	35.9 QP	40.0	-4.1	1.00 V	14	46.9	-11.0
4	144.46	31.8 QP	43.5	-11.7	1.00 V	281	41.4	-9.6
5	288.02	30.8 QP	46.0	-15.2	1.00 V	352	39.0	-8.2
6	499.48	30.9 QP	46.0	-15.1	1.00 V	162	35.4	-4.5

Remarks:

1. Emission Level(dBuV/m) = Raw Value(dBuV) + Correction Factor(dB/m)
2. Correction Factor(dB/m) = Antenna Factor(dB/m) + Cable Factor(dB) – Pre-Amplifier Factor(dB)
3. The other emission levels were very low against the limit of frequency range 30MHz ~ 1000MHz
4. Margin value = Emission Level – Limit value
5. The emission levels were very low against the limit of frequency range 9kHz ~ 30MHz: the amplitude of spurious emissions attenuated more than 20 dB below the permissible value to be report

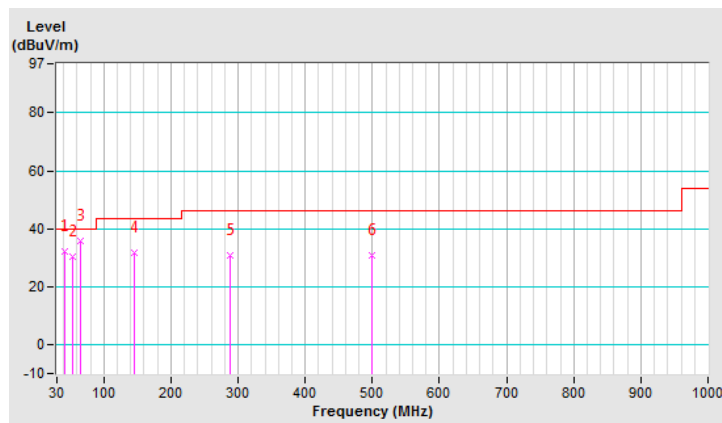

4.2 Conducted Emission Measurement

4.2.1 Limits of Conducted Emission Measurement

Frequency (MHz)	Conducted Limit (dBuV)	
	Quasi-peak	Average
0.15 - 0.5	66 - 56	56 - 46
0.50 - 5.0	56	46
5.0 - 30.0	60	50

Note: 1. The lower limit shall apply at the transition frequencies.

2. The limit decreases in line with the logarithm of the frequency in the range of 0.15 to 0.50MHz.

4.2.2 Test Instruments

Description & Manufacturer	Model No.	Serial No.	Cal. Date	Cal. Due
Test Receiver ROHDE & SCHWARZ	ESCI	100613	Dec. 10, 2018	Dec. 09, 2019
RF signal cable Woken	5D-FB	Cable-cond1-01	Sep. 05, 2018	Sep. 04, 2019
LISN ROHDE & SCHWARZ (EUT)	ENV216	101826	Feb. 26, 2018	Feb. 25, 2019
			Feb. 21, 2019	Feb. 20, 2020
LISN ROHDE & SCHWARZ (Peripheral)	ESH3-Z5	100311	Aug. 19, 2018	Aug. 18, 2019
Software ADT	BV ADT_Cond_ V7.3.7.4	NA	NA	NA

Note: 1. The calibration interval of the above test instruments is 12 months and the calibrations are traceable to NML/ROC and NIST/USA.

2. The test was performed in HwaYa Shielded Room 1.

3. The VCCI Site Registration No. is C-12040.

4.2.3 Test Procedures

- The EUT was placed 0.4 meters from the conducting wall of the shielded room with EUT being connected to the power mains through a line impedance stabilization network (LISN). Other support units were connected to the power mains through another LISN. The two LISNs provide 50 ohm/ 50uH of coupling impedance for the measuring instrument.
- Both lines of the power mains connected to the EUT were checked for maximum conducted interference.
- The frequency range from 150kHz to 30MHz was searched. Emission levels under (Limit - 20dB) was not recorded.

Note: The resolution bandwidth and video bandwidth of test receiver is 9kHz for quasi-peak detection (QP) and average detection (AV) at frequency 0.15MHz-30MHz.

4.2.4 Deviation from Test Standard

No deviation.

4.2.5 Test Setup

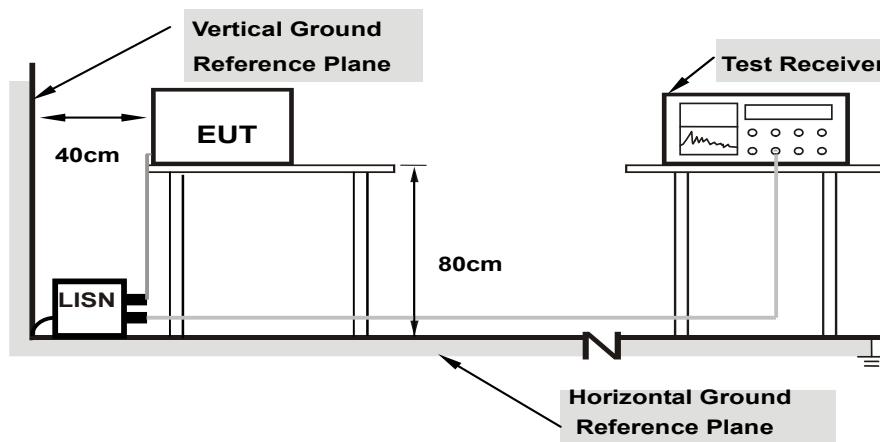

Note: 1.Support units were connected to second LISN.

For the actual test configuration, please refer to the attached file (Test Setup Photo).

4.2.6 EUT Operating Conditions

Same as 4.1.6.

4.2.7 Test Results

Worst-case data:

802.11a

Phase	Line (L)	Detector Function	Quasi-Peak (QP) / Average (AV)
Test Mode	A		

No	Freq. [MHz]	Corr. Factor (dB)	Reading Value [dB (uV)]		Emission Level [dB (uV)]		Limit [dB (uV)]		Margin (dB)	
			Q.P.	AV.	Q.P.	AV.	Q.P.	AV.	Q.P.	AV.
			1	0.32483	10.07	28.81	27.78	38.88	37.85	59.58
2	0.42225	10.07	27.09	19.98	37.16	30.05	57.40	47.40	-20.24	-17.35
3	0.97575	10.08	24.77	24.49	34.85	34.57	56.00	46.00	-21.15	-11.43
4	1.62604	10.09	26.87	26.61	36.96	36.70	56.00	46.00	-19.04	-9.30
5	2.27625	10.10	27.29	26.99	37.39	37.09	56.00	46.00	-18.61	-8.91
6	10.16025	10.27	22.33	15.94	32.60	26.21	60.00	50.00	-27.40	-23.79

Remarks:

1. Q.P. and AV. are abbreviations of quasi-peak and average individually.
2. The emission levels of other frequencies were very low against the limit.
3. Margin value = Emission level - Limit value
4. Correction factor = Insertion loss + Cable loss
5. Emission Level = Correction Factor + Reading Value.

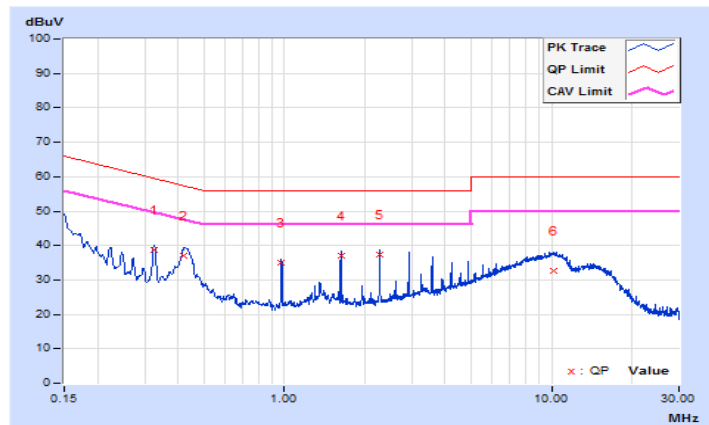

Phase	Neutral (N)	Detector Function	Quasi-Peak (QP) / Average (AV)
Test Mode	A		

No	Freq. [MHz]	Corr. Factor (dB)	Reading Value [dB (uV)]		Emission Level [dB (uV)]		Limit [dB (uV)]		Margin (dB)	
			Q.P.	AV.	Q.P.	AV.	Q.P.	AV.	Q.P.	AV.
			1	0.32550	10.13	28.55	27.83	38.68	37.96	59.57
2	0.42747	10.13	28.37	20.86	38.50	30.99	57.30	47.30	-18.80	-16.31
3	1.62604	10.15	26.77	26.63	36.92	36.78	56.00	46.00	-19.08	-9.22
4	2.27625	10.16	27.20	27.02	37.36	37.18	56.00	46.00	-18.64	-8.82
5	2.92650	10.18	26.30	25.83	36.48	36.01	56.00	46.00	-19.52	-9.99
6	3.57675	10.21	25.11	23.64	35.32	33.85	56.00	46.00	-20.68	-12.15

Remarks:

1. Q.P. and AV. are abbreviations of quasi-peak and average individually.
2. The emission levels of other frequencies were very low against the limit.
3. Margin value = Emission level - Limit value
4. Correction factor = Insertion loss + Cable loss
5. Emission Level = Correction Factor + Reading Value.

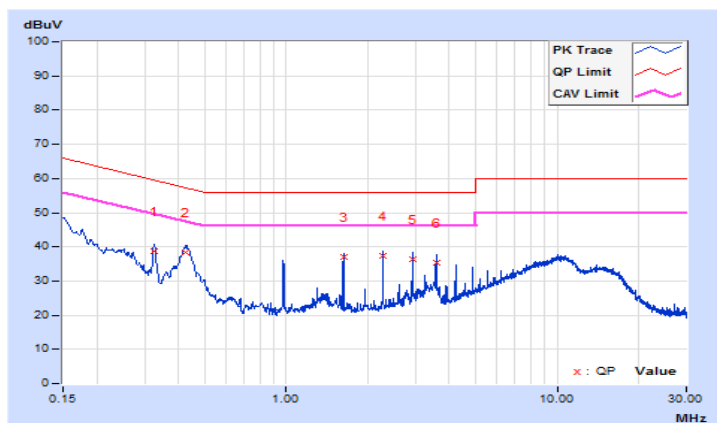

Phase	Line (L)	Detector Function	Quasi-Peak (QP) / Average (AV)
Test Mode	B		

No	Freq. [MHz]	Corr. Factor (dB)	Reading Value [dB (uV)]		Emission Level [dB (uV)]		Limit [dB (uV)]		Margin (dB)	
			Q.P.	AV.	Q.P.	AV.	Q.P.	AV.	Q.P.	AV.
			1	0.15000	9.69	37.61	21.95	47.30	31.64	66.00
2	0.17344	9.69	33.09	18.03	42.78	27.72	64.79	54.79	-22.01	-27.07
3	0.19297	9.68	29.88	14.85	39.56	24.53	63.91	53.91	-24.35	-29.38
4	0.40000	9.68	23.85	16.78	33.53	26.46	57.85	47.85	-24.32	-21.39
5	3.57813	9.74	16.87	12.16	26.61	21.90	56.00	46.00	-29.39	-24.10
6	9.83594	9.87	22.47	16.72	32.34	26.59	60.00	50.00	-27.66	-23.41

Remarks:

1. Q.P. and AV. are abbreviations of quasi-peak and average individually.
2. The emission levels of other frequencies were very low against the limit.
3. Margin value = Emission level - Limit value
4. Correction factor = Insertion loss + Cable loss
5. Emission Level = Correction Factor + Reading Value.

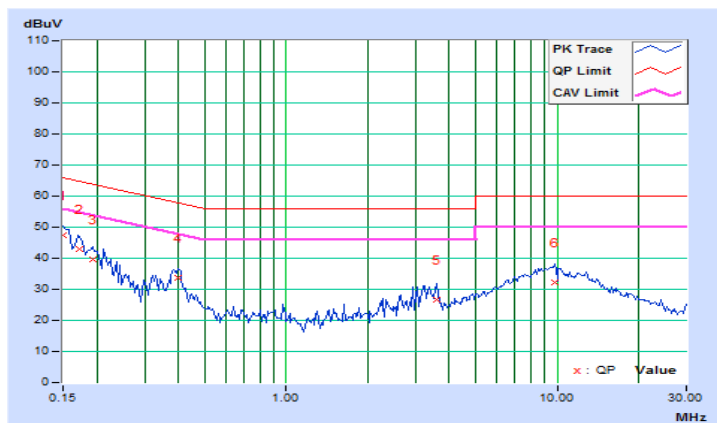

Phase	Neutral (N)	Detector Function	Quasi-Peak (QP) / Average (AV)
Test Mode	B		

No	Freq. [MHz]	Corr. Factor (dB)	Reading Value [dB (uV)]		Emission Level [dB (uV)]		Limit [dB (uV)]		Margin (dB)	
			Q.P.	AV.	Q.P.	AV.	Q.P.	AV.	Q.P.	AV.
			1	0.15391	9.66	36.45	21.29	46.11	30.95	65.79
2	0.16172	9.66	35.63	19.23	45.29	28.89	65.38	55.38	-20.09	-26.49
3	0.17734	9.66	32.45	17.20	42.11	26.86	64.61	54.61	-22.50	-27.75
4	0.39609	9.65	22.16	15.25	31.81	24.90	57.93	47.93	-26.12	-23.03
5	3.19141	9.70	15.72	6.43	25.42	16.13	56.00	46.00	-30.58	-29.87
6	10.08203	9.85	22.47	16.56	32.32	26.41	60.00	50.00	-27.68	-23.59

Remarks:

1. Q.P. and AV. are abbreviations of quasi-peak and average individually.
2. The emission levels of other frequencies were very low against the limit.
3. Margin value = Emission level - Limit value
4. Correction factor = Insertion loss + Cable loss
5. Emission Level = Correction Factor + Reading Value.

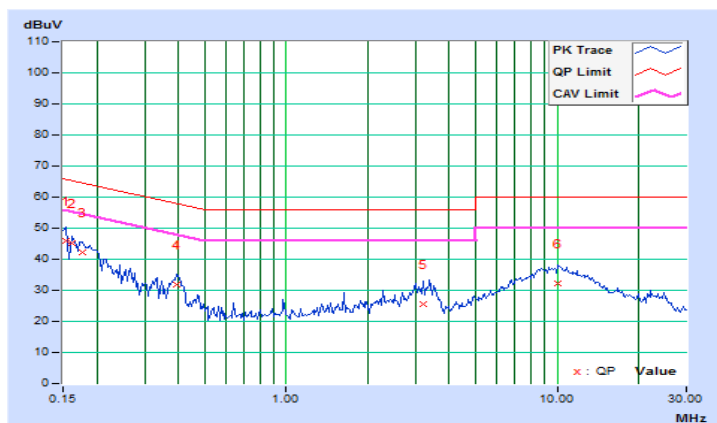

4.3 Transmit Power Measurement

4.3.1 Limits of Transmit Power Measurement

Operation Band	EUT Category		Limit
U-NII-1		Outdoor Access Point	1 Watt (30 dBm) (Max. e.i.r.p \leq 125mW(21 dBm) at any elevation angle above 30 degrees as measured from the horizon)
		Fixed point-to-point Access Point	1 Watt (30 dBm)
		Indoor Access Point	1 Watt (30 dBm)
	√	Mobile and Portable client device	250mW (24 dBm)
U-NII-2A	√		250mW (24 dBm) or 11 dBm+10 log B*
U-NII-2C	√		250mW (24 dBm) or 11 dBm+10 log B*
U-NII-3	√		1 Watt (30 dBm)

*B is the 26 dB emission bandwidth in megahertz

Per KDB 662911 Method of conducted output power measurement on IEEE 802.11 devices,

Array Gain = 0 dB (i.e., no array gain) for $N_{ANT} \leq 4$;

Array Gain = 0 dB (i.e., no array gain) for channel widths ≥ 40 MHz for any N_{ANT} ;

Array Gain = $5 \log(N_{ANT}/N_{SS})$ dB or 3 dB, whichever is less for 20-MHz channel widths with $N_{ANT} \geq 5$.

For power measurements on all other devices: Array Gain = $10 \log(N_{ANT}/N_{SS})$ dB.

4.3.2 Test Setup

For Power Output

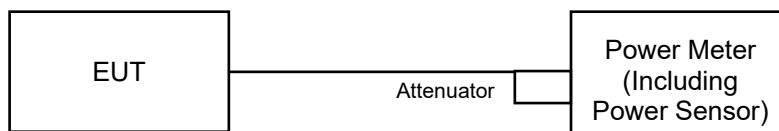

For 26dB Bandwidth

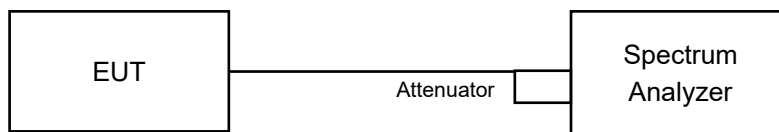

4.3.3 Test Instruments

Refer to section 4.1.2 to get information of above instrument.

4.3.4 Test Procedure

For Average Power Measurement

Method PM is used to perform output power measurement, trigger and gating function of wide band power meter is enabled to measure max output power of TX on burst and set the detector to average. Duty factor is not added to measured value.

For 26dB Bandwidth

- a. Set RBW = approximately 1% of the emission bandwidth.
- b. Set the VBW > RBW.
- c. Detector = Peak.
- d. Trace mode = max hold.
- e. Measure the maximum width of the emission that is 26 dB down from the peak of the emission. Compare this with the RBW setting of the analyzer. Readjust RBW and repeat measurement as needed until the RBW/EBW ratio is approximately 1%.

4.3.5 Deviation from Test Standard

No deviation.

4.3.6 EUT Operating Conditions

The software provided by client to enable the EUT under transmission condition continuously at lowest, middle and highest channel frequencies individually.

4.3.7 Test Result

Power Output:

1TX

802.11a

Chan.	Freq. (MHz)	Maximum Conducted Power (mW)	Maximum Conducted Power (dBm)	Power Limit (dBm)	Pass / Fail
36	5180	104.472	20.19	24.00	Pass
40	5200	107.399	20.31	24.00	Pass
48	5240	98.175	19.92	24.00	Pass
52	5260	111.429	20.47	24.00	Pass
60	5300	113.501	20.55	24.00	Pass
64	5320	108.643	20.36	24.00	Pass
100	5500	154.882	21.90	24.00	Pass
116	5580	168.267	22.26	24.00	Pass
140	5700	154.525	21.89	24.00	Pass
149	5745	217.771	23.38	30.00	Pass
157	5785	213.796	23.30	30.00	Pass
165	5825	218.273	23.39	30.00	Pass

Note:

For U-NII-2A, U-NII-2C Band:

1. $11\text{dBm} + 10\log(32.90) = 26.17 > 24\text{dBm}$
2. $11\text{dBm} + 10\log(32.49) = 26.11 > 24\text{dBm}$
3. $11\text{dBm} + 10\log(32.38) = 26.10 > 24\text{dBm}$
4. $11\text{dBm} + 10\log(26.98) = 25.31 > 24\text{dBm}$
5. $11\text{dBm} + 10\log(26.54) = 25.23 > 24\text{dBm}$
6. $11\text{dBm} + 10\log(25.32) = 25.03 > 24\text{dBm}$

802.11n (HT20)

Chan.	Freq. (MHz)	Maximum Conducted Power (mW)	Maximum Conducted Power (dBm)	Power Limit (dBm)	Pass / Fail
36	5180	98.401	19.93	24.00	Pass
40	5200	103.992	20.17	24.00	Pass
48	5240	99.312	19.97	24.00	Pass
52	5260	113.501	20.55	24.00	Pass
60	5300	111.429	20.47	24.00	Pass
64	5320	110.154	20.42	24.00	Pass
100	5500	152.405	21.83	24.00	Pass
116	5580	171.791	22.35	24.00	Pass
140	5700	122.462	20.88	24.00	Pass
149	5745	217.771	23.38	30.00	Pass
157	5785	211.349	23.25	30.00	Pass
165	5825	209.411	23.21	30.00	Pass

Note:

For U-NII-2A, U-NII-2C Band:

1. $11\text{dBm} + 10\log(32.80) = 26.15 > 24\text{dBm}$
2. $11\text{dBm} + 10\log(30.08) = 25.78 > 24\text{dBm}$
3. $11\text{dBm} + 10\log(31.37) = 25.96 > 24\text{dBm}$
4. $11\text{dBm} + 10\log(28.96) = 25.61 > 24\text{dBm}$
5. $11\text{dBm} + 10\log(29.21) = 25.65 > 24\text{dBm}$
6. $11\text{dBm} + 10\log(29.38) = 25.68 > 24\text{dBm}$

802.11n (HT40)

Chan.	Freq. (MHz)	Maximum Conducted Power (mW)	Maximum Conducted Power (dBm)	Power Limit (dBm)	Pass / Fail
38	5190	66.069	18.20	24.00	Pass
46	5230	110.917	20.45	24.00	Pass
54	5270	108.143	20.34	24.00	Pass
62	5310	74.989	18.75	24.00	Pass
102	5510	85.114	19.30	24.00	Pass
110	5550	190.546	22.80	24.00	Pass
134	5670	165.959	22.20	24.00	Pass
151	5755	239.332	23.79	30.00	Pass
159	5795	239.332	23.79	30.00	Pass

Note:

For U-NII-2A, U-NII-2C Band:

1. $11\text{dBm} + 10\log(76.67) = 29.84 > 24\text{dBm}$
2. $11\text{dBm} + 10\log(42.07) = 27.23 > 24\text{dBm}$
3. $11\text{dBm} + 10\log(42.05) = 27.23 > 24\text{dBm}$
4. $11\text{dBm} + 10\log(78.64) = 29.95 > 24\text{dBm}$
5. $11\text{dBm} + 10\log(85.34) = 30.31 > 24\text{dBm}$

802.11ac (VHT80)

Chan.	Freq. (MHz)	Maximum Conducted Power (mW)	Maximum Conducted Power (dBm)	Power Limit (dBm)	Pass / Fail
42	5210	67.298	18.28	24.00	Pass
58	5290	66.527	18.23	24.00	Pass
106	5530	67.608	18.30	24.00	Pass
155	5775	234.963	23.71	30.00	Pass

Note:

For U-NII-2A, U-NII-2C Band:

1. $11\text{dBm} + 10\log(84.15) = 30.25 > 24\text{dBm}$
2. $11\text{dBm} + 10\log(84.37) = 30.26 > 24\text{dBm}$

2TX
802.11a

Chan.	Freq. (MHz)	Maximum Conducted Power (dBm)		Total Power (mW)	Total Power (dBm)	Power Limit (dBm)	Pass / Fail
		Chain 0	Chain 1				
36	5180	15.23	15.48	68.661	18.37	24.00	Pass
40	5200	15.31	15.55	69.855	18.44	24.00	Pass
48	5240	14.58	14.69	58.152	17.65	24.00	Pass
52	5260	17.65	17.58	115.490	20.63	24.00	Pass
60	5300	17.61	17.52	114.171	20.58	24.00	Pass
64	5320	17.55	17.46	112.604	20.52	24.00	Pass
100	5500	19.97	19.64	191.357	22.82	24.00	Pass
116	5580	20.29	20.03	207.598	23.17	24.00	Pass
140	5700	19.94	19.99	198.398	22.98	24.00	Pass
149	5745	23.41	23.42	439.066	26.43	30.00	Pass
157	5785	23.59	23.40	447.336	26.51	30.00	Pass
165	5825	23.44	23.32	435.583	26.39	30.00	Pass

Note:

For U-NII-2A, U-NII-2C Band:

Chain 0

1. $11\text{dBm} + 10\log(23.82) = 24.76 > 24\text{dBm}$
2. $11\text{dBm} + 10\log(23.79) = 24.76 > 24\text{dBm}$
3. $11\text{dBm} + 10\log(24.23) = 24.84 > 24\text{dBm}$
4. $11\text{dBm} + 10\log(24.03) = 24.80 > 24\text{dBm}$
5. $11\text{dBm} + 10\log(23.70) = 24.74 > 24\text{dBm}$
6. $11\text{dBm} + 10\log(26.94) = 25.30 > 24\text{dBm}$

Chain 1

1. $11\text{dBm} + 10\log(23.89) = 24.78 > 24\text{dBm}$
2. $11\text{dBm} + 10\log(23.74) = 24.75 > 24\text{dBm}$
3. $11\text{dBm} + 10\log(24.06) = 24.81 > 24\text{dBm}$
4. $11\text{dBm} + 10\log(24.12) = 24.82 > 24\text{dBm}$
5. $11\text{dBm} + 10\log(23.64) = 24.73 > 24\text{dBm}$
6. $11\text{dBm} + 10\log(26.95) = 25.30 > 24\text{dBm}$

802.11n (HT20)

Chan.	Freq. (MHz)	Maximum Conducted Power (dBm)		Total Power (mW)	Total Power (dBm)	Power Limit (dBm)	Pass / Fail
		Chain 0	Chain 1				
36	5180	15.59	15.67	73.122	18.64	24.00	Pass
40	5200	15.22	15.36	67.622	18.30	24.00	Pass
48	5240	14.74	14.63	58.825	17.70	24.00	Pass
52	5260	17.35	17.55	111.210	20.46	24.00	Pass
60	5300	17.45	17.63	113.533	20.55	24.00	Pass
64	5320	17.51	17.42	111.572	20.48	24.00	Pass
100	5500	20.49	20.17	215.936	23.34	24.00	Pass
116	5580	20.50	20.46	223.375	23.49	24.00	Pass
140	5700	20.47	20.40	221.077	23.45	24.00	Pass
149	5745	23.50	23.45	445.181	26.49	30.00	Pass
157	5785	23.58	23.34	443.808	26.47	30.00	Pass
165	5825	23.50	23.38	441.643	26.45	30.00	Pass

Note:

For U-NII-2A, U-NII-2C Band:

Chain 0

1. $11\text{dBm} + 10\log(24.10) = 24.82 > 24\text{dBm}$
2. $11\text{dBm} + 10\log(24.91) = 24.96 > 24\text{dBm}$
3. $11\text{dBm} + 10\log(24.23) = 24.84 > 24\text{dBm}$
4. $11\text{dBm} + 10\log(27.46) = 25.38 > 24\text{dBm}$
5. $11\text{dBm} + 10\log(25.06) = 24.98 > 24\text{dBm}$
6. $11\text{dBm} + 10\log(29.30) = 25.66 > 24\text{dBm}$

Chain 1

1. $11\text{dBm} + 10\log(25.28) = 25.02 > 24\text{dBm}$
2. $11\text{dBm} + 10\log(23.92) = 24.78 > 24\text{dBm}$
3. $11\text{dBm} + 10\log(24.23) = 24.84 > 24\text{dBm}$
4. $11\text{dBm} + 10\log(28.34) = 25.52 > 24\text{dBm}$
5. $11\text{dBm} + 10\log(24.53) = 24.89 > 24\text{dBm}$
6. $11\text{dBm} + 10\log(29.90) = 25.75 > 24\text{dBm}$

802.11n (HT40)

Chan.	Freq. (MHz)	Maximum Conducted Power (dBm)		Total Power (mW)	Total Power (dBm)	Power Limit (dBm)	Pass / Fail
		Chain 0	Chain 1				
38	5190	17.63	17.45	113.533	20.55	24.00	Pass
46	5230	17.63	17.41	113.024	20.53	24.00	Pass
54	5270	17.55	17.62	114.695	20.60	24.00	Pass
62	5310	17.53	17.38	111.326	20.47	24.00	Pass
102	5510	19.57	18.74	165.390	22.19	24.00	Pass
110	5550	20.82	20.67	237.462	23.76	24.00	Pass
134	5670	20.97	20.90	248.053	23.95	24.00	Pass
151	5755	23.43	23.36	437.063	26.41	30.00	Pass
159	5795	23.51	23.38	442.159	26.46	30.00	Pass

Note:

For U-NII-2A, U-NII-2C Band:

Chain 0

1. $11\text{dBm} + 10\log(42.19) = 27.25 > 24\text{dBm}$
2. $11\text{dBm} + 10\log(41.87) = 27.21 > 24\text{dBm}$
3. $11\text{dBm} + 10\log(42.17) = 27.25 > 24\text{dBm}$
4. $11\text{dBm} + 10\log(42.42) = 27.27 > 24\text{dBm}$
5. $11\text{dBm} + 10\log(50.03) = 27.99 > 24\text{dBm}$

Chain 1

1. $11\text{dBm} + 10\log(42.24) = 27.25 > 24\text{dBm}$
2. $11\text{dBm} + 10\log(42.09) = 27.24 > 24\text{dBm}$
3. $11\text{dBm} + 10\log(42.30) = 27.26 > 24\text{dBm}$
4. $11\text{dBm} + 10\log(41.96) = 27.22 > 24\text{dBm}$
5. $11\text{dBm} + 10\log(48.41) = 27.84 > 24\text{dBm}$

802.11ac (VHT80)

Chan.	Freq. (MHz)	Maximum Conducted Power (dBm)		Total Power (mW)	Total Power (dBm)	Power Limit (dBm)	Pass / Fail
		Chain 0	Chain 1				
42	5210	17.62	17.55	114.695	20.60	24.00	Pass
58	5290	17.66	17.62	116.155	20.65	24.00	Pass
106	5530	18.66	18.45	143.435	21.57	24.00	Pass
155	5775	22.88	22.79	384.197	25.85	30.00	Pass

Note:

For U-NII-2A, U-NII-2C Band:

Chain 0

1. $11\text{dBm} + 10\log(83.95) = 30.24 > 24\text{dBm}$
2. $11\text{dBm} + 10\log(84.26) = 30.25 > 24\text{dBm}$

Chain 1

1. $11\text{dBm} + 10\log(83.68) = 30.22 > 24\text{dBm}$
2. $11\text{dBm} + 10\log(82.73) = 30.17 > 24\text{dBm}$

26dB Bandwidth:

1TX

802.11a

Chan.	Freq. (MHz)	26dBc Bandwidth (MHz)
52	5260	32.90
60	5300	32.49
64	5320	32.38
100	5500	26.98
116	5580	26.54
140	5700	25.32

802.11n (HT20)

Chan.	Freq. (MHz)	26dBc Bandwidth (MHz)
52	5260	32.80
60	5300	30.08
64	5320	31.37
100	5500	28.96
116	5580	29.21
140	5700	29.38

802.11n (HT40)

Chan.	Freq. (MHz)	26dBc Bandwidth (MHz)
54	5270	76.67
62	5310	42.07
102	5510	42.05
110	5550	78.64
134	5670	85.34

802.11ac (VHT80)

Chan.	Freq. (MHz)	26dBc Bandwidth (MHz)
58	5290	84.15
106	5530	84.37

Spectrum Plot of Worst Value

802.11a

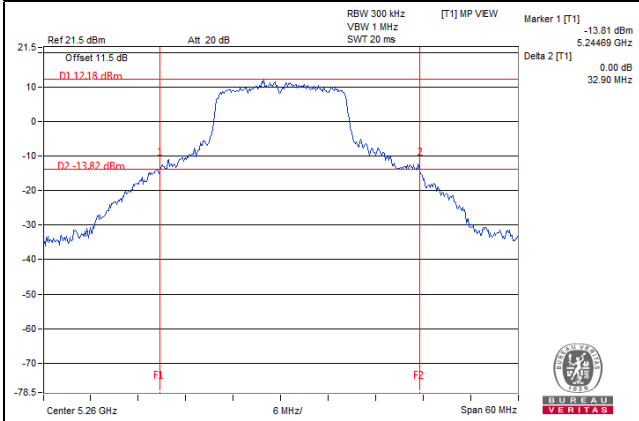

802.11n (HT20)

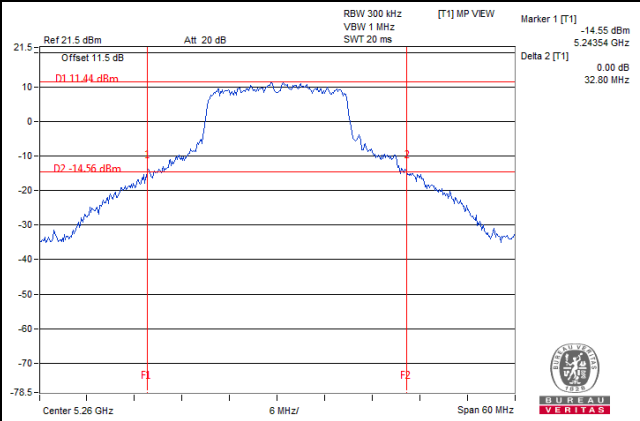

802.11n (HT40)

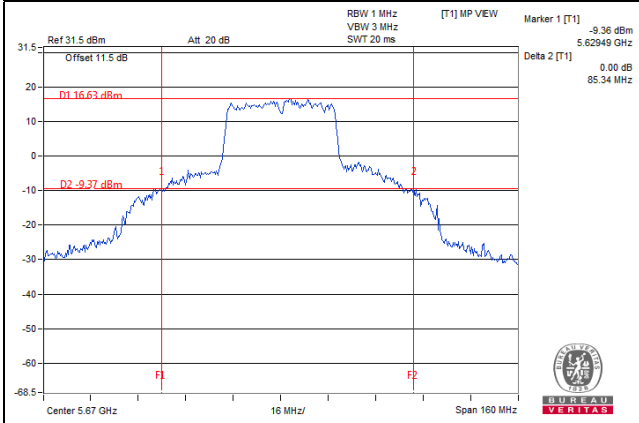

802.11ac (VHT80)

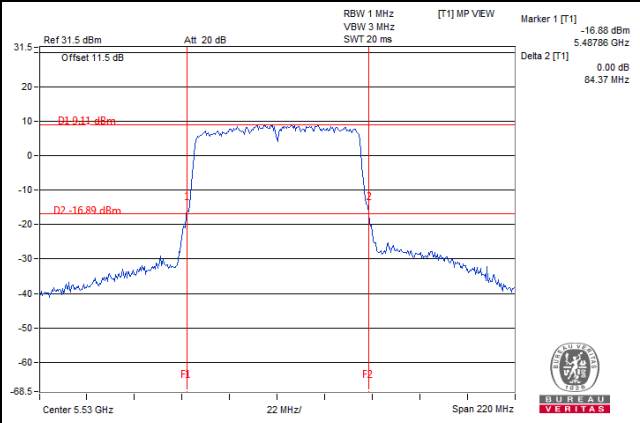

2TX

802.11a

Chan.	Freq. (MHz)	26dBc Bandwidth (MHz)	
		Chain 0	Chain 1
52	5260	23.82	23.89
60	5300	23.79	23.74
64	5320	24.23	24.06
100	5500	24.03	24.12
116	5580	23.70	23.64
140	5700	26.94	26.95

802.11n (HT20)

Chan.	Freq. (MHz)	26dBc Bandwidth (MHz)	
		Chain 0	Chain 1
52	5260	24.10	25.28
60	5300	24.91	23.92
64	5320	24.23	24.23
100	5500	27.46	28.34
116	5580	25.06	24.53
140	5700	29.30	29.90

802.11n (HT40)

Chan.	Freq. (MHz)	26dBc Bandwidth (MHz)	
		Chain 0	Chain 1
54	5270	42.19	42.24
62	5310	41.87	42.09
102	5510	42.17	42.30
110	5550	42.42	41.96
134	5670	50.03	48.41

802.11ac (VHT80)

Chan.	Freq. (MHz)	26dBc Bandwidth (MHz)	
		Chain 0	Chain 1
58	5290	83.95	83.68
106	5530	84.26	82.73

Spectrum Plot of Worst Value

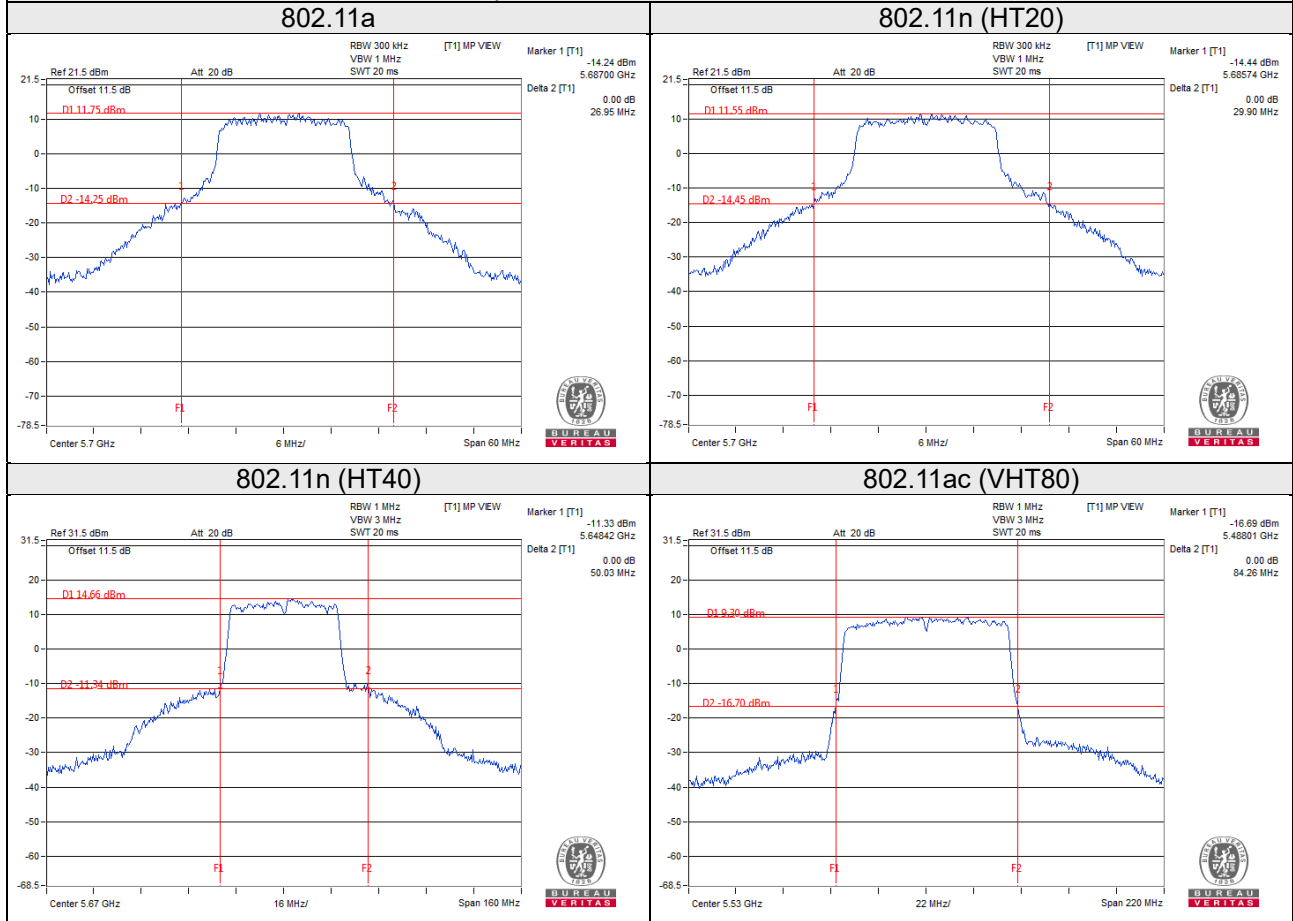

EUT Maximum Conducted Power

1TX

802.11a

Frequency Band (MHz)	Max. Power	
	Output Power (mW)	Output Power (dBm)
5250~5350	113.501	20.55
5470~5725	168.267	22.26

802.11n (HT20)

Frequency Band (MHz)	Max. Power	
	Output Power (mW)	Output Power (dBm)
5250~5350	113.501	20.55
5470~5725	171.791	22.35

802.11n (HT40)

Frequency Band (MHz)	Max. Power	
	Output Power (mW)	Output Power (dBm)
5250~5350	108.143	20.34
5470~5725	190.546	22.80

802.11ac (VHT80)

Frequency Band (MHz)	Max. Power	
	Output Power (mW)	Output Power (dBm)
5250~5350	66.527	18.23
5470~5725	67.608	18.30

2TX

802.11a

Frequency Band (MHz)	Max. Power	
	Output Power (mW)	Output Power (dBm)
5250~5350	115.490	20.63
5470~5725	207.598	23.17

802.11n (HT20)

Frequency Band (MHz)	Max. Power	
	Output Power (mW)	Output Power (dBm)
5250~5350	113.533	20.55
5470~5725	223.375	23.49

802.11n (HT40)

Frequency Band (MHz)	Max. Power	
	Output Power (mW)	Output Power (dBm)
5250~5350	114.695	20.60
5470~5725	248.053	23.95

802.11ac (VHT80)

Frequency Band (MHz)	Max. Power	
	Output Power (mW)	Output Power (dBm)
5250~5350	116.155	20.65
5470~5725	143.435	21.57

4.4 Occupied Bandwidth Measurement

4.4.1 Test Setup

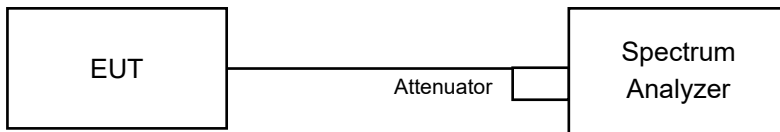

4.4.2 Test Instruments

Refer to section 4.1.2 to get information of above instrument.

4.4.3 Test Procedure

The transmitter output was connected to the spectrum analyzer through an attenuator. The bandwidth of the fundamental frequency was measured by spectrum analyzer with resolution bandwidth in the range of 1% to 5% of the anticipated emission bandwidth, and a video bandwidth at least 3x the resolution bandwidth and set the detector to sampling. The width of a frequency band such that, below the lower and above the upper frequency limits, the mean powers emitted are each equal to a specified percentage 0.5 %of the total mean power of a given emission.

4.4.4 Test Result

1TX

802.11a

Chan.	Freq. (MHz)	Occupied Bandwidth (MHz)
36	5180	18.00
40	5200	18.60
48	5240	18.60
52	5260	18.48
60	5300	17.64
64	5320	17.88
100	5500	17.40
116	5580	17.04
140	5700	17.04
149	5745	20.17
157	5785	21.72
165	5825	20.26

802.11n (HT20)

Chan.	Freq. (MHz)	Occupied Bandwidth (MHz)
36	5180	18.48
40	5200	19.44
48	5240	18.60
52	5260	18.96
60	5300	18.60
64	5320	18.36
100	5500	18.24
116	5580	18.24
140	5700	18.36
149	5745	30.48
157	5785	31.80
165	5825	32.52

802.11n (HT40)

Chan.	Freq. (MHz)	Occupied Bandwidth (MHz)
38	5190	36.72
46	5230	37.32
54	5270	37.20
62	5310	36.60
102	5510	36.72
110	5550	37.32
134	5670	38.04
151	5755	43.56
159	5795	47.28

802.11ac (VHT80)

Chan.	Freq. (MHz)	Occupied Bandwidth (MHz)
42	5210	75.60
58	5290	75.84
106	5530	75.84
155	5775	85.68

Spectrum Plot of Worst Value

802.11a

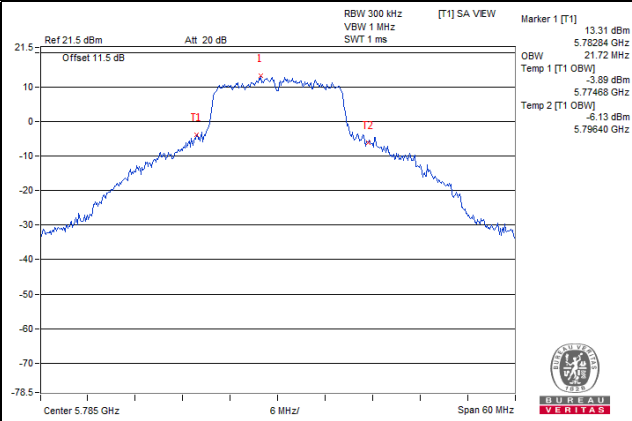

802.11n (HT20)

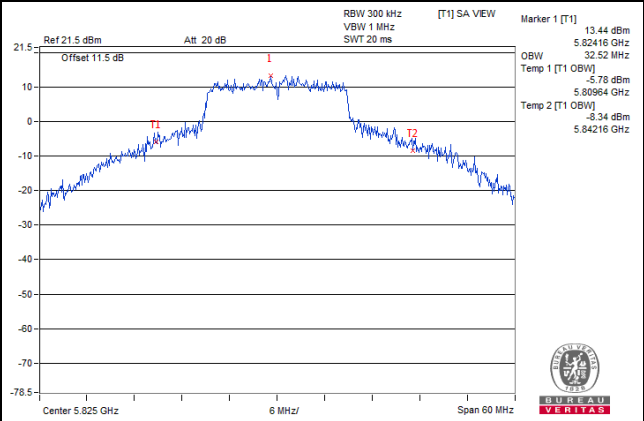

802.11n (HT40)

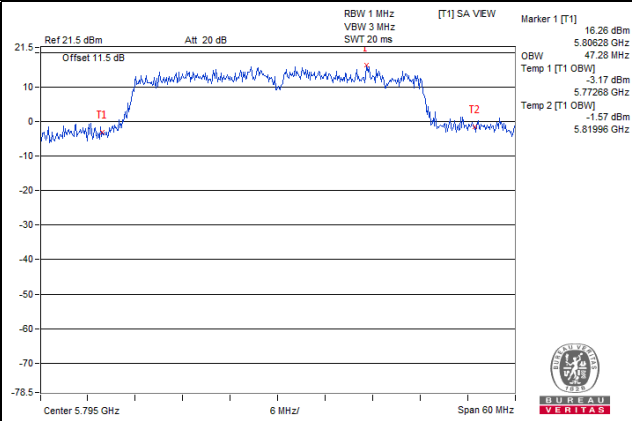

802.11ac (VHT80)

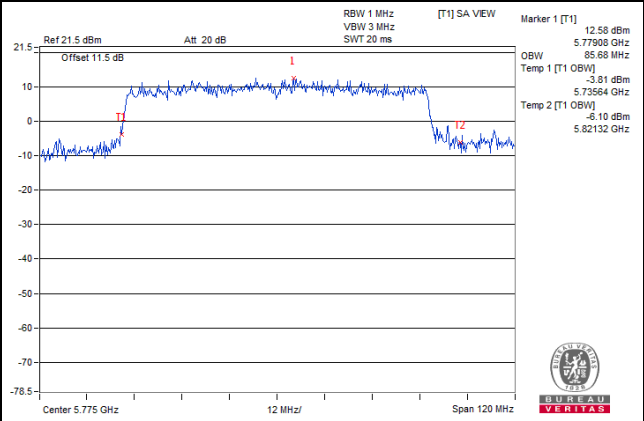

2TX

802.11a

Chan.	Freq. (MHz)	Occupied Bandwidth (MHz)	
		Chain 0	Chain 1
36	5180	16.80	16.80
40	5200	16.80	16.56
48	5240	16.68	16.68
52	5260	16.80	16.80
60	5300	16.68	16.56
64	5320	16.80	16.80
100	5500	16.80	16.56
116	5580	16.68	16.68
140	5700	17.04	17.16
149	5745	18.72	29.76
157	5785	29.52	29.76
165	5825	20.76	17.76

802.11n (HT20)

Chan.	Freq. (MHz)	Occupied Bandwidth (MHz)	
		Chain 0	Chain 1
36	5180	17.88	18.00
40	5200	18.00	17.88
48	5240	17.88	17.76
52	5260	18.00	17.88
60	5300	18.00	17.88
64	5320	17.88	17.88
100	5500	18.00	18.00
116	5580	17.88	17.88
140	5700	18.48	18.48
149	5745	29.28	29.52
157	5785	31.44	31.08
165	5825	33.72	30.84

802.11n (HT40)

Chan.	Freq. (MHz)	Occupied Bandwidth (MHz)	
		Chain 0	Chain 1
38	5190	36.60	36.60
46	5230	36.72	36.60
54	5270	36.60	36.60
62	5310	36.72	36.60
102	5510	36.72	36.60
110	5550	36.72	36.72
134	5670	36.96	36.72
151	5755	47.04	36.72
159	5795	36.96	45.36

802.11ac (VHT80)

Chan.	Freq. (MHz)	Occupied Bandwidth (MHz)	
		Chain 0	Chain 1
42	5210	75.84	76.08
58	5290	75.84	75.84
106	5530	75.84	75.84
155	5775	77.04	78.24

Spectrum Plot of Worst Value

802.11a

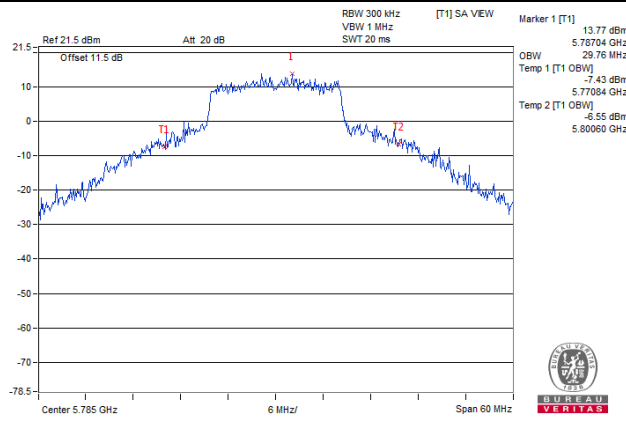

802.11n (HT20)

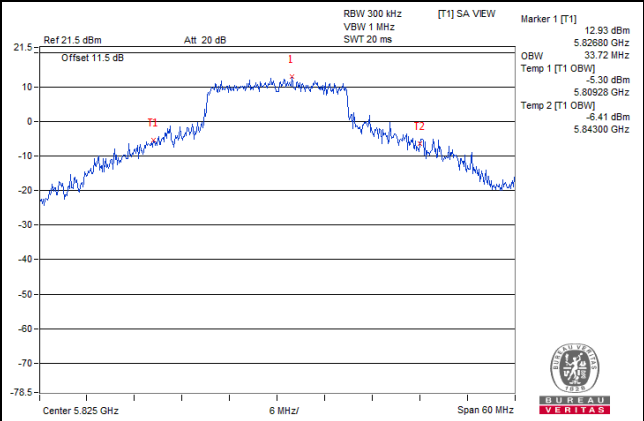

802.11n (HT40)

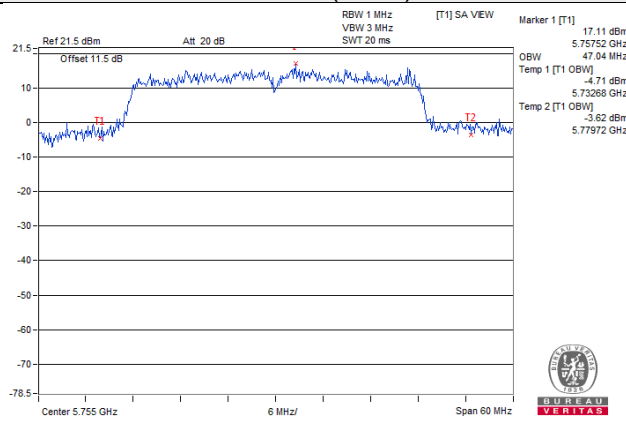

802.11ac (VHT80)

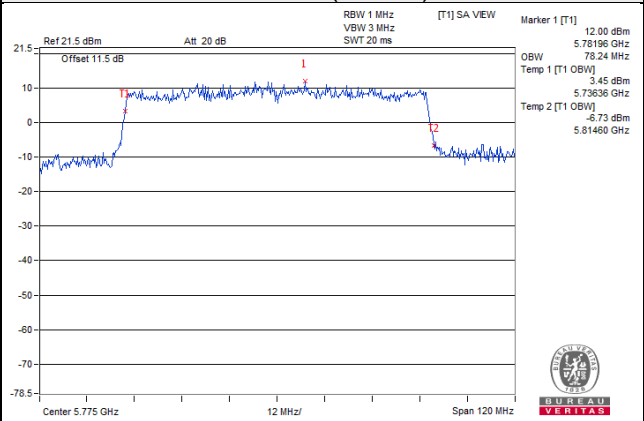

4.5 Peak Power Spectral Density Measurement

4.5.1 Limits of Peak Power Spectral Density Measurement

Operation Band	EUT Category		Limit
U-NII-1		Outdoor Access Point	17dBm/ MHz
		Fixed point-to-point Access Point	
		Indoor Access Point	
	√	Mobile and Portable client device	11dBm/ MHz
U-NII-2A	√		11dBm/ MHz
U-NII-2C	√		11dBm/ MHz
U-NII-3	√		30dBm/ 500kHz

4.5.2 Test Setup

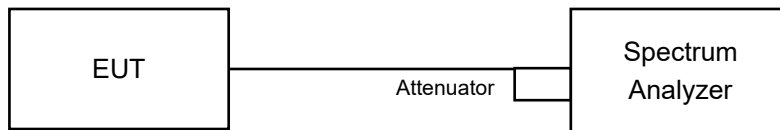

4.5.3 Test Instruments

Refer to section 4.1.2 to get information of above instrument.

4.5.4 Test Procedures

For U-NII-1, U-NII-2A and U-NII-2C band:

Duty cycle of test signal is > 98%

Using method SA-1

- Set span to encompass the entire emission bandwidth (EBW) of the signal.
- Set RBW = 1 MHz, Set VBW ≥ 3 MHz, Detector = RMS
- Sweep time = auto, trigger set to “free run”.
- Trace average at least 100 traces in power averaging mode.
- Record the max value

Duty cycle of test signal is < 98%

Using method SA-2

- Set span to encompass the entire emission bandwidth (EBW) of the signal.
- Set RBW = 1MHz, Set VBW ≥ 3 MHz, Detector = RMS
- Set Channel power measure = 1MHz
- Sweep time = auto, trigger set to “free run”.
- Trace average at least 100 traces in power averaging mode.
- Record the max value and add 10 log (1/duty cycle)

For U-NII-3 band:

Duty cycle of test signal is > 98%

- a. Set span to encompass the entire emission bandwidth (EBW) of the signal.
- b. Set RBW = 300 kHz, Set VBW \geq 1 MHz, Detector = RMS
- c. Use the peak marker function to determine the maximum power level in any 300 kHz band segment within the fundamental EBW.
- d. Scale the observed power level to an equivalent value in 500 kHz by adjusting (reducing) the measured power by a bandwidth correction factor (BWCF) where $BWCF = 10\log(500 \text{ kHz}/300\text{kHz})$
- e. Sweep time = auto, trigger set to "free run".
- f. Trace average at least 100 traces in power averaging mode.
- g. Record the max value

Duty cycle of test signal is < 98%

- a. Set span to encompass the entire emission bandwidth (EBW) of the signal.
- b. Set RBW = 300 kHz, Set VBW \geq 1 MHz, Detector = RMS
- c. Use the peak marker function to determine the maximum power level in any 300 kHz band segment within the fundamental EBW.
- d. Scale the observed power level to an equivalent value in 500 kHz by adjusting (reducing) the measured power by a bandwidth correction factor (BWCF) where $BWCF = 10\log(500 \text{ kHz} / 300 \text{ kHz})$
- e. Sweep time = auto, trigger set to "free run".
- f. Trace average at least 100 traces in power averaging mode.
- g. Record the max value and add $10 \log (1/\text{duty cycle})$

4.5.5 Deviation from Test Standard

No deviation.

4.5.6 EUT Operating Conditions

Same as 4.3.6.

4.5.7 Test Results

For U-NII-1, U-NII-2A and U-NII-2C band:

1TX

802.11a

Chan.	Freq. (MHz)	PSD w/o Duty Factor (dBm/MHz)	Duty Factor (dB)	PSD with Duty Factor (dBm/MHz)	Max. Limit (dBm/MHz)	Pass / Fail
36	5180	5.87	0.13	6.00	11.00	Pass
40	5200	6.16	0.13	6.29	11.00	Pass
48	5240	5.96	0.13	6.09	11.00	Pass
52	5260	6.61	0.13	6.74	11.00	Pass
60	5300	6.52	0.13	6.65	11.00	Pass
64	5320	6.67	0.13	6.80	11.00	Pass
100	5500	7.05	0.13	7.18	11.00	Pass
116	5580	7.37	0.13	7.50	11.00	Pass
140	5700	6.99	0.13	7.12	11.00	Pass

Note: Refer to section 3.3 for duty cycle spectrum plot.

802.11n (HT20)

Chan.	Freq. (MHz)	PSD w/o Duty Factor (dBm/MHz)	Duty Factor (dB)	PSD with Duty Factor (dBm/MHz)	Max. Limit (dBm/MHz)	Pass / Fail
36	5180	5.24	0.11	5.35	11.00	Pass
40	5200	5.54	0.11	5.65	11.00	Pass
48	5240	5.65	0.11	5.76	11.00	Pass
52	5260	6.05	0.11	6.16	11.00	Pass
60	5300	6.01	0.11	6.12	11.00	Pass
64	5320	6.12	0.11	6.23	11.00	Pass
100	5500	7.04	0.11	7.15	11.00	Pass
116	5580	7.83	0.11	7.94	11.00	Pass
140	5700	6.36	0.11	6.47	11.00	Pass

Note: Refer to section 3.3 for duty cycle spectrum plot.

802.11n (HT40)

Chan.	Freq. (MHz)	PSD w/o Duty Factor (dBm/MHz)	Duty Factor (dB)	PSD with Duty Factor (dBm/MHz)	Max. Limit (dBm/MHz)	Pass / Fail
38	5190	0.53	0.18	0.71	11.00	Pass
46	5230	3.37	0.18	3.55	11.00	Pass
54	5270	3.55	0.18	3.73	11.00	Pass
62	5310	1.60	0.18	1.78	11.00	Pass
102	5510	2.27	0.18	2.45	11.00	Pass
110	5550	5.68	0.18	5.86	11.00	Pass
134	5670	5.09	0.18	5.27	11.00	Pass

Note: Refer to section 3.3 for duty cycle spectrum plot.

802.11ac (VHT80)

Chan.	Freq. (MHz)	PSD w/o Duty Factor (dBm/MHz)	Duty Factor (dB)	PSD with Duty Factor (dBm/MHz)	Max. Limit (dBm/MHz)	Pass / Fail
42	5210	-2.54	0.49	-2.05	11.00	Pass
58	5290	-2.36	0.49	-1.87	11.00	Pass
106	5530	-1.87	0.49	-1.38	11.00	Pass

Note: Refer to section 3.3 for duty cycle spectrum plot.

Spectrum Plot of Worst Value

802.11a

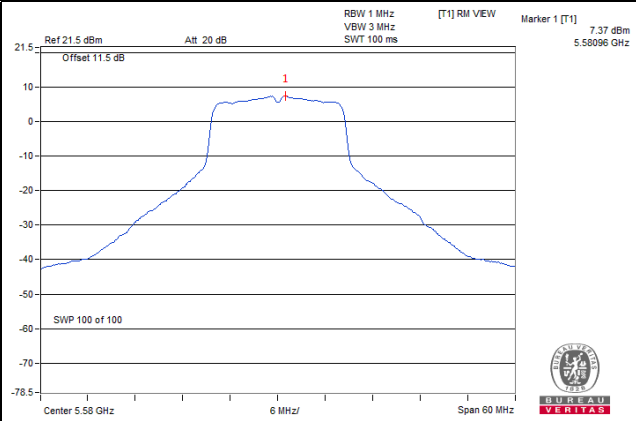

802.11n (HT20)

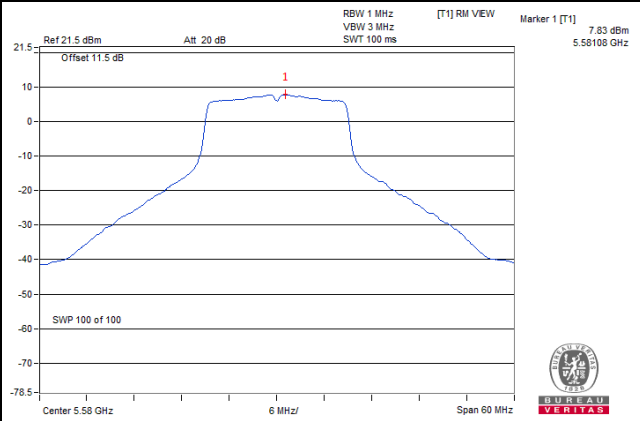

802.11n (HT40)

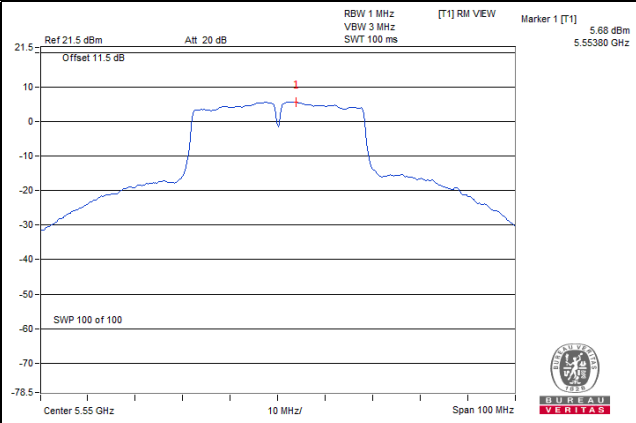

802.11ac (VHT80)

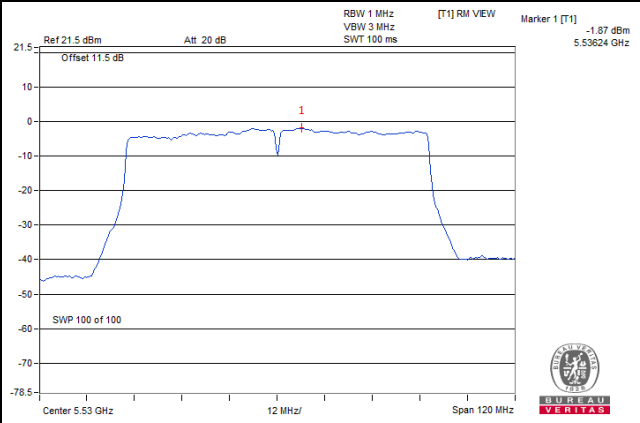

2TX

802.11a

Chan.	Freq. (MHz)	PSD (dBm/MHz)		Total PSD (dBm/MHz)	Max. Limit (dBm/MHz)	Pass / Fail
		Chain 0	Chain 1			
36	5180	1.51	1.20	4.37	11.00	Pass
40	5200	1.58	1.56	4.58	11.00	Pass
48	5240	1.54	1.53	4.55	11.00	Pass
52	5260	4.85	4.50	7.69	11.00	Pass
60	5300	4.93	4.54	7.75	11.00	Pass
64	5320	4.88	4.54	7.72	11.00	Pass
100	5500	6.18	5.85	9.03	11.00	Pass
116	5580	6.03	6.12	9.09	11.00	Pass
140	5700	6.13	6.05	9.10	11.00	Pass

Note:

1. Method 1 of power density measurement of KDB 662911 is using for calculating total power density. Total power density is summing entire spectra across corresponding frequency bins on the various outputs by computer.
2. Directional Gain = $2.34\text{dBi} + 10\log(2) = 5.35\text{dBi} < 6\text{dBi}$, so the power density limit not need to reduce.

802.11n (HT20)

Chan.	Freq. (MHz)	PSD (dBm/MHz)		Total PSD (dBm/MHz)	Max. Limit (dBm/MHz)	Pass / Fail
		Chain 0	Chain 1			
36	5180	1.37	1.40	4.40	11.00	Pass
40	5200	1.33	1.18	4.27	11.00	Pass
48	5240	1.50	1.25	4.39	11.00	Pass
52	5260	4.44	4.08	7.27	11.00	Pass
60	5300	4.02	4.13	7.09	11.00	Pass
64	5320	4.01	4.27	7.15	11.00	Pass
100	5500	6.44	6.00	9.24	11.00	Pass
116	5580	6.11	6.10	9.12	11.00	Pass
140	5700	6.07	6.00	9.05	11.00	Pass

Note:

1. Method 1 of power density measurement of KDB 662911 is using for calculating total power density. Total power density is summing entire spectra across corresponding frequency bins on the various outputs by computer.
2. Directional Gain = $2.34\text{dBi} + 10\log(2) = 5.35\text{dBi} < 6\text{dBi}$, so the power density limit not need to reduce.

802.11n (HT40)

Chan.	Freq. (MHz)	PSD w/o Duty Factor (dBm/MHz)		Duty Factor (dB)	Total PSD with Duty Factor (dBm/MHz)	Max. Limit (dBm/MHz)	Pass / Fail
		Chain 0	Chain 1				
38	5190	0.03	0.04	0.18	3.23	11.00	Pass
46	5230	1.35	0.84	0.18	4.29	11.00	Pass
54	5270	0.74	1.34	0.18	4.24	11.00	Pass
62	5310	1.67	1.34	0.18	4.70	11.00	Pass
102	5510	1.57	1.67	0.18	4.81	11.00	Pass
110	5550	3.35	3.24	0.18	6.49	11.00	Pass
134	5670	3.09	2.95	0.18	6.21	11.00	Pass

Note:

1. Method 1 of power density measurement of KDB 662911 is using for calculating total power density. Total power density is summing entire spectra across corresponding frequency bins on the various outputs by computer.
2. Directional Gain = $2.34\text{dBi} + 10\log(2) = 5.35\text{dBi} < 6\text{dBi}$, so the power density limit not need to reduce.
3. Refer to section 3.3 for duty cycle spectrum plot.

802.11ac (VHT80)

Chan.	Freq. (MHz)	PSD w/o Duty Factor (dBm/MHz)		Duty Factor (dB)	Total PSD with Duty Factor (dBm/MHz)	Max. Limit (dBm/MHz)	Pass / Fail
		Chain 0	Chain 1				
42	5210	-3.23	-3.03	0.33	0.21	11.00	Pass
58	5290	-2.82	-2.95	0.33	0.46	11.00	Pass
106	5530	-1.95	-2.25	0.33	1.24	11.00	Pass

Note:

1. Method 1 of power density measurement of KDB 662911 is using for calculating total power density. Total power density is summing entire spectra across corresponding frequency bins on the various outputs by computer.
2. Directional Gain = $2.34\text{dBi} + 10\log(2) = 5.35\text{dBi} < 6\text{dBi}$, so the power density limit not need to reduce.
3. Refer to section 3.3 for duty cycle spectrum plot.

Spectrum Plot of Worst Value

802.11a / Chain 0 / CH 100

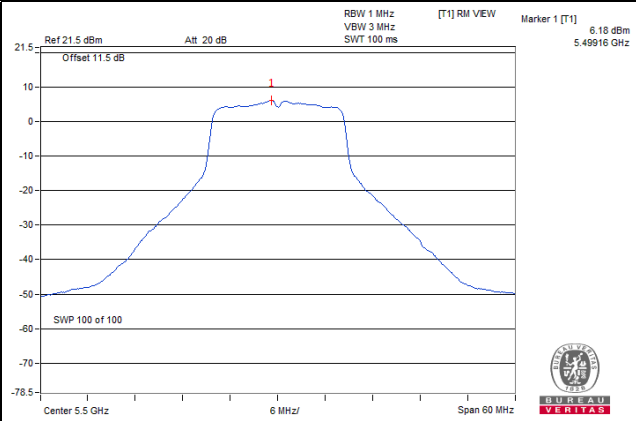

802.11n (HT20) / Chain 0 / CH 100

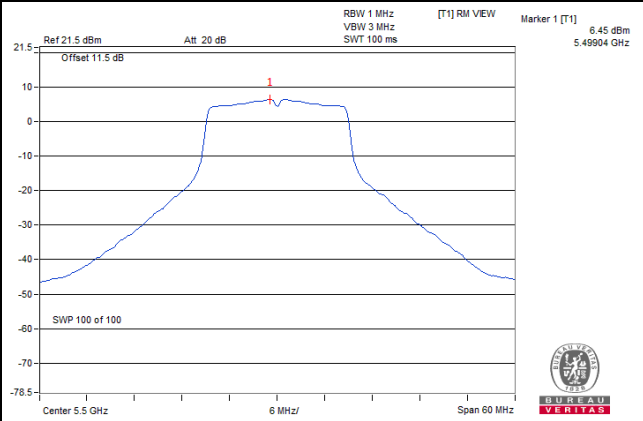

802.11n (HT40) / Chain 0 / CH 110

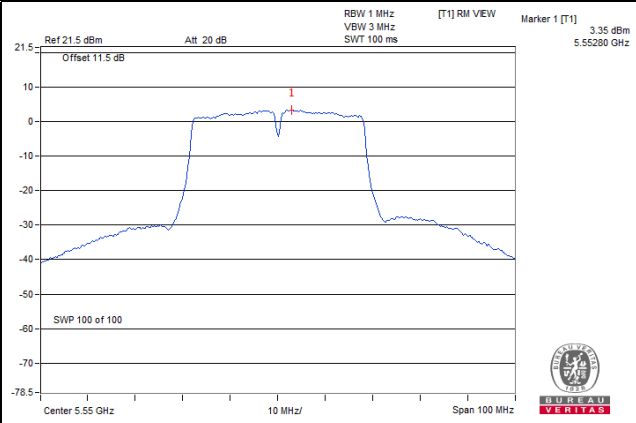

802.11ac (VHT80) / Chain 0 / 106

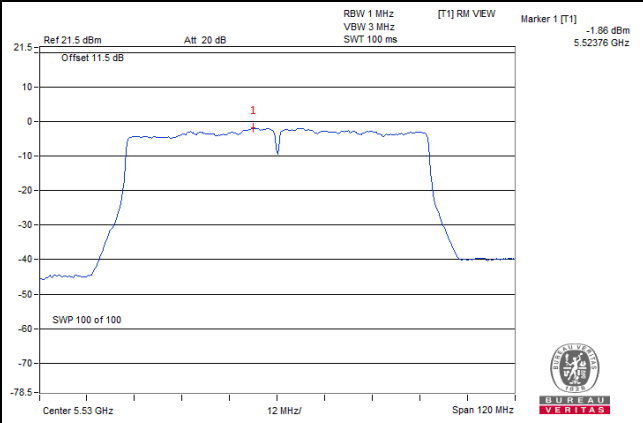

For U-NII-3 band:

1TX

802.11a

Chan.	Freq. (MHz)	PSD w/o Duty Factor		Duty Factor (dB)	Total PSD with Duty Factor (dBm/500kHz)	Limit (dBm/500kHz)	Pass / Fail
		(dBm/300kHz)	(dBm/500kHz)				
149	5745	0.37	2.59	0.13	2.72	30.00	Pass
157	5785	0.55	2.77	0.13	2.90	30.00	Pass
165	5825	0.16	2.38	0.13	2.51	30.00	Pass

Note: Refer to section 3.3 for duty cycle spectrum plot.

802.11n (HT20)

Chan.	Freq. (MHz)	PSD w/o Duty Factor		Duty Factor (dB)	Total PSD with Duty Factor (dBm/500kHz)	Limit (dBm/500kHz)	Pass / Fail
		(dBm/300kHz)	(dBm/500kHz)				
149	5745	1.01	3.23	0.11	3.34	30.00	Pass
157	5785	0.95	3.17	0.11	3.28	30.00	Pass
165	5825	1.05	3.27	0.11	3.38	30.00	Pass

Note: Refer to section 3.3 for duty cycle spectrum plot.

802.11n (HT40)

Chan.	Freq. (MHz)	PSD w/o Duty Factor		Duty Factor (dB)	Total PSD with Duty Factor (dBm/500kHz)	Limit (dBm/500kHz)	Pass / Fail
		(dBm/300kHz)	(dBm/500kHz)				
151	5755	-2.41	-0.19	0.18	-0.01	30.00	Pass
159	5795	-2.19	0.03	0.18	0.21	30.00	Pass

Note: Refer to section 3.3 for duty cycle spectrum plot.

802.11ac (VHT80)

Chan.	Freq. (MHz)	PSD w/o Duty Factor		Duty Factor (dB)	Total PSD with Duty Factor (dBm/500kHz)	Limit (dBm/500kHz)	Pass / Fail
		(dBm/300kHz)	(dBm/500kHz)				
155	5775	-5.43	-3.21	0.49	-2.72	30.00	Pass

Note: Refer to section 3.3 for duty cycle spectrum plot.

Spectrum Plot of Worst Value

802.11a

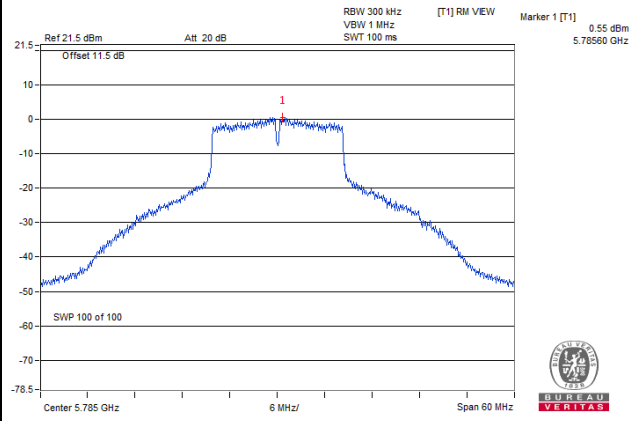

802.11n (HT20)

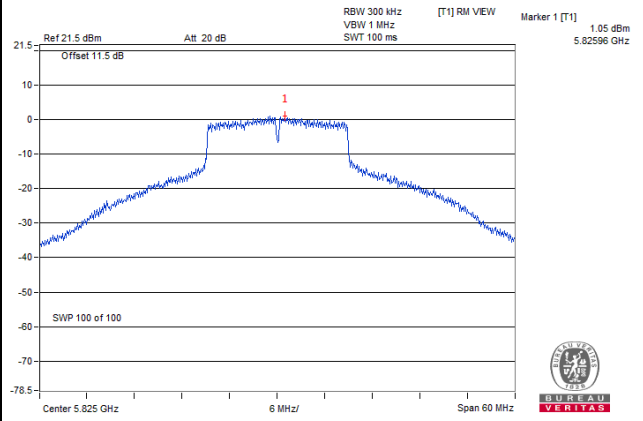

802.11n (HT40)

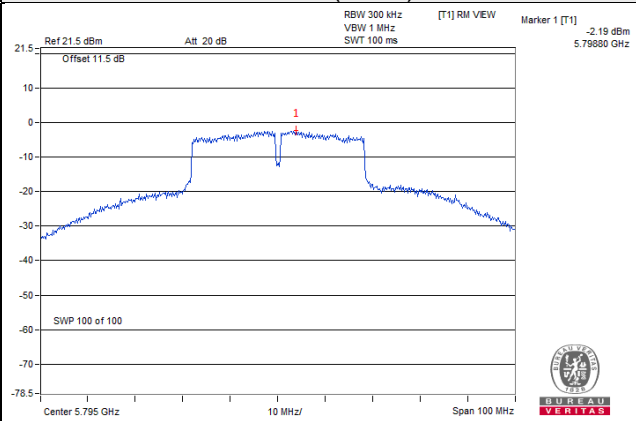

802.11ac (VHT80)

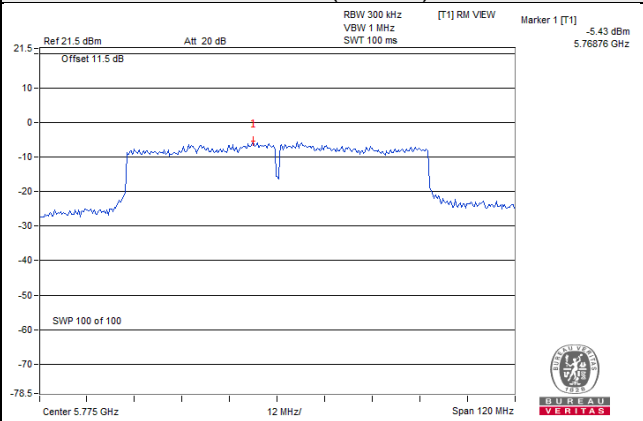

2TX

802.11a

TX chain	Chan.	Freq. (MHz)	PSD (dBm/300 kHz)	PSD (dBm/500 kHz)	10 log (N=2) dB	Total PSD (dBm/500 kHz)	Limit (dBm/500 kHz)	Pass / Fail
0	149	5745	0.02	2.24	3.01	5.25	30.00	Pass
	157	5785	0.96	3.18	3.01	6.19	30.00	Pass
	165	5825	0.84	3.06	3.01	6.07	30.00	Pass
1	149	5745	1.07	3.29	3.01	6.30	30.00	Pass
	157	5785	1.19	3.41	3.01	6.42	30.00	Pass
	165	5825	1.07	3.29	3.01	6.30	30.00	Pass

Note:

- Method 3 of power density measurement of KDB 662911 is using for calculating total power density, Measure and add 10 log (N_{ANT}) dB.
- Directional Gain = 2.34dBi + 10log(2) = 5.35dBi < 6dBi, so the power density limit not need to reduce.

802.11n (HT20)

TX chain	Chan.	Freq. (MHz)	PSD (dBm/300 kHz)	PSD (dBm/500 kHz)	10 log (N=2) dB	Total PSD (dBm/500 kHz)	Limit (dBm/500 kHz)	Pass / Fail
0	149	5745	0.30	2.52	3.01	5.53	30.00	Pass
	157	5785	0.42	2.64	3.01	5.65	30.00	Pass
	165	5825	0.65	2.87	3.01	5.88	30.00	Pass
1	149	5745	0.39	2.61	3.01	5.62	30.00	Pass
	157	5785	0.64	2.86	3.01	5.87	30.00	Pass
	165	5825	0.69	2.91	3.01	5.92	30.00	Pass

Note:

- Method 3 of power density measurement of KDB 662911 is using for calculating total power density, Measure and add 10 log (N_{ANT}) dB.
- Directional Gain = 2.34dBi + 10log(2) = 5.35dBi < 6dBi, so the power density limit not need to reduce.

802.11n (HT40)

TX chain	Chan.	Freq. (MHz)	PSD W/O Duty Factor		10 log (N=2) dB	Duty Factor (dB)	Total PSD With Duty Factor (dBm/500kHz)	Limit (dBm/500kHz)	Pass / Fail
			(dBm/300kHz)	(dBm/500kHz)					
0	151	5755	-2.50	-0.28	3.01	0.18	2.91	30.00	Pass
	159	5795	-2.70	-0.48	3.01	0.18	2.71	30.00	Pass
1	151	5755	-2.63	-0.41	3.01	0.18	2.78	30.00	Pass
	159	5795	-2.69	-0.47	3.01	0.18	2.72	30.00	Pass

Note:

1. Method 3 of power density measurement of KDB 662911 is using for calculating total power density, Measure and add $10 \log (N_{ANT})$ dB.
2. Directional Gain = $2.34\text{dBi} + 10\log(2) = 5.35\text{dBi} < 6\text{dBi}$, so the power density limit not need to reduce.
3. Refer to section 3.3 for duty cycle spectrum plot.

802.11ac (VHT80)

TX chain	Chan.	Freq. (MHz)	PSD W/O Duty Factor		10 log (N=2) dB	Duty Factor (dB)	Total PSD With Duty Factor (dBm/500kHz)	Limit (dBm/500kHz)	Pass / Fail
			(dBm/300kHz)	(dBm/500kHz)					
0	155	5775	-6.19	-3.97	3.01	0.33	-0.63	30.00	Pass
1	155	5775	-6.02	-3.80	3.01	0.33	-0.46	30.00	Pass

Note:

1. Method 3 of power density measurement of KDB 662911 is using for calculating total power density, Measure and add $10 \log (N_{ANT})$ dB.
2. Directional Gain = $2.34\text{dBi} + 10\log(2) = 5.35\text{dBi} < 6\text{dBi}$, so the power density limit not need to reduce.
3. Refer to section 3.3 for duty cycle spectrum plot.

Spectrum Plot of Worst Value

802.11a

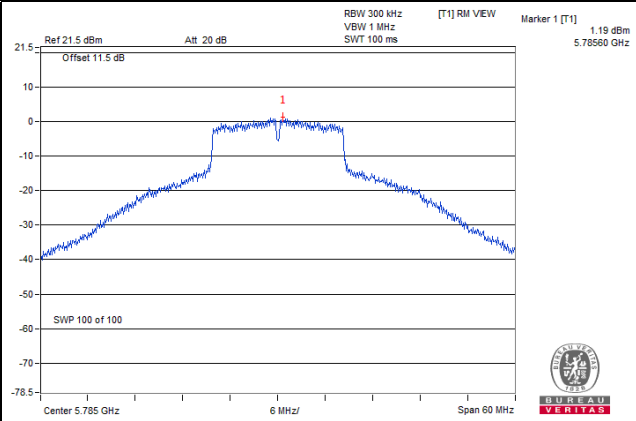

802.11n (HT20)

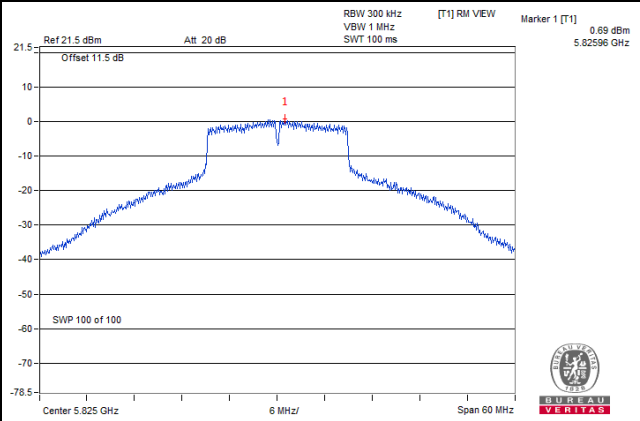

802.11n (HT40)

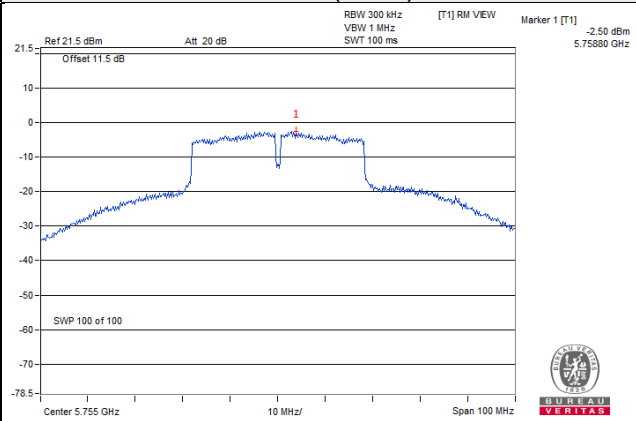

802.11ac (VHT80)

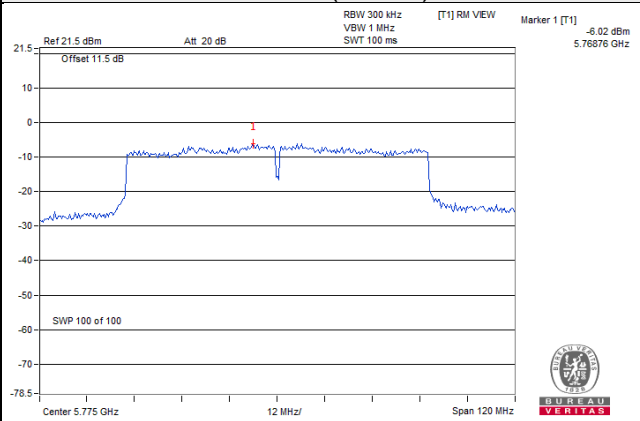

4.6 Frequency Stability

4.6.1 Limits of Frequency Stability Measurement

The frequency of the carrier signal shall be maintained within band of operation

4.6.2 Test Setup

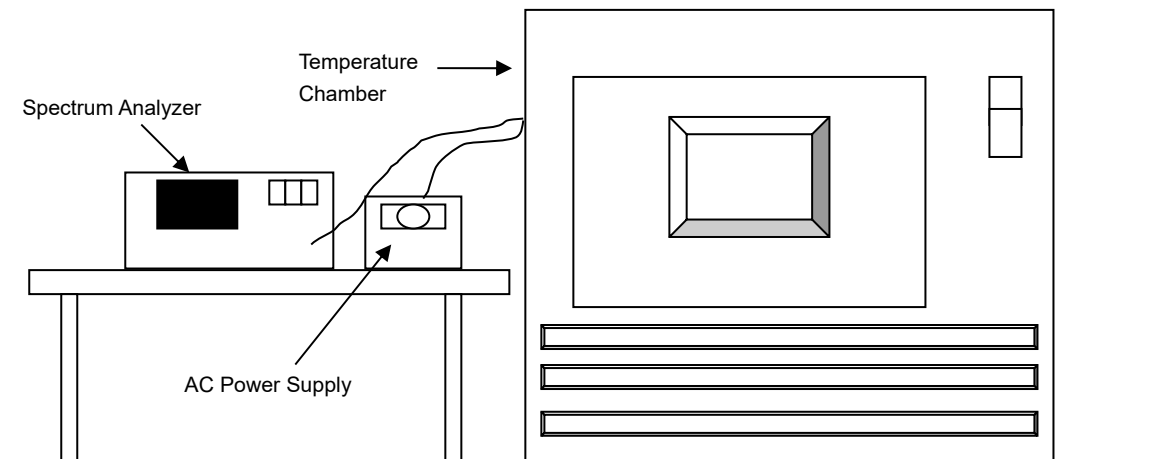

4.6.3 Test Instruments

Description & Manufacturer	Model No.	Serial No.	Cal. Date	Cal. Due
Spectrum Analyzer ROHDE & SCHWARZ	FSP40	100039	Jun. 11, 2018	Jun. 10, 2019
WIT Standard Temperature And Humidity Chamber	TH-4S-C	W981030	Jun. 04, 2018	Jun. 03, 2019
Digital Multimeter Fluke	87-III	70360742	Jun. 29, 2018	Jun. 28, 2019
AC Power Supply Extech	CFW-105	E000603	NA	NA

Note: 1. The calibration interval of the above test instruments is 12 months and the calibrations are traceable to NML/ROC and NIST/USA.

4.6.4 Test Procedure

- The EUT was placed inside the environmental test chamber and powered by nominal AC voltage.
- Turn the EUT on and couple its output to a spectrum analyzer.
- Turn the EUT off and set the chamber to the highest temperature specified.
- Allow sufficient time (approximately 30 min) for the temperature of the chamber to stabilize, turn the EUT on and measure the operating frequency after 2, 5, and 10 minutes.
- Repeat step d. with the temperature chamber set to the next desired temperature.
- The test chamber was allowed to stabilize at +20 degree C for a minimum of 30 minutes. The supply voltage was then adjusted on the EUT from 85% to 115% and the frequency record.

4.6.5 Deviation from Test Standard

No deviation.

4.6.6 EUT Operating Condition

Set the EUT transmit at un-modulation mode to test frequency stability.

4.6.7 Test Results

1TX

Frequency Stability Versus Temp.									
Operating Frequency: 5180MHz									
Temp. (°C)	Power Supply (Vac)	0 Minute		2 Minute		5 Minute		10 Minute	
		Measured Frequency (MHz)	Result	Measured Frequency (MHz)	Result	Measured Frequency (MHz)	Result	Measured Frequency (MHz)	Result
40	120	5179.9818	Pass	5179.9815	Pass	5179.9788	Pass	5179.981	Pass
30	120	5180.0094	Pass	5180.0142	Pass	5180.01	Pass	5180.0123	Pass
20	120	5179.9993	Pass	5179.9961	Pass	5179.9962	Pass	5179.9988	Pass
10	120	5180.0223	Pass	5180.0234	Pass	5180.0232	Pass	5180.0215	Pass
0	120	5179.9969	Pass	5179.9968	Pass	5179.9963	Pass	5179.9935	Pass

Frequency Stability Versus Voltage									
Operating Frequency: 5180MHz									
Temp. (°C)	Power Supply (Vac)	0 Minute		2 Minute		5 Minute		10 Minute	
		Measured Frequency (MHz)	Result	Measured Frequency (MHz)	Result	Measured Frequency (MHz)	Result	Measured Frequency (MHz)	Result
20	138	5179.9987	Pass	5179.9969	Pass	5179.9968	Pass	5179.9998	Pass
	120	5179.9993	Pass	5179.9961	Pass	5179.9962	Pass	5179.9988	Pass
	102	5179.9984	Pass	5179.9968	Pass	5179.9967	Pass	5179.9992	Pass

2TX

Frequency Stability Versus Temp.									
Operating Frequency: 5180MHz									
Temp. (°C)	Power Supply (Vac)	0 Minute		2 Minute		5 Minute		10 Minute	
		Measured Frequency (MHz)	Result	Measured Frequency (MHz)	Result	Measured Frequency (MHz)	Result	Measured Frequency (MHz)	Result
40	120	5179.9876	Pass	5179.9912	Pass	5179.988	Pass	5179.9888	Pass
30	120	5179.9788	Pass	5179.9814	Pass	5179.9811	Pass	5179.9803	Pass
20	120	5180.0179	Pass	5180.0178	Pass	5180.0176	Pass	5180.0208	Pass
10	120	5180.0132	Pass	5180.0135	Pass	5180.0155	Pass	5180.0134	Pass
0	120	5179.9736	Pass	5179.9755	Pass	5179.9752	Pass	5179.974	Pass

Frequency Stability Versus Voltage									
Operating Frequency: 5180MHz									
Temp. (°C)	Power Supply (Vac)	0 Minute		2 Minute		5 Minute		10 Minute	
		Measured Frequency (MHz)	Result	Measured Frequency (MHz)	Result	Measured Frequency (MHz)	Result	Measured Frequency (MHz)	Result
20	138	5180.0171	Pass	5180.0177	Pass	5180.0173	Pass	5180.0199	Pass
	120	5180.0179	Pass	5180.0178	Pass	5180.0176	Pass	5180.0208	Pass
	102	5180.0184	Pass	5180.0172	Pass	5180.0179	Pass	5180.0212	Pass

4.7 6dB Bandwidth Measurement

4.7.1 Limits of 6dB Bandwidth Measurement

The minimum of 6dB Bandwidth Measurement is 0.5MHz.

4.7.2 Test Setup

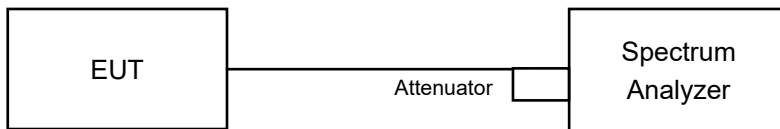

4.7.3 Test Instruments

Refer to section 4.1.2 to get information of above instrument.

4.7.4 Test Procedure

- Set resolution bandwidth (RBW) = 100kHz
- Set the video bandwidth (VBW) $\geq 3 \times$ RBW, Detector = Peak.
- Trace mode = max hold.
- Sweep = auto couple.
- Measure the maximum width of the emission that is constrained by the frequencies associated with the two amplitude points (upper and lower) that are attenuated by 6 dB relative to the maximum level measured in the fundamental emission

4.7.5 Deviation from Test Standard

No deviation.

4.7.6 EUT Operating Condition

The software provided by client to enable the EUT under transmission condition continuously at lowest, middle and highest channel frequencies individually.

4.7.7 Test Results

1TX

802.11a

Channel	Frequency (MHz)	6dB Bandwidth (MHz)	Minimum Limit (MHz)	Pass / Fail
149	5745	15.38	0.5	Pass
157	5785	15.67	0.5	Pass
165	5825	15.35	0.5	Pass

802.11n (HT20)

Channel	Frequency (MHz)	6dB Bandwidth (MHz)	Minimum Limit (MHz)	Pass / Fail
149	5745	17.60	0.5	Pass
157	5785	17.62	0.5	Pass
165	5825	17.62	0.5	Pass

802.11n (HT40)

Channel	Frequency (MHz)	6dB Bandwidth (MHz)	Minimum Limit (MHz)	Pass / Fail
151	5755	35.31	0.5	Pass
159	5795	35.59	0.5	Pass

802.11ac (VHT80)

Channel	Frequency (MHz)	6dB Bandwidth (MHz)	Minimum Limit (MHz)	Pass / Fail
155	5775	75.49	0.5	Pass

Spectrum Plot of Worst Value

802.11a

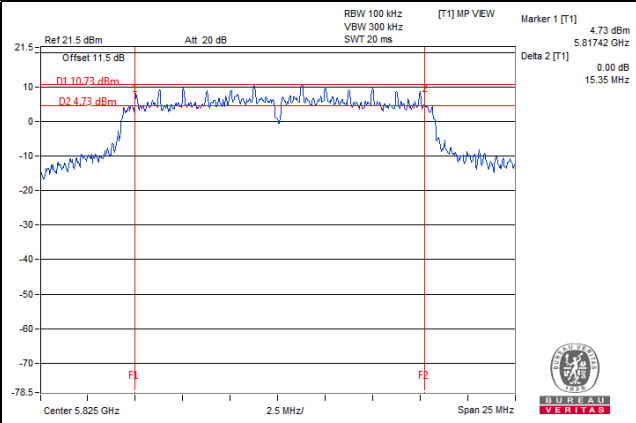

802.11n (HT20)

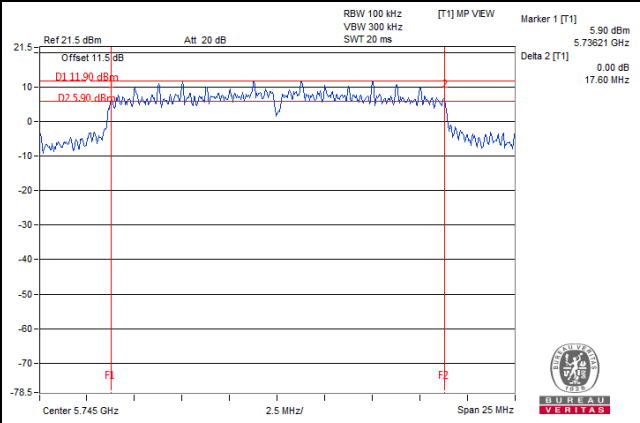

802.11n (HT40)

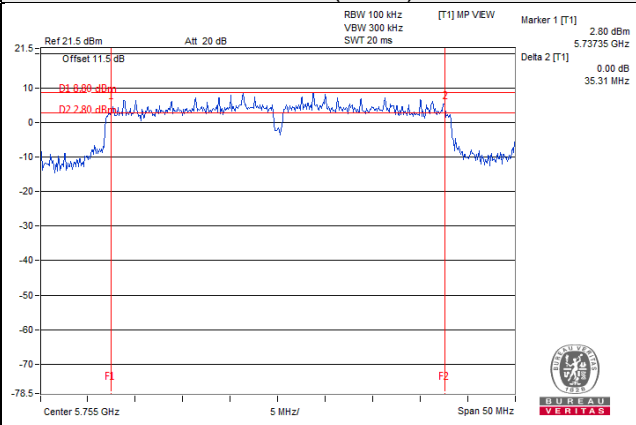

802.11ac (VHT80)

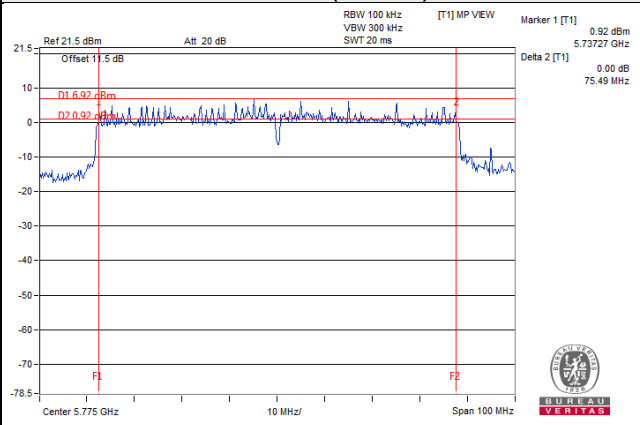

2TX

802.11a

Channel	Frequency (MHz)	6dB Bandwidth (MHz)		Minimum Limit (MHz)	Pass / Fail
		Chain 0	Chain 1		
149	5745	15.36	16.37	0.5	Pass
157	5785	16.34	16.35	0.5	Pass
165	5825	15.92	15.54	0.5	Pass

802.11n (HT20)

Channel	Frequency (MHz)	6dB Bandwidth (MHz)		Minimum Limit (MHz)	Pass / Fail
		Chain 0	Chain 1		
149	5745	17.63	17.63	0.5	Pass
157	5785	17.62	17.62	0.5	Pass
165	5825	17.63	17.58	0.5	Pass

802.11n (HT40)

Channel	Frequency (MHz)	6dB Bandwidth (MHz)		Minimum Limit (MHz)	Pass / Fail
		Chain 0	Chain 1		
151	5755	35.22	35.55	0.5	Pass
159	5795	35.23	35.57	0.5	Pass

802.11ac (VHT80)

Channel	Frequency (MHz)	6dB Bandwidth (MHz)		Minimum Limit (MHz)	Pass / Fail
		Chain 0	Chain 1		
155	5775	75.50	75.36	0.5	Pass

Spectrum Plot of Worst Value

802.11a

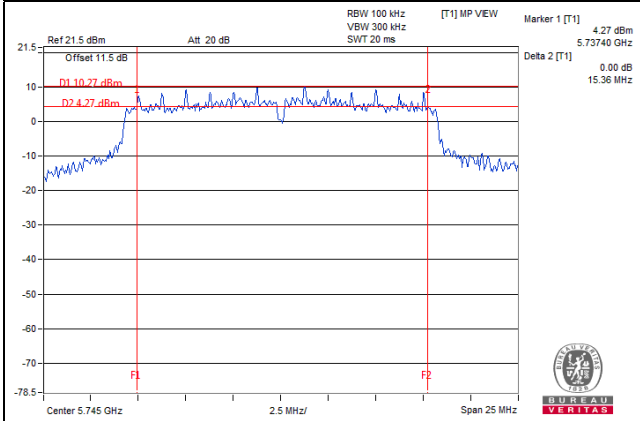

802.11n (HT20)

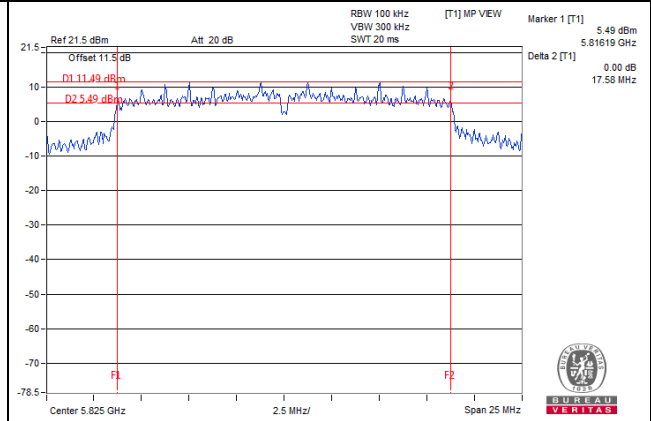

802.11n (HT40)

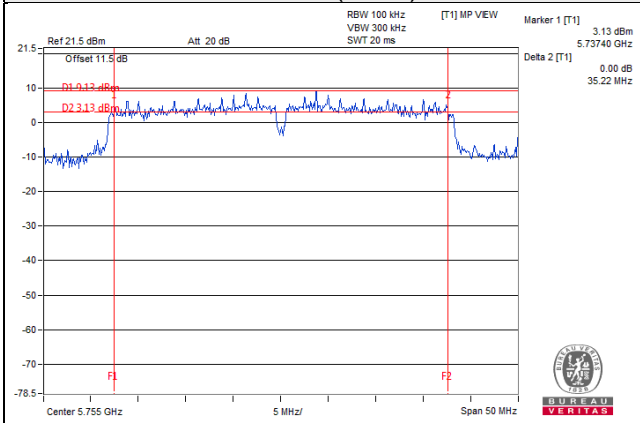

802.11ac (VHT80)

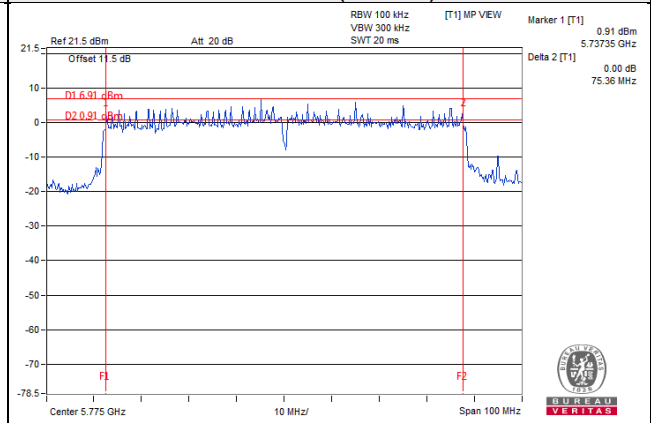

5 Pictures of Test Arrangements

Please refer to the attached file (Test Setup Photo).

Annex A- Radiated Out of Band Emission (OOBE) Measurement (For U-NII-3 band)

1TX

802.11a

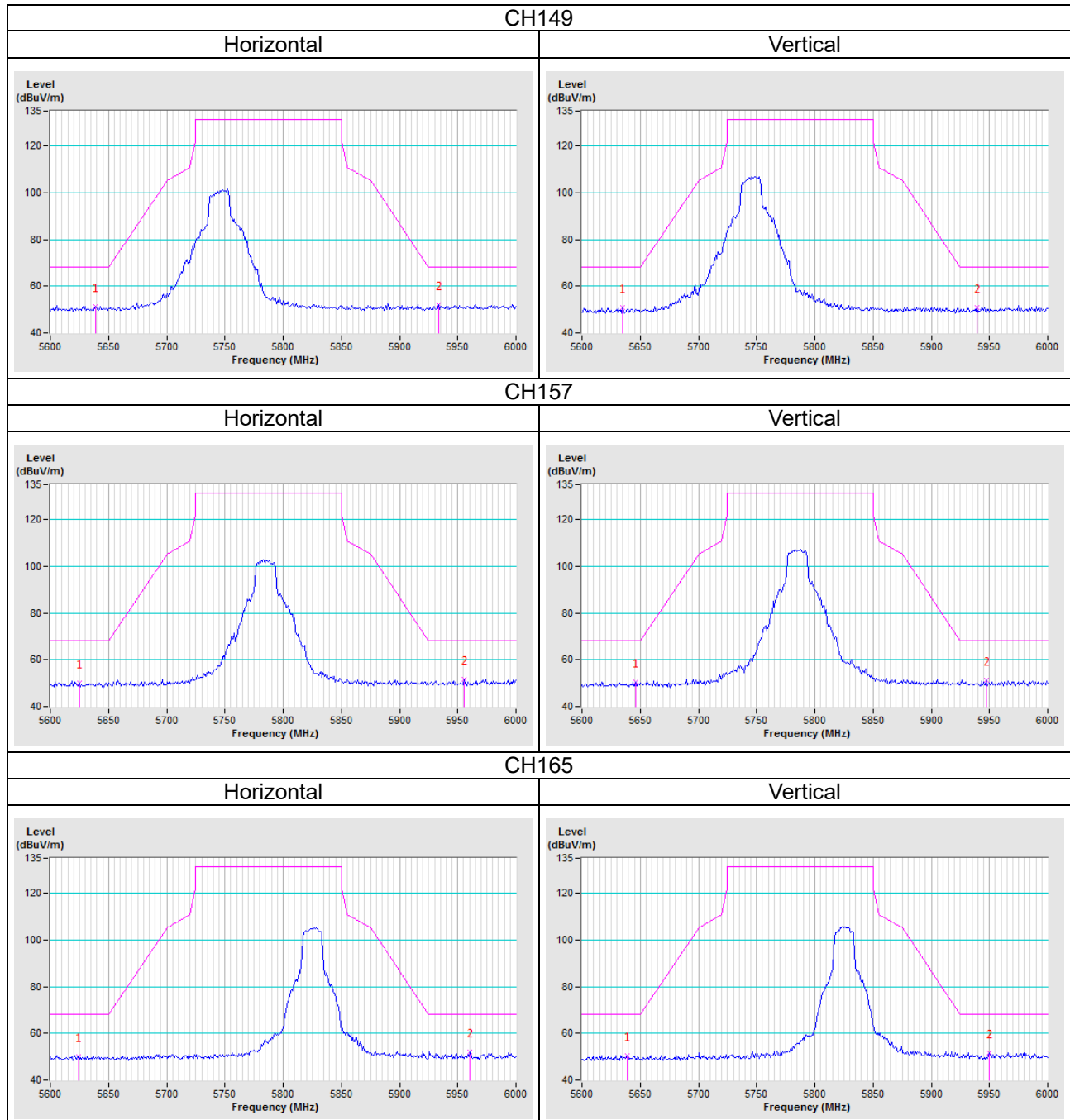

802.11n (HT20)

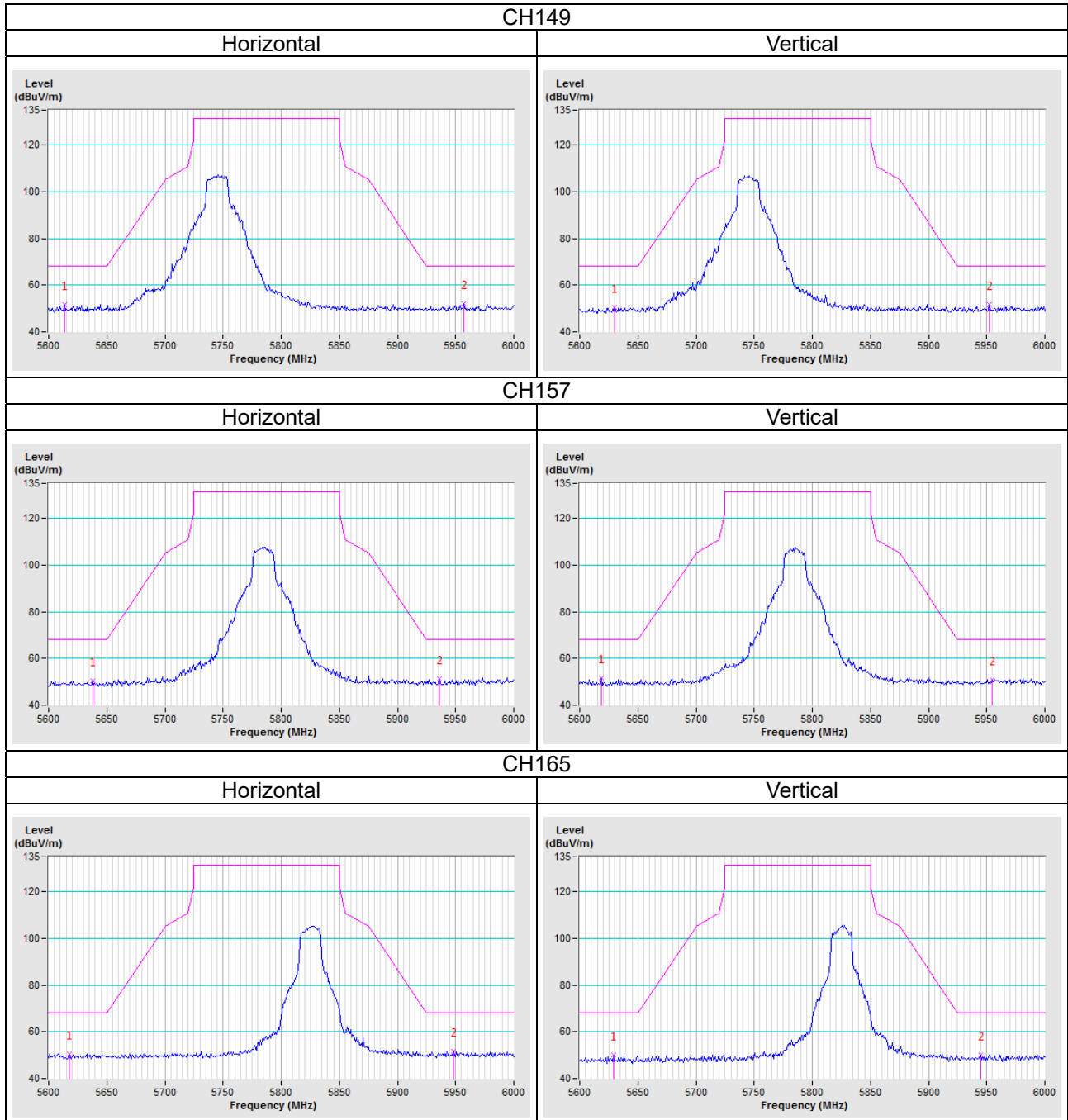

802.11n (HT40)

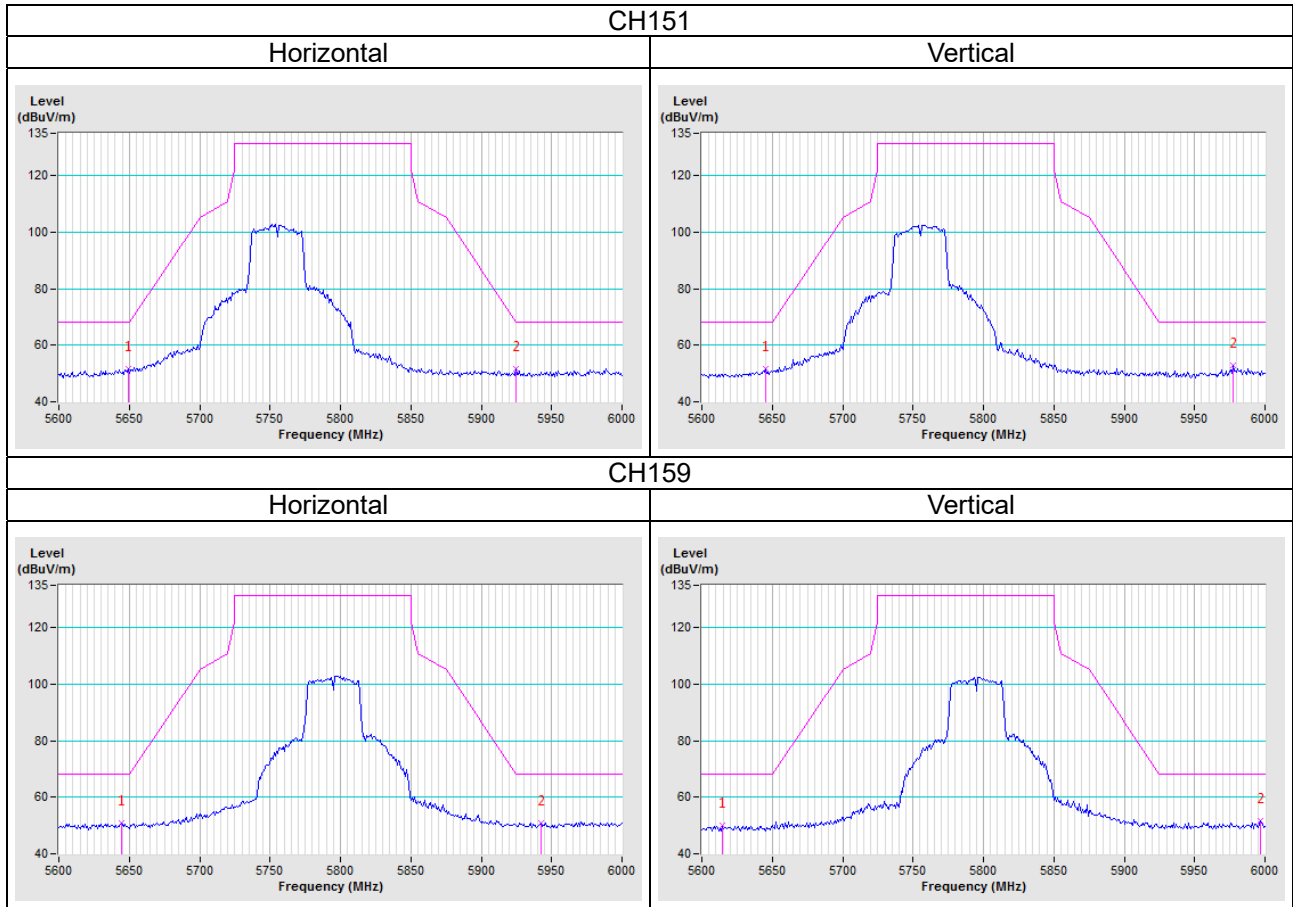

802.11ac (VHT80)

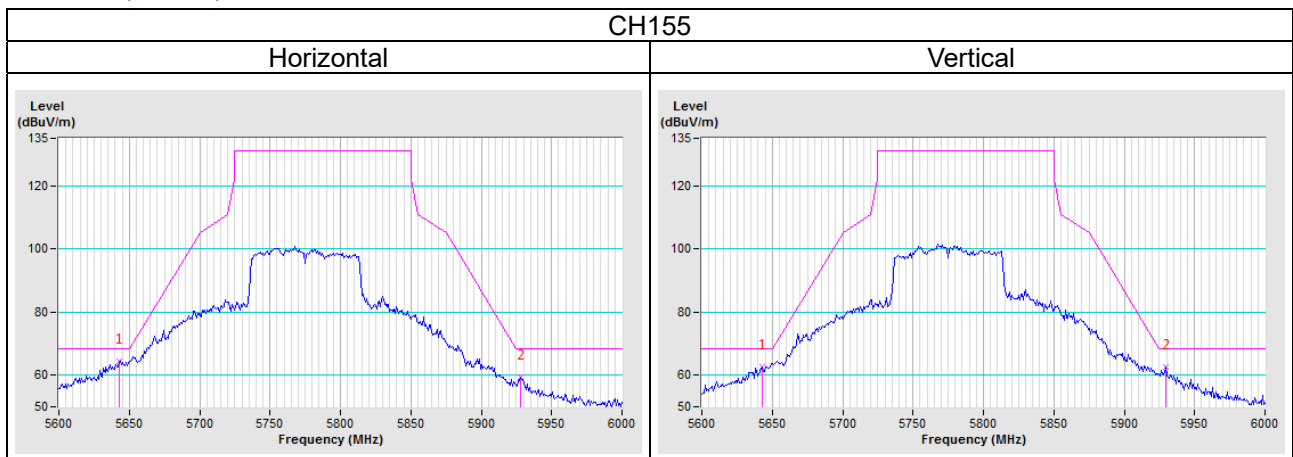

2TX

802.11a

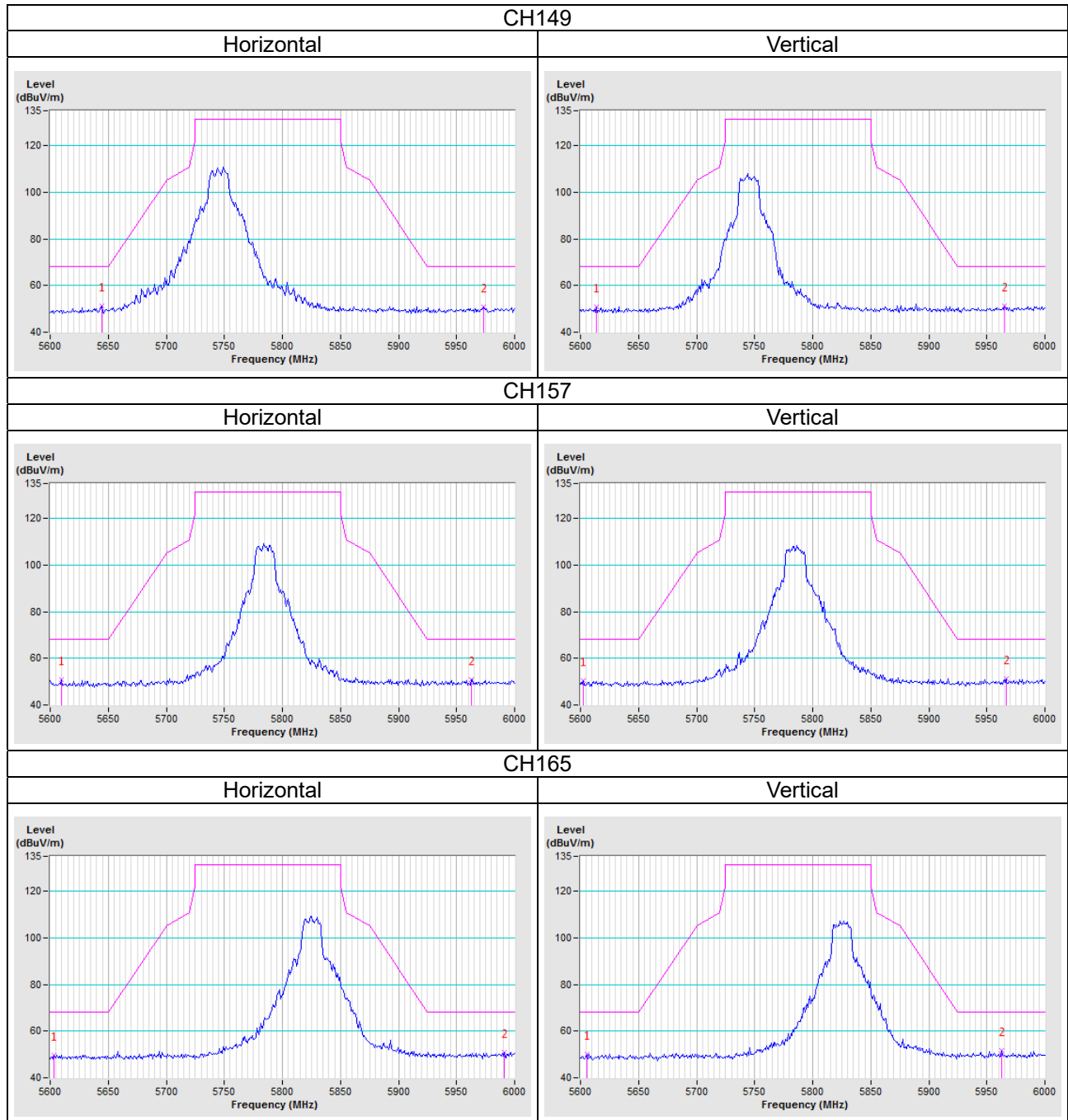

802.11n (HT20)

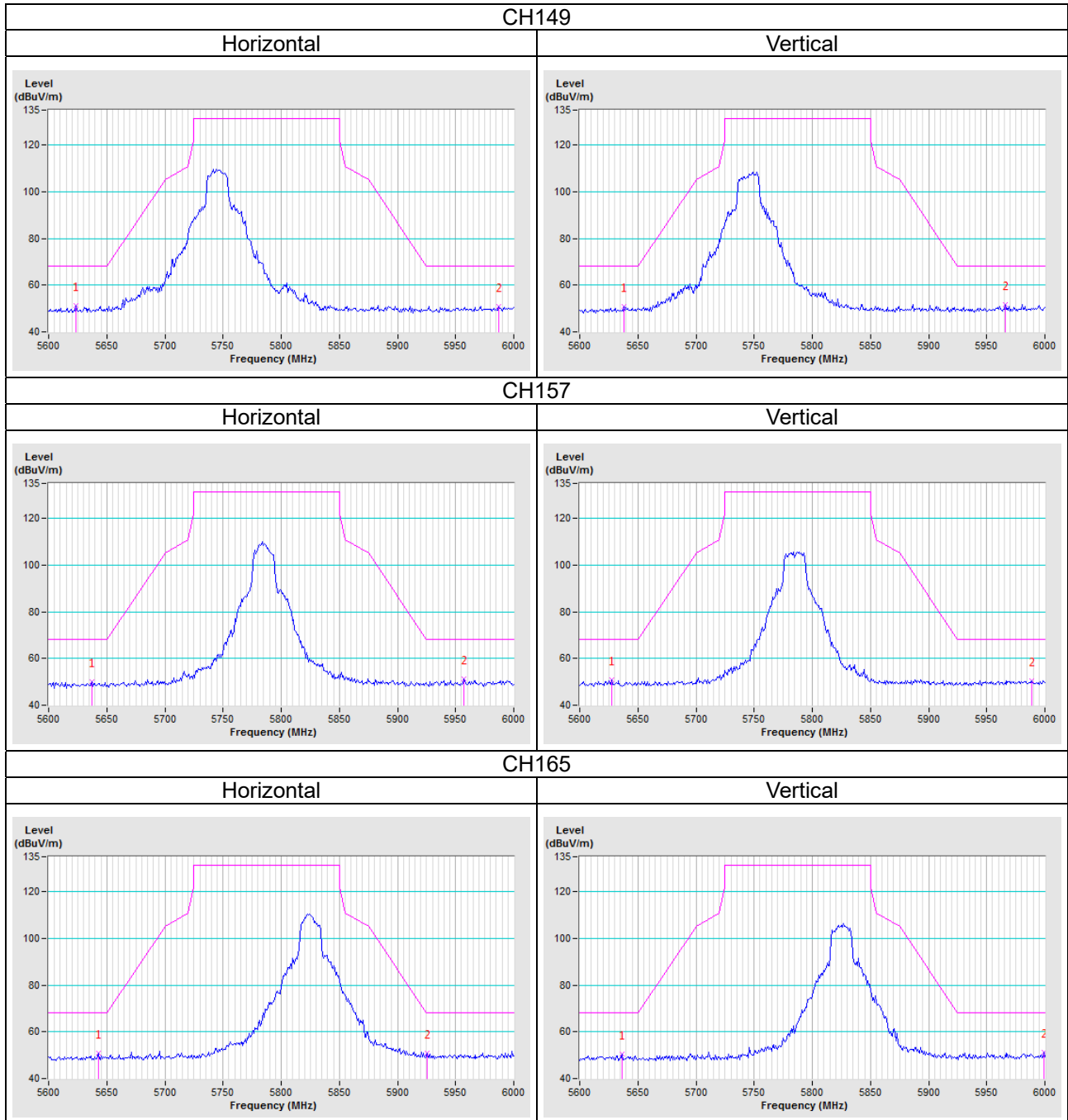

802.11n (HT40)

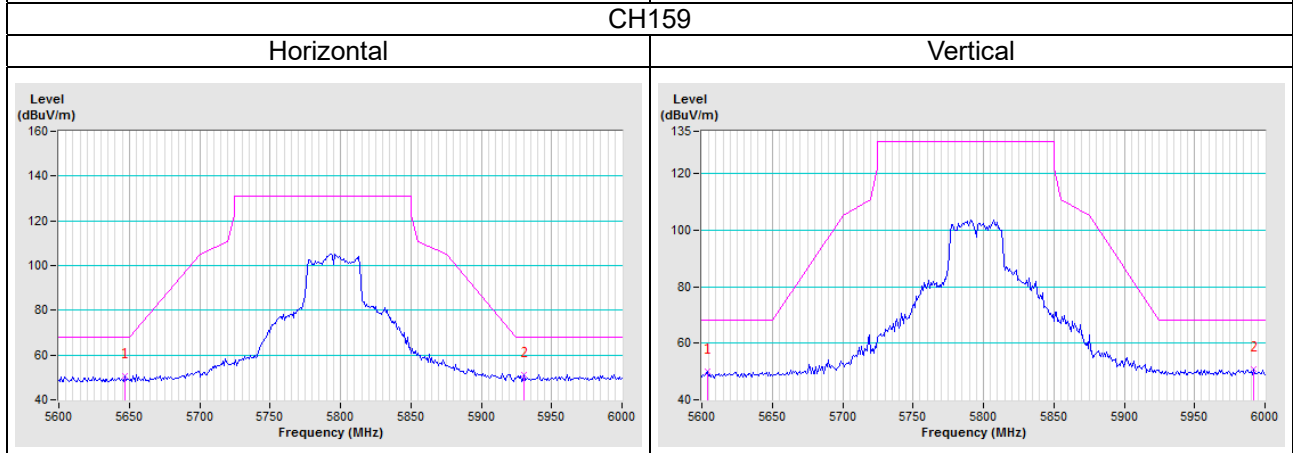
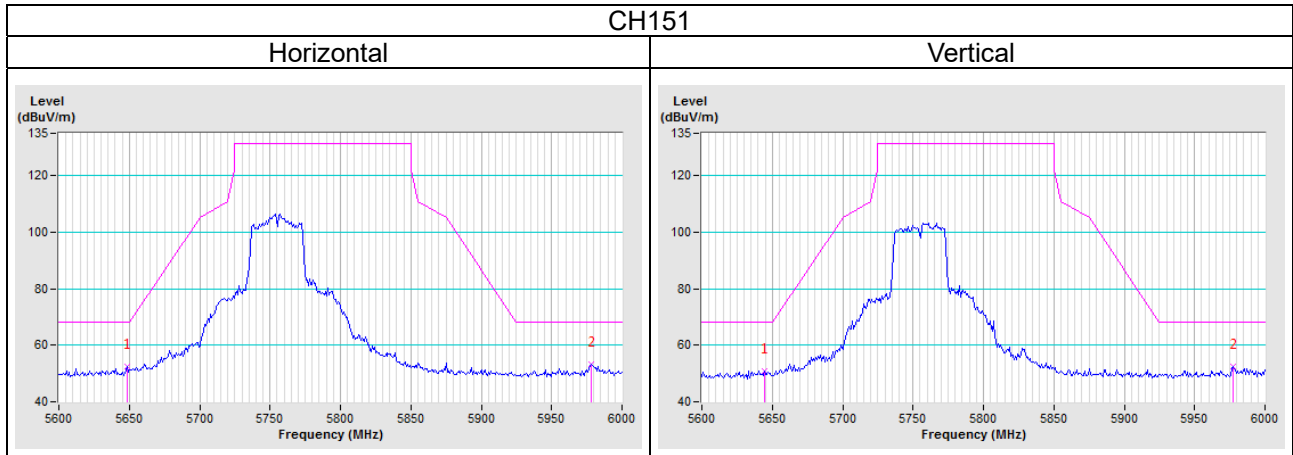

802.11ac (VHT80)

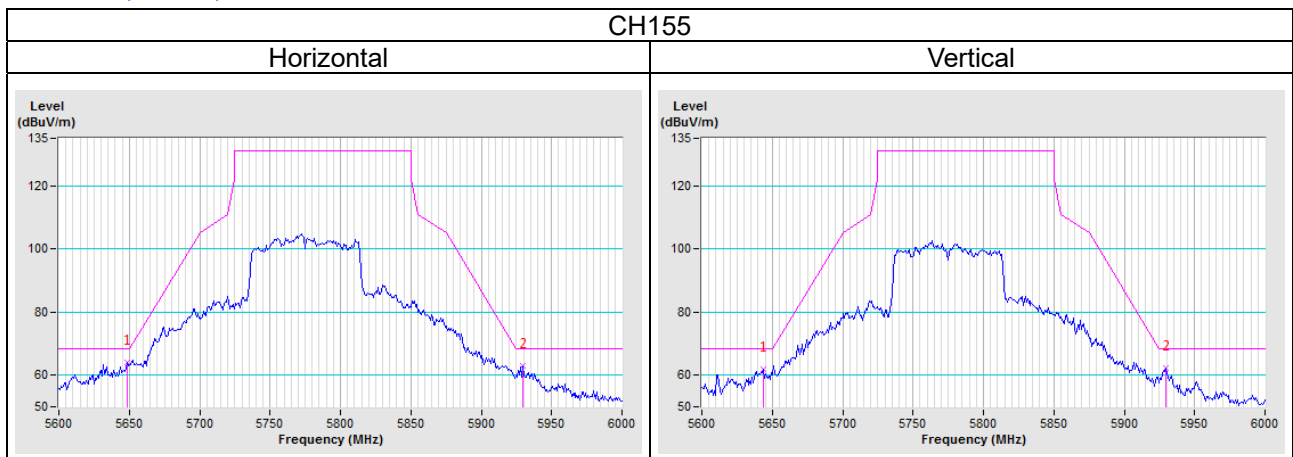

Appendix – Information of the Testing Laboratories

We, Bureau Veritas Consumer Products Services (H.K.) Ltd., Taoyuan Branch, were founded in 1988 to provide our best service in EMC, Radio, Telecom and Safety consultation. Our laboratories are FCC recognized accredited test firms and accredited and approved according to ISO/IEC 17025.

If you have any comments, please feel free to contact us at the following:

Lin Kou EMC/RF Lab

Tel: 886-2-26052180

Fax: 886-2-26051924

Hsin Chu EMC/RF/Telecom Lab

Tel: 886-3-6668565

Fax: 886-3-6668323

Hwa Ya EMC/RF/Safety

Tel: 886-3-3183232

Fax: 886-3-3270892

Email: service.adt@tw.bureauveritas.com

Web Site: www.bureauveritas-adt.com

The address and road map of all our labs can be found in our web site also.

--- END ---